



RF TEST REPORT

Applicant Quectel Wireless Solutions Co., Ltd
FCC ID XMR202005BG95M5
Product LTE Cat M1 & Cat NB2 & EGPRS Module
Brand Quectel
Model BG95-M5
Marketing Quectel BG95-M5
Report No. R2108A0767-R4V1
Issue Date November 11, 2021

TA Technology (Shanghai) Co., Ltd. tested the above equipment in accordance with the requirements in **FCC CFR47 Part 2 (2020)/ FCC CFR47 Part 27C (2020)**. The test results show that the equipment tested is capable of demonstrating compliance with the requirements as documented in this report.

Performed by: Peng Tao

Approved by: Kai Xu

TA Technology (Shanghai) Co., Ltd.

No.145, Jintang Rd, Tangzhen Industry Park, Pudong Shanghai, China

TEL: +86-021-50791141/2/3

FAX: +86-021-50791141/2/3-8000



TABLE OF CONTENT

1	Test Laboratory.....	6
1.1	Notes of the Test Report.....	6
1.2.	Test facility.....	6
1.3	Testing Location.....	6
2	General Description of Equipment under Test.....	7
2.1	Applicant and Manufacturer Information.....	7
2.2	General information.....	7
3	Applied Standards.....	9
4	Test Configuration.....	10
5	Test Case Results.....	12
5.1	RF Power Output and Effective Isotropic Radiated Power.....	12
5.2	Occupied Bandwidth.....	19
5.3	Band Edge Compliance.....	29
5.4	Peak-to-Average Power Ratio (PAPR).....	59
5.5	Frequency Stability.....	62
5.6	Spurious Emissions at Antenna Terminals.....	74
5.7	Radiates Spurious Emission.....	96
6	Main Test Instruments.....	107
	ANNEX A: The EUT Appearance.....	108
	ANNEX B: Test Setup Photos.....	109
	ANNEX C: Verify data.....	110
	ANNEX D: Product Change Description.....	111



Version	Revision description	Issue Date
Rev.0	Initial issue of report.	September 24, 2021
Rev.1	Update data. Update description	November 11, 2021

Note: This revised report (Report No. R2108A0767-R4V1) supersedes and replaces the previously issued report (Report No. R2108A0767-R4). Please discard or destroy the previously issued report and dispose of it accordingly.



Summary of Measurement Results

Number	Test Case	Clause in FCC rules	Verdict
1	RF Power Output and Effective Isotropic Radiated Power	2.1046 27.50(d)(4) /27.50(b)(10) /27.50(c)(10)	PASS
2	Occupied Bandwidth	2.1049	PASS
3	Band Edge Compliance	27.53(h) /27.53(g) /27.53(f) /27.53(c)	PASS
4	Peak-to-Average Power Ratio	27.50(d)/KDB971168 D01(5.7)	PASS
5	Frequency Stability	2.1055 / 27.54	PASS
6	Spurious Emissions at Antenna Terminals	2.1051 /27.53(h) /27.53(g) /27.53(f) /27.53(c)	PASS
7	Radiates Spurious Emission	2.1051 /27.53(h) /27.53(g) /27.53(f) /27.53(c)	PASS

Date of Testing(original): May 23, 2020 ~ June 16, 2020

(variant): August 31, 2021 ~ November 5, 2021

Note: PASS: The EUT complies with the essential requirements in the standard.

FAIL: The EUT does not comply with the essential requirements in the standard.

All indications of Pass/Fail in this report are opinions expressed by TA Technology (Shanghai) Co., Ltd. based on interpretations and/or observations of test results. Measurement Uncertainties were not taken into account and are published for informational purposes only.

BG95-M5 (Report No.: R2108A0767-R4V1) is a variant model of BG95-M5 (Report No.: R2005A0283-R4V1). There is only changed the Power Amplifier and Software Version of product.

Tested cases refer to the following table. Please refer to Appendix C for Verify data

Test Case	Original	Variant
RF Power Output and Effective Radiated Power	PASS	Retest(LTE Band 4/66/12/13/85)
Occupied Bandwidth	PASS	Verify the worst combination of each frequency band(LTE Band 4/66/12/13/85)
Band Edge Compliance	PASS	Verify the worst combination of each frequency band(LTE Band 4/66/12/13/85)
Peak-to-Average Power Ratio	PASS	Retest(LTE Band 4/66/12/13/85)
Frequency Stability	PASS	Verify the worst combination of each frequency band(LTE Band 4/66/12/13/85)
Spurious Emissions at Antenna Terminals	PASS	Verify the worst combination of each frequency



		band(LTE Band 4/66/12/13/85)
Radiates Spurious Emission	PASS	Verify the worst combination of each frequency band(LTE Band 4/66/12/13/85)

The detailed product change description please refers to the **Difference Declaration Letter**.



1 Test Laboratory

1.1 Notes of the Test Report

This report shall not be reproduced in full or partial, without the written approval of **TA technology (shanghai) co., Ltd.** The results documented in this report apply only to the tested sample, under the conditions and modes of operation as described herein .Measurement Uncertainties were not taken into account and are published for informational purposes only. This report is written to support regulatory compliance of the applicable standards stated above.

1.2. Test facility

FCC (Designation number: CN1179, Test Firm Registration Number: 446626)

TA Technology (Shanghai) Co., Ltd. has been listed on the US Federal Communications Commission list of test facilities recognized to perform electromagnetic emissions measurements.

A2LA (Certificate Number: 3857.01)

TA Technology (Shanghai) Co., Ltd. has been listed by American Association for Laboratory Accreditation to perform electromagnetic emission measurement.

1.3 Testing Location

Company: TA Technology (Shanghai) Co., Ltd.
Address: No.145, Jintang Rd, Tangzhen Industry Park, Pudong Shanghai, China
City: Shanghai
Post code: 201201
Country: P. R. China
Contact: Xu Kai
Telephone: +86-021-50791141/2/3
Fax: +86-021-50791141/2/3-8000
Website: <http://www.ta-shanghai.com>
E-mail: xukai@ta-shanghai.com

2 General Description of Equipment under Test

2.1 Applicant and Manufacturer Information

Applicant	Quectel Wireless Solutions Co., Ltd
Applicant address	Building 5, Shanghai Business Park Phase III (Area B), No.1016 Tianlin Road, Minhang District, Shanghai, China 200233
Manufacturer	Quectel Wireless Solutions Co., Ltd
Manufacturer address	Building 5, Shanghai Business Park Phase III (Area B), No.1016 Tianlin Road, Minhang District, Shanghai, China 200233

2.2 General information

EUT Description			
Model	BG95-M5		
IMEI	Original	866833040004456	
	Variant	866833040047463	
Hardware Version	R1.1		
Software Version	BG95M5LAR02A03		
Power Supply	External Power Supply		
Antenna Type	The EUT don't have standard Antenna, The Antenna used for testing in this report is the after-market accessory (Dipole Antenna)		
Antenna Gain	Frequency(MHz)	Gain(dBi)	
	700	1.66	
	710	3.26	
	780	4.45	
	1720	1.94	
	1740	2.00	
Antenna Gain	1780	0.97	
	Test Mode(s)	LTE Band 4/12/13/66/85;	
	Test Modulation	(LTE)QPSK 16QAM;	
LTE Category	M1		
Maximum E.I.R.P	LTE Band 4:	25.70dBm	
	LTE Band 66:	25.50dBm	
Maximum E.R.P	LTE Band 12:	25.10dBm	
	LTE Band 13:	25.63dBm	
	LTE Band 85	24.29dBm	
Rated Power Supply Voltage:	3.8V		
Extreme Voltage	Minimum: 3.3V Maximum: 4.3V		



Extreme Temperature	Lowest: -40°C Highest: +85°C		
Frequency Range(s)	LTE Band 4	1710 ~ 1755	2110 ~ 2155
	LTE Band 12	699 ~ 716	729 ~ 746
	LTE Band 13	777 ~ 787	746 ~ 756
	LTE Band 66	1710 ~ 1780	2110 ~ 2180
	LTE Band 85	698 ~ 716	728 ~ 746
Note: 1. The EUT is sent from the applicant to TA and the information of the EUT is declared by the applicant.			



3 Applied Standards

According to the specifications of the manufacturer, it must comply with the requirements of the following standards:

Test standards:

FCC CFR47 Part 27C (2020)

ANSI C63.26 (2015)

Reference standard:

FCC CFR47 Part 2 (2020)

KDB 971168 D01 Power Meas License Digital Systems v03r01

4 Test Configuration

Radiated measurements are performed by rotating the EUT in three different orthogonal test planes. EUT stand-up position (Z axis), lie-down position (X, Y axis). Receiver antenna polarization (horizontal and vertical), the worst emission was found in position (X axis, horizontal polarization) and the worst case was recorded.

All mode and data rates and positions and RB size and modulations were investigated.

Subsequently, only the worst case emissions are reported.

The following testing in LTE is set based on the maximum RF Output Power.

The following testing in different Bandwidth is set to detailin the following table:

Test modes are chosen to be reported as the worst case configuration below for LTE 4/12/13/66/85:

Test items	Modes	Bandwidth (MHz)						Modulation		RB			Test Channel		
		1.4	3	5	10	15	20	QPSK	16QAM	1	50%	100%	L	M	H
RF Power Output and Effective Isotropic Radiated Power	LTE 4	O	O	O	O	O	O	O	O	O	O	O	O	O	O
	LTE 12	O	O	O	O	-	-	O	O	O	O	O	O	O	O
	LTE 13	-	-	O	O	-	-	O	O	O	O	O	O	O	O
	LTE 66	O	O	O	O	O	O	O	O	O	O	O	O	O	O
	LTE 85	-	-	O	O	-	-	O	O	O	O	O	O	O	O
Occupied Bandwidth	LTE 4	O	O	O	O	O	O	O	O	-	-	O	-	O	-
	LTE 12	-	-	O	O	O	O	O	O	-	-	O	-	O	-
	LTE 13	-	-	O	O	-	-	O	O	-	-	O	-	O	-
	LTE 66	O	O	O	O	O	O	O	O	-	-	O	-	O	-
	LTE 85	-	-	O	O	-	-	O	O	-	-	O	-	O	-
Band Edge Compliance	LTE 4	O	O	O	O	O	O	O	O	O	-	O	O	-	O
	LTE 12	-	-	O	O	O	O	O	O	O	-	O	O	-	O
	LTE 13	-	-	O	O	-	-	O	O	O	-	O	O	-	O
	LTE 66	O	O	O	O	O	O	O	O	O	-	O	O	-	O
	LTE 85	-	-	O	O	-	-	O	O	O	-	O	O	-	O
Peak-to-Average Power Ratio	LTE 4	O	O	O	O	O	O	O	O	-	-	O	-	O	-
	LTE 12	-	-	O	O	O	O	O	O	-	-	O	-	O	-
	LTE 13	-	-	O	O	-	-	O	O	-	-	O	-	O	-
	LTE 66	O	O	O	O	O	O	O	O	-	-	O	-	O	-
	LTE 85	-	-	O	O	-	-	O	O	-	-	O	-	O	-
Frequency Stability	LTE 4	O	O	O	O	O	O	O	O	O	O	O	O	O	O
	LTE 12	-	-	O	O	O	O	O	O	O	O	O	O	O	O
	LTE 13	-	-	O	O	-	-	O	O	O	O	O	O	O	O
	LTE 66	O	O	O	O	O	O	O	O	O	O	O	O	O	O
	LTE 85	-	-	O	O	-	-	O	O	O	O	O	O	O	O
Spurious	LTE 4	O	O	O	O	O	O	O	-	O	-	-	O	O	O



Emissions at Antenna Terminals	LTE 12	-	-	O	O	O	O	O	-	O	-	-	O	O	O
	LTE 13	-	-	O	O	-	-	O	-	O	-	-	O	O	O
	LTE 66	O	O	O	O	O	O	O	-	O	-	-	O	O	O
	LTE 85	-	-	O	O	-	-	O	-	O	-	-	O	O	O
Radiates Spurious Emission	LTE 4	O	-	O	-	-	O	O	-	O	-	-	-	O	-
	LTE 12	-	-	O	-	O	O	O	-	O	-	-	-	O	-
	LTE 13	-	-	O	O	-	-	O	-	O	-	-	-	O	-
	LTE 66	O	O	O	O	O	O	O	-	O	-	-	-	O	-
	LTE 85	-	-	O	O	-	-	O	-	O	-	-	-	O	-
Note	<p>1. The mark "O" means that this configuration is chosen for testing.</p> <p>2. The mark "-" means that this configuration is not testing.</p>														

5 Test Case Results

5.1 RF Power Output and Effective Isotropic Radiated Power

Ambient condition

Temperature	Relative humidity	Pressure
23°C ~25°C	45%~50%	101.5kPa

Methods of Measurement

During the process of the testing, The EUT is controlled by the Base Station Simulator to ensure max power transmission and proper modulation.

1. The testing follows FCC KDB 971168 D01 v03r01 Section 5.8 and ANSI C63.26 (2015).
 - a) Connect the equipment as illustrated. Mount the equipment with the manufacturer specified antenna in a vertical orientation on a manufacturer specified mounting surface located on a non-conducting rotating platform of a RF anechoic chamber (preferred) or a standard radiation site.
 - b) Key the transmitter, then rotate the EUT 360° azimuthally and record spectrum analyzer power level (LVL) measurements at angular increments that are sufficiently small to permit resolution of all peaks. If a standard radiation test site is used, raise and lower the test antenna to obtain a maximum reading at each angular increment. (Note: several batteries may be needed to offset the effect of battery voltage droop, which should not exceed 5% of the manufactured specified battery voltage during transmission).
 - c) Replace the transmitter under test with a vertically polarized half-wave dipole (or an antenna whose gain is known relative to an ideal half-wave dipole). The center of the antenna should be at the same location as the center of the antenna under test.
 - d) Connect the antenna to a signal generator with a known output power and record the path loss (in dB) as LOSS. If a standard radiation test site is used, raise and lower the test antenna to obtain a maximum reading. $LOSS = \text{Generator Output Power (dBm)} - \text{Analyzer reading (dBm)}$
 - e) Determine the effective radiated output power at each angular position from the readings in steps b) and d) using the following equation: $ERP \text{ (dBm)} = \text{LVL (dBm)} + \text{LOSS (dB)}$
 - f) The maximum ERP is the maximum value determined in the preceding step.
 - g) When calculating ERP, in addition to knowing the antenna radiation and matching characteristics, it is necessary to know the loss values of all elements (e.g. transmission line attenuation, mismatches, filters, combiners) interposed between the point where transmitter output power is measured, and the point where power is applied to the antenna. ERP can then be calculated as follows:

$$EIRP \text{ (dBm)} = \text{Output Power (dBm)} - \text{Losses (dB)} + \text{Antenna Gain (dBi)}$$

where: dBd refers to gain relative to an ideal dipole.

$$EIRP \text{ (dBm)} = ERP \text{ (dBm)} + 2.15 \text{ (dB.)}$$

The RB allocation refers to section 5.1, using the maximum output power configuration.

Test Setup

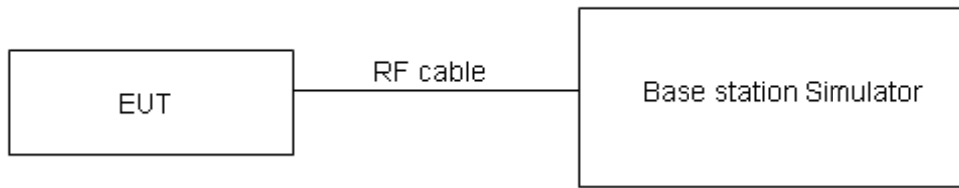

The loss between RF output port of the EUT and the input port of the tester has been taken into consideration.

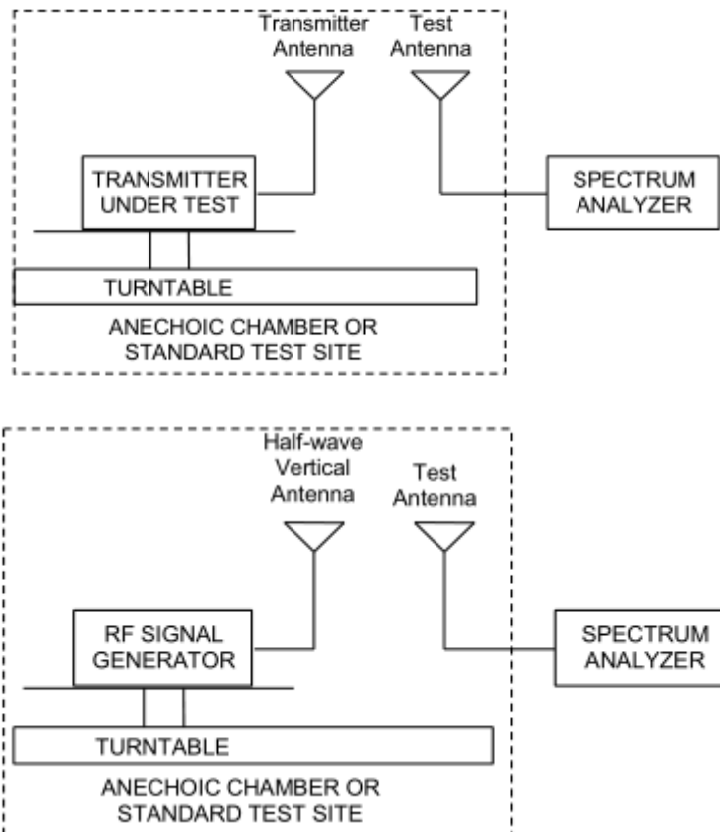

Note: Area side:2.4mX3.6m

The radiated emission was measured in the following position: EUT stand-up position (Z axis), lie-down position (X, Y axis). The worst emission was found in stand-up position (Z axis) and the worst case was recorded.

Limits

No specific RF power output requirements in part 2.1046.

Rule Part 27.50(b) (10) specifies that “Portable stations (hand-held devices) transmitting in the 746-757 MHz, 776-788 MHz, and 805-806 MHz bands are limited to 3 watts ERP”

Rule Part 27.50(c) (10) specifies that “Portable stations (hand-held devices) in the 600 MHz uplink band and the 698-746 MHz band, and fixed and mobile stations in the 600 MHz uplink band are limited to 3 watts ERP”



Rule Part 27.50(d) (4) specifies that “Fixed, mobile and portable (hand-held) stations operating in the 1710–1755 MHz band are limited to 1 watt EIRP”

Part 27.50(b)(10)Limit	$\leq 3 \text{ W}$ (34.77 dBm)
Part 27.50(c)(10)Limit	$\leq 3 \text{ W}$ (34.77 dBm)
Part 27.50(d)(4)Limit	$\leq 1 \text{ W}$ (30 dBm)

Measurement Uncertainty

The assessed measurement uncertainty to ensure 95% confidence level for the normal distribution is with the coverage factor $k = 2$, $U=0.4$ dB for RF power output, $k = 2$, $U= 1.19$ dB for ERP/EIRP.



Test Results

LTE Band 4	Channel/ Frequency(MHz)	Index	RB# RBstart	Conducted Power (dBm)		EIRP (dBm)	
				QPSK	16QAM	QPSK	16QAM
1.4MHz	19957/1710.7	0	1#0	23.48	22.74	25.42	24.68
		0	6#0	21.52	21.40	23.46	23.34
	20175/1732.5	0	1#0	23.69	22.52	25.69	24.52
		0	6#0	21.37	21.56	23.37	23.56
	20393/1754.3	0	1#5	23.12	22.42	24.69	23.99
		0	6#0	21.41	21.13	22.98	22.70
3MHz	19965/1711.5	0	1#0	23.62	22.85	25.56	24.79
		0	6#0	21.55	21.54	23.49	23.48
	20175/1732.5	0	1#0	23.42	22.50	25.42	24.50
		0	6#0	21.36	21.24	23.36	23.24
	20385/1753.5	1	1#5	23.25	22.63	24.82	24.20
		1	6#0	21.41	21.24	22.98	22.81
5MHz	19975/1712.5	3	1#0	23.56	23.76	25.50	25.70
		0	6#0	22.54	21.42	24.48	23.36
	20175/1732.5	0	1#0	23.43	23.15	25.43	25.15
		0	6#0	22.38	21.48	24.38	23.48
	20375/1752.5	0	1#5	23.27	23.11	24.84	24.68
		3	6#0	22.44	21.51	24.01	23.08
10MHz	20000/1715	3	1#0	23.66	23.37	25.60	25.31
		0	4#0	23.66	22.62	25.60	24.56
	20175/1732.5	0	1#0	23.41	23.62	25.41	25.62
		0	4#0	23.40	22.17	25.40	24.17
	20350/1750	4	1#5	23.26	23.14	24.83	24.71
		7	4#2	23.54	22.55	25.11	24.12
15MHz	20025/1717.5	3	1#0	23.62	23.27	25.56	25.21
		0	6#0	23.64	23.65	25.58	25.59
	20175/1732.5	0	1#0	23.55	23.17	25.55	25.17
		0	6#0	23.54	23.58	25.54	25.58
	20325/1747.5	8	1#5	23.27	23.12	24.84	24.69
		11	6#0	23.47	23.49	25.04	25.06
20MHz	20050/1720	3	1#0	23.58	23.36	25.52	25.30
		0	6#0	23.55	23.61	25.49	25.55
	20175/1732.5	0	1#0	23.57	23.17	25.57	25.17
		0	6#0	23.57	23.56	25.57	25.56
	20300/1745	12	1#5	23.31	23.16	24.88	24.73
		15	6#0	23.41	23.45	24.98	25.02



LTE Band 12	Channel/ Frequency(MHz)	Index	RB# RBstart	Conducted Power (dBm)		ERP (dBm)	
				QPSK	16QAM	QPSK	16QAM
1.4MHz	23017/699.7	0	1#0	23.00	22.41	22.51	21.92
		0	6#0	21.23	21.09	20.74	20.60
	23095/707.5	0	1#0	23.01	22.28	24.12	23.39
		0	6#0	21.13	20.89	22.24	22.00
	23173/715.3	0	1#5	23.03	22.21	24.83	24.01
		0	6#0	21.14	20.98	22.94	22.78
3MHz	23025/700.5	0	1#0	23.60	22.23	23.11	21.74
		0	6#0	21.16	21.56	20.67	21.07
	23095/707.5	0	1#0	23.41	22.05	24.52	23.16
		0	6#0	21.08	21.45	22.19	22.56
	23165/714.5	1	1#5	23.30	22.02	25.10	23.82
		1	6#0	21.12	21.51	22.92	23.31
5MHz	23035/701.5	3	1#0	23.24	23.12	22.75	22.63
		0	6#0	22.26	21.58	21.77	21.09
	23095/707.5	0	1#0	23.18	22.98	24.29	24.09
		0	6#0	22.19	21.47	23.30	22.58
	23155/713.5	0	1#5	23.14	22.83	24.94	24.63
		3	6#0	22.01	20.63	23.81	22.43
10MHz	23060/704	3	1#0	23.23	23.02	22.74	22.53
		0	4#0	23.33	22.56	22.84	22.07
	23095/707.5	0	1#0	23.25	23.04	24.36	24.15
		0	4#0	23.18	22.72	24.29	23.83
	23130/711	4	1#5	23.03	23.21	24.83	25.01
		7	4#2	23.16	21.81	24.96	23.61

LTE Band 13	Channel/ Frequency(MHz)	Index	RB# RBstart	Conducted Power (dBm)		ERP (dBm)	
				QPSK	16QAM	QPSK	16QAM
5MHz	23205/779.5	3	1#0	23.08	23.33	25.38	25.63
		0	6#0	22.32	21.27	24.62	23.57
	23230/782	0	1#0	23.30	22.91	25.60	25.21
		0	6#0	22.28	21.65	24.58	23.95
	23255/784.5	0	1#5	23.02	22.70	25.32	25.00
		3	6#0	22.22	21.47	24.52	23.77
10MHz	23230/782	0	1#0	23.25	22.87	25.55	25.17
		0	4#0	23.23	22.59	25.53	24.89



LTE Band 66	Channel/ Frequency(MHz)	Index	RB# RBstart	Conducted Power (dBm)		EIRP (dBm)	
				QPSK	16QAM	QPSK	16QAM
1.4MHz	131979/1710.7	0	1#0	23.37	22.56	25.31	24.50
		0	6#0	21.38	21.31	23.32	23.25
	132322/1745	0	1#0	23.41	22.38	25.41	24.38
		0	6#0	21.17	21.38	23.17	23.38
	132665/1779.3	0	1#5	23.11	22.98	24.08	23.95
		0	6#0	21.69	21.42	22.66	22.39
3MHz	131987/1711.5	0	1#0	23.56	22.23	25.50	24.17
		0	6#0	21.49	21.71	23.43	23.65
	132322/1745	0	1#0	23.31	21.98	25.31	23.98
		0	6#0	21.25	21.47	23.25	23.47
	132657/1778.5	1	1#5	23.89	22.41	24.86	23.38
		1	6#0	21.54	22.09	22.51	23.06
5MHz	131997/1712.5	3	1#0	23.55	23.24	25.49	25.18
		0	6#0	22.40	21.49	24.34	23.43
	132322/1745	0	1#0	23.23	23.02	25.23	25.02
		0	6#0	22.23	21.31	24.23	23.31
	132647/1777.5	0	1#5	23.49	23.08	24.46	24.05
		3	6#0	22.71	22.03	23.68	23.00
10MHz	132022/1715	3	1#0	23.43	23.17	25.37	25.11
		0	4#0	23.55	22.71	25.49	24.65
	132022/1745	0	1#0	23.02	23.26	25.02	25.26
		0	4#0	23.12	22.41	25.12	24.41
	132622/1775	4	1#5	23.36	22.97	24.33	23.94
		7	4#2	23.69	23.31	24.66	24.28
15MHz	132047/1717.5	3	1#0	23.48	23.22	25.42	25.16
		0	6#0	23.47	23.48	25.41	25.42
	132322/1745	0	1#0	23.13	23.41	25.13	25.41
		0	6#0	23.10	23.18	25.10	25.18
	132597/1772.5	8	1#5	23.52	23.07	24.49	24.04
		11	6#0	23.55	23.76	24.52	24.73
20MHz	132072/1720	3	1#0	23.42	23.25	25.36	25.19
		0	6#0	23.36	23.40	25.30	25.34
	132322/1745	0	1#0	23.21	22.97	25.21	24.97
		0	6#0	23.18	23.21	25.18	25.21
	132572/1770	12	1#5	23.00	22.54	23.97	23.51
		15	6#0	23.56	23.75	24.53	24.72



LTE Band 85	Channel/ Frequency(MHz)	Index	RB# RBstart	Conducted Power (dBm)		ERP (dBm)	
				QPSK	16QAM	QPSK	16QAM
5MHz	134027/700.5	3	1#0	23.41	23.32	22.92	22.83
		0	6#0	22.19	21.03	21.70	20.54
	134092/707	0	1#0	23.02	22.85	24.13	23.96
		0	6#0	21.92	20.73	23.03	21.84
	134157/713.5	0	1#5	23.08	23.00	24.19	24.11
		3	6#0	22.10	20.88	23.21	21.99
10MHz	134052/703	3	1#0	23.32	23.14	22.83	22.65
		0	4#0	23.07	22.26	22.58	21.77
	134092/707	0	1#0	23.12	23.02	24.23	24.13
		0	4#0	23.05	21.87	24.16	22.98
	134132/711	4	1#5	23.09	23.18	24.20	24.29
		7	4#2	22.82	21.74	23.93	22.85

5.2 Occupied Bandwidth

Ambient condition

Temperature	Relative humidity	Pressure
23°C ~25°C	45%~50%	101.5kPa

Method of Measurement

The EUT was connected to Spectrum Analyzer and Base Station Simulator via power Splitter. The occupied bandwidth is measured using spectrum analyzer.

RBW is set to 51kHz, VBW is set to 160kHz for LTE Band 4/12/13/66/85 .

99% power and -26dBc occupied bandwidths are recorded. Spectrum analyzer plots are included on the following pages.

Test Setup

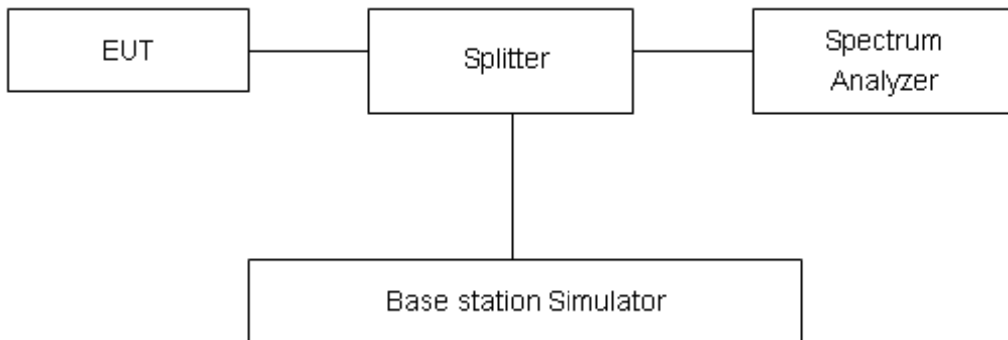

Limits

No specific occupied bandwidth requirements in part 2.1049.

Measurement Uncertainty

The assessed measurement uncertainty to ensure 95% confidence level for the normal distribution is with the coverage factor $k = 2$, $U=624\text{Hz}$.



Test Result

Mode	Bandwidth	Modulation	Channel/ Frequency(MHz)	RB	Bandwidth(MHz)	
					99% Power	-26dBc
LTE Band 4	1.4MHz	QPSK	20175/1732.5	6#0	1.1043	1.310
		16QAM	20175/1732.5	6#0	0.9383	1.358
	3MHz	QPSK	20175/1732.5	6#0	1.1127	1.378
		16QAM	20175/1732.5	6#0	0.9530	1.178
	5MHz	QPSK	20175/1732.5	6#0	1.1120	1.329
		16QAM	20175/1732.5	6#0	0.9523	1.245
	10MHz	QPSK	20175/1732.5	6#0	1.1170	1.350
		16QAM	20175/1732.5	6#0	0.9564	1.177
	15MHz	QPSK	20175/1732.5	6#0	1.1302	1.353
		16QAM	20175/1732.5	6#0	0.9719	1.321
	20MHz	QPSK	20175/1732.5	6#0	1.1324	1.363
		16QAM	20175/1732.5	6#0	0.9736	1.178

Mode	Bandwidth	Modulation	Channel/ Frequency(MHz)	RB	Bandwidth(MHz)	
					99% Power	-26dBc
LTE Band 12	1.4MHz	QPSK	23095/707.5	6#0	1.1009	1.356
		16QAM	23095/707.5	6#0	0.9381	1.227
	3MHz	QPSK	23095/707.5	6#0	1.1082	1.354
		16QAM	23095/707.5	6#0	0.9455	1.172
	5MHz	QPSK	23095/707.5	6#0	1.1121	1.316
		16QAM	23095/707.5	6#0	0.9489	1.201
	10MHz	QPSK	23095/707.5	6#0	1.1163	1.327
		16QAM	23095/707.5	6#0	0.9517	1.237

Mode	Bandwidth	Modulation	Channel/ Frequency(MHz)	RB	Bandwidth(MHz)	
					99% Power	-26dBc
LTE Band 13	5MHz	QPSK	23230/782	6#0	1.1241	1.332
		16QAM	23230/782	6#0	0.9474	1.175
	10MHz	QPSK	23230/782	6#0	1.1212	1.346
		16QAM	23230/782	6#0	0.9559	1.222



Mode	Bandwidth	Modulation	Channel/ Frequency(MHz)	RB	Bandwidth(MHz)	
					99% Power	-26dBc
LTE Band 66	1.4MHz	QPSK	132322/1745	6#0	1.1022	1.327
		16QAM	132322/1745	6#0	0.9406	1.382
	3MHz	QPSK	132322/1745	6#0	1.1088	1.360
		16QAM	132322/1745	6#0	0.9466	1.180
	5MHz	QPSK	132322/1745	6#0	1.1101	1.325
		16QAM	132322/1745	6#0	0.9534	1.201
	10MHz	QPSK	132322/1745	6#0	1.1173	1.321
		16QAM	132322/1745	6#0	0.9573	1.167
	15MHz	QPSK	132322/1745	6#0	1.1145	1.325
		16QAM	132322/1745	6#0	0.9569	1.224
	20MHz	QPSK	132322/1745	6#0	1.1228	1.416
		16QAM	132322/1745	6#0	0.9658	1.245

Mode	Bandwidth	Modulation	Channel/ Frequency(MHz)	RB	Bandwidth(MHz)	
					99% Power	-26dBc
LTE Band 85	5MHz	QPSK	134092/707	6#0	1.1412	1.389
		16QAM	134092/707	6#0	0.9530	1.178
	10MHz	QPSK	134092/707	6#0	1.1255	1.413
		16QAM	134092/707	6#0	0.9577	1.203



LTE Band 4 QPSK 1.4MHz CH-Middle



LTE Band 4 QPSK 3MHz CH-Middle



LTE Band 4 QPSK 5MHz CH-Middle



LTE Band 4 QPSK 10MHz CH-Middle



LTE Band 4 QPSK 15MHz CH-Middle



LTE Band 4 QPSK 20MHz CH-Middle





LTE Band 4 16QAM 1.4MHz CH-Middle



LTE Band 4 16QAM 3MHz CH-Middle

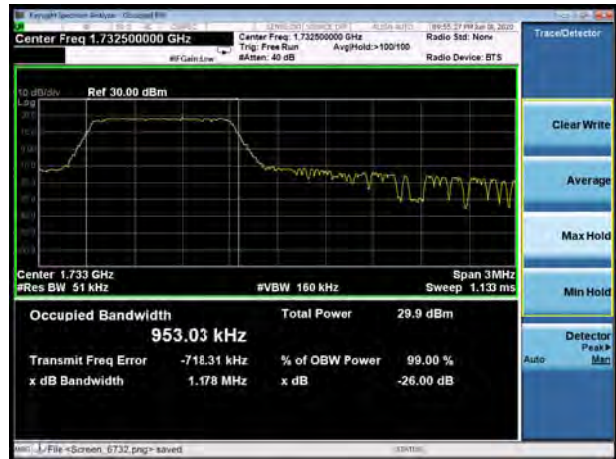

LTE Band 4 16QAM 5MHz CH-Middle



LTE Band 4 16QAM 10MHz CH-Middle



LTE Band 4 16QAM 15MHz CH-Middle



LTE Band 4 16QAM 20MHz CH-Middle





LTE Band 12 QPSK 1.4MHz CH-Middle



LTE Band 12 QPSK 3MHz CH-Middle

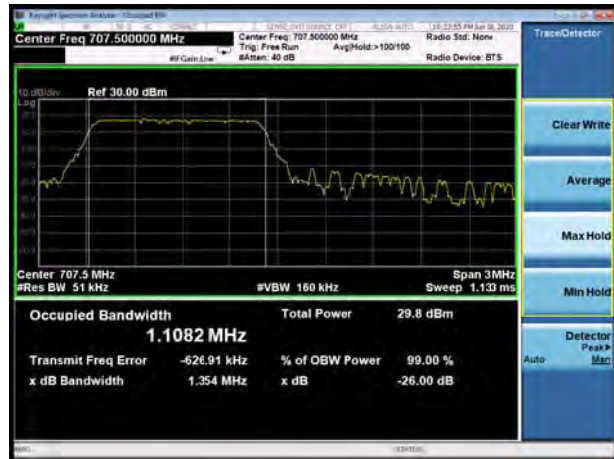

LTE Band 12 QPSK 5MHz CH-Middle



LTE Band 12 QPSK 10MHz CH-Middle



LTE Band 12 16QAM 1.4MHz CH-Middle

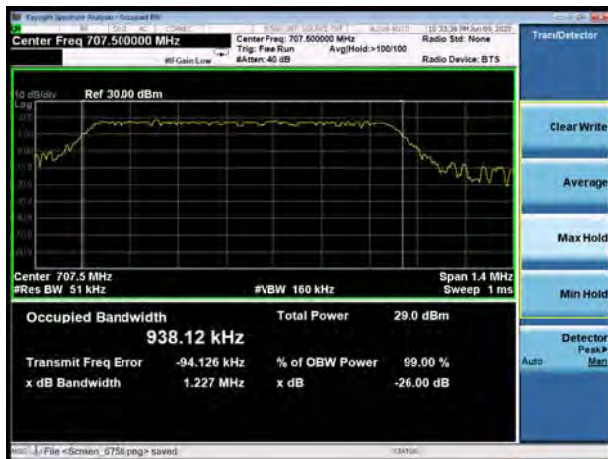

LTE Band 12 16QAM 3MHz CH-Middle

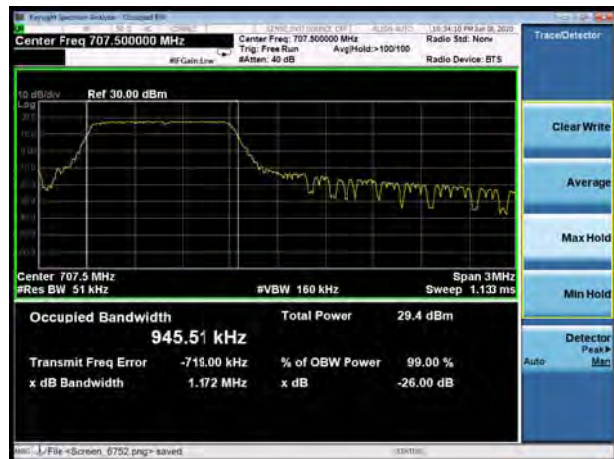

LTE Band 12 16QAM 5MHz CH-Middle



LTE Band 12 16QAM 10MHz CH-Middle



LTE Band 13 QPSK 5MHz CH-Middle



LTE Band 13 QPSK 10MHz CH-Middle



LTE Band 13 16QAM 5MHz CH-Middle



LTE Band 13 16QAM 10MHz CH-Middle





LTE Band 66 QPSK 1.4MHz CH-Middle



LTE Band 66 QPSK 3MHz CH-Middle

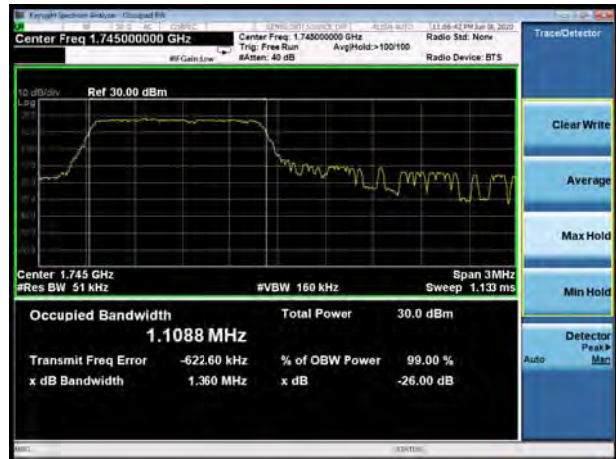

LTE Band 66 QPSK 5MHz CH-Middle



LTE Band 66 QPSK 10MHz CH-Middle



LTE Band 66 QPSK 15MHz CH-Middle



LTE Band 66 QPSK 20MHz CH-Middle



LTE Band 66 16QAM 1.4MHz CH-Middle

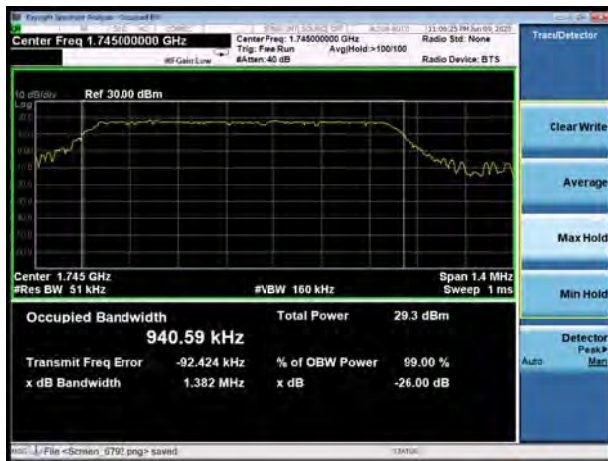

LTE Band 66 16QAM 3MHz CH-Middle



LTE Band 66 16QAM 5MHz CH-Middle



LTE Band 66 16QAM 10MHz CH-Middle



LTE Band 66 16QAM 15MHz CH-Middle



LTE Band 66 16QAM 20MHz CH-Middle





LTE Band 85 QPSK 5MHz CH-Middle



LTE Band 85 QPSK 10MHz CH-Middle



LTE Band 85 16QAM 5MHz CH-Middle



LTE Band 85 16QAM 10MHz CH-Middle



5.3 Band Edge Compliance

Ambient condition

Temperature	Relative humidity	Pressure
23°C ~25°C	45%~50%	101.5kPa

Method of Measurement

The EUT was connected to Spectrum Analyzer and Base Station Simulator via power Splitter. The band edge of the lowest and highest channels were measured.

The testing follows KDB 971168 D01 v03r01 Section 6.0

The EUT was connected to spectrum analyzer and system simulator via a power divider.

The band edges of low and high channels for the highest RF powers were measured.

RBW is set to 51kHz, VBW is set to 160kHz for LTE Band 4/12/66/85 .

RBW is set to 6.25 kHz for LTE Band 13 (763MHz~775MHz).

RBW is set to 100 kHz for LTE Band 13 (775MHz~776MHz).

RBW is set to 200 kHz for LTE Band 13 (776MHz~788MHz).

RBW is set to 100 kHz for LTE Band 13 (788MHz~793MHz).

RBW is set to 6.25 kHz for LTE Band 13 (793MHz~805MHz).

on spectrum analyzer.

Set spectrum analyzer with RMS detector.

The RF fundamental frequency should be excluded against the limit line in the operating frequency band.

Checked that all the results comply with the emission limit line.

Test Setup

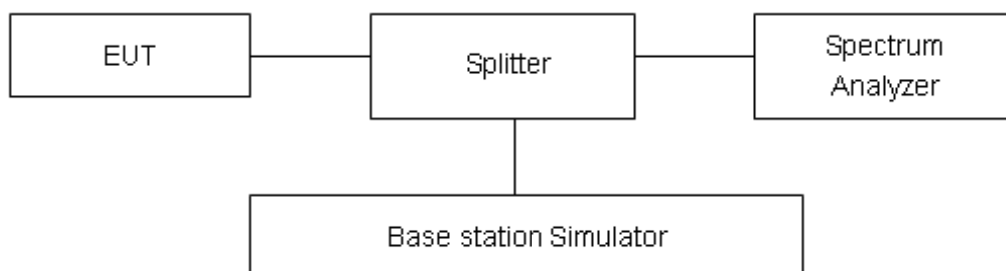

Limits

Rule Part 27.53(i) By a factor of not less than $43 + 10 \log (P)$ dB on all frequencies between 2305 and 2320 MHz.

Rule Part 27.53(h) specifies that “ for operations in the 1695-1710 MHz, 1710-1755 MHz, 1755-1780



MHz, 1915-1920 MHz, 1995-2000 MHz, 2000-2020 MHz, 2110-2155 MHz, 2155-2180 MHz, and 2180-2200 bands, the power of any emission outside a licensee's frequency block shall be attenuated below the transmitter power (P) in watts by at least $43 + 10 \log_{10} (P)$ dB"

Rule Part 27.53(g) For operations in the 600 MHz band and the 698-746 MHz band, the power of any emission outside a licensee's frequency band(s) of operation shall be attenuated below the transmitter power (P) within the licensed band(s) of operation, measured in watts, by at least $43 + 10 \log (P)$ dB. Compliance with this provision is based on the use of measurement instrumentation employing a resolution bandwidth of 100 kilohertz or greater. However, in the 100 kilohertz bands immediately outside and adjacent to a licensee's frequency block, a resolution bandwidth of at least 30 kHz may be employed.

Rule Part 27.53(m) (4) specifies that "for BRS and EBS stations. For mobile digital stations, the attenuation factor shall be not less than $40 + 10 \log (P)$ dB on all frequencies between the channel edge and 5 megahertz from the channel edge, $43 + 10 \log (P)$ dB on all frequencies between 5 megahertz and X megahertz from the channel edge, and $55 + 10 \log (P)$ dB on all frequencies more than X megahertz from the channel edge, where X is the greater of 6 megahertz or the actual emission bandwidth as defined in paragraph (m)(4) of this section. In addition, the attenuation factor shall not be less than $43 + 10 \log (P)$ dB on all frequencies between 2490.5 MHz and 2496 MHz and $55 + 10 \log (P)$ dB at or below 2490.5 MHz. Mobile Satellite Service licensees operating on frequencies below 2495 MHz may also submit a documented interference complaint against BRS licensees operating on channel BRS Channel 1 on the same terms and conditions as adjacent channel BRS or EBS licensees.

Example:

The limit line is derived from $43 + 10 \log (P)$ dB below the transmitter power P(Watts)
= P(W)- [43 + 10log(P)] (dB)
= [30 + 10log (P)] (dBm) - [43 + 10log(P)] (dB) = -13dBm.

Rule Part 27.53(f) For operations in the 746-758 MHz, 775-788 MHz, and 805-806 MHz bands, emissions in the band 1559-1610 MHz shall be limited to -70 dBW/MHz equivalent isotropically radiated power (EIRP) for wideband signals, and -80 dBW EIRP for discrete emissions of less than 700 Hz bandwidth. For the purpose of equipment authorization, a transmitter shall be tested with an antenna that is representative of the type that will be used with the equipment in normal operation.

Rule Part 27.53 (c) For operations in the 746-758 MHz band and the 776-788 MHz band, the power of any emission outside the licensee's frequency band(s) of operation shall be attenuated below the transmitter power (P) within the licensed band(s) of operation, measured in watts, in accordance with the following:

- (1) On any frequency outside the 746-758 MHz band, the power of any emission shall be attenuated outside the band below the transmitter power (P) by at least $43 + 10 \log (P)$ dB;
- (2) On any frequency outside the 776-788 MHz band, the power of any emission shall be attenuated outside the band below the transmitter power (P) by at least $43 + 10 \log (P)$ dB;
- (3) On all frequencies between 763-775 MHz and 793-805 MHz, by a factor not less than $76 + 10 \log (P)$ dB in a 6.25 kHz band segment, for base and fixed stations;
- (4) On all frequencies between 763-775 MHz and 793-805 MHz, by a factor not less than $65 + 10 \log$



(P) dB in a 6.25 kHz band segment, for mobile and portable stations;

(5) Compliance with the provisions of paragraphs (c)(1) and (c)(2) of this section is based on the use of measurement instrumentation employing a resolution bandwidth of 100 kHz or greater. However, in the 100 kHz bands immediately outside and adjacent to the frequency block, a resolution bandwidth of at least 30 kHz may be employed;

Measurement Uncertainty

The assessed measurement uncertainty to ensure 95% confidence level for the normal distribution is with the coverage factor $k = 1.96$, $U=0.684\text{dB}$.

Test Result

All the test traces in the plots shows the test results clearly.

LTE Band 4 QPSK 1.4MHz CH-Low, 1 RB



LTE Band 4 QPSK 1.4MHz CH-High, 1 RB



LTE Band 4 QPSK 1.4MHz CH-Low, 100%RB

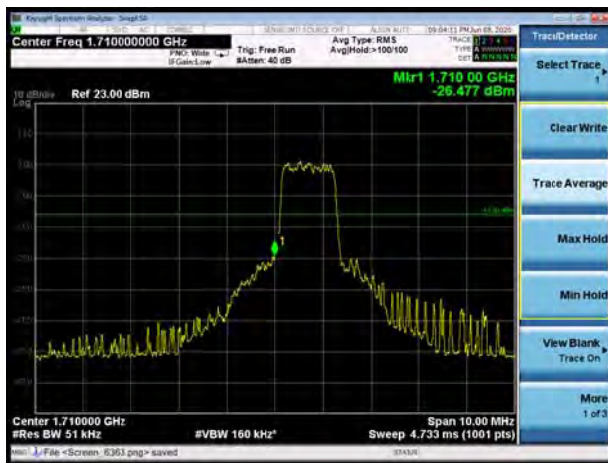

LTE Band 4 QPSK 1.4MHz CH-High, 100%RB



LTE Band 4 QPSK 3MHz CH-Low, 1 RB

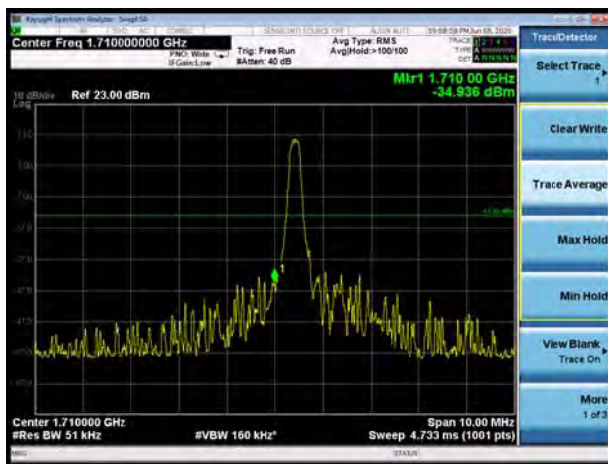

LTE Band 4 QPSK 3MHz CH-High, 1 RB

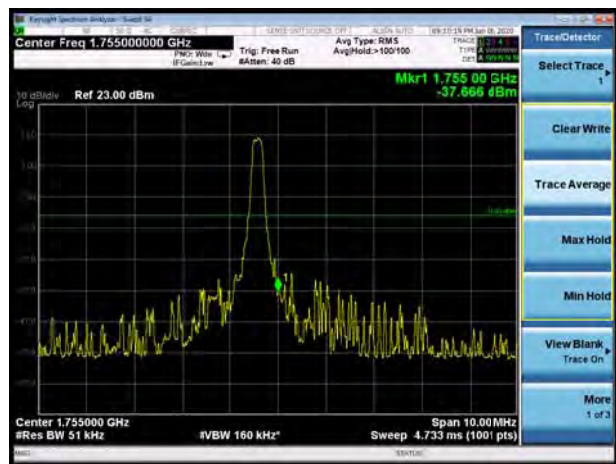

LTE Band 4 QPSK 3MHz CH-Low, 100%RB

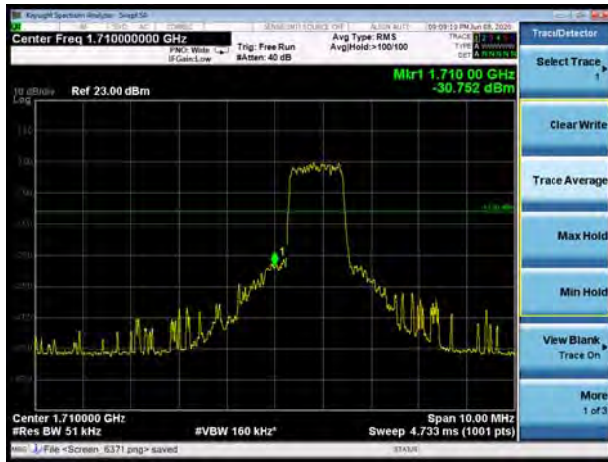

LTE Band 4 QPSK 3MHz CH-High, 100%RB

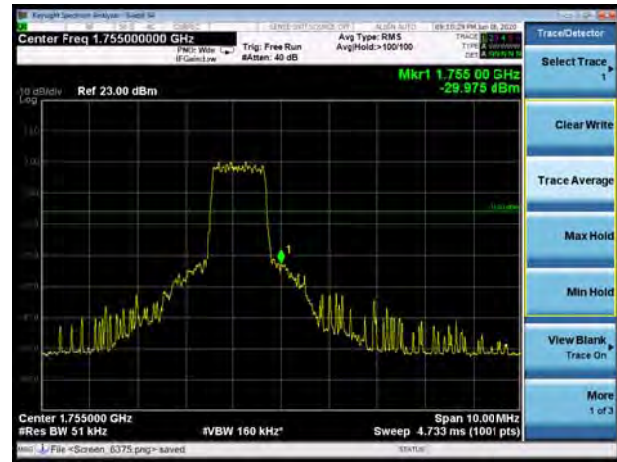

LTE Band 4 QPSK 5MHz CH-Low, 1 RB



LTE Band 4 QPSK 5MHz CH-High, 1 RB



LTE Band 4 QPSK 5MHz CH-Low, 100%RB

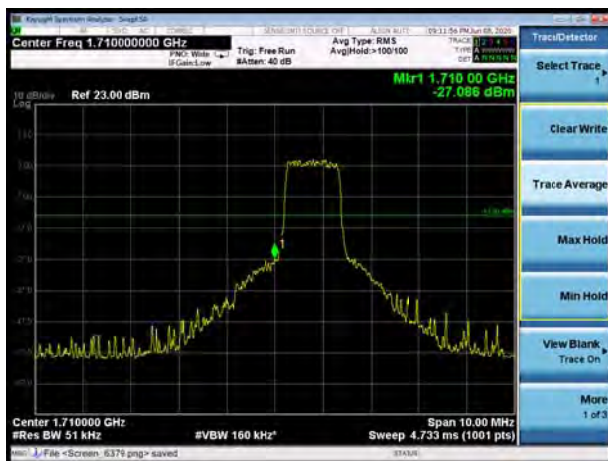

LTE Band 4 QPSK 5MHz CH-High, 100%RB

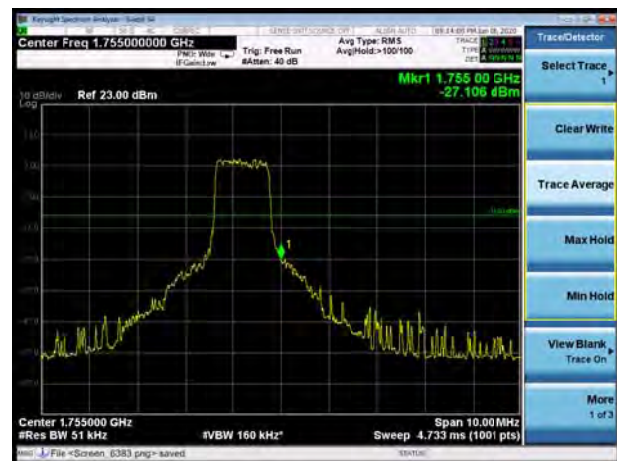



LTE Band 4 QPSK 10MHz CH-Low, 1 RB

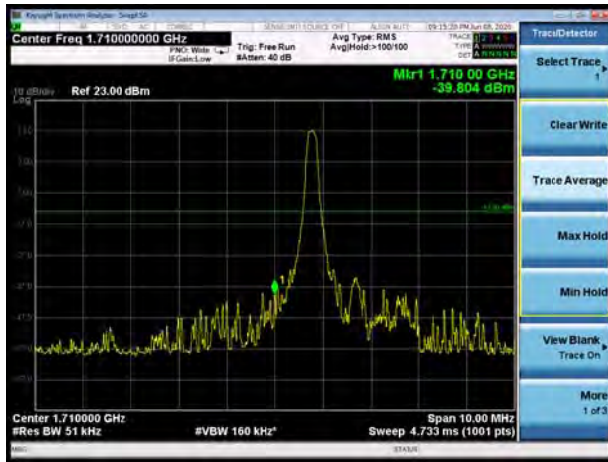

LTE Band 4 QPSK 10MHz CH-High, 1 RB

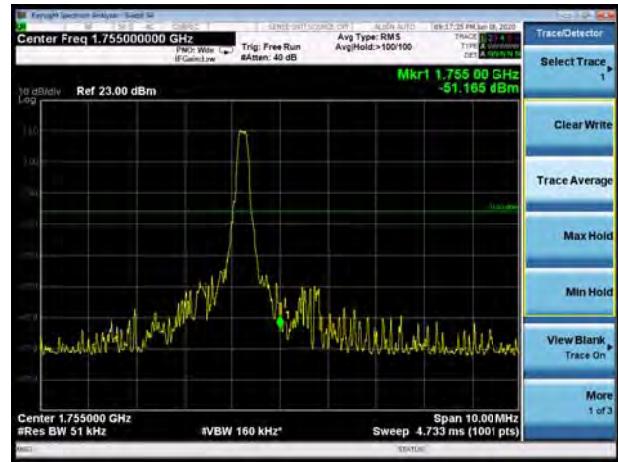

LTE Band 4 QPSK 10MHz CH-Low, 100%RB

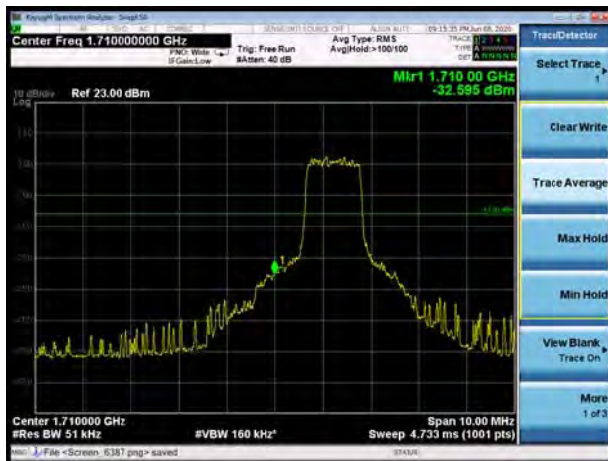

LTE Band 4 QPSK 10MHz CH-High, 100%RB

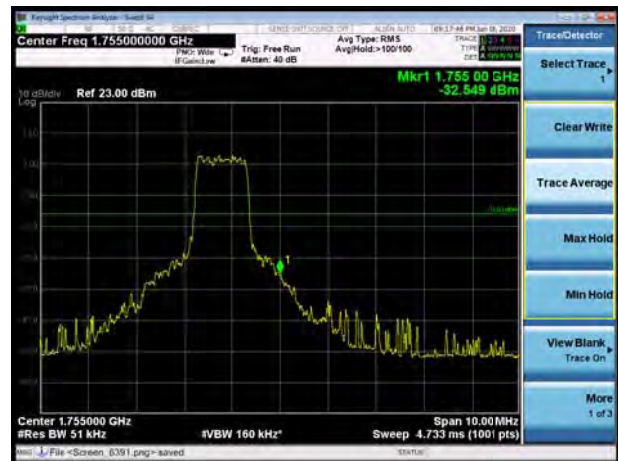

LTE Band 4 QPSK 15MHz CH-Low, 1 RB

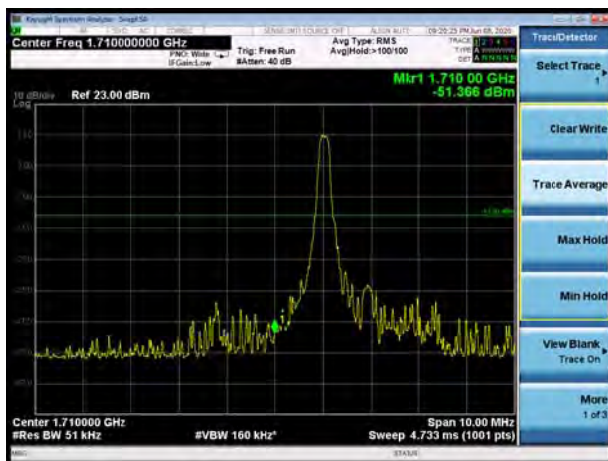

LTE Band 4 QPSK 15MHz CH-High, 1 RB

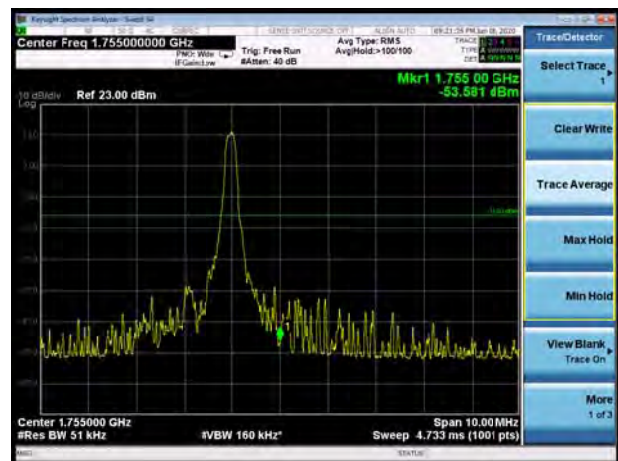

LTE Band 4 QPSK 15MHz CH-Low, 100%RB



LTE Band 4 QPSK 15MHz CH-High, 100%RB

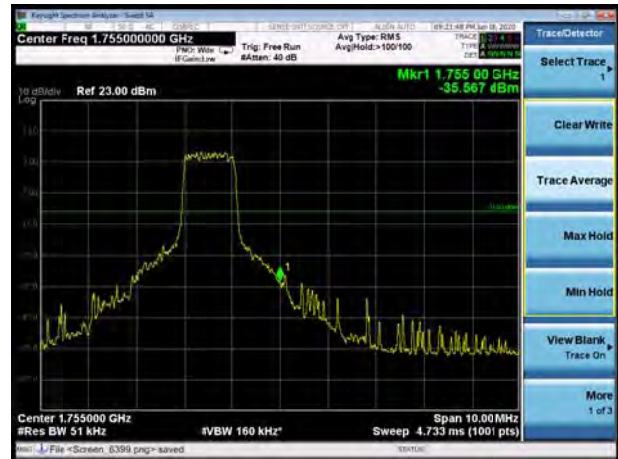

LTE Band 4 QPSK 20MHz CH-Low, 1 RB



LTE Band 4 QPSK 20MHz CH-High, 1 RB



LTE Band 4 QPSK 20MHz CH-Low, 100%RB

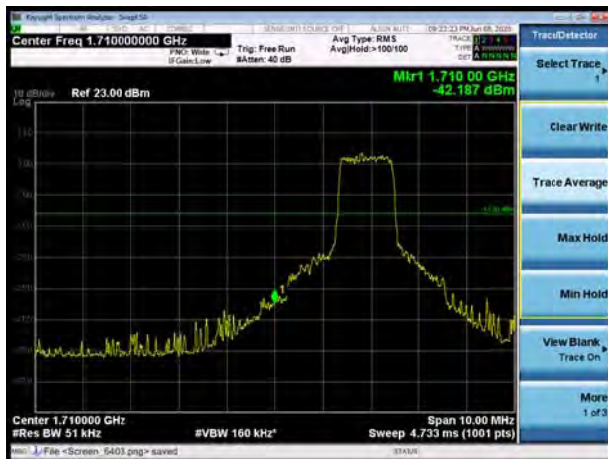

LTE Band 4 QPSK 20MHz CH-High, 100%RB

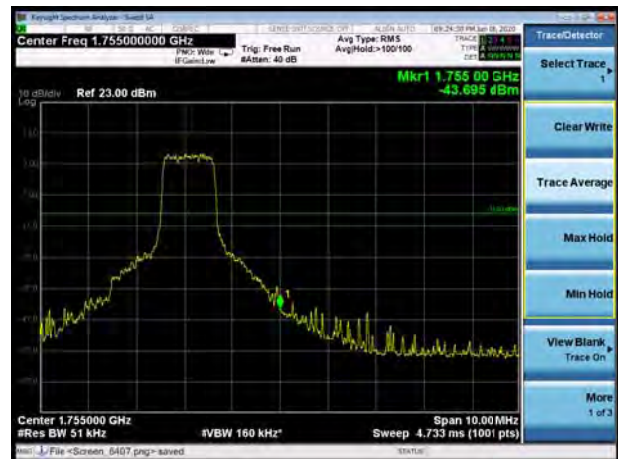



LTE Band 4 16QAM 1.4MHz CH-Low, 1 RB



LTE Band 4 16QAM 1.4MHz CH-High, 1 RB

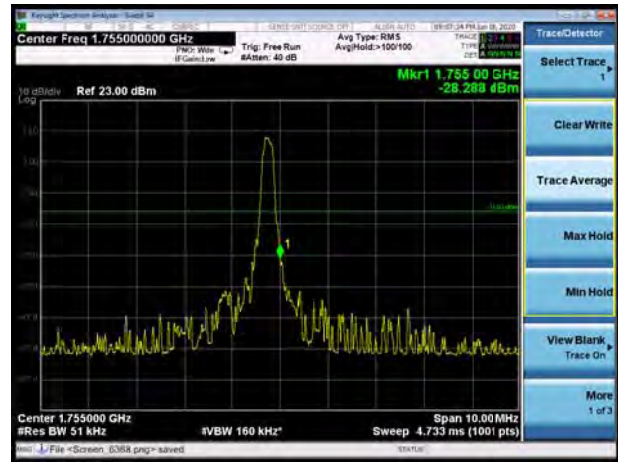

LTE Band 4 16QAM 1.4MHz CH-Low, 100%RB

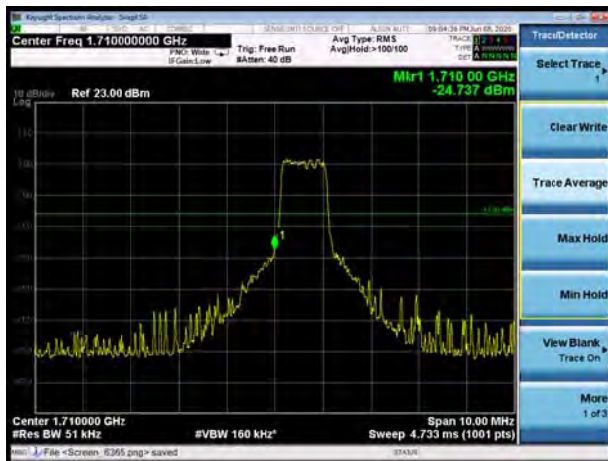

LTE Band 4 16QAM 1.4MHz CH-High, 100%RB

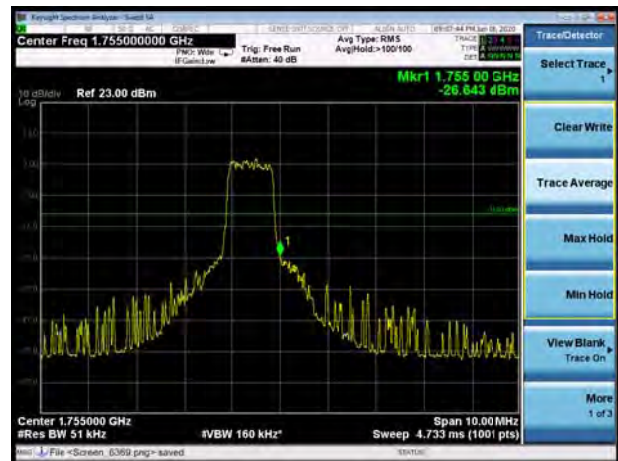

LTE Band 4 16QAM 3MHz CH-Low, 1 RB



LTE Band 4 16QAM 3MHz CH-High, 1 RB





LTE Band 4 16QAM 3MHz CH-Low, 100%RB

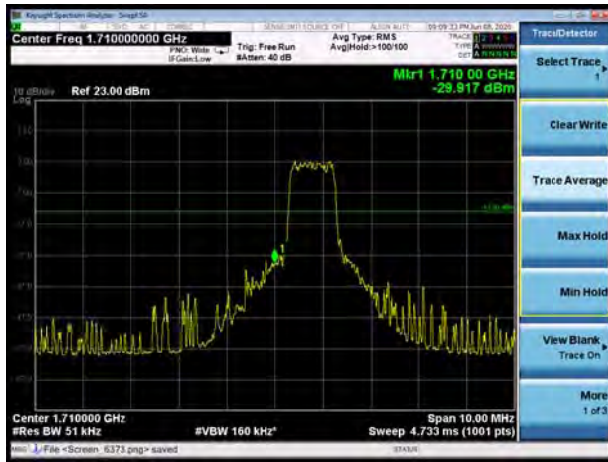

LTE Band 4 16QAM 3MHz CH-High, 100%RB

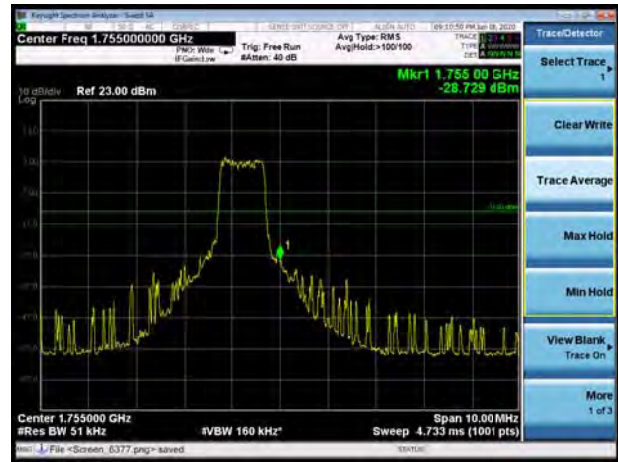

LTE Band 4 16QAM 5MHz CH-Low, 1 RB

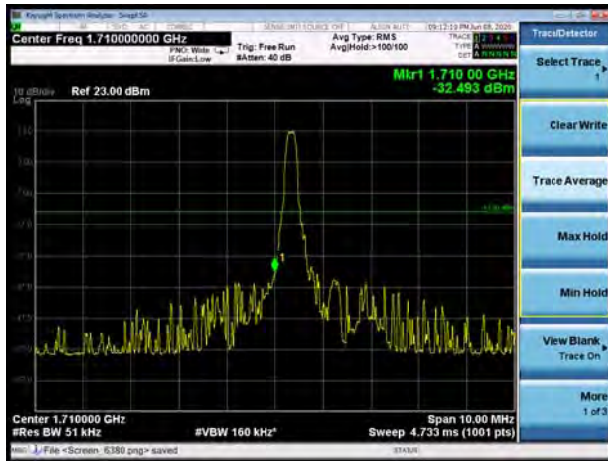

LTE Band 4 16QAM 5MHz CH-High, 1 RB

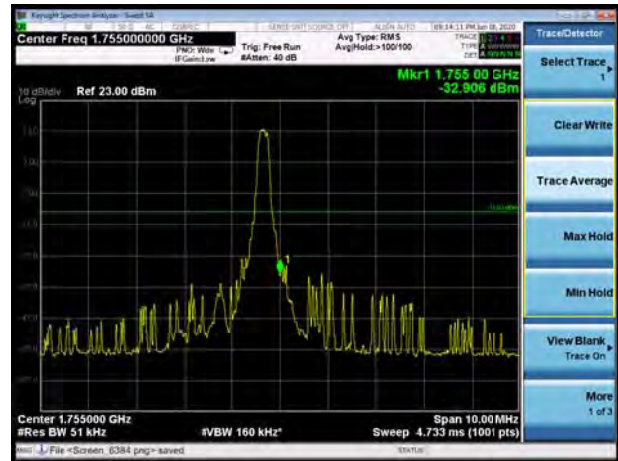

LTE Band 4 16QAM 5MHz CH-Low, 100%RB

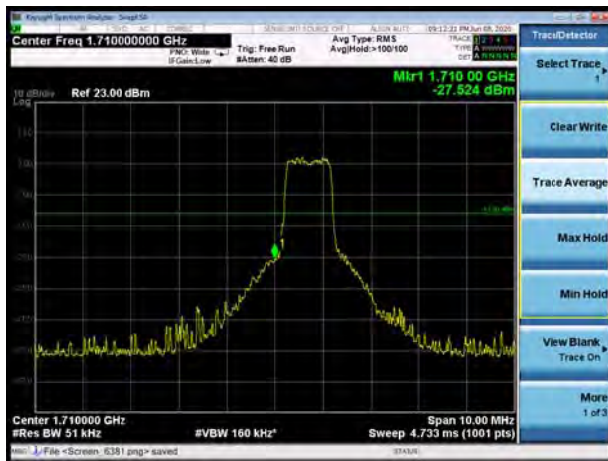

LTE Band 4 16QAM 5MHz CH-High, 100%RB

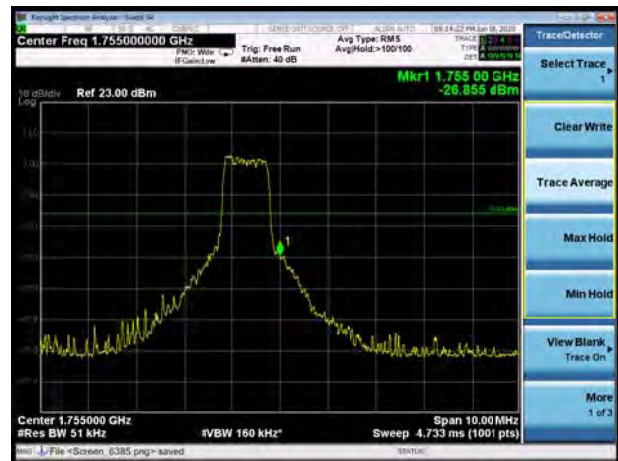

LTE Band 4 16QAM 10MHz CH-Low, 1 RB

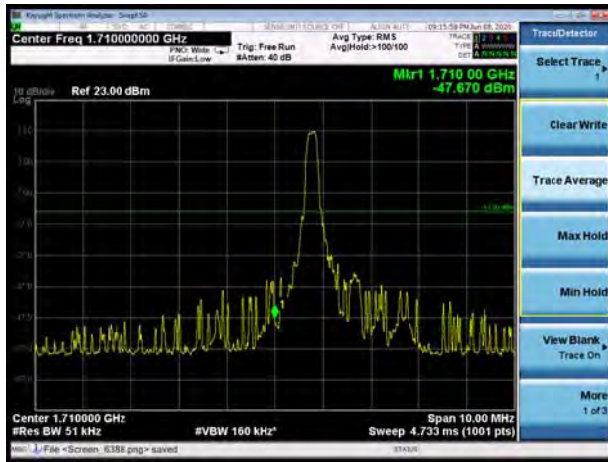

LTE Band 4 16QAM 10MHz CH-High, 1 RB

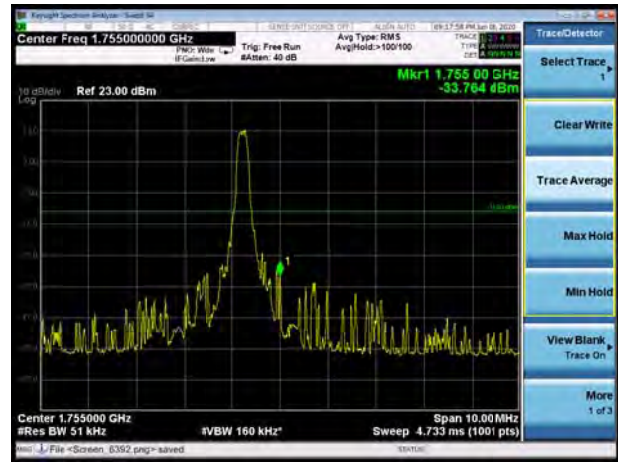

LTE Band 4 16QAM 10MHz CH-Low, 100%RB

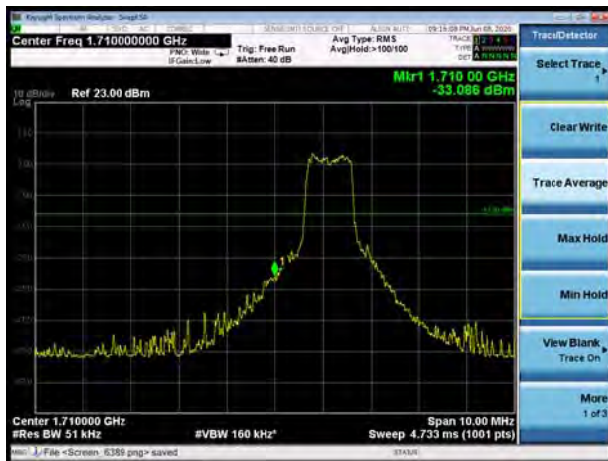

LTE Band 4 16QAM 10MHz CH-High, 100%RB

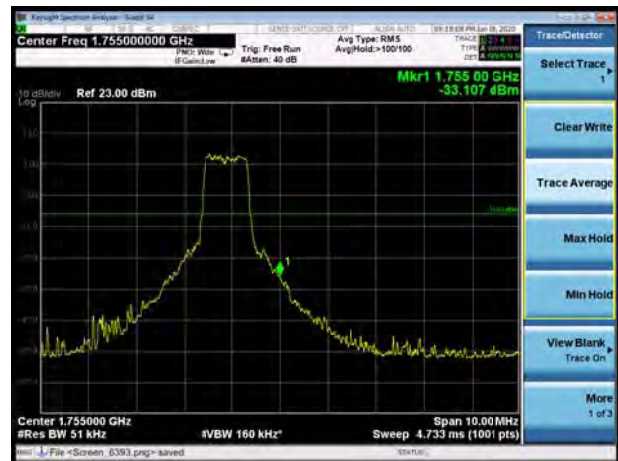

LTE Band 4 16QAM 15MHz CH-Low, 1 RB



LTE Band 4 16QAM 15MHz CH-High, 1 RB



LTE Band 4 16QAM 15MHz CH-Low, 100%RB

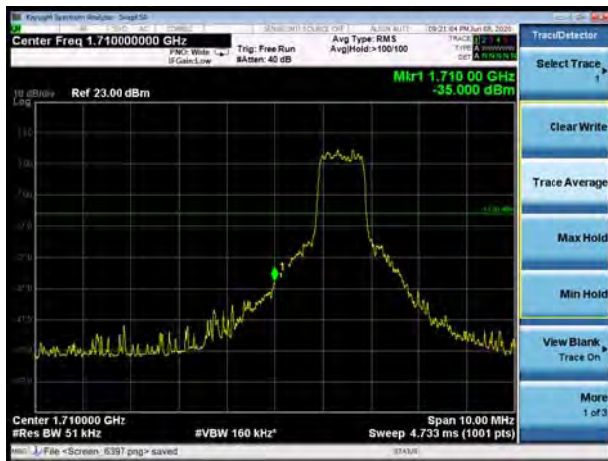

LTE Band 4 16QAM 15MHz CH-High, 100%RB



LTE Band 4 16QAM 20MHz CH-Low, 1 RB



LTE Band 4 16QAM 20MHz CH-High, 1 RB

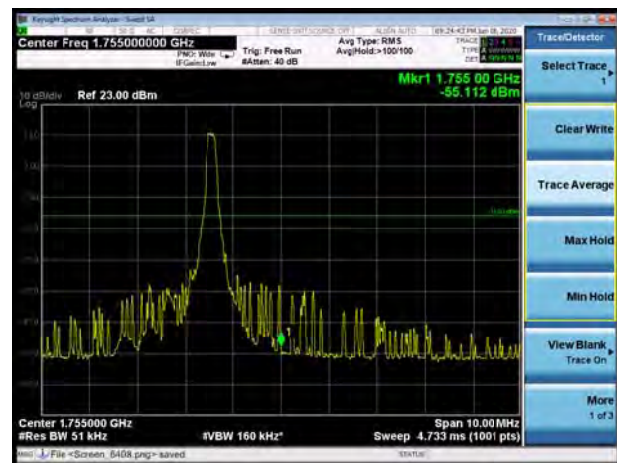

LTE Band 4 16QAM 20MHz CH-Low, 100%RB

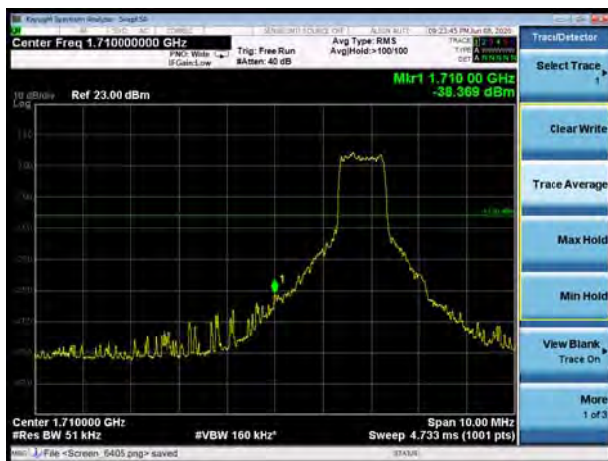

LTE Band 4 16QAM 20MHz CH-High, 100%RB

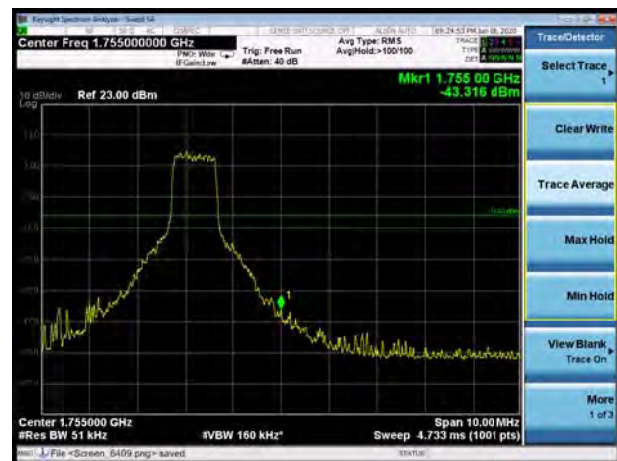

LTE Band 12 QPSK 1.4MHz CH-Low, 1 RB

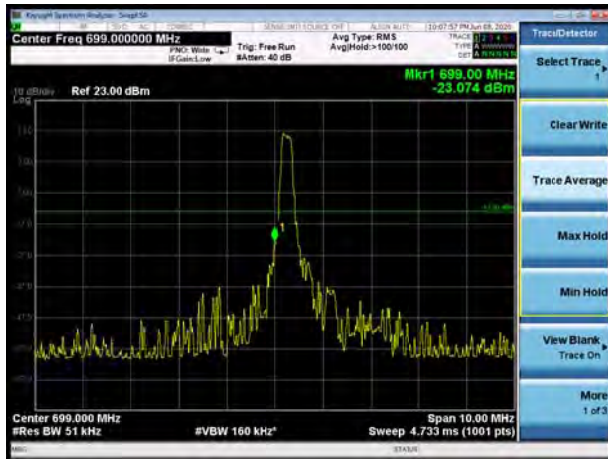

LTE Band 12 QPSK 1.4MHz CH-High, 1 RB

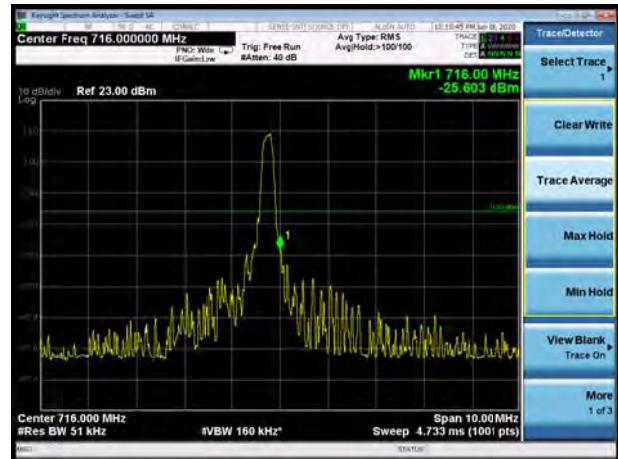

LTE Band 12 QPSK 1.4MHz CH-Low, 100%RB

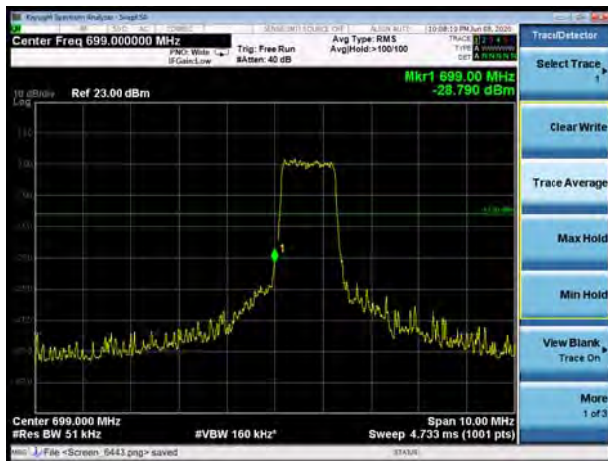

LTE Band 12 QPSK 1.4MHz CH-High, 100%RB

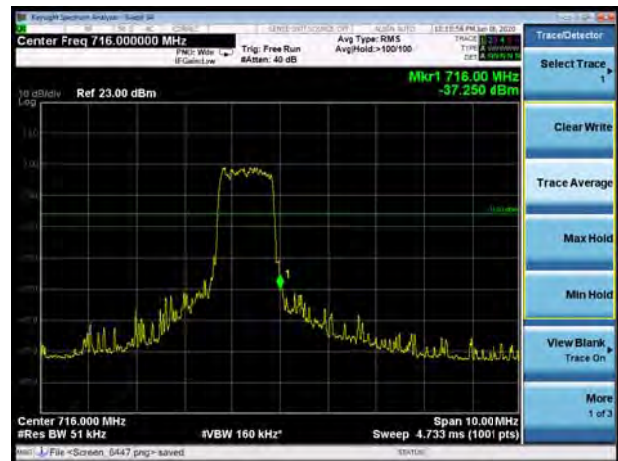

LTE Band 12 QPSK 3MHz CH-Low, 1 RB

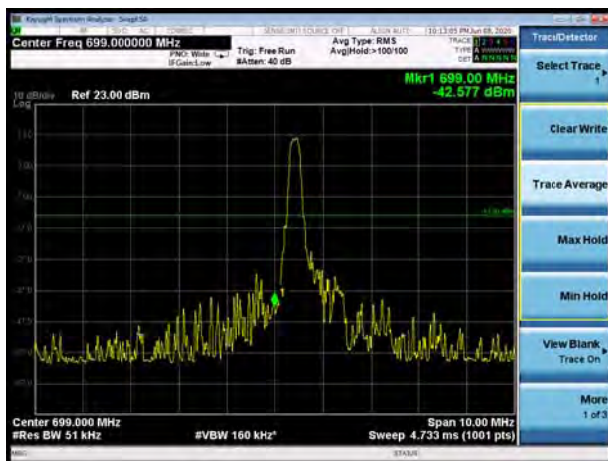

LTE Band 12 QPSK 3MHz CH-High, 1 RB

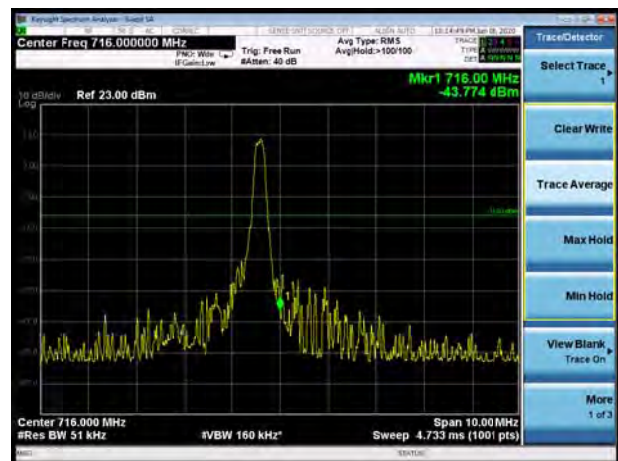



LTE Band 12 QPSK 3MHz CH-Low, 100%RB

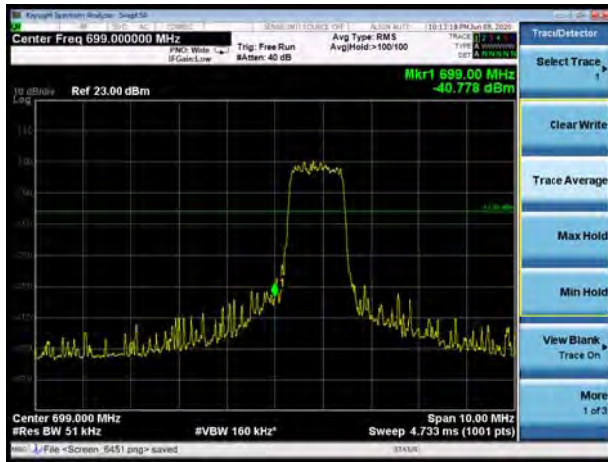

LTE Band 12 QPSK 3MHz CH-High, 100%RB

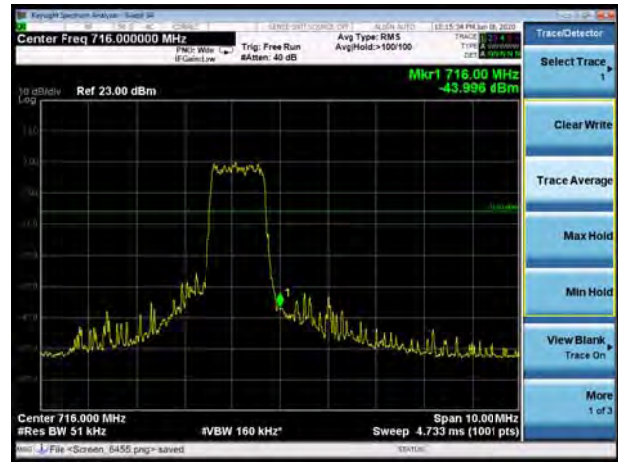

LTE Band 12 QPSK 5MHz CH-Low, 1 RB

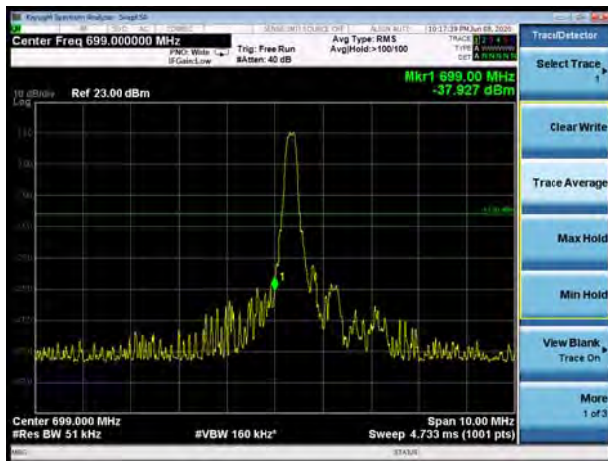

LTE Band 12 QPSK 5MHz CH-High, 1 RB

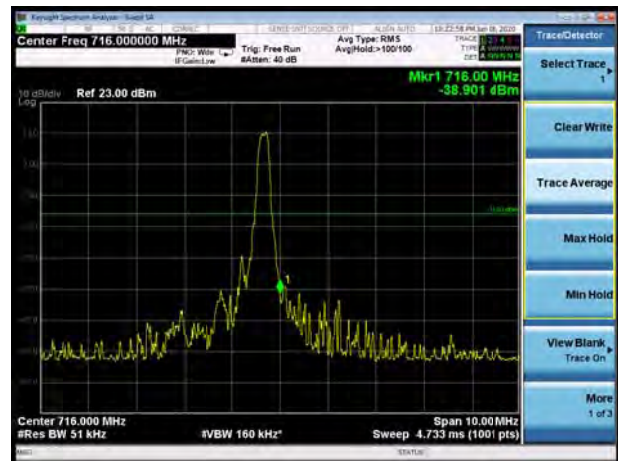

LTE Band 12 QPSK 5MHz CH-Low, 100%RB



LTE Band 12 QPSK 5MHz CH-High, 100%RB

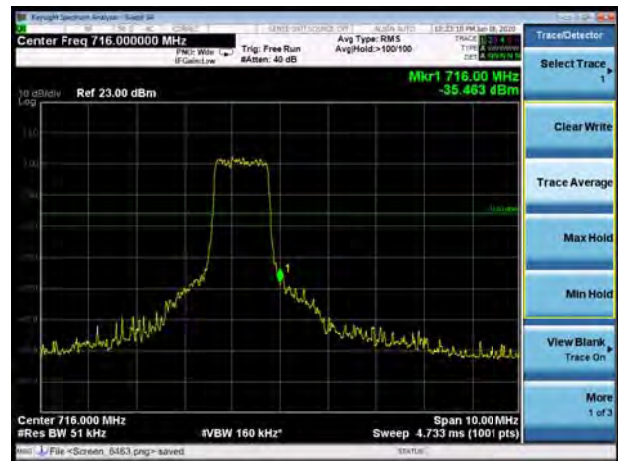



LTE Band 12 QPSK 10MHz CH-Low, 1 RB

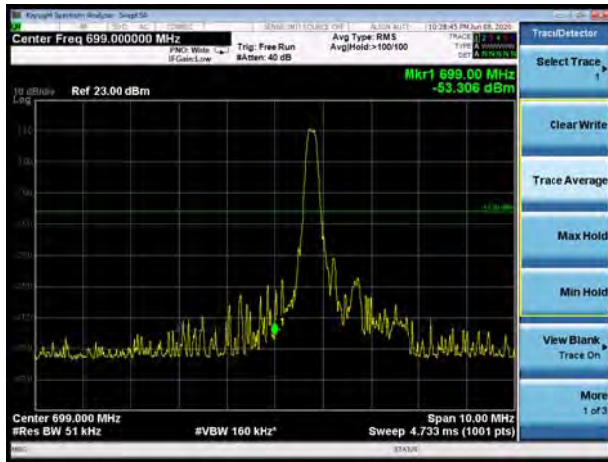

LTE Band 12 QPSK 10MHz CH-High, 1 RB



LTE Band 12 QPSK 10MHz CH-Low, 100%RB

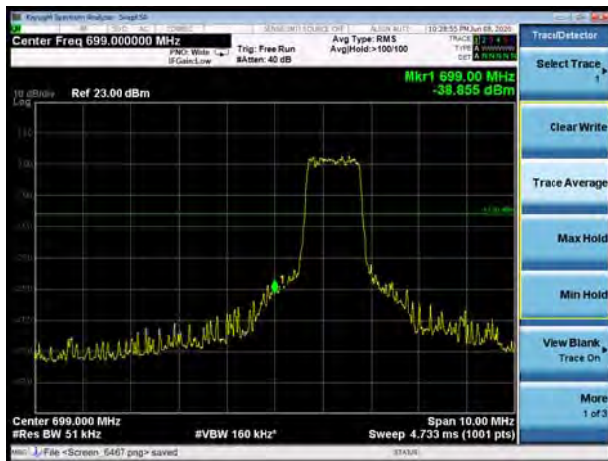

LTE Band 12 QPSK 10MHz CH-High, 100%RB

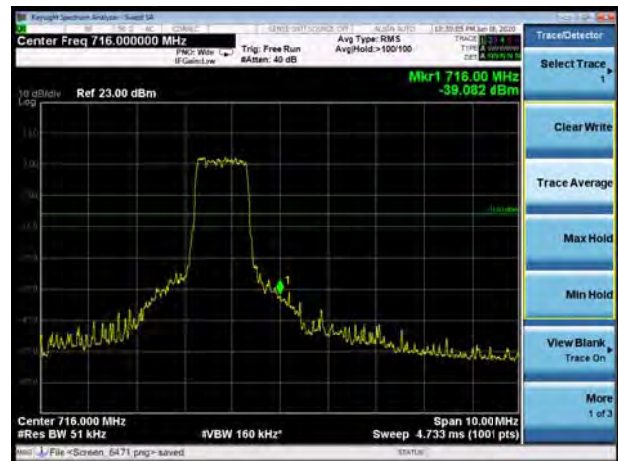

LTE Band 12 16QAM 1.4MHz CH-Low, 1 RB



LTE Band 12 16QAM 1.4MHz CH-High, 1 RB





LTE Band 12 16QAM 1.4MHz CH-Low, 100%RB

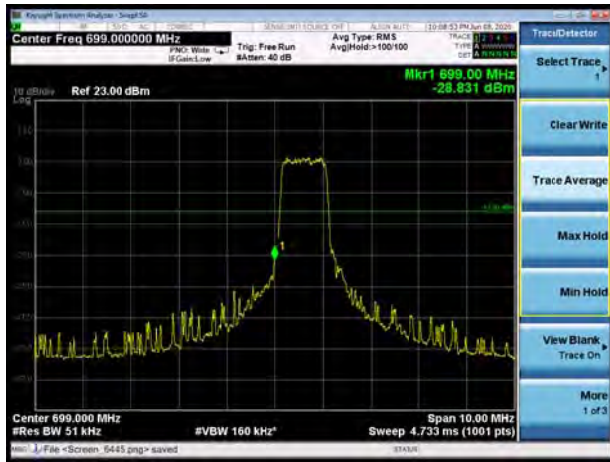

LTE Band 12 16QAM 1.4MHz CH-High, 100%RB

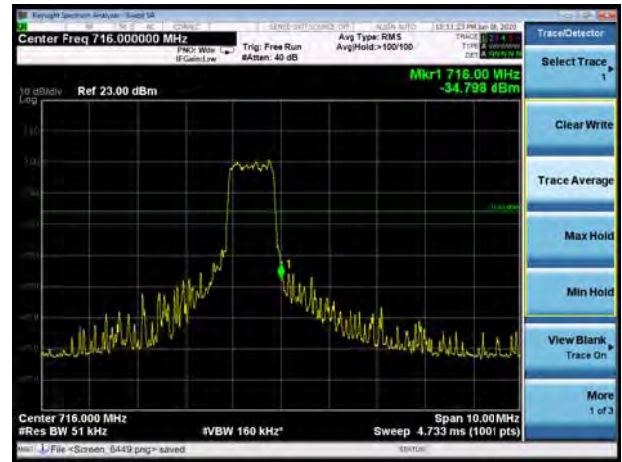

LTE Band 12 16QAM 3MHz CH-Low, 1 RB

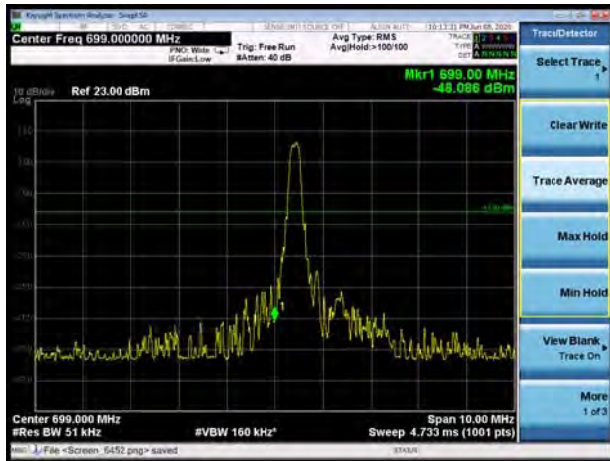

LTE Band 12 16QAM 3MHz CH-High, 1 RB

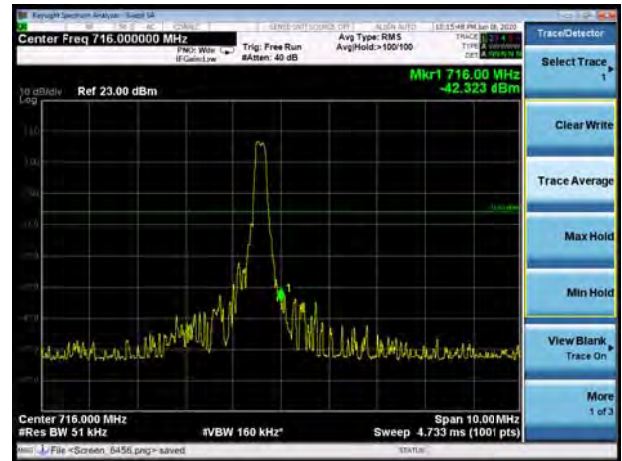

LTE Band 12 16QAM 3MHz CH-Low, 100%RB

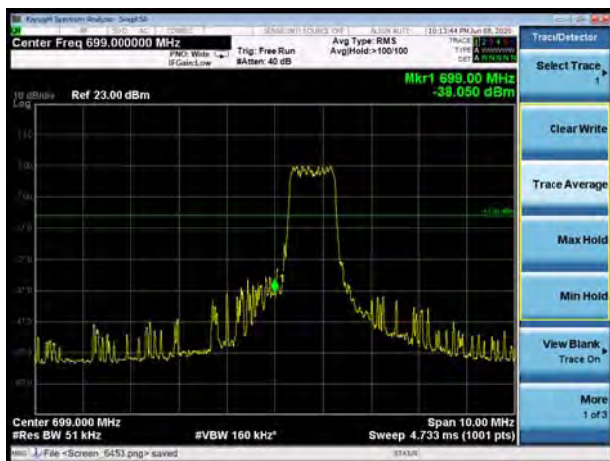

LTE Band 12 16QAM 3MHz CH-High, 100%RB

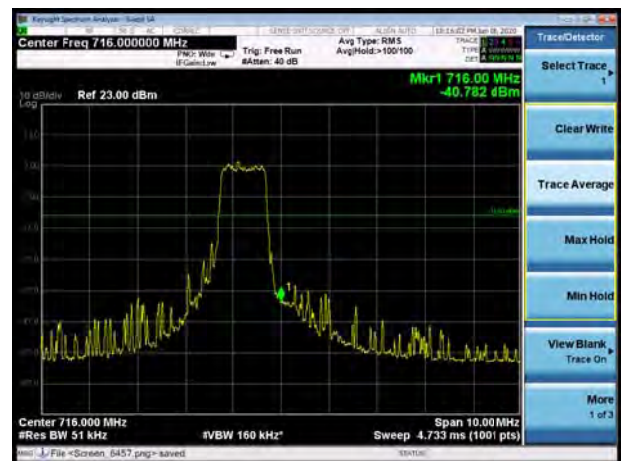



LTE Band 12 16QAM 5MHz CH-Low, 1 RB

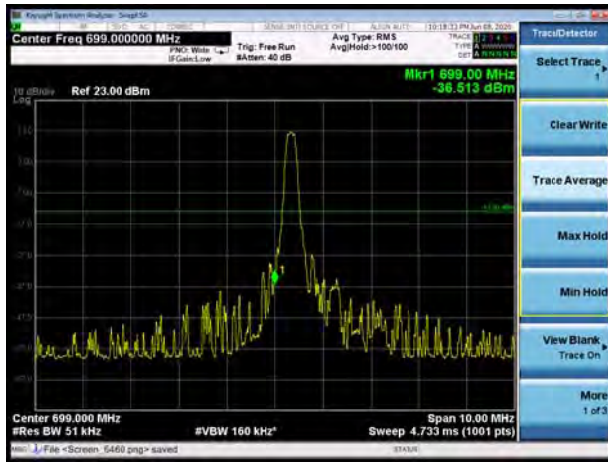

LTE Band 12 16QAM 5MHz CH-High, 1 RB



LTE Band 12 16QAM 5MHz CH-Low, 100%RB

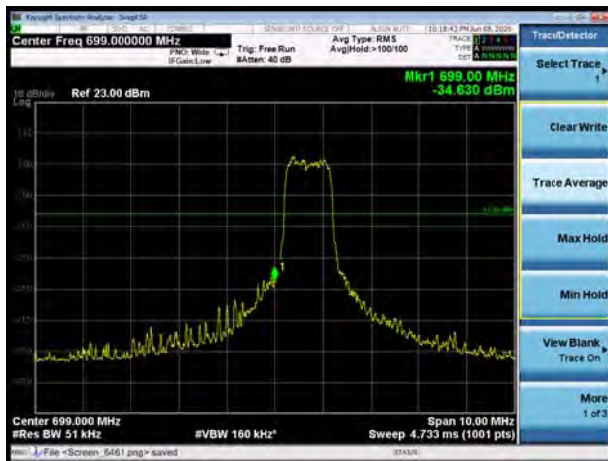

LTE Band 12 16QAM 5MHz CH-High, 100%RB

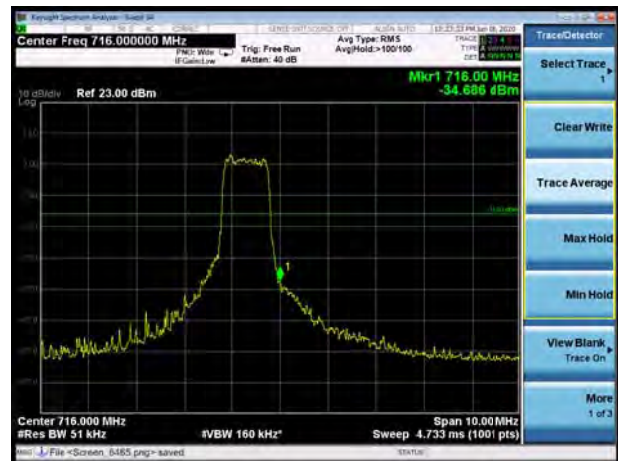

LTE Band 12 16QAM 10MHz CH-Low, 1 RB

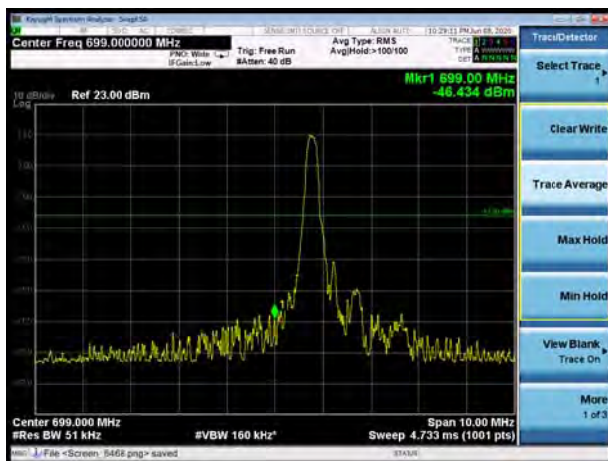

LTE Band 12 16QAM 10MHz CH-High, 1 RB

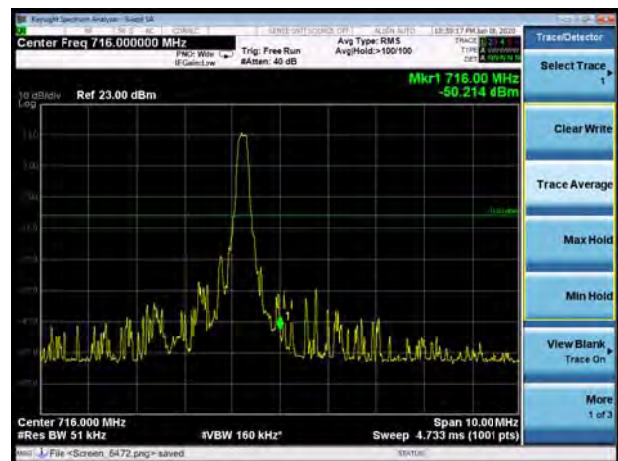



LTE Band 12 16QAM 10MHz CH-Low, 100%RB

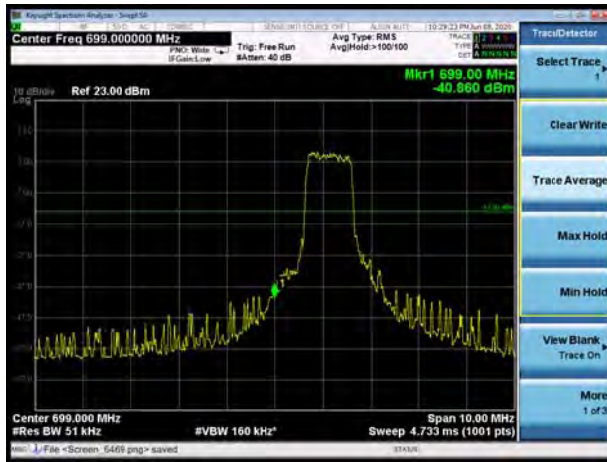

LTE Band 12 16QAM 10MHz CH-High, 100%RB

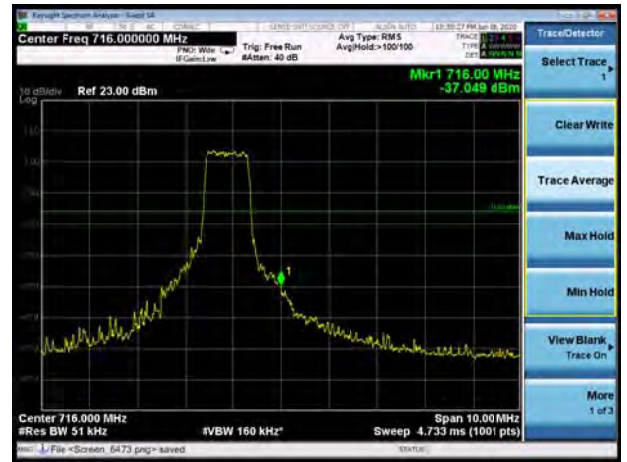

LTE Band 13 QPSK 5MHz CH-Low, 1 RB

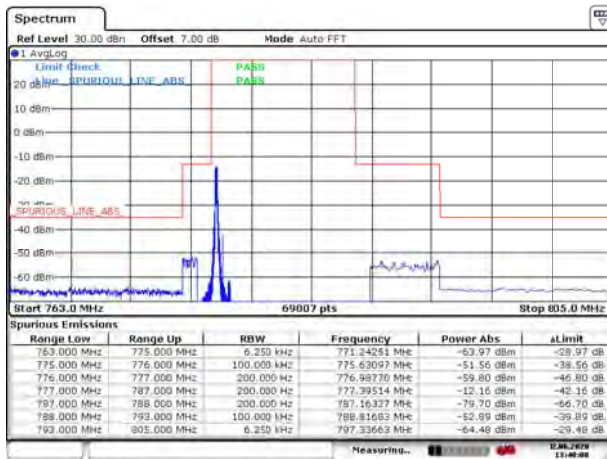

Date: 12 JUN 2020 13:40:08

LTE Band 13 QPSK 5MHz CH-High, 1 RB

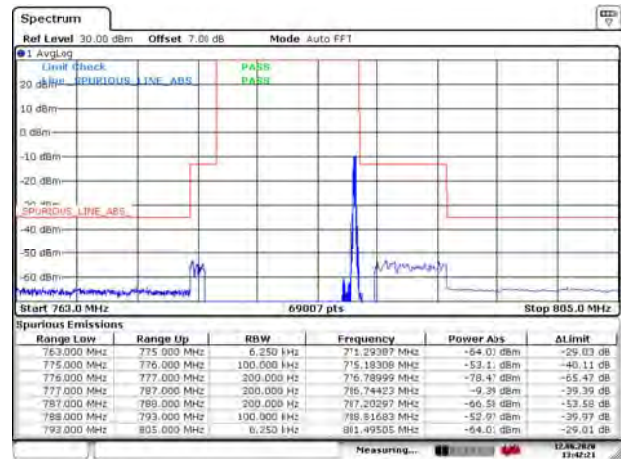

Date: 12 JUN 2020 13:42:21

LTE Band 13 QPSK 5MHz CH-Low, 100%RB

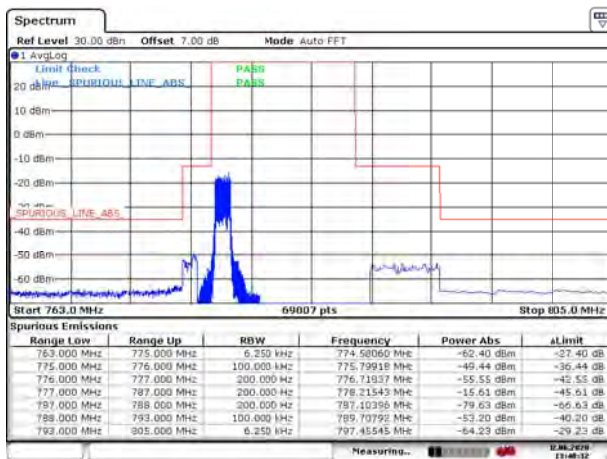

Date: 12 JUN 2020 13:40:31

LTE Band 13 QPSK 5MHz CH-High, 100%RB

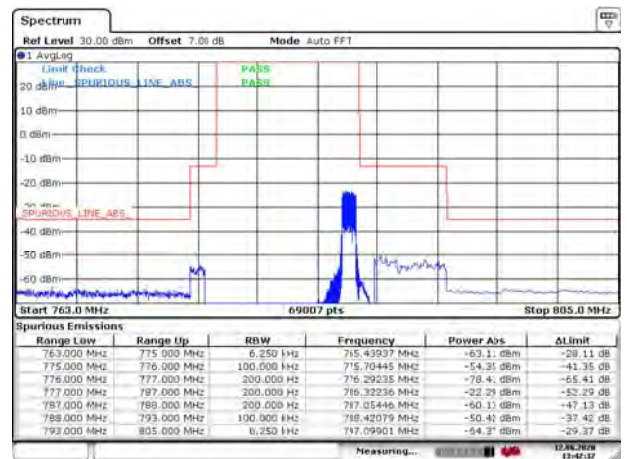

Date: 12 JUN 2020 13:42:37



LTE Band 13 QPSK 10MHz CH-Low, 1 RB

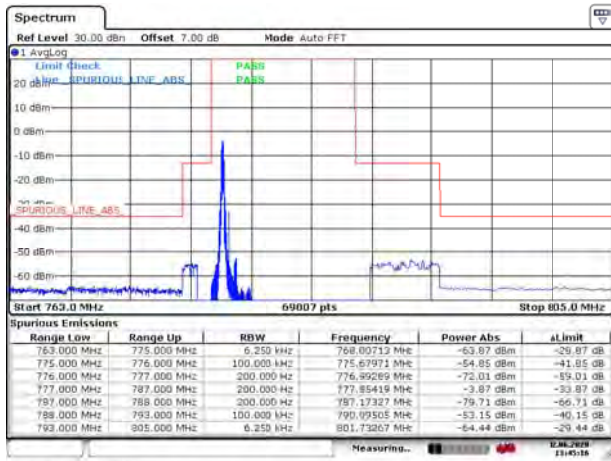

Date: 12 JUN 2020 13:45:16

LTE Band 13 QPSK 10MHz CH-High, 1 RB

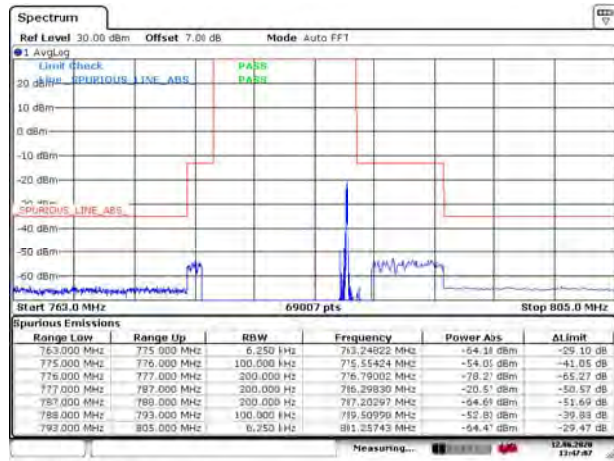

Date: 12 JUN 2020 13:47:07

LTE Band 13 QPSK 10MHz CH-Low, 100%RB

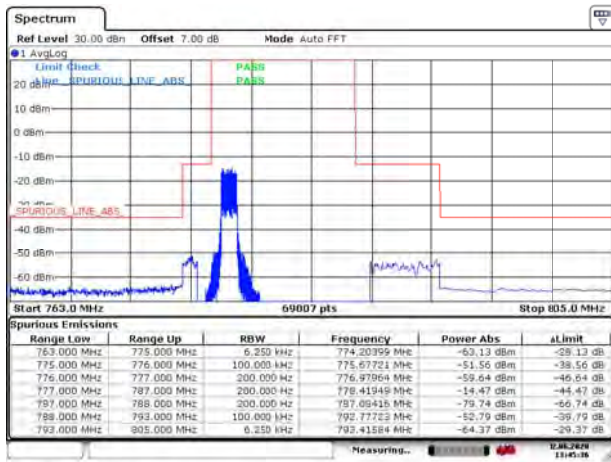

Date: 12 JUN 2020 13:45:36

LTE Band 13 QPSK 10MHz CH- High, 100%RB

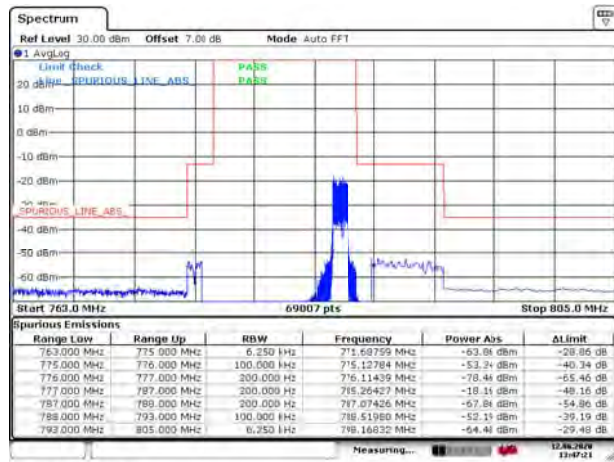

Date: 12 JUN 2020 13:47:20

LTE Band 13 16QAM 5MHz CH-Low, 1 RB

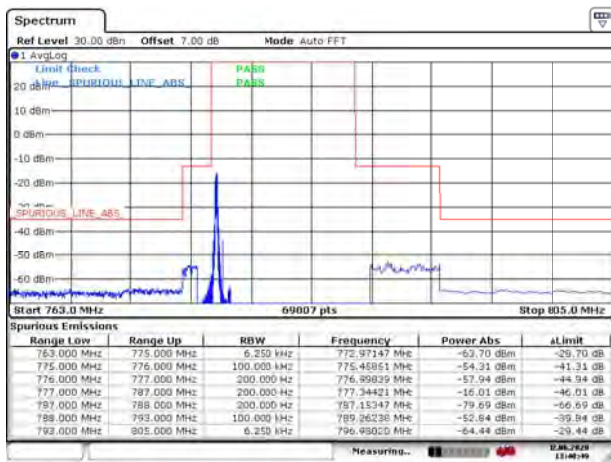

Date: 12 JUN 2020 13:40:48

LTE Band 13 16QAM 5MHz CH-High, 1 RB

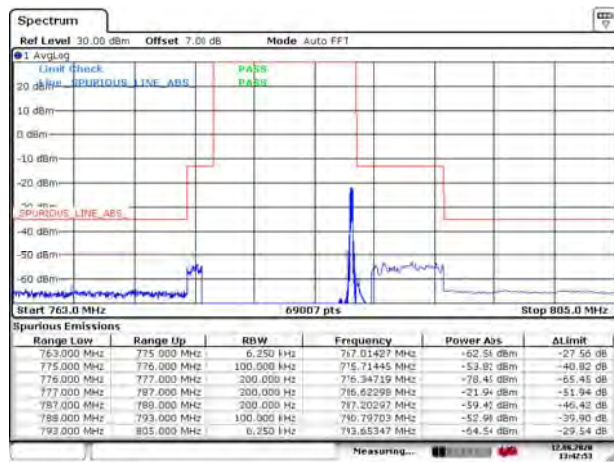

Date: 12 JUN 2020 13:42:53



LTE Band 13 16QAM 5MHz CH-Low, 100%RB

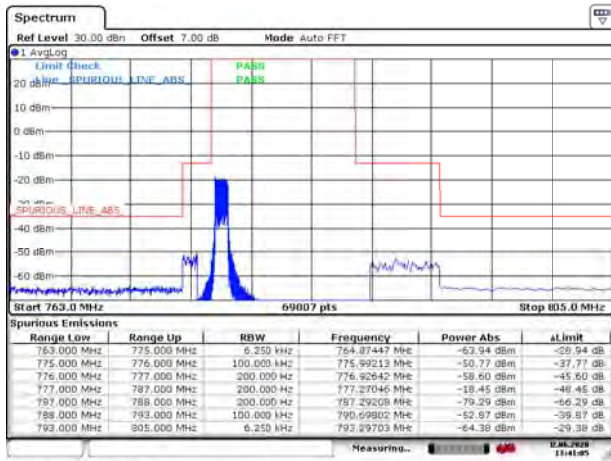

Date: 12 JUN 2020 13:41:04

LTE Band 13 16QAM 5MHz CH- High, 100%RB

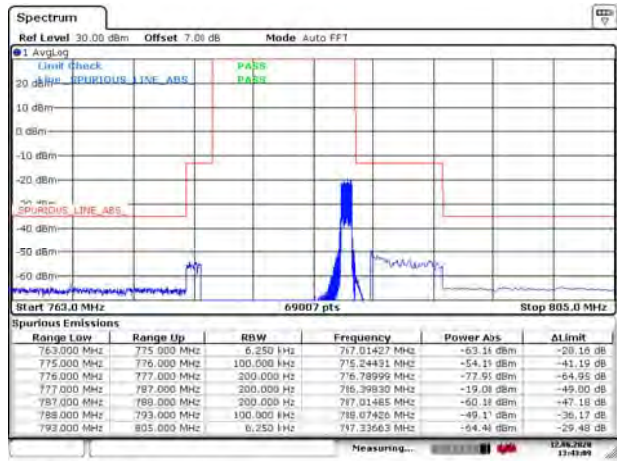

Date: 12 JUN 2020 13:43:09

LTE Band 13 16QAM 10MHz CH-Low, 1 RB

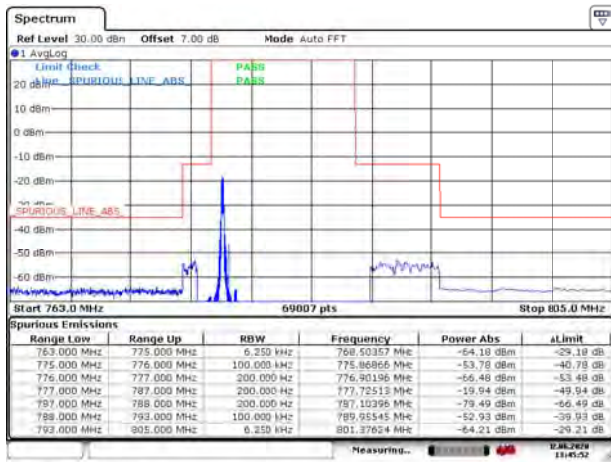

Date: 12 JUN 2020 13:45:52

LTE Band 13 16QAM 10MHz CH-High, 1 RB

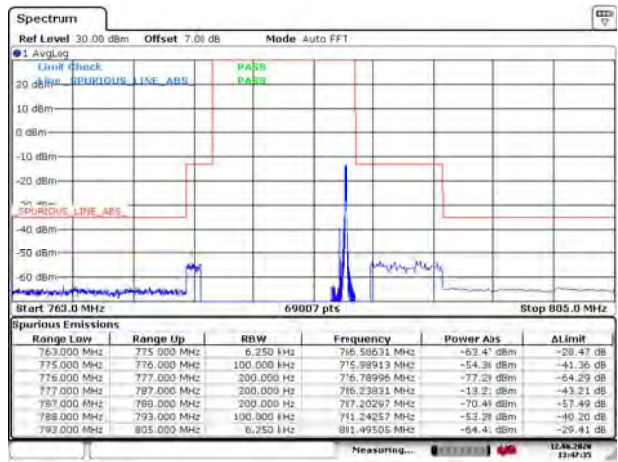

Date: 12 JUN 2020 13:47:35

LTE Band 13 16QAM 10MHz CH-Low, 100%RB

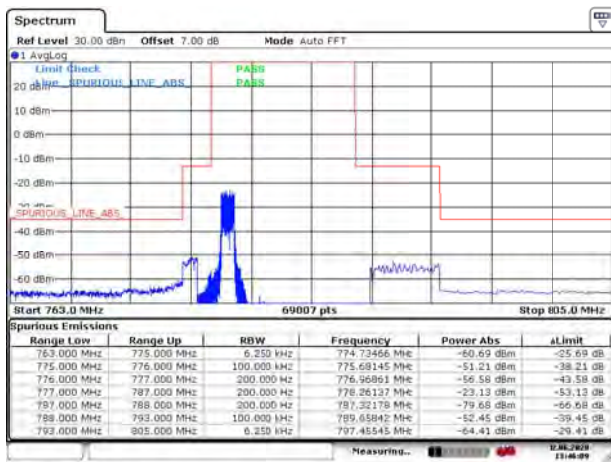

Date: 12 JUN 2020 13:46:09

LTE Band 13 16QAM 10MHz CH- High, 100%RB

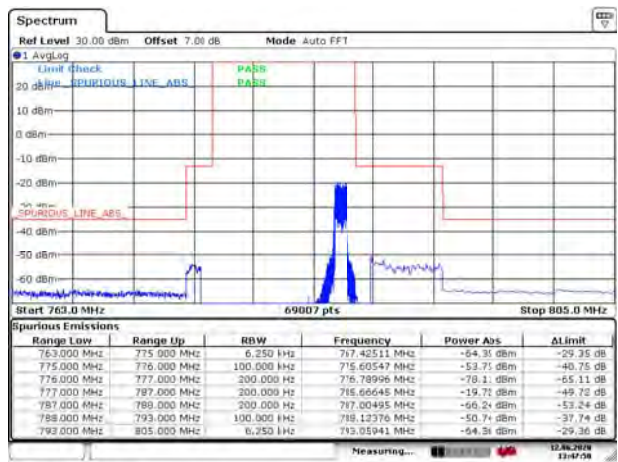

Date: 12 JUN 2020 13:47:50

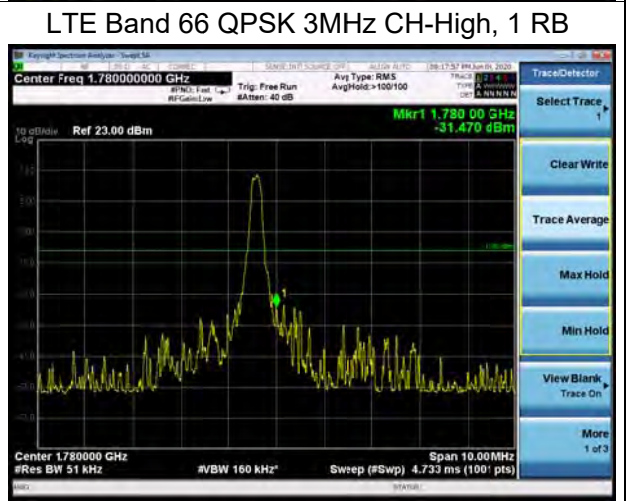
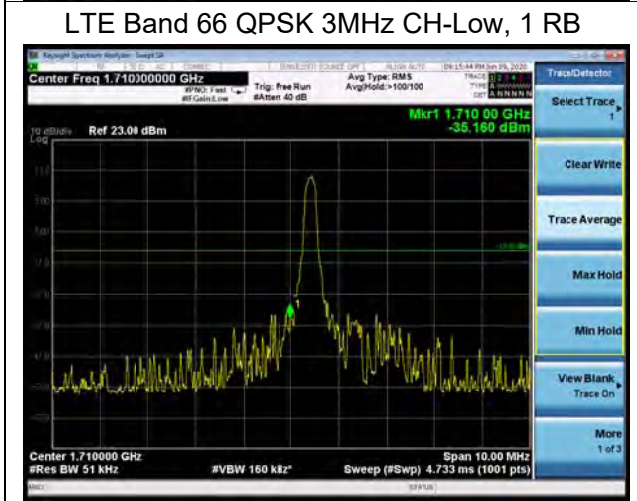
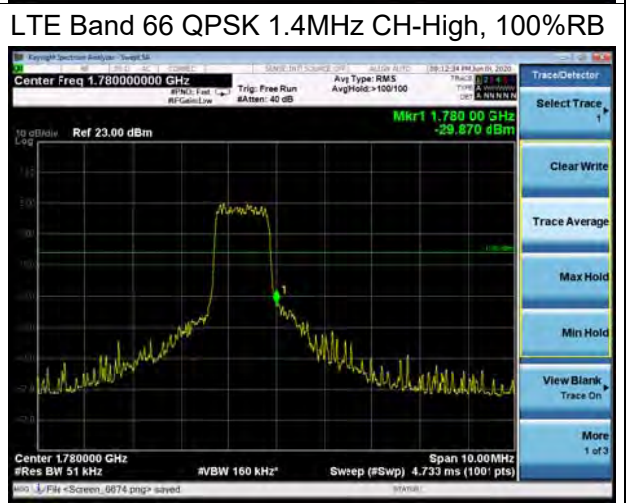
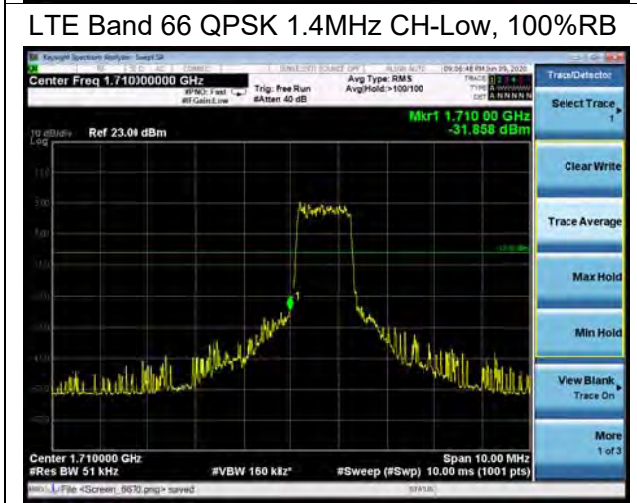
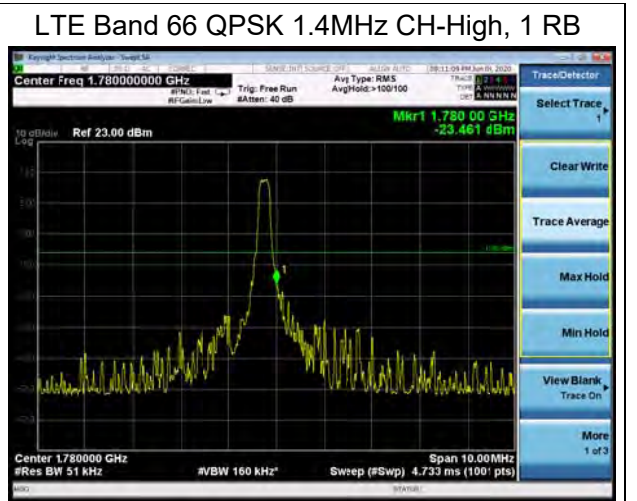
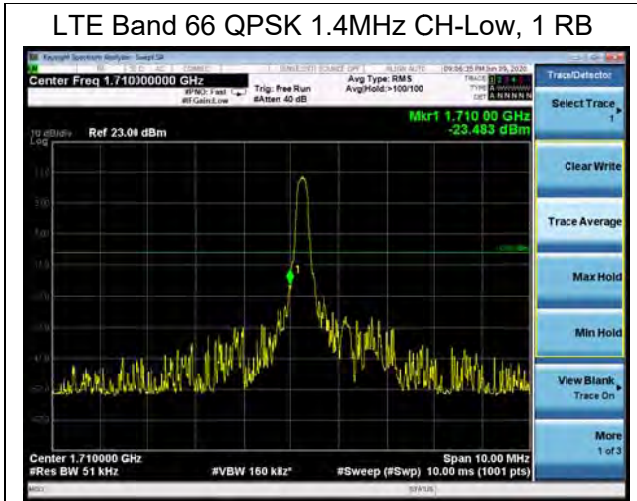



LTE Band 66 QPSK 3MHz CH-Low, 100%RB

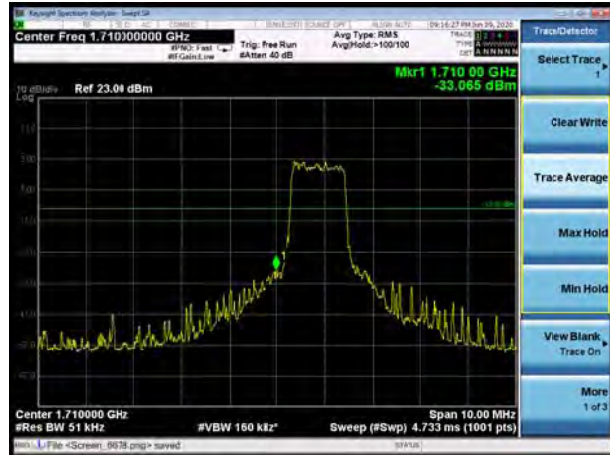

LTE Band 66 QPSK 3MHz CH-High, 100%RB

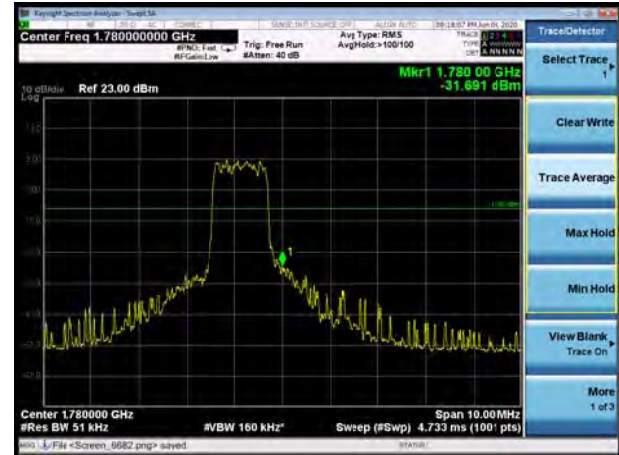

LTE Band 66 QPSK 5MHz CH-Low, 1 RB



LTE Band 66 QPSK 5MHz CH-High, 1 RB

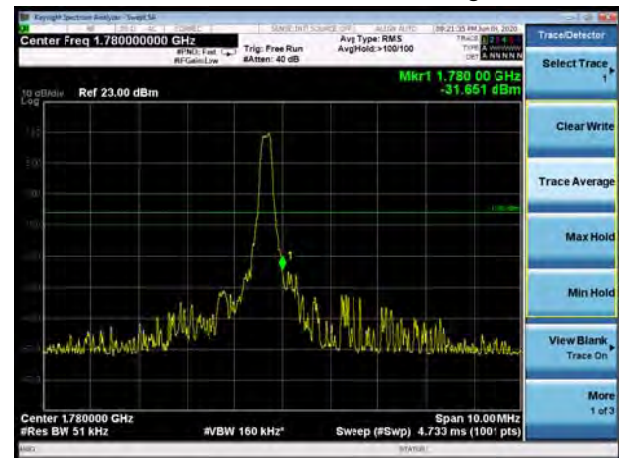

LTE Band 66 QPSK 5MHz CH-Low, 100%RB



LTE Band 66 QPSK 5MHz CH-High, 100%RB

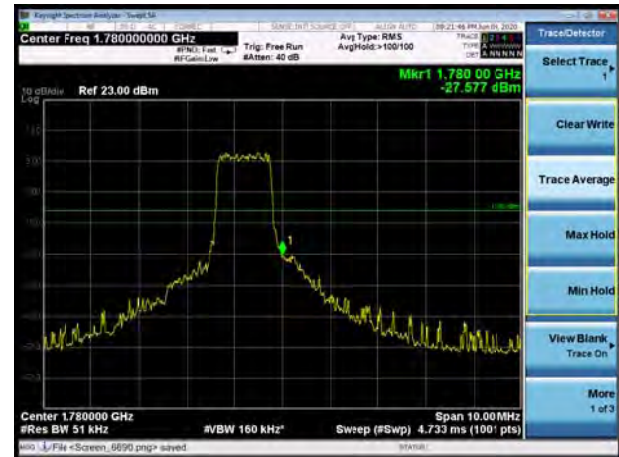



LTE Band 66 QPSK 10MHz CH-Low, 1 RB

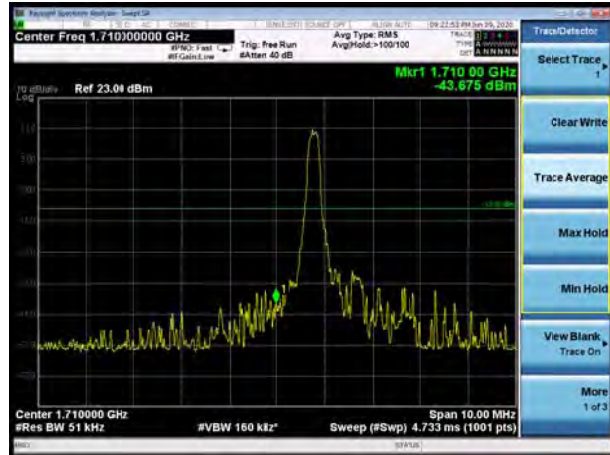

LTE Band 66 QPSK 10MHz CH-High, 1 RB

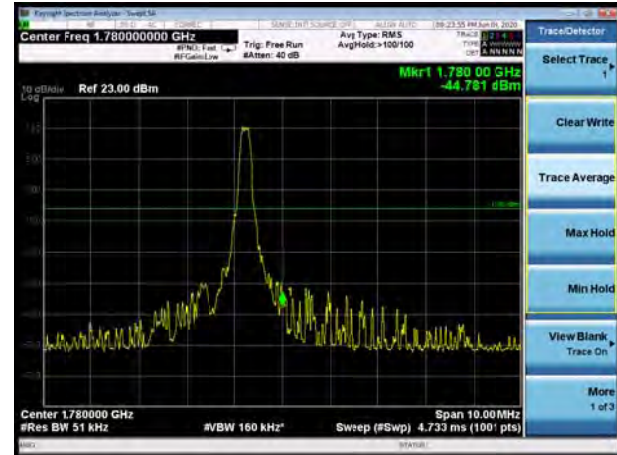

LTE Band 66 QPSK 10MHz CH-Low, 100%RB

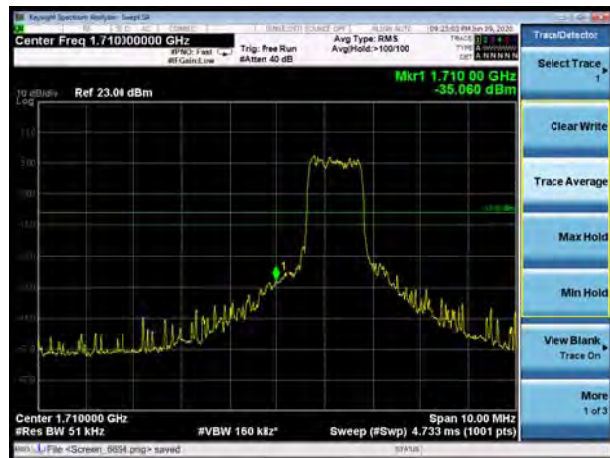

LTE Band 66 QPSK 10MHz CH-High, 100%RB

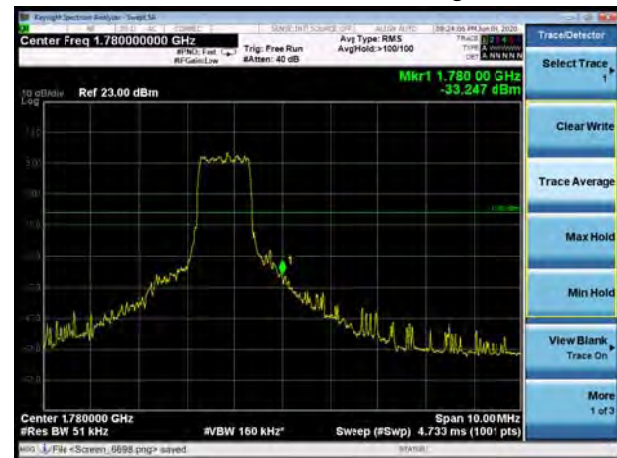

LTE Band 66 QPSK 15MHz CH-Low, 1 RB

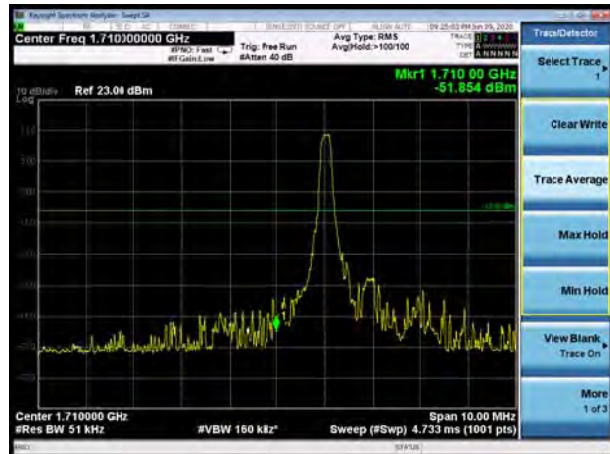

LTE Band 66 QPSK 15MHz CH-High, 1 RB

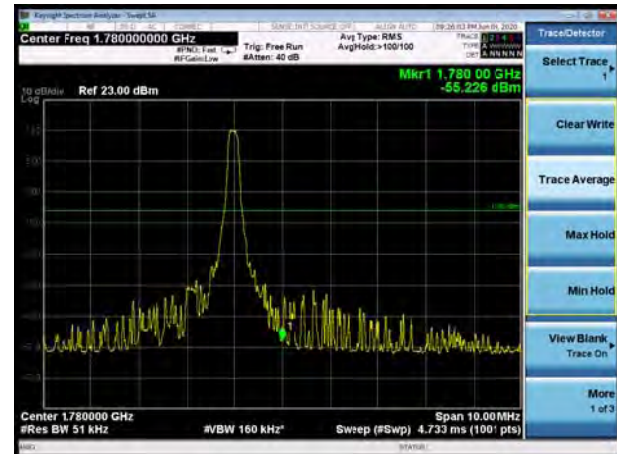



LTE Band 66 QPSK 15MHz CH-Low, 100%RB

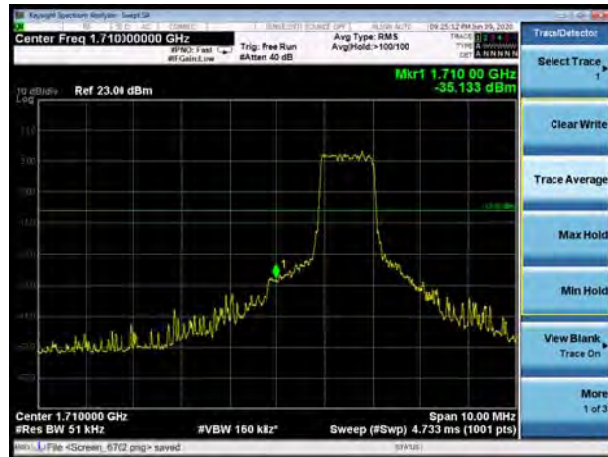

LTE Band 66 QPSK 15MHz CH-High, 100%RB

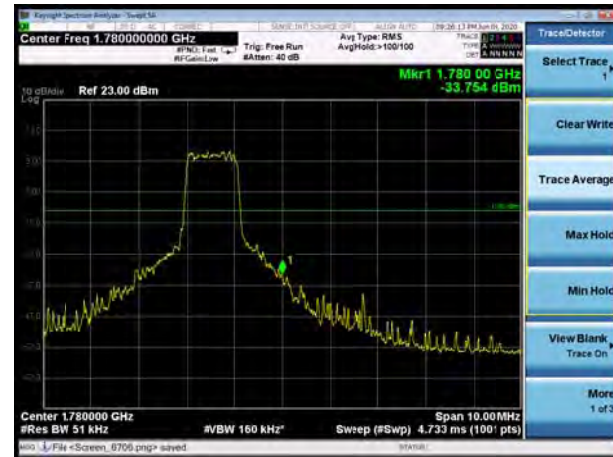

LTE Band 66 QPSK 20MHz CH-Low, 1 RB

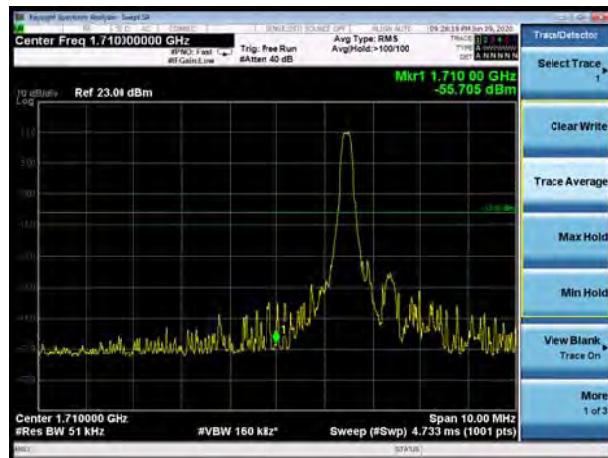

LTE Band 66 QPSK 20MHz CH-High, 1 RB

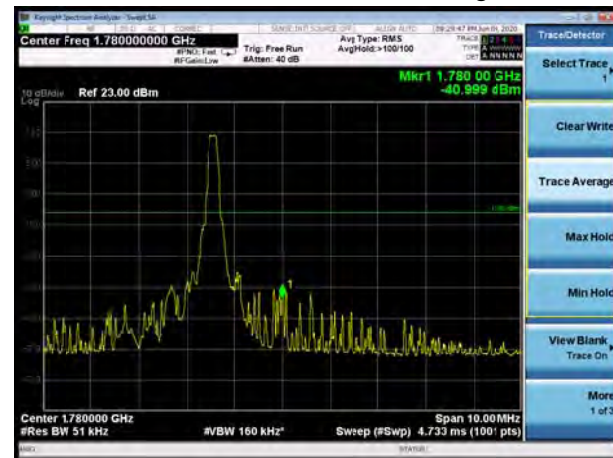

LTE Band 66 QPSK 20MHz CH-Low, 100%RB



LTE Band 66 QPSK 20MHz CH-High, 100%RB

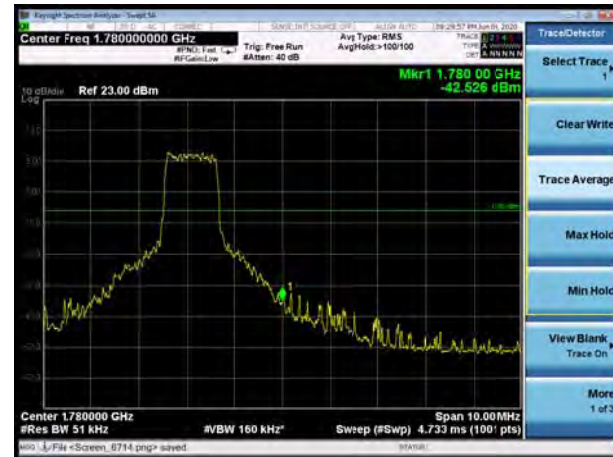

LTE Band 66 16QAM 1.4MHz CH-Low, 1 RB

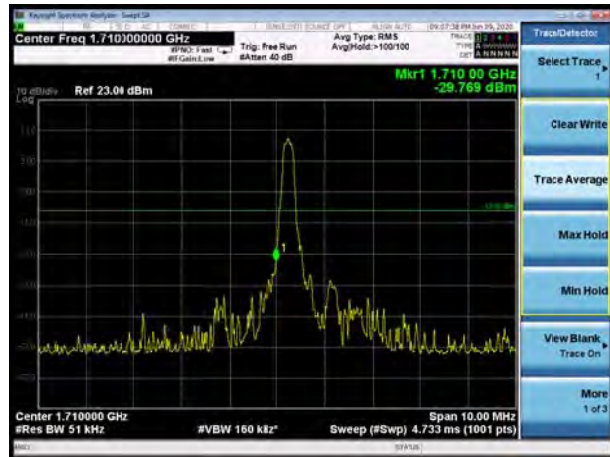

LTE Band 66 16QAM 1.4MHz CH-High, 1 RB



LTE Band 66 16QAM 1.4MHz CH-Low, 100%RB

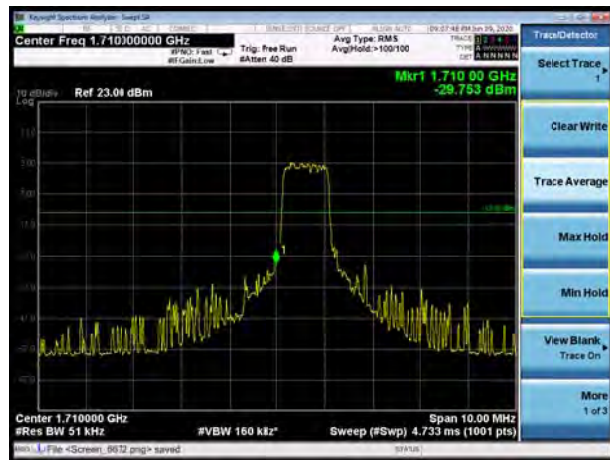

LTE Band 66 16QAM 1.4MHz CH-High, 100%RB

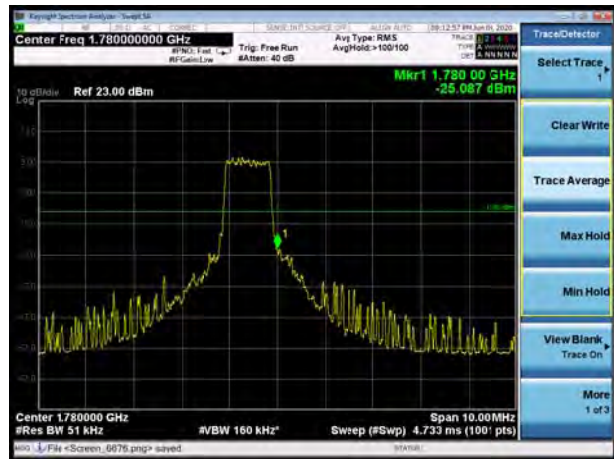

LTE Band 66 16QAM 3MHz CH-Low, 1 RB

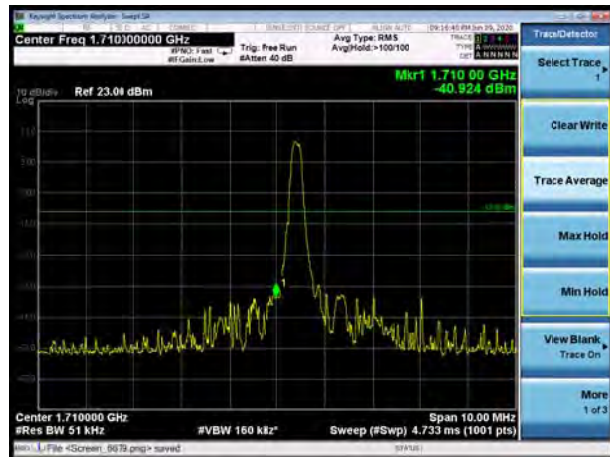

LTE Band 66 16QAM 3MHz CH-High, 1 RB





LTE Band 66 16QAM 3MHz CH-Low, 100%RB

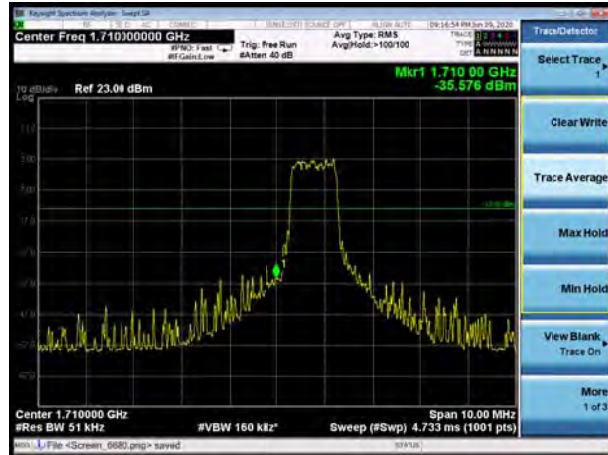

LTE Band 66 16QAM 3MHz CH-High, 100%RB

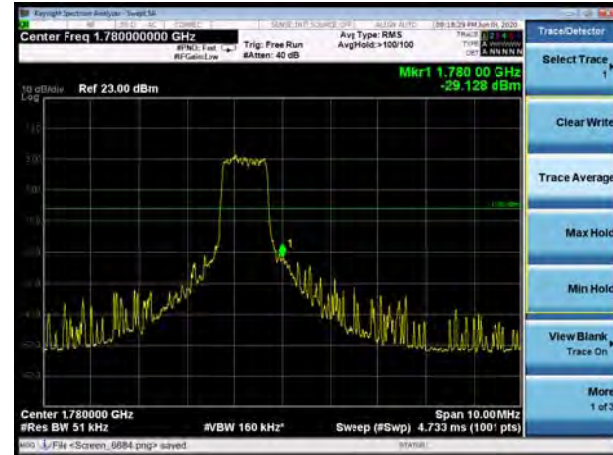

LTE Band 66 16QAM 5MHz CH-Low, 1 RB



LTE Band 66 16QAM 5MHz CH-High, 1 RB

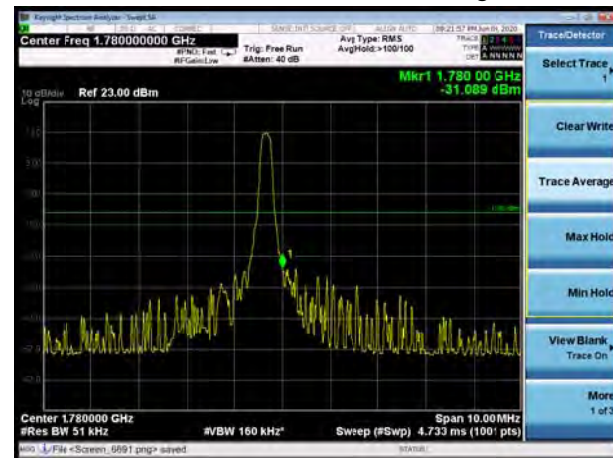

LTE Band 66 16QAM 5MHz CH-Low, 100%RB

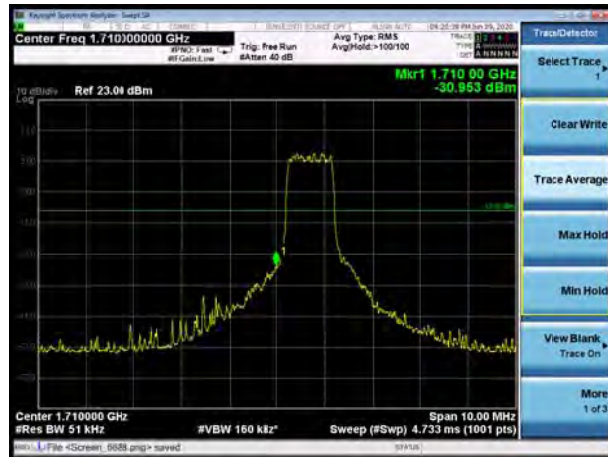

LTE Band 66 16QAM 5MHz CH-High, 100%RB

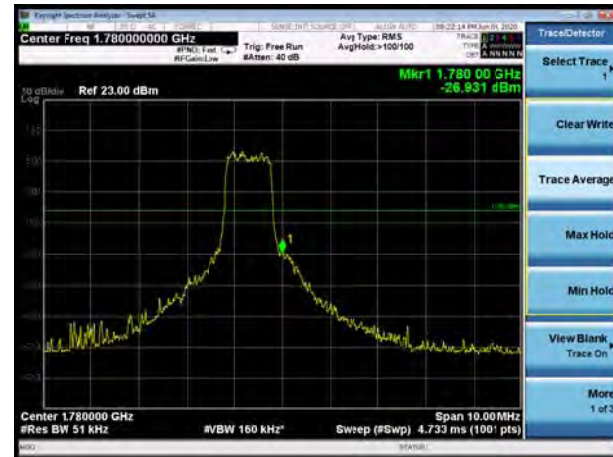



LTE Band 66 16QAM 10MHz CH-Low, 1 RB

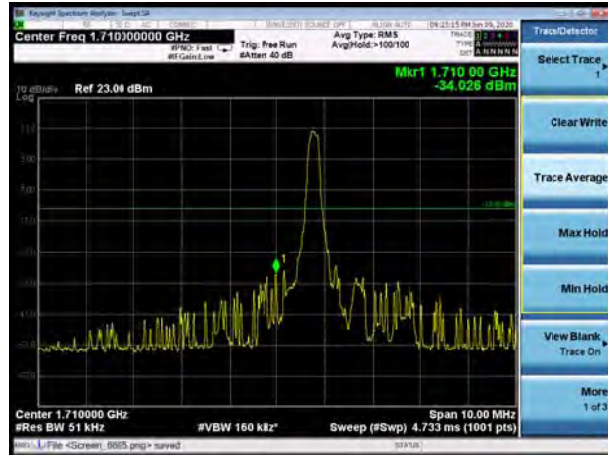

LTE Band 66 16QAM 10MHz CH-High, 1 RB

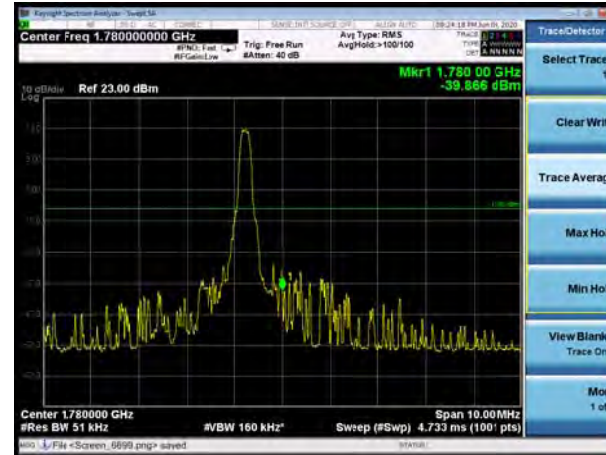

LTE Band 66 16QAM 10MHz CH-Low, 100%RB

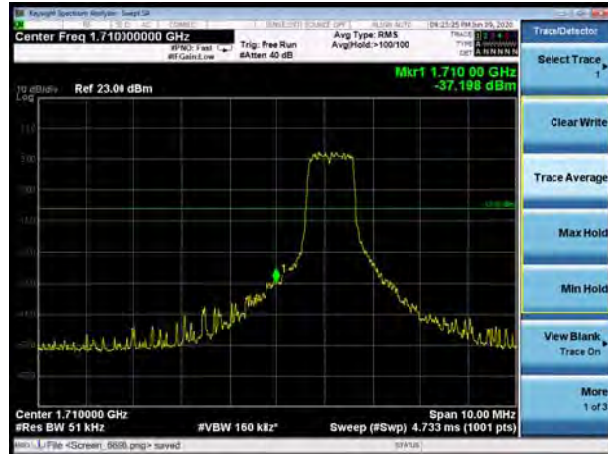

LTE Band 66 16QAM 10MHz CH-High, 100%RB

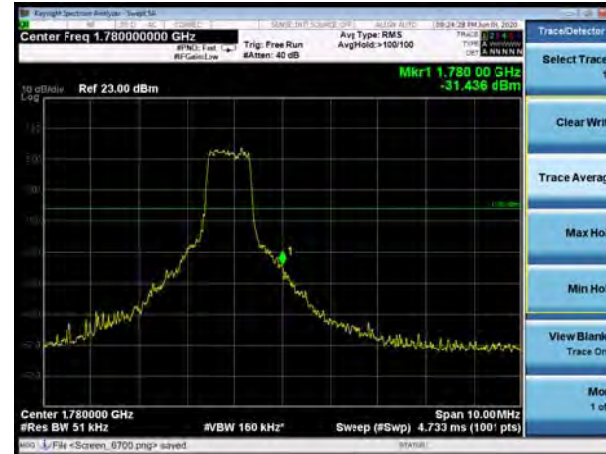

LTE Band 66 16QAM 15MHz CH-Low, 1 RB

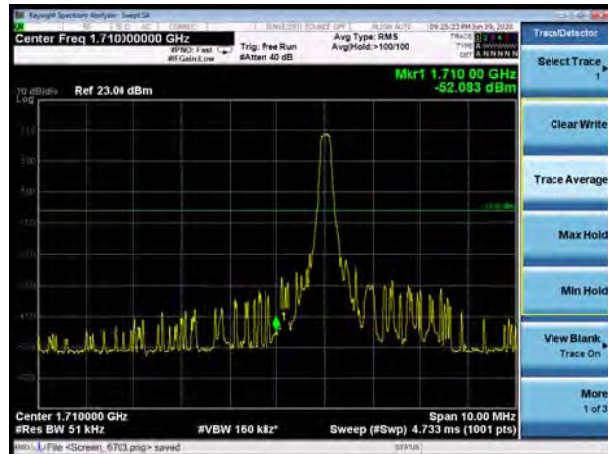

LTE Band 66 16QAM 15MHz CH-High, 1 RB

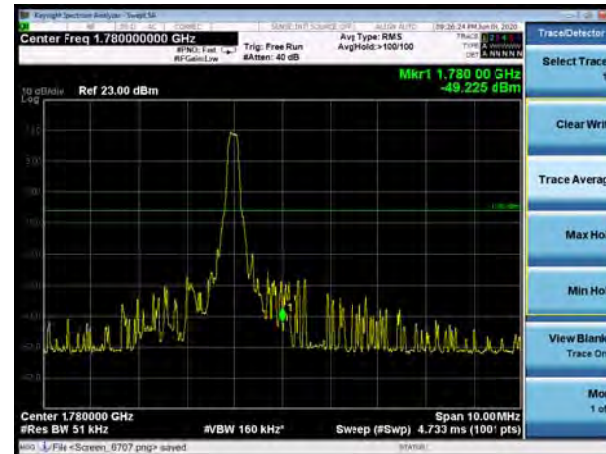



LTE Band 66 16QAM 15MHz CH-Low, 100%RB



LTE Band 66 16QAM 15MHz CH-High, 100%RB

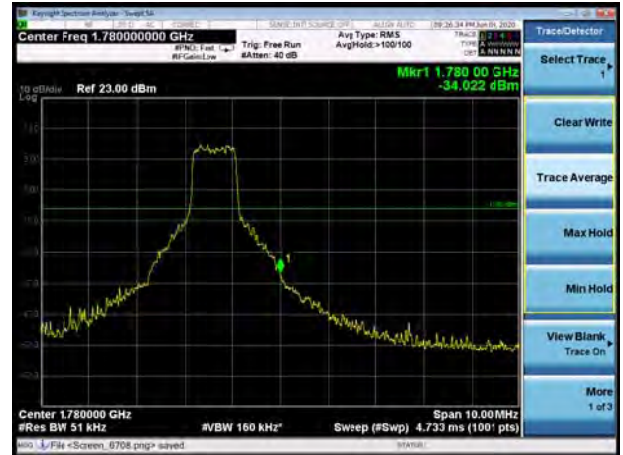

LTE Band 66 16QAM 20MHz CH-Low, 1 RB



LTE Band 66 16QAM 20MHz CH-High, 1 RB

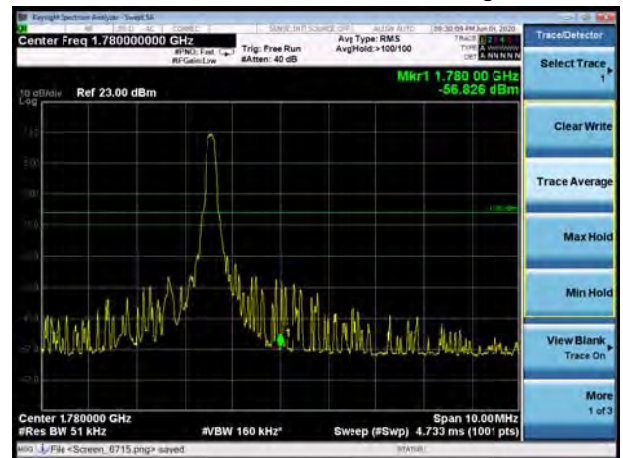

LTE Band 66 16QAM 20MHz CH-Low, 100%RB



LTE Band 66 16QAM 20MHz CH-High, 100%RB



LTE Band 85 QPSK 5MHz CH-Low, 1 RB

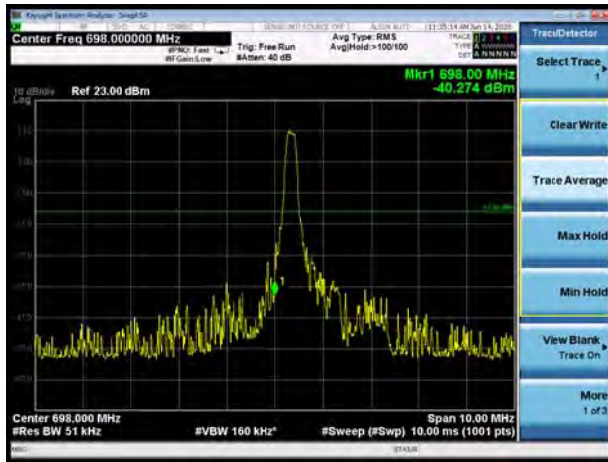

LTE Band 85 QPSK 5MHz CH-High, 1 RB

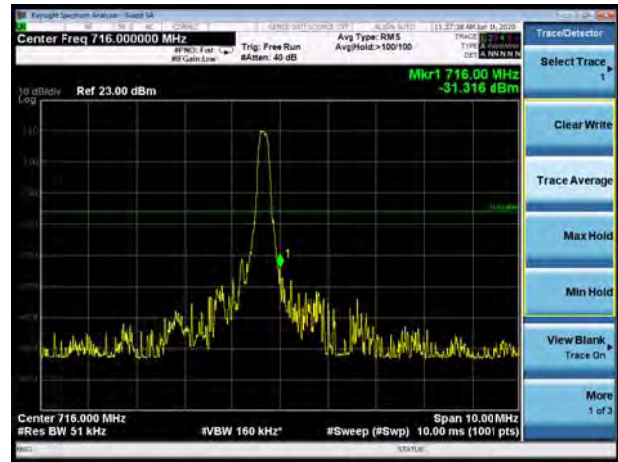

LTE Band 85 QPSK 5MHz CH-Low, 100%RB

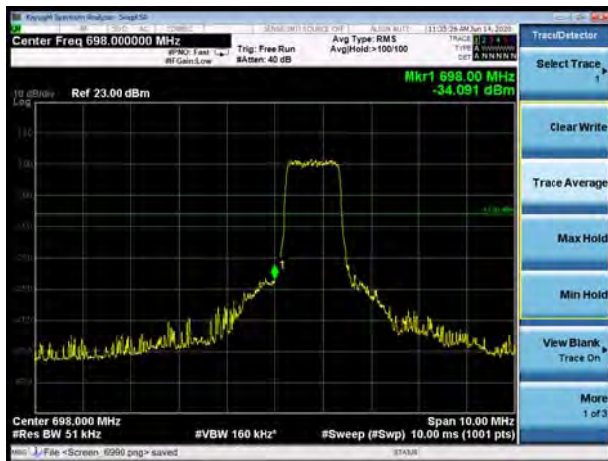

LTE Band 85 QPSK 5MHz CH-High, 100%RB

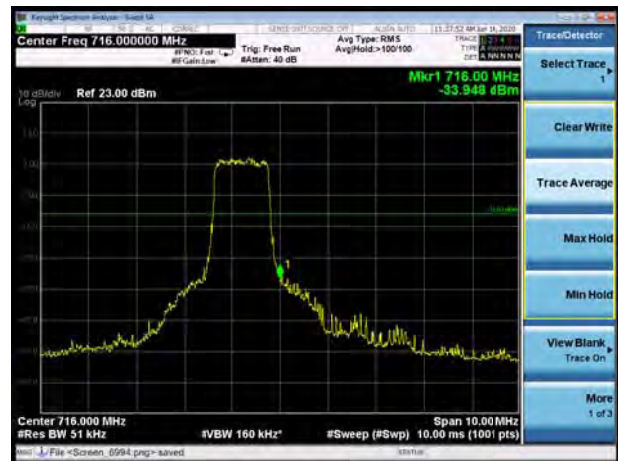

LTE Band 85 QPSK 10MHz CH-Low, 1 RB

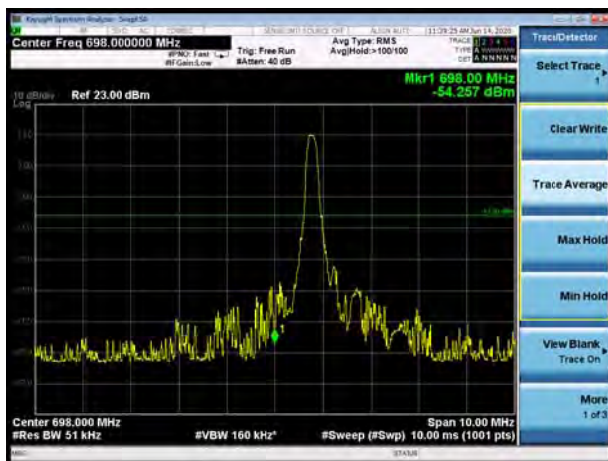

LTE Band 85 QPSK 10MHz CH-High, 1 RB

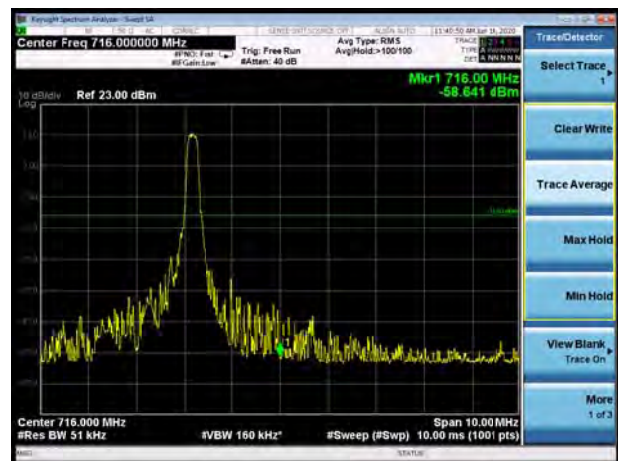



LTE Band 85 QPSK 10MHz CH-Low, 100%RB

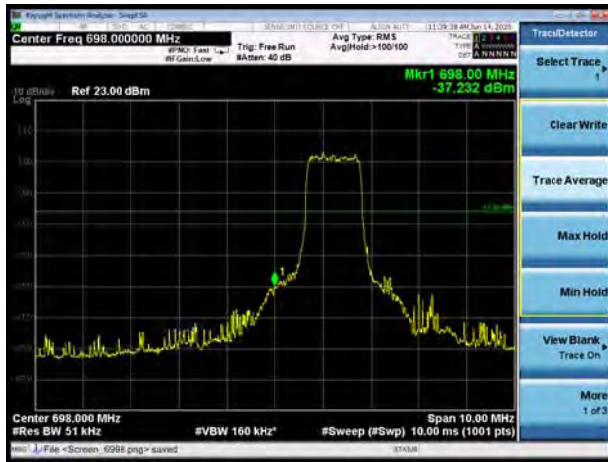

LTE Band 85 QPSK 10MHz CH-High, 100%RB



LTE Band 85 16QAM 5MHz CH-Low, 1 RB



LTE Band 85 16QAM 5MHz CH-High, 1 RB



LTE Band 85 16QAM 5MHz CH-Low, 100%RB

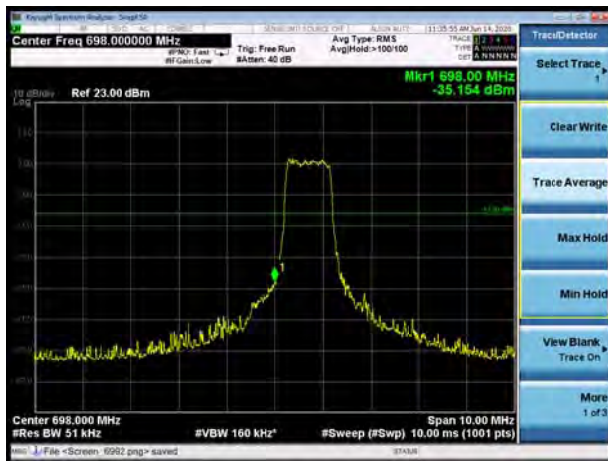

LTE Band 85 16QAM 5MHz CH-High, 100%RB

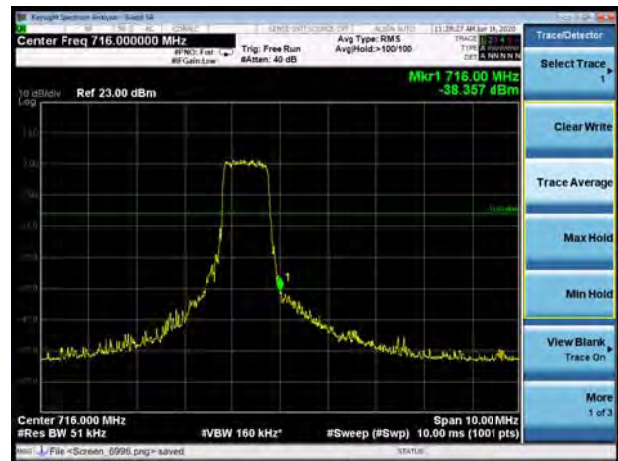



LTE Band 85 16QAM 10MHz CH-Low, 1 RB

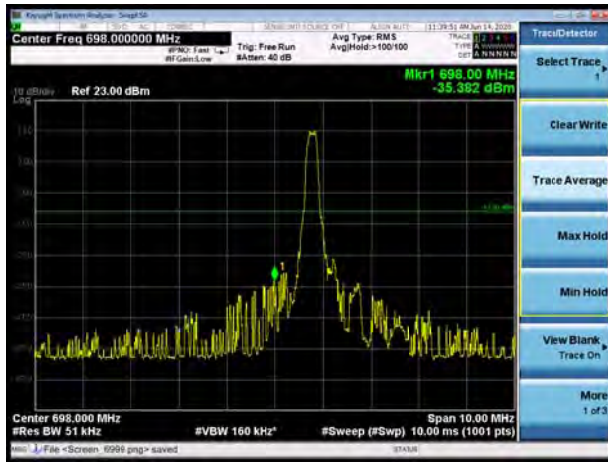

LTE Band 85 16QAM 10MHz CH-High, 1 RB

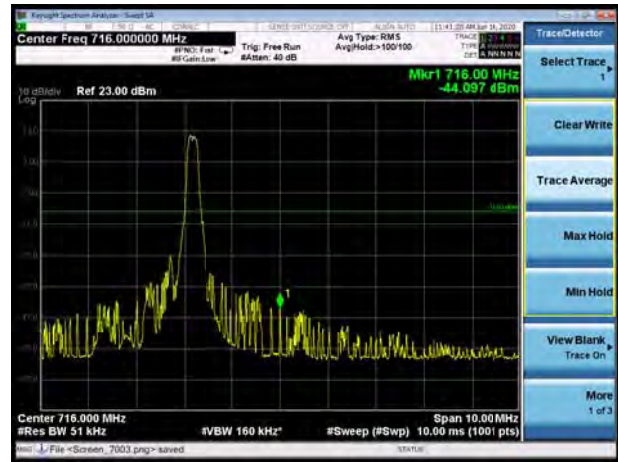

LTE Band 85 16QAM 10MHz CH-Low, 100%RB

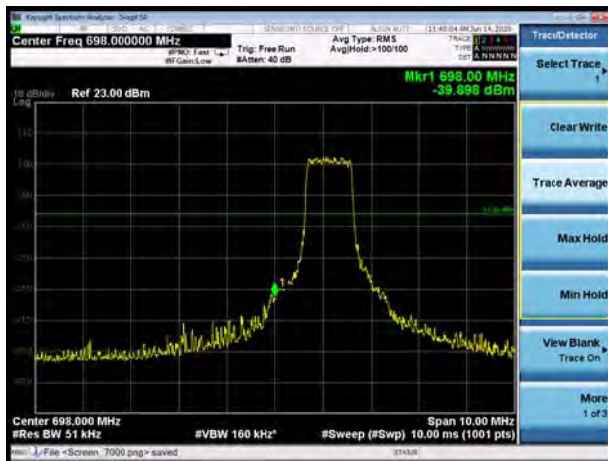

LTE Band 85 16QAM 10MHz CH-High, 100%RB

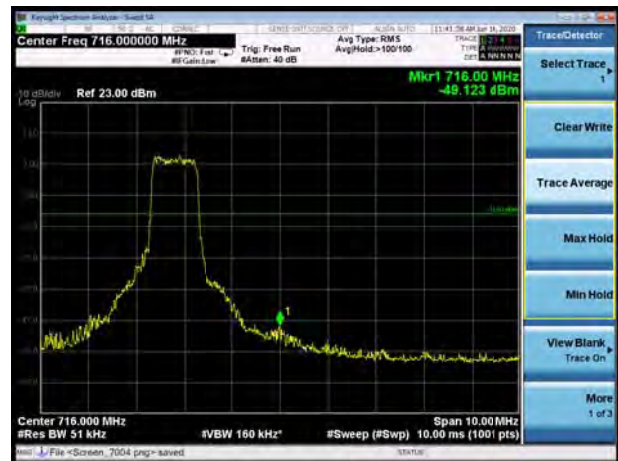

5.4 Peak-to-Average Power Ratio (PAPR)

Ambient condition

Temperature	Relative humidity	Pressure
23°C ~25°C	45%~50%	101.5kPa

Methods of Measurement

Measure the total peak power and record as PPk. And measure the total average power and record as PAvg. Both the peak and average power levels must be expressed in the same logarithmic units (e.g., dBm). Determine the PAPR from:

$$PAPR (dB) = PPk (dBm) - PAvg (dBm).$$

Test Setup

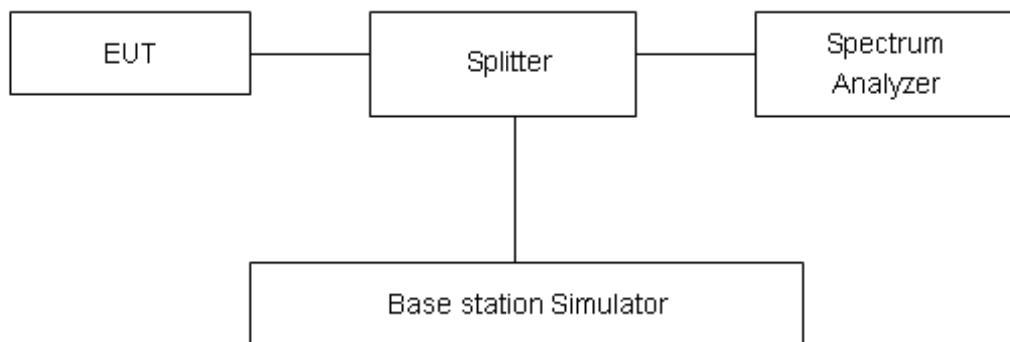

Limits

Rule Part 27.50(d)(5) Equipment employed must be authorized in accordance with the provisions of 24.51. Power measurements for transmissions by stations authorized under this section may be made either in accordance with a Commission-approved average power technique or in compliance with paragraph (d)(6) of this section. In measuring transmissions in this band using an average power technique, the peak-to-average ratio (PAR) of the transmission may not exceed 13 dB.

Measurement Uncertainty

The assessed measurement uncertainty to ensure 95% confidence level for the normal distribution is with the coverage factor k = 2, U= 0.4 dB.



Test Results

Mode	Bandwidth	Modulation	Channel/ Frequency(MHz)	Peak-to-Average Power Ratio (PAPR)			Limit (dB)	Conclusion
				Peak(dBm)	Avg(dBm)	PAPR(dB)		
LTE Band 4	1.4MHz	QPSK	20175/1732.5	26.02	16.10	9.92	13	PASS
		16QAM	20175/1732.5	26.61	16.11	10.50	13	PASS
	3MHz	QPSK	20175/1732.5	26.00	16.06	9.94	13	PASS
		16QAM	20175/1732.5	26.59	16.06	10.53	13	PASS
	5MHz	QPSK	20175/1732.5	26.77	17.10	9.67	13	PASS
		16QAM	20175/1732.5	26.73	16.37	10.36	13	PASS
	10MHz	QPSK	20175/1732.5	26.63	16.77	9.86	13	PASS
		16QAM	20175/1732.5	27.25	17.31	9.94	13	PASS
	15MHz	QPSK	20175/1732.5	27.34	17.98	9.36	13	PASS
		16QAM	20175/1732.5	27.63	18.54	9.09	13	PASS
	20MHz	QPSK	20175/1732.5	27.29	17.56	9.73	13	PASS
		16QAM	20175/1732.5	27.62	18.64	8.98	13	PASS

Mode	Bandwidth	Modulation	Channel/ Frequency(MHz)	Peak-to-Average Power Ratio (PAPR)			Limit (dB)	Conclusion
				Peak(dBm)	Avg(dBm)	PAPR(dB)		
LTE Band 12	1.4MHz	QPSK	23095/707.5	25.66	14.18	11.48	13	PASS
		16QAM	23095/707.5	26.76	14.66	12.10	13	PASS
	3MHz	QPSK	23095/707.5	25.60	15.68	9.92	13	PASS
		16QAM	23095/707.5	26.38	15.75	10.63	13	PASS
	5MHz	QPSK	23095/707.5	26.60	16.93	9.67	13	PASS
		16QAM	23095/707.5	26.53	16.08	10.45	13	PASS
	10MHz	QPSK	23095/707.5	26.55	16.84	9.71	13	PASS
		16QAM	23095/707.5	27.17	16.67	10.50	13	PASS

Mode	Bandwidth	Modulation	Channel/ Frequency(MHz)	Peak-to-Average Power Ratio (PAPR)			Limit (dB)	Conclusion
				Peak(dBm)	Avg(dBm)	PAPR(dB)		
LTE Band 13	5MHz	QPSK	23230/782	26.39	16.90	9.49	13	PASS
		16QAM	23230/782	26.42	16.14	10.28	13	PASS
	10MHz	QPSK	23230/782	26.22	16.94	9.28	13	PASS
		16QAM	23230/782	26.72	16.86	9.86	13	PASS



Mode	Bandwidth	Modulation	Channel/ Frequency(MHz)	Peak-to-Average Power Ratio (PAPR)			Limit (dB)	Conclusion
				Peak(dBm)	Avg(dBm)	PAPR(dB)		
LTE Band 66	1.4MHz	QPSK	132322/1745	26.08	16.05	10.03	13	PASS
		16QAM	132322/1745	26.69	15.95	10.74	13	PASS
	3MHz	QPSK	132322/1745	26.06	15.97	10.09	13	PASS
		16QAM	132322/1745	26.69	15.97	10.72	13	PASS
	5MHz	QPSK	132322/1745	26.89	17.17	9.72	13	PASS
		16QAM	132322/1745	26.59	15.89	10.70	13	PASS
	10MHz	QPSK	132322/1745	26.78	17.17	9.61	13	PASS
		16QAM	132322/1745	27.42	16.98	10.44	13	PASS
	15MHz	QPSK	132322/1745	27.41	18.65	8.76	13	PASS
		16QAM	132322/1745	27.70	17.65	10.05	13	PASS
	20MHz	QPSK	132322/1745	27.42	17.94	9.48	13	PASS
		16QAM	132322/1745	27.75	18.43	9.32	13	PASS

Mode	Bandwidth	Modulation	Channel/ Frequency(MHz)	Peak-to-Average Power Ratio (PAPR)			Limit (dB)	Conclusion
				Peak(dBm)	Avg(dBm)	PAPR(dB)		
LTE Band 85	5MHz	QPSK	134092/707	26.34	16.55	9.79	13	PASS
		16QAM	134092/707	25.98	15.75	10.23	13	PASS
	10MHz	QPSK	134092/707	26.38	16.13	10.25	13	PASS
		16QAM	134092/707	26.69	16.83	9.86	13	PASS

5.5 Frequency Stability

Ambient condition

Temperature	Relative humidity	Pressure
23°C ~25°C	45%~50%	101.5kPa

Method of Measurement

Frequency Stability (Temperature Variation)

The temperature inside the climate chamber is varied from -40°C to +85°C in 10°C step size.

(1) With all power removed, the temperature was decreased to -10°C and permitted to stabilize for three hours.

(2) Measure the carrier frequency with the test equipment in a “call mode”. These measurements should be made within 1 minute of powering up the mobile station, to prevent significant self warming.

(3) Repeat the above measurements at 10°C increments from -40°C to +85°C . Allow at least 1.5 hours at each temperature, un-powered, before making measurements.

Frequency Stability (Voltage Variation)

The frequency stability shall be measured with variation of primary supply voltage as follows:

(1) Vary primary supply voltage from 85 to 115 percent of the nominal value for other than hand carried battery equipment.

(2) For hand carried, battery powered equipment, reduce primary supply voltage to the battery-operating end point which shall be specified by the manufacturer.

This transceiver is specified to operate with an input voltage of between 3.3 V and 4.3 V, with a nominal voltage of 3.8V.

.Test setup

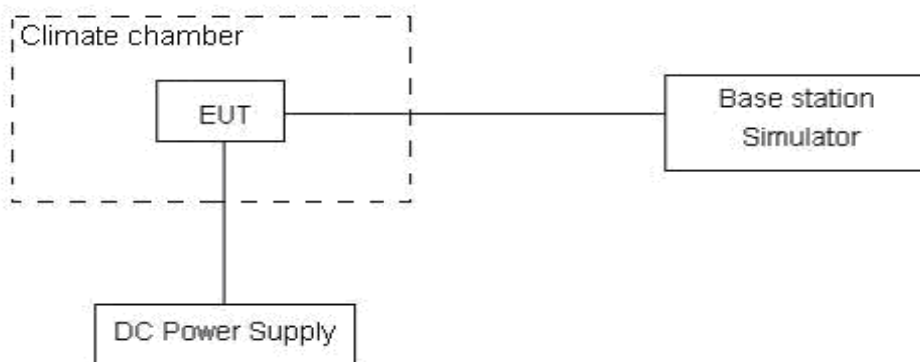

Limits

The frequency stability shall be sufficient to ensure that the fundamental emissions stay within the authorized bands of operation.

Measurement Uncertainty

The assessed measurement uncertainty to ensure 99.75% confidence level for the normal distribution is with the coverage factor $k = 3, U=0.01\text{ppm}$.



Test Result

LTE Band 4						
Condition		Freq.Error (Hz)	Freq.Error (Hz)	Frequency Stability (ppm)	Frequency Stability (ppm)	Verdict
BANDWIDTH	1.4MHz					
Temperature	Voltage	16QAM	QPSK	16QAM	QPSK	
Normal (25°C)	Normal	7.66	17.77	0.00407	0.00945	PASS
Extreme (85°C)		13.32	5.44	0.00709	0.00289	PASS
Extreme (80°C)		6.86	17.96	0.00365	0.00955	PASS
Extreme (70°C)		17.02	1.64	0.00906	0.00087	PASS
Extreme (60°C)		3.78	16.61	0.00201	0.00883	PASS
Extreme (50°C)		4.02	17.61	0.00214	0.00937	PASS
Extreme (40°C)		17.69	10.36	0.00941	0.00551	PASS
Extreme (30°C)		11.53	7.57	0.00613	0.00403	PASS
Extreme (20°C)		12.99	9.39	0.00691	0.00499	PASS
Extreme (10°C)		2.57	9.73	0.00137	0.00518	PASS
Extreme (0°C)		2.20	6.41	0.00117	0.00341	PASS
Extreme (-10°C)		5.77	13.11	0.00307	0.00697	PASS
Extreme (-20°C)		9.35	17.35	0.00498	0.00923	PASS
Extreme (-30°C)		9.81	6.34	0.00522	0.00337	PASS
Extreme (-40°C)		14.88	12.81	0.00791	0.00681	PASS
25°C	LV	4.47	14.75	0.00238	0.00785	PASS
	HV	5.59	1.29	0.00297	0.00068	PASS
Condition		Freq.Error (Hz)	Freq.Error (Hz)	Frequency Stability (ppm)	Frequency Stability (ppm)	Verdict
BANDWIDTH	3MHz					
Temperature	Voltage	16QAM	QPSK	16QAM	QPSK	
Normal (25°C)	Normal	10.11	1.41	0.00538	0.00075	PASS
Extreme (85°C)		2.05	17.79	0.00109	0.00946	PASS
Extreme (80°C)		15.14	10.74	0.00805	0.00571	PASS
Extreme (70°C)		11.61	15.69	0.00618	0.00835	PASS
Extreme (60°C)		15.82	14.29	0.00842	0.00760	PASS
Extreme (50°C)		2.01	17.80	0.00107	0.00947	PASS
Extreme (40°C)		10.10	15.85	0.00537	0.00843	PASS
Extreme (30°C)		8.58	17.86	0.00456	0.00950	PASS
Extreme (20°C)		3.61	9.46	0.00192	0.00503	PASS
Extreme (10°C)		2.08	14.15	0.00111	0.00753	PASS
Extreme (0°C)		13.99	16.77	0.00744	0.00892	PASS
Extreme (-10°C)		6.98	8.29	0.00371	0.00441	PASS
Extreme (-20°C)		14.10	15.36	0.00750	0.00817	PASS
Extreme (-30°C)		10.67	9.09	0.00567	0.00483	PASS



Extreme (-40°C)		7.30	16.72	0.00388	0.00889	PASS
25°C	LV	4.34	5.60	0.00231	0.00298	PASS
	HV	16.04	2.66	0.00853	0.00142	PASS
Condition		Freq.Error (Hz)	Freq.Error (Hz)	Frequency Stability (ppm)	Frequency Stability (ppm)	Verdict
BANDWIDTH	5MHz					
Temperature	Voltage	16QAM	QPSK	16QAM	QPSK	
Normal (25°C)	Normal	11.98	14.25	0.00637	0.00758	
Extreme (85°C)		1.84	12.36	0.00098	0.00658	PASS
Extreme (80°C)		7.92	12.01	0.00421	0.00639	PASS
Extreme (70°C)		11.61	4.18	0.00618	0.00223	PASS
Extreme (60°C)		5.27	5.06	0.00280	0.00269	PASS
Extreme (50°C)		13.80	7.94	0.00734	0.00423	PASS
Extreme (40°C)		13.82	7.68	0.00735	0.00409	PASS
Extreme (30°C)		13.65	3.34	0.00726	0.00177	PASS
Extreme (20°C)		12.50	17.46	0.00665	0.00929	PASS
Extreme (10°C)		15.32	5.42	0.00815	0.00288	PASS
Extreme (0°C)		15.68	8.27	0.00834	0.00440	PASS
Extreme (-10°C)		16.15	9.05	0.00859	0.00481	PASS
Extreme (-20°C)		8.68	15.42	0.00462	0.00820	PASS
Extreme (-30°C)		6.54	8.50	0.00348	0.00452	PASS
Extreme (-40°C)		13.39	1.67	0.00712	0.00089	PASS
25°C		LV	14.25	12.41	0.00758	0.00660
	HV	5.93	5.91	0.00315	0.00314	PASS
Condition		Freq.Error (Hz)	Freq.Error (Hz)	Frequency Stability (ppm)	Frequency Stability (ppm)	Verdict
BANDWIDTH	10MHz					
Temperature	Voltage	16QAM	QPSK	16QAM	QPSK	
Normal (25°C)	Normal	11.62	9.58	0.00618	0.00510	
Extreme (85°C)		7.64	15.96	0.00407	0.00849	PASS
Extreme (80°C)		9.03	2.28	0.00481	0.00121	PASS
Extreme (70°C)		8.76	16.43	0.00466	0.00874	PASS
Extreme (60°C)		2.38	16.58	0.00126	0.00882	PASS
Extreme (50°C)		8.34	7.08	0.00444	0.00377	PASS
Extreme (40°C)		15.08	11.63	0.00802	0.00618	PASS
Extreme (30°C)		11.15	17.65	0.00593	0.00939	PASS
Extreme (20°C)		12.30	8.17	0.00654	0.00435	PASS
Extreme (10°C)		1.59	12.17	0.00084	0.00648	PASS
Extreme (0°C)		6.01	3.19	0.00320	0.00170	PASS
Extreme (-10°C)		9.47	8.47	0.00503	0.00451	PASS
Extreme (-20°C)		7.14	2.95	0.00380	0.00157	PASS



Extreme (-30°C)		5.16	4.47	0.00274	0.00238	PASS
Extreme (-40°C)		5.50	5.64	0.00292	0.00300	PASS
25°C	LV	15.99	9.36	0.00851	0.00498	PASS
	HV	17.26	10.65	0.00918	0.00566	PASS
Condition		Freq.Error (Hz)	Freq.Error (Hz)	Frequency Stability (ppm)	Frequency Stability (ppm)	Verdict
BANDWIDTH	15MHz					
Temperature	Voltage	16QAM	QPSK	16QAM	QPSK	
Normal (25°C)	Normal	10.60	11.66	0.00564	0.00620	PASS
Extreme (85°C)		12.76	15.70	0.00679	0.00835	PASS
Extreme (80°C)		8.29	4.52	0.00441	0.00240	PASS
Extreme (70°C)		2.61	6.09	0.00139	0.00324	PASS
Extreme (60°C)		2.69	17.28	0.00143	0.00919	PASS
Extreme (50°C)		16.17	5.53	0.00860	0.00294	PASS
Extreme (40°C)		8.15	14.57	0.00434	0.00775	PASS
Extreme (30°C)		10.69	2.27	0.00569	0.00121	PASS
Extreme (20°C)		4.29	11.21	0.00228	0.00596	PASS
Extreme (10°C)		10.87	16.26	0.00578	0.00865	PASS
Extreme (0°C)		13.18	7.55	0.00701	0.00401	PASS
Extreme (-10°C)		5.23	7.05	0.00278	0.00375	PASS
Extreme (-20°C)		15.65	12.16	0.00833	0.00647	PASS
Extreme (-30°C)		5.78	14.40	0.00307	0.00766	PASS
Extreme (-40°C)		7.47	6.97	0.00397	0.00371	PASS
25°C		LV	14.46	5.56	0.00769	0.00296
	HV	13.99	2.75	0.00744	0.00146	PASS
Condition		Freq.Error (Hz)	Freq.Error (Hz)	Frequency Stability (ppm)	Frequency Stability (ppm)	Verdict
BANDWIDTH	20MHz					
Temperature	Voltage	16QAM	QPSK	16QAM	QPSK	
Normal (25°C)	Normal	1.49	7.61	0.00079	0.00405	PASS
Extreme (85°C)		15.62	5.32	0.00831	0.00283	PASS
Extreme (80°C)		15.30	15.02	0.00814	0.00799	PASS
Extreme (70°C)		7.02	12.24	0.00373	0.00651	PASS
Extreme (60°C)		7.17	8.61	0.00381	0.00458	PASS
Extreme (50°C)		15.48	17.73	0.00823	0.00943	PASS
Extreme (40°C)		10.69	9.45	0.00569	0.00503	PASS
Extreme (30°C)		13.13	6.75	0.00699	0.00359	PASS
Extreme (20°C)		8.53	5.49	0.00454	0.00292	PASS
Extreme (10°C)		15.96	14.88	0.00849	0.00791	PASS
Extreme (0°C)		8.67	4.32	0.00461	0.00230	PASS
Extreme (-10°C)		13.84	10.29	0.00736	0.00547	PASS



Extreme (-20°C)		15.40	4.85	0.00819	0.00258	PASS
Extreme (-30°C)		8.55	5.10	0.00455	0.00271	PASS
Extreme (-40°C)		1.16	12.53	0.00061	0.00667	PASS
25°C	LV	2.59	1.42	0.00138	0.00076	PASS
	HV	11.56	10.37	0.00615	0.00552	PASS

LTE Band 12						
Condition		Freq.Error (Hz)	Freq.Error (Hz)	Frequency Stability (ppm)	Frequency Stability (ppm)	Verdict
BANDWIDTH	1.4MHz					
Temperature	Voltage	16QAM	QPSK	16QAM	QPSK	
Normal (25°C)	Normal	3.07	9.20	0.00163	0.00489	PASS
Extreme (85°C)		13.50	9.10	0.00718	0.00484	PASS
Extreme (80°C)		17.95	14.37	0.00955	0.00764	PASS
Extreme (70°C)		12.76	5.06	0.00679	0.00269	PASS
Extreme (60°C)		8.66	17.19	0.00461	0.00915	PASS
Extreme (50°C)		14.99	2.05	0.00797	0.00109	PASS
Extreme (40°C)		2.37	7.16	0.00126	0.00381	PASS
Extreme (30°C)		1.99	12.07	0.00106	0.00642	PASS
Extreme (20°C)		14.36	12.15	0.00764	0.00646	PASS
Extreme (10°C)		5.24	4.34	0.00278	0.00231	PASS
Extreme (0°C)		10.95	6.63	0.00582	0.00353	PASS
Extreme (-10°C)		16.53	16.49	0.00879	0.00877	PASS
Extreme (-20°C)		10.67	14.10	0.00568	0.00750	PASS
Extreme (-30°C)		10.28	16.66	0.00547	0.00886	PASS
Extreme (-40°C)		6.32	13.89	0.00336	0.00739	PASS
25°C	LV	14.83	3.33	0.00789	0.00177	PASS
	HV	17.62	12.30	0.00937	0.00654	PASS
Condition		Freq.Error (Hz)	Freq.Error (Hz)	Frequency Stability (ppm)	Frequency Stability (ppm)	Verdict
BANDWIDTH	3MHz					
Temperature	Voltage	16QAM	QPSK	16QAM	QPSK	
Normal (25°C)	Normal	15.73	1.10	0.00836	0.00058	PASS
Extreme (85°C)		11.51	7.90	0.00612	0.00420	PASS
Extreme (80°C)		9.91	14.83	0.00527	0.00789	PASS
Extreme (70°C)		10.24	9.45	0.00545	0.00503	PASS
Extreme (60°C)		2.20	11.61	0.00117	0.00617	PASS
Extreme (50°C)		15.54	7.08	0.00826	0.00377	PASS
Extreme (40°C)		3.22	1.32	0.00171	0.00070	PASS
Extreme (30°C)		10.24	15.17	0.00545	0.00807	PASS
Extreme (20°C)		10.05	12.34	0.00535	0.00656	PASS



Extreme (10°C)		1.15	7.58	0.00061	0.00403	PASS
Extreme (0°C)		17.04	6.14	0.00906	0.00327	PASS
Extreme (-10°C)		3.55	13.34	0.00189	0.00709	PASS
Extreme (-20°C)		5.04	1.08	0.00268	0.00057	PASS
Extreme (-30°C)		4.84	1.31	0.00257	0.00070	PASS
Extreme (-40°C)		7.81	14.35	0.00415	0.00763	PASS
25°C	LV	15.04	10.69	0.00800	0.00569	PASS
	HV	5.13	12.17	0.00273	0.00647	PASS
Condition		Freq.Error (Hz)	Freq.Error (Hz)	Frequency Stability (ppm)	Frequency Stability (ppm)	Verdict
BANDWIDTH	5MHz					
Temperature	Voltage	16QAM	QPSK	16QAM	QPSK	
Normal (25°C)	Normal	2.34	13.95	0.00124	0.00742	PASS
Extreme (85°C)		16.66	8.67	0.00886	0.00461	PASS
Extreme (80°C)		7.79	12.31	0.00415	0.00655	PASS
Extreme (70°C)		16.53	13.36	0.00879	0.00710	PASS
Extreme (60°C)		14.76	3.15	0.00785	0.00167	PASS
Extreme (50°C)		7.46	6.45	0.00397	0.00343	PASS
Extreme (40°C)		4.33	12.60	0.00230	0.00670	PASS
Extreme (30°C)		8.88	17.61	0.00472	0.00937	PASS
Extreme (20°C)		4.23	6.51	0.00225	0.00346	PASS
Extreme (10°C)		16.89	10.55	0.00899	0.00561	PASS
Extreme (0°C)		6.14	12.69	0.00327	0.00675	PASS
Extreme (-10°C)		12.75	1.72	0.00678	0.00091	PASS
Extreme (-20°C)		11.79	17.39	0.00627	0.00925	PASS
Extreme (-30°C)		11.07	4.71	0.00589	0.00251	PASS
Extreme (-40°C)		17.73	3.82	0.00943	0.00203	PASS
25°C	LV	5.02	10.51	0.00267	0.00559	PASS
	HV	3.48	1.26	0.00185	0.00067	PASS
Condition		Freq.Error (Hz)	Freq.Error (Hz)	Frequency Stability (ppm)	Frequency Stability (ppm)	Verdict
BANDWIDTH	10MHz					
Temperature	Voltage	16QAM	QPSK	16QAM	QPSK	
Normal (25°C)	Normal	11.38	9.02	0.00605	0.00480	PASS
Extreme (85°C)		14.67	2.24	0.00780	0.00119	PASS
Extreme (80°C)		15.25	2.18	0.00811	0.00116	PASS
Extreme (70°C)		3.56	12.47	0.00189	0.00663	PASS
Extreme (60°C)		7.45	13.14	0.00396	0.00699	PASS
Extreme (50°C)		8.04	1.71	0.00428	0.00091	PASS
Extreme (40°C)		13.75	12.89	0.00731	0.00686	PASS
Extreme (30°C)		17.71	11.62	0.00942	0.00618	PASS



Extreme (20°C)		7.02	3.99	0.00374	0.00212	PASS
Extreme (10°C)		4.62	16.77	0.00246	0.00892	PASS
Extreme (0°C)		17.33	4.98	0.00922	0.00265	PASS
Extreme (-10°C)		7.02	2.62	0.00373	0.00140	PASS
Extreme (-20°C)		17.60	6.56	0.00936	0.00349	PASS
Extreme (-30°C)		16.02	16.77	0.00852	0.00892	PASS
Extreme (-40°C)		12.99	10.80	0.00691	0.00575	PASS
25°C	LV	8.53	9.81	0.00454	0.00522	PASS
	HV	5.36	12.49	0.00285	0.00664	PASS

LTE Band 13						
Condition		Freq.Error (Hz)	Freq.Error (Hz)	Frequency Stability (ppm)	Frequency Stability (ppm)	Verdict
BANDWIDTH	5MHz					
Temperature	Voltage	16QAM	QPSK	16QAM	QPSK	
Normal (25°C)	Normal	4.30	15.41	0.00228	0.00820	PASS
Extreme (85°C)		15.78	11.34	0.00839	0.00603	PASS
Extreme (80°C)		3.47	1.18	0.00185	0.00063	PASS
Extreme (70°C)		7.97	14.08	0.00424	0.00749	PASS
Extreme (60°C)		17.81	7.32	0.00948	0.00389	PASS
Extreme (50°C)		2.11	16.35	0.00112	0.00870	PASS
Extreme (40°C)		17.66	9.45	0.00939	0.00502	PASS
Extreme (30°C)		2.20	8.81	0.00117	0.00469	PASS
Extreme (20°C)		4.66	17.21	0.00248	0.00915	PASS
Extreme (10°C)		17.64	14.81	0.00938	0.00788	PASS
Extreme (0°C)		9.94	14.25	0.00529	0.00758	PASS
Extreme (-10°C)		3.59	2.76	0.00191	0.00147	PASS
Extreme (-20°C)		12.01	6.78	0.00639	0.00361	PASS
Extreme (-30°C)		4.83	16.05	0.00257	0.00854	PASS
Extreme (-40°C)		8.23	5.53	0.00438	0.00294	PASS
25°C	LV	17.79	2.56	0.00946	0.00136	PASS
	HV	10.15	2.70	0.00540	0.00144	PASS
Condition		Freq.Error (Hz)	Freq.Error (Hz)	Frequency Stability (ppm)	Frequency Stability (ppm)	Verdict
BANDWIDTH	10MHz					
Temperature	Voltage	16QAM	QPSK	16QAM	QPSK	
Normal (25°C)	Normal	4.31	8.98	0.00229	0.00478	PASS
Extreme (85°C)		16.09	1.29	0.00856	0.00069	PASS
Extreme (80°C)		17.88	16.38	0.00951	0.00871	PASS
Extreme (70°C)		3.31	7.88	0.00176	0.00419	PASS



Extreme (60℃)		16.81	17.29	0.00894	0.00919	PASS
Extreme (50℃)		15.09	1.40	0.00802	0.00074	PASS
Extreme (40℃)		9.18	6.20	0.00488	0.00330	PASS
Extreme (30℃)		13.71	15.93	0.00729	0.00847	PASS
Extreme (20℃)		2.44	10.83	0.00130	0.00576	PASS
Extreme (10℃)		10.78	12.41	0.00573	0.00660	PASS
Extreme (0℃)		5.24	1.34	0.00279	0.00071	PASS
Extreme (-10℃)		12.56	7.05	0.00668	0.00375	PASS
Extreme (-20℃)		5.13	17.46	0.00273	0.00929	PASS
Extreme (-30℃)		13.62	2.28	0.00725	0.00121	PASS
Extreme (-40℃)		9.82	13.14	0.00522	0.00699	PASS
25℃	LV	13.94	4.48	0.00741	0.00238	PASS
	HV	15.47	10.65	0.00823	0.00567	PASS

LTE Band 66						
Condition		Freq.Error (Hz)	Freq.Error (Hz)	Frequency Stability (ppm)	Frequency Stability (ppm)	Verdict
BANDWIDTH	1.4MHz					
Temperature	Voltage	16QAM	QPSK	16QAM	QPSK	
Normal (25℃)	Normal	12.04	17.23	0.00640	0.00917	PASS
Extreme (85℃)		3.83	12.48	0.00204	0.00664	PASS
Extreme (80℃)		11.00	5.37	0.00585	0.00285	PASS
Extreme (70℃)		2.13	13.01	0.00113	0.00692	PASS
Extreme (60℃)		6.10	11.60	0.00325	0.00617	PASS
Extreme (50℃)		17.79	15.40	0.00946	0.00819	PASS
Extreme (40℃)		11.51	14.99	0.00612	0.00797	PASS
Extreme (30℃)		9.55	8.35	0.00508	0.00444	PASS
Extreme (20℃)		5.04	17.40	0.00268	0.00926	PASS
Extreme (10℃)		11.77	5.78	0.00626	0.00308	PASS
Extreme (0℃)		13.46	8.34	0.00716	0.00444	PASS
Extreme (-10℃)		1.36	2.02	0.00072	0.00107	PASS
Extreme (-20℃)		5.99	16.75	0.00318	0.00891	PASS
Extreme (-30℃)		7.01	10.96	0.00373	0.00583	PASS
Extreme (-40℃)		1.84	12.43	0.00098	0.00661	PASS
25℃	LV	7.33	1.96	0.00390	0.00104	PASS
	HV	11.74	14.29	0.00625	0.00760	PASS
Condition		Freq.Error (Hz)	Freq.Error (Hz)	Frequency Stability (ppm)	Frequency Stability (ppm)	Verdict
BANDWIDTH	3MHz					
Temperature	Voltage	16QAM	QPSK	16QAM	QPSK	
Normal (25℃)	Normal	6.90	8.50	0.00367	0.00452	PASS



Extreme (85°C)		13.80	17.30	0.00734	0.00920	PASS
Extreme (80°C)		13.25	5.85	0.00705	0.00311	PASS
Extreme (70°C)		1.43	4.49	0.00076	0.00239	PASS
Extreme (60°C)		14.97	9.98	0.00796	0.00531	PASS
Extreme (50°C)		6.12	9.21	0.00326	0.00490	PASS
Extreme (40°C)		16.48	6.96	0.00877	0.00370	PASS
Extreme (30°C)		13.46	15.68	0.00716	0.00834	PASS
Extreme (20°C)		7.92	4.85	0.00421	0.00258	PASS
Extreme (10°C)		3.08	17.77	0.00164	0.00945	PASS
Extreme (0°C)		11.56	15.82	0.00615	0.00841	PASS
Extreme (-10°C)		1.41	8.04	0.00075	0.00428	PASS
Extreme (-20°C)		3.99	1.94	0.00212	0.00103	PASS
Extreme (-30°C)		8.04	17.01	0.00428	0.00905	PASS
Extreme (-40°C)		5.73	7.08	0.00305	0.00377	PASS
25°C	LV	3.50	14.91	0.00186	0.00793	PASS
	HV	11.00	3.98	0.00585	0.00212	PASS
Condition		Freq.Error (Hz)	Freq.Error (Hz)	Frequency Stability (ppm)	Frequency Stability (ppm)	Verdict
BANDWIDTH	5MHz					
Temperature	Voltage	16QAM	QPSK	16QAM	QPSK	
Normal (25°C)	Normal	11.33	16.83	0.00603	0.00895	PASS
Extreme (85°C)		7.91	8.04	0.00421	0.00428	PASS
Extreme (80°C)		9.79	10.47	0.00521	0.00557	PASS
Extreme (70°C)		4.62	6.47	0.00246	0.00344	PASS
Extreme (60°C)		12.47	7.79	0.00663	0.00414	PASS
Extreme (50°C)		3.61	15.31	0.00192	0.00814	PASS
Extreme (40°C)		3.26	3.82	0.00174	0.00203	PASS
Extreme (30°C)		17.94	2.26	0.00954	0.00120	PASS
Extreme (20°C)		14.71	5.51	0.00782	0.00293	PASS
Extreme (10°C)		10.80	14.17	0.00575	0.00754	PASS
Extreme (0°C)		5.00	4.98	0.00266	0.00265	PASS
Extreme (-10°C)		11.73	16.18	0.00624	0.00861	PASS
Extreme (-20°C)		11.73	8.39	0.00624	0.00446	PASS
Extreme (-30°C)		2.72	12.14	0.00145	0.00646	PASS
Extreme (-40°C)		4.65	8.15	0.00247	0.00433	PASS
25°C	LV	12.12	15.54	0.00645	0.00827	PASS
	HV	4.47	8.16	0.00238	0.00434	PASS
Condition		Freq.Error (Hz)	Freq.Error (Hz)	Frequency Stability (ppm)	Frequency Stability (ppm)	Verdict
BANDWIDTH	10MHz					
Temperature	Voltage	16QAM	QPSK	16QAM	QPSK	



Normal (25°C)	Normal	16.65	8.72	0.00886	0.00464	PASS
Extreme (85°C)		8.95	2.04	0.00476	0.00109	PASS
Extreme (80°C)		5.54	16.14	0.00295	0.00859	PASS
Extreme (70°C)		6.52	12.51	0.00347	0.00666	PASS
Extreme (60°C)		11.96	16.99	0.00636	0.00904	PASS
Extreme (50°C)		13.56	10.15	0.00721	0.00540	PASS
Extreme (40°C)		5.65	12.37	0.00301	0.00658	PASS
Extreme (30°C)		2.16	13.34	0.00115	0.00709	PASS
Extreme (20°C)		15.40	14.26	0.00819	0.00758	PASS
Extreme (10°C)		9.79	9.07	0.00521	0.00482	PASS
Extreme (0°C)		5.19	14.29	0.00276	0.00760	PASS
Extreme (-10°C)		6.42	4.82	0.00341	0.00257	PASS
Extreme (-20°C)		9.24	6.29	0.00491	0.00334	PASS
Extreme (-30°C)		13.04	5.59	0.00694	0.00298	PASS
Extreme (-40°C)		16.64	3.71	0.00885	0.00197	PASS
25°C	LV	3.38	7.46	0.00180	0.00397	PASS
	HV	16.13	9.08	0.00858	0.00483	PASS
Condition		Freq.Error	Freq.Error	Frequency	Frequency	Verdict
BANDWIDTH	15MHz	(Hz)	(Hz)	Stability	Stability	
Temperature	Voltage	16QAM	QPSK	(ppm)	(ppm)	
Normal (25°C)	Normal	5.15	11.13	0.00274	0.00592	PASS
Extreme (85°C)		8.10	15.37	0.00431	0.00818	PASS
Extreme (80°C)		4.96	5.73	0.00264	0.00305	PASS
Extreme (70°C)		8.16	3.23	0.00434	0.00172	PASS
Extreme (60°C)		2.08	1.06	0.00111	0.00056	PASS
Extreme (50°C)		5.96	8.95	0.00317	0.00476	PASS
Extreme (40°C)		12.48	5.07	0.00664	0.00270	PASS
Extreme (30°C)		3.28	4.03	0.00175	0.00214	PASS
Extreme (20°C)		5.06	12.43	0.00269	0.00661	PASS
Extreme (10°C)		3.56	13.14	0.00189	0.00699	PASS
Extreme (0°C)		15.64	8.37	0.00832	0.00445	PASS
Extreme (-10°C)		7.24	15.45	0.00385	0.00822	PASS
Extreme (-20°C)		16.35	5.57	0.00870	0.00296	PASS
Extreme (-30°C)		8.34	4.64	0.00443	0.00247	PASS
Extreme (-40°C)		5.07	2.10	0.00270	0.00112	PASS
25°C	LV	6.52	8.16	0.00347	0.00434	PASS
	HV	6.92	1.95	0.00368	0.00104	PASS
Condition		Freq.Error	Freq.Error	Frequency	Frequency	Verdict
BANDWIDTH	20MHz	(Hz)	(Hz)	Stability	Stability	
		(ppm)	(ppm)	(ppm)	(ppm)	



Temperature	Voltage	16QAM	QPSK	16QAM	QPSK	
Normal (25°C)	Normal	17.87	6.15	0.00951	0.00327	PASS
Extreme (85°C)		13.66	10.95	0.00726	0.00582	PASS
Extreme (80°C)		5.39	1.25	0.00287	0.00067	PASS
Extreme (70°C)		11.88	10.32	0.00632	0.00549	PASS
Extreme (60°C)		3.04	1.33	0.00162	0.00071	PASS
Extreme (50°C)		1.14	7.31	0.00061	0.00389	PASS
Extreme (40°C)		3.09	17.41	0.00164	0.00926	PASS
Extreme (30°C)		9.11	7.25	0.00484	0.00386	PASS
Extreme (20°C)		14.47	4.64	0.00770	0.00247	PASS
Extreme (10°C)		17.76	3.78	0.00945	0.00201	PASS
Extreme (0°C)		17.61	16.26	0.00937	0.00865	PASS
Extreme (-10°C)		10.58	6.21	0.00563	0.00330	PASS
Extreme (-20°C)		13.93	16.44	0.00741	0.00875	PASS
Extreme (-30°C)		3.96	4.21	0.00211	0.00224	PASS
Extreme (-40°C)		10.80	3.18	0.00574	0.00169	PASS
25°C	LV	1.69	16.63	0.00090	0.00885	PASS
	HV	15.20	11.19	0.00809	0.00595	PASS

LTE Band 85						
Condition		Freq.Error (Hz)	Freq.Error (Hz)	Frequency Stability (ppm)	Frequency Stability (ppm)	Verdict
BANDWIDTH	5MHz					
Temperature	Voltage	16QAM	QPSK	16QAM	QPSK	
Normal (25°C)	Normal	15.61	5.92	0.00830	0.00315	PASS
Extreme (85°C)		14.69	13.42	0.00781	0.00714	PASS
Extreme (80°C)		9.68	3.61	0.00515	0.00192	PASS
Extreme (70°C)		11.27	1.15	0.00599	0.00061	PASS
Extreme (60°C)		4.76	12.84	0.00253	0.00683	PASS
Extreme (50°C)		3.73	15.98	0.00198	0.00850	PASS
Extreme (40°C)		4.43	12.00	0.00236	0.00638	PASS
Extreme (30°C)		11.26	5.19	0.00599	0.00276	PASS
Extreme (20°C)		3.36	12.57	0.00179	0.00669	PASS
Extreme (10°C)		16.61	16.99	0.00884	0.00904	PASS
Extreme (0°C)		5.02	13.56	0.00267	0.00721	PASS
Extreme (-10°C)		2.54	6.51	0.00135	0.00346	PASS
Extreme (-20°C)		11.83	16.34	0.00629	0.00869	PASS
Extreme (-30°C)		3.32	15.73	0.00177	0.00836	PASS
Extreme (-40°C)		15.91	13.03	0.00846	0.00693	PASS
25°C	LV	4.12	17.06	0.00219	0.00907	PASS
	HV	6.04	7.40	0.00321	0.00394	PASS
Condition		Freq.Error	Freq.Error	Frequency	Frequency	Verdict



		(Hz)	(Hz)	Stability (ppm)	Stability (ppm)	
BANDWIDTH	10MHz					
Temperature	Voltage	16QAM	QPSK	16QAM	QPSK	
Normal (25°C)	Normal	2.79	1.91	0.00149	0.00102	PASS
Extreme (85°C)		11.80	7.70	0.00628	0.00409	PASS
Extreme (80°C)		8.76	17.36	0.00466	0.00924	PASS
Extreme (70°C)		14.33	8.25	0.00762	0.00439	PASS
Extreme (60°C)		3.92	4.09	0.00209	0.00218	PASS
Extreme (50°C)		3.56	17.63	0.00190	0.00938	PASS
Extreme (40°C)		14.82	13.02	0.00788	0.00693	PASS
Extreme (30°C)		11.94	17.89	0.00635	0.00952	PASS
Extreme (20°C)		3.44	4.19	0.00183	0.00223	PASS
Extreme (10°C)		18.00	14.48	0.00957	0.00770	PASS
Extreme (0°C)		4.90	3.85	0.00261	0.00205	PASS
Extreme (-10°C)		12.04	6.86	0.00641	0.00365	PASS
Extreme (-20°C)		11.88	4.03	0.00632	0.00214	PASS
Extreme (-30°C)		13.57	13.05	0.00722	0.00694	PASS
Extreme (-40°C)		10.86	14.10	0.00578	0.00750	PASS
25°C		LV	11.34	14.78	0.00603	0.00786
	HV	3.03	17.97	0.00161	0.00956	PASS

5.6 Spurious Emissions at Antenna Terminals

Ambient condition

Temperature	Relative humidity	Pressure
23°C ~25°C	45%~50%	101.5kPa

Method of Measurement

The EUT was connected to Spectrum Analyzer and Base Station Simulator via power Splitter. The measurement is carried out using a spectrum analyzer. The spectrum analyzer scans from 9kHz to the 10th harmonic of the carrier. The peak detector is used.

RBW is set to 100kHz, VBW is set to 300kHz for 30MHz~1GHz

RBW is set to 1MHz, VBW is set to 3MHz for above 1GHz, Sweep is set to ATUO.

Of those disturbances below (limit – 20 dB), the mark is not required for the EUT.

The modulation mode and RB allocation refer to section 5.1, using the maximum output power configuration.

Test setup

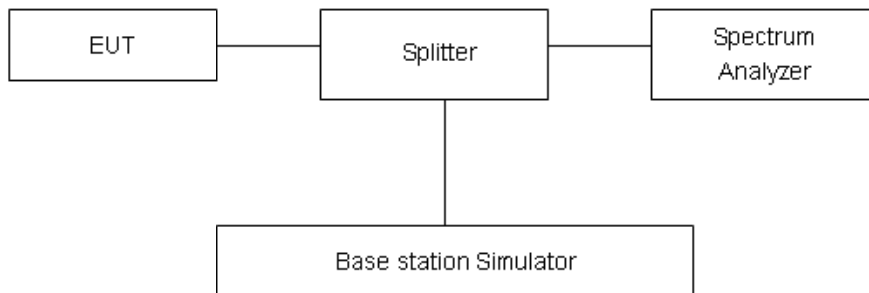

Limits

Rule Part 27.53(h) specifies that “for operations in the 1695-1710 MHz, 1710-1755 MHz, 1755-1780 MHz, 1915-1920 MHz, 1995-2000 MHz, 2000-2020 MHz, 2110-2155 MHz, 2155-2180 MHz, and 2180-2200 bands, the power of any emission outside a licensee's frequency block shall be attenuated below the transmitter power (P) in watts by at least $43 + 10 \log_{10} (P)$ dB..”

Rule Part 27.53 (g) For operations in the 600 MHz band and the 698-746 MHz band, the power of any emission outside a licensee's frequency band(s) of operation shall be attenuated below the transmitter power (P) within the licensed band(s) of operation, measured in watts, by at least $43 + 10 \log (P)$ dB. Compliance with this provision is based on the use of measurement instrumentation employing a resolution bandwidth of 100 kilohertz or greater. However, in the 100 kilohertz bands immediately outside and adjacent to a licensee's frequency block, a resolution bandwidth of at least 30 kHz may be employed.

Rule Part 27.53(f) For operations in the 746-758 MHz, 775-788 MHz, and 805-806 MHz bands, emissions in the band 1559-1610 MHz shall be limited to -70 dBW/MHz equivalent isotropically



radiated power (EIRP) for wideband signals, and -80 dBW EIRP for discrete emissions of less than 700 Hz bandwidth. For the purpose of equipment authorization, a transmitter shall be tested with an antenna that is representative of the type that will be used with the equipment in normal operation.

Part 27.53 (c) For operations in the 746-758 MHz band and the 776-788 MHz band, the power of any emission outside the licensee's frequency band(s) of operation shall be attenuated below the transmitter power (P) within the licensed band(s) of operation, measured in watts, in accordance with the following:

- (1) On any frequency outside the 746-758 MHz band, the power of any emission shall be attenuated outside the band below the transmitter power (P) by at least $43 + 10 \log (P)$ dB;
- (2) On any frequency outside the 776-788 MHz band, the power of any emission shall be attenuated outside the band below the transmitter power (P) by at least $43 + 10 \log (P)$ dB;
- (3) On all frequencies between 763-775 MHz and 793-805 MHz, by a factor not less than $76 + 10 \log (P)$ dB in a 6.25 kHz band segment, for base and fixed stations;
- (4) On all frequencies between 763-775 MHz and 793-805 MHz, by a factor not less than $65 + 10 \log (P)$ dB in a 6.25 kHz band segment, for mobile and portable stations;
- (5) Compliance with the provisions of paragraphs (c)(1) and (c)(2) of this section is based on the use of measurement instrumentation employing a resolution bandwidth of 100 kHz or greater. However, in the 100 kHz bands immediately outside and adjacent to the frequency block, a resolution bandwidth of at least 30 kHz may be employed;

Part 27.53(a)/(h)/(g) Limit		-13 dBm
Part 27.53(f) Limit	Limit out of the band 1559-1610 MHz	-13 dBm
	Limit in the band 1559-1610 MHz	-40 dBm

Measurement Uncertainty

The assessed measurement uncertainty to ensure 99.75% confidence level for the normal distribution is with the coverage factor $k = 1.96$.

Frequency	Uncertainty
9kHz-1GHz	0.684 dB
1GHz-27GHz	1.407 dB



Test Result

Sweep the whole frequency band through the range from 9kHz to the 10th harmonic of the carrier, the emissions more than 20 dB below the limit are not reported.

The signal beyond the limit is carrier.

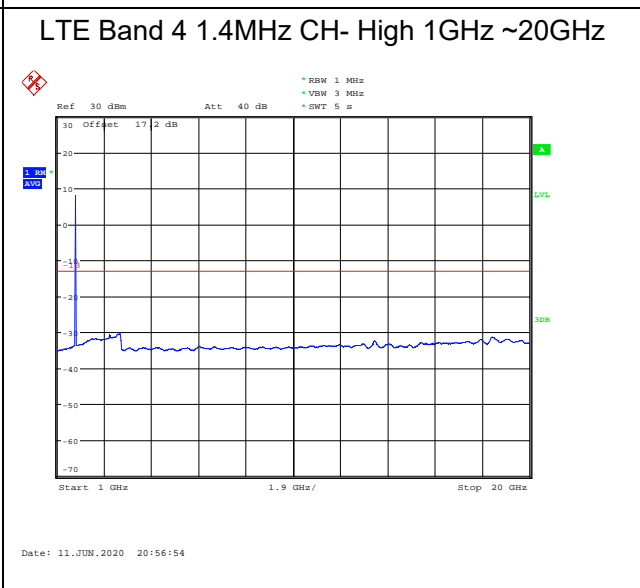
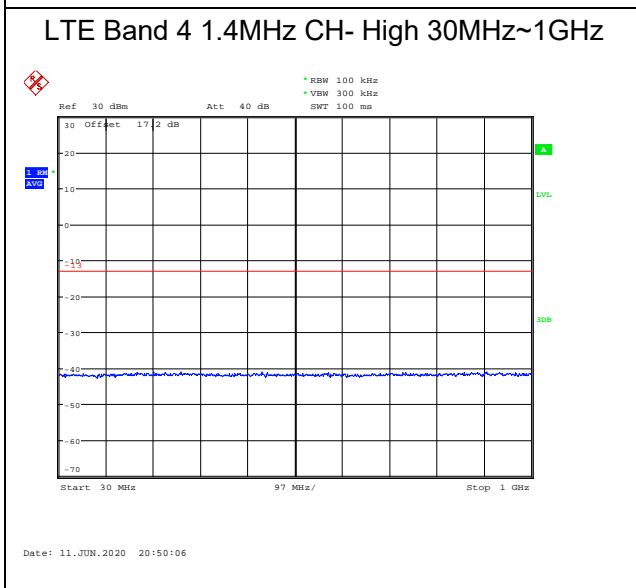
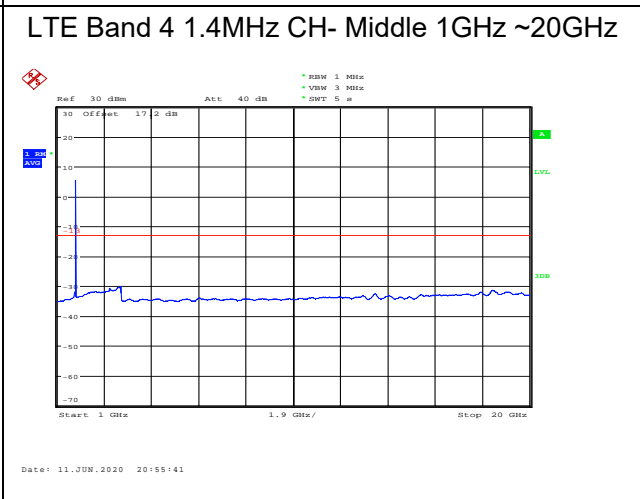
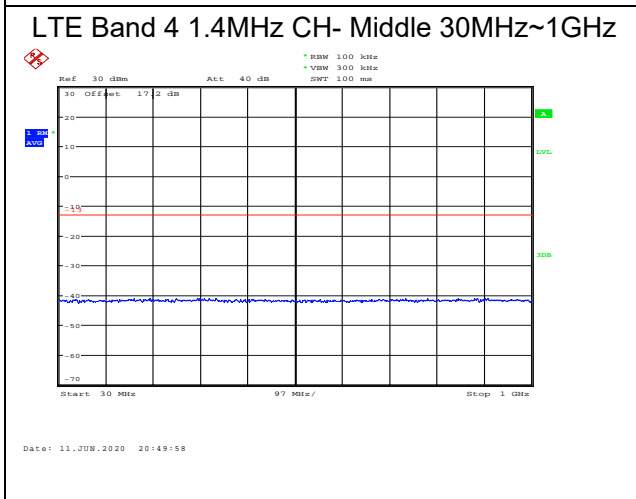
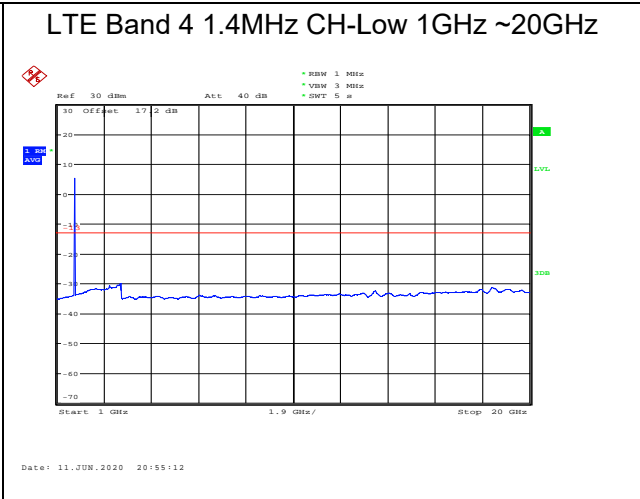
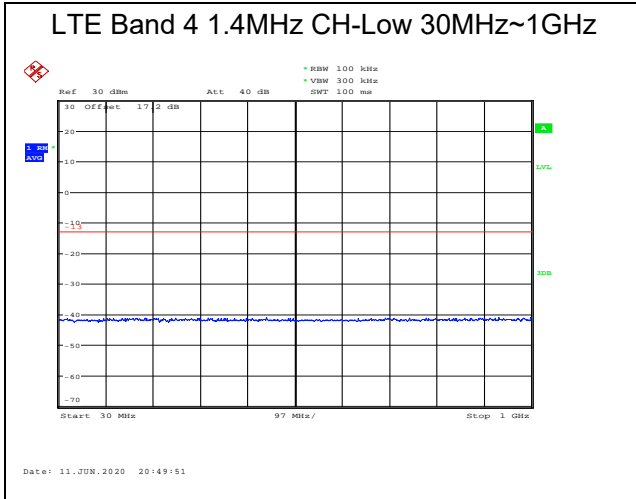



LTE Band 4 3MHz CH-Low 30MHz~1GHz

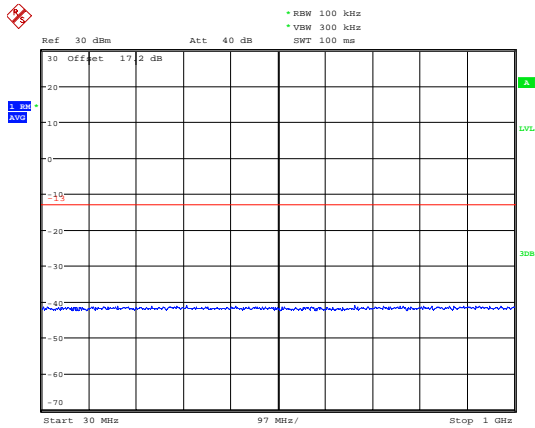

Date: 11.JUN.2020 20:50:14

LTE Band 4 3MHz CH-Low 1GHz ~20GHz

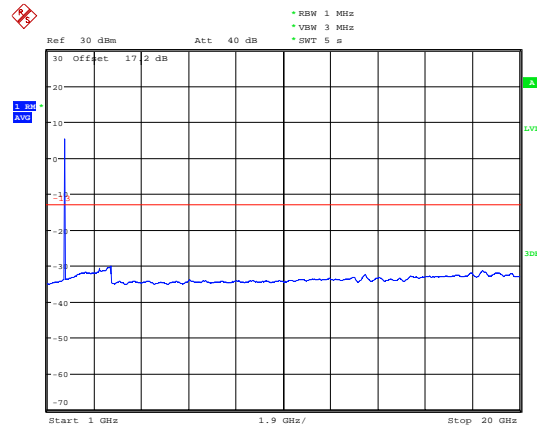

Date: 11.JUN.2020 20:57:58

LTE Band 4 3MHz CH- Middle 30MHz~1GHz

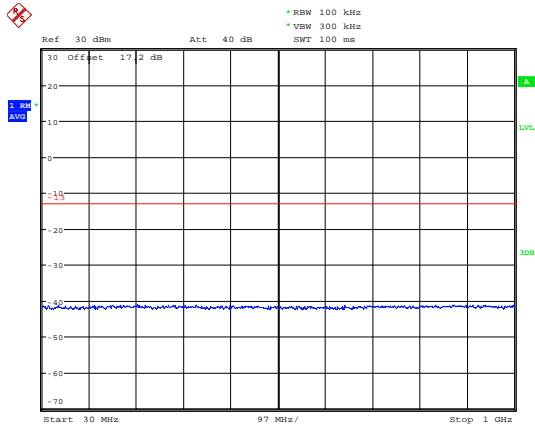

Date: 11.JUN.2020 20:50:22

LTE Band 4 3MHz CH- Middle 1GHz ~20GHz

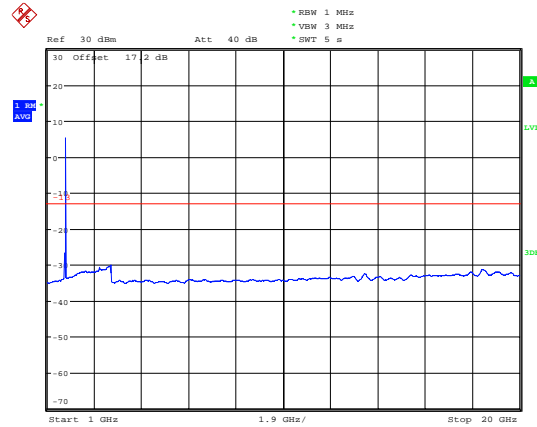

Date: 11.JUN.2020 20:58:37

LTE Band 4 3MHz CH- High 30MHz~1GHz

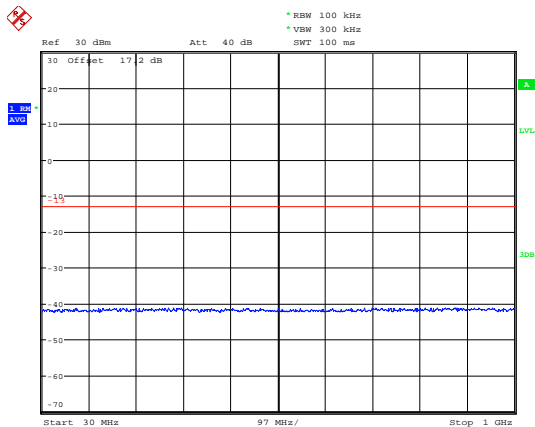

Date: 11.JUN.2020 20:50:30

LTE Band 4 3MHz CH- High 1GHz ~9GHz

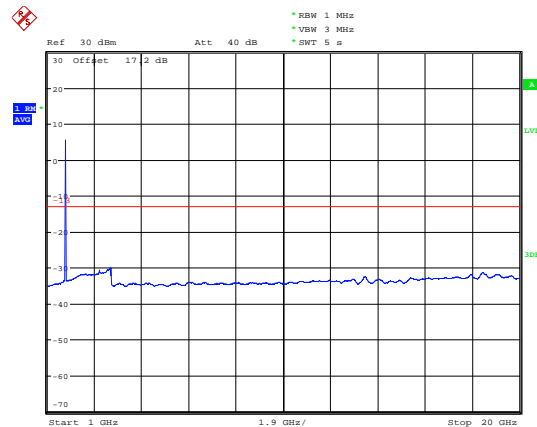

Date: 11.JUN.2020 20:59:06



LTE Band 4 5MHz CH-Low 30MHz~1GHz

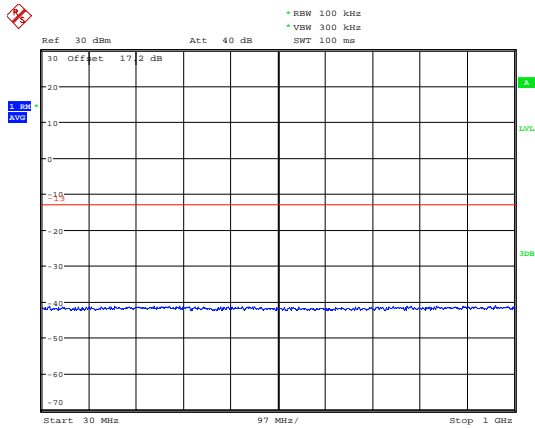

Date: 11.JUN.2020 20:50:38

LTE Band 4 5MHz CH-Low 1GHz~20GHz

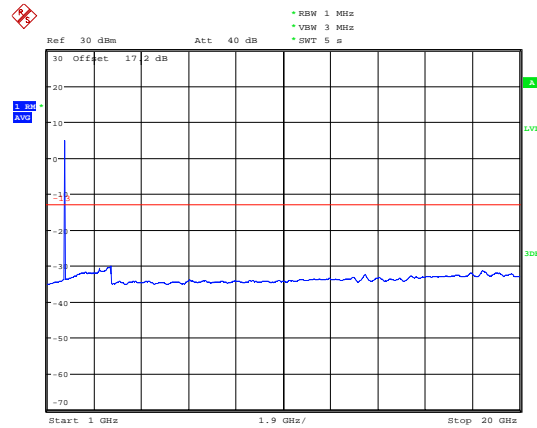

Date: 11.JUN.2020 20:59:41

LTE Band 4 5MHz CH- Middle 30MHz~1GHz

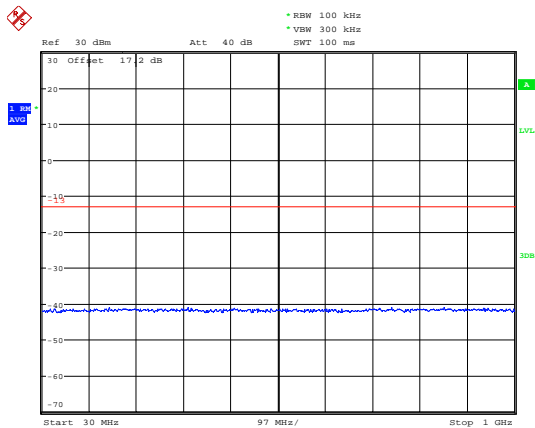

Date: 11.JUN.2020 20:50:45

LTE Band 4 5MHz CH- Middle 1GHz~20GHz

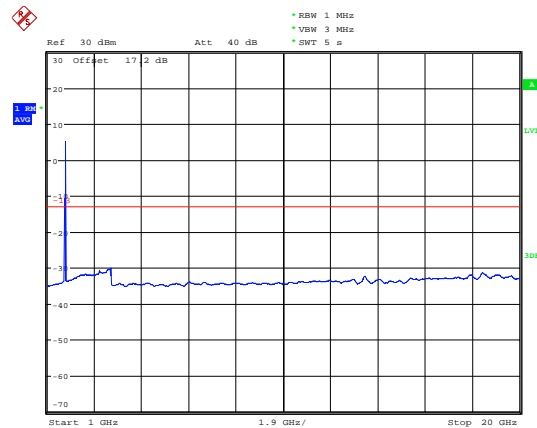

Date: 11.JUN.2020 21:00:07

LTE Band 4 5MHz CH- High 30MHz~1GHz

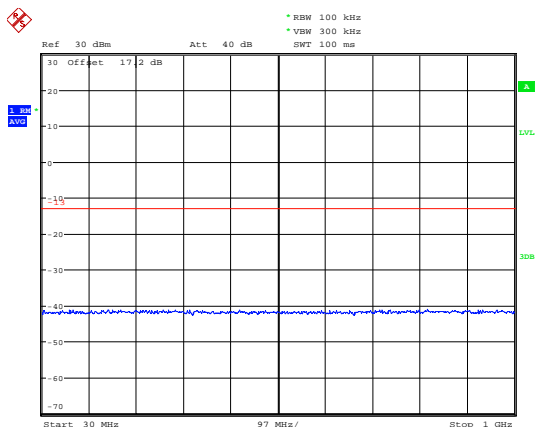

Date: 11.JUN.2020 20:50:52

LTE Band 4 5MHz CH- High 1GHz~20GHz

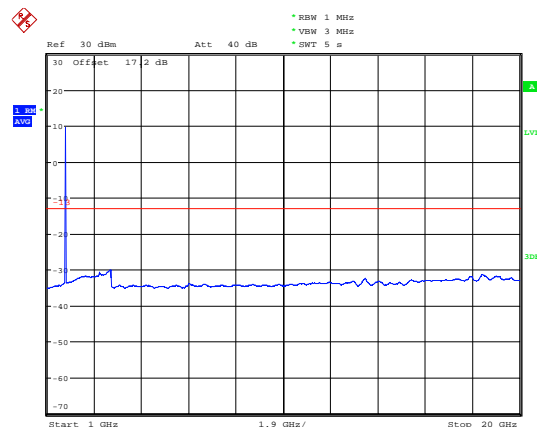

Date: 11.JUN.2020 21:01:07



LTE Band 4 10MHz CH-Low 30MHz~1GHz

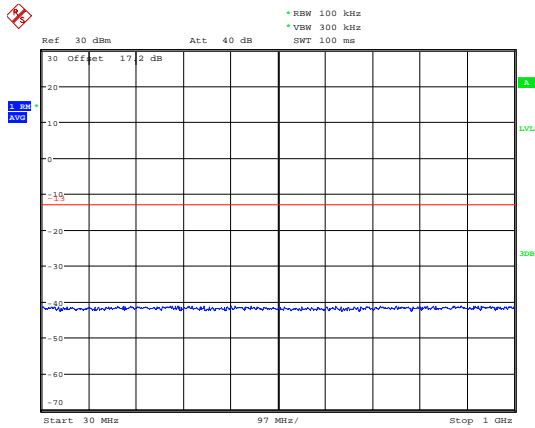

Date: 11.JUN.2020 20:51:00

LTE Band 4 10MHz CH-Low 1GHz ~20GHz

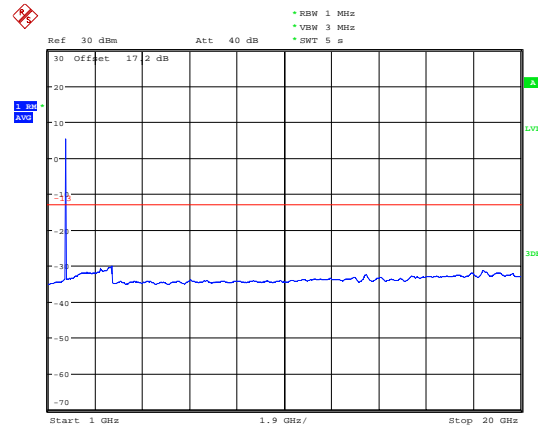

Date: 11.JUN.2020 21:01:46

LTE Band 4 10MHz CH- Middle 30MHz~1GHz

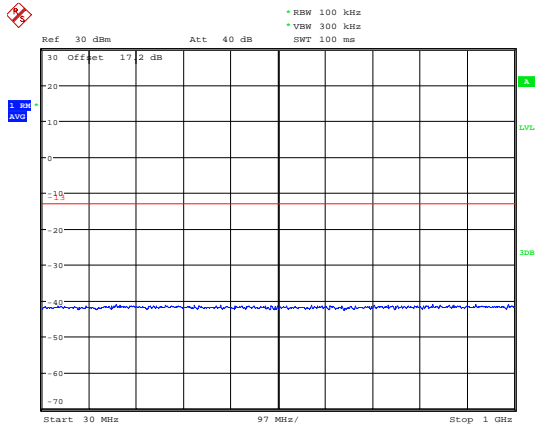

Date: 11.JUN.2020 20:51:12

LTE Band 4 10MHz CH- Middle 1GHz ~20GHz

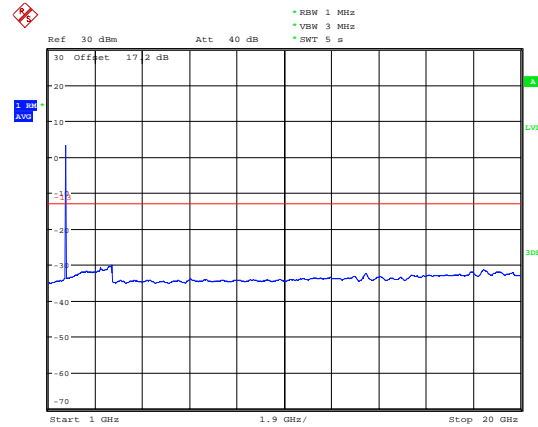

Date: 11.JUN.2020 21:02:07

LTE Band 4 10MHz CH- High 30MHz~1GHz

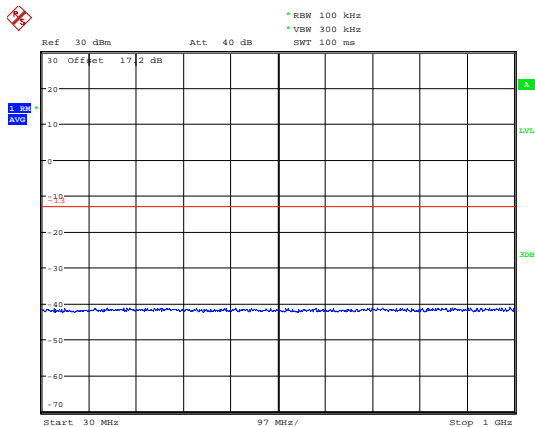

Date: 11.JUN.2020 20:51:20

LTE Band 4 10MHz CH- High 1GHz ~20GHz

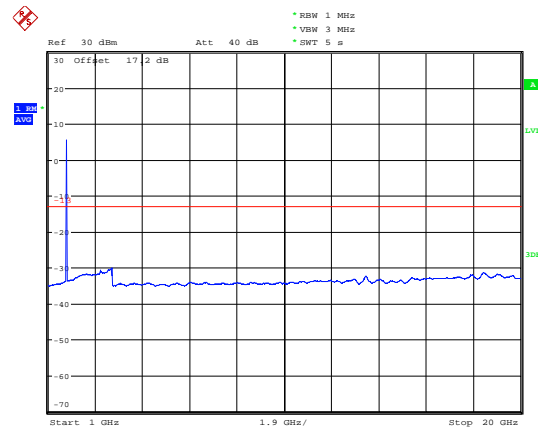

Date: 11.JUN.2020 21:02:32



LTE Band 4 15MHz CH-Low 30MHz~1GHz

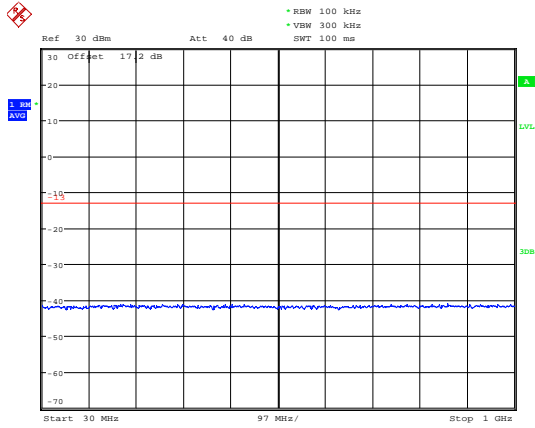

Date: 11.JUN.2020 20:51:27

LTE Band 4 15MHz CH-Low 1GHz ~20GHz

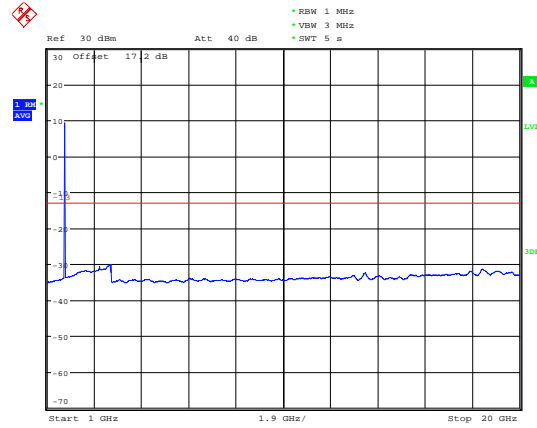

Date: 11.JUN.2020 21:03:33

LTE Band 4 15MHz CH- Middle 30MHz~1GHz

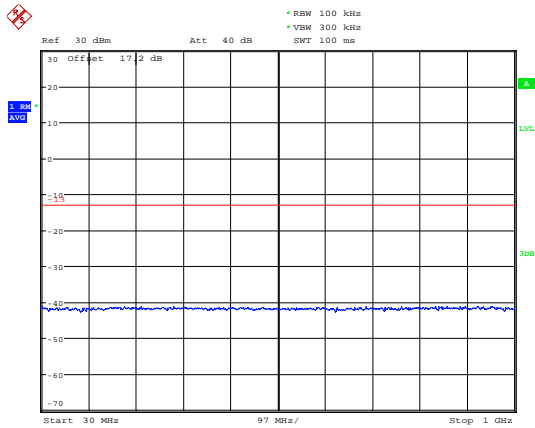

Date: 11.JUN.2020 20:51:35

LTE Band 4 15MHz CH- Middle 1GHz ~20GHz

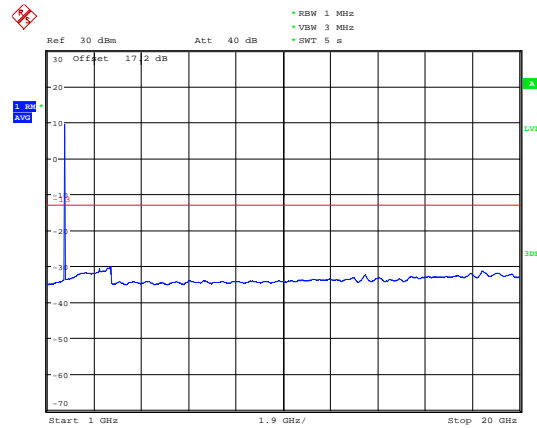

Date: 11.JUN.2020 21:03:55

LTE Band 4 15MHz CH- High 30MHz~1GHz

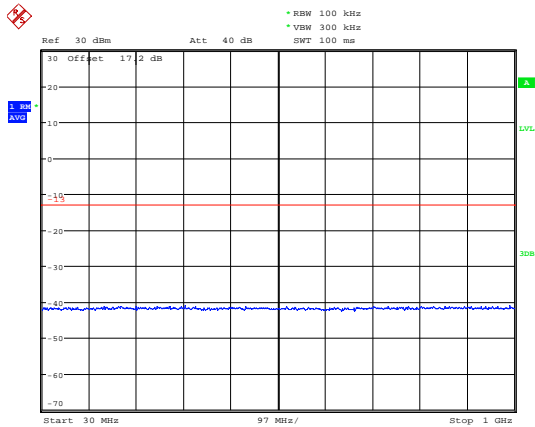

Date: 11.JUN.2020 20:51:43

LTE Band 4 15MHz CH- High 1GHz ~20GHz

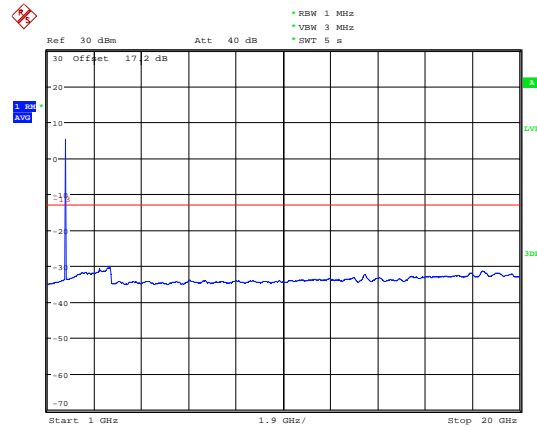

Date: 11.JUN.2020 21:06:35



LTE Band 4 20MHz CH-Low 30MHz~1GHz

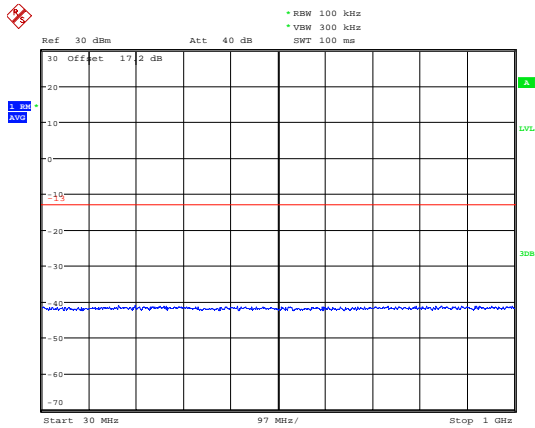

Date: 11.JUN.2020 20:51:51

LTE Band 4 20MHz CH-Low 1GHz ~20GHz

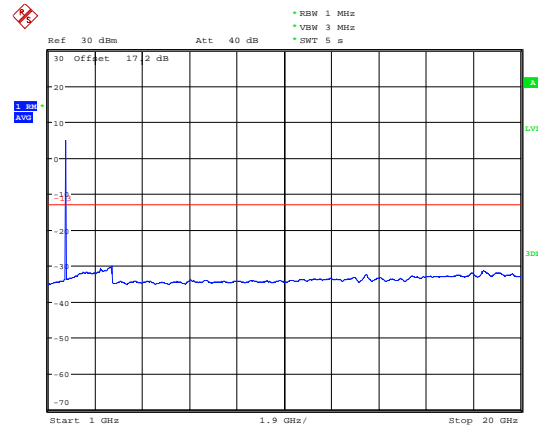

Date: 11.JUN.2020 21:07:52

LTE Band 4 20MHz CH- Middle 30MHz~1GHz

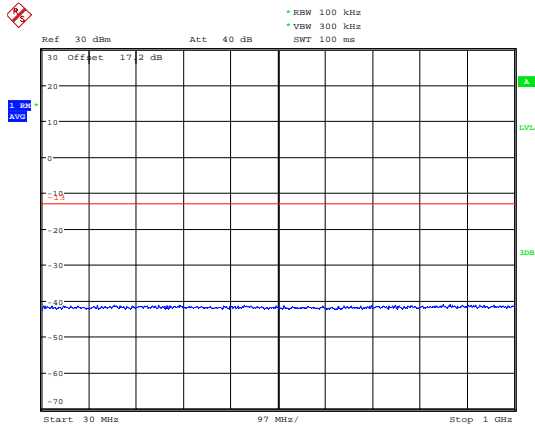

Date: 11.JUN.2020 20:52:00

LTE Band 4 20MHz CH- Middle 1GHz ~20GHz

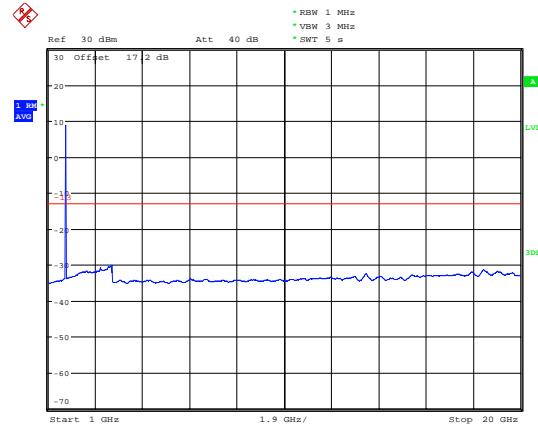

Date: 11.JUN.2020 21:08:19

LTE Band 4 20MHz CH- High 30MHz~1GHz

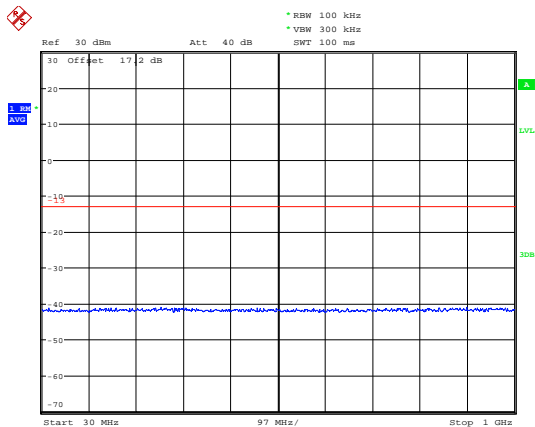

Date: 11.JUN.2020 20:52:08

LTE Band 4 20MHz CH- High 1GHz ~20GHz

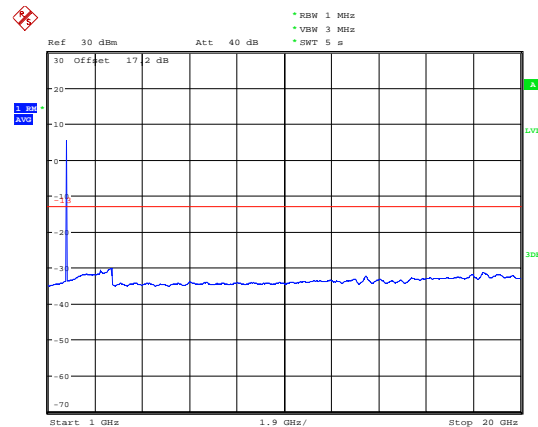

Date: 11.JUN.2020 21:08:46



LTE Band 12 1.4MHz CH-Low 30MHz~1GHz

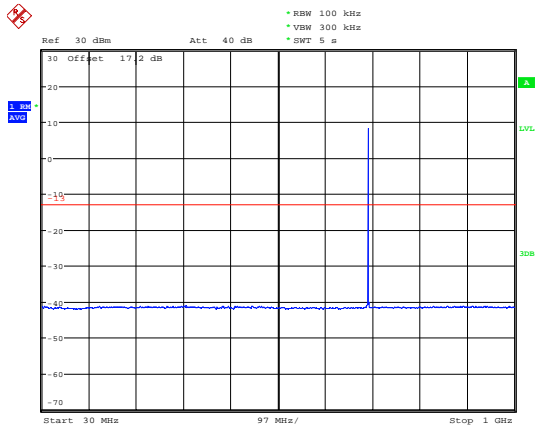

Date: 11.JUN.2020 22:08:45

LTE Band 12 1.4MHz CH-Low 1GHz~20GHz

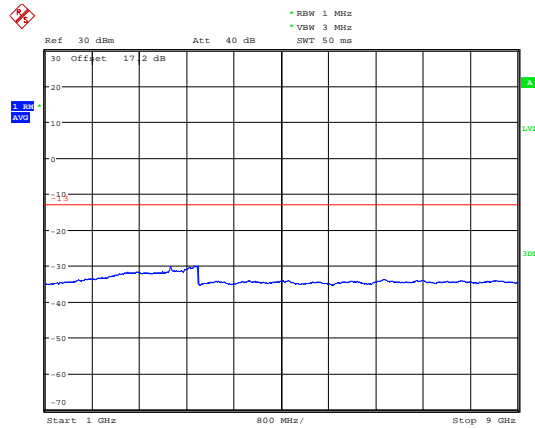

Date: 11.JUN.2020 22:03:09

LTE Band 12 1.4MHz CH-Middle 30MHz~1GHz

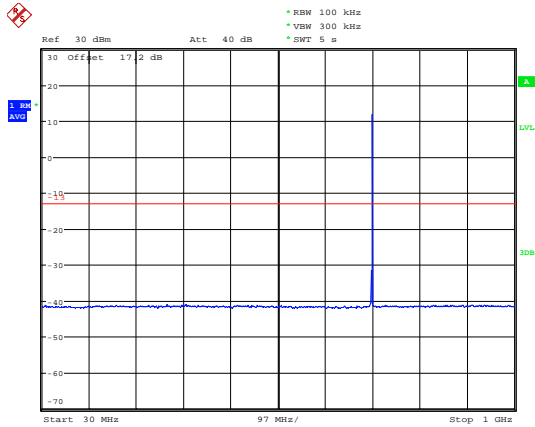

Date: 11.JUN.2020 22:11:44

LTE Band 12 1.4MHz CH-Middle 1GHz~9GHz

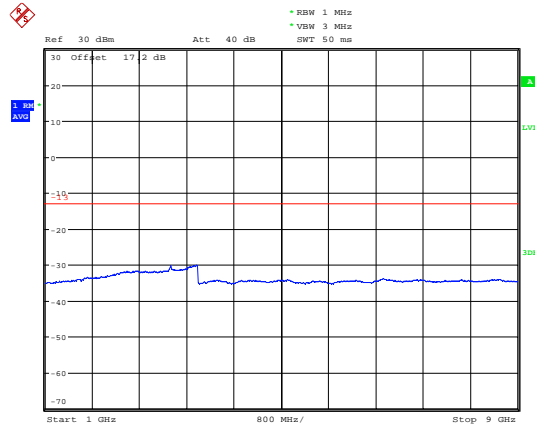

Date: 11.JUN.2020 22:03:18

LTE Band 12 1.4MHz CH-High 30MHz~1GHz

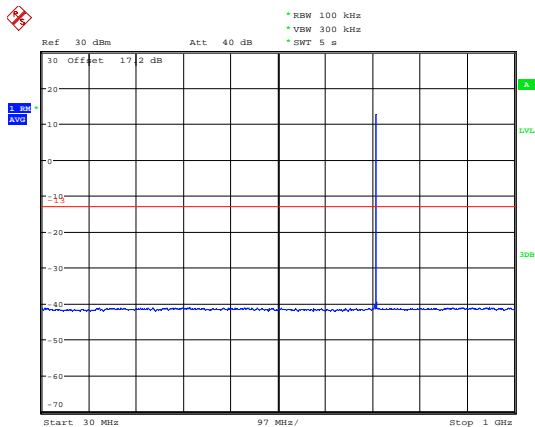

Date: 11.JUN.2020 22:13:40

LTE Band 12 1.4MHz CH-High 1GHz~9GHz

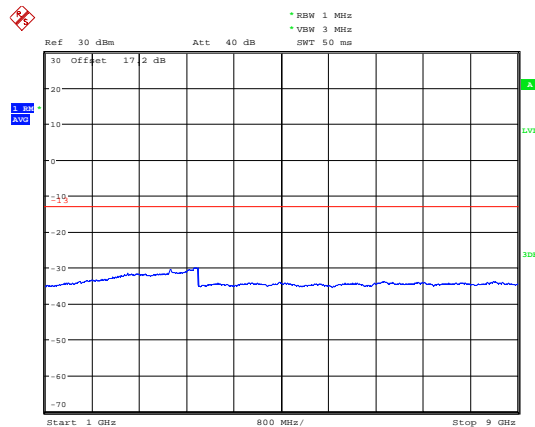

Date: 11.JUN.2020 22:03:26



LTE Band 12 3MHz CH-Low 30MHz~1GHz

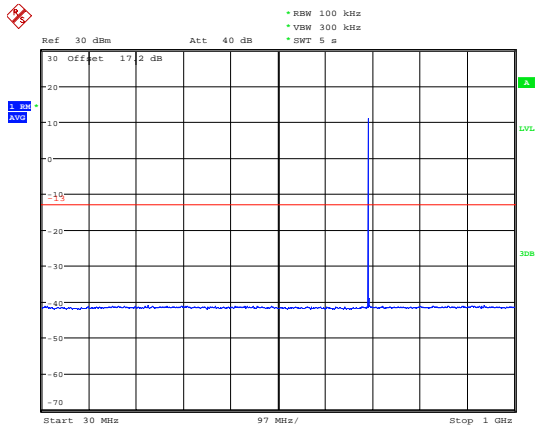

Date: 11.JUN.2020 22:15:30

LTE Band 12 3MHz CH-Low 1GHz~9GHz

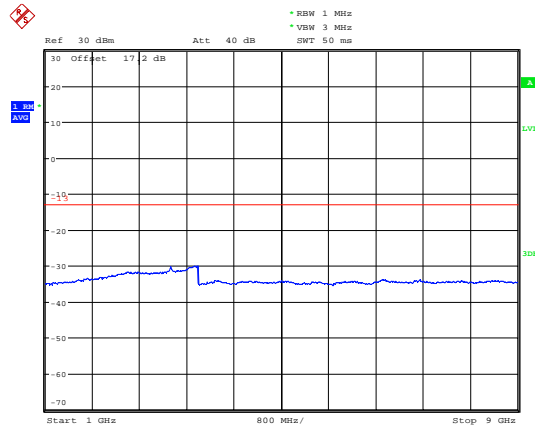

Date: 11.JUN.2020 22:03:45

LTE Band 12 3MHz CH-Middle 30MHz~1GHz

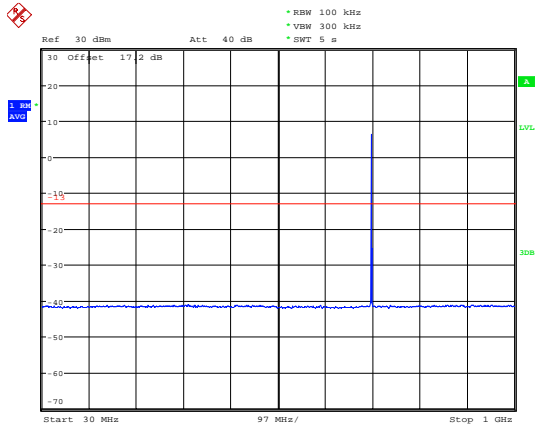

Date: 11.JUN.2020 22:16:09

LTE Band 12 3MHz CH-Middle 1GHz~9GHz

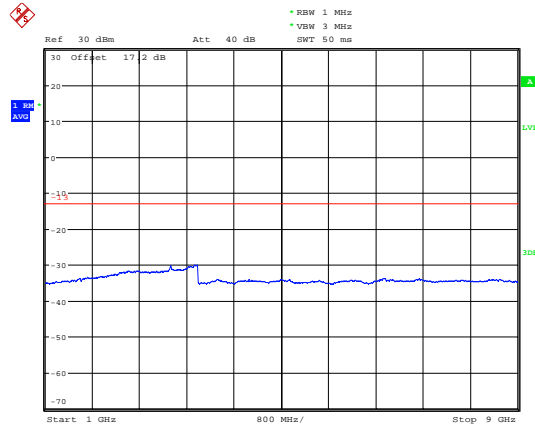

Date: 11.JUN.2020 22:03:52

LTE Band 12 3MHz CH-High 30MHz~1GHz

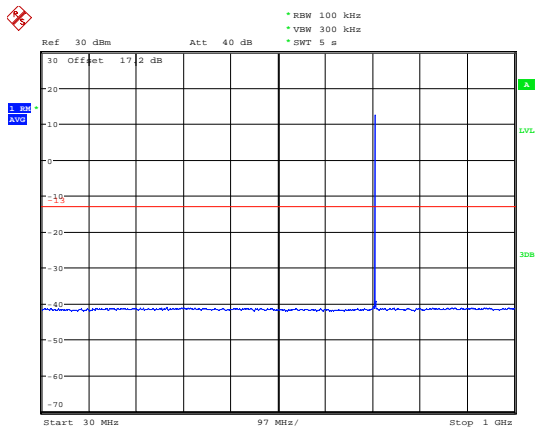

Date: 11.JUN.2020 22:16:45

LTE Band 12 3MHz CH-High 1GHz~9GHz

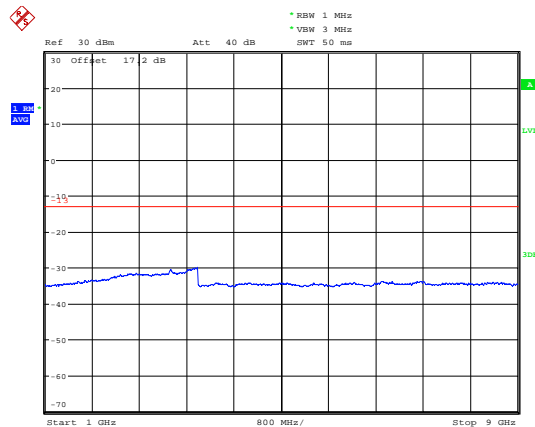

Date: 11.JUN.2020 22:04:00



LTE Band 12 5MHz CH-Low 30MHz~1GHz

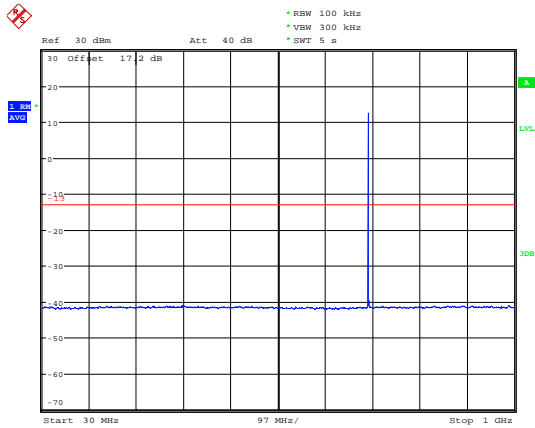

Date: 11.JUN.2020 22:17:20

LTE Band 12 5MHz CH-Low 1GHz~9GHz

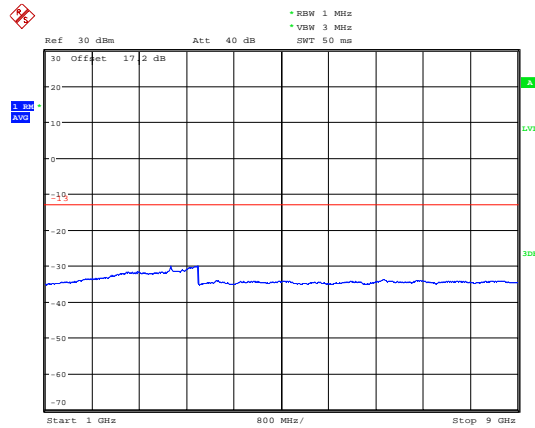

Date: 11.JUN.2020 22:04:09

LTE Band 12 5MHz CH-Middle 30MHz~1GHz

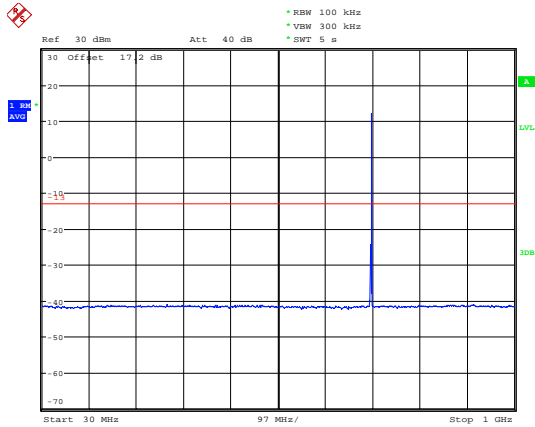

Date: 11.JUN.2020 22:17:52

LTE Band 12 5MHz CH-Middle 1GHz~9GHz

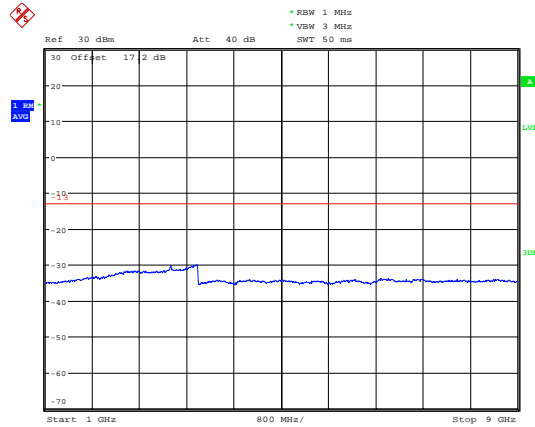

Date: 11.JUN.2020 22:04:16

LTE Band 12 5MHz CH-High 30MHz~1GHz

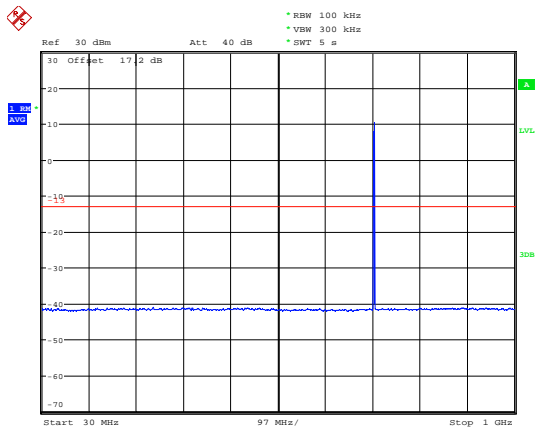

Date: 11.JUN.2020 22:18:24

LTE Band 12 5MHz CH-High 1GHz~9GHz

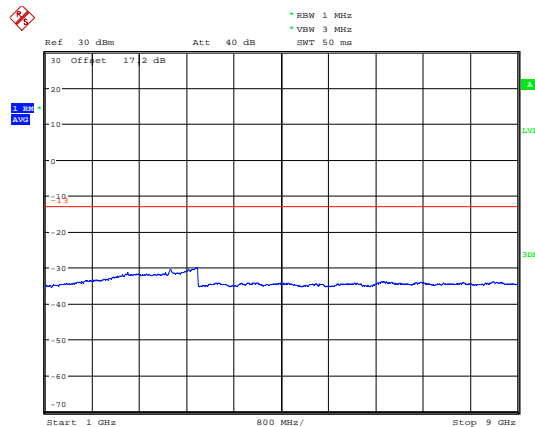

Date: 11.JUN.2020 22:04:27



LTE Band 12 10MHz CH-Low 30MHz~1GHz

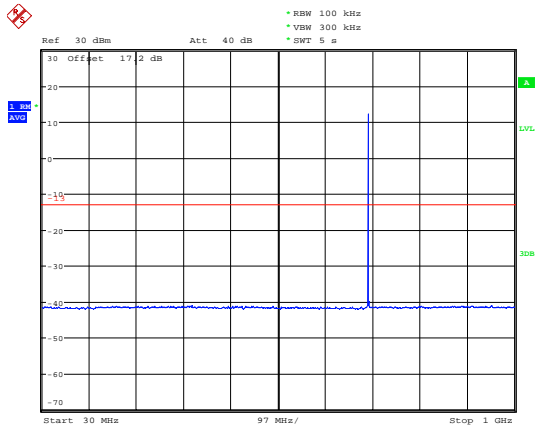

Date: 11.JUN.2020 22:18:57

LTE Band 12 10MHz CH-Low 1GHz~9GHz

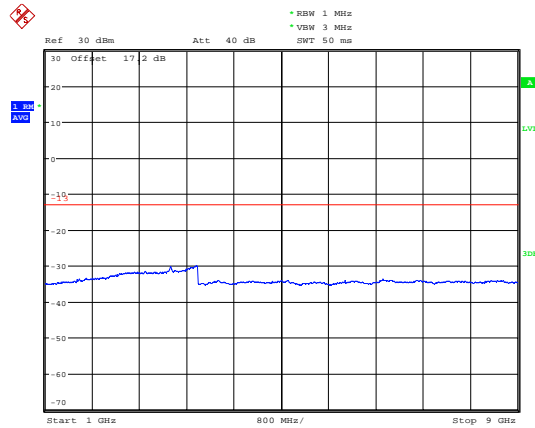

Date: 11.JUN.2020 22:04:35

LTE Band 12 10MHz CH-Middle 30MHz~1GHz

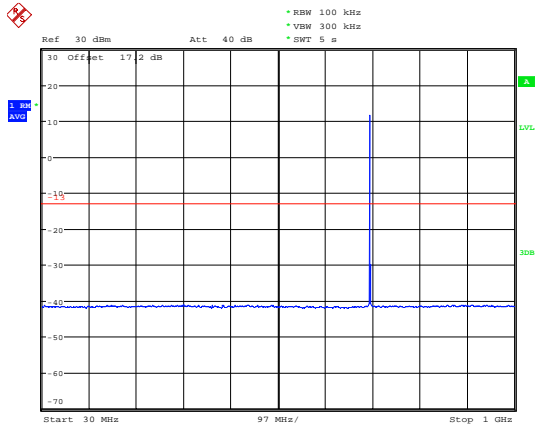

Date: 11.JUN.2020 22:19:54

LTE Band 12 10MHz CH-Middle 1GHz~9GHz

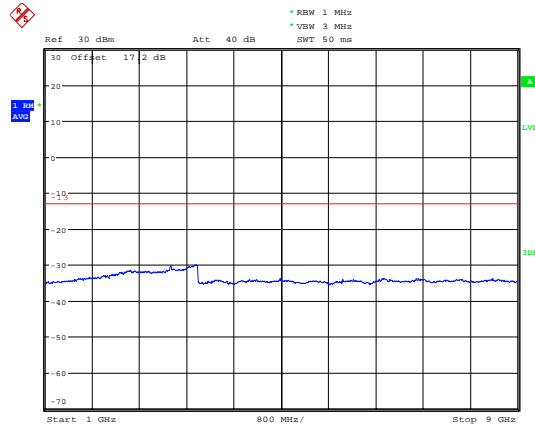

Date: 11.JUN.2020 22:04:44

LTE Band 12 10MHz CH-High 30MHz~1GHz

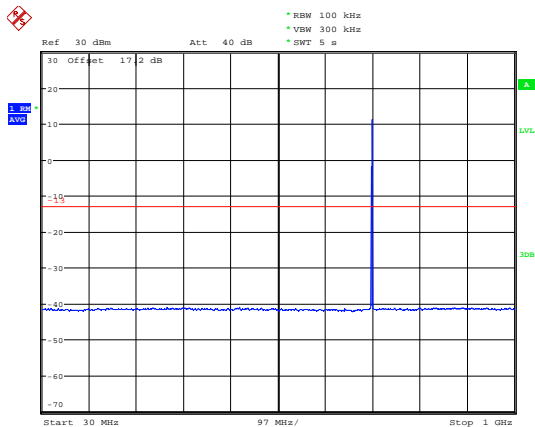

Date: 11.JUN.2020 22:22:08

LTE Band 12 10MHz CH-High 1GHz~9GHz

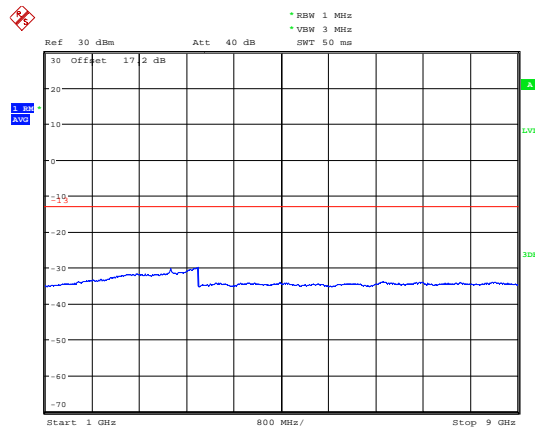

Date: 11.JUN.2020 22:04:53



LTE Band 13 5MHz CH-Low 30MHz~1GHz

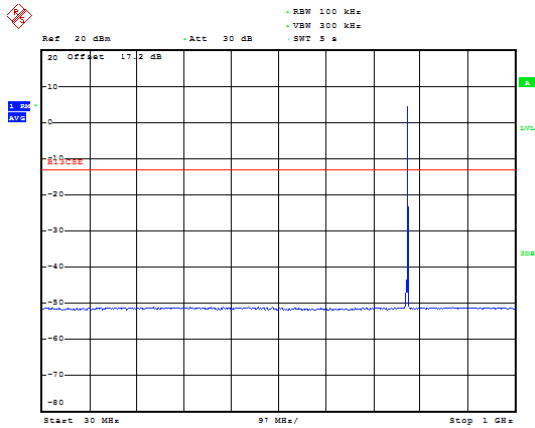

Date: 11 JUN 2020 22:31:08

LTE Band 13 5MHz CH-Low 1GHz~9GHz

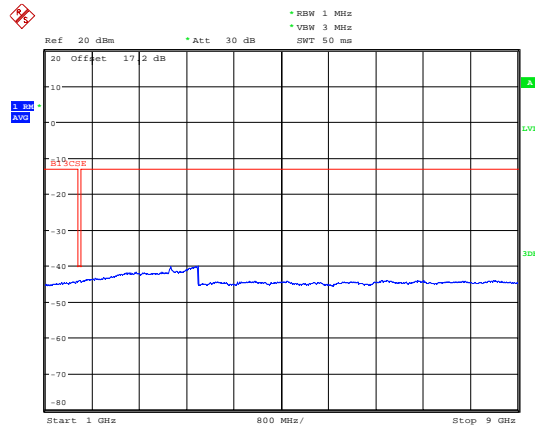

Date: 11 JUN 2020 22:36:26

LTE Band 13 5MHz CH-Middle 30MHz~1GHz

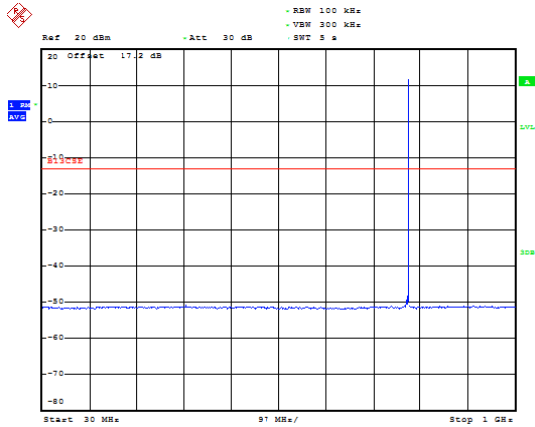

Date: 11 JUN 2020 22:33:17

LTE Band 13 5MHz CH-Middle 1GHz~9GHz

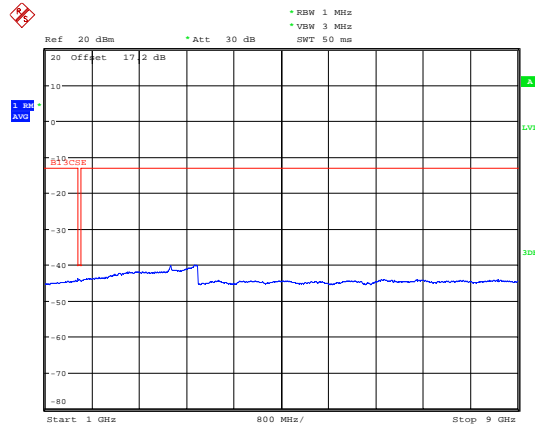

Date: 11 JUN 2020 22:36:34

LTE Band 13 5MHz CH-High 30MHz~1GHz

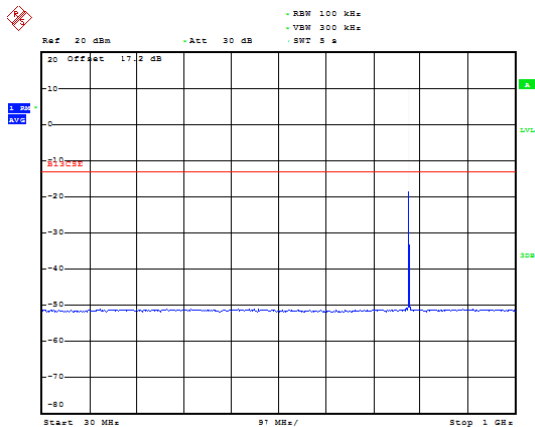

Date: 11 JUN 2020 22:34:40

LTE Band 13 5MHz CH-High 1GHz~9GHz

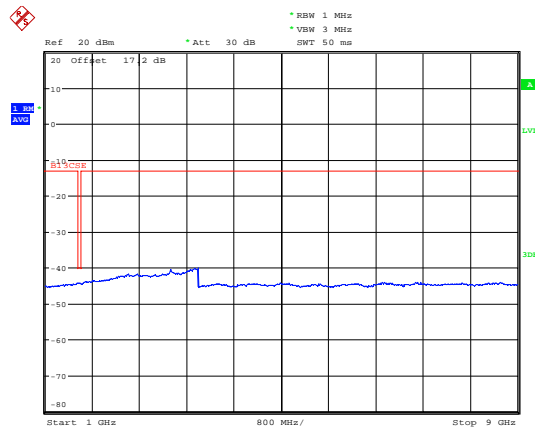

Date: 11 JUN 2020 22:36:42



LTE Band 13 10MHz CH-Middle 30MHz~1GHz

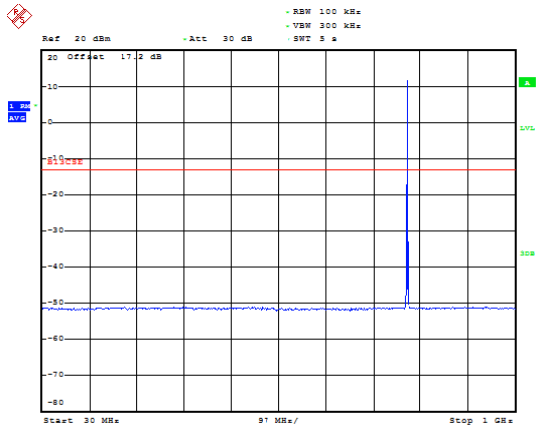

Date: 11 JUN 2020 22:35:45

LTE Band 13 10MHz CH-Middle 1GHz~9GHz

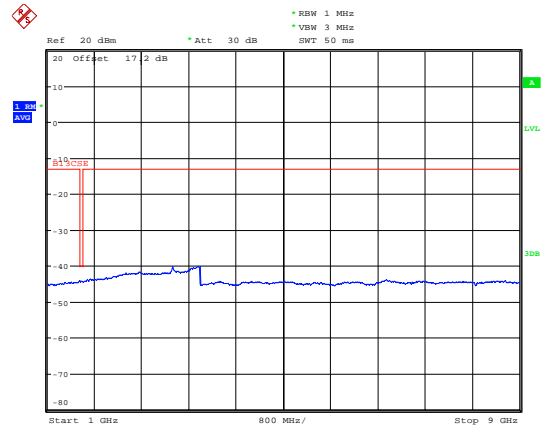

Date: 11 JUN 2020 22:36:50



LTE Band 66 1.4MHz CH-Low 30MHz~1GHz

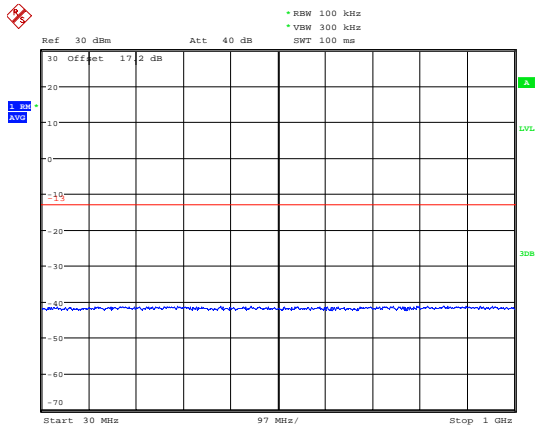

Date: 12.JUN.2020 22:08:18

LTE Band 66 1.4MHz CH-Low 1GHz ~20GHz

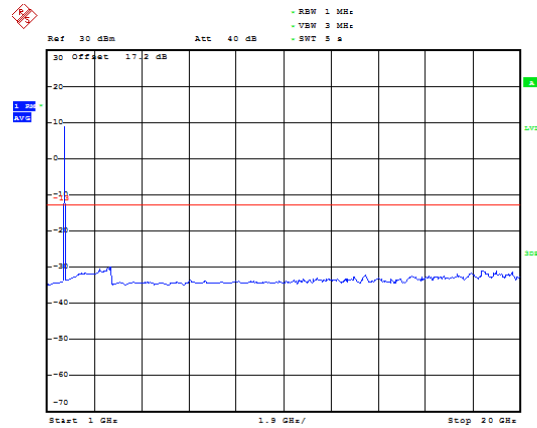

Date: 12.JUN.2020 22:11:22

LTE Band 66 1.4MHz CH- Middle 30MHz~1GHz

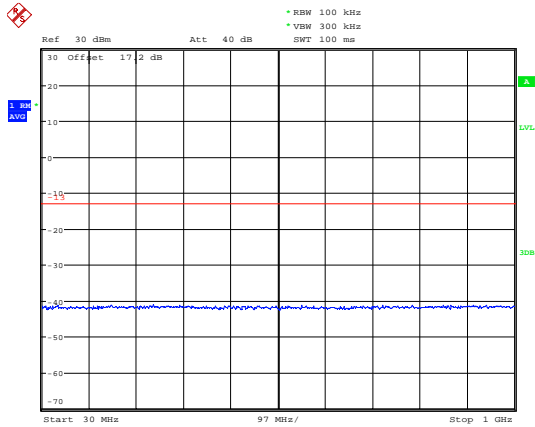

Date: 12.JUN.2020 22:08:28

LTE Band 66 1.4MHz CH- Middle 1GHz ~20GHz

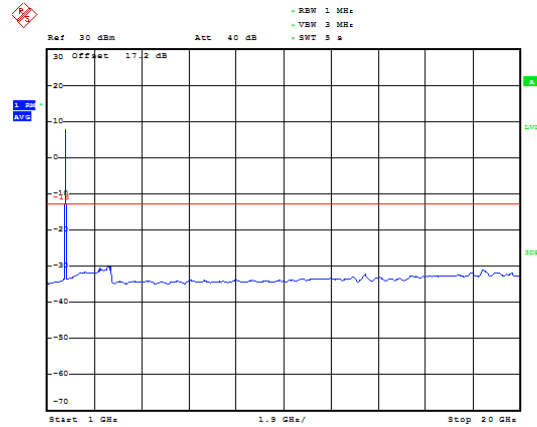

Date: 12.JUN.2020 22:12:33

LTE Band 66 1.4MHz CH-High 30MHz~1GHz

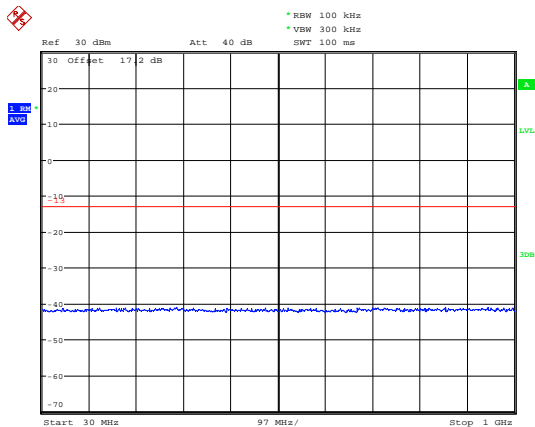

Date: 12.JUN.2020 22:08:37

LTE Band 66 1.4MHz CH-High 1GHz ~20GHz

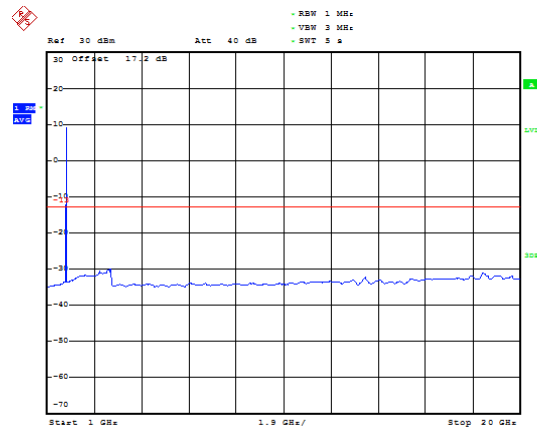

Date: 12.JUN.2020 22:12:59



LTE Band 66 3MHz CH-Low 30MHz~1GHz

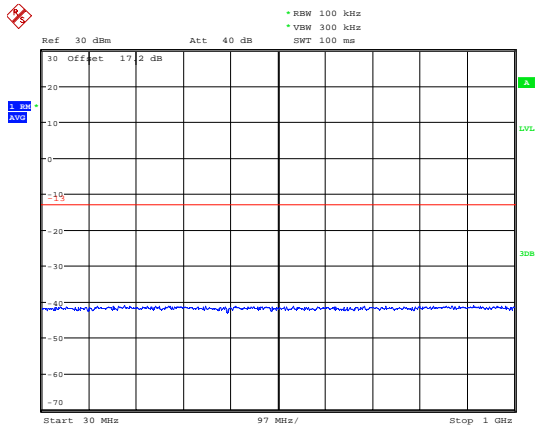

Date: 12.JUN.2020 22:08:45

LTE Band 66 3MHz CH-Low 1GHz ~20GHz

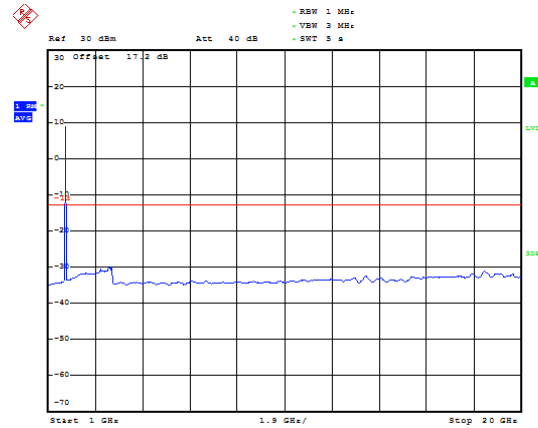

Date: 12.JUN.2020 22:13:55

LTE Band 66 3MHz CH- Middle 30MHz~1GHz

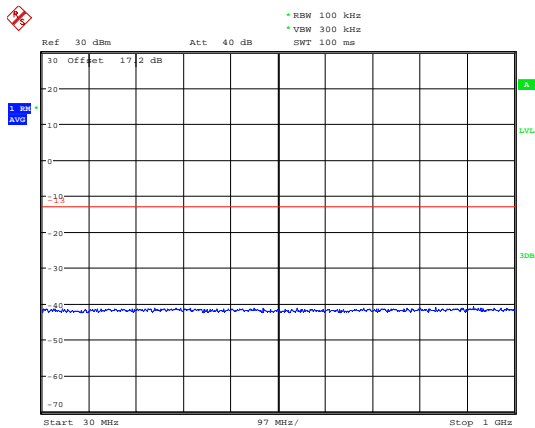

Date: 12.JUN.2020 22:08:53

LTE Band 66 3MHz CH- Middle 1GHz ~20GHz

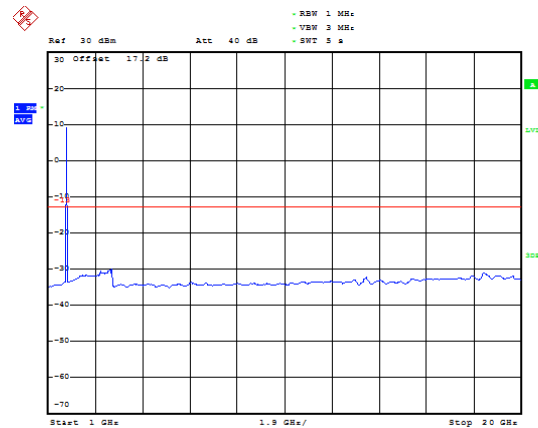

Date: 12.JUN.2020 22:14:14

LTE Band 66 3MHz CH-High 30MHz~1GHz

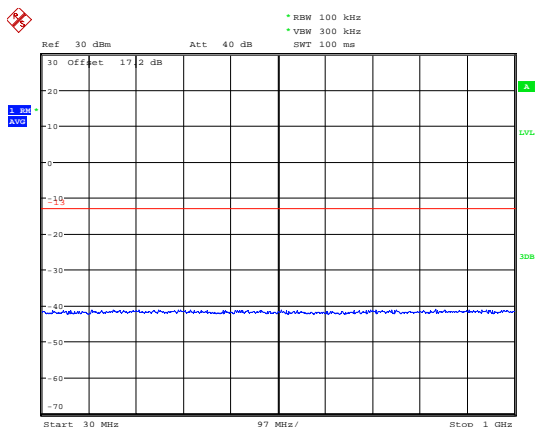

Date: 12.JUN.2020 22:09:01

LTE Band 66 3MHz CH-High 1GHz ~20GHz

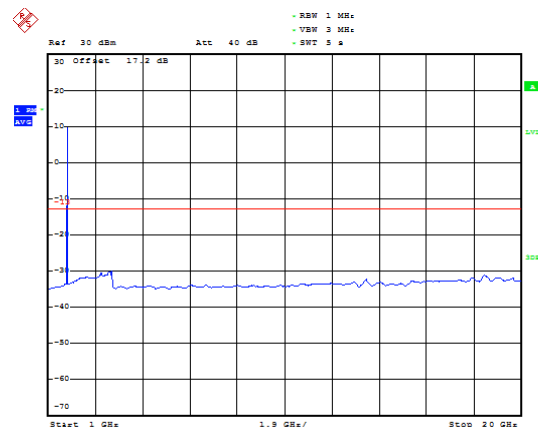

Date: 12.JUN.2020 22:14:49



LTE Band 66 5MHz CH-Low 30MHz~1GHz

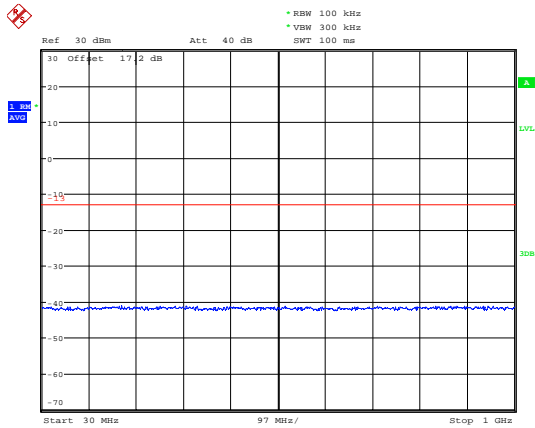

Date: 12.JUN.2020 22:09:11

LTE Band 66 5MHz CH-Low 1GHz ~20GHz

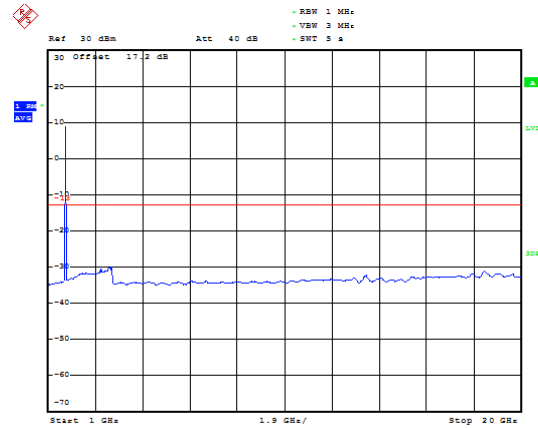

Date: 12.JUN.2020 22:15:44

LTE Band 66 5MHz CH- Middle 30MHz~1GHz

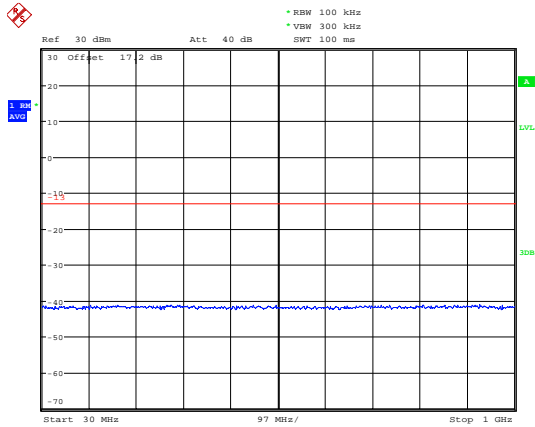

Date: 12.JUN.2020 22:09:19

LTE Band 66 5MHz CH- Middle 1GHz ~20GHz

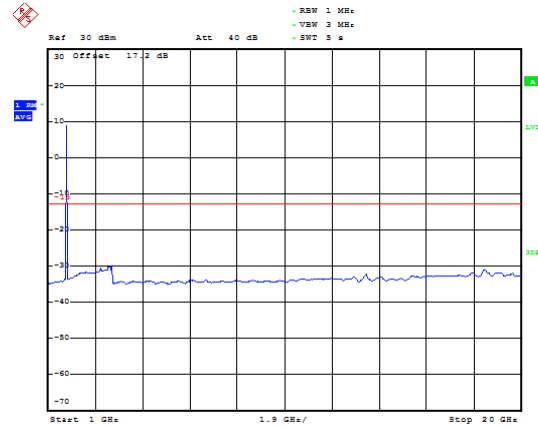

Date: 12.JUN.2020 22:16:02

LTE Band 66 5MHz CH-High 30MHz~1GHz

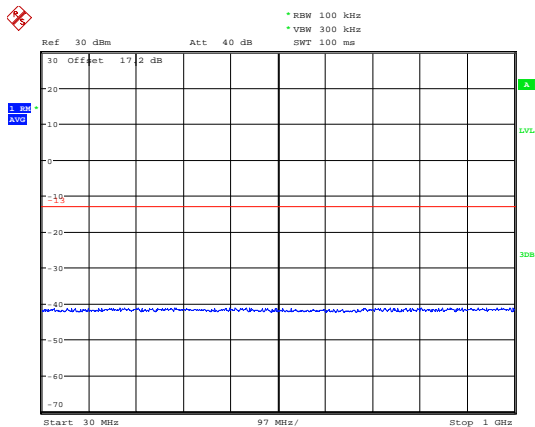

Date: 12.JUN.2020 22:09:27

LTE Band 66 5MHz CH-High 1GHz ~20GHz

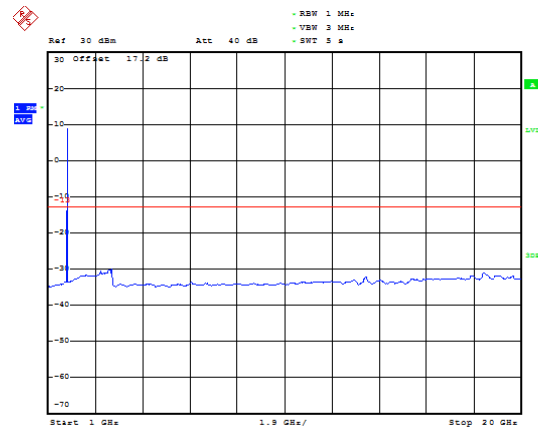

Date: 12.JUN.2020 22:16:27



LTE Band 66 10MHz CH-Low 30MHz~1GHz

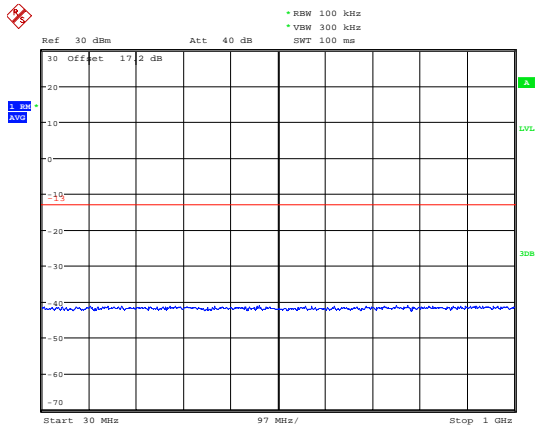

Date: 12 JUN 2020 22:09:35

LTE Band 66 10MHz CH-Low 1GHz ~20GHz

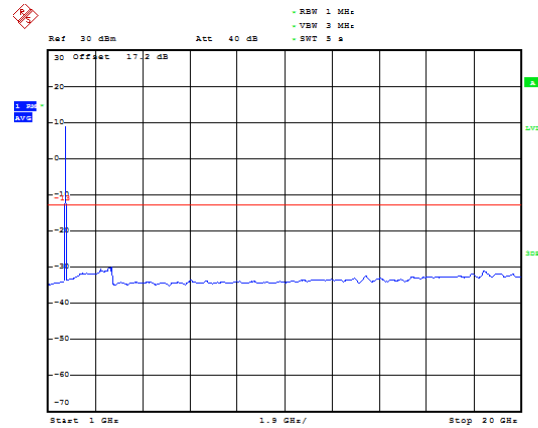

Date: 12 JUN 2020 22:17:00

LTE Band 66 10MHz CH- Middle 30MHz~1GHz

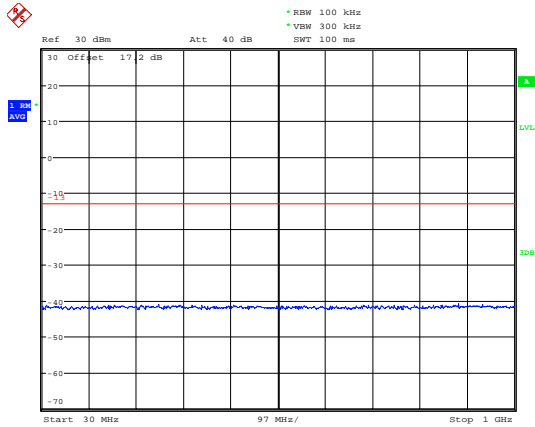

Date: 12 JUN 2020 22:09:44

LTE Band 66 10MHz CH- Middle 1GHz ~20GHz

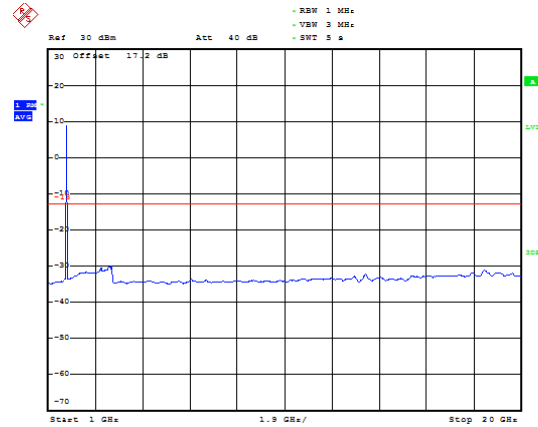

Date: 12 JUN 2020 22:17:19

LTE Band 66 10MHz CH-High 30MHz~1GHz

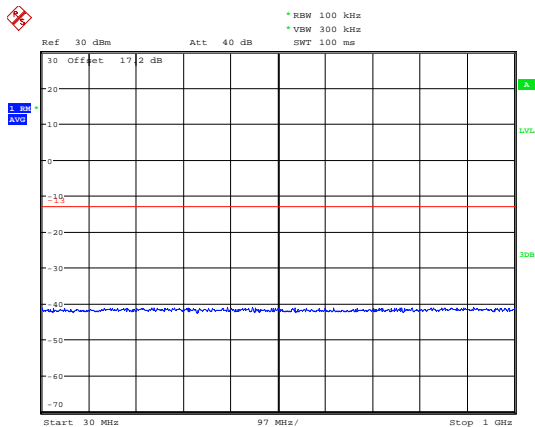

Date: 12 JUN 2020 22:09:51

LTE Band 66 10MHz CH-High 1GHz ~20GHz

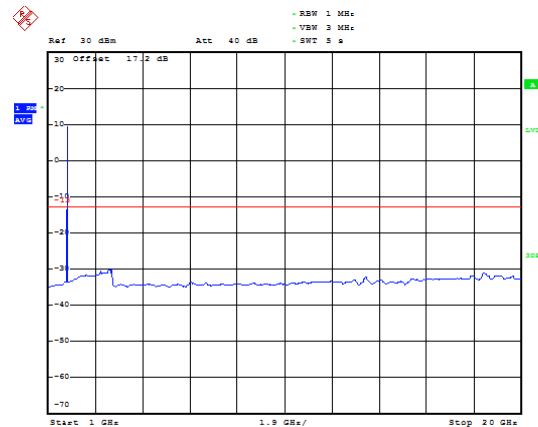

Date: 12 JUN 2020 22:17:37



LTE Band 66 15MHz CH-Low 30MHz~1GHz

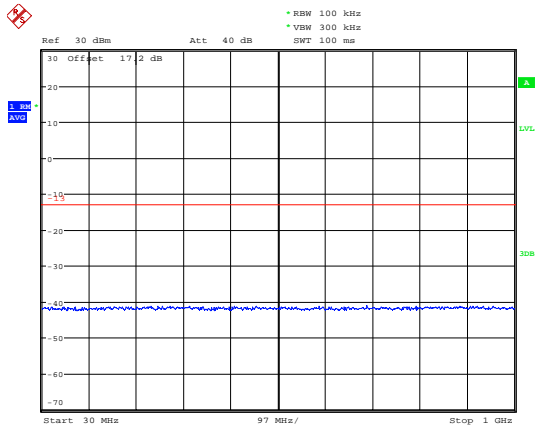

Date: 12.JUN.2020 22:10:05

LTE Band 66 15MHz CH-Low 1GHz ~20GHz

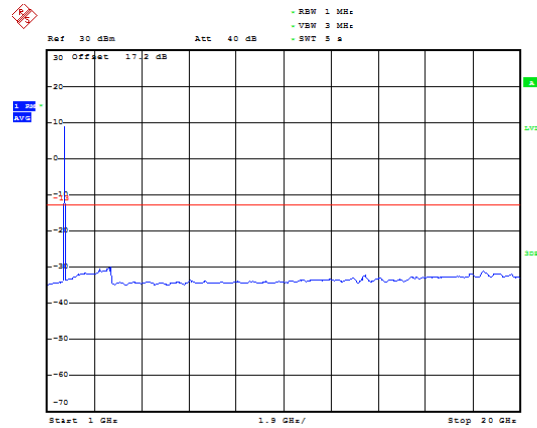

Date: 12.JUN.2020 22:18:37

LTE Band 66 15MHz CH- Middle 30MHz~1GHz

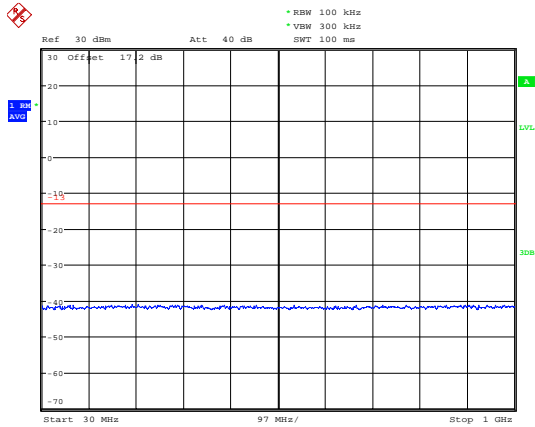

Date: 12.JUN.2020 22:10:13

LTE Band 66 15MHz CH- Middle 1GHz ~20GHz

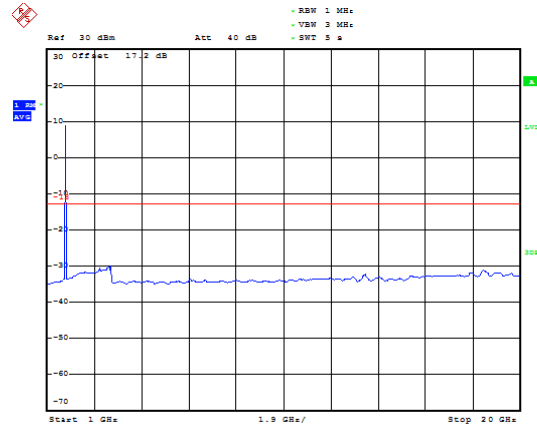

Date: 12.JUN.2020 22:18:54

LTE Band 66 15MHz CH-High 30MHz~1GHz

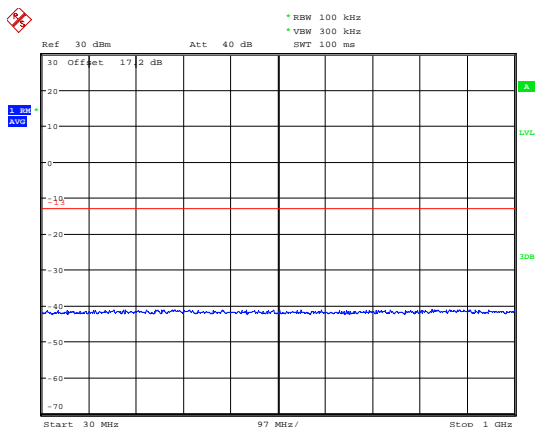

Date: 12.JUN.2020 22:10:21

LTE Band 66 15MHz CH-High 1GHz ~20GHz

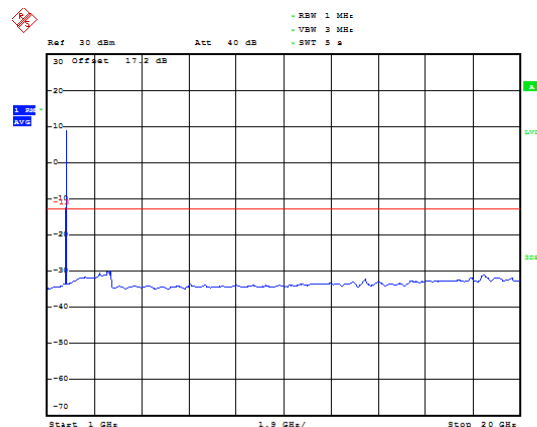

Date: 12.JUN.2020 22:19:11



LTE Band 66 20MHz CH-Low 30MHz~1GHz

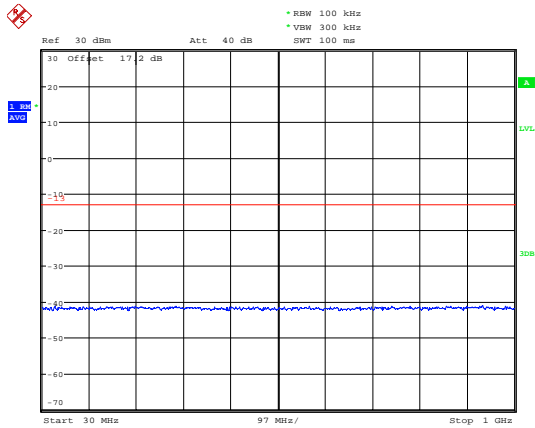

Date: 12 JUN 2020 22:10:29

LTE Band 66 20MHz CH-Low 1GHz ~20GHz

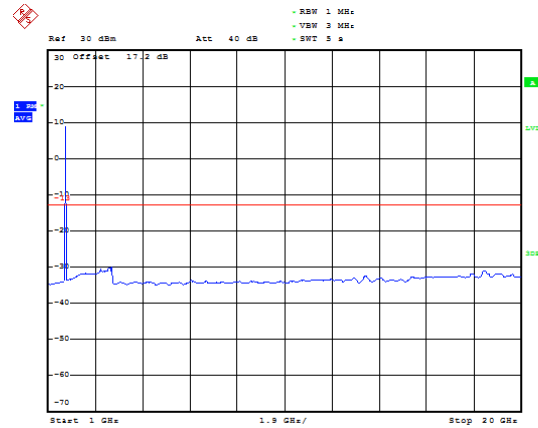

Date: 12 JUN 2020 22:20:13

LTE Band 66 20MHz CH- Middle 30MHz~1GHz

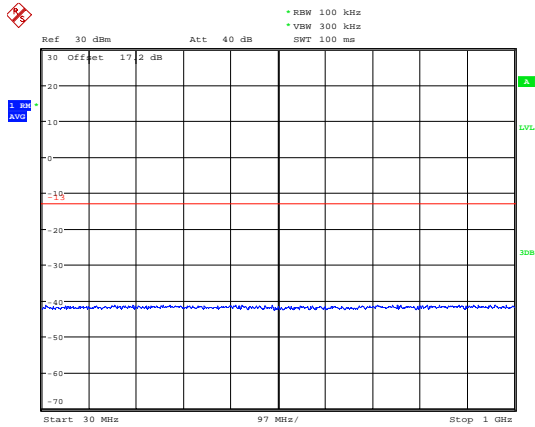

Date: 12 JUN 2020 22:10:37

LTE Band 66 20MHz CH- Middle 1GHz ~20GHz

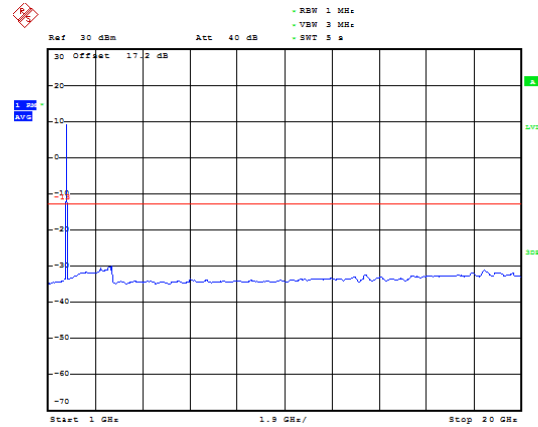

Date: 12 JUN 2020 22:20:33

LTE Band 66 20MHz CH-High 30MHz~1GHz

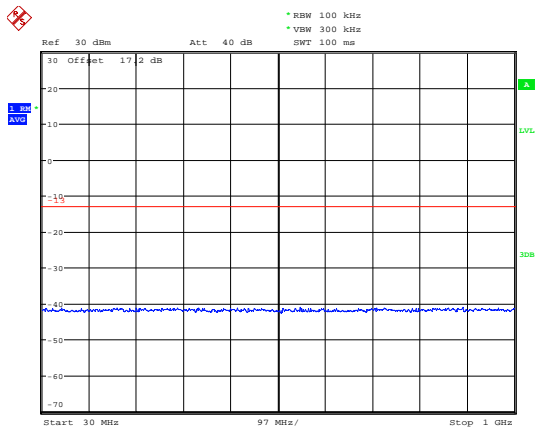

Date: 12 JUN 2020 22:10:50

LTE Band 66 20MHz CH-High 1GHz ~20GHz

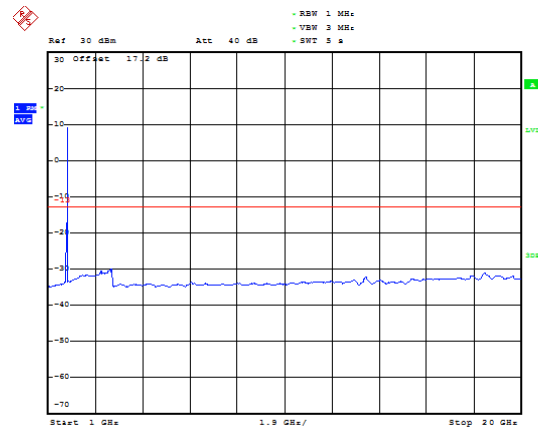

Date: 12 JUN 2020 22:24:36



LTE Band 85 5MHz CH-Low 30MHz~1GHz

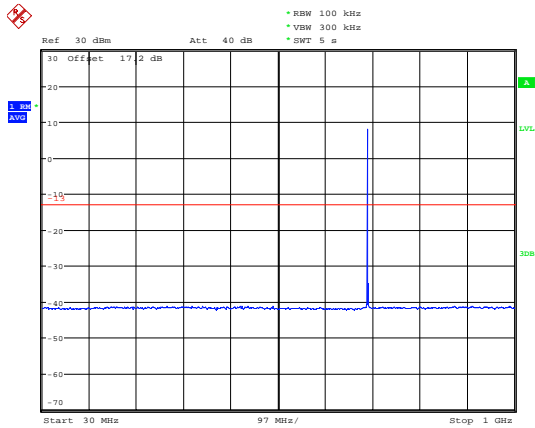

Date: 14.JUN.2020 15:26:50

LTE Band 85 5MHz CH-Low 1GHz~9GHz

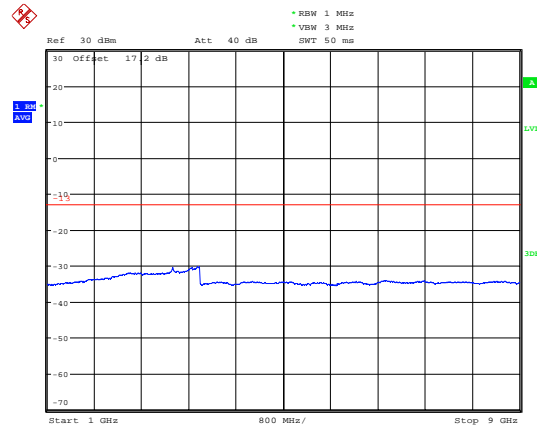

Date: 14.JUN.2020 15:28:10

LTE Band 85 5MHz CH-Middle 30MHz~1GHz

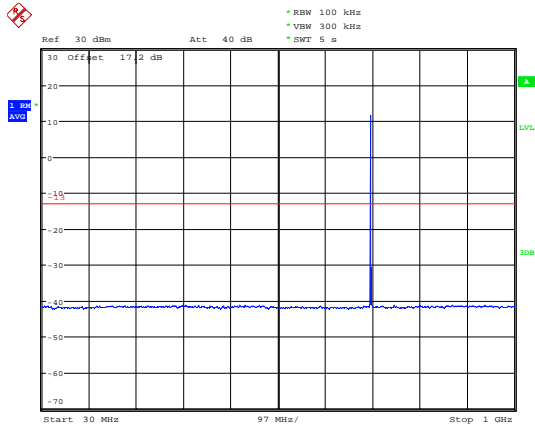

Date: 14.JUN.2020 15:27:16

LTE Band 85 5MHz CH-Middle 1GHz~9GHz

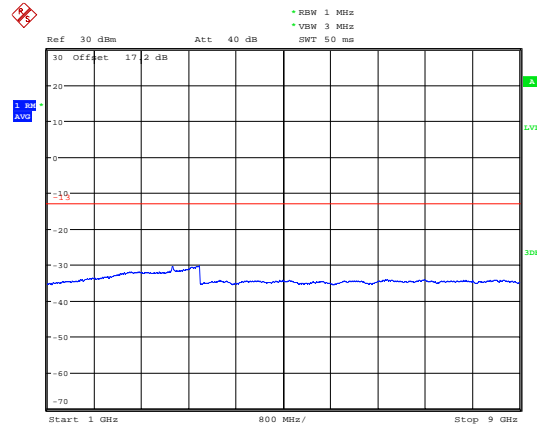

Date: 14.JUN.2020 15:28:19

LTE Band 85 5MHz CH-High 30MHz~1GHz

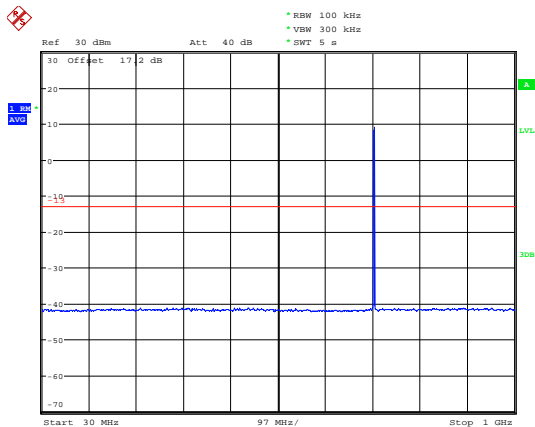

Date: 14.JUN.2020 15:27:46

LTE Band 85 5MHz CH-High 1GHz~9GHz

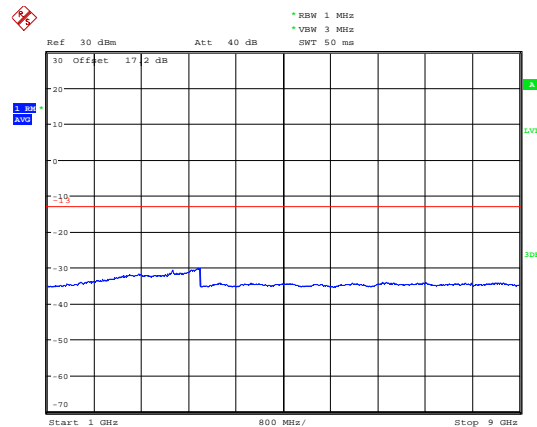

Date: 14.JUN.2020 15:28:28



LTE Band 85 10MHz CH- Low 30MHz~1GHz

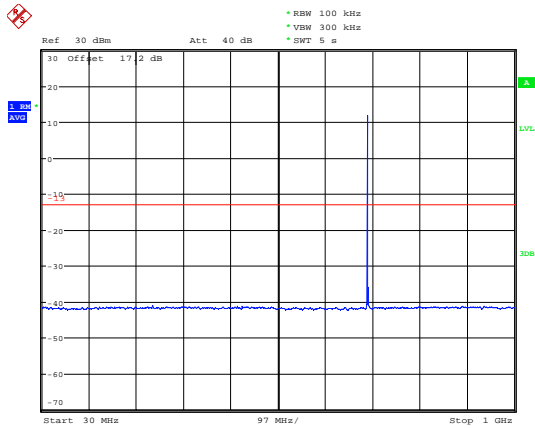

Date: 14.JUN.2020 15:25:16

LTE Band 85 10MHz CH- Low 1GHz~9GHz

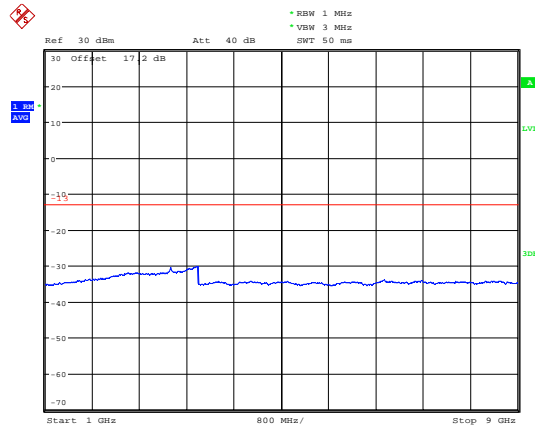

Date: 14.JUN.2020 15:28:38

LTE Band 85 10MHz CH-Middle 30MHz~1GHz

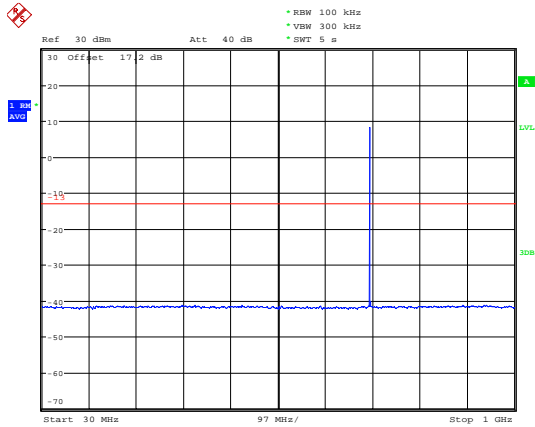

Date: 14.JUN.2020 15:23:41

LTE Band 85 10MHz CH-Middle 1GHz~9GHz

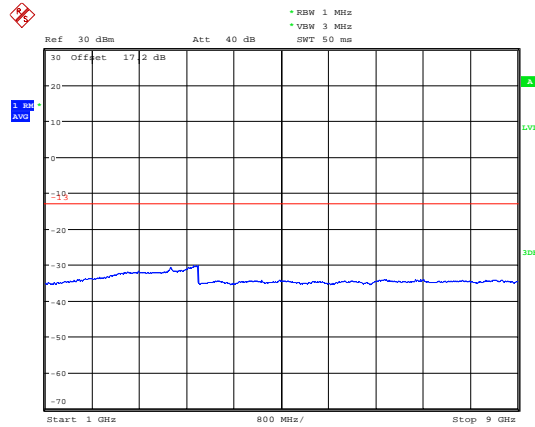

Date: 14.JUN.2020 15:28:47

LTE Band 85 10MHz CH- High 30MHz~1GHz

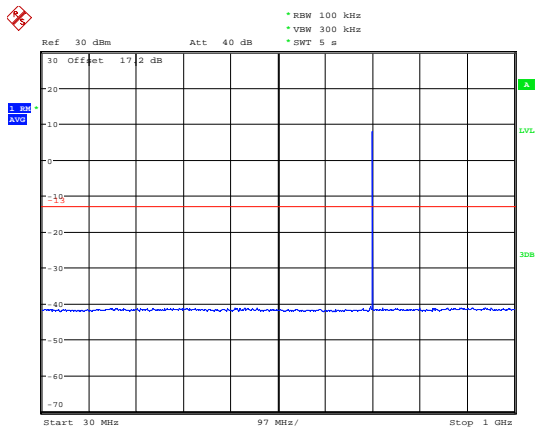

Date: 14.JUN.2020 15:25:50

LTE Band 85 10MHz CH- High 1GHz~9GHz

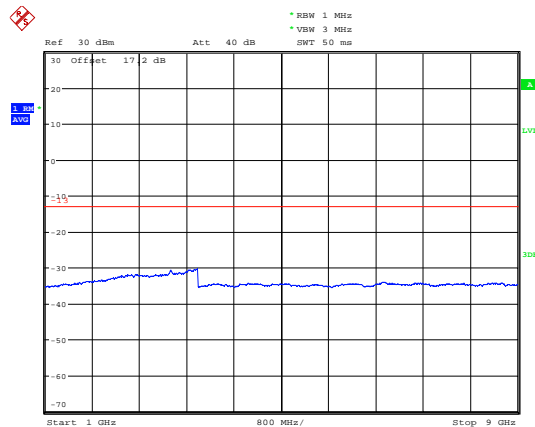

Date: 14.JUN.2020 15:28:55

5.7 Radiates Spurious Emission

Ambient condition

Temperature	Relative humidity	Pressure
23°C ~25°C	45%~50%	101.5kPa

Method of Measurement

1. The testing follows FCC KDB 971168 D01 v03r01 Section 5.8 and ANSI C63.26 (2015).
2. Below 1GHz: The EUT is placed on a turntable 0.8 meters above the ground in the chamber, 3 meter away from the antenna. The maximal emission value is acquired by adjusting the antenna height, polarisation and turntable azimuth. Normally, the height range of antenna is 1 m to 4 m, the azimuth range of turntable is 0° to 360°, and the receive antenna has two polarizations Vertical (V) and Horizontal (H). Above 1GHz: (Note: the FCC's permission to use 1.5m as an alternative per TCBC Conf call of Dec. 2, 2014.) The EUT is placed on a turntable 1.5 meters above the ground in the chamber, 3 meter away from the antenna. The maximal emission value is acquired by adjusting the antenna height, polarisation and turntable azimuth. Normally, the height range of antenna is 1 m to 4 m, the azimuth range of turntable is 0° to 360°, and the receive antenna has two polarizations Vertical (V) and Horizontal (H).
3. A loop antenna, A log-periodic antenna or horn antenna shall be substituted in place of the EUT. The log-periodic antenna will be driven by a signal generator and the level will be adjusted till the same power value on the spectrum analyzer or receiver. The level of the spurious emissions can be calculated through the level of the signal generator, cable loss, the gain of the substitution antenna and the reading of the spectrum analyzer or receiver.
4. The EUT is then put into continuously transmitting mode at its maximum power level during the test. Set Test Receiver or Spectrum RBW=200Hz,VBW=600Hz for 9kHz -150kHz , RBW=10kHz, VBW=30kHz 150kHz-30MHz ,RBW=100kHz,VBW=300kHz for 30MHz to 1GHz and RBW=1MHz, VBW=3MHz for above 1GHz And the maximum value of the receiver should be recorded as (Pr).
5. The EUT shall be replaced by a substitution antenna. In the chamber, an substitution antenna for the frequency band of interest is placed at the reference point of the chamber. An RF Signal source for the frequency band of interest is connected to the substitution antenna with a cable that has been constructed to not interfere with the radiation pattern of the antenna. A power (PMea) is applied to the input of the substitution antenna, and adjust the level of the signal generator output until the value of the receiver reach the previously recorded (Pr). The power of signal source (PMea) is recorded. The test should be performed by rotating the test item and adjusting the receiving antenna polarization.
6. A amplifier should be connected to the Signal Source output port. And the cable should be connect between the Amplifier and the Substitution Antenna. The cable loss (Pcl) ,the Substitution Antenna Gain (Ga) and the Amplifier Gain (PAg) should be recorded after test.
7. The measurement results are obtained as described below:
Power(EIRP)=PMea- PAg - Pcl + Ga
The measurement results are amend as described below:
Power(EIRP)=PMea- Pcl + Ga
8. This value is EIRP since the measurement is calibrated using an antenna of known gain (2.15 dBi) and known input power. ERP can be calculated from EIRP by subtracting the gain of the dipole, ERP

= EIRP-2.15dBi.

The modulation mode and RB allocation refer to section 5.1, using the maximum output power configuration.

Test setup

9KHz ~ 30MHz

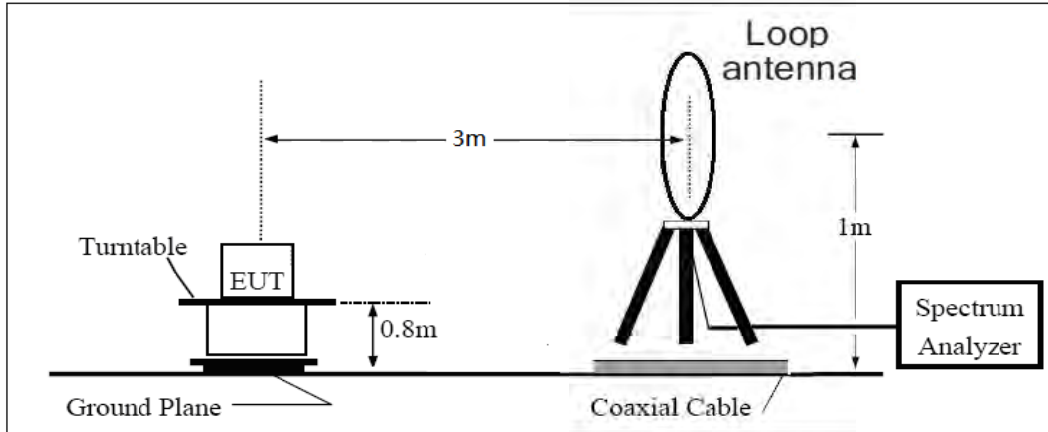

30MHz ~ 1GHz

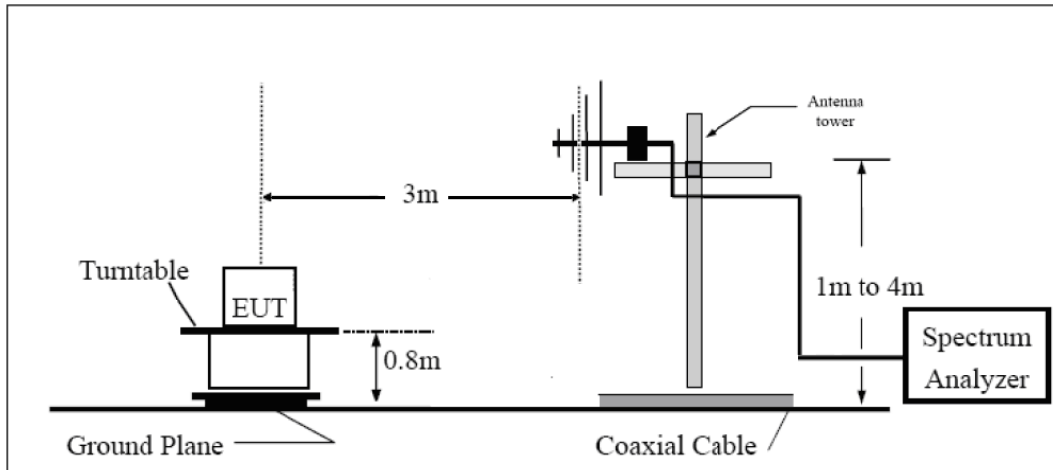

Above 1GHz

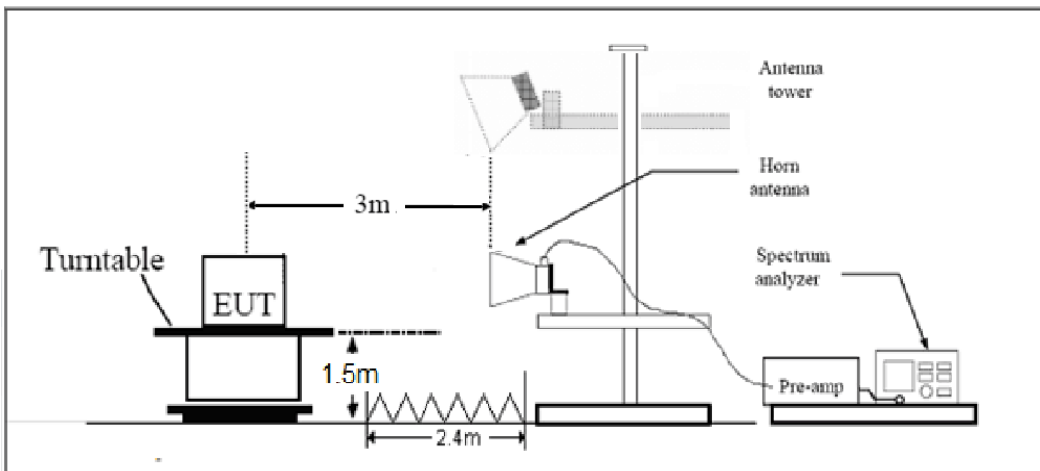

Note: Area side:2.4mX3.6m

**Limits**

Rule Part 27.53(h) specifies that “for operations in the 1695-1710 MHz, 1710-1755 MHz, 1755-1780 MHz, 1915-1920 MHz, 1995-2000 MHz, 2000-2020 MHz, 2110-2155 MHz, 2155-2180 MHz, and 2180-2200 bands, the power of any emission outside a licensee's frequency block shall be attenuated below the transmitter power (P) in watts by at least $43 + 10 \log_{10}(P)$ dB.”

Rule Part 27.53 (g) For operations in the 600 MHz band and the 698-746 MHz band, the power of any emission outside a licensee's frequency band(s) of operation shall be attenuated below the transmitter power (P) within the licensed band(s) of operation, measured in watts, by at least $43 + 10 \log(P)$ dB. Compliance with this provision is based on the use of measurement instrumentation employing a resolution bandwidth of 100 kilohertz or greater. However, in the 100 kilohertz bands immediately outside and adjacent to a licensee's frequency block, a resolution bandwidth of at least 30 kHz may be employed.

Rule Part 27.53(f) For operations in the 746-758 MHz, 775-788 MHz, and 805-806 MHz bands, emissions in the band 1559-1610 MHz shall be limited to -70 dBW/MHz equivalent isotropically radiated power (EIRP) for wideband signals, and -80 dBW EIRP for discrete emissions of less than 700 Hz bandwidth. For the purpose of equipment authorization, a transmitter shall be tested with an antenna that is representative of the type that will be used with the equipment in normal operation.

Part 27.53 (c) For operations in the 746-758 MHz band and the 776-788 MHz band, the power of any emission outside the licensee's frequency band(s) of operation shall be attenuated below the transmitter power (P) within the licensed band(s) of operation, measured in watts, in accordance with the following:

- (1) On any frequency outside the 746-758 MHz band, the power of any emission shall be attenuated outside the band below the transmitter power (P) by at least $43 + 10 \log(P)$ dB;
- (2) On any frequency outside the 776-788 MHz band, the power of any emission shall be attenuated outside the band below the transmitter power (P) by at least $43 + 10 \log(P)$ dB;
- (3) On all frequencies between 763-775 MHz and 793-805 MHz, by a factor not less than $76 + 10 \log(P)$ dB in a 6.25 kHz band segment, for base and fixed stations;
- (4) On all frequencies between 763-775 MHz and 793-805 MHz, by a factor not less than $65 + 10 \log(P)$ dB in a 6.25 kHz band segment, for mobile and portable stations;
- (5) Compliance with the provisions of paragraphs (c)(1) and (c)(2) of this section is based on the use of measurement instrumentation employing a resolution bandwidth of 100 kHz or greater. However, in the 100 kHz bands immediately outside and adjacent to the frequency block, a resolution bandwidth of at least 30 kHz may be employed;

Part 27.53(a)/(h)/(g) Limit		-13 dBm
Part 27.53(f) Limit	Limit out of the band 1559-1610 MHz	-13 dBm
	Limit in the band 1559-1610 MHz	-40 dBm

Measurement Uncertainty

The assessed measurement uncertainty to ensure 95% confidence level for the normal distribution is with the coverage factor $k = \pm 1.96$, $U = \pm 3.55$ dB.

**Test Result**

For radiated spurious emissions test, the worst mode (Middle Channel) should be reflected in the report.

Sweep the whole frequency band through the range from 9kHz to the 10th harmonic of the carrier, the emissions below the noise floor will not be recorded in the report.

LTE Band 4 QPSK 1.4MHz CH-Middle, RB 1

Harmonic	Frequency (MHz)	SG (dBm)	Cable Loss (dB)	Gain (dBi)	Antenna Polarization	EIRP Level (dBm)	Limit (dBm)	Margin (dB)	Azimuth (deg)
2	3464.3	-46.45	2.6	10.75	Horizontal	-38.30	-13.00	25.30	45
3	5197.5	-57.55	2.4	11.05	Horizontal	-48.90	-13.00	35.90	0
4	6930.0	-58.95	4.5	11.15	Horizontal	-52.30	-13.00	39.30	45
5	8662.5	-54.45	5.1	11.35	Horizontal	-48.20	-13.00	35.20	270
6	10395.0	-48.75	5.3	11.95	Horizontal	-42.10	-13.00	29.10	135
7	12127.5	-52.55	5.5	13.55	Horizontal	-44.50	-13.00	31.50	90
8	13860.0	-49.41	6.3	13.75	Horizontal	-41.96	-13.00	28.96	225
9	15592.5	-48.95	6.7	13.85	Horizontal	-41.80	-13.00	28.80	45
10	17325.0	-46.45	6.8	14.25	Horizontal	-39.00	-13.00	26.00	90

Note: 1. The other Spurious RF Radiated emissions level is no more than noise floor.
2. The worst emission was found in the antenna is Horizontal position.



LTE Band 4 QPSK 5MHz CH-Middle, RB 1

Harmonic	Frequency (MHz)	SG (dBm)	Cable Loss (dB)	Gain (dBi)	Antenna Polarization	EIRP Level (dBm)	Limit (dBm)	Margin (dB)	Azimuth (deg)
2	3460.5	-46.05	2.6	10.75	Horizontal	-37.90	-13.00	24.90	180
3	5191.5	-57.15	2.4	11.05	Horizontal	-48.50	-13.00	35.50	90
4	6930.0	-59.75	4.5	11.15	Horizontal	-53.10	-13.00	40.10	0
5	8662.5	-54.45	5.1	11.35	Horizontal	-48.20	-13.00	35.20	45
6	10395.0	-49.55	5.3	11.95	Horizontal	-42.90	-13.00	29.90	315
7	12127.5	-51.55	5.5	13.55	Horizontal	-43.50	-13.00	30.50	0
8	13860.0	-49.55	6.3	13.75	Horizontal	-42.10	-13.00	29.10	90
9	15592.5	-47.95	6.7	13.85	Horizontal	-40.80	-13.00	27.80	45
10	17325.0	-44.95	6.8	14.25	Horizontal	-37.50	-13.00	24.50	225

Note: 1. The other Spurious RF Radiated emissions level is no more than noise floor.
2. The worst emission was found in the antenna is Horizontal position.



LTE Band 4 QPSK 20MHz CH-Middle, RB 1

Harmonic	Frequency (MHz)	SG (dBm)	Cable Loss (dB)	Gain (dBi)	Antenna Polarization	EIRP Level (dBm)	Limit (dBm)	Margin (dB)	Azimuth (deg)
2	3447.8	-46.32	2.6	10.75	Horizontal	-38.17	-13.00	25.17	45
3	5170.9	-58.45	2.4	11.05	Horizontal	-49.80	-13.00	36.80	315
4	6930.0	-59.05	4.5	11.15	Horizontal	-52.40	-13.00	39.40	90
5	8662.5	-54.45	5.1	11.35	Horizontal	-48.20	-13.00	35.20	0
6	10395.0	-49.45	5.3	11.95	Horizontal	-42.80	-13.00	29.80	45
7	12127.5	-50.35	5.5	13.55	Horizontal	-42.30	-13.00	29.30	225
8	13860.0	-49.35	6.3	13.75	Horizontal	-41.90	-13.00	28.90	315
9	15592.5	-49.10	6.7	13.85	Horizontal	-41.95	-13.00	28.95	45
10	17325.0	-47.35	6.8	14.25	Horizontal	-39.90	-13.00	26.90	90

Note: 1.The other Spurious RF Radiated emissions level is no more than noise floor.

2. The worst emission was found in the antenna is Horizontal position.

LTE Band 12 QPSK 1.4MHz CH-Middle, RB 1

Harmonic	Frequency (MHz)	SG (dBm)	Cable Loss (dB)	Gain (dBi)	Antenna Polarization	ERP Level (dBm)	Limit (dBm)	Margin (dB)	Azimuth (deg)
2	1415.0	-66.80	2.00	10.75	Horizontal	-60.20	-13.00	47.20	45
3	2122.5	-66.99	2.51	11.05	Horizontal	-60.60	-13.00	47.60	135
4	2830.0	-60.75	4.20	11.15	Horizontal	-55.95	-13.00	42.95	225
5	3537.5	-57.10	5.20	11.15	Horizontal	-53.30	-13.00	40.30	180
6	4245.0	-55.20	5.50	11.95	Horizontal	-50.90	-13.00	37.90	225
7	4952.5	-55.10	5.70	13.55	Horizontal	-49.40	-13.00	36.40	45
8	5660.0	-55.10	6.30	13.75	Horizontal	-49.80	-13.00	36.80	315
9	6367.5	-56.10	6.80	13.85	Horizontal	-51.20	-13.00	38.20	90
10	7075.0	-56.40	6.90	14.25	Horizontal	-51.20	-13.00	38.20	45

Note: 1.The other Spurious RF Radiated emissions level is no more than noise floor.

2. The worst emission was found in the antenna is Horizontal position.



LTE Band 12 QPSK 5MHz CH-Middle, RB 1

Harmonic	Frequency (MHz)	SG (dBm)	Cable Loss (dB)	Gain (dBi)	Antenna Polarization	ERP Level (dBm)	Limit (dBm)	Margin (dB)	Azimuth (deg)
2	1410.6	-65.30	2.00	10.75	Horizontal	-58.70	-13.00	45.70	135
3	2115.9	-63.99	2.51	11.05	Horizontal	-57.60	-13.00	44.60	225
4	2821.2	-61.00	4.20	11.15	Horizontal	-56.20	-13.00	43.20	90
5	3512.5	-57.50	5.20	11.15	Horizontal	-53.70	-13.00	40.70	45
6	4215.0	-55.50	5.50	11.95	Horizontal	-51.20	-13.00	38.20	315
7	4917.5	-54.50	5.70	13.55	Horizontal	-48.80	-13.00	35.80	135
8	5620.0	-55.50	6.30	13.75	Horizontal	-50.20	-13.00	37.20	90
9	6322.5	-55.80	6.80	13.85	Horizontal	-50.90	-13.00	37.90	45
10	7025.0	-55.80	6.90	14.25	Horizontal	-50.60	-13.00	37.60	225

Note: 1. The other Spurious RF Radiated emissions level is no more than noise floor.
2. The worst emission was found in the antenna is Horizontal position.

LTE Band 12 QPSK 10MHz CH-Middle, RB 1

Harmonic	Frequency (MHz)	SG (dBm)	Cable Loss (dB)	Gain (dBi)	Antenna Polarization	ERP Level (dBm)	Limit (dBm)	Margin (dB)	Azimuth (deg)
2	1406.4	-66.40	2.00	10.75	Horizontal	-59.80	-13.00	46.80	45
3	2109.6	-66.29	2.51	11.05	Horizontal	-59.90	-13.00	46.90	315
4	2812.8	-60.79	4.20	11.15	Horizontal	-55.99	-13.00	42.99	90
5	3537.5	-56.30	5.20	11.15	Horizontal	-52.50	-13.00	39.50	90
6	4245.0	-55.80	5.50	11.95	Horizontal	-51.50	-13.00	38.50	0
7	4952.5	-53.50	5.70	13.55	Horizontal	-47.80	-13.00	34.80	45
8	5660.0	-53.90	6.30	13.75	Horizontal	-48.60	-13.00	35.60	315
9	6367.5	-56.60	6.80	13.85	Horizontal	-51.70	-13.00	38.70	45
10	7075.0	-56.50	6.90	14.25	Horizontal	-51.30	-13.00	38.30	90

Note: 1. The other Spurious RF Radiated emissions level is no more than noise floor.
2. The worst emission was found in the antenna is Horizontal position.



LTE Band 13 QPSK 5MHz CH-Middle, RB 1

Harmonic	Frequency (MHz)	SG (dBm)	Cable Loss (dB)	Gain (dBi)	Antenna Polarization	EIRP Level (dBm)	Limit (dBm)	Margin (dB)	Azimuth (deg)
2	1564.0	-64.74	2.51	11.05	Horizontal	-58.35	-40.00	18.35	45
Harmonic	Frequency (MHz)	SG (dBm)	Cable Loss (dB)	Gain (dBi)	Antenna Polarization	ERP Level (dBm)	Limit (dBm)	Margin (dB)	Azimuth (deg)
3	2346.0	-65.59	2.51	11.05	Horizontal	-59.20	-13.00	46.20	315
4	3128.0	-57.40	4.20	11.15	Horizontal	-52.60	-13.00	39.60	270
5	3910.0	-54.60	5.20	11.15	Horizontal	-50.80	-13.00	37.80	135
6	4692.0	-54.00	5.50	11.95	Horizontal	-49.70	-13.00	36.70	225
7	5474.0	-55.00	5.70	13.55	Horizontal	-49.30	-13.00	36.30	45
8	6256.0	-55.50	6.30	13.75	Horizontal	-50.20	-13.00	37.20	90
9	7038.0	-55.30	6.80	13.85	Horizontal	-50.40	-13.00	37.40	45
10	7820.0	-54.80	6.90	14.25	Horizontal	-49.60	-13.00	36.60	315

Note: 1.The other Spurious RF Radiated emissions level is no more than noise floor.
2. The worst emission was found in the antenna is Horizontal position.

LTE Band 13 QPSK 10MHz CH-Middle, RB 1

Harmonic	Frequency (MHz)	SG (dBm)	Cable Loss (dB)	Gain (dBi)	Antenna Polarization	ERP Level (dBm)	Limit (dBm)	Margin (dB)	Azimuth (deg)
2	1555.3	-65.80	2.00	10.75	Horizontal	-59.20	-13.00	46.20	270
3	2346.0	-62.89	2.51	11.05	Horizontal	-56.50	-13.00	43.50	90
4	3128.0	-57.40	4.20	11.15	Horizontal	-52.60	-13.00	39.60	270
5	3910.0	-54.60	5.20	11.15	Horizontal	-50.80	-13.00	37.80	135
6	4692.0	-54.00	5.50	11.95	Horizontal	-49.70	-13.00	36.70	225
7	5474.0	-55.00	5.70	13.55	Horizontal	-49.30	-13.00	36.30	45
8	6256.0	-55.50	6.30	13.75	Horizontal	-50.20	-13.00	37.20	90
9	7038.0	-55.30	6.80	13.85	Horizontal	-50.40	-13.00	37.40	45
10	7820.0	-54.80	6.90	14.25	Horizontal	-49.60	-13.00	36.60	315

Note: 1.The other Spurious RF Radiated emissions level is no more than noise floor.
2. The worst emission was found in the antenna is Horizontal position.



LTE Band 66 QPSK 1.4MHz CH-Middle, RB 1

Harmonic	Frequency (MHz)	SG (dBm)	Cable Loss (dB)	Gain (dBi)	Antenna Polarization	EIRP Level (dBm)	Limit (dBm)	Margin (dB)	Azimuth (deg)
2	3509.3	-52.45	2.6	10.75	Horizontal	-44.30	-13.00	31.30	90
3	5262.5	-56.05	2.4	11.05	Horizontal	-47.40	-13.00	34.40	180
4	7018.0	-56.95	4.5	11.15	Horizontal	-50.30	-13.00	37.30	270
5	8772.5	-53.75	5.1	11.35	Horizontal	-47.50	-13.00	34.50	45
6	10527.0	-50.65	5.3	11.95	Horizontal	-44.00	-13.00	31.00	90
7	12281.5	-50.25	5.5	13.55	Horizontal	-42.20	-13.00	29.20	0
8	14036.0	-49.75	6.3	13.75	Horizontal	-42.30	-13.00	29.30	315
9	15790.5	-48.45	6.7	13.85	Horizontal	-41.30	-13.00	28.30	45
10	17545.0	-46.85	6.8	14.25	Horizontal	-39.40	-13.00	26.40	90

Note: 1. The other Spurious RF Radiated emissions level is no more than noise floor.

2. The worst emission was found in the antenna is Horizontal position.

LTE Band 66 QPSK 5MHz CH-Middle, RB 1

Harmonic	Frequency (MHz)	SG (dBm)	Cable Loss (dB)	Gain (dBi)	Antenna Polarization	EIRP Level (dBm)	Limit (dBm)	Margin (dB)	Azimuth (deg)
2	3486.0	-49.25	2.6	10.75	Horizontal	-41.10	-13.00	28.10	0
3	5229.0	-56.35	2.4	11.05	Horizontal	-47.70	-13.00	34.70	225
4	6972.0	-59.25	4.5	11.15	Horizontal	-52.60	-13.00	39.60	45
5	8715.0	-54.85	5.1	11.35	Horizontal	-48.60	-13.00	35.60	135
6	10458.0	-50.65	5.3	11.95	Horizontal	-44.00	-13.00	31.00	315
7	12201.0	-50.95	5.5	13.55	Horizontal	-42.90	-13.00	29.90	225
8	13944.0	-49.43	6.3	13.75	Horizontal	-41.98	-13.00	28.98	90
9	15687.0	-48.85	6.7	13.85	Horizontal	-41.70	-13.00	28.70	45
10	17430.0	-47.15	6.8	14.25	Horizontal	-39.70	-13.00	26.70	270

Note: 1. The other Spurious RF Radiated emissions level is no more than noise floor.

2. The worst emission was found in the antenna is Horizontal position.



LTE Band 66 QPSK 20MHz CH-Middle, RB 1

Harmonic	Frequency (MHz)	SG (dBm)	Cable Loss (dB)	Gain (dBi)	Antenna Polarization	EIRP Level (dBm)	Limit (dBm)	Margin (dB)	Azimuth (deg)
2	3472.9	-49.35	2.6	10.75	Horizontal	-41.20	-13.00	28.20	45
3	5209.0	-58.45	2.4	11.05	Horizontal	-49.80	-13.00	36.80	270
4	6945.8	-59.05	4.5	11.15	Horizontal	-52.40	-13.00	39.40	90
5	8682.0	-53.65	5.1	11.35	Horizontal	-47.40	-13.00	34.40	315
6	10418.6	-49.95	5.3	11.95	Horizontal	-43.30	-13.00	30.30	0
7	12455.0	-50.25	5.5	13.55	Horizontal	-42.20	-13.00	29.20	90
8	13891.5	-49.35	6.3	13.75	Horizontal	-41.90	-13.00	28.90	45
9	15627.0	-48.25	6.7	13.85	Horizontal	-41.10	-13.00	28.10	135
10	17364.4	-46.15	6.8	14.25	Horizontal	-38.70	-13.00	25.70	225

Note: 1.The other Spurious RF Radiated emissions level is no more than noise floor.
2. The worst emission was found in the antenna is Horizontal position.

LTE Band 85 QPSK 5MHz CH-Middle, RB 1

Harmonic	Frequency (MHz)	SG (dBm)	Cable Loss (dB)	Gain (dBi)	Antenna Polarization	ERP Level (dBm)	Limit (dBm)	Margin (dB)	Azimuth (deg)
2	1410.6	-66.55	2.00	10.75	Horizontal	-59.95	-13.00	46.95	225
3	2115.9	-67.49	2.51	11.05	Horizontal	-61.10	-13.00	48.10	90
4	2821.2	-60.70	4.20	11.15	Horizontal	-55.90	-13.00	42.90	315
5	3526.5	-57.10	5.20	11.15	Horizontal	-53.30	-13.00	40.30	315
6	4231.8	-55.60	5.50	11.95	Horizontal	-51.30	-13.00	38.30	90
7	4937.1	-54.80	5.70	13.55	Horizontal	-49.10	-13.00	36.10	45
8	5642.4	-56.00	6.30	13.75	Horizontal	-50.70	-13.00	37.70	315
9	6347.7	-55.10	6.80	13.85	Horizontal	-50.20	-13.00	37.20	180
10	7053.0	-56.00	6.90	14.25	Horizontal	-50.80	-13.00	37.80	225

Note: 1.The other Spurious RF Radiated emissions level is no more than noise floor.
2. The worst emission was found in the antenna is Horizontal position.



LTE Band 85 QPSK 10MHz CH-Middle, RB 1

Harmonic	Frequency (MHz)	SG (dBm)	Cable Loss (dB)	Gain (dBi)	Antenna Polarization	ERP Level (dBm)	Limit (dBm)	Margin (dB)	Azimuth (deg)
2	1405.3	-66.49	2.00	10.75	Horizontal	-59.89	-13.00	46.89	0
3	2108.0	-66.29	2.51	11.05	Horizontal	-59.90	-13.00	46.90	90
4	2810.8	-60.80	4.20	11.15	Horizontal	-56.00	-13.00	43.00	135
5	3513.5	-56.76	5.20	11.15	Horizontal	-52.96	-13.00	39.96	180
6	4216.2	-55.20	5.50	11.95	Horizontal	-50.90	-13.00	37.90	270
7	4918.9	-55.30	5.70	13.55	Horizontal	-49.60	-13.00	36.60	135
8	5621.6	-55.70	6.30	13.75	Horizontal	-50.40	-13.00	37.40	0
9	6324.3	-54.80	6.80	13.85	Horizontal	-49.90	-13.00	36.90	45
10	7027.0	-55.70	6.90	14.25	Horizontal	-50.50	-13.00	37.50	225

Note: 1. The other Spurious RF Radiated emissions level is no more than noise floor.

2. The worst emission was found in the antenna is Horizontal position.



6 Main Test Instruments

Name	Manufacturer	Type	Serial Number	Calibration Date	Expiration Date
Base Station Simulator	R&S	CMW500	113824	2020-05-18	2021-05-17
Power Splitter	Hua Xiang	SHX-GF2-2-13	10120101	/	/
Spectrum Analyzer	Key sight	N9010A	MY50210259	2020-05-18	2021-05-17
Signal Analyzer	R&S	FSV30	100815	2019-12-15	2020-12-14
Loop Antenna	SCHWARZBECK	FMZB1519	1519-047	2017-09-26	2020-09-25
Trilog Antenna	SCHWARZBECK	VUBL 9163	9163-201	2017-11-18	2020-11-17
Horn Antenna	R&S	HF907	100126	2018-07-07	2020-07-06
Horn Antenna	ETS-Lindgren	3160-09	00102643	2018-06-20	2020-06-19
Signal generator	R&S	SMB 100A	102594	2020-05-18	2021-05-17
Climatic Chamber	ESPEC	SU-242	93000506	2017-12-17	2020-12-16
Preamplifier	R&S	SCU18	102327	2020-05-18	2021-05-17
MOB COMMS DC SUPPLY	Keysight	66319D	MY43004105	2020-05-18	2021-05-17
RF Cable	Agilent	SMA 15cm	0001	2020-06-11	2020-12-10
Software	R&S	EMC32	9.26.0	/	/

*****END OF REPORT *****



ANNEX A: The EUT Appearance

The EUT Appearance are submitted separately.



ANNEX B: Test Setup Photos

The Test Setup Photos are submitted separately.



ANNEX C: Verify data

The Verify data are submitted separately.



ANNEX D: Product Change Description

The Product Change Description are submitted separately.