

FCC Measurement/Technical Report on

SARA-R510M8S

SARA-R510S

SARA-R500S

FCC ID: XPYUBX19KM01

IC: 8595A-UBX19KM01

Test Report Reference: MDE_UBLOX_2105_FCC_01

Test Laboratory:

7layers GmbH
Borsigstrasse 11
40880 Ratingen
Germany



Deutsche
Akkreditierungsstelle
D-PL-12140-01-01
D-PL-12140-01-02
D-PL-12140-01-03

Note:

The following test results relate only to the devices specified in this document. This report shall not be reproduced in parts without the written approval of the test laboratory.

7layers GmbH

Borsigstraße 11
40880 Ratingen, Germany
T +49 (0) 2102 749 0
F +49 (0) 2102 749 350

Geschäftsführer/
Managing Directors:
Frank Spiller
Bernhard Retka
Alexandre Norré-Oudard

Registergericht/registered:
Düsseldorf HRB 75554
USt-Id.-Nr./VAT-No. DE203159652
Steuer-Nr./TAX-No. 147/5869/0385

a Bureau Veritas
Group Company

www.7layers.com

Table of Contents

1	Applied Standards and Test Summary	4
1.1	Applied Standards	4
1.2	FCC-IC Correlation Table	5
1.3	Measurement Summary	8
2	Revision History / Signatures	26
3	Administrative Data	27
3.1	Testing Laboratory	27
3.2	Project Data	27
3.3	Applicant Data	27
3.4	Manufacturer Data	27
4	Test object Data	28
4.1	General EUT Description	28
4.2	EUT Main components	28
4.3	Ancillary Equipment	29
4.4	Auxiliary Equipment	29
4.5	EUT Setups	30
4.6	Operating Modes / Test Channels	30
4.7	Product labelling	32
5	Test Results	33
5.1	RF Output power	33
5.2	Frequency stability	38
5.3	Spurious emissions at antenna terminals	41
5.4	Field strength of spurious radiation	44
5.5	Emission and occupied bandwidth	52
5.6	Band edge compliance	55
5.7	Peak-average-ratio	58
5.8	RF Output power	60
5.9	Frequency stability	65
5.10	Spurious emissions at antenna terminal	67
5.11	Field strength of spurious radiation	70
5.12	Emission and occupied bandwidth	79
5.13	Band edge compliance	82
5.14	Peak to Average Ratio	85
5.15	RF Output Power	88
5.16	Frequency stability	102
5.17	Spurious emissions at antenna terminals	114
5.18	Field strength of spurious radiation	125
5.19	Emission and occupied bandwidth	149
5.20	Band edge compliance	158
5.21	Peak to Average Ratio	169
6	Test Equipment	178

7	Antenna Factors, Cable Loss and Sample Calculations	183
7.1	LISN R&S ESH3-Z5 (150 kHz – 30 MHz)	183
7.2	Antenna R&S HFH2-Z2 (9 kHz – 30 MHz)	184
7.3	Antenna R&S HL562 (30 MHz – 1 GHz)	185
7.4	Antenna R&S HF907 (1 GHz – 18 GHz)	186
7.5	Antenna EMCO 3160-09 (18 GHz – 26.5 GHz)	187
7.6	Antenna EMCO 3160-10 (26.5 GHz – 40 GHz)	188
8	Measurement Uncertainties	189
9	Photo Report	190

1 APPLIED STANDARDS AND TEST SUMMARY

1.1 APPLIED STANDARDS

Type of Authorization

Certification for an Industrial Signal Booster.

Applicable FCC Rules

Prepared in accordance with the requirements of FCC Rules and Regulations as listed in 47 CFR Ch.1 Parts 2 and 24, (10-1-19 Edition). The following subparts are applicable to the results in this test report.

Part 2, Subpart J - Equipment Authorization Procedures, Certification

Part 24, Subpart E – Broadband PCS

§ 24.232 – Power and antenna height limits

§ 24.235 – Frequency stability

§ 24.238 – Emission limitations for Broadband PCS equipment

Part 27; Miscellaneous Wireless Communications Services
Subpart C – Technical standards

§ 27.50 – Power and duty cycle limits

§ 27.53 – Emission limits

§ 27.54 – Frequency stability

Part 22, Subpart H – Cellular Radiotelephone Service

§ 22.905 – Channels for cellular service

§ 22.913 – Effective radiated power limits

§ 22.917 – Emission limitations for cellular equipment

The tests were selected and performed with reference to:

- FCC Public Notice 971168 applying “Measurement guidance for certification of licensed digital transmitters” 971168 D01 v03r01, 2018-04-09
- ANSI C63.26: 2015

1.2 FCC-IC CORRELATION TABLE

Correlation of measurement requirements for Cellular Mobile Devices from FCC and ISED Canada

Measurement	FCC reference	ISED reference
RF Output Power	§ 2.1046 § 24.232	RSS-GEN Issue 5, 6.12 RSS-133 Issue 6, 6.4
Peak-Average-Ratio	§ 24.232	RSS 133 Issue 6: 6.4
Emission and Occupied bandwidth	§ 2.1049	RSS-GEN Issue 5, 6.7
Spurious Emission at Antenna Terminals	§ 2.1051 § 24.238	RSS-GEN Issue 5, 6.13 RSS-133 Issue 6, 6.5
Band Edge Compliance	§ 2.1051 § 24.238	RSS-GEN Issue 5, 6.13 RSS-133 Issue 6, 6.5
Frequency stability	§ 2.1055 § 24.235	RSS-GEN Issue 5, 6.11 RSS-133 Issue 6: 6.3
Field strength of spurious radiation	§ 2.1053 § 24.236	RSS-GEN Issue 5, 6.13 RSS-133 Issue 6: 6.5

**Correlation of measurement requirements for
Cellular Mobile Devices
from
FCC and ISED Canada**

Measurement	FCC reference	ISED reference
RF Output Power	§ 2.1046 § 27.50	RSS-GEN Issue 5, 6.12 RSS-130 Issue 2, 4.6.2/4.6.3 RSS-139 Issue 3, 6.5 RSS-199 Issue 3, 4.4
Peak to Average-Ratio	§ 27.50	RSS-130 Issue 2: 4.6.1 RSS 139 Issue 3: 6.5 RSS-199 Issue 3, 4.4
Emission and Occupied bandwidth	§ 2.1049	RSS-GEN Issue 5, 6.7
Spurious Emission at Antenna Terminals	§ 2.1051 § 27.53	RSS-GEN Issue 5, 6.13 RSS-130 Issue 2: 4.7.1/4.7.2 RSS-139 Issue 3, 6.6 RSS-199 Issue 3, 4.5
Band Edge Compliance	§ 2.1051 § 27.53	RSS-GEN Issue 5, 6.13 RSS-130 Issue 2: 4.7.1/4.7.2 RSS-139 Issue 3, 6.6 RSS-199 Issue 3, 4.5
Frequency stability	§ 2.1055 § 27.54	RSS-GEN Issue 5, 6.11 RSS-130 Issue 2: 4.5 RSS-139 Issue 3: 6.4 RSS-199 Issue 3, 4.3
Field strength of spurious radiation	§ 2.1053 § 27.53	RSS-GEN Issue 5, 6.13 RSS-130 Issue 2: 4.7.1/4.7.2 RSS-139 Issue 3: 6.6 RSS-199 Issue 3, 4.5

**Correlation of measurement requirements for
Cellular Mobile Devices
from
FCC and ISED Canada**

Measurement	FCC reference	ISED reference
RF Output Power	§ 2.1046 § 22.913	RSS-GEN Issue 5, 6.12 RSS-132 Issue 3, 5.4
Peak-Average-Ratio	-	RSS 132 Issue 3: 5.4
Emission and Occupied bandwidth	§ 2.1049	RSS-GEN Issue 5, 6.7
Spurious Emission at Antenna Terminals	§ 2.1051 § 22.917	RSS-GEN Issue 5, 6.13 RSS-132 Issue 3, 5.5
Band Edge Compliance	§ 2.1051 § 22.917	RSS-GEN Issue 4, 6.13 RSS-132 Issue 3, 5.5
Frequency stability	§ 2.1055 § 22.355	RSS-GEN Issue 5, 6.11 RSS-132 Issue 3: 5.3
Field strength of spurious radiation	§ 2.1053 § 22.917	RSS-GEN Issue 5, 6.13 RSS-132 Issue 3: 5.5

1.3 MEASUREMENT SUMMARY

47 CFR CHAPTER I FCC PART 22 Subpart H § 2.1046 § 22.913

RF Output power

The measurement was performed according to ANSI C63.26: 2015

Final Result

OP-Mode	Setup	Date	FCC	IC
Technology, Radio Technology, Operating Frequency, ChBW, Ressource Blocks, Measurement method				
CAT-M1, eFDD 26 16QAM, mid channel, 1.4 MHz, 1, conducted	S01_AA01	2021-06-19	Passed	Passed
CAT-M1, eFDD 26 16QAM, mid channel, 1.4 MHz, 5, conducted	S01_AA01	2021-06-19	Passed	Passed
CAT-M1, eFDD 26 16QAM, mid channel, 10 MHz, 1, conducted	S01_AA01	2021-06-19	Passed	Passed
CAT-M1, eFDD 26 16QAM, mid channel, 10 MHz, 5, conducted	S01_AA01	2021-06-19	Passed	Passed
CAT-M1, eFDD 26 16QAM, mid channel, 3 MHz, 1, conducted	S01_AA01	2021-06-19	Passed	Passed
CAT-M1, eFDD 26 16QAM, mid channel, 3 MHz, 5, conducted	S01_AA01	2021-06-19	Passed	Passed
CAT-M1, eFDD 26 16QAM, mid channel, 5 MHz, 1, conducted	S01_AA01	2021-06-19	Passed	Passed
CAT-M1, eFDD 26 16QAM, mid channel, 5 MHz, 5, conducted	S01_AA01	2021-06-19	Passed	Passed
CAT-M1, eFDD 26 QPSK, mid channel, 1.4 MHz, 1, conducted	S01_AA01	2021-06-19	Passed	Passed
CAT-M1, eFDD 26 QPSK, mid channel, 1.4 MHz, 3, conducted	S01_AA01	2021-06-19	Passed	Passed
CAT-M1, eFDD 26 QPSK, mid channel, 1.4 MHz, 6, conducted	S01_AA01	2021-06-19	Passed	Passed
CAT-M1, eFDD 26 QPSK, mid channel, 10 MHz, 1, conducted	S01_AA01	2021-06-19	Passed	Passed
CAT-M1, eFDD 26 QPSK, mid channel, 10 MHz, 3, conducted	S01_AA01	2021-06-19	Passed	Passed
CAT-M1, eFDD 26 QPSK, mid channel, 10 MHz, 6, conducted	S01_AA01	2021-06-19	Passed	Passed
CAT-M1, eFDD 26 QPSK, mid channel, 3 MHz, 1, conducted	S01_AA01	2021-06-19	Passed	Passed
CAT-M1, eFDD 26 QPSK, mid channel, 3 MHz, 3, conducted	S01_AA01	2021-06-19	Passed	Passed
CAT-M1, eFDD 26 QPSK, mid channel, 3 MHz, 6, conducted	S01_AA01	2021-06-19	Passed	Passed
CAT-M1, eFDD 26 QPSK, mid channel, 5 MHz, 1, conducted	S01_AA01	2021-06-19	Passed	Passed
CAT-M1, eFDD 26 QPSK, mid channel, 5 MHz, 3, conducted	S01_AA01	2021-06-19	Passed	Passed
CAT-M1, eFDD 26 QPSK, mid channel, 5 MHz, 6, conducted	S01_AA01	2021-06-19	Passed	Passed
CAT-M1, eFDD 5 16QAM, mid channel, 1.4 MHz, 1, conducted	S01_AA01	2021-06-19	Passed	Passed
CAT-M1, eFDD 5 16QAM, mid channel, 1.4 MHz, 5, conducted	S01_AA01	2021-06-19	Passed	Passed
CAT-M1, eFDD 5 16QAM, mid channel, 10 MHz, 1, conducted	S01_AA01	2021-06-19	Passed	Passed
CAT-M1, eFDD 5 16QAM, mid channel, 10 MHz, 5, conducted	S01_AA01	2021-06-19	Passed	Passed
CAT-M1, eFDD 5 16QAM, mid channel, 3 MHz, 1, conducted	S01_AA01	2021-06-19	Passed	Passed
CAT-M1, eFDD 5 16QAM, mid channel, 3 MHz, 5, conducted	S01_AA01	2021-06-19	Passed	Passed
CAT-M1, eFDD 5 16QAM, mid channel, 5 MHz, 1, conducted	S01_AA01	2021-06-19	Passed	Passed
CAT-M1, eFDD 5 16QAM, mid channel, 5 MHz, 5, conducted	S01_AA01	2021-06-19	Passed	Passed
CAT-M1, eFDD 5 QPSK, mid channel, 1.4 MHz, 1, conducted	S01_AA01	2021-06-19	Passed	Passed
CAT-M1, eFDD 5 QPSK, mid channel, 1.4 MHz, 3, conducted	S01_AA01	2021-06-19	Passed	Passed
CAT-M1, eFDD 5 QPSK, mid channel, 1.4 MHz, 6, conducted	S01_AA01	2021-06-19	Passed	Passed
CAT-M1, eFDD 5 QPSK, mid channel, 10 MHz, 1, conducted	S01_AA01	2021-06-19	Passed	Passed
CAT-M1, eFDD 5 QPSK, mid channel, 10 MHz, 3, conducted	S01_AA01	2021-06-19	Passed	Passed
CAT-M1, eFDD 5 QPSK, mid channel, 10 MHz, 6, conducted	S01_AA01	2021-06-19	Passed	Passed
CAT-M1, eFDD 5 QPSK, mid channel, 3 MHz, 1, conducted	S01_AA01	2021-06-19	Passed	Passed
CAT-M1, eFDD 5 QPSK, mid channel, 3 MHz, 3, conducted	S01_AA01	2021-06-19	Passed	Passed
CAT-M1, eFDD 5 QPSK, mid channel, 3 MHz, 6, conducted	S01_AA01	2021-06-19	Passed	Passed
CAT-M1, eFDD 5 QPSK, mid channel, 5 MHz, 1, conducted	S01_AA01	2021-06-19	Passed	Passed
CAT-M1, eFDD 5 QPSK, mid channel, 5 MHz, 6, conducted	S01_AA01	2021-06-19	Passed	Passed

47 CFR CHAPTER I FCC PART 22 Subpart H § 2.1046 § 22.913

RF Output power

The measurement was performed according to ANSI C63.26: 2015

Final Result

OP-Mode	Setup	Date	FCC	IC
Technology, Radio Technology, Operating Frequency, ChBW, Ressource Blocks, Measurement method				
NB-IoT, eFDD 5 BPSK, high channel, 0.2 MHz, 1, conducted	S01_AB01	2021-05-22	Passed	Passed
NB-IoT, eFDD 5 BPSK, low channel, 0.2 MHz, 1, conducted	S01_AB01	2021-05-22	Passed	Passed
NB-IoT, eFDD 5 BPSK, mid channel, 0.2 MHz, 1, conducted	S01_AB01	2021-05-22	Passed	Passed
NB-IoT, eFDD 5 QPSK, high channel, 0.2 MHz, 1, conducted	S01_AB01	2021-05-22	Passed	Passed
NB-IoT, eFDD 5 QPSK, high channel, 0.2 MHz, 12, conducted	S01_AB01	2021-05-22	Passed	Passed
NB-IoT, eFDD 5 QPSK, high channel, 0.2 MHz, 3, conducted	S01_AB01	2021-05-22	Passed	Passed
NB-IoT, eFDD 5 QPSK, high channel, 0.2 MHz, 6, conducted	S01_AB01	2021-05-22	Passed	Passed
NB-IoT, eFDD 5 QPSK, low channel, 0.2 MHz, 1, conducted	S01_AB01	2021-05-22	Passed	Passed
NB-IoT, eFDD 5 QPSK, low channel, 0.2 MHz, 12, conducted	S01_AB01	2021-05-22	Passed	Passed
NB-IoT, eFDD 5 QPSK, low channel, 0.2 MHz, 3, conducted	S01_AB01	2021-05-22	Passed	Passed
NB-IoT, eFDD 5 QPSK, low channel, 0.2 MHz, 6, conducted	S01_AB01	2021-05-22	Passed	Passed
NB-IoT, eFDD 5 QPSK, mid channel, 0.2 MHz, 1, conducted	S01_AB01	2021-05-22	Passed	Passed
NB-IoT, eFDD 5 QPSK, mid channel, 0.2 MHz, 12, conducted	S01_AB01	2021-05-22	Passed	Passed
NB-IoT, eFDD 5 QPSK, mid channel, 0.2 MHz, 3, conducted	S01_AB01	2021-05-22	Passed	Passed
NB-IoT, eFDD 5 QPSK, mid channel, 0.2 MHz, 6, conducted	S01_AB01	2021-05-22	Passed	Passed

47 CFR CHAPTER I FCC PART 22 Subpart H § 2.1055 § 22.355

Frequency stability

The measurement was performed according to ANSI C63.26: 2015

Final Result

OP-Mode	Setup	Date	FCC	IC
Technology, Radio Technology, Operating Frequency, ChBW, Ressource Blocks, Measurement method				
NB-IoT, eFDD 5 QPSK, mid channel, 0.2 MHz, 1, conducted	S01_AB01	2021-05-16	Passed	Passed

47 CFR CHAPTER I FCC PART 22 Subpart H § 2.1051 § 22.917

Spurious emissions at antenna terminals

The measurement was performed according to ANSI C63.26: 2015

Final Result

OP-Mode	Setup	Date	FCC	IC
Technology, Radio Technology, Operating Frequency, ChBW, Ressource Blocks, Measurement method				
NB-IoT, eFDD 5 QPSK, high channel, 0.2 MHz, 1, conducted	S01_AB02	2021-05-07	Passed	Passed
NB-IoT, eFDD 5 QPSK, low channel, 0.2 MHz, 1, conducted	S01_AB02	2021-05-07	Passed	Passed
NB-IoT, eFDD 5 QPSK, mid channel, 0.2 MHz, 1, conducted	S01_AB01	2021-11-06	Passed	Passed

47 CFR CHAPTER I FCC PART 22 Subpart H § 2.1053 § 22.917

Field strength of spurious radiation

The measurement was performed according to ANSI C63.26: 2015

Final Result

OP-Mode	Setup	Date	FCC	IC
Technology, Radio Technology, Operating Frequency, ChBW, Ressource Blocks, Measurement method				
CAT-M1, eFDD 5 QPSK, mid channel, 1.4 MHz, 1, radiated	S01_AA01	2021-06-21	Passed	Passed
CAT-M1, eFDD 26 QPSK, mid channel, 1.4 MHz, 1, radiated	S01_AA01	2021-06-21	Passed	Passed
NB-IoT, eFDD 5 QPSK, high channel, 0.2 MHz, 1, radiated	S01_AB01	2021-07-07	Passed	Passed
NB-IoT, eFDD 5 QPSK, low channel, 0.2 MHz, 1, radiated	S01_AB01	2021-07-07	Passed	Passed

47 CFR CHAPTER I FCC PART 22 § 2.1053 § 22.917

Subpart H

Field strength of spurious radiation

The measurement was performed according to ANSI C63.26: 2015

Final Result

OP-Mode	Setup	Date	FCC	IC
Technology, Radio Technology, Operating Frequency, ChBW, Ressource Blocks, Measurement method				
NB-IoT, eFDD 5 QPSK, mid channel, 0.2 MHz, 1, radiated	S01_AB01	2021-07-07	Passed	Passed
NB-IoT, eFDD 5 QPSK, mid channel, 0.2 MHz, 1, radiated	S01_BB01	2021-06-27	Passed	Passed
NB-IoT, eFDD 5 QPSK, mid channel, 0.2 MHz, 1, radiated	S01_CB01	2021-06-27	Passed	Passed

47 CFR CHAPTER I FCC PART 22 Subpart H § 2.1049

Emission and occupied bandwidth

The measurement was performed according to ANSI C63.26: 2015

Final Result

OP-Mode	Setup	Date	FCC	IC
Technology, Radio Technology, Operating Frequency, ChBW, Ressource Blocks, Measurement method				
NB-IoT, eFDD 5 BPSK, high channel, 0.2 MHz, 1, conducted	S01_AB01	2021-05-14	Passed	Passed
NB-IoT, eFDD 5 BPSK, low channel, 0.2 MHz, 1, conducted	S01_AB01	2021-05-14	Passed	Passed
NB-IoT, eFDD 5 BPSK, mid channel, 0.2 MHz, 1, conducted	S01_AB01	2021-05-14	Passed	Passed
NB-IoT, eFDD 5 QPSK, high channel, 0.2 MHz, 12, conducted	S01_AB01	2021-05-14	Passed	Passed
NB-IoT, eFDD 5 QPSK, low channel, 0.2 MHz, 12, conducted	S01_AB02	2021-05-07	Passed	Passed
NB-IoT, eFDD 5 QPSK, mid channel, 0.2 MHz, 12, conducted	S01_AB01	2021-05-14	Passed	Passed

47 CFR CHAPTER I FCC PART 22 Subpart H § 2.1051 § 22.917

Band edge compliance

The measurement was performed according to ANSI C63.26: 2015

Final Result

OP-Mode	Setup	Date	FCC	IC
Technology, Radio Technology, Operating Frequency, ChBW, Ressource Blocks, Measurement method				
NB-IoT, eFDD 5 BPSK, high channel, 0.2 MHz, 1, conducted	S01_AB02	2021-05-07	Passed	Passed
NB-IoT, eFDD 5 BPSK, low channel, 0.2 MHz, 1, conducted	S01_AB01	2021-05-26	Passed	Passed
NB-IoT, eFDD 5 QPSK, high channel, 0.2 MHz, 12, conducted	S01_AB01	2021-05-26	Passed	Passed
NB-IoT, eFDD 5 QPSK, low channel, 0.2 MHz, 12, conducted	S01_AB01	2021-05-26	Passed	Passed

47 CFR CHAPTER I FCC PART 22 Subpart H -

Peak-average-ratio

The measurement was performed according to ANSI C63.26: 2015

Final Result

OP-Mode	Setup	Date	FCC	IC
Technology, Radio Technology, Operating Frequency, ChBW, Ressource Blocks, Measurement method				
NB-IoT, eFDD 5 BPSK, high channel, 0.2 MHz, 1, conducted	S01_AB02	2021-05-07	Passed	Passed
NB-IoT, eFDD 5 BPSK, low channel, 0.2 MHz, 1, conducted	S01_AB02	2021-05-07	Passed	Passed
NB-IoT, eFDD 5 BPSK, mid channel, 0.2 MHz, 1, conducted	S01_AB02	2021-05-07	Passed	Passed
NB-IoT, eFDD 5 QPSK, high channel, 0.2 MHz, 12, conducted	S01_AB01	2021-01-07	Passed	Passed
NB-IoT, eFDD 5 QPSK, low channel, 0.2 MHz, 12, conducted	S01_AB01	2021-01-07	Passed	Passed
NB-IoT, eFDD 5 QPSK, mid channel, 0.2 MHz, 12, conducted	S01_AB01	2021-01-07	Passed	Passed

47 CFR CHAPTER I FCC PART 24 Subpart E § 2.1046 § 24.232

RF Output power

The measurement was performed according to ANSI C63.26: 2015

Final Result

OP-Mode

Technology, Radio Technology, Operating Frequency, ChBW, Ressource Blocks, Measurement method

OP-Mode	Setup	Date	FCC	IC
CAT-M1, eFDD 2 16QAM, mid channel, 1.4 MHz, 1, conducted	S01_AA01	2021-06-19	Passed	Passed
CAT-M1, eFDD 2 16QAM, mid channel, 1.4 MHz, 5, conducted	S01_AA01	2021-06-19	Passed	Passed
CAT-M1, eFDD 2 16QAM, mid channel, 10 MHz, 1, conducted	S01_AA01	2021-06-19	Passed	Passed
CAT-M1, eFDD 2 16QAM, mid channel, 10 MHz, 5, conducted	S01_AA01	2021-06-19	Passed	Passed
CAT-M1, eFDD 2 16QAM, mid channel, 3 MHz, 1, conducted	S01_AA01	2021-06-19	Passed	Passed
CAT-M1, eFDD 2 16QAM, mid channel, 3 MHz, 5, conducted	S01_AA01	2021-06-19	Passed	Passed
CAT-M1, eFDD 2 16QAM, mid channel, 5 MHz, 1, conducted	S01_AA01	2021-06-19	Passed	Passed
CAT-M1, eFDD 2 16QAM, mid channel, 5 MHz, 5, conducted	S01_AA01	2021-06-19	Passed	Passed
CAT-M1, eFDD 2 QPSK, mid channel, 1.4 MHz, 1, conducted	S01_AA01	2021-06-19	Passed	Passed
CAT-M1, eFDD 2 QPSK, mid channel, 1.4 MHz, 3, conducted	S01_AA01	2021-06-19	Passed	Passed
CAT-M1, eFDD 2 QPSK, mid channel, 1.4 MHz, 6, conducted	S01_AA01	2021-06-19	Passed	Passed
CAT-M1, eFDD 2 QPSK, mid channel, 10 MHz, 1, conducted	S01_AA01	2021-06-19	Passed	Passed
CAT-M1, eFDD 2 QPSK, mid channel, 10 MHz, 3, conducted	S01_AA01	2021-06-19	Passed	Passed
CAT-M1, eFDD 2 QPSK, mid channel, 10 MHz, 6, conducted	S01_AA01	2021-06-19	Passed	Passed
CAT-M1, eFDD 2 QPSK, mid channel, 3 MHz, 1, conducted	S01_AA01	2021-06-19	Passed	Passed
CAT-M1, eFDD 2 QPSK, mid channel, 3 MHz, 3, conducted	S01_AA01	2021-06-19	Passed	Passed
CAT-M1, eFDD 2 QPSK, mid channel, 3 MHz, 6, conducted	S01_AA01	2021-06-19	Passed	Passed
CAT-M1, eFDD 2 QPSK, mid channel, 5 MHz, 1, conducted	S01_AA01	2021-06-19	Passed	Passed
CAT-M1, eFDD 2 QPSK, mid channel, 5 MHz, 3, conducted	S01_AA01	2021-06-19	Passed	Passed
CAT-M1, eFDD 2 QPSK, mid channel, 5 MHz, 6, conducted	S01_AA01	2021-06-19	Passed	Passed
CAT-M1, eFDD 25 16QAM, mid channel, 1.4 MHz, 1, conducted	S01_AA01	2021-06-19	Passed	Passed
CAT-M1, eFDD 25 16QAM, mid channel, 1.4 MHz, 5, conducted	S01_AA01	2021-06-19	Passed	Passed
CAT-M1, eFDD 25 16QAM, mid channel, 10 MHz, 1, conducted	S01_AA01	2021-06-19	Passed	Passed
CAT-M1, eFDD 25 16QAM, mid channel, 10 MHz, 5, conducted	S01_AA01	2021-06-19	Passed	Passed
CAT-M1, eFDD 25 16QAM, mid channel, 3 MHz, 1, conducted	S01_AA01	2021-06-19	Passed	Passed
CAT-M1, eFDD 25 16QAM, mid channel, 3 MHz, 5, conducted	S01_AA01	2021-06-19	Passed	Passed
CAT-M1, eFDD 25 16QAM, mid channel, 5 MHz, 1, conducted	S01_AA01	2021-06-19	Passed	Passed
CAT-M1, eFDD 25 16QAM, mid channel, 5 MHz, 5, conducted	S01_AA01	2021-06-19	Passed	Passed
CAT-M1, eFDD 25 QPSK, mid channel, 1.4 MHz, 1, conducted	S01_AA01	2021-06-19	Passed	Passed
CAT-M1, eFDD 25 QPSK, mid channel, 1.4 MHz, 3, conducted	S01_AA01	2021-06-19	Passed	Passed
CAT-M1, eFDD 25 QPSK, mid channel, 1.4 MHz, 6, conducted	S01_AA01	2021-06-19	Passed	Passed
CAT-M1, eFDD 25 QPSK, mid channel, 10 MHz, 1, conducted	S01_AA01	2021-06-19	Passed	Passed
CAT-M1, eFDD 25 QPSK, mid channel, 10 MHz, 3, conducted	S01_AA01	2021-06-19	Passed	Passed
CAT-M1, eFDD 25 QPSK, mid channel, 10 MHz, 6, conducted	S01_AA01	2021-06-19	Passed	Passed
CAT-M1, eFDD 25 QPSK, mid channel, 3 MHz, 1, conducted	S01_AA01	2021-06-19	Passed	Passed
CAT-M1, eFDD 25 QPSK, mid channel, 3 MHz, 3, conducted	S01_AA01	2021-06-19	Passed	Passed
CAT-M1, eFDD 25 QPSK, mid channel, 3 MHz, 6, conducted	S01_AA01	2021-06-19	Passed	Passed
CAT-M1, eFDD 25 QPSK, mid channel, 5 MHz, 1, conducted	S01_AA01	2021-06-19	Passed	Passed
CAT-M1, eFDD 25 QPSK, mid channel, 5 MHz, 3, conducted	S01_AA01	2021-06-19	Passed	Passed
CAT-M1, eFDD 25 QPSK, mid channel, 5 MHz, 6, conducted	S01_AA01	2021-06-19	Passed	Passed

47 CFR CHAPTER I FCC PART 24 Subpart E § 2.1046 § 24.232

RF Output power

The measurement was performed according to ANSI C63.26: 2015

Final Result

OP-Mode

Technology, Radio Technology, Operating Frequency, ChBW, Ressource Blocks, Measurement method

	Setup	Date	FCC	IC
NB-IoT, eFDD 2 BPSK, high channel, 0.2 MHz, 1, conducted	S01_AB01	2021-05-22	Passed	Passed
NB-IoT, eFDD 2 BPSK, low channel, 0.2 MHz, 1, conducted	S01_AB01	2021-05-22	Passed	Passed
NB-IoT, eFDD 2 BPSK, mid channel, 0.2 MHz, 1, conducted	S01_AB01	2021-05-22	Passed	Passed
NB-IoT, eFDD 2 QPSK, high channel, 0.2 MHz, 1, conducted	S01_AB01	2021-05-22	Passed	Passed
NB-IoT, eFDD 2 QPSK, high channel, 0.2 MHz, 12, conducted	S01_AB01	2021-05-22	Passed	Passed
NB-IoT, eFDD 2 QPSK, high channel, 0.2 MHz, 3, conducted	S01_AB01	2021-05-22	Passed	Passed
NB-IoT, eFDD 2 QPSK, high channel, 0.2 MHz, 6, conducted	S01_AB01	2021-05-22	Passed	Passed
NB-IoT, eFDD 2 QPSK, low channel, 0.2 MHz, 1, conducted	S01_AB01	2021-05-22	Passed	Passed
NB-IoT, eFDD 2 QPSK, low channel, 0.2 MHz, 12, conducted	S01_AB02	2021-05-07	Passed	Passed
NB-IoT, eFDD 2 QPSK, low channel, 0.2 MHz, 3, conducted	S01_AB01	2021-05-22	Passed	Passed
NB-IoT, eFDD 2 QPSK, low channel, 0.2 MHz, 6, conducted	S01_AB01	2021-05-22	Passed	Passed
NB-IoT, eFDD 2 QPSK, mid channel, 0.2 MHz, 1, conducted	S01_AB01	2021-05-22	Passed	Passed
NB-IoT, eFDD 2 QPSK, mid channel, 0.2 MHz, 12, conducted	S01_AB01	2021-05-22	Passed	Passed
NB-IoT, eFDD 2 QPSK, mid channel, 0.2 MHz, 3, conducted	S01_AB01	2021-05-22	Passed	Passed
NB-IoT, eFDD 2 QPSK, mid channel, 0.2 MHz, 6, conducted	S01_AB01	2021-05-22	Passed	Passed

47 CFR CHAPTER I FCC PART 24 Subpart E § 2.1051 § 24.238

Spurious emissions at antenna terminal

The measurement was performed according to ANSI C63.26: 2015

Final Result

OP-Mode

Technology, Radio Technology, Operating Frequency, ChBW, Ressource Blocks, Measurement method

	Setup	Date	FCC	IC
NB-IoT, eFDD 2 QPSK, mid channel, 0.2 MHz, 1, conducted	S01_AB01	2021-11-06	Passed	Passed

47 CFR CHAPTER I FCC PART 24 Subpart E § 2.1053 § 24.236

Field strength of spurious radiation

The measurement was performed according to ANSI C63.26: 2015

Final Result

OP-Mode

Technology, Radio Technology, Operating Frequency, ChBW, Ressource Blocks, Measurement method

	Setup	Date	FCC	IC
CAT-M1, eFDD 2 QPSK, mid channel, 1.4 MHz, 1, radiated	S01_AA01	2021-06-21	Passed	Passed
CAT-M1, eFDD 25 QPSK, mid channel, 1.4 MHz, 1, radiated	S01_AA01	2021-06-21	Passed	Passed
NB-IoT, eFDD 2 QPSK, high channel, 0.2 MHz, 1, radiated	S01_AB01	2021-05-31	Passed	Passed
NB-IoT, eFDD 2 QPSK, low channel, 0.2 MHz, 1, radiated	S01_AB01	2021-05-31	Passed	Passed
NB-IoT, eFDD 2 QPSK, mid channel, 0.2 MHz, 1, radiated	S01_AB01	2021-05-31	Passed	Passed
NB-IoT, eFDD 2 QPSK, mid channel, 0.2 MHz, 1, radiated	S01_BB01	2021-06-22	Passed	Passed
NB-IoT, eFDD 2 QPSK, mid channel, 0.2 MHz, 1, radiated	S01_CB01	2021-05-27	Passed	Passed

47 CFR CHAPTER I FCC PART 24 Subpart E § 2.1049

Emission and occupied bandwidth

The measurement was performed according to ANSI C63.26: 2015

Final Result

OP-Mode

Technology, Radio Technology, Operating Frequency, ChBW, Ressource Blocks, Measurement method

	Setup	Date	FCC	IC
NB-IoT, eFDD 2 BPSK, high channel, 0.2 MHz, 1, conducted	S01_AB01	2021-05-14	Passed	Passed

47 CFR CHAPTER I FCC PART 24 Subpart E § 2.1049

Emission and occupied bandwidth

The measurement was performed according to ANSI C63.26: 2015

Final Result

OP-Mode	Setup	Date	FCC	IC
Technology, Radio Technology, Operating Frequency, ChBW, Ressource Blocks, Measurement method				
NB-IoT, eFDD 2 BPSK, low channel, 0.2 MHz, 1, conducted	S01_AB01	2021-05-14	Passed	Passed
NB-IoT, eFDD 2 BPSK, mid channel, 0.2 MHz, 1, conducted	S01_AB01	2021-05-14	Passed	Passed
NB-IoT, eFDD 2 QPSK, high channel, 0.2 MHz, 12, conducted	S01_AB01	2021-05-14	Passed	Passed
NB-IoT, eFDD 2 QPSK, low channel, 0.2 MHz, 12, conducted	S01_AB01	2021-05-14	Passed	Passed
NB-IoT, eFDD 2 QPSK, mid channel, 0.2 MHz, 12, conducted	S01_AB01	2021-05-14	Passed	Passed

47 CFR CHAPTER I FCC PART 24 Subpart E § 2.1051 § 24.238

Band edge compliance

The measurement was performed according to ANSI C63.26: 2015

Final Result

OP-Mode	Setup	Date	FCC	IC
Technology, Radio Technology, Operating Frequency, ChBW, Ressource Blocks, Measurement method				
NB-IoT, eFDD 2 BPSK, high channel, 0.2 MHz, 1, conducted	S01_AB01	2021-05-07	Passed	Passed
NB-IoT, eFDD 2 BPSK, low channel, 0.2 MHz, 1, conducted	S01_AB01	2021-05-26	Passed	Passed
NB-IoT, eFDD 2 QPSK, high channel, 0.2 MHz, 12, conducted	S01_AB01	2021-05-26	Passed	Passed
NB-IoT, eFDD 2 QPSK, low channel, 0.2 MHz, 12, conducted	S01_AB01	2021-05-26	Passed	Passed

47 CFR CHAPTER I FCC PART 24 Subpart E § 24.232

Peak to Average Ratio

The measurement was performed according to ANSI C63.26: 2015

Final Result

OP-Mode	Setup	Date	FCC	IC
Technology, Radio Technology, Operating Frequency, ChBW, Ressource Blocks, Measurement method				
NB-IoT, eFDD 2 BPSK, high channel, 0.2 MHz, 1, conducted	S01_AB02	2021-05-07	Passed	Passed
NB-IoT, eFDD 2 BPSK, low channel, 0.2 MHz, 1, conducted	S01_AB02	2021-05-07	Passed	Passed
NB-IoT, eFDD 2 BPSK, mid channel, 0.2 MHz, 1, conducted	S01_AB02	2021-05-07	Passed	Passed
NB-IoT, eFDD 2 QPSK, high channel, 0.2 MHz, 12, conducted	S01_AB02	2021-01-07	Passed	Passed
NB-IoT, eFDD 2 QPSK, low channel, 0.2 MHz, 12, conducted	S01_AB02	2021-01-07	Passed	Passed
NB-IoT, eFDD 2 QPSK, mid channel, 0.2 MHz, 12, conducted	S01_AB02	2021-01-07	Passed	Passed

47 CFR CHAPTER I FCC PART 27 Subpart C § 2.1046 § 27.50

RF Output Power

The measurement was performed according to ANSI C63.26: 2015

Final Result

OP-Mode	Setup	Date	FCC	IC
Technology, Radio Technology, Operating Frequency, ChBW, Ressource Blocks, Measurement method				
CAT-M1, eFDD 12 16QAM, mid channel, 1.4 MHz, 1, conducted	S01_AA01	2021-06-19	Passed	Passed
CAT-M1, eFDD 12 16QAM, mid channel, 1.4 MHz, 5, conducted	S01_AA01	2021-06-19	Passed	Passed
CAT-M1, eFDD 12 16QAM, mid channel, 10 MHz, 1, conducted	S01_AA01	2021-06-19	Passed	Passed
CAT-M1, eFDD 12 16QAM, mid channel, 10 MHz, 5, conducted	S01_AA01	2021-06-19	Passed	Passed
CAT-M1, eFDD 12 16QAM, mid channel, 3 MHz, 1, conducted	S01_AA01	2021-06-19	Passed	Passed
CAT-M1, eFDD 12 16QAM, mid channel, 3 MHz, 5, conducted	S01_AA01	2021-06-19	Passed	Passed
CAT-M1, eFDD 12 16QAM, mid channel, 5 MHz, 1, conducted	S01_AA01	2021-06-19	Passed	Passed
CAT-M1, eFDD 12 16QAM, mid channel, 5 MHz, 5, conducted	S01_AA01	2021-06-19	Passed	Passed
CAT-M1, eFDD 12 QPSK, mid channel, 1.4 MHz, 1, conducted	S01_AA01	2021-06-19	Passed	Passed

47 CFR CHAPTER I FCC PART 27 Subpart C § 2.1046 § 27.50

RF Output Power

The measurement was performed according to ANSI C63.26: 2015

Final Result

OP-Mode

Technology, Radio Technology, Operating Frequency, ChBW, Ressource Blocks, Measurement method

	Setup	Date	FCC	IC
CAT-M1, eFDD 12 QPSK, mid channel, 1.4 MHz, 3, conducted	S01_AA01	2021-06-19	Passed	Passed
CAT-M1, eFDD 12 QPSK, mid channel, 1.4 MHz, 6, conducted	S01_AA01	2021-06-19	Passed	Passed
CAT-M1, eFDD 12 QPSK, mid channel, 10 MHz, 1, conducted	S01_AA01	2021-06-19	Passed	Passed
CAT-M1, eFDD 12 QPSK, mid channel, 10 MHz, 3, conducted	S01_AA01	2021-06-19	Passed	Passed
CAT-M1, eFDD 12 QPSK, mid channel, 10 MHz, 6, conducted	S01_AA01	2021-06-19	Passed	Passed
CAT-M1, eFDD 12 QPSK, mid channel, 3 MHz, 1, conducted	S01_AA01	2021-06-19	Passed	Passed
CAT-M1, eFDD 12 QPSK, mid channel, 3 MHz, 3, conducted	S01_AA01	2021-06-19	Passed	Passed
CAT-M1, eFDD 12 QPSK, mid channel, 3 MHz, 6, conducted	S01_AA01	2021-06-19	Passed	Passed
CAT-M1, eFDD 12 QPSK, mid channel, 5 MHz, 1, conducted	S01_AA01	2021-06-19	Passed	Passed
CAT-M1, eFDD 12 QPSK, mid channel, 5 MHz, 3, conducted	S01_AA01	2021-06-19	Passed	Passed
CAT-M1, eFDD 12 QPSK, mid channel, 5 MHz, 6, conducted	S01_AA01	2021-06-19	Passed	Passed
CAT-M1, eFDD 13 16QAM, mid channel, 10 MHz, 1, conducted	S01_AA01	2021-06-19	Passed	Passed
CAT-M1, eFDD 13 16QAM, mid channel, 10 MHz, 5, conducted	S01_AA01	2021-06-19	Passed	Passed
CAT-M1, eFDD 13 16QAM, mid channel, 5 MHz, 1, conducted	S01_AA01	2021-06-19	Passed	Passed
CAT-M1, eFDD 13 16QAM, mid channel, 5 MHz, 5, conducted	S01_AA01	2021-06-19	Passed	Passed
CAT-M1, eFDD 13 QPSK, mid channel, 10 MHz, 3, conducted	S01_AA01	2021-06-19	Passed	Passed
CAT-M1, eFDD 13 QPSK, mid channel, 5 MHz, 1, conducted	S01_AA01	2021-06-19	Passed	Passed
CAT-M1, eFDD 13 QPSK, mid channel, 5 MHz, 3, conducted	S01_AA01	2021-06-19	Passed	Passed
CAT-M1, eFDD 13 QPSK, mid channel, 5 MHz, 6, conducted	S01_AA01	2021-06-19	Passed	Passed
CAT-M1, eFDD 4 16QAM, mid channel, 1.4 MHz, 1, conducted	S01_AA01	2021-06-19	Passed	Passed
CAT-M1, eFDD 4 16QAM, mid channel, 1.4 MHz, 5, conducted	S01_AA01	2021-06-19	Passed	Passed
CAT-M1, eFDD 4 16QAM, mid channel, 10 MHz, 1, conducted	S01_AA01	2021-06-19	Passed	Passed
CAT-M1, eFDD 4 16QAM, mid channel, 10 MHz, 5, conducted	S01_AA01	2021-06-19	Passed	Passed
CAT-M1, eFDD 4 16QAM, mid channel, 3 MHz, 1, conducted	S01_AA01	2021-06-19	Passed	Passed
CAT-M1, eFDD 4 16QAM, mid channel, 3 MHz, 5, conducted	S01_AA01	2021-06-19	Passed	Passed
CAT-M1, eFDD 4 16QAM, mid channel, 5 MHz, 1, conducted	S01_AA01	2021-06-19	Passed	Passed
CAT-M1, eFDD 4 16QAM, mid channel, 5 MHz, 5, conducted	S01_AA01	2021-06-19	Passed	Passed
CAT-M1, eFDD 4 QPSK, mid channel, 1.4 MHz, 1, conducted	S01_AA01	2021-06-19	Passed	Passed
CAT-M1, eFDD 4 QPSK, mid channel, 1.4 MHz, 3, conducted	S01_AA01	2021-06-19	Passed	Passed
CAT-M1, eFDD 4 QPSK, mid channel, 1.4 MHz, 6, conducted	S01_AA01	2021-06-19	Passed	Passed
CAT-M1, eFDD 4 QPSK, mid channel, 10 MHz, 1, conducted	S01_AA01	2021-06-19	Passed	Passed
CAT-M1, eFDD 4 QPSK, mid channel, 10 MHz, 3, conducted	S01_AA01	2021-06-19	Passed	Passed
CAT-M1, eFDD 4 QPSK, mid channel, 10 MHz, 6, conducted	S01_AA01	2021-06-19	Passed	Passed
CAT-M1, eFDD 4 QPSK, mid channel, 3 MHz, 1, conducted	S01_AA01	2021-06-19	Passed	Passed
CAT-M1, eFDD 4 QPSK, mid channel, 3 MHz, 3, conducted	S01_AA01	2021-06-19	Passed	Passed
CAT-M1, eFDD 4 QPSK, mid channel, 3 MHz, 6, conducted	S01_AA01	2021-06-19	Passed	Passed
CAT-M1, eFDD 4 QPSK, mid channel, 5 MHz, 1, conducted	S01_AA01	2021-06-19	Passed	Passed
CAT-M1, eFDD 4 QPSK, mid channel, 5 MHz, 3, conducted	S01_AA01	2021-06-19	Passed	Passed
CAT-M1, eFDD 4 QPSK, mid channel, 5 MHz, 6, conducted	S01_AA01	2021-06-19	Passed	Passed
CAT-M1, eFDD 66 16QAM, high channel, 1.4 MHz, 1, conducted	S01_AA01	2021-06-19	Passed	Passed
CAT-M1, eFDD 66 16QAM, high channel, 1.4 MHz, 5, conducted	S01_AA01	2021-06-19	Passed	Passed
CAT-M1, eFDD 66 16QAM, high channel, 10 MHz, 1, conducted	S01_AA01	2021-06-19	Passed	Passed
CAT-M1, eFDD 66 16QAM, high channel, 10 MHz, 5, conducted	S01_AA01	2021-06-21	Passed	Passed
CAT-M1, eFDD 66 16QAM, high channel, 3 MHz, 1, conducted	S01_AA01	2021-06-19	Passed	Passed
CAT-M1, eFDD 66 16QAM, high channel, 3 MHz, 5, conducted	S01_AA01	2021-06-19	Passed	Passed
CAT-M1, eFDD 66 16QAM, high channel, 5 MHz, 1, conducted	S01_AA01	2021-06-19	Passed	Passed

47 CFR CHAPTER I FCC PART 27 Subpart C § 2.1046 § 27.50

RF Output Power

The measurement was performed according to ANSI C63.26: 2015

Final Result

OP-Mode

Technology, Radio Technology, Operating Frequency, ChBW, Ressource Blocks, Measurement method

	Setup	Date	FCC	IC
CAT-M1, eFDD 66 16QAM, high channel, 5 MHz, 5, conducted	S01_AA01	2021-06-21	Passed	Passed
CAT-M1, eFDD 66 16QAM, low channel, 1.4 MHz, 1, conducted	S01_AA01	2021-06-19	Passed	Passed
CAT-M1, eFDD 66 16QAM, low channel, 1.4 MHz, 5, conducted	S01_AA01	2021-06-19	Passed	Passed
CAT-M1, eFDD 66 16QAM, low channel, 10 MHz, 1, conducted	S01_AA01	2021-06-19	Passed	Passed
CAT-M1, eFDD 66 16QAM, low channel, 10 MHz, 5, conducted	S01_AA01	2021-06-19	Passed	Passed
CAT-M1, eFDD 66 16QAM, low channel, 3 MHz, 1, conducted	S01_AA01	2021-06-19	Passed	Passed
CAT-M1, eFDD 66 16QAM, low channel, 3 MHz, 5, conducted	S01_AA01	2021-06-19	Passed	Passed
CAT-M1, eFDD 66 16QAM, low channel, 5 MHz, 1, conducted	S01_AA01	2021-06-19	Passed	Passed
CAT-M1, eFDD 66 16QAM, low channel, 5 MHz, 5, conducted	S01_AA01	2021-06-19	Passed	Passed
CAT-M1, eFDD 66 16QAM, mid channel, 1.4 MHz, 1, conducted	S01_AA01	2021-06-19	Passed	Passed
CAT-M1, eFDD 66 16QAM, mid channel, 1.4 MHz, 5, conducted	S01_AA01	2021-06-19	Passed	Passed
CAT-M1, eFDD 66 16QAM, mid channel, 10 MHz, 1, conducted	S01_AA01	2021-06-19	Passed	Passed
CAT-M1, eFDD 66 16QAM, mid channel, 10 MHz, 5, conducted	S01_AA01	2021-06-19	Passed	Passed
CAT-M1, eFDD 66 16QAM, mid channel, 3 MHz, 1, conducted	S01_AA01	2021-06-19	Passed	Passed
CAT-M1, eFDD 66 16QAM, mid channel, 3 MHz, 5, conducted	S01_AA01	2021-06-19	Passed	Passed
CAT-M1, eFDD 66 16QAM, mid channel, 5 MHz, 1, conducted	S01_AA01	2021-06-19	Passed	Passed
CAT-M1, eFDD 66 16QAM, mid channel, 5 MHz, 5, conducted	S01_AA01	2021-06-19	Passed	Passed
CAT-M1, eFDD 66 QPSK, high channel, 1.4 MHz, 1, conducted	S01_AA01	2021-06-19	Passed	Passed
CAT-M1, eFDD 66 QPSK, high channel, 1.4 MHz, 3, conducted	S01_AA01	2021-06-19	Passed	Passed
CAT-M1, eFDD 66 QPSK, high channel, 1.4 MHz, 6, conducted	S01_AA01	2021-06-19	Passed	Passed
CAT-M1, eFDD 66 QPSK, high channel, 10 MHz, 1, conducted	S01_AA01	2021-06-19	Passed	Passed
CAT-M1, eFDD 66 QPSK, high channel, 10 MHz, 3, conducted	S01_AA01	2021-06-21	Passed	Passed
CAT-M1, eFDD 66 QPSK, high channel, 10 MHz, 6, conducted	S01_AA01	2021-06-21	Passed	Passed
CAT-M1, eFDD 66 QPSK, high channel, 3 MHz, 1, conducted	S01_AA01	2021-06-19	Passed	Passed
CAT-M1, eFDD 66 QPSK, high channel, 3 MHz, 3, conducted	S01_AA01	2021-06-19	Passed	Passed
CAT-M1, eFDD 66 QPSK, high channel, 3 MHz, 6, conducted	S01_AA01	2021-06-19	Passed	Passed
CAT-M1, eFDD 66 QPSK, high channel, 5 MHz, 1, conducted	S01_AA01	2021-06-19	Passed	Passed
CAT-M1, eFDD 66 QPSK, high channel, 5 MHz, 3, conducted	S01_AA01	2021-06-21	Passed	Passed
CAT-M1, eFDD 66 QPSK, high channel, 5 MHz, 6, conducted	S01_AA01	2021-06-21	Passed	Passed
CAT-M1, eFDD 66 QPSK, low channel, 1.4 MHz, 1, conducted	S01_AA01	2021-06-19	Passed	Passed
CAT-M1, eFDD 66 QPSK, low channel, 1.4 MHz, 3, conducted	S01_AA01	2021-06-19	Passed	Passed
CAT-M1, eFDD 66 QPSK, low channel, 1.4 MHz, 6, conducted	S01_AA01	2021-06-19	Passed	Passed
CAT-M1, eFDD 66 QPSK, low channel, 10 MHz, 1, conducted	S01_AA01	2021-06-19	Passed	Passed
CAT-M1, eFDD 66 QPSK, low channel, 10 MHz, 3, conducted	S01_AA01	2021-06-19	Passed	Passed
CAT-M1, eFDD 66 QPSK, low channel, 10 MHz, 6, conducted	S01_AA01	2021-06-19	Passed	Passed
CAT-M1, eFDD 66 QPSK, low channel, 3 MHz, 1, conducted	S01_AA01	2021-06-19	Passed	Passed
CAT-M1, eFDD 66 QPSK, low channel, 3 MHz, 3, conducted	S01_AA01	2021-06-19	Passed	Passed
CAT-M1, eFDD 66 QPSK, low channel, 3 MHz, 6, conducted	S01_AA01	2021-06-19	Passed	Passed
CAT-M1, eFDD 66 QPSK, low channel, 5 MHz, 1, conducted	S01_AA01	2021-06-19	Passed	Passed
CAT-M1, eFDD 66 QPSK, low channel, 5 MHz, 3, conducted	S01_AA01	2021-06-19	Passed	Passed
CAT-M1, eFDD 66 QPSK, low channel, 5 MHz, 6, conducted	S01_AA01	2021-06-19	Passed	Passed
CAT-M1, eFDD 66 QPSK, mid channel, 1.4 MHz, 1, conducted	S01_AA01	2021-06-19	Passed	Passed
CAT-M1, eFDD 66 QPSK, mid channel, 1.4 MHz, 3, conducted	S01_AA01	2021-06-19	Passed	Passed
CAT-M1, eFDD 66 QPSK, mid channel, 1.4 MHz, 6, conducted	S01_AA01	2021-06-19	Passed	Passed
CAT-M1, eFDD 66 QPSK, mid channel, 10 MHz, 1, conducted	S01_AA01	2021-06-19	Passed	Passed
CAT-M1, eFDD 66 QPSK, mid channel, 10 MHz, 3, conducted	S01_AA01	2021-06-19	Passed	Passed

47 CFR CHAPTER I FCC PART 27 Subpart C § 2.1046 § 27.50

RF Output Power

The measurement was performed according to ANSI C63.26: 2015

Final Result

OP-Mode

Technology, Radio Technology, Operating Frequency, ChBW, Ressource Blocks, Measurement method

	Setup	Date	FCC	IC
CAT-M1, eFDD 66 QPSK, mid channel, 10 MHz, 6, conducted	S01_AA01	2021-06-19	Passed	Passed
CAT-M1, eFDD 66 QPSK, mid channel, 3 MHz, 1, conducted	S01_AA01	2021-06-19	Passed	Passed
CAT-M1, eFDD 66 QPSK, mid channel, 3 MHz, 3, conducted	S01_AA01	2021-06-19	Passed	Passed
CAT-M1, eFDD 66 QPSK, mid channel, 3 MHz, 6, conducted	S01_AA01	2021-06-19	Passed	Passed
CAT-M1, eFDD 66 QPSK, mid channel, 5 MHz, 1, conducted	S01_AA01	2021-06-19	Passed	Passed
CAT-M1, eFDD 66 QPSK, mid channel, 5 MHz, 3, conducted	S01_AA01	2021-06-19	Passed	Passed
CAT-M1, eFDD 66 QPSK, mid channel, 5 MHz, 6, conducted	S01_AA01	2021-06-19	Passed	Passed
CAT-M1, eFDD 71 16QAM, high channel, 10 MHz, 1, conducted	S01_AA01	2021-06-21	Passed	Passed
CAT-M1, eFDD 71 16QAM, high channel, 10 MHz, 5, conducted	S01_AA01	2021-06-21	Passed	Passed
CAT-M1, eFDD 71 16QAM, high channel, 5 MHz, 1, conducted	S01_AA01	2021-06-21	Passed	Passed
CAT-M1, eFDD 71 16QAM, high channel, 5 MHz, 5, conducted	S01_AA01	2021-06-21	Passed	Passed
CAT-M1, eFDD 71 16QAM, low channel, 10 MHz, 1, conducted	S01_AA01	2021-06-21	Passed	Passed
CAT-M1, eFDD 71 16QAM, low channel, 10 MHz, 5, conducted	S01_AA01	2021-06-21	Passed	Passed
CAT-M1, eFDD 71 16QAM, low channel, 5 MHz, 1, conducted	S01_AA01	2021-06-21	Passed	Passed
CAT-M1, eFDD 71 16QAM, low channel, 5 MHz, 5, conducted	S01_AA01	2021-06-21	Passed	Passed
CAT-M1, eFDD 71 16QAM, mid channel, 10 MHz, 1, conducted	S01_AA01	2021-06-19	Passed	Passed
CAT-M1, eFDD 71 16QAM, mid channel, 10 MHz, 5, conducted	S01_AA01	2021-06-19	Passed	Passed
CAT-M1, eFDD 71 16QAM, mid channel, 5 MHz, 1, conducted	S01_AA01	2021-06-19	Passed	Passed
CAT-M1, eFDD 71 16QAM, mid channel, 5 MHz, 5, conducted	S01_AA01	2021-06-19	Passed	Passed
CAT-M1, eFDD 71 QPSK, high channel, 10 MHz, 1, conducted	S01_AA01	2021-06-21	Passed	Passed
CAT-M1, eFDD 71 QPSK, high channel, 10 MHz, 3, conducted	S01_AA01	2021-06-21	Passed	Passed
CAT-M1, eFDD 71 QPSK, high channel, 10 MHz, 6, conducted	S01_AA01	2021-06-21	Passed	Passed
CAT-M1, eFDD 71 QPSK, high channel, 5 MHz, 1, conducted	S01_AA01	2021-06-21	Passed	Passed
CAT-M1, eFDD 71 QPSK, high channel, 5 MHz, 3, conducted	S01_AA01	2021-06-21	Passed	Passed
CAT-M1, eFDD 71 QPSK, high channel, 5 MHz, 6, conducted	S01_AA01	2021-06-21	Passed	Passed
CAT-M1, eFDD 71 QPSK, low channel, 10 MHz, 1, conducted	S01_AA01	2021-06-21	Passed	Passed
CAT-M1, eFDD 71 QPSK, low channel, 10 MHz, 3, conducted	S01_AA01	2021-06-21	Passed	Passed
CAT-M1, eFDD 71 QPSK, low channel, 10 MHz, 6, conducted	S01_AA01	2021-06-21	Passed	Passed
CAT-M1, eFDD 71 QPSK, low channel, 5 MHz, 1, conducted	S01_AA01	2021-06-21	Passed	Passed
CAT-M1, eFDD 71 QPSK, low channel, 5 MHz, 3, conducted	S01_AA01	2021-06-21	Passed	Passed
CAT-M1, eFDD 71 QPSK, low channel, 5 MHz, 6, conducted	S01_AA01	2021-06-21	Passed	Passed
CAT-M1, eFDD 71 QPSK, mid channel, 10 MHz, 1, conducted	S01_AA01	2021-06-19	Passed	Passed
CAT-M1, eFDD 71 QPSK, mid channel, 10 MHz, 3, conducted	S01_AA01	2021-06-19	Passed	Passed
CAT-M1, eFDD 71 QPSK, mid channel, 10 MHz, 6, conducted	S01_AA01	2021-06-19	Passed	Passed
CAT-M1, eFDD 71 QPSK, mid channel, 5 MHz, 1, conducted	S01_AA01	2021-06-19	Passed	Passed
CAT-M1, eFDD 71 QPSK, mid channel, 5 MHz, 3, conducted	S01_AA01	2021-06-19	Passed	Passed
CAT-M1, eFDD 71 QPSK, mid channel, 5 MHz, 6, conducted	S01_AA01	2021-06-19	Passed	Passed
CAT-M1, eFDD 8 16QAM, high channel, 1.4 MHz, 1, conducted	S01_AA01	2021-06-21	Passed	Passed
CAT-M1, eFDD 8 16QAM, high channel, 1.4 MHz, 5, conducted	S01_AA01	2021-06-21	Passed	Passed
CAT-M1, eFDD 8 16QAM, low channel, 1.4 MHz, 1, conducted	S01_AA01	2021-06-21	Passed	Passed
CAT-M1, eFDD 8 16QAM, low channel, 1.4 MHz, 5, conducted	S01_AA01	2021-06-21	Passed	Passed
CAT-M1, eFDD 8 16QAM, mid channel, 1.4 MHz, 1, conducted	S01_AA01	2021-06-21	Passed	Passed
CAT-M1, eFDD 8 16QAM, mid channel, 1.4 MHz, 5, conducted	S01_AA01	2021-06-21	Passed	Passed
CAT-M1, eFDD 8 16QAM, mid channel, 3 MHz, 1, conducted	S01_AA01	2021-06-21	Passed	Passed
CAT-M1, eFDD 8 16QAM, mid channel, 3 MHz, 5, conducted	S01_AA01	2021-06-21	Passed	Passed
CAT-M1, eFDD 8 QPSK, high channel, 1.4 MHz, 1, conducted	S01_AA01	2021-06-21	Passed	Passed

47 CFR CHAPTER I FCC PART 27 Subpart C § 2.1046 § 27.50

RF Output Power

The measurement was performed according to ANSI C63.26: 2015

Final Result

OP-Mode

Technology, Radio Technology, Operating Frequency, ChBW, Ressource Blocks, Measurement method

	Setup	Date	FCC	IC
CAT-M1, eFDD 8 QPSK, high channel, 1.4 MHz, 3, conducted	S01_AA01	2021-06-21	Passed	Passed
CAT-M1, eFDD 8 QPSK, high channel, 1.4 MHz, 6, conducted	S01_AA01	2021-06-21	Passed	Passed
CAT-M1, eFDD 8 QPSK, low channel, 1.4 MHz, 1, conducted	S01_AA01	2021-06-21	Passed	Passed
CAT-M1, eFDD 8 QPSK, low channel, 1.4 MHz, 3, conducted	S01_AA01	2021-06-21	Passed	Passed
CAT-M1, eFDD 8 QPSK, low channel, 1.4 MHz, 6, conducted	S01_AA01	2021-06-21	Passed	Passed
CAT-M1, eFDD 8 QPSK, mid channel, 1.4 MHz, 1, conducted	S01_AA01	2021-06-21	Passed	Passed
CAT-M1, eFDD 8 QPSK, mid channel, 1.4 MHz, 3, conducted	S01_AA01	2021-06-21	Passed	Passed
CAT-M1, eFDD 8 QPSK, mid channel, 1.4 MHz, 6, conducted	S01_AA01	2021-06-21	Passed	Passed
CAT-M1, eFDD 8 QPSK, mid channel, 3 MHz, 3, conducted	S01_AA01	2021-06-21	Passed	Passed
CAT-M1, eFDD 8 QPSK, mid channel, 3 MHz, 6, conducted	S01_AA01	2021-06-21	Passed	Passed
NB-IoT, eFDD 12 BPSK, high channel, 0.2 MHz, 1, conducted	S01_AB01	2021-06-19	Passed	Passed
NB-IoT, eFDD 12 BPSK, low channel, 0.2 MHz, 1, conducted	S01_AB01	2021-06-19	Passed	Passed
NB-IoT, eFDD 12 BPSK, mid channel, 0.2 MHz, 1, conducted	S01_AB01	2021-06-19	Passed	Passed
NB-IoT, eFDD 12 QPSK, high channel, 0.2 MHz, 1, conducted	S01_AB01	2021-06-19	Passed	Passed
NB-IoT, eFDD 12 QPSK, high channel, 0.2 MHz, 12, conducted	S01_AB01	2021-06-19	Passed	Passed
NB-IoT, eFDD 12 QPSK, high channel, 0.2 MHz, 3, conducted	S01_AB01	2021-06-19	Passed	Passed
NB-IoT, eFDD 12 QPSK, high channel, 0.2 MHz, 6, conducted	S01_AB01	2021-06-19	Passed	Passed
NB-IoT, eFDD 12 QPSK, low channel, 0.2 MHz, 1, conducted	S01_AB01	2021-06-19	Passed	Passed
NB-IoT, eFDD 12 QPSK, low channel, 0.2 MHz, 12, conducted	S01_AB01	2021-06-19	Passed	Passed
NB-IoT, eFDD 12 QPSK, low channel, 0.2 MHz, 3, conducted	S01_AB01	2021-06-19	Passed	Passed
NB-IoT, eFDD 12 QPSK, low channel, 0.2 MHz, 6, conducted	S01_AB01	2021-06-19	Passed	Passed
NB-IoT, eFDD 12 QPSK, mid channel, 0.2 MHz, 1, conducted	S01_AB01	2021-06-19	Passed	Passed
NB-IoT, eFDD 12 QPSK, mid channel, 0.2 MHz, 12, conducted	S01_AB01	2021-06-19	Passed	Passed
NB-IoT, eFDD 12 QPSK, mid channel, 0.2 MHz, 3, conducted	S01_AB01	2021-06-19	Passed	Passed
NB-IoT, eFDD 12 QPSK, mid channel, 0.2 MHz, 6, conducted	S01_AB01	2021-06-19	Passed	Passed
NB-IoT, eFDD 4 BPSK, high channel, 0.2 MHz, 1, conducted	S01_AB01	2021-06-19	Passed	Passed
NB-IoT, eFDD 4 BPSK, low channel, 0.2 MHz, 1, conducted	S01_AB01	2021-06-19	Passed	Passed
NB-IoT, eFDD 4 BPSK, mid channel, 0.2 MHz, 1, conducted	S01_AB01	2021-06-19	Passed	Passed
NB-IoT, eFDD 4 QPSK, high channel, 0.2 MHz, 1, conducted	S01_AB01	2021-06-19	Passed	Passed
NB-IoT, eFDD 4 QPSK, high channel, 0.2 MHz, 12, conducted	S01_AB01	2021-06-19	Passed	Passed
NB-IoT, eFDD 4 QPSK, high channel, 0.2 MHz, 3, conducted	S01_AB01	2021-06-19	Passed	Passed
NB-IoT, eFDD 4 QPSK, high channel, 0.2 MHz, 6, conducted	S01_AB01	2021-06-19	Passed	Passed
NB-IoT, eFDD 4 QPSK, low channel, 0.2 MHz, 1, conducted	S01_AB02	2021-05-07	Passed	Passed
NB-IoT, eFDD 4 QPSK, low channel, 0.2 MHz, 12, conducted	S01_AB01	2021-06-19	Passed	Passed
NB-IoT, eFDD 4 QPSK, low channel, 0.2 MHz, 3, conducted	S01_AB01	2021-06-19	Passed	Passed
NB-IoT, eFDD 4 QPSK, low channel, 0.2 MHz, 6, conducted	S01_AB01	2021-06-19	Passed	Passed
NB-IoT, eFDD 4 QPSK, mid channel, 0.2 MHz, 1, conducted	S01_AB01	2021-06-19	Passed	Passed
NB-IoT, eFDD 4 QPSK, mid channel, 0.2 MHz, 12, conducted	S01_AB01	2021-06-19	Passed	Passed
NB-IoT, eFDD 4 QPSK, mid channel, 0.2 MHz, 3, conducted	S01_AB01	2021-06-19	Passed	Passed
NB-IoT, eFDD 4 QPSK, mid channel, 0.2 MHz, 6, conducted	S01_AB01	2021-06-19	Passed	Passed
NB-IoT, eFDD 66 BPSK, high channel, 0.2 MHz, 1, conducted	S01_AB01	2021-05-22	Passed	Passed
NB-IoT, eFDD 66 BPSK, low channel, 0.2 MHz, 1, conducted	S01_AB01	2021-05-22	Passed	Passed
NB-IoT, eFDD 66 BPSK, mid channel, 0.2 MHz, 1, conducted	S01_AB01	2021-05-22	Passed	Passed
NB-IoT, eFDD 66 QPSK, high channel, 0.2 MHz, 1, conducted	S01_AB01	2021-05-22	Passed	Passed
NB-IoT, eFDD 66 QPSK, high channel, 0.2 MHz, 12, conducted	S01_AB01	2021-05-22	Passed	Passed
NB-IoT, eFDD 66 QPSK, high channel, 0.2 MHz, 3, conducted	S01_AB01	2021-05-22	Passed	Passed

47 CFR CHAPTER I FCC PART 27 Subpart C § 2.1046 § 27.50

RF Output Power

The measurement was performed according to ANSI C63.26: 2015

Final Result

OP-Mode

Technology, Radio Technology, Operating Frequency, ChBW, Ressource Blocks, Measurement method

OP-Mode	Setup	Date	FCC	IC
NB-IoT, eFDD 66 QPSK, high channel, 0.2 MHz, 6, conducted	S01_AB01	2021-05-22	Passed	Passed
NB-IoT, eFDD 66 QPSK, low channel, 0.2 MHz, 1, conducted	S01_AB01	2021-05-22	Passed	Passed
NB-IoT, eFDD 66 QPSK, low channel, 0.2 MHz, 12, conducted	S01_AB01	2021-05-22	Passed	Passed
NB-IoT, eFDD 66 QPSK, low channel, 0.2 MHz, 3, conducted	S01_AB01	2021-05-22	Passed	Passed
NB-IoT, eFDD 66 QPSK, low channel, 0.2 MHz, 6, conducted	S01_AB01	2021-05-22	Passed	Passed
NB-IoT, eFDD 66 QPSK, mid channel, 0.2 MHz, 1, conducted	S01_AB01	2021-05-22	Passed	Passed
NB-IoT, eFDD 66 QPSK, mid channel, 0.2 MHz, 12, conducted	S01_AB01	2021-05-22	Passed	Passed
NB-IoT, eFDD 66 QPSK, mid channel, 0.2 MHz, 3, conducted	S01_AB01	2021-05-22	Passed	Passed
NB-IoT, eFDD 66 QPSK, mid channel, 0.2 MHz, 6, conducted	S01_AB01	2021-05-22	Passed	Passed
NB-IoT, eFDD 71 BPSK, high channel, 0.2 MHz, 1, conducted	S01_AB01	2021-06-19	Passed	Passed
NB-IoT, eFDD 71 BPSK, low channel, 0.2 MHz, 1, conducted	S01_AB01	2021-06-19	Passed	Passed
NB-IoT, eFDD 71 BPSK, mid channel, 0.2 MHz, 1, conducted	S01_AB01	2021-06-19	Passed	Passed
NB-IoT, eFDD 71 QPSK, high channel, 0.2 MHz, 1, conducted	S01_AB01	2021-06-19	Passed	Passed
NB-IoT, eFDD 71 QPSK, high channel, 0.2 MHz, 12, conducted	S01_AB02	2021-05-07	Passed	Passed
NB-IoT, eFDD 71 QPSK, high channel, 0.2 MHz, 3, conducted	S01_AB01	2021-06-19	Passed	Passed
NB-IoT, eFDD 71 QPSK, high channel, 0.2 MHz, 6, conducted	S01_AB01	2021-06-19	Passed	Passed
NB-IoT, eFDD 71 QPSK, low channel, 0.2 MHz, 1, conducted	S01_AB01	2021-06-19	Passed	Passed
NB-IoT, eFDD 71 QPSK, low channel, 0.2 MHz, 12, conducted	S01_AB02	2021-05-07	Passed	Passed
NB-IoT, eFDD 71 QPSK, low channel, 0.2 MHz, 3, conducted	S01_AB01	2021-06-19	Passed	Passed
NB-IoT, eFDD 71 QPSK, low channel, 0.2 MHz, 6, conducted	S01_AB01	2021-06-19	Passed	Passed
NB-IoT, eFDD 71 QPSK, mid channel, 0.2 MHz, 1, conducted	S01_AB01	2021-06-19	Passed	Passed
NB-IoT, eFDD 71 QPSK, mid channel, 0.2 MHz, 12, conducted	S01_AB02	2021-05-07	Passed	Passed
NB-IoT, eFDD 71 QPSK, mid channel, 0.2 MHz, 3, conducted	S01_AB01	2021-06-19	Passed	Passed
NB-IoT, eFDD 71 QPSK, mid channel, 0.2 MHz, 6, conducted	S01_AB01	2021-06-19	Passed	Passed
NB-IoT, eFDD 8 BPSK, high channel, 0.2 MHz, 1, conducted	S01_AB01	2021-06-19	Passed	Passed
NB-IoT, eFDD 8 BPSK, low channel, 0.2 MHz, 1, conducted	S01_AB01	2021-06-19	Passed	Passed
NB-IoT, eFDD 8 BPSK, mid channel, 0.2 MHz, 1, conducted	S01_AB01	2021-06-19	Passed	Passed
NB-IoT, eFDD 8 QPSK, high channel, 0.2 MHz, 1, conducted	S01_AB01	2021-06-19	Passed	Passed
NB-IoT, eFDD 8 QPSK, high channel, 0.2 MHz, 12, conducted	S01_AB02	2021-05-07	Passed	Passed
NB-IoT, eFDD 8 QPSK, high channel, 0.2 MHz, 3, conducted	S01_AB01	2021-06-19	Passed	Passed
NB-IoT, eFDD 8 QPSK, high channel, 0.2 MHz, 6, conducted	S01_AB01	2021-06-19	Passed	Passed
NB-IoT, eFDD 8 QPSK, low channel, 0.2 MHz, 1, conducted	S01_AB01	2021-06-19	Passed	Passed
NB-IoT, eFDD 8 QPSK, low channel, 0.2 MHz, 12, conducted	S01_AB02	2021-05-07	Passed	Passed
NB-IoT, eFDD 8 QPSK, low channel, 0.2 MHz, 3, conducted	S01_AB01	2021-06-19	Passed	Passed
NB-IoT, eFDD 8 QPSK, low channel, 0.2 MHz, 6, conducted	S01_AB01	2021-06-19	Passed	Passed
NB-IoT, eFDD 8 QPSK, mid channel, 0.2 MHz, 1, conducted	S01_AB01	2021-06-19	Passed	Passed
NB-IoT, eFDD 8 QPSK, mid channel, 0.2 MHz, 12, conducted	S01_AB02	2021-05-07	Passed	Passed
NB-IoT, eFDD 8 QPSK, mid channel, 0.2 MHz, 3, conducted	S01_AB01	2021-06-19	Passed	Passed
NB-IoT, eFDD 8 QPSK, mid channel, 0.2 MHz, 6, conducted	S01_AB01	2021-06-19	Passed	Passed
NB-IoT, eFDD 85 BPSK, high channel, 0.2 MHz, 1, conducted	S01_AB01	2021-05-22	Passed	Passed
NB-IoT, eFDD 85 BPSK, low channel, 0.2 MHz, 1, conducted	S01_AB01	2021-05-22	Passed	Passed
NB-IoT, eFDD 85 BPSK, mid channel, 0.2 MHz, 1, conducted	S01_AB01	2021-05-22	Passed	Passed
NB-IoT, eFDD 85 QPSK, high channel, 0.2 MHz, 1, conducted	S01_AB01	2021-05-22	Passed	Passed
NB-IoT, eFDD 85 QPSK, high channel, 0.2 MHz, 12, conducted	S01_AB01	2021-05-22	Passed	Passed
NB-IoT, eFDD 85 QPSK, high channel, 0.2 MHz, 3, conducted	S01_AB01	2021-05-22	Passed	Passed
NB-IoT, eFDD 85 QPSK, high channel, 0.2 MHz, 6, conducted	S01_AB01	2021-05-22	Passed	Passed

47 CFR CHAPTER I FCC PART 27 Subpart C § 2.1046 § 27.50

RF Output Power

The measurement was performed according to ANSI C63.26: 2015

Final Result

OP-Mode	Setup	Date	FCC	IC
Technology, Radio Technology, Operating Frequency, ChBW, Ressource Blocks, Measurement method				
NB-IoT, eFDD 85 QPSK, low channel, 0.2 MHz, 1, conducted	S01_AB01	2021-05-22	Passed	Passed
NB-IoT, eFDD 85 QPSK, low channel, 0.2 MHz, 12, conducted	S01_AB01	2021-05-22	Passed	Passed
NB-IoT, eFDD 85 QPSK, low channel, 0.2 MHz, 3, conducted	S01_AB01	2021-05-22	Passed	Passed
NB-IoT, eFDD 85 QPSK, low channel, 0.2 MHz, 6, conducted	S01_AB01	2021-05-22	Passed	Passed
NB-IoT, eFDD 85 QPSK, mid channel, 0.2 MHz, 1, conducted	S01_AB01	2021-05-22	Passed	Passed
NB-IoT, eFDD 85 QPSK, mid channel, 0.2 MHz, 12, conducted	S01_AB01	2021-05-22	Passed	Passed
NB-IoT, eFDD 85 QPSK, mid channel, 0.2 MHz, 3, conducted	S01_AB01	2021-05-22	Passed	Passed
NB-IoT, eFDD 85 QPSK, mid channel, 0.2 MHz, 6, conducted	S01_AB01	2021-05-22	Passed	Passed

47 CFR CHAPTER I FCC PART 27 Subpart C § 2.1055 § 27.54

Frequency stability

The measurement was performed according to ANSI C63.26: 2015

Final Result

OP-Mode	Setup	Date	FCC	IC
Technology, Radio Technology, Operating Frequency, ChBW, Ressource Blocks, Measurement method				
CAT-M1, eFDD 66 QPSK, mid channel, 1.4 MHz, 1, conducted	S01_AA01	2021-04-07	Passed	Passed
CAT-M1, eFDD 71 QPSK, mid channel, 1.4 MHz, 1, conducted	S01_AA01	2021-04-07	Passed	Passed
CAT-M1, eFDD 8 QPSK, mid channel, 1.4 MHz, 1, conducted	S01_AA01	2021-04-07	Passed	Passed
NB-IoT, eFDD 12 QPSK, mid channel, 0.2 MHz, 1, conducted	S01_AB01	2021-05-16	Passed	Passed
NB-IoT, eFDD 13 QPSK, mid channel, 0.2 MHz, 1, conducted	S01_AB01	2021-05-16	Passed	Passed
NB-IoT, eFDD 4 QPSK, mid channel, 0.2 MHz, 1, conducted	S01_AB01	2021-05-16	Passed	Passed
NB-IoT, eFDD 66 QPSK, mid channel, 0.2 MHz, 1, conducted	S01_AB01	2021-05-16	Passed	Passed
NB-IoT, eFDD 71 QPSK, mid channel, 0.2 MHz, 1, conducted	S01_AB01	2021-05-16	Passed	Passed
NB-IoT, eFDD 8 QPSK, mid channel, 0.2 MHz, 1, conducted	S01_AB01	2021-05-16	Passed	Passed
NB-IoT, eFDD 85 QPSK, mid channel, 0.2 MHz, 1, conducted	S01_AB01	2021-05-16	Passed	Passed

47 CFR CHAPTER I FCC PART 27 Subpart C § 2.1051 § 27.53

Spurious emissions at antenna terminals

The measurement was performed according to ANSI C63.26: 2015

Final Result

OP-Mode	Setup	Date	FCC	IC
Technology, Radio Technology, Operating Frequency, ChBW, Ressource Blocks, Measurement method				
CAT-M1, eFDD 66 QPSK, high channel, 1.4 MHz, 1, conducted	S01_AA01	2021-06-21	Passed	Passed
CAT-M1, eFDD 66 QPSK, low channel, 1.4 MHz, 1, conducted	S01_AA01	2021-06-21	Passed	Passed
CAT-M1, eFDD 66 QPSK, mid channel, 1.4 MHz, 1, conducted	S01_AA01	2021-06-21	Passed	Passed
CAT-M1, eFDD 71 QPSK, high channel, 1.4 MHz, 1, conducted	S01_AA01	2021-06-21	Passed	Passed
CAT-M1, eFDD 71 QPSK, low channel, 1.4 MHz, 1, conducted	S01_AA01	2021-06-21	Passed	Passed
CAT-M1, eFDD 71 QPSK, mid channel, 1.4 MHz, 1, conducted	S01_AA01	2021-06-21	Passed	Passed
CAT-M1, eFDD 8 QPSK, high channel, 1.4 MHz, 1, conducted	S01_AA01	2021-06-21	Passed	Passed
CAT-M1, eFDD 8 QPSK, low channel, 1.4 MHz, 1, conducted	S01_AA01	2021-06-21	Passed	Passed
CAT-M1, eFDD 8 QPSK, mid channel, 1.4 MHz, 1, conducted	S01_AA01	2021-06-21	Passed	Passed
NB-IoT, eFDD 12 QPSK, high channel, 0.2 MHz, 1, conducted	S01_AB01	2021-06-21	Passed	Passed
NB-IoT, eFDD 12 QPSK, low channel, 0.2 MHz, 1, conducted	S01_AB01	2021-06-21	Passed	Passed

47 CFR CHAPTER I FCC PART 27 Subpart C § 2.1051 § 27.53

Spurious emissions at antenna terminals

The measurement was performed according to ANSI C63.26: 2015

Final Result

OP-Mode	Setup	Date	FCC	IC
Technology, Radio Technology, Operating Frequency, ChBW, Ressource Blocks, Measurement method				
NB-IoT, eFDD 12 QPSK, mid channel, 0.2 MHz, 1, conducted	S01_AB01	2021-06-21	Passed	Passed
NB-IoT, eFDD 13 QPSK, high channel, 0.2 MHz, 1, conducted	S01_AB01	2021-06-21	Passed	Passed
NB-IoT, eFDD 13 QPSK, low channel, 0.2 MHz, 1, conducted	S01_AB01	2021-06-21	Passed	Passed
NB-IoT, eFDD 13 QPSK, mid channel, 0.2 MHz, 1, conducted	S01_AB01	2021-06-21	Passed	Passed
NB-IoT, eFDD 4 QPSK, high channel, 0.2 MHz, 1, conducted	S01_AB01	2021-06-21	Passed	Passed
NB-IoT, eFDD 4 QPSK, low channel, 0.2 MHz, 1, conducted	S01_AB01	2021-06-21	Passed	Passed
NB-IoT, eFDD 4 QPSK, mid channel, 0.2 MHz, 1, conducted	S01_AB01	2021-06-21	Passed	Passed
NB-IoT, eFDD 66 QPSK, high channel, 0.2 MHz, 1, conducted	S01_AB01	2021-06-21	Passed	Passed
NB-IoT, eFDD 66 QPSK, low channel, 0.2 MHz, 1, conducted	S01_AB01	2021-06-21	Passed	Passed
NB-IoT, eFDD 66 QPSK, mid channel, 0.2 MHz, 1, conducted	S01_AB01	2021-06-21	Passed	Passed
NB-IoT, eFDD 71 QPSK, high channel, 0.2 MHz, 1, conducted	S01_AB01	2021-06-21	Passed	Passed
NB-IoT, eFDD 71 QPSK, low channel, 0.2 MHz, 1, conducted	S01_AB01	2021-06-21	Passed	Passed
NB-IoT, eFDD 71 QPSK, mid channel, 0.2 MHz, 1, conducted	S01_AB01	2021-06-21	Passed	Passed
NB-IoT, eFDD 8 QPSK, high channel, 0.2 MHz, 1, conducted	S01_AB01	2021-06-21	Passed	Passed
NB-IoT, eFDD 8 QPSK, low channel, 0.2 MHz, 1, conducted	S01_AB01	2021-06-21	Passed	Passed
NB-IoT, eFDD 8 QPSK, mid channel, 0.2 MHz, 1, conducted	S01_AB01	2021-06-21	Passed	Passed
NB-IoT, eFDD 85 QPSK, high channel, 0.2 MHz, 1, conducted	S01_AB01	2021-06-21	Passed	Passed

47 CFR CHAPTER I FCC PART 27 Subpart C § 2.1053 § 27.53

Field strength of spurious radiation

The measurement was performed according to ANSI C63.26: 2015

Final Result

OP-Mode	Setup	Date	FCC	IC
Technology, Radio Technology, Operating Frequency, ChBW, Ressource Blocks, Measurement method				
CAT-M1, eFDD 12 QPSK, mid channel, 1.4 MHz, 1, radiated	S01_AA01	2021-06-21	Passed	Passed
CAT-M1, eFDD 13 QPSK, mid channel, 1.4 MHz, 1, radiated	S01_AA01	2021-06-21	Passed	Passed
CAT-M1, eFDD 4 QPSK, mid channel, 1.4 MHz, 1, radiated	S01_AA01	2021-06-21	Passed	Passed
CAT-M1, eFDD 66 QPSK, high channel, 1.4 MHz, 1, radiated	S01_AA01	2021-06-14	Passed	Passed
CAT-M1, eFDD 66 QPSK, low channel, 1.4 MHz, 1, radiated	S01_AA01	2021-06-14	Passed	Passed
CAT-M1, eFDD 66 QPSK, mid channel, 1.4 MHz, 1, radiated	S01_AA01	2021-06-14	Passed	Passed
CAT-M1, eFDD 71 QPSK, high channel, 1.4 MHz, 1, radiated	S01_AA01	2021-06-14	Passed	Passed
CAT-M1, eFDD 71 QPSK, low channel, 1.4 MHz, 1, radiated	S01_AA01	2021-06-14	Passed	Passed
CAT-M1, eFDD 71 QPSK, mid channel, 1.4 MHz, 1, radiated	S01_AA01	2021-06-14	Passed	Passed
CAT-M1, eFDD 8 QPSK, high channel, 1.4 MHz, 1, radiated	S01_AA01	2021-06-14	Passed	Passed
CAT-M1, eFDD 8 QPSK, low channel, 1.4 MHz, 1, radiated	S01_AA01	2021-06-14	Passed	Passed
CAT-M1, eFDD 8 QPSK, mid channel, 1.4 MHz, 1, radiated	S01_AA01	2021-06-14	Passed	Passed
NB-IoT, eFDD 12 QPSK, high channel, 0.2 MHz, 1, radiated	S01_AB01	2021-06-29	Passed	Passed
NB-IoT, eFDD 12 QPSK, low channel, 0.2 MHz, 1, radiated	S01_AB01	2021-06-29	Passed	Passed
NB-IoT, eFDD 12 QPSK, mid channel, 0.2 MHz, 1, radiated	S01_AB01	2021-06-29	Passed	Passed
NB-IoT, eFDD 13 QPSK, high channel, 0.2 MHz, 1, radiated	S01_AB01	2021-06-29	Passed	Passed
NB-IoT, eFDD 13 QPSK, low channel, 0.2 MHz, 1, radiated	S01_AB01	2021-06-29	Passed	Passed
NB-IoT, eFDD 13 QPSK, mid channel, 0.2 MHz, 1, radiated	S01_AB01	2021-06-29	Passed	Passed
NB-IoT, eFDD 4 QPSK, high channel, 0.2 MHz, 1, radiated	S01_AB01	2021-06-29	Passed	Passed
NB-IoT, eFDD 4 QPSK, low channel, 0.2 MHz, 1, radiated	S01_AB01	2021-06-29	Passed	Passed
NB-IoT, eFDD 4 QPSK, mid channel, 0.2 MHz, 1, radiated	S01_AB01	2021-06-29	Passed	Passed

47 CFR CHAPTER I FCC PART 27 Subpart C § 2.1053 § 27.53

Field strength of spurious radiation

The measurement was performed according to ANSI C63.26: 2015

Final Result

OP-Mode	Setup	Date	FCC	IC
Technology, Radio Technology, Operating Frequency, ChBW, Ressource Blocks, Measurement method				
NB-IoT, eFDD 66 QPSK, high channel, 0.2 MHz, 1, radiated	S01_AB01	2021-05-31	Passed	Passed
NB-IoT, eFDD 66 QPSK, low channel, 0.2 MHz, 1, radiated	S01_AB01	2021-05-31	Passed	Passed
NB-IoT, eFDD 66 QPSK, mid channel, 0.2 MHz, 1, radiated	S01_AB01	2021-05-31	Passed	Passed
NB-IoT, eFDD 71 QPSK, high channel, 0.2 MHz, 1, radiated	S01_AB01	2021-06-29	Passed	Passed
NB-IoT, eFDD 71 QPSK, low channel, 0.2 MHz, 1, radiated	S01_AB01	2021-06-29	Passed	Passed
NB-IoT, eFDD 71 QPSK, mid channel, 0.2 MHz, 1, radiated	S01_AB01	2021-06-29	Passed	Passed
NB-IoT, eFDD 8 QPSK, high channel, 0.2 MHz, 1, radiated	S01_AB01	2021-06-29	Passed	Passed
NB-IoT, eFDD 8 QPSK, low channel, 0.2 MHz, 1, radiated	S01_AB01	2021-06-29	Passed	Passed
NB-IoT, eFDD 8 QPSK, mid channel, 0.2 MHz, 1, radiated	S01_AB01	2021-06-29	Passed	Passed
NB-IoT, eFDD 85 QPSK, high channel, 0.2 MHz, 1, radiated	S01_AB01	2021-06-29	Passed	Passed
NB-IoT, eFDD 85 QPSK, low channel, 0.2 MHz, 1, radiated	S01_AB01	2021-06-29	Passed	Passed
NB-IoT, eFDD 13 QPSK, mid channel, 0.2 MHz, 1, radiated	S01_BB01	2021-06-27	Passed	Passed
NB-IoT, eFDD 13 QPSK, mid channel, 0.2 MHz, 1, radiated	S01_CB01	2021-06-27	Passed	Passed

47 CFR CHAPTER I FCC PART 27 Subpart C § 2.1049

Emission and occupied bandwidth

The measurement was performed according to ANSI C63.26: 2015

Final Result

OP-Mode	Setup	Date	FCC	IC
Technology, Radio Technology, Operating Frequency, ChBW, Ressource Blocks, Measurement method				
CAT-M1, eFDD 66 16QAM, high channel, 1.4 MHz, 5, conducted	S01_AA01	2021-06-21	Passed	Passed
CAT-M1, eFDD 66 16QAM, low channel, 1.4 MHz, 5, conducted	S01_AA01	2021-06-21	Passed	Passed
CAT-M1, eFDD 66 16QAM, mid channel, 1.4 MHz, 5, conducted	S01_AA01	2021-06-21	Passed	Passed
CAT-M1, eFDD 66 QPSK, high channel, 1.4 MHz, 6, conducted	S01_AA01	2021-06-21	Passed	Passed
CAT-M1, eFDD 66 QPSK, low channel, 1.4 MHz, 6, conducted	S01_AA01	2021-06-21	Passed	Passed
CAT-M1, eFDD 66 QPSK, mid channel, 1.4 MHz, 6, conducted	S01_AA01	2021-06-21	Passed	Passed
CAT-M1, eFDD 71 16QAM, high channel, 1.4 MHz, 5, conducted	S01_AA01	2021-06-21	Passed	Passed
CAT-M1, eFDD 71 16QAM, low channel, 1.4 MHz, 5, conducted	S01_AA01	2021-06-21	Passed	Passed
CAT-M1, eFDD 71 16QAM, mid channel, 1.4 MHz, 5, conducted	S01_AA01	2021-06-21	Passed	Passed
CAT-M1, eFDD 71 QPSK, high channel, 1.4 MHz, 6, conducted	S01_AA01	2021-06-21	Passed	Passed
CAT-M1, eFDD 71 QPSK, low channel, 1.4 MHz, 6, conducted	S01_AA01	2021-06-21	Passed	Passed
CAT-M1, eFDD 71 QPSK, mid channel, 1.4 MHz, 6, conducted	S01_AA01	2021-06-21	Passed	Passed
CAT-M1, eFDD 8 QPSK, high channel, 1.4 MHz, 6, conducted	S01_AA01	2021-06-21	Passed	Passed
CAT-M1, eFDD 8 QPSK, low channel, 1.4 MHz, 6, conducted	S01_AA01	2021-06-21	Passed	Passed
CAT-M1, eFDD 8 QPSK, mid channel, 1.4 MHz, 6, conducted	S01_AA01	2021-06-21	Passed	Passed
NB-IoT, eFDD 12 BPSK, high channel, 0.2 MHz, 1, conducted	S01_AB02	2021-05-07	Passed	Passed
NB-IoT, eFDD 12 BPSK, low channel, 0.2 MHz, 1, conducted	S01_AB02	2021-05-07	Passed	Passed
NB-IoT, eFDD 12 BPSK, mid channel, 0.2 MHz, 1, conducted	S01_AB02	2021-05-07	Passed	Passed
NB-IoT, eFDD 12 QPSK, high channel, 0.2 MHz, 12, conducted	S01_AB02	2021-05-07	Passed	Passed
NB-IoT, eFDD 12 QPSK, low channel, 0.2 MHz, 12, conducted	S01_AB02	2021-05-07	Passed	Passed
NB-IoT, eFDD 12 QPSK, mid channel, 0.2 MHz, 12, conducted	S01_AB02	2021-05-07	Passed	Passed
NB-IoT, eFDD 13 BPSK, high channel, 0.2 MHz, 1, conducted	S01_AB01	2021-05-14	Passed	Passed
NB-IoT, eFDD 13 BPSK, low channel, 0.2 MHz, 1, conducted	S01_AB01	2021-05-14	Passed	Passed
NB-IoT, eFDD 13 BPSK, mid channel, 0.2 MHz, 1, conducted	S01_AB01	2021-05-14	Passed	Passed
NB-IoT, eFDD 13 QPSK, high channel, 0.2 MHz, 12, conducted	S01_AB01	2021-05-14	Passed	Passed

47 CFR CHAPTER I FCC PART 27 Subpart C § 2.1049

Emission and occupied bandwidth

The measurement was performed according to ANSI C63.26: 2015

Final Result

OP-Mode	Setup	Date	FCC	IC
Technology, Radio Technology, Operating Frequency, ChBW, Ressource Blocks, Measurement method				
NB-IoT, eFDD 13 QPSK, low channel, 0.2 MHz, 12, conducted	S01_AB01	2021-05-14	Passed	Passed
NB-IoT, eFDD 13 QPSK, mid channel, 0.2 MHz, 12, conducted	S01_AB01	2021-05-14	Passed	Passed
NB-IoT, eFDD 4 BPSK, high channel, 0.2 MHz, 1, conducted	S01_AB01	2021-11-06	Passed	Passed
NB-IoT, eFDD 4 BPSK, low channel, 0.2 MHz, 1, conducted	S01_AB01	2021-11-06	Passed	Passed
NB-IoT, eFDD 4 BPSK, mid channel, 0.2 MHz, 1, conducted	S01_AB01	2021-11-06	Passed	Passed
NB-IoT, eFDD 4 QPSK, high channel, 0.2 MHz, 12, conducted	S01_AB01	2021-11-06	Passed	Passed
NB-IoT, eFDD 4 QPSK, low channel, 0.2 MHz, 12, conducted	S01_AB01	2021-11-06	Passed	Passed
NB-IoT, eFDD 4 QPSK, mid channel, 0.2 MHz, 12, conducted	S01_AB01	2021-11-06	Passed	Passed
NB-IoT, eFDD 66 BPSK, high channel, 0.2 MHz, 1, conducted	S01_AB01	2021-05-14	Passed	Passed
NB-IoT, eFDD 66 BPSK, low channel, 0.2 MHz, 1, conducted	S01_AB01	2021-05-14	Passed	Passed
NB-IoT, eFDD 66 BPSK, mid channel, 0.2 MHz, 1, conducted	S01_AB01	2021-05-14	Passed	Passed
NB-IoT, eFDD 66 QPSK, high channel, 0.2 MHz, 12, conducted	S01_AB01	2021-05-14	Passed	Passed
NB-IoT, eFDD 66 QPSK, low channel, 0.2 MHz, 12, conducted	S01_AB01	2021-05-14	Passed	Passed
NB-IoT, eFDD 66 QPSK, mid channel, 0.2 MHz, 12, conducted	S01_AB01	2021-05-14	Passed	Passed
NB-IoT, eFDD 71 BPSK, high channel, 0.2 MHz, 1, conducted	S01_AB01	2021-06-21	Passed	Passed
NB-IoT, eFDD 71 BPSK, low channel, 0.2 MHz, 1, conducted	S01_AB01	2021-06-21	Passed	Passed
NB-IoT, eFDD 71 BPSK, mid channel, 0.2 MHz, 1, conducted	S01_AB01	2021-06-21	Passed	Passed
NB-IoT, eFDD 71 QPSK, high channel, 0.2 MHz, 12, conducted	S01_AB01	2021-06-21	Passed	Passed
NB-IoT, eFDD 71 QPSK, low channel, 0.2 MHz, 12, conducted	S01_AB01	2021-06-21	Passed	Passed
NB-IoT, eFDD 71 QPSK, mid channel, 0.2 MHz, 12, conducted	S01_AB01	2021-06-21	Passed	Passed
NB-IoT, eFDD 8 BPSK, high channel, 0.2 MHz, 1, conducted	S01_AB01	2021-06-21	Passed	Passed
NB-IoT, eFDD 8 BPSK, low channel, 0.2 MHz, 1, conducted	S01_AB01	2021-06-21	Passed	Passed
NB-IoT, eFDD 8 BPSK, mid channel, 0.2 MHz, 1, conducted	S01_AB01	2021-06-21	Passed	Passed
NB-IoT, eFDD 8 QPSK, high channel, 0.2 MHz, 12, conducted	S01_AB01	2021-06-21	Passed	Passed
NB-IoT, eFDD 8 QPSK, low channel, 0.2 MHz, 12, conducted	S01_AB01	2021-06-21	Passed	Passed
NB-IoT, eFDD 8 QPSK, mid channel, 0.2 MHz, 12, conducted	S01_AB01	2021-06-21	Passed	Passed
NB-IoT, eFDD 85 BPSK, high channel, 0.2 MHz, 1, conducted	S01_AB01	2021-05-26	Passed	Passed
NB-IoT, eFDD 85 BPSK, low channel, 0.2 MHz, 1, conducted	S01_AB01	2021-05-26	Passed	Passed
NB-IoT, eFDD 85 BPSK, mid channel, 0.2 MHz, 1, conducted	S01_AB01	2021-05-26	Passed	Passed
NB-IoT, eFDD 85 QPSK, high channel, 0.2 MHz, 12, conducted	S01_AB01	2021-05-26	Passed	Passed
NB-IoT, eFDD 85 QPSK, low channel, 0.2 MHz, 12, conducted	S01_AB01	2021-05-26	Passed	Passed
NB-IoT, eFDD 85 QPSK, mid channel, 0.2 MHz, 12, conducted	S01_AB01	2021-05-26	Passed	Passed

47 CFR CHAPTER I FCC PART 27 Subpart C § 2.1051 § 27.53

Band edge compliance

The measurement was performed according to ANSI C63.26: 2015

Final Result

OP-Mode	Setup	Date	FCC	IC
Technology, Radio Technology, Operating Frequency, ChBW, Ressource Blocks, Measurement method				
CAT-M1, eFDD 66 QPSK, high channel, 1.4 MHz, 6, conducted	S01_AA01	2021-06-21	Passed	Passed
CAT-M1, eFDD 66 QPSK, low channel, 1.4 MHz, 6, conducted	S01_AA01	2021-06-21	Passed	Passed
CAT-M1, eFDD 71 QPSK, high channel, 1.4 MHz, 6, conducted	S01_AA01	2021-06-21	Passed	Passed
CAT-M1, eFDD 71 QPSK, low channel, 1.4 MHz, 6, conducted	S01_AA01	2021-06-21	Passed	Passed
CAT-M1, eFDD 8 QPSK, high channel, 1.4 MHz, 6, conducted	S01_AA01	2021-06-21	Passed	Passed
CAT-M1, eFDD 8 QPSK, low channel, 1.4 MHz, 6, conducted	S01_AA01	2021-06-21	Passed	Passed

47 CFR CHAPTER I FCC PART 27 Subpart C § 2.1051 § 27.53

Band edge compliance

The measurement was performed according to ANSI C63.26: 2015

Final Result

OP-Mode

Technology, Radio Technology, Operating Frequency, ChBW, Ressource Blocks, Measurement method

OP-Mode	Setup	Date	FCC	IC
CAT-M1, eFDD 66 QPSK, high channel, 1.4 MHz, 6, conducted	S01_AA01	2021-06-21	Passed	Passed
CAT-M1, eFDD 66 QPSK, low channel, 1.4 MHz, 6, conducted	S01_AA01	2021-06-21	Passed	Passed
CAT-M1, eFDD 66 16QAM, high channel, 1.4 MHz, 5, conducted	S01_AA01	2021-06-21	Passed	Passed
CAT-M1, eFDD 66 16QAM, low channel, 1.4 MHz, 5, conducted	S01_AA01	2021-06-21	Passed	Passed
CAT-M1, eFDD 71 QPSK, high channel, 1.4 MHz, 6, conducted	S01_AA01	2021-06-21	Passed	Passed
CAT-M1, eFDD 71 QPSK, low channel, 1.4 MHz, 6, conducted	S01_AA01	2021-06-21	Passed	Passed
CAT-M1, eFDD 71 16QAM, high channel, 1.4 MHz, 5, conducted	S01_AA01	2021-06-21	Passed	Passed
CAT-M1, eFDD 71 16QAM, low channel, 1.4 MHz, 5, conducted	S01_AA01	2021-06-21	Passed	Passed
CAT-M1, eFDD 8 QPSK, high channel, 1.4 MHz, 6, conducted	S01_AA01	2021-06-21	Passed	Passed
CAT-M1, eFDD 8 QPSK, low channel, 1.4 MHz, 6, conducted	S01_AA01	2021-06-21	Passed	Passed
CAT-M1, eFDD 8 16QAM, high channel, 1.4 MHz, 5, conducted	S01_AA01	2021-06-21	Passed	Passed
CAT-M1, eFDD 8 16QAM, low channel, 1.4 MHz, 5, conducted	S01_AA01	2021-06-21	Passed	Passed
NB-IoT, eFDD 12 BPSK, high channel, 0.2 MHz, 1, conducted	S01_AB01	2021-06-21	Passed	Passed
NB-IoT, eFDD 12 BPSK, low channel, 0.2 MHz, 1, conducted	S01_AB01	2021-06-21	Passed	Passed
NB-IoT, eFDD 12 QPSK, high channel, 0.2 MHz, 12, conducted	S01_AB01	2021-06-21	Passed	Passed
NB-IoT, eFDD 12 QPSK, low channel, 0.2 MHz, 12, conducted	S01_AB01	2021-06-21	Passed	Passed
NB-IoT, eFDD 13 BPSK, high channel, 0.2 MHz, 1, conducted	S01_AB01	2021-05-26	Passed	Passed
NB-IoT, eFDD 13 BPSK, low channel, 0.2 MHz, 1, conducted	S01_AB01	2021-05-26	Passed	Passed
NB-IoT, eFDD 13 QPSK, high channel, 0.2 MHz, 12, conducted	S01_AB01	2021-05-26	Passed	Passed
NB-IoT, eFDD 13 QPSK, low channel, 0.2 MHz, 12, conducted	S01_AB01	2021-05-26	Passed	Passed
NB-IoT, eFDD 4 BPSK, high channel, 0.2 MHz, 1, conducted	S01_AB01	2021-11-06	Passed	Passed
NB-IoT, eFDD 4 BPSK, low channel, 0.2 MHz, 1, conducted	S01_AB01	2021-11-06	Passed	Passed
NB-IoT, eFDD 4 QPSK, high channel, 0.2 MHz, 12, conducted	S01_AB01	2021-11-06	Passed	Passed
NB-IoT, eFDD 4 QPSK, low channel, 0.2 MHz, 12, conducted	S01_AB02	2021-05-07	Passed	Passed
NB-IoT, eFDD 66 BPSK, high channel, 0.2 MHz, 1, conducted	S01_AB01	2021-05-26	Passed	Passed
NB-IoT, eFDD 66 BPSK, low channel, 0.2 MHz, 1, conducted	S01_AB01	2021-05-26	Passed	Passed
NB-IoT, eFDD 66 QPSK, high channel, 0.2 MHz, 12, conducted	S01_AB01	2021-05-26	Passed	Passed
NB-IoT, eFDD 66 QPSK, low channel, 0.2 MHz, 12, conducted	S01_AB01	2021-05-26	Passed	Passed
NB-IoT, eFDD 71 BPSK, high channel, 0.2 MHz, 1, conducted	S01_AB02	2021-05-07	Passed	Passed
NB-IoT, eFDD 71 BPSK, low channel, 0.2 MHz, 1, conducted	S01_AB01	2021-06-21	Passed	Passed
NB-IoT, eFDD 71 QPSK, high channel, 0.2 MHz, 12, conducted	S01_AB01	2021-06-21	Passed	Passed
NB-IoT, eFDD 71 QPSK, low channel, 0.2 MHz, 12, conducted	S01_AB01	2021-06-21	Passed	Passed
NB-IoT, eFDD 8 BPSK, high channel, 0.2 MHz, 1, conducted	S01_AB01	2021-06-21	Passed	Passed
NB-IoT, eFDD 8 BPSK, low channel, 0.2 MHz, 1, conducted	S01_AB01	2021-06-21	Passed	Passed
NB-IoT, eFDD 8 QPSK, high channel, 0.2 MHz, 12, conducted	S01_AB01	2021-06-21	Passed	Passed
NB-IoT, eFDD 8 QPSK, low channel, 0.2 MHz, 12, conducted	S01_AB01	2021-06-21	Passed	Passed
NB-IoT, eFDD 85 BPSK, high channel, 0.2 MHz, 1, conducted	S01_AB01	2021-05-26	Passed	Passed
NB-IoT, eFDD 85 BPSK, low channel, 0.2 MHz, 1, conducted	S01_AB01	2021-05-26	Passed	Passed
NB-IoT, eFDD 85 QPSK, high channel, 0.2 MHz, 12, conducted	S01_AB01	2021-05-26	Passed	Passed
NB-IoT, eFDD 85 QPSK, low channel, 0.2 MHz, 12, conducted	S01_AB01	2021-05-26	Passed	Passed

47 CFR CHAPTER I FCC PART 27 Subpart C § 27.50

Peak to Average Ratio

The measurement was performed according to ANSI C63.26: 2015

Final Result

OP-Mode

Technology, Radio Technology, Operating Frequency, ChBW, Ressource Blocks, Measurement method

OP-Mode	Setup	Date	FCC	IC
CAT-M1, eFDD 66 QPSK, high channel, 1.4 MHz, 6, conducted	S01_AA01	2021-06-21	Passed	Passed
CAT-M1, eFDD 66 QPSK, low channel, 1.4 MHz, 6, conducted	S01_AA01	2021-06-21	Passed	Passed
CAT-M1, eFDD 66 QPSK, mid channel, 1.4 MHz, 6, conducted	S01_AA01	2021-06-21	Passed	Passed
CAT-M1, eFDD 71 QPSK, high channel, 1.4 MHz, 6, conducted	S01_AA01	2021-06-21	Passed	Passed
CAT-M1, eFDD 71 QPSK, low channel, 1.4 MHz, 6, conducted	S01_AA01	2021-06-21	Passed	Passed
CAT-M1, eFDD 71 QPSK, mid channel, 1.4 MHz, 6, conducted	S01_AA01	2021-06-21	Passed	Passed
CAT-M1, eFDD 8 QPSK, high channel, 1.4 MHz, 6, conducted	S01_AA01	2021-06-21	Passed	Passed
CAT-M1, eFDD 8 QPSK, low channel, 1.4 MHz, 6, conducted	S01_AA01	2021-06-21	Passed	Passed
CAT-M1, eFDD 8 QPSK, mid channel, 1.4 MHz, 6, conducted	S01_AA01	2021-06-21	Passed	Passed
NB-IoT, eFDD 12 BPSK, high channel, 0.2 MHz, 1, conducted	S01_AB02	2021-05-07	Passed	Passed
NB-IoT, eFDD 12 BPSK, low channel, 0.2 MHz, 1, conducted	S01_AB02	2021-05-07	Passed	Passed
NB-IoT, eFDD 12 BPSK, mid channel, 0.2 MHz, 1, conducted	S01_AB02	2021-05-07	Passed	Passed
NB-IoT, eFDD 12 QPSK, high channel, 0.2 MHz, 12, conducted	S01_AB02	2021-01-07	Passed	Passed
NB-IoT, eFDD 12 QPSK, low channel, 0.2 MHz, 12, conducted	S01_AB02	2021-01-07	Passed	Passed
NB-IoT, eFDD 12 QPSK, mid channel, 0.2 MHz, 12, conducted	S01_AB02	2021-01-07	Passed	Passed
NB-IoT, eFDD 13 BPSK, high channel, 0.2 MHz, 1, conducted	S01_AB02	2021-05-07	Passed	Passed
NB-IoT, eFDD 13 BPSK, low channel, 0.2 MHz, 1, conducted	S01_AB02	2021-05-07	Passed	Passed
NB-IoT, eFDD 13 BPSK, mid channel, 0.2 MHz, 1, conducted	S01_AB02	2021-05-07	Passed	Passed
NB-IoT, eFDD 13 QPSK, high channel, 0.2 MHz, 12, conducted	S01_AB02	2021-01-07	Passed	Passed
NB-IoT, eFDD 13 QPSK, low channel, 0.2 MHz, 12, conducted	S01_AB02	2021-01-07	Passed	Passed
NB-IoT, eFDD 13 QPSK, mid channel, 0.2 MHz, 12, conducted	S01_AB02	2021-01-07	Passed	Passed
NB-IoT, eFDD 4 BPSK, high channel, 0.2 MHz, 1, conducted	S01_AB02	2021-05-07	Passed	Passed
NB-IoT, eFDD 4 BPSK, low channel, 0.2 MHz, 1, conducted	S01_AB02	2021-05-07	Passed	Passed
NB-IoT, eFDD 4 BPSK, mid channel, 0.2 MHz, 1, conducted	S01_AB02	2021-05-07	Passed	Passed
NB-IoT, eFDD 4 QPSK, high channel, 0.2 MHz, 12, conducted	S01_AB02	2021-01-07	Passed	Passed
NB-IoT, eFDD 4 QPSK, low channel, 0.2 MHz, 12, conducted	S01_AB02	2021-01-07	Passed	Passed
NB-IoT, eFDD 4 QPSK, mid channel, 0.2 MHz, 12, conducted	S01_AB02	2021-01-07	Passed	Passed
NB-IoT, eFDD 66 BPSK, high channel, 0.2 MHz, 1, conducted	S01_AB02	2021-05-07	Passed	Passed
NB-IoT, eFDD 66 BPSK, low channel, 0.2 MHz, 1, conducted	S01_AB02	2021-05-07	Passed	Passed
NB-IoT, eFDD 66 BPSK, mid channel, 0.2 MHz, 1, conducted	S01_AB02	2021-05-07	Passed	Passed
NB-IoT, eFDD 66 QPSK, high channel, 0.2 MHz, 12, conducted	S01_AB02	2021-01-07	Passed	Passed
NB-IoT, eFDD 66 QPSK, low channel, 0.2 MHz, 12, conducted	S01_AB02	2021-01-07	Passed	Passed
NB-IoT, eFDD 66 QPSK, mid channel, 0.2 MHz, 12, conducted	S01_AB02	2021-01-07	Passed	Passed
NB-IoT, eFDD 71 BPSK, high channel, 0.2 MHz, 1, conducted	S01_AB02	2021-05-07	Passed	Passed
NB-IoT, eFDD 71 BPSK, low channel, 0.2 MHz, 1, conducted	S01_AB02	2021-05-07	Passed	Passed
NB-IoT, eFDD 71 BPSK, mid channel, 0.2 MHz, 1, conducted	S01_AB02	2021-05-07	Passed	Passed
NB-IoT, eFDD 71 QPSK, high channel, 0.2 MHz, 12, conducted	S01_AB02	2021-01-07	Passed	Passed
NB-IoT, eFDD 71 QPSK, low channel, 0.2 MHz, 12, conducted	S01_AB02	2021-01-07	Passed	Passed
NB-IoT, eFDD 71 QPSK, mid channel, 0.2 MHz, 12, conducted	S01_AB02	2021-01-07	Passed	Passed
NB-IoT, eFDD 8 BPSK, high channel, 0.2 MHz, 1, conducted	S01_AB02	2021-05-07	Passed	Passed
NB-IoT, eFDD 8 BPSK, low channel, 0.2 MHz, 1, conducted	S01_AB02	2021-05-07	Passed	Passed
NB-IoT, eFDD 8 BPSK, mid channel, 0.2 MHz, 1, conducted	S01_AB02	2021-05-07	Passed	Passed
NB-IoT, eFDD 8 QPSK, high channel, 0.2 MHz, 12, conducted	S01_AB02	2021-01-07	Passed	Passed
NB-IoT, eFDD 8 QPSK, low channel, 0.2 MHz, 12, conducted	S01_AB02	2021-01-07	Passed	Passed
NB-IoT, eFDD 8 QPSK, mid channel, 0.2 MHz, 12, conducted	S01_AB02	2021-01-07	Passed	Passed
NB-IoT, eFDD 85 BPSK, high channel, 0.2 MHz, 1, conducted	S01_AB02	2021-05-07	Passed	Passed

47 CFR CHAPTER I FCC PART 27 Subpart C § 27.50

Peak to Average Ratio

The measurement was performed according to ANSI C63.26: 2015

Final Result

OP-Mode

Technology, Radio Technology, Operating Frequency, ChBW, Ressource Blocks, Measurement method

	Setup	Date	FCC	IC
NB-IoT, eFDD 85 BPSK, low channel, 0.2 MHz, 1, conducted	S01_AB02	2021-05-07	Passed	Passed
NB-IoT, eFDD 85 BPSK, mid channel, 0.2 MHz, 1, conducted	S01_AB02	2021-05-07	Passed	Passed
NB-IoT, eFDD 85 QPSK, high channel, 0.2 MHz, 12, conducted	S01_AB02	2021-01-07	Passed	Passed
NB-IoT, eFDD 85 QPSK, low channel, 0.2 MHz, 12, conducted	S01_AB02	2021-01-07	Passed	Passed
NB-IoT, eFDD 85 QPSK, mid channel, 0.2 MHz, 12, conducted	S01_AB02	2021-01-07	Passed	Passed

N/A: Not applicable

N/P: Not performed

2 REVISION HISTORY / SIGNATURES

Report version control			
Version	Release date	Change Description	Version validity
initial	2021-07-13	--	valid
--	--	--	--

COMMENT: -

Only spot checks were performed for this test report for the bands LTE CAT-M1 eFDD 2 / 4 / 5 / 12 / 13 / 25 / 26. The complete test results for these bands are listed in the report MDE_UBLOX_1905_FCC_01_rev01.

Only spot checks were performed for the child products.

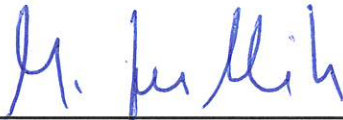

(responsible for accreditation scope)
Dipl.-Ing. Marco Kullik

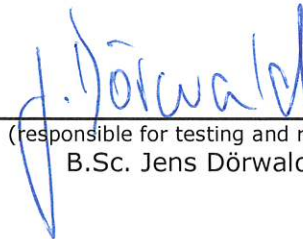

(responsible for testing and report)
B.Sc. Jens Dörwald



7 layers GmbH, Borsigstr. 11
40880 Ratingen, Germany
Phone +49 (0)2102 749 0

3 ADMINISTRATIVE DATA

3.1 TESTING LABORATORY

Company Name: 7layers GmbH
Address: Borsigstr. 11
40880 Ratingen
Germany

The test facility is accredited by the following accreditation organisation:

Laboratory accreditation no: DAKKS D-PL-12140-01-01| -02 | -03
FCC Designation Number: DE0015
FCC Test Firm Registration: 929146
ISED CAB Identifier DE0007; ISED#: 3699A

Responsible for accreditation scope: Dipl.-Ing. Marco Kullik

Report Template Version: 2020-06-15

3.2 PROJECT DATA

Responsible for testing and report: B.Sc. Jens Dörwald
Employees who performed the tests: documented internally at 7Layers
Date of Report: 2021-07-13
Testing Period: 2021-01-07 to 2021-07-07

3.3 APPLICANT DATA

Company Name: u-blox AG
Address: Zürcherstrasse 68
8800 Thalwil
Switzerland
Contact Person: Mr. Giulio Comar

3.4 MANUFACTURER DATA

Company Name: please see Applicant Data
Address:
Contact Person:

4 TEST OBJECT DATA

4.1 GENERAL EUT DESCRIPTION

Kind of Device product description	LTE CAT-M1 / NB-IoT module.
Product name	SARA-R510M8S
Type	SARA-R510M8S SARA-R510S SARA-R500S
Declared EUT data by the supplier	
Power Supply Type	DC
General product description	The EUT is LTE CAT-M1 / NB-IoT module. It supports the following relevant bands for FCC Approval CAT-M1: eFDD2 / LTE eFDD4 / eFDD5 / eFDD8 / eFDD12 / eFDD13 / eFDD25 / eFDD26 / eFDD66 / eFDD71 NB-IoT: eFDD2 / LTE eFDD4 / eFDD5 / eFDD8 / eFDD12 / eFDD13 / eFDD66 / eFDD71 / eFDD85
Nominal Voltage / Frequency	3.8 V DC

4.2 EUT MAIN COMPONENTS

Sample Name	Sample Code	Description
EUT A	DE1015140aa01	SARA-R510M8S
Sample Parameter	Value	
Serial No.	352709570010223	
HW Version	UBX-352L00	
SW Version	03.11, A00.01	
Comment	-	

Sample Name	Sample Code	Description
EUT B	DE1015140ab01	SARA-R510M8S
Sample Parameter	Value	
Serial No.	352709570012310	
HW Version	UBX-352L00	
SW Version	03.11, A00.01	
Comment	-	

Sample Name	Sample Code	Description
EUT C	DE1015140ab02	SARA-R510M8S
Sample Parameter	Value	
Serial No.	352709570012310	
HW Version	UBX-352L00	
SW Version	03.13, A00.01	
Comment	-	

Sample Name	Sample Code	Description
EUT D	DE1015141bb01	SARA-R500S
Sample Parameter	Value	
Serial No.	352107200011911	
HW Version	UBX-352LB0	
SW Version	03.11, A00.01	
Comment	Child product	

Sample Name	Sample Code	Description
EUT E	DE1015142cb01	SARA-R510S
Sample Parameter	Value	
Serial No.	351457830012313	
HW Version	UBX-352LA0	
SW Version	03.11, A00.01	
Comment	Child product	

NOTE: The short description is used to simplify the identification of the EUT in this test report.

4.3 ANCILLARY EQUIPMENT

For the purposes of this test report, ancillary equipment is defined as equipment which is used in conjunction with the EUT to provide operational and control features to the EUT. It is necessary to configure the system in a typical fashion, as a customer would normally use it. But nevertheless Ancillary Equipment can influence the test results.

Device	Details (Manufacturer, Type Model, OUT Code)	Description
-	-	-

4.4 AUXILIARY EQUIPMENT

For the purposes of this test report, auxiliary equipment is defined as equipment which is used temporarily to enable operational and control features especially used for the tests of the EUT which is not used during normal operation or equipment that is used during the tests in combination with the EUT but is not subject of this test report. It is necessary to configure the system in a typical fashion, as a customer would normally use it. But nevertheless Auxiliary Equipment can influence the test results.

Device	Details (Manufacturer, Type Model, HW, SW, S/N)	Description
-	-	-

4.5 EUT SETUPS

This chapter describes the combination of EUTs and equipment used for testing. The rationale for selecting the EUTs, ancillary and auxiliary equipment and interconnecting cables, is to test a representative configuration meeting the requirements of the referenced standards.

Setup	Combination of EUTs	Description and Rationale
S01_AA01	EUT A	RF Sample
S01_AB01	EUT B	RF Sample
S01_AB02	EUT C	RF Sample
S01_BB01	EUT D	RF Sample (child product)
S01_CB01	EUT E	RF Sample (child product)

4.6 OPERATING MODES / TEST CHANNELS

This chapter describes the operating modes of the EUTs used for testing.

CAT-M1 eFDD 2		LOW	MID	HIGH	LOW	MID	HIGH	LOW	MID	HIGH
	Cell BW [MHz]	1.4	1.4	1.4	3	3	3	5	5	5
	CH no.	18607	18900	19193	18615	18900	19185	18625	18900	19175
	f [MHz]	1850.7	1880.0	1909.3	1851.5	1880.0	1908.5	1852.5	1880.0	1907.5
	LOW	MID	HIGH	LOW	MID	HIGH	LOW	MID	HIGH	
Cell BW [MHz]	10	10	10	-	-	-	-	-	-	
CH no.	18650	18900	19150	-	-	-	-	-	-	
f [MHz]	1855.0	1880.0	1905.0	-	-	-	-	-	-	

CAT-M1 eFDD 4		LOW	MID	HIGH	LOW	MID	HIGH	LOW	MID	HIGH
	Cell BW [MHz]	1.4	1.4	1.4	3	3	3	5	5	5
	CH no.	19957	20175	20393	19965	20175	20385	19975	20175	20375
	f [MHz]	1710.7	1732.5	1754.3	1711.5	1732.5	1753.5	1712.5	1732.5	1752.5
	LOW	MID	HIGH	LOW	MID	HIGH	LOW	MID	HIGH	
Cell BW [MHz]	10	10	10	-	-	-	-	-	-	
CH no.	20000	20175	20350	-	-	-	-	-	-	
f [MHz]	1715.0	1732.5	1750.0	-	-	-	-	-	-	

CAT-M1 eFDD 5		LOW	MID	HIGH	LOW	MID	HIGH	LOW	MID	HIGH
	Cell BW [MHz]	1.4	1.4	1.4	3	3	3	5	5	5
	CH no.	20407	20525	20643	20415	20525	20635	20425	20525	20625
	f [MHz]	824.7	836.5	848.3	825.5	836.5	847.5	826.5	836.5	846.5
	LOW	MID	HIGH	LOW	MID	HIGH	LOW	MID	HIGH	
Cell BW [MHz]	10	10	10	-	-	-	-	-	-	
CH no.	20450	20525	20600	-	-	-	-	-	-	
f [MHz]	829.0	836.5	844.0	-	-	-	-	-	-	

CAT-M1 eFDD 8		LOW	MID	HIGH	LOW	MID	HIGH	LOW	MID	HIGH
	Cell BW [MHz]	1.4	1.4	1.4	-	3	-	-	-	-
	CH no.	21632	21640	21648	-	20525	-	-	-	-
	f [MHz]	898.2	899.0	899.8	-	899.0	-	-	-	-
	LOW	MID	HIGH	LOW	MID	HIGH	LOW	MID	HIGH	
Cell BW [MHz]	-	-	-	-	-	-	-	-	-	
CH no.	-	-	-	-	-	-	-	-	-	
f [MHz]	-	-	-	-	-	-	-	-	-	

CAT-M1 eFDD 12		LOW	MID	HIGH	LOW	MID	HIGH	LOW	MID	HIGH
	Cell BW [MHz]	1.4	1.4	1.4	3	3	3	5	5	5
	CH no.	23017	23095	23173	23025	23095	23165	23035	23095	23155
	f [MHz]	699.7	707.5	715.3	700.5	707.5	714.5	701.5	707.5	713.5
		LOW	MID	HIGH	LOW	MID	HIGH	LOW	MID	HIGH
	Cell BW [MHz]	10	10	10	-	-	-	-	-	-
	CH no.	23060	23095	23130	-	-	-	-	-	-
f [MHz]	704.0	707.5	711.0	-	-	-	-	-	-	

CAT-M1 eFDD 13		LOW	MID	HIGH	LOW	MID	HIGH	LOW	MID	HIGH
	Cell BW [MHz]	5	5	5	10	10	10	-	-	-
	CH no.	23205	23230	23255	-	23230	-	-	-	-
	f [MHz]	779.5	782.0	784.5	-	782.0	-	-	-	-
		LOW	MID	HIGH	LOW	MID	HIGH	LOW	MID	HIGH
	Cell BW [MHz]	-	-	-	-	-	-	-	-	-
	CH no.	-	-	-	-	-	-	-	-	-
f [MHz]	-	-	-	-	-	-	-	-	-	

CAT-M1 eFDD 25		LOW	MID	HIGH	LOW	MID	HIGH	LOW	MID	HIGH
	Cell BW [MHz]	1.4	1.4	1.4	3	3	3	5	5	5
	CH no.	26047	26365	26683	26055	26365	26675	26065	26365	26665
	f [MHz]	1850.7	1882.5	1914.3	1851.5	1882.5	1913.5	1852.5	1882.5	1912.5
		LOW	MID	HIGH	LOW	MID	HIGH	LOW	MID	HIGH
	Cell BW [MHz]	10	10	10	-	-	-	-	-	-
	CH no.	26090	26365	26640	-	-	-	-	-	-
f [MHz]	1855.0	1882.5	1910.0	-	-	-	-	-	-	

CAT-M1 eFDD 26 (Part 22)		LOW	MID	HIGH	LOW	MID	HIGH	LOW	MID	HIGH
	Cell BW [MHz]	1.4	1.4	1.4	3	3	3	5	5	5
	CH no.	26797	26915	27033	26805	26915	27025	26815	26915	27015
	f [MHz]	824.7	836.5	848.3	825.5	836.5	847.5	826.5	836.5	846.5
		LOW	MID	HIGH	LOW	MID	HIGH	LOW	MID	HIGH
	Cell BW [MHz]	10	10	10	-	-	-	-	-	-
	CH no.	26840	26915	26990	-	-	-	-	-	-
f [MHz]	829.0	836.5	844	-	-	-	-	-	-	

CAT-M1 eFDD 66		LOW	MID	HIGH	LOW	MID	HIGH	LOW	MID	HIGH
	Cell BW [MHz]	1.4	1.4	1.4	3	3	3	5	5	5
	CH no.	131979	132322	132665	131987	132322	132657	131997	132322	132647
	f [MHz]	1710.7	1745.0	1779.3	1711.5	1745.0	1778.5	1712.5	1745.0	1777.5
		LOW	MID	HIGH	LOW	MID	HIGH	LOW	MID	HIGH
	Cell BW [MHz]	10	10	10	-	-	-	-	-	-
	CH no.	132022	132322	132622	-	-	-	-	-	-
f [MHz]	1715.0	1745.0	1775.0	-	-	-	-	-	-	

CAT-M1 eFDD 71		LOW	MID	HIGH	LOW	MID	HIGH	LOW	MID	HIGH
	Cell BW [MHz]	1.4	1.4	1.4	3	3	3	5	5	5
	CH no.	133129	133297	133465	133172	133297	133422	133197	133297	133397
	f [MHz]	663.7	680.5	697.3	668	680.5	693	670.5	680.5	690.5
		LOW	MID	HIGH	LOW	MID	HIGH	LOW	MID	HIGH
	Cell BW [MHz]	10	10	10	-	-	-	-	-	-
	CH no.	133222	133297	133372	-	-	-	-	-	-
f [MHz]	673	680.5	688	-	-	-	-	-	-	

NB-IoT eFDD 2		LOW	MID	HIGH
	Cell BW [MHz]	0.2	0.2	0.2
	CH no.	18601	18900	19199
	f [MHz]	1850.1	1880.0	1909.9

NB-IoT eFDD 4		LOW	MID	HIGH
	Cell BW [MHz]	0.2	0.2	0.2
	CH no.	19951	20175	20399
	f [MHz]	1710.1	1745.5	1754.9

NB-IoT eFDD 5		LOW	MID	HIGH
	Cell BW [MHz]	0.2	0.2	0.2
	CH no.	20401	20525	20649
	f [MHz]	824.1	836.5	848.9

NB-IoT eFDD 8		LOW	MID	HIGH
	Cell BW [MHz]	0.2	0.2	0.2
	CH no.	21626	21640	21654
	f [MHz]	897.6	899.0	900.4

NB-IoT eFDD 12		LOW	MID	HIGH
	Cell BW [MHz]	0.2	0.2	0.2
	CH no.	23011	23095	23178
	f [MHz]	699.1	707.5	715.8

NB-IoT eFDD 13		LOW	MID	HIGH
	Cell BW [MHz]	0.2	0.2	0.2
	CH no.	23181	23230	23279
	f [MHz]	777.1	782.0	786.9

NB-IoT eFDD 66		LOW	MID	HIGH
	Cell BW [MHz]	0.2	0.2	0.2
	CH no.	131973	132322	132671
	f [MHz]	1710.1	1745.0	1779.9

NB-IoT eFDD 71		LOW	MID	HIGH
	Cell BW [MHz]	0.2	0.2	0.2
	CH no.	133124	133297	133470
	f [MHz]	663.2	680.5	697.8

NB-IoT eFDD 85		LOW	MID	HIGH
	Cell BW [MHz]	0.2	0.2	0.2
	CH no.	134004	134092	134180
	f [MHz]	698.2	707.0	715.8

4.7 PRODUCT LABELLING

4.7.1 FCC ID LABEL

Please refer to the documentation of the applicant.

4.7.2 LOCATION OF THE LABEL ON THE EUT

Please refer to the documentation of the applicant.

5 TEST RESULTS

5.1 RF OUTPUT POWER

Standard **FCC PART 22 Subpart H**

The test was performed according to:
ANSI C63.26: 2015

5.1.1 TEST DESCRIPTION

This test case is intended to demonstrate compliance to the applicable RF Output power test case per § 2.1046 and RSS-GEN 6.12. The limit and the requirements come from the applicable rule part and ISED RSS-Standard for the operating band of the cellular device.

The EUT was connected to the test setup according to the following diagram:

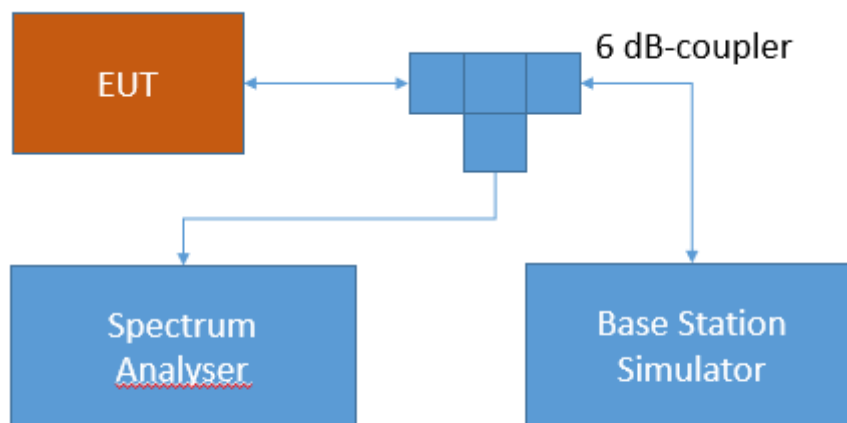

Test Setup FCC Part 22/24/27/90 Cellular;
RF Output power

The attenuation of the measuring and stimulus path are known for each measured frequency and are considered.

The Spectrum Analyzer settings can be directly found in the measurement diagrams.

5.1.2 TEST REQUIREMENTS / LIMITS

FCC Part 22, § 22.913

(a) *Maximum ERP.* The ERP of transmitters in the Cellular Radiotelephone Service must not exceed the limits in this section.

(5) The ERP of mobile transmitters and auxiliary test transmitters must not exceed 7 watts.

RSS-132; 5.4 Transmitter Output Power and Equivalent Isotropically Radiated Power

The transmitter output power shall be measured in terms of average power. The equivalent isotropically radiated power (e.i.r.p.) for mobile equipment shall not exceed 11.5 watts.

5.1.3 TEST PROTOCOL

Temperature 20 – 25 °C

Humidity 30 - 40 %

Radio Technology	Channel	Re-source Blocks / Sub-carrier	Band-width [MHz]	RMS Cond. Power [dBm]	FCC EIRP Limit [W]	IC EIRP Limit [W]	Max. Antenna Gain FCC [dBi]	Max. Antenna Gain IC [dBi]
CAT-M1 eFDD 5 QPSK	mid	1	1.4	22.63	11.5	11.5	17.97	17.97
CAT-M1 eFDD 5 QPSK	mid	3	1.4	21.43	11.5	11.5	19.17	19.17
CAT-M1 eFDD 5 QPSK	mid	6	1.4	20.52	11.5	11.5	20.08	20.08
CAT-M1 eFDD 5 16QAM	mid	1	1.4	21.10	11.5	11.5	19.50	19.50
CAT-M1 eFDD 5 16QAM	mid	5	1.4	20.73	11.5	11.5	19.87	19.87
CAT-M1 eFDD 5 QPSK	mid	1	3	22.62	11.5	11.5	17.98	17.98
CAT-M1 eFDD 5 QPSK	mid	3	3	21.37	11.5	11.5	19.23	19.23
CAT-M1 eFDD 5 QPSK	mid	6	3	20.45	11.5	11.5	20.15	20.15
CAT-M1 eFDD 5 16QAM	mid	1	3	21.14	11.5	11.5	19.46	19.46
CAT-M1 eFDD 5 16QAM	mid	5	3	20.68	11.5	11.5	19.92	19.92
CAT-M1 eFDD 5 QPSK	mid	1	5	22.48	11.5	11.5	18.12	18.12
CAT-M1 eFDD 5 QPSK	mid	6	5	21.34	11.5	11.5	19.26	19.26
CAT-M1 eFDD 5 16QAM	mid	1	5	21.46	11.5	11.5	19.14	19.14
CAT-M1 eFDD 5 16QAM	mid	5	5	22.14	11.5	11.5	18.46	18.46
CAT-M1 eFDD 5 QPSK	mid	1	10	20.63	11.5	11.5	19.97	19.97
CAT-M1 eFDD 5 QPSK	mid	3	10	22.61	11.5	11.5	17.99	17.99
CAT-M1 eFDD 5 QPSK	mid	6	10	22.47	11.5	11.5	18.13	18.13
CAT-M1 eFDD 5 16QAM	mid	1	10	21.45	11.5	11.5	19.15	19.15
CAT-M1 eFDD 5 16QAM	mid	5	10	22.22	11.5	11.5	18.38	18.38
CAT-M1 eFDD 26 QPSK	mid	1	1.4	21.66	11.5	11.5	18.94	18.94
CAT-M1 eFDD 26 QPSK	mid	3	1.4	22.63	11.5	11.5	17.97	17.97
CAT-M1 eFDD 26 QPSK	mid	6	1.4	21.43	11.5	11.5	19.17	19.17
CAT-M1 eFDD 26 16QAM	mid	1	1.4	20.49	11.5	11.5	20.11	20.11
CAT-M1 eFDD 26 16QAM	mid	5	1.4	21.09	11.5	11.5	19.51	19.51
CAT-M1 eFDD 26 QPSK	mid	1	3	20.69	11.5	11.5	19.91	19.91
CAT-M1 eFDD 26 QPSK	mid	3	3	22.60	11.5	11.5	18.00	18.00
CAT-M1 eFDD 26 QPSK	mid	6	3	21.37	11.5	11.5	19.23	19.23
CAT-M1 eFDD 26 16QAM	mid	1	3	20.45	11.5	11.5	20.15	20.15
CAT-M1 eFDD 26 16QAM	mid	5	3	21.10	11.5	11.5	19.50	19.50
CAT-M1 eFDD 26 QPSK	mid	1	5	20.66	11.5	11.5	19.94	19.94
CAT-M1 eFDD 26 QPSK	mid	3	5	22.53	11.5	11.5	18.07	18.07
CAT-M1 eFDD 26 QPSK	mid	6	5	21.36	11.5	11.5	19.24	19.24
CAT-M1 eFDD 26 16QAM	mid	1	5	21.44	11.5	11.5	19.16	19.16
CAT-M1 eFDD 26 16QAM	mid	5	5	22.18	11.5	11.5	18.42	18.42
CAT-M1 eFDD 26 QPSK	mid	1	10	20.63	11.5	11.5	19.97	19.97
CAT-M1 eFDD 26 QPSK	mid	3	10	22.58	11.5	11.5	18.02	18.02
CAT-M1 eFDD 26 QPSK	mid	6	10	22.48	11.5	11.5	18.12	18.12
CAT-M1 eFDD 26 16QAM	mid	1	10	21.45	11.5	11.5	19.15	19.15
CAT-M1 eFDD 26 16QAM	mid	5	10	22.27	11.5	11.5	18.33	18.33
NB-IoT eFDD 5 QPSK	low	1	0.2	22.46	11.5	11.5	18.14	18.14
NB-IoT eFDD 5 QPSK	low	3	0.2	22.14	11.5	11.5	18.46	18.46
NB-IoT eFDD 5 QPSK	low	6	0.2	22.23	11.5	11.5	18.37	18.37
NB-IoT eFDD 5 QPSK	low	12	0.2	21.21	11.5	11.5	19.39	19.39
NB-IoT eFDD 5 QPSK	mid	1	0.2	22.51	11.5	11.5	18.09	18.09
NB-IoT eFDD 5 QPSK	mid	3	0.2	22.15	11.5	11.5	18.45	18.45

NB-IoT eFDD 5 QPSK	mid	6	0.2	22.35	11.5	11.5	18.25	18.25
NB-IoT eFDD 5 QPSK	mid	12	0.2	21.31	11.5	11.5	19.29	19.29
NB-IoT eFDD 5 QPSK	high	1	0.2	22.61	11.5	11.5	17.99	17.99
NB-IoT eFDD 5 QPSK	high	3	0.2	22.22	11.5	11.5	18.38	18.38
NB-IoT eFDD 5 QPSK	high	6	0.2	22.4	11.5	11.5	18.20	18.20
NB-IoT eFDD 5 QPSK	high	12	0.2	21.36	11.5	11.5	19.24	19.24
NB-IoT eFDD 5 BPSK	low	1	0.2	22.52	11.5	11.5	18.08	18.08
NB-IoT eFDD 5 BPSK	mid	1	0.2	22.49	11.5	11.5	18.11	18.11
NB-IoT eFDD 5 BPSK	high	1	0.2	22.58	11.5	11.5	18.02	18.02

Remark: Please see next sub-clause for the measurement plot.

5.1.4 MEASUREMENT PLOT (EXAMPLE PLOT, SHOWING WORST CASE, IF APPLICABLE)

CAT-M1 eFDD5 QPSK 1.4MHz RB1, Channel = mid

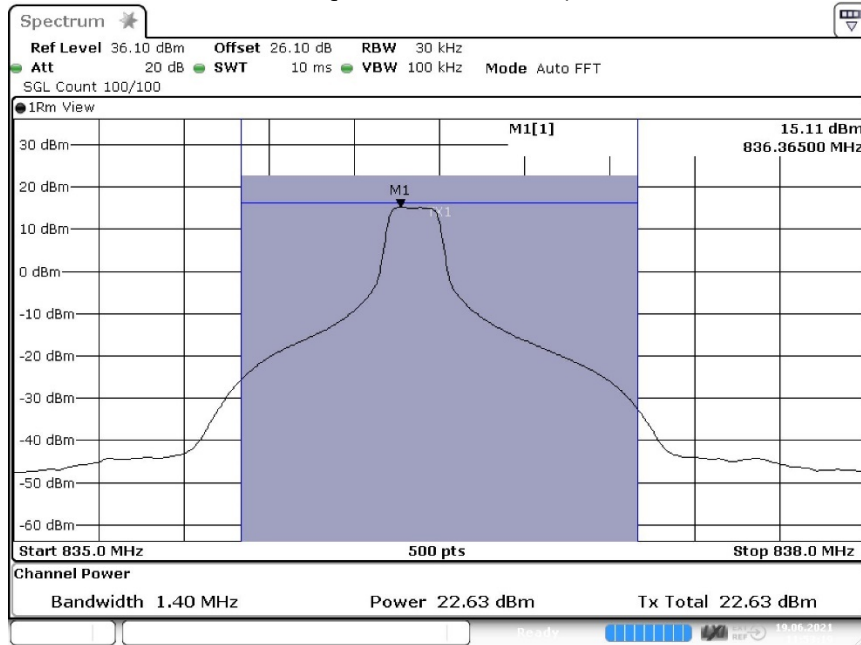

CAT-M1 eFDD26 QPSK 1.4MHz RB1, Channel = mid

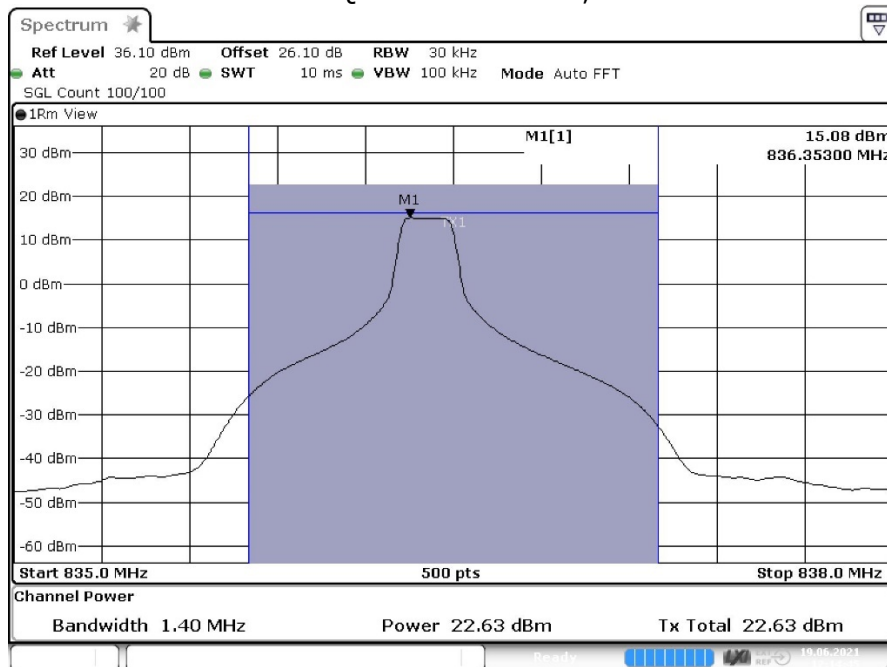

NB-IoT eFDD5 QPSK Subcarrier 1, Channel = mid

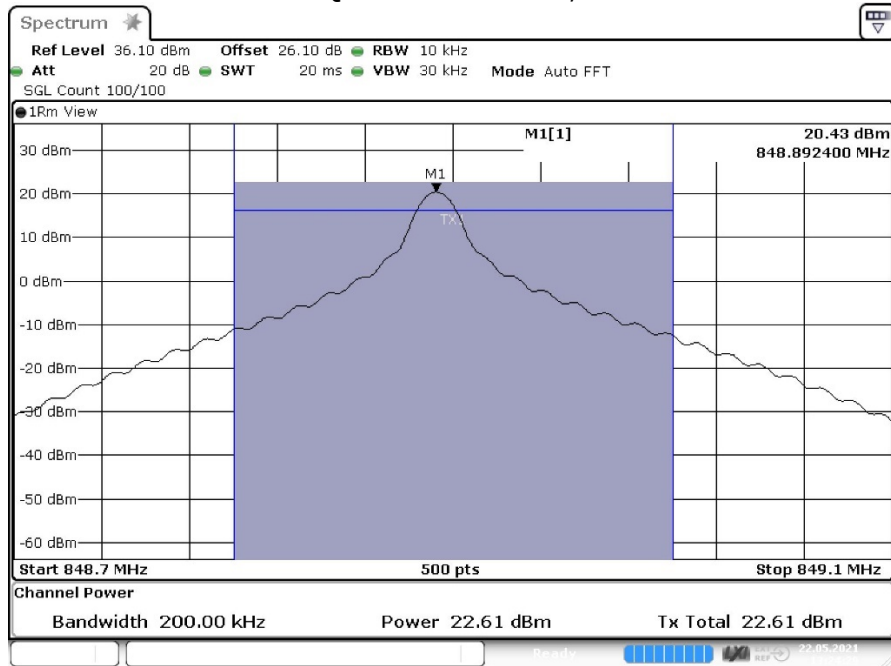

Date: 22.MAY.2021 13:24:29

5.1.5 TEST EQUIPMENT USED

- Radio Lab

5.2 FREQUENCY STABILITY

Standard **FCC PART 22 Subpart H**

The test was performed according to:
ANSI C63.26: 2015

5.2.1 TEST DESCRIPTION

This test case is intended to demonstrate compliance to the applicable frequency stability test case per § 2.1055 and RSS-GEN 6.11. The limit and the requirements come from the applicable rule part and ISED RSS-Standard for the operating band of the cellular device.

The EUT was connected to the test setup according to the following diagram:



Test Setup FCC Part 22/24/27/90 Cellular;
Frequency stability

The attenuation of the measuring / stimulus path is known for each measured frequency and are considered.

5.2.2 TEST REQUIREMENTS / LIMITS

FCC Part 22, § 22.355

Except as otherwise provided in this part, the carrier frequency of each transmitter in the Public Mobile Services must be maintained within the tolerances given in Table C-1 of this section.

Table C-1—Frequency Tolerance for Transmitters in the Public Mobile Services

Frequency Range [MHz]	Mobile Devices > 3 W [ppm]	Mobile Devices ≤ 3 W [ppm]
25 – 50	20.0	50.0
50 – 450	5.0	50.0
450 – 512	5.0	5.0

821 – 896	2.5	2.5
928 - 929	n/a	n/a
929 – 960	n/a	n/a
2110 - 2220	n/a	n/a

RSS-132; 5.3 Frequency Stability

The carrier frequency shall not depart from the reference frequency in excess of ± 2.5 ppm for mobile stations.

In lieu of meeting the above stability values, the test report may show that the frequency stability is sufficient to ensure that the occupied bandwidth stays within each of the sub-bands (see Section 5.1) when tested to the temperature and supply voltage variations specified in RSS-Gen.

5.2.3 TEST PROTOCOL

NB-IoT eFDD5

Temp. °C	Duration min	Voltage	Limit Hz	Freq. error Average (Hz)	Freq. error Max. (Hz)	Verdict
-30	0	normal	2091.25	7	25	passed
-30	5			8	14	passed
-30	10			4	31	passed
-20	0	normal	2091.25	6	11	passed
-20	5			8	15	passed
-20	10			5	24	passed
-10	0	normal	2091.25	9	13	passed
-10	5			11	26	passed
-10	10			7	17	passed
0	0	normal	2091.25	5	18	passed
0	5			4	26	passed
0	10			8	24	passed
10	0	normal	2091.25	9	30	passed
10	5			10	15	passed
10	10			7	21	passed
20	0	low	2091.25	9	28	passed
20	5			11	26	passed
20	10			6	23	passed
20	0	normal	2091.25	7	20	passed
20	5			7	18	passed
20	10			9	22	passed
20	0	high	2091.25	4	34	passed
20	5			8	25	passed
20	10			6	23	passed
30	0	normal	2091.25	7	16	passed
30	5			6	18	passed
30	10			6	22	passed
40	0	normal	2091.25	8	29	passed
40	5			6	28	passed
40	10			9	15	passed
50	0	normal	2091.25	7	14	passed
50	5			6	19	passed
50	10			8	23	passed

Remark: Please see next sub-clause for the measurement plot.

5.2.4 TEST EQUIPMENT USED

- Radio Lab

5.3 SPURIOUS EMISSIONS AT ANTENNA TERMINALS

Standard **FCC PART 22 Subpart H**

The test was performed according to:
ANSI C63.26: 2015

5.3.1 TEST DESCRIPTION

This test case is intended to demonstrate compliance to the applicable conducted spurious emission test case per § 2.1051 and RSS-GEN 6.13. The limit comes from the applicable rule part and ISED RSS-Standard for the operating band of the cellular device.

The EUT was connected to the test setup according to the following diagram:

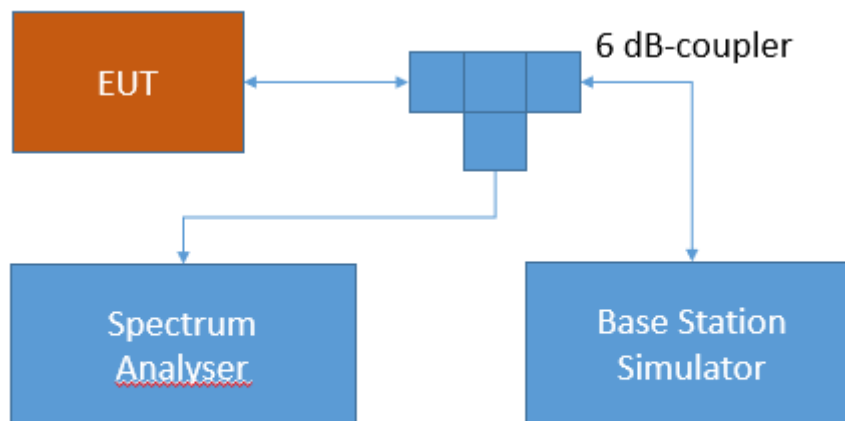

Test Setup FCC Part 22/24/27/90 Cellular;
Spurious Emissions at antenna terminal

The attenuation of the measuring and stimulus path are known for each measured frequency and are considered.

The Spectrum Analyzer settings can be directly found in the measurement diagrams.

5.3.2 TEST REQUIREMENTS / LIMITS

FCC Part 2.1051; Measurement required: Spurious emissions at antenna terminal:

The radio frequency voltage or powers generated within the equipment and appearing on a spurious frequency shall be checked at the equipment output terminals when properly loaded with a suitable artificial antenna. Curves or equivalent data shall show the magnitude of each harmonic and other spurious emission that can be detected when the equipment is operated

under the conditions specified in §2.1049 as appropriate. The magnitude of spurious emissions which are attenuated more than 20 dB below the permissible value need not be specified.

Part 22, Subpart H – Cellular Radiotelephone Service

§22 917 – Emission limitations for cellular equipment

(a) *Out of band emissions.* The power of any emission outside of the authorized operating frequency ranges must be attenuated below the transmitting power (P) by a factor of at least $43 + 10 \log(P)$ dB.

RSS-132; 5.5 Transmitter Unwanted Emissions

Mobile and base station equipment shall comply with the limits in (i) and (ii) below.

1. In the first 1.0 MHz band immediately outside and adjacent to each of the sub-bands specified in Section 5.1, the power of emissions per any 1% of the occupied bandwidth shall be attenuated (in dB) below the transmitter output power P (dBW) by at least $43 + 10 \log_{10}p$ (watts).
2. After the first 1.0 MHz immediately outside and adjacent to each of the sub-bands, the power of emissions in any 100 kHz bandwidth shall be attenuated (in dB) below the transmitter output power P (dBW) by at least $43 + 10 \log_{10} p$ (watts). If the measurement is performed using 1% of the occupied bandwidth, power integration over 100 kHz is required.

5.3.3 TEST PROTOCOL

Temperature 20 – 25 °C
Humidity 30 - 40 %

Radio Technology	Channel	Detector	Trace	Resolution Bandwidth /kHz	Frequency /MHz	Peak Value /dBm	Limit /dBm	Margin to Limit /dB
NB-IoT eFDD5	low	rms	maxhold	2	823.98	-24.75	-13	11.75
NB-IoT eFDD5	mid	rms	maxhold	-	-	-	-13	>20
NB-IoT eFDD5	high	rms	maxhold	2	849.01	-20.41	-13	7.41

Remark: Please see next sub-clause for the measurement plot.

5.3.4 MEASUREMENT PLOT (EXAMPLE PLOT, SHOWING WORST CASE, IF APPLICABLE)

NB-IoT eFDD5, Channel = high

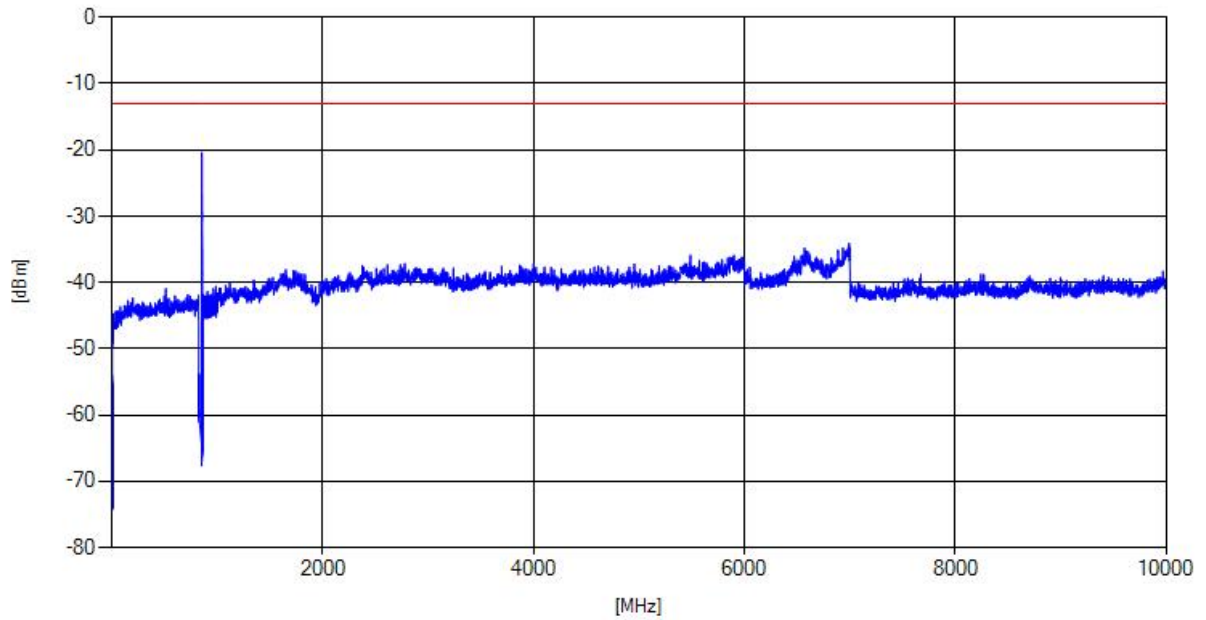

5.3.5 TEST EQUIPMENT USED

- Radio Lab

5.4 FIELD STRENGTH OF SPURIOUS RADIATION

Standard **FCC PART 22 Subpart H**

The test was performed according to:
ANSI C63.26: 2015

5.4.1 TEST DESCRIPTION

This test case is intended to demonstrate compliance to the applicable radiated spurious emission measurements per § 2.1053 and RSS-GEN 6.13. The limit and requirements come from the applicable rule part and ISED RSS-Standard for the operating band of the cellular device.

The EUT was connected to the test setup according to the following diagram:

Frequency Range: 30 MHz – 1 GHz:

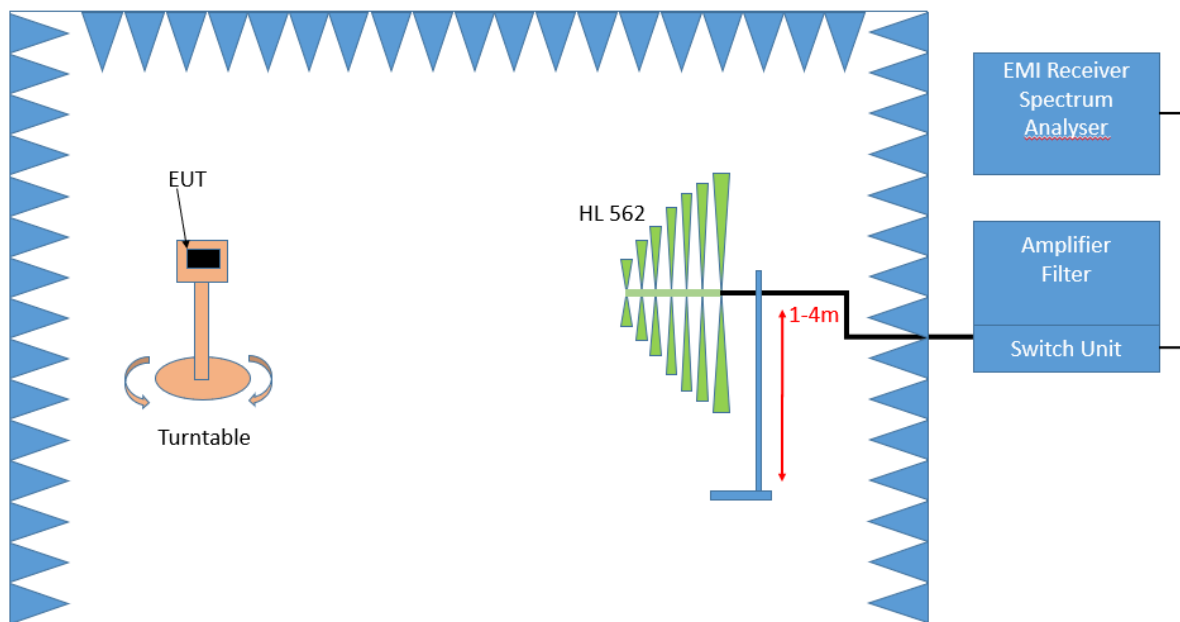

Test Setup; Spurious Emission Radiated (SAC), 30 MHz- 1GHz

Frequency Range: 1 GHz – 26.5 GHz

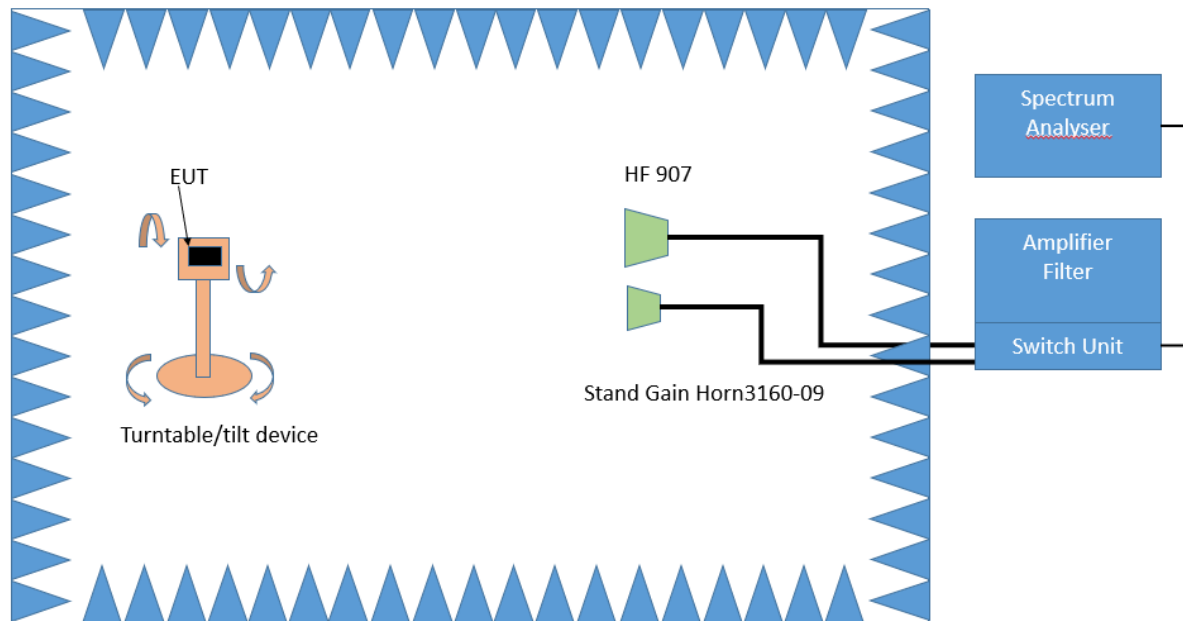

Test Setup; Spurious Emission Radiated (FAC), 1 GHz-26.5 GHz

The test set-up was made in accordance to the general provisions of ANSI C63.26 in a typical installation configuration. The Equipment Under Test (EUT) was set up on a non-conductive table 1.0 x 2.0 m² in the semi-anechoic chamber. The influence of the EUT support table that is used between 30–1000 MHz was evaluated.

The measurement procedure is implemented into the EMI test software EMC32 from R&S. Exploratory tests are performed at 3 orthogonal axes to determine the worst-case orientation of a body-worn or handheld EUT. The final test on all kind of EUTs is also performed at 3 axes. A pre-check is performed while the EUT is powered from a DC power source.

1. Measurement above 30 MHz and up to 1 GHz

Step 1: Preliminary scan

This is a preliminary test to identify the highest amplitudes relative to the limit.

Settings for step 1:

- Antenna distance: 3 m
- Detector: Peak
- RBW: 100 kHz
- VBW: 300 kHz
- Sweep time: coupled
- Turntable angle range: -180° to 90°
- Turntable step size: 90°
- Height variation range: 1 – 4 m
- Height variation step size: 1.5 m
- Polarisation: Horizontal + Vertical

Intention of this step is, to determine the radiated EMI-profile of the EUT. Afterwards the relevant emissions for the final measurement are identified.

Step 2: Adjustment measurement

In this step the accuracy of the turntable azimuth and antenna height will be improved. This is necessary to find out the maximum value of every frequency.

For each frequency, which was determined the turntable azimuth and antenna height will be adjusted. The turntable azimuth will slowly vary by $\pm 45^\circ$ around this value. During this action, the value of emission is continuously measured. The turntable azimuth at the highest emission will be recorded and adjusted. In this position, the antenna height will also slowly vary by \pm

100 cm around the antenna height determined. During this action, the value of emission is also continuously measured. The antenna height of the highest emission will also be recorded and adjusted.

- Detector: Peak
- Measured frequencies: in step 1 determined frequencies
- RBW: 100 kHz
- VBW: 300 kHz
- Sweep time: coupled
- Turntable angle range: $\pm 45^\circ$ around the determined value
- Height variation range: ± 100 cm around the determined value
- Antenna Polarisation: max. value determined in step 1

Step 3: Final measurement with RMS detector

With the settings determined in step 3, the final measurement will be performed:

EMI receiver settings for step 4:

- Detector: RMQ
- Measured frequencies: in step 1 determined frequencies
- RBW: 100 kHz
- VBW: 300 kHz
- Sweep time: 1 s

After the measurement a plot will be generated which contains a diagram with the results of the preliminary scan and a chart with the frequencies and values of the results of the final measurement.

3. Measurement above 1 GHz

The following modifications apply to the measurement procedure for the frequency range above 1 GHz:

Step 1:

The Equipment Under Test (EUT) was set up on a non-conductive support (tilt device) at 1.5 m height in the fully-anechoic chamber.

All steps were performed with one height (1.5 m) of the receiving antenna only.

The EUT is turned during the preliminary measurement across the elevation axis, with a step size of 90° .

The turn table step size (azimuth angle) for the preliminary measurement is 45° .

- Antenna distance: 3 m
- Detector: Peak
- RBW: 1 MHz
- VBW: 3 MHz
- Sweep time: coupled
- Turntable angle range: -180° to 90°
- Turntable step size: 90°
- Polarisation: Horizontal + Vertical

Step 2:

Due to the fact, that in this frequency range the test is performed in a fully anechoic room, the height scan of the receiving antenna instep 2 is omitted. Instead of this, a maximum search with a step size $\pm 45^\circ$ for the elevation axis is performed.

The turn table azimuth will slowly vary by $\pm 22.5^\circ$.

The elevation angle will slowly vary by $\pm 45^\circ$

EMI receiver settings (for all steps):

- Detector: Peak,
- RBW: 1 MHz
- VBW: 3 MHz
- Sweep time: coupled

Step 3:

Spectrum analyser settings for step 3:

- Detector: RMS
- Measured frequencies: in step 1 determined frequencies
- RBW: 1 MHz
- VBW: 3 MHz
- Sweep Time: 1 s

5.4.2 TEST REQUIREMENTS / LIMITS

FCC Part 2.1053; Measurement required: Field strength of spurious radiation:

Measurements shall be made to detect spurious emissions that may be radiated directly from the cabinet, control circuits, power leads, or intermediate circuit elements under normal conditions of installation and operation. Curves or equivalent data shall be supplied showing the magnitude of each harmonic and other spurious emission. For this test, single sideband, independent sideband, and controlled carrier transmitters shall be modulated under the conditions specified in paragraph (c) of §2.1049, as appropriate.

Part 22, Subpart H – Cellular Radiotelephone Service**§ 22 917 – Emission limitations for cellular equipment**

(a) *Out of band emissions.* The power of any emission outside of the authorized operating frequency ranges must be attenuated below the transmitting power (P) by a factor of at least $43 + 10 \log(P)$ dB.

RSS-132; 5.5 Transmitter Unwanted Emissions

Mobile and base station equipment shall comply with the limits in (i) and (ii) below.

1. In the first 1.0 MHz band immediately outside and adjacent to each of the sub-bands specified in Section 5.1, the power of emissions per any 1% of the occupied bandwidth shall be attenuated (in dB) below the transmitter output power P (dBW) by at least $43 + 10 \log_{10} p$ (watts).
2. After the first 1.0 MHz immediately outside and adjacent to each of the sub-bands, the power of emissions in any 100 kHz bandwidth shall be attenuated (in dB) below the transmitter output power P (dBW) by at least $43 + 10 \log_{10} p$ (watts). If the measurement is performed using 1% of the occupied bandwidth, power integration over 100 kHz is required.

5.4.3 TEST PROTOCOL

Temperature 20 – 25 °C
Humidity 30 - 40 %

Radio Technology	Channel	Detector	Trace	Resolution Bandwidth /kHz	Frequency /MHz	Peak Value /dBm	Limit /dBm	Margin to Limit /dB
CAT-M1 eFDD5	mid	rms	maxhold	-	-	-	-13	>20

Radio Technology	Channel	Detector	Trace	Resolution Bandwidth /kHz	Frequency /MHz	Peak Value /dBm	Limit /dBm	Margin to Limit /dB
CAT-M1 eFDD26	mid	rms	maxhold	-	-	-	-13	>20

Radio Technology	Channel	Detector	Trace	Resolution Bandwidth /kHz	Frequency /MHz	Peak Value /dBm	Limit /dBm	Margin to Limit /dB
NB-IoT eFDD5	low	peak	maxhold	5	823.84	-21.4	-13	8.4
NB-IoT eFDD5	mid	rms	maxhold	-	-	-	-13	>20
NB-IoT eFDD5	high	rms	maxhold	50	849.00	-14.11	-13	1.11

Remark: Please see next sub-clause for the measurement plot.

5.4.4 MEASUREMENT PLOT (EXAMPLE PLOT, SHOWING WORST CASE, IF APPLICABLE)

CAT-M1 eFDD5 QPSK, Channel = mid

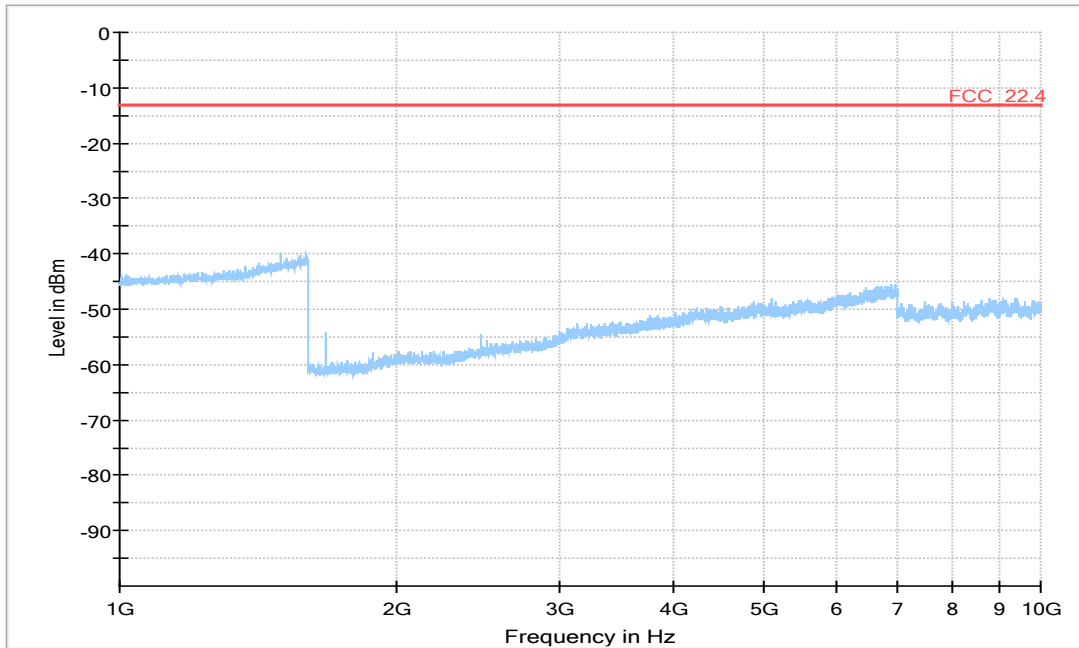

CAT-M1 eFDD26 QPSK, Channel = mid

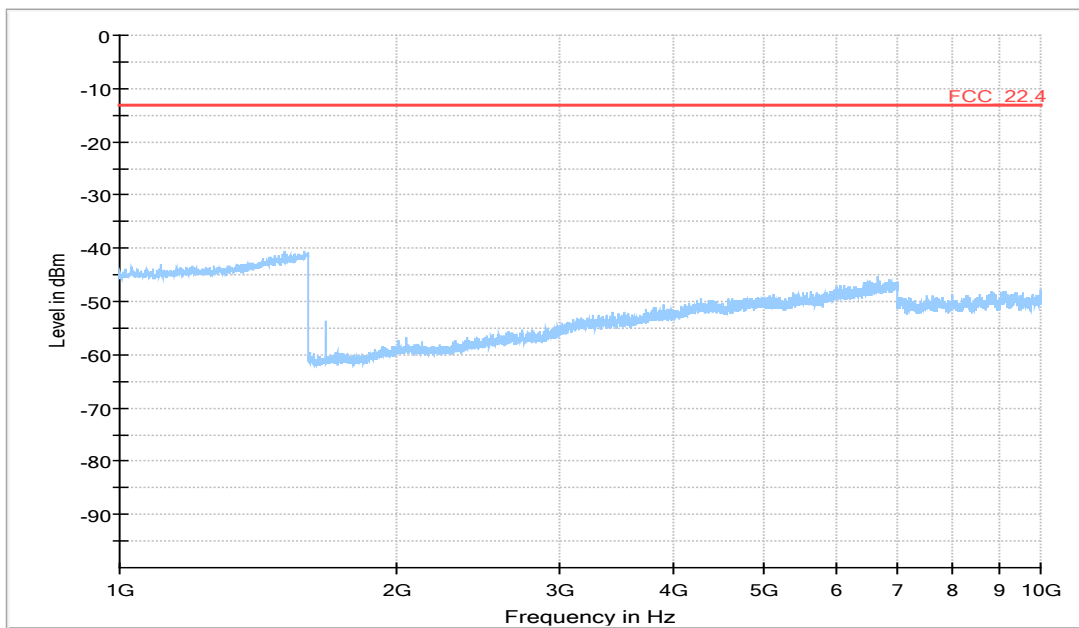

NB-IoT eFDD5 QPSK, Channel = high
30 MHz – 1 GHz

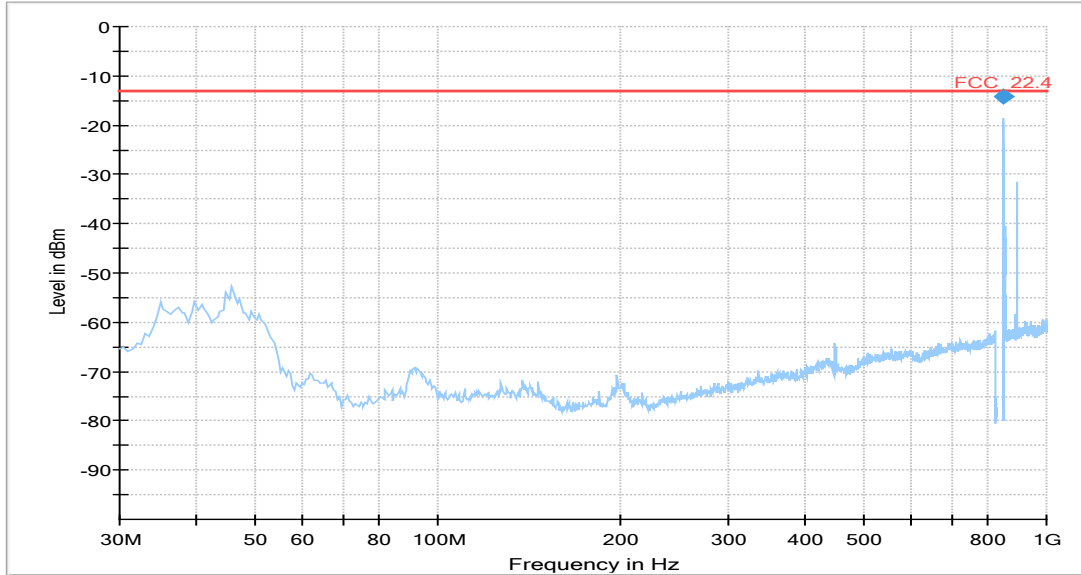

Frequency (MHz)	RMS (dBm)	Limit (dBm)	Margin (dB)	Meas. Time (ms)	Bandwidth (kHz)	Height (cm)	Pol	Azimuth (deg)	Corr. (dB)
849.004000	-14.11	-13.00	1.11	1000.0	50.000	164.0	H	24.0	-73.9

1 GHz – 10 GHz

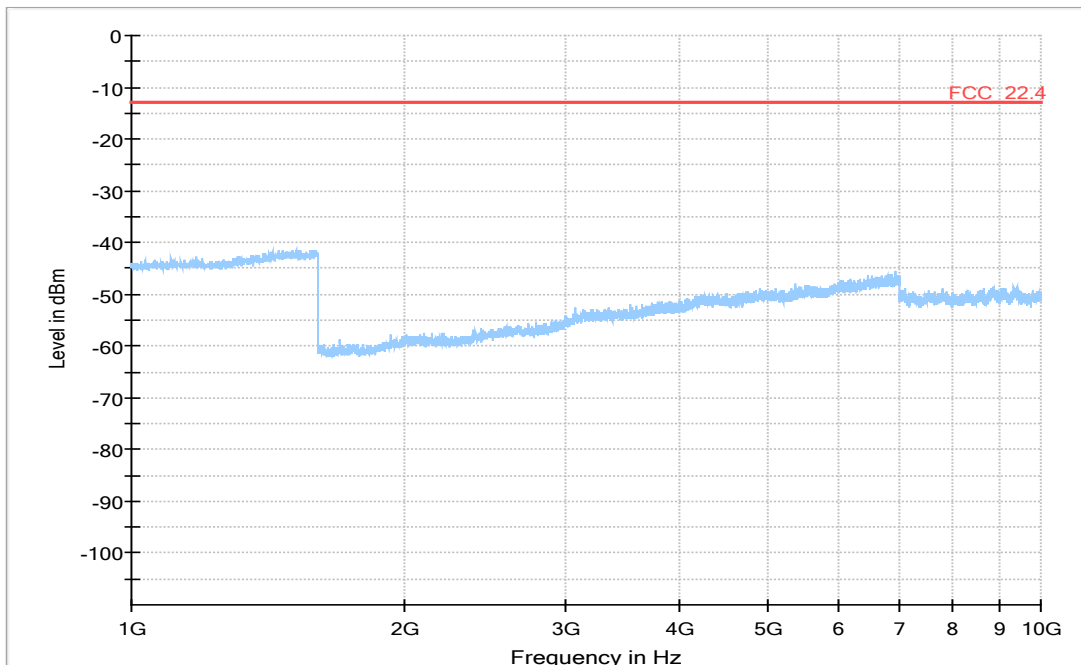

Spot checks for child product
S01_BB01
NB-IoT eFDD5 QPSK, Channel = mid

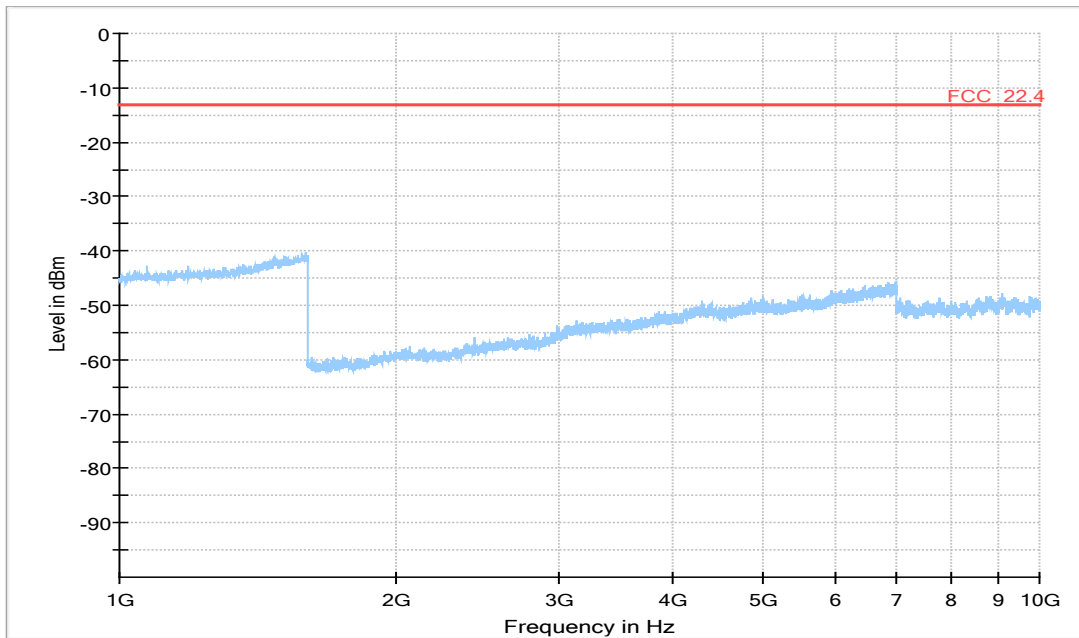

S01_CB01
NB-IoT eFDD5 QPSK, Channel = mid

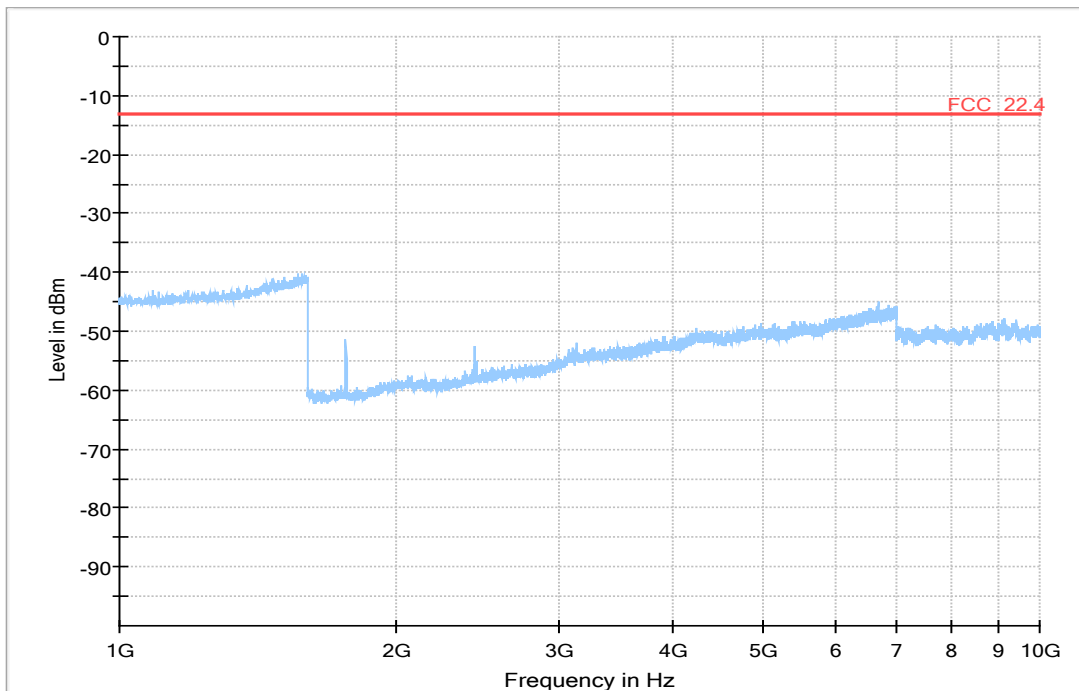

5.4.5 TEST EQUIPMENT USED

5.5 EMISSION AND OCCUPIED BANDWIDTH

Standard **FCC PART 22 Subpart H**

The test was performed according to:
ANSI C63.26: 2015

5.5.1 TEST DESCRIPTION

This test case is intended to demonstrate compliance to the applicable conducted spurious emission test case per FCC §2.1049 and RSS-GEN 6.7. The limit and the requirements come from the applicable rule part and ISED RSS-Standard for the operating band of the cellular device.

The EUT was connected to the test setups according to the following diagram:

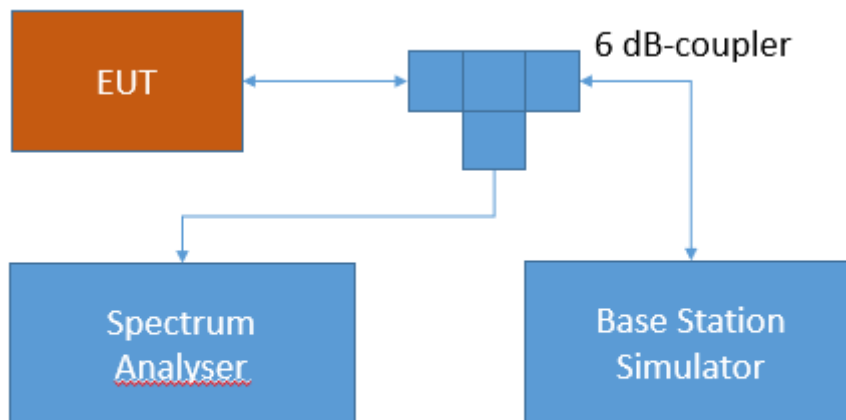

Test Setup FCC Part 22/24/27/90 Cellular;
Band edge compliance

The attenuation of the measuring and stimulus path are known for each measured frequency and are considered.

The Spectrum Analyser settings can be directly found in the measurement diagrams.

5.5.2 TEST REQUIREMENTS / LIMITS

FCC Part 2.1049; Occupied Bandwidth:

The occupied bandwidth, that is the frequency bandwidth such that, below its lower and above its upper frequency limits, the mean powers radiated are each equal to 0.5 percent of the total mean power radiated by a given emission shall be measured under the following conditions as applicable:

(h) Transmitters employing digital modulation techniques—when modulated by an input signal such that its amplitude and symbol rate represent the maximum rated conditions under which the equipment will be operated. The signal shall be applied through any filter networks, pseudo-random generators or other devices required in normal service. Additionally, the occupied bandwidth shall be shown for operation with any devices used for modifying the spectrum when such devices are optional at the discretion of the user.

(i) Transmitters designed for other types of modulation—when modulated by an appropriate signal of sufficient amplitude to be representative of the type of service in which used. A description of the input signal should be supplied.

RSS-GEN; 6.6 Occupied Bandwidth

The emission bandwidth (\times dB) is defined as the frequency range between two points, one above and one below the carrier frequency, at which the spectral density of the emission is attenuated \times dB below the maximum in-band spectral density of the modulated signal. Spectral density (power per unit bandwidth) is to be measured with a detector of resolution bandwidth in the range of 1% to 5% of the anticipated emission bandwidth, and a video bandwidth at least $3\times$ the resolution bandwidth.

When the occupied bandwidth limit is not stated in the applicable RSS or reference measurement method, the transmitted signal bandwidth shall be reported as the 99% emission bandwidth, as calculated or measured.

5.5.3 TEST PROTOCOL

Temperature 20 – 25 °C
Humidity 30 - 40 %

Radio Technology	Channel	Ressource Blocks / Subcarrier	Bandwidth [MHz]	Nominal BW [MHz]	99 % BW [kHz]
NB-IoT eFDD 5 QPSK	low	12	0.2	0.2	185.36
NB-IoT eFDD 5 QPSK	mid	12	0.2	0.2	184.37
NB-IoT eFDD 5 QPSK	high	12	0.2	0.2	184.37
NB-IoT eFDD 5 BPSK	low	1	0.2	0.2	108.22
NB-IoT eFDD 5 BPSK	mid	1	0.2	0.2	110.22
NB-IoT eFDD 5 BPSK	high	1	0.2	0.2	108.22

Remark: Please see next sub-clause for the measurement plot.

5.5.4 MEASUREMENT PLOT (EXAMPLE PLOT, SHOWING WORST CASE, IF APPLICABLE)

NB-IoT eFDD5 QPSK, Channel = mid

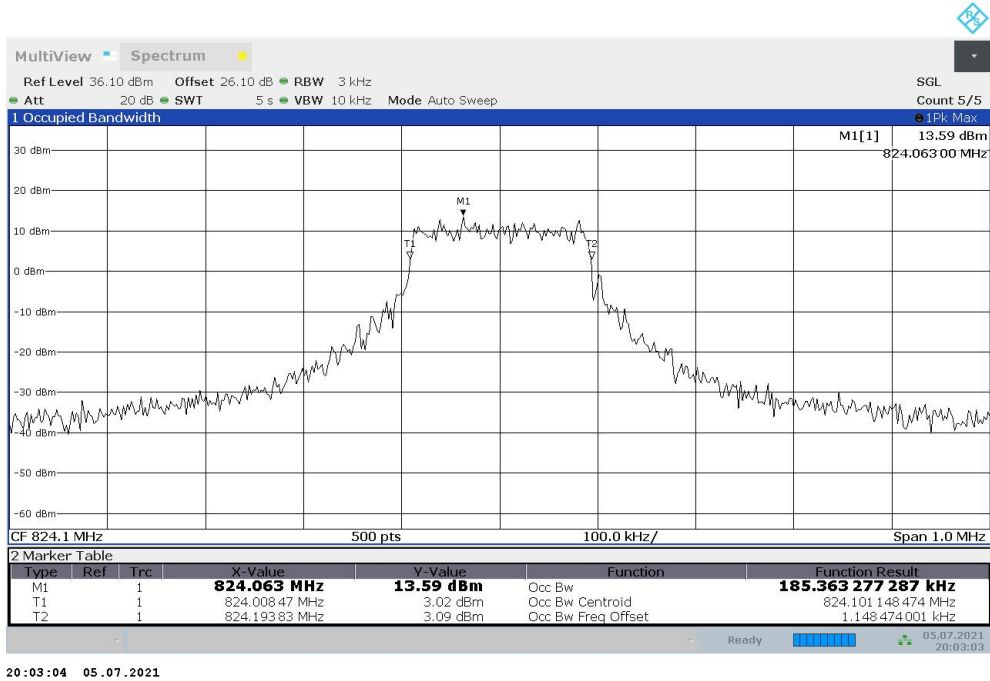

5.5.5 TEST EQUIPMENT USED

- Radio Lab

5.6 BAND EDGE COMPLIANCE

Standard **FCC PART 22 Subpart H**

The test was performed according to:
ANSI C63.26: 2015

5.6.1 TEST DESCRIPTION

This test case is intended to demonstrate compliance to the applicable conducted spurious emission test case per § 2.1051 and RSS-GEN 6.13. The limit comes from the applicable rule part and ISSED RSS-Standard for the operating band of the cellular device.

The EUT was connected to the test setup according to the following diagram:

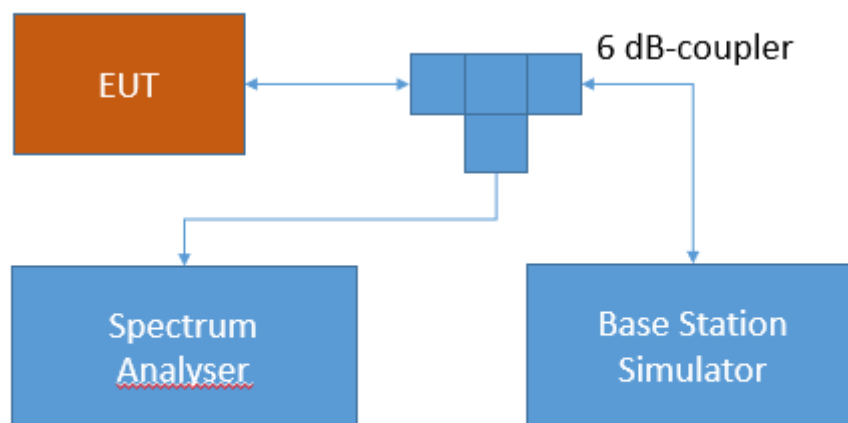

Test Setup FCC Part 22/24/27/90 Cellular;
Band edge compliance

The attenuation of the measuring and stimulus path are known for each measured frequency and are considered.

The Spectrum Analyser settings can be directly found in the measurement diagrams.

5.6.2 TEST REQUIREMENTS / LIMITS

FCC Part 2.1051; Measurement required: Spurious emissions at antenna terminal:

The radio frequency voltage or powers generated within the equipment and appearing on a spurious frequency shall be checked at the equipment output terminals when properly loaded with a suitable artificial antenna. Curves or equivalent data shall show the magnitude of each harmonic and other spurious emission that can be detected when the equipment is operated

under the conditions specified in §2.1049 as appropriate. The magnitude of spurious emissions which are attenuated more than 20 dB below the permissible value need not be specified.

Part 22, Subpart H – Cellular Radiotelephone Service

§22 917 – Emission limitations for cellular equipment

(a) *Out of band emissions.* The power of any emission outside of the authorized operating frequency ranges must be attenuated below the transmitting power (P) by a factor of at least $43 + 10 \log(P)$ dB.

RSS-132; 5.5 Transmitter Unwanted Emissions

Mobile and base station equipment shall comply with the limits in (i) and (ii) below.

1. In the first 1.0 MHz band immediately outside and adjacent to each of the sub-bands specified in Section 5.1, the power of emissions per any 1% of the occupied bandwidth shall be attenuated (in dB) below the transmitter output power P (dBW) by at least $43 + 10 \log_{10}p$ (watts).
2. After the first 1.0 MHz immediately outside and adjacent to each of the sub-bands, the power of emissions in any 100 kHz bandwidth shall be attenuated (in dB) below the transmitter output power P (dBW) by at least $43 + 10 \log_{10} p$ (watts). If the measurement is performed using 1% of the occupied bandwidth, power integration over 100 kHz is required.

5.6.3 TEST PROTOCOL

Temperature 20 – 25 °C
Humidity 30 - 40 %

Radio Technology	Channel	Re-source Blocks / Sub-carrier	Band-width [MHz]	Peak [dBm]	Average [dBm]	RMS [dBm]	Limit [dBm]	Margin to Limit [dB]
NB-IoT eFDD 5 QPSK	low	12	0.2	-11.23	-30.52	-19.47	-13	6.47
NB-IoT eFDD 5 QPSK	high	12	0.2	-12.34	-31.51	-20.00	-13	7.00
NB-IoT eFDD 5 BPSK	low	1	0.2	-3.87	-18.56	-15.17	-13	2.17
NB-IoT eFDD 5 BPSK	high	1	0.2	-5.88	-16.18	-14.86	-13	1.86

Remark: Please see next sub-clause for the measurement plot.

5.6.4 MEASUREMENT PLOT (EXAMPLE PLOT, SHOWING WORST CASE, IF APPLICABLE)

NB-IoT eFDD5 BPSK, Channel = high

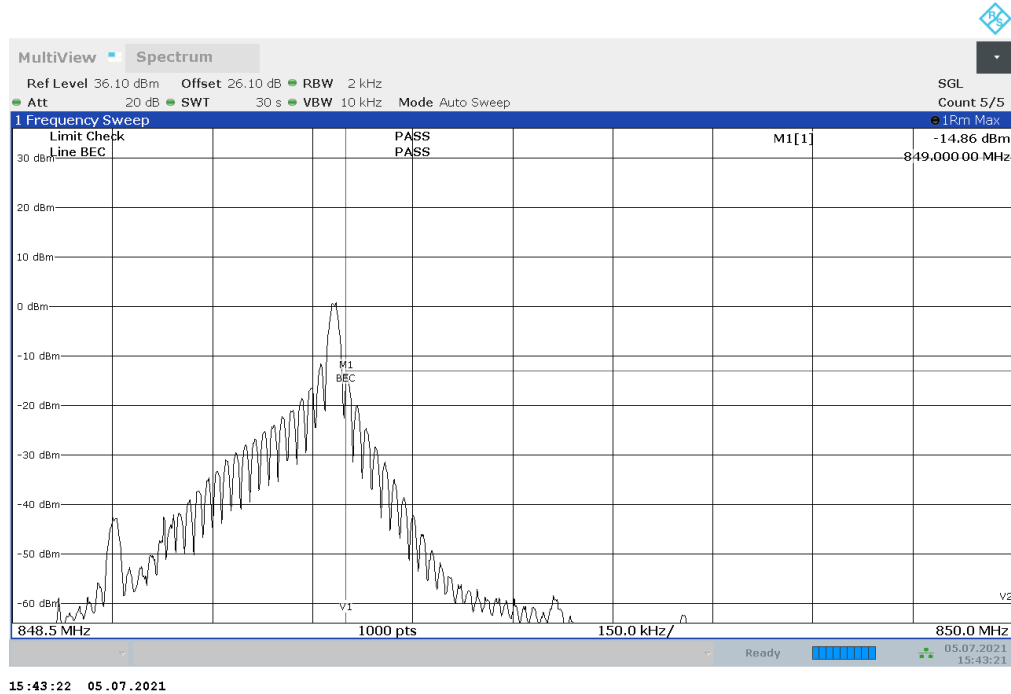

5.6.5 TEST EQUIPMENT USED

- Radio Lab

5.7 PEAK-AVERAGE-RATIO

Standard **FCC PART 22 Subpart H**

The test was performed according to:
ANSI C63.26: 2015

5.7.1 TEST DESCRIPTION

This test case is intended to demonstrate compliance of the EUT to the peak-to-average limits and requirements of the applicable rule part and ISED RSS-Standard for the operating band of the cellular device.

The EUT was connected to the test setup according to the following diagram:

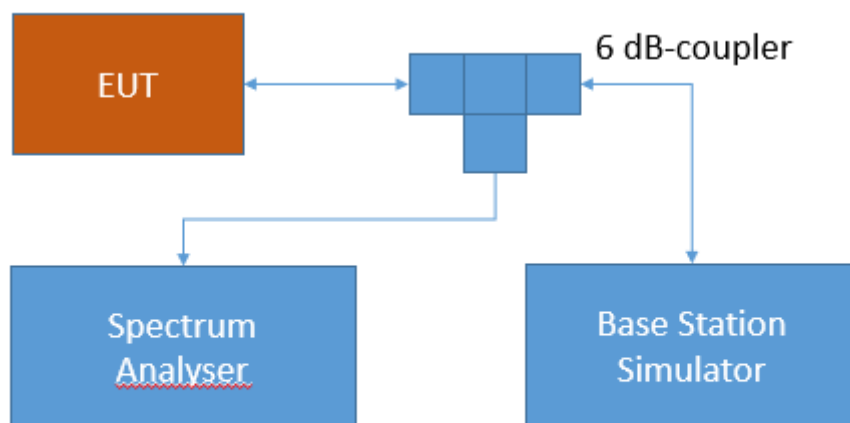

Test Setup FCC Part 22/24/27/90 Cellular;
Peak-average ratio

The attenuation of the measuring and stimulus path are known for each measured frequency and are considered.

The Spectrum Analyzer settings can be directly found in the measurement diagrams. The internal CCDF (complementary cumulative distribution function) of the spectrum analyser is used for this measurement

5.7.2 TEST REQUIREMENTS / LIMITS

FCC Part 22, § 22.913

There exists no applicable limit

RSS-132; 5.4 Transmitter Output Power and Equivalent Isotropically Radiated Power

In addition, the peak-to-average power ratio (PAPR) of the transmitter shall not exceed 13 dB for more than 0.1% of the time using a signal corresponding to the highest PAPR during periods of continuous transmission.

5.7.3 TEST PROTOCOL

Temperature 20 – 25 °C
Humidity 30 - 40 %

Radio Technology	Channel	Resource Blocks / Subcarrier	Bandwidth [MHz]	Peak to Average Ratio [dB]	Limit (IC) [dB]
NB-IoT eFDD 5 QPSK	low	12	0.2	8.34	13
NB-IoT eFDD 5 QPSK	mid	12	0.2	8.56	13
NB-IoT eFDD 5 QPSK	high	12	0.2	8.52	13
NB-IoT eFDD 5 BPSK	low	1	0.2	3.88	13
NB-IoT eFDD 5 BPSK	mid	1	0.2	3.92	13
NB-IoT eFDD 5 BPSK	high	1	0.2	3.84	13

Remark: Please see next sub-clause for the measurement plot.

5.7.4 MEASUREMENT PLOT (EXAMPLE PLOT, SHOWING WORST CASE, IF APPLICABLE)

NB-IoT eFDD5 QPSK, Channel = mid

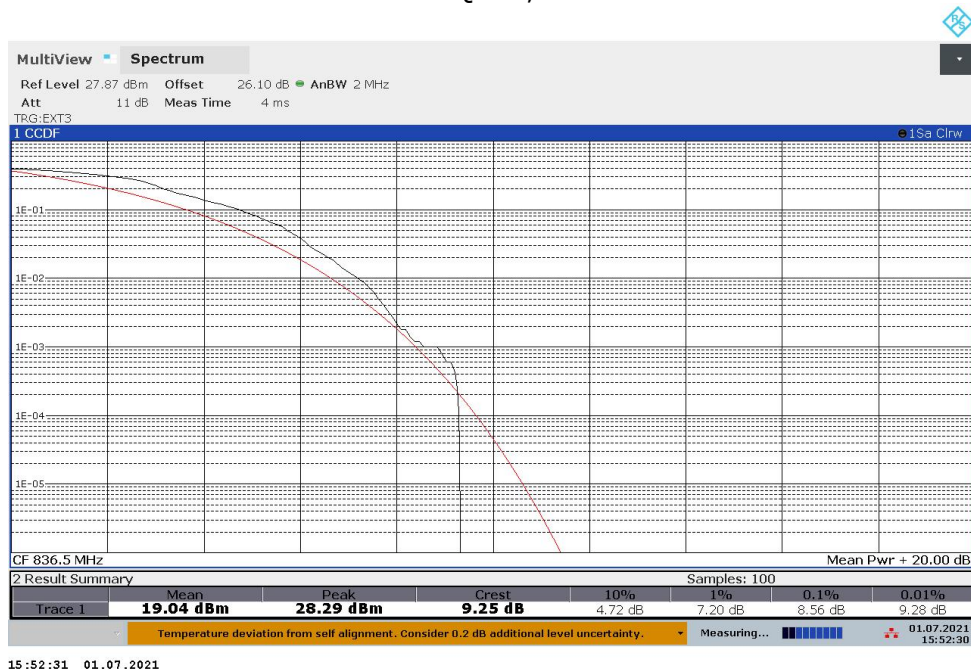

5.7.5 TEST EQUIPMENT USED

- Radio Lab

5.8 RF OUTPUT POWER

Standard **FCC PART 24 Subpart E**

The test was performed according to:
ANSI C63.26: 2015

5.8.1 TEST DESCRIPTION

This test case is intended to demonstrate compliance to the applicable RF Output power test case per § 2.1046 and RSS-GEN 6.12. The limit and the requirements come from the applicable rule part and ISED RSS-Standard for the operating band of the cellular device.

The EUT was connected to the test setup according to the following diagram:

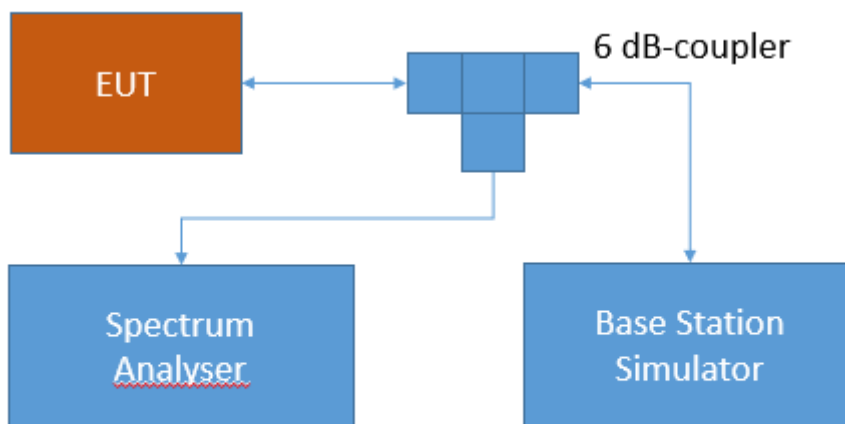

Test Setup FCC Part 22/24/27/90 Cellular;
RF Output power

The attenuation of the measuring and stimulus path are known for each measured frequency and are considered.

The Spectrum Analyzer settings can be directly found in the measurement diagrams.

5.8.2 TEST REQUIREMENTS / LIMITS

FCC Part 24, § 24.232

(c) Mobile and portable stations are limited to 2 watts EIRP and the equipment must employ a means for limiting power to the minimum necessary for successful communications.

RSS-133; 6.4 Transmitter Output Power and Equivalent Isotropically Radiated Power

The equivalent isotropically radiated power (e.i.r.p.) for transmitters shall not exceed the limits given in SRSP-510.

SRSP-510; 5.1.2 Radiated Power and Antenna Height Limits – Mobile Stations

Mobile stations and hand-held portables are limited to 2 watts maximum e.i.r.p. The equipment shall employ means to limit the power to the minimum necessary for successful communication.

5.8.3 TEST PROTOCOL

Temperature 20 – 25 °C
Humidity 30 - 40 %

Radio Technology	Channel	Re-source Blocks / Sub-carrier	Band-width [MHz]	RMS Cond. Power [dBm]	FCC EIRP Limit [W]	IC EIRP Limit [W]	Max. Antenna Gain FCC [dBi]	Max. Antenna Gain IC [dBi]
CAT-M1 eFDD 2 QPSK	mid	1	1.4	23.07	2	2	9.93	9.93
CAT-M1 eFDD 2 QPSK	mid	3	1.4	21.98	2	2	11.02	11.02
CAT-M1 eFDD 2 QPSK	mid	6	1.4	21.25	2	2	11.75	11.75
CAT-M1 eFDD 2 16QAM	mid	1	1.4	21.71	2	2	11.29	11.29
CAT-M1 eFDD 2 16QAM	mid	5	1.4	21.43	2	2	11.57	11.57
CAT-M1 eFDD 2 QPSK	mid	1	3	23.12	2	2	9.88	9.88
CAT-M1 eFDD 2 QPSK	mid	3	3	22.01	2	2	10.99	10.99
CAT-M1 eFDD 2 QPSK	mid	6	3	21.28	2	2	11.72	11.72
CAT-M1 eFDD 2 16QAM	mid	1	3	21.64	2	2	11.36	11.36
CAT-M1 eFDD 2 16QAM	mid	5	3	21.44	2	2	11.56	11.56
CAT-M1 eFDD 2 QPSK	mid	1	5	23.05	2	2	9.95	9.95
CAT-M1 eFDD 2 QPSK	mid	3	5	21.97	2	2	11.03	11.03
CAT-M1 eFDD 2 QPSK	mid	6	5	22.09	2	2	10.91	10.91
CAT-M1 eFDD 2 16QAM	mid	1	5	22.73	2	2	10.27	10.27
CAT-M1 eFDD 2 16QAM	mid	5	5	21.44	2	2	11.56	11.56
CAT-M1 eFDD 2 QPSK	mid	1	10	23.1	2	2	9.9	9.9
CAT-M1 eFDD 2 QPSK	mid	3	10	23.04	2	2	9.96	9.96
CAT-M1 eFDD 2 QPSK	mid	6	10	22.08	2	2	10.92	10.92
CAT-M1 eFDD 2 16QAM	mid	1	10	22.7	2	2	10.3	10.3
CAT-M1 eFDD 2 16QAM	mid	5	10	22.26	2	2	10.74	10.74
CAT-M1 eFDD 25 QPSK	mid	1	1.4	23.24	2	2	9.76	9.76
CAT-M1 eFDD 25 QPSK	mid	3	1.4	22.11	2	2	10.89	10.89
CAT-M1 eFDD 25 QPSK	mid	6	1.4	21.32	2	2	11.68	11.68
CAT-M1 eFDD 25 16QAM	mid	1	1.4	21.78	2	2	11.22	11.22
CAT-M1 eFDD 25 16QAM	mid	5	1.4	21.5	2	2	11.5	11.5
CAT-M1 eFDD 25 QPSK	mid	1	3	23.2	2	2	9.8	9.8
CAT-M1 eFDD 25 QPSK	mid	3	3	22.09	2	2	10.91	10.91
CAT-M1 eFDD 25 QPSK	mid	6	3	21.39	2	2	11.61	11.61
CAT-M1 eFDD 25 16QAM	mid	1	3	21.73	2	2	11.27	11.27
CAT-M1 eFDD 25 16QAM	mid	5	3	21.57	2	2	11.43	11.43
CAT-M1 eFDD 25 QPSK	mid	1	5	23.2	2	2	9.8	9.8
CAT-M1 eFDD 25 QPSK	mid	3	5	22.1	2	2	10.9	10.9
CAT-M1 eFDD 25 QPSK	mid	6	5	22.2	2	2	10.8	10.8
CAT-M1 eFDD 25 16QAM	mid	1	5	22.82	2	2	10.18	10.18
CAT-M1 eFDD 25 16QAM	mid	5	5	21.55	2	2	11.45	11.45
CAT-M1 eFDD 25 QPSK	mid	1	10	23.19	2	2	9.81	9.81
CAT-M1 eFDD 25 QPSK	mid	3	10	23.15	2	2	9.85	9.85
CAT-M1 eFDD 25 QPSK	mid	6	10	22.18	2	2	10.82	10.82
CAT-M1 eFDD 25 16QAM	mid	1	10	22.81	2	2	10.19	10.19
CAT-M1 eFDD 25 16QAM	mid	5	10	22.36	2	2	10.64	10.64
NB-IoT eFDD 2 QPSK	low	1	0.2	22.49	2	2	10.51	10.51

NB-IoT eFDD 2 QPSK	low	3	0.2	20.95	2	2	12.05	12.05
NB-IoT eFDD 2 QPSK	low	6	0.2	22.48	2	2	10.52	10.52
NB-IoT eFDD 2 QPSK	low	12	0.2	22.45	2	2	10.55	10.55
NB-IoT eFDD 2 QPSK	mid	1	0.2	22.36	2	2	10.64	10.64
NB-IoT eFDD 2 QPSK	mid	3	0.2	22.04	2	2	10.96	10.96
NB-IoT eFDD 2 QPSK	mid	6	0.2	22.37	2	2	10.63	10.63
NB-IoT eFDD 2 QPSK	mid	12	0.2	21.39	2	2	11.61	11.61
NB-IoT eFDD 2 QPSK	high	1	0.2	22.38	2	2	10.62	10.62
NB-IoT eFDD 2 QPSK	high	3	0.2	22.00	2	2	11.00	11.00
NB-IoT eFDD 2 QPSK	high	6	0.2	22.31	2	2	10.69	10.69
NB-IoT eFDD 2 QPSK	high	12	0.2	21.35	2	2	11.65	11.65
NB-IoT eFDD 2 BPSK	low	1	0.2	22.57	2	2	10.43	10.43
NB-IoT eFDD 2 BPSK	mid	1	0.2	22.45	2	2	10.55	10.55
NB-IoT eFDD 2 BPSK	high	1	0.2	22.42	2	2	10.58	10.58

Remark: Please see next sub-clause for the measurement plot.

5.8.4 MEASUREMENT PLOT (EXAMPLE PLOT, SHOWING WORST CASE, IF APPLICABLE)

CAT-M1 eFDD2 QPSK 3MHz RB1, Channel = mid

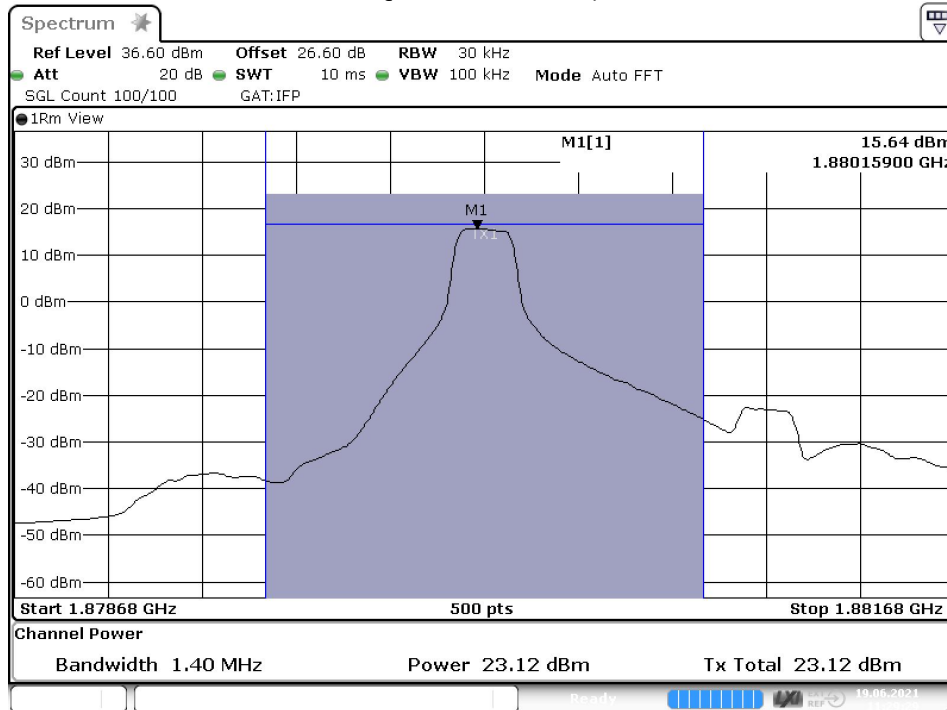

Date: 19 JUN.2021 11:29:29

CAT-M1 eFDD25 QPSK 1.4MHz RB1, Channel = mid

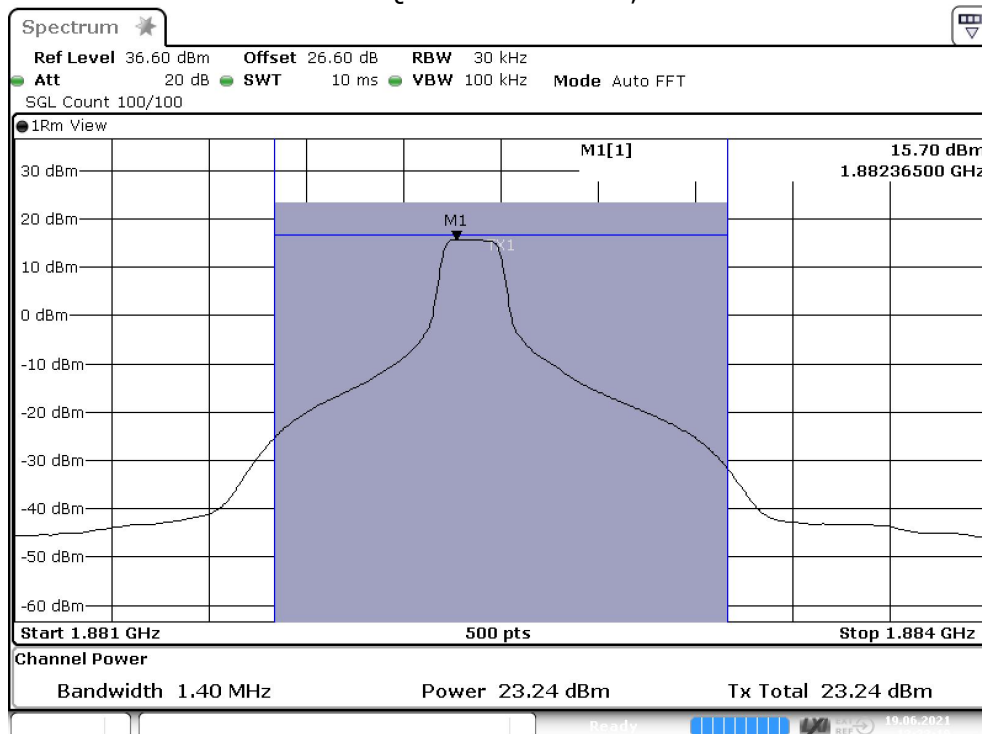

Date: 19 JUN.2021 12:22:11

NB-IoT eFDD2 BPSK SC1, Channel = low

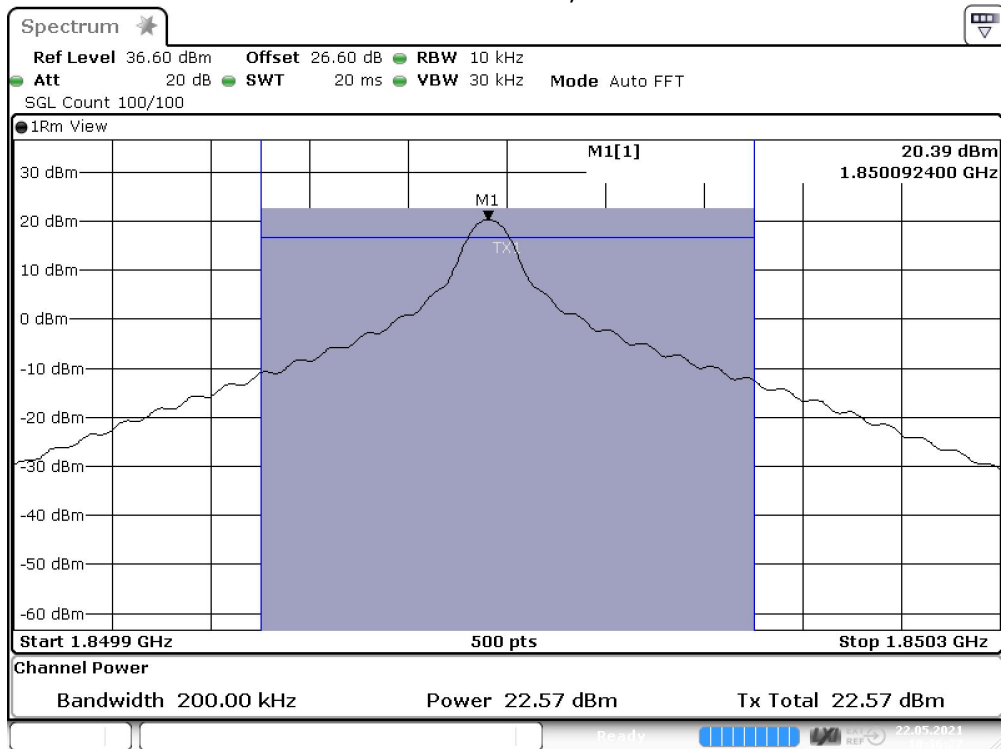

Date: 22.MAY.2021 10:36:27

5.8.5 TEST EQUIPMENT USED

- Radio Lab

5.9 FREQUENCY STABILITY

Standard **FCC PART 24 Subpart E**

The test was performed according to:
ANSI C63.26: 2015

5.9.1 TEST DESCRIPTION

This test case is intended to demonstrate compliance to the applicable frequency stability test case per § 2.1055 and RSS-GEN 6.11. The limit and the requirements come from the applicable rule part and ISED RSS-Standard for the operating band of the cellular device.

The EUT was connected to the test setup according to the following diagram:



Test Setup FCC Part 22/24/27/90 Cellular;
Frequency stability

The attenuation of the measuring / stimulus path is known for each measured frequency and are considered.

5.9.2 TEST REQUIREMENTS / LIMITS

FCC Part 24, § 24.235

The frequency stability shall be sufficient to ensure that the fundamental emission stays within the authorized frequency block.

RSS-133; 6.3 Frequency Stability

The carrier frequency shall not depart from the reference frequency, in excess of ± 2.5 ppm for mobile stations.

In lieu of meeting the above stability values, the test report may show that the frequency stability is sufficient to ensure that the emission bandwidth stays within the operating frequency block when tested to the temperature and supply voltage variations specified in RSS-Gen.

5.9.3 TEST PROTOCOL

NB-IoT eFDD2

Temp. °C	Duration min	Voltage	Limit Hz	Freq. error Average (Hz)	Freq. error Max. (Hz)	Verdict
-30	0	normal	4700	-8	11	passed
-30	5			-4	18	passed
-30	10			6	16	passed
-20	0	normal	4700	-7	17	passed
-20	5			6	13	passed
-20	10			6	16	passed
-10	0	normal	4700	-4	16	passed
-10	5			-9	19	passed
-10	10			-9	17	passed
0	0	normal	4700	7	14	passed
0	5			5	18	passed
0	10			-3	12	passed
10	0	normal	4700	-6	11	passed
10	5			-7	10	passed
10	10			-4	14	passed
20	0	low	4700	-3	16	passed
20	5			8	13	passed
20	10			3	18	passed
20	0	normal	4700	-7	15	passed
20	5			9	15	passed
20	10			7	17	passed
20	0	high	4700	-2	14	passed
20	5			-4	10	passed
20	10			6	13	passed
30	0	normal	4700	-6	18	passed
30	5			-3	16	passed
30	10			7	18	passed
40	0	normal	4700	-5	20	passed
40	5			-6	11	passed
40	10			-3	13	passed
50	0	normal	4700	4	18	passed
50	5			-6	16	passed
50	10			-8	15	passed

Remark: Please see next sub-clause for the measurement plot.

5.9.4 TEST EQUIPMENT USED

5.10 SPURIOUS EMISSIONS AT ANTENNA TERMINAL

Standard **FCC PART 24 Subpart E**

The test was performed according to:
ANSI C63.26: 2015

5.10.1 TEST DESCRIPTION

This test case is intended to demonstrate compliance to the applicable conducted spurious emission test case per § 2.1051 and RSS-GEN 6.13. The limit comes from the applicable rule part and ISED RSS-Standard for the operating band of the cellular device.

The EUT was connected to the test setup according to the following diagram:

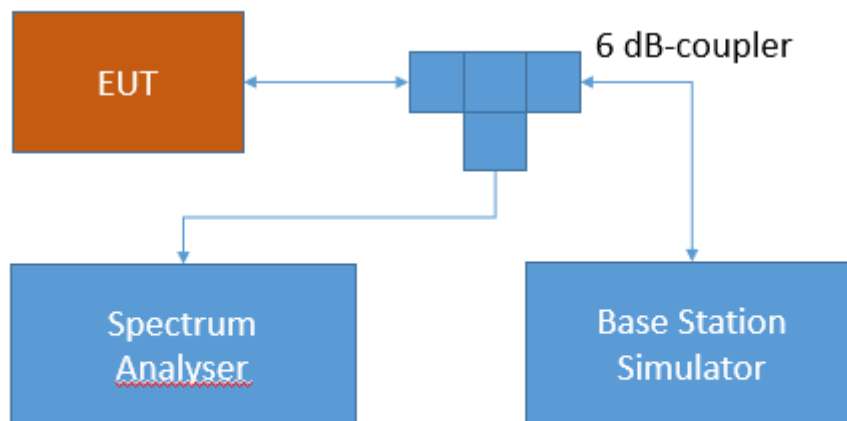

Test Setup FCC Part 22/24/27/90 Cellular;
Spurious Emissions at antenna terminal

The attenuation of the measuring and stimulus path are known for each measured frequency and are considered.

The Spectrum Analyzer settings can be directly found in the measurement diagrams.

5.10.2 TEST REQUIREMENTS / LIMITS

FCC Part 2.1051; Measurement required: Spurious emissions at antenna terminal:

The radio frequency voltage or powers generated within the equipment and appearing on a spurious frequency shall be checked at the equipment output terminals when properly loaded with a suitable artificial antenna. Curves or equivalent data shall show the magnitude of each harmonic and other spurious emission that can be detected when the equipment is operated

under the conditions specified in §2.1049 as appropriate. The magnitude of spurious emissions which are attenuated more than 20 dB below the permissible value need not be specified.

Part 24, Subpart E – Broadband PCS; Band 2

§24.238 – Emission limitations for Broadband PCS equipment

(a) *Out of band emissions.* The power of any emission outside of the authorized operating frequency ranges must be attenuated below the transmitting power (P) by a factor of at least $43 + 10 \log(P)$ dB.

RSS-133; 6.5 Transmitter Unwanted Emissions

6.5.1 Out-of-Block Emissions

Equipment shall comply with the limits in (i) and (ii) below.

- i. In the 1.0 MHz bands immediately outside and adjacent to the equipment’s operating frequency block, the emission power per any 1% of the emission bandwidth shall be attenuated (in dB) below the transmitter output power P (dBW) by at least $43 + 10 \log_{10}P$ (watts).
- ii. After the first 1.0 MHz, the emission power in any 1 MHz bandwidth shall be attenuated (in dB) below the transmitter output power P (dBW) by at least $43 + 10 \log_{10}P$ (watts). If the measurement is performed using 1% of the emission bandwidth, power integration over 1.0 MHz is required.

5.10.3 TEST PROTOCOL

Temperature 20 – 25 °C
Humidity 30 - 40 %

Radio Technology	Channel	Detector	Trace	Resolution Bandwidth /kHz	Frequency /MHz	Peak Value /dBm	Limit /dBm	Margin to Limit /dB
NB-IoT eFDD2	low	rms	maxhold	2	1849.98	-24.56	-13	11.56
NB-IoT eFDD2	mid	rms	maxhold	-	-	-	-13	>20
NB-IoT eFDD2	high	rms	maxhold	2	1910.01	-21.96	-13	8.96

Remark: Please see next sub-clause for the measurement plot.

5.10.4 MEASUREMENT PLOT (EXAMPLE PLOT, SHOWING WORST CASE, IF APPLICABLE)

NB-IoT eFDD2 QPSK, Channel = high

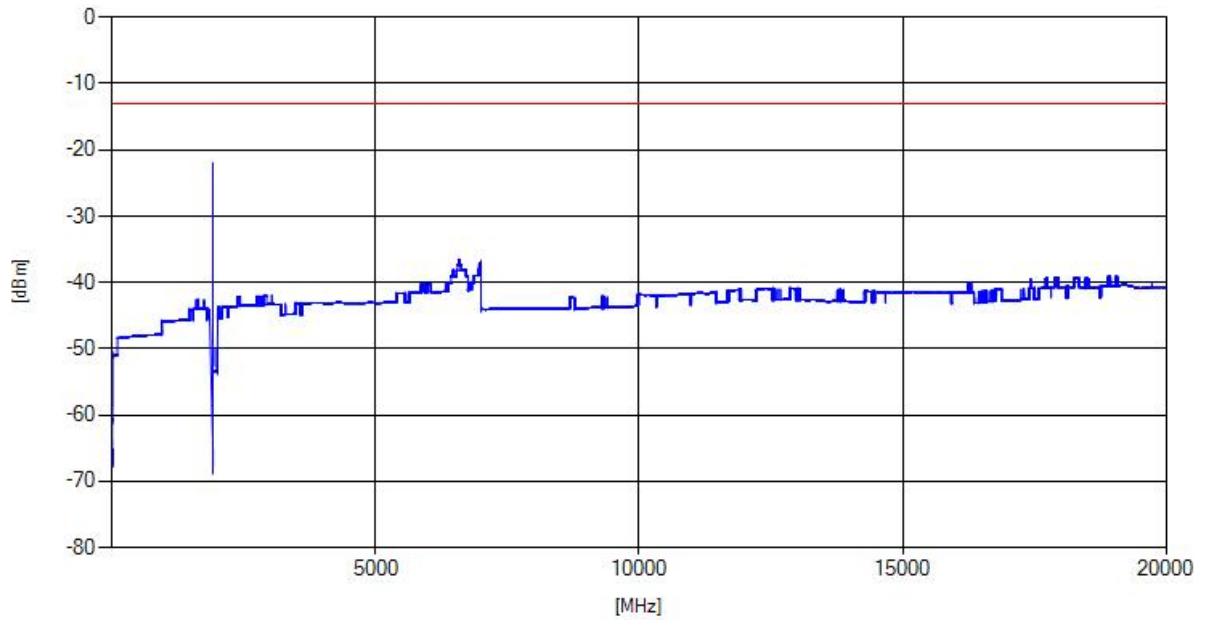

5.10.5 TEST EQUIPMENT USED

- Radio Lab

5.11 FIELD STRENGTH OF SPURIOUS RADIATION

Standard **FCC PART 24 Subpart E**

The test was performed according to:
ANSI C63.26: 2015

5.11.1 TEST DESCRIPTION

This test case is intended to demonstrate compliance to the applicable radiated spurious emission measurements per § 2.1053 and RSS-GEN 6.13. The limit and requirements come from the applicable rule part and ISED RSS-Standard for the operating band of the cellular device.

The EUT was connected to the test setup according to the following diagram:

Frequency Range: 30 MHz – 1 GHz:

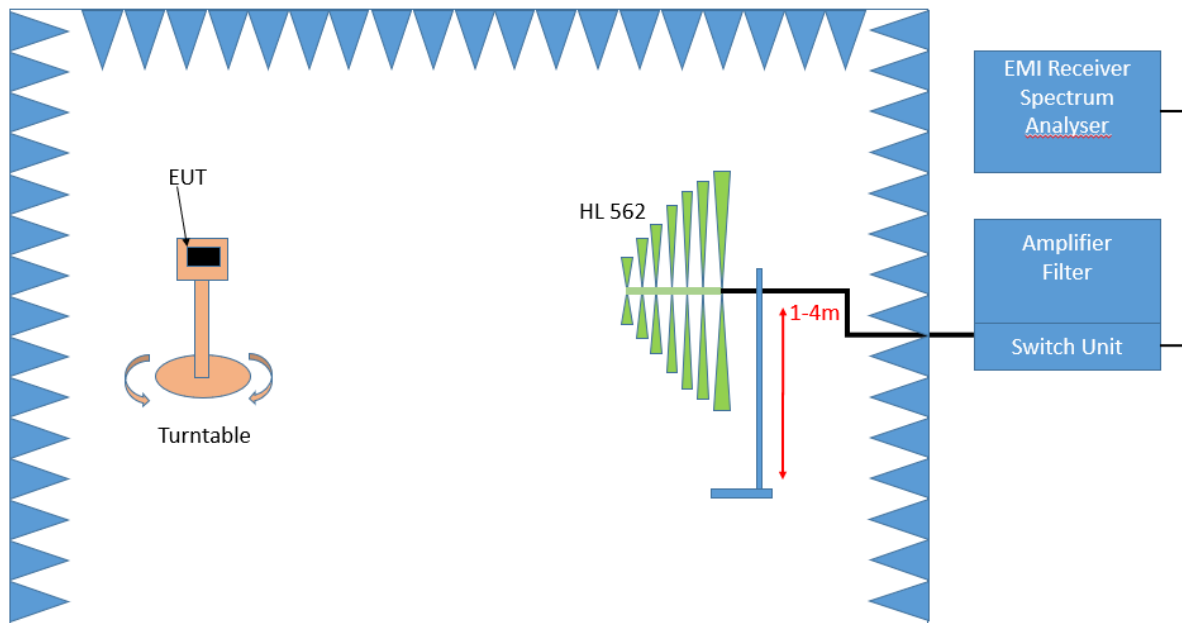

Test Setup; Spurious Emission Radiated (SAC), 30 MHz- 1GHz

Frequency Range: 1 GHz – 26.5 GHz

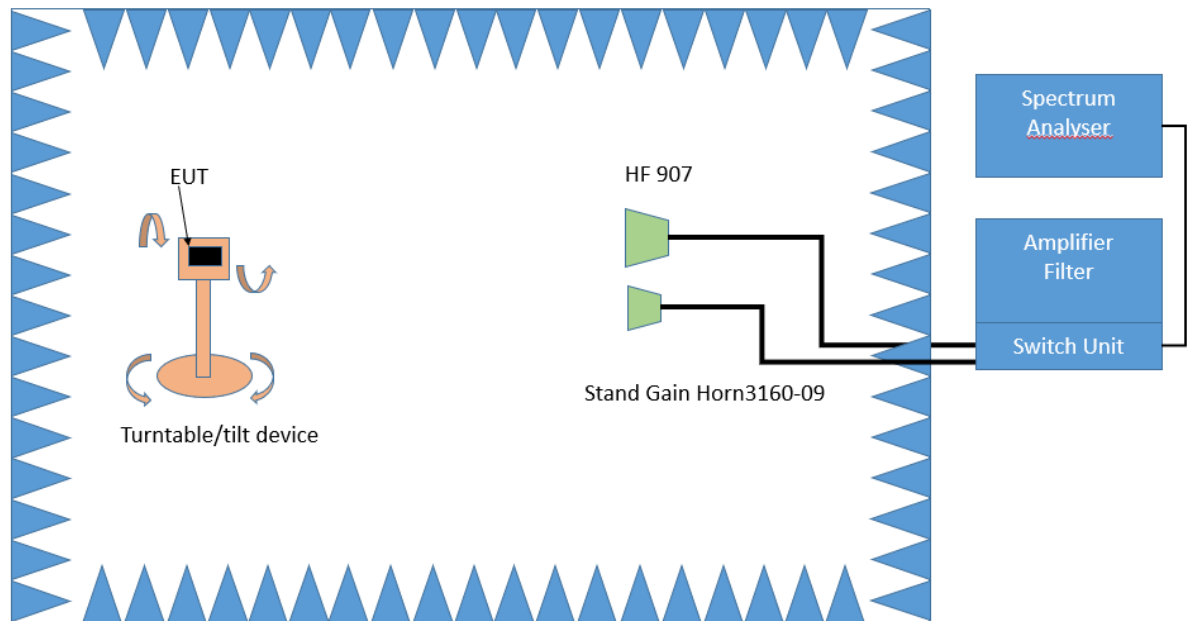

Test Setup; Spurious Emission Radiated (FAC), 1 GHz-26.5 GHz

The test set-up was made in accordance to the general provisions of ANSI C63.26 in a typical installation configuration. The Equipment Under Test (EUT) was set up on a non-conductive table 1.0 x 2.0 m² in the semi-anechoic chamber. The influence of the EUT support table that is used between 30–1000 MHz was evaluated.

The measurement procedure is implemented into the EMI test software EMC32 from R&S. Exploratory tests are performed at 3 orthogonal axes to determine the worst-case orientation of a body-worn or handheld EUT. The final test on all kind of EUTs is also performed at 3 axes. A pre-check is performed while the EUT is powered from a DC power source.

1. Measurement above 30 MHz and up to 1 GHz

Step 1: Preliminary scan

This is a preliminary test to identify the highest amplitudes relative to the limit.

Settings for step 1:

- Antenna distance: 3 m
- Detector: Peak
- RBW: 100 kHz
- VBW: 300 kHz
- Sweep time: coupled
- Turntable angle range: -180° to 90°
- Turntable step size: 90°
- Height variation range: 1 – 4 m
- Height variation step size: 1.5 m
- Polarisation: Horizontal + Vertical

Intention of this step is, to determine the radiated EMI-profile of the EUT. Afterwards the relevant emissions for the final measurement are identified.

Step 2: Adjustment measurement

In this step the accuracy of the turntable azimuth and antenna height will be improved. This is necessary to find out the maximum value of every frequency.

For each frequency, which was determined the turntable azimuth and antenna height will be adjusted. The turntable azimuth will slowly vary by $\pm 45^{\circ}$ around this value. During this action, the value of emission is continuously measured. The turntable azimuth at the highest emission

will be recorded and adjusted. In this position, the antenna height will also slowly vary by ± 100 cm around the antenna height determined. During this action, the value of emission is also continuously measured. The antenna height of the highest emission will also be recorded and adjusted.

- Detector: Peak
- Measured frequencies: in step 1 determined frequencies
- RBW: 100 kHz
- VBW: 300 kHz
- Sweep time: coupled
- Turntable angle range: $\pm 45^\circ$ around the determined value
- Height variation range: ± 100 cm around the determined value
- Antenna Polarisation: max. value determined in step 1

Step 3: Final measurement with RMS detector

With the settings determined in step 3, the final measurement will be performed:

EMI receiver settings for step 4:

- Detector: RMQ
- Measured frequencies: in step 1 determined frequencies
- RBW: 100 kHz
- VBW: 300 kHz
- Sweep time: 1 s

After the measurement a plot will be generated which contains a diagram with the results of the preliminary scan and a chart with the frequencies and values of the results of the final measurement.

3. Measurement above 1 GHz

The following modifications apply to the measurement procedure for the frequency range above 1 GHz:

Step 1:

The Equipment Under Test (EUT) was set up on a non-conductive support (tilt device) at 1.5 m height in the fully-anechoic chamber.

All steps were performed with one height (1.5 m) of the receiving antenna only.

The EUT is turned during the preliminary measurement across the elevation axis, with a step size of 90° .

The turn table step size (azimuth angle) for the preliminary measurement is 45° .

- Antenna distance: 3 m
- Detector: Peak
- RBW: 1 MHz
- VBW: 3 MHz
- Sweep time: coupled
- Turntable angle range: -180° to 90°
- Turntable step size: 90°
- Polarisation: Horizontal + Vertical

Step 2:

Due to the fact, that in this frequency range the test is performed in a fully anechoic room, the height scan of the receiving antenna instep 2 is omitted. Instead of this, a maximum search with a step size $\pm 45^\circ$ for the elevation axis is performed.

The turn table azimuth will slowly vary by $\pm 22.5^\circ$.

The elevation angle will slowly vary by $\pm 45^\circ$

EMI receiver settings (for all steps):

- Detector: Peak,
- RBW: 1 MHz
- VBW: 3 MHz

- Sweep time: coupled

Step 3:

Spectrum analyser settings for step 3:

- Detector: RMS
- Measured frequencies: in step 1 determined frequencies
- RBW: 1 MHz
- VBW: 3 MHz
- Sweep Time: 1 s

5.11.2 TEST REQUIREMENTS / LIMITS

FCC Part 2.1053; Measurement required: Field strength of spurious radiation:

Measurements shall be made to detect spurious emissions that may be radiated directly from the cabinet, control circuits, power leads, or intermediate circuit elements under normal conditions of installation and operation. Curves or equivalent data shall be supplied showing the magnitude of each harmonic and other spurious emission. For this test, single sideband, independent sideband, and controlled carrier transmitters shall be modulated under the conditions specified in paragraph (c) of §2.1049, as appropriate.

Part 24, Subpart E – Broadband PCS

§ 24.238 – Emission limitations for Broadband PCS equipment

- a) Out of band emissions. The power of any emission outside of the authorized operating frequency ranges must be attenuated below the transmitting power (P) by a factor of at least $43 + 10 \log(P)$ dB.
- b) Measurement procedure. Compliance with these rules is based on the use of measurement instrumentation employing a resolution bandwidth of 1 MHz or greater. However, in the 1 MHz bands immediately outside and adjacent to the frequency block a resolution bandwidth of at least one percent of the emission bandwidth of the fundamental emission of the transmitter may be employed. A narrower resolution bandwidth is permitted in all cases to improve measurement accuracy provided the measured power is integrated over the full required measurement bandwidth (i.e. 1 MHz or 1 percent of emission bandwidth, as specified). The emission bandwidth is defined as the width of the signal between two points, one below the carrier center frequency and one above the carrier center frequency, outside of which all emissions are attenuated at least 26 dB below the transmitter power.

RSS-133; 6.5 Transmitter Unwanted Emissions

Mobile and base station equipment shall comply with the limits in (1) and (2) below.

1. In the 1.0 MHz bands immediately outside and adjacent to the equipment's operating frequency block, the emission power per any 1% of the emission bandwidth shall be attenuated (in dB) below the transmitter output power P (dBW) by at least $43 + 10 \log_{10}P$ (watts).
2. After the first 1.0 MHz, the emission power in any 1 MHz bandwidth shall be attenuated (in dB) below the transmitter output power P (dBW) by at least $43 + 10 \log_{10}P$ (watts). If the measurement is performed using 1% of the emission bandwidth, power integration over 1.0 MHz is required.

5.11.3 TEST PROTOCOL

Temperature 20 – 25 °C
Humidity 30 - 40 %

Radio Technology	Channel	Detector	Trace	Resolution Bandwidth /kHz	Frequency /MHz	Peak Value /dBm	Limit /dBm	Margin to Limit /dB
CAT-M1 eFDD2	mid	rms	maxhold	-	-	-	-13	>20

Radio Technology	Channel	Detector	Trace	Resolution Bandwidth /kHz	Frequency /MHz	Peak Value /dBm	Limit /dBm	Margin to Limit /dB
CAT-M1 eFDD25	mid	rms	maxhold	-	-	-	-13	>20

Radio Technology	Channel	Detector	Trace	Resolution Bandwidth /kHz	Frequency /MHz	Peak Value /dBm	Limit /dBm	Margin to Limit /dB
NB-IoT eFDD2	low	peak	maxhold	2	1849.99	-18.02	-13	5.02
NB-IoT eFDD2	mid	rms	maxhold	-	-	-	-13	>20
NB-IoT eFDD2	high	rms	maxhold	2	1910.00	-17.80	-13	4.80

Remark: Please see next sub-clause for the measurement plot.

5.11.4 MEASUREMENT PLOT (EXAMPLE PLOT, SHOWING WORST CASE, IF APPLICABLE)

CAT-M1 eFDD2 QPSK, Channel =mid

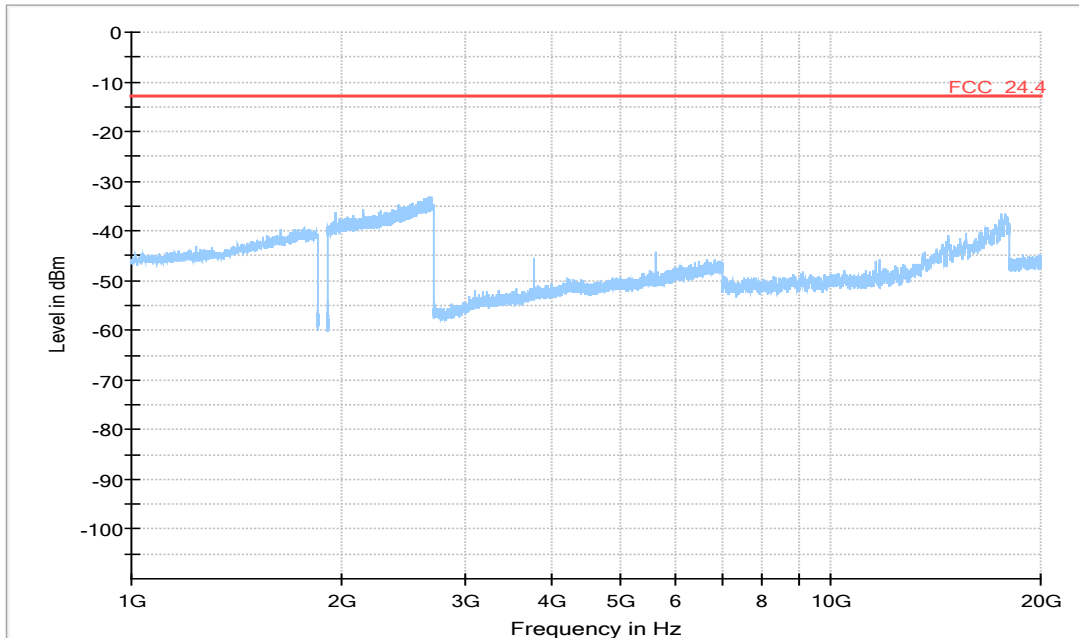

CAT-M1 eFDD25 QPSK, Channel =mid

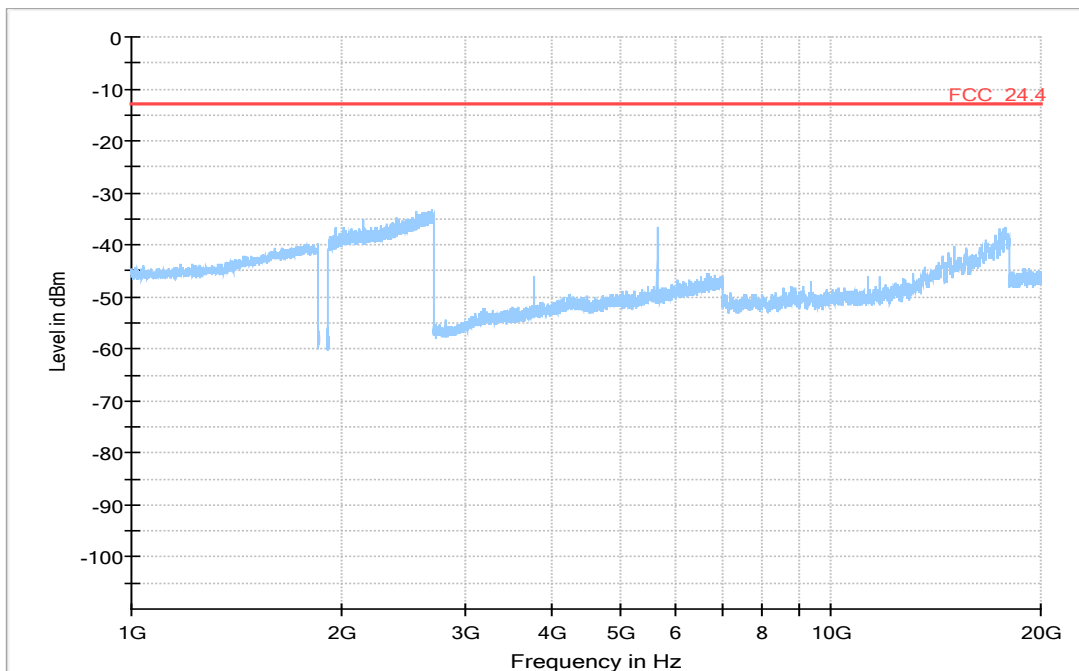

NB-IoT eFDD2 QPSK, Channel = high
30 MHz - 1 GHz

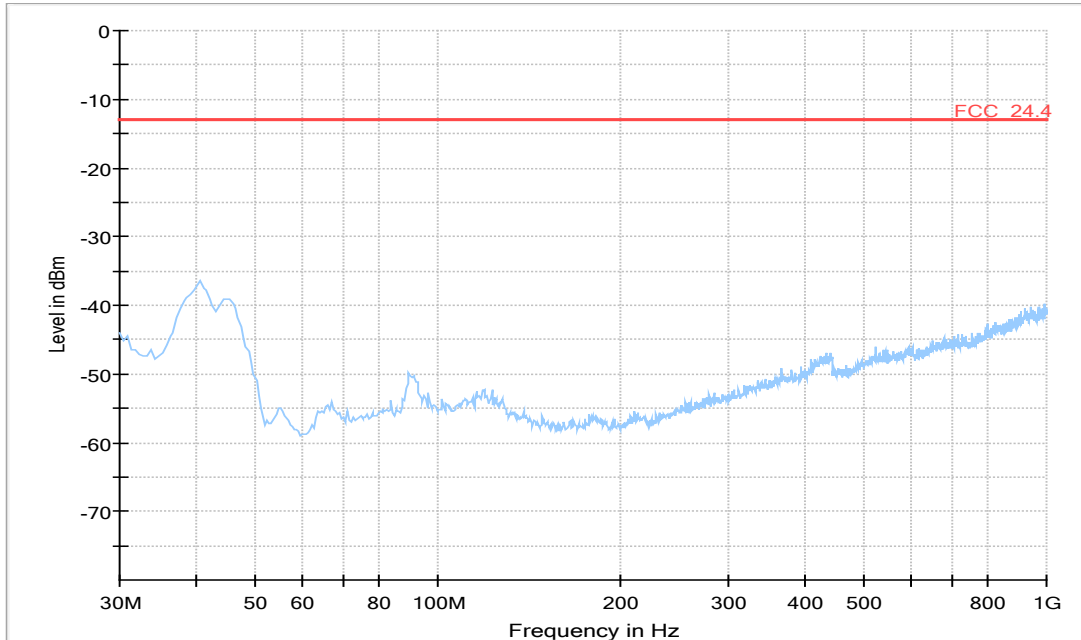

1 GHz - 20 GHz

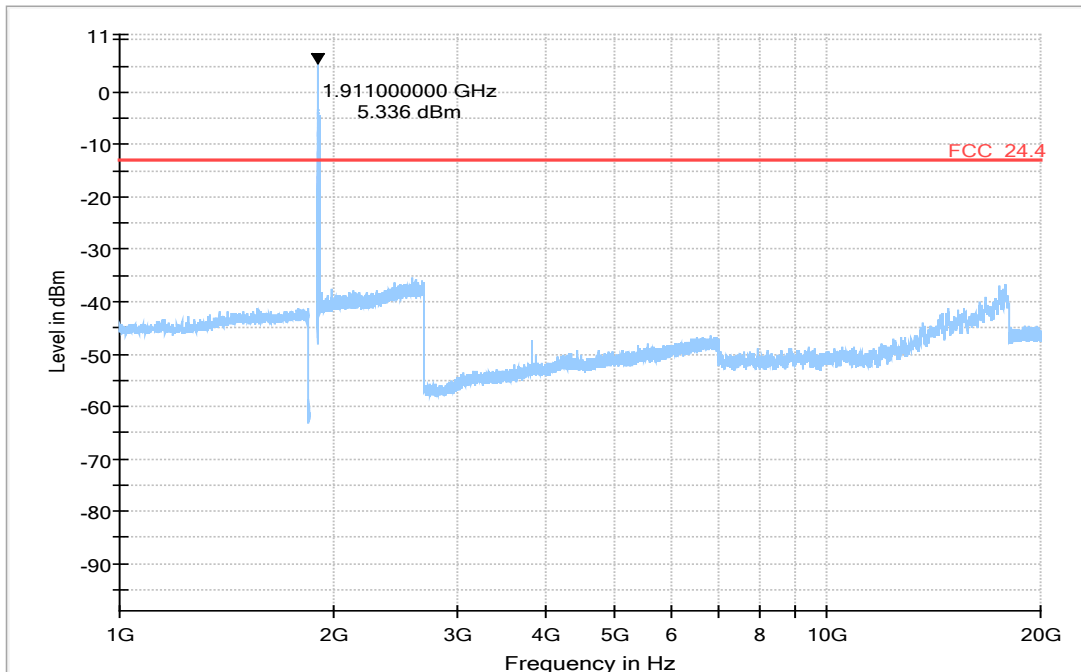

re-measurement at carrier

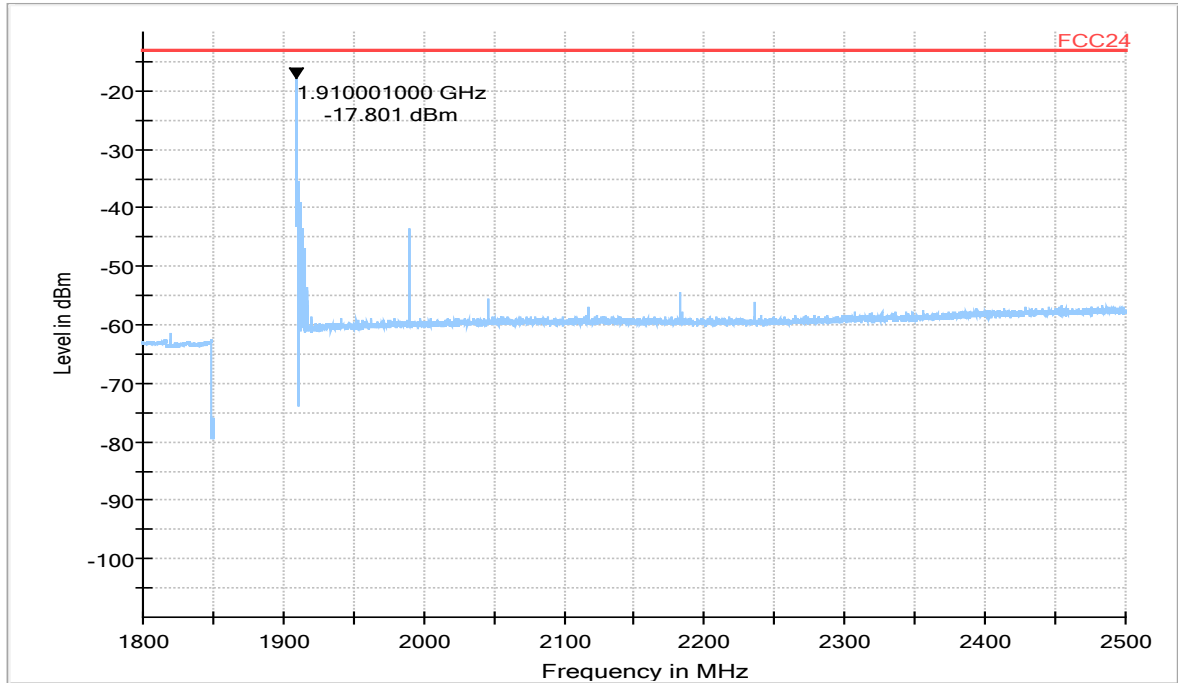

Spot checks for child product
S01_BB01
NB-IoT eFDD2 QPSK, Channel = mid

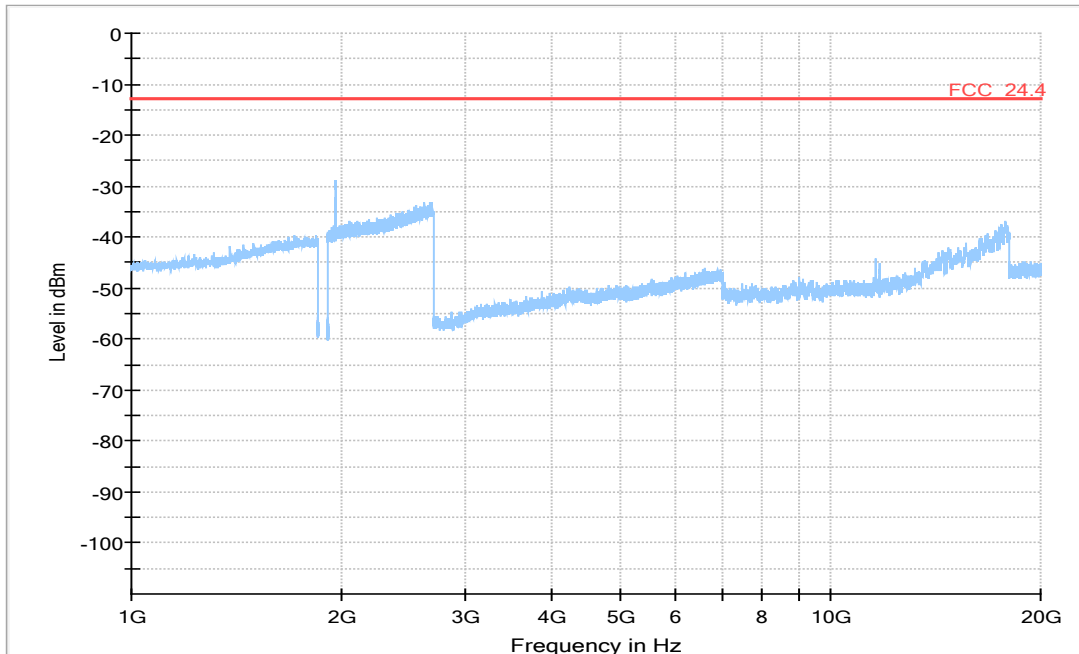

S01_CB01
NB-IoT eFDD2 QPSK, Channel = mid

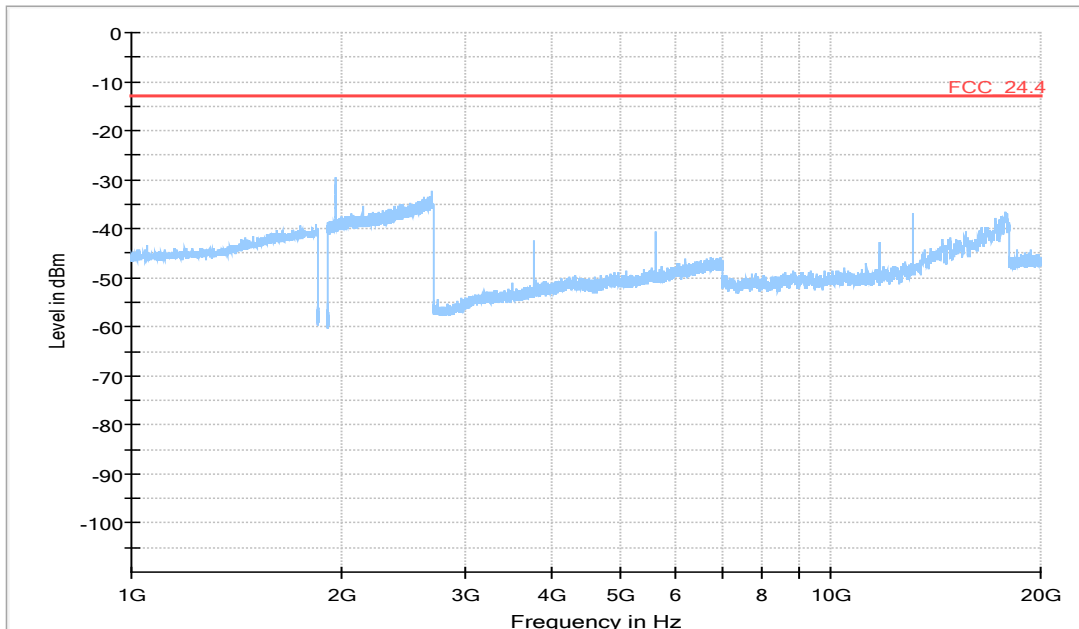

5.11.5 TEST EQUIPMENT USED

- Radiated Emissions

5.12 EMISSION AND OCCUPIED BANDWIDTH

Standard **FCC PART 24 Subpart E**

The test was performed according to:
ANSI C63.26: 2015

5.12.1 TEST DESCRIPTION

This test case is intended to demonstrate compliance to the applicable conducted spurious emission test case per FCC §2.1049 and RSS-GEN 6.7. The limit and the requirements come from the applicable rule part and ISED RSS-Standard for the operating band of the cellular device.

The EUT was connected to the test setups according to the following diagram:

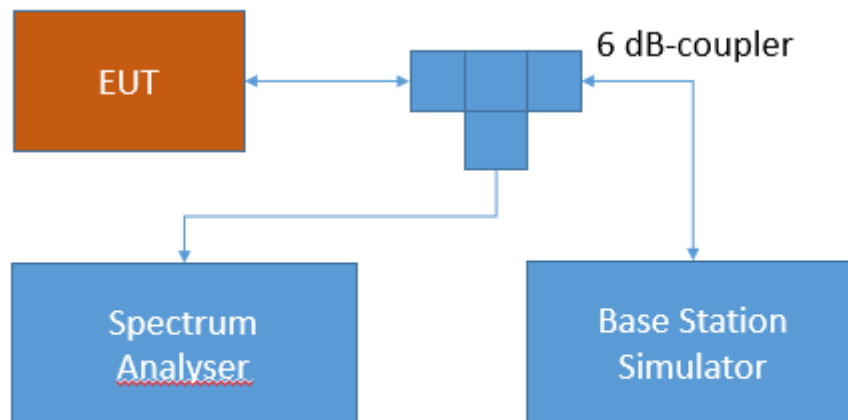

Test Setup FCC Part 22/24/27/90 Cellular;
Band edge compliance

The attenuation of the measuring and stimulus path are known for each measured frequency and are considered.

The Spectrum Analyzer settings can be directly found in the measurement diagrams.

5.12.2 TEST REQUIREMENTS / LIMITS

FCC Part 2.1049; Occupied Bandwidth:

The occupied bandwidth, that is the frequency bandwidth such that, below its lower and above its upper frequency limits, the mean powers radiated are each equal to 0.5 percent of the total

mean power radiated by a given emission shall be measured under the following conditions as applicable:

(h) Transmitters employing digital modulation techniques—when modulated by an input signal such that its amplitude and symbol rate represent the maximum rated conditions under which the equipment will be operated. The signal shall be applied through any filter networks, pseudo-random generators or other devices required in normal service. Additionally, the occupied bandwidth shall be shown for operation with any devices used for modifying the spectrum when such devices are optional at the discretion of the user.

(i) Transmitters designed for other types of modulation—when modulated by an appropriate signal of sufficient amplitude to be representative of the type of service in which used. A description of the input signal should be supplied.

RSS-GEN; 6.7 Occupied Bandwidth (or 99% emission bandwidth) and x dB bandwidth

The occupied bandwidth or the “99% emission bandwidth” is defined as the frequency range between two points, one above and the other below the carrier frequency, within which 99% of the total transmitted power of the fundamental transmitted emission is contained. The occupied bandwidth shall be reported for all equipment in addition to the specified bandwidth required in the applicable RSSs.

In some cases, the “x dB bandwidth” is required, which is defined as the frequency range between two points, one at the lowest frequency below and one at the highest frequency above the carrier frequency, at which the maximum power level of the transmitted emission is attenuated x dB below the maximum in-band power level of the modulated signal, where the two points are on the outskirts of the in-band emission.

The following conditions shall be observed for measuring the occupied bandwidth and x dB bandwidth:

The transmitter shall be operated at its maximum carrier power measured under normal test conditions.

The span of the spectrum analyzer shall be set large enough to capture all products of the modulation process, including the emission skirts, around the carrier frequency, but small enough to avoid having other emissions (e.g. on adjacent channels) within the span. The detector of the spectrum analyzer shall be set to “Sample”. However, a peak, or peak hold, may be used in place of the sampling detector since this usually produces a wider bandwidth than the actual bandwidth (worst-case measurement). Use of a peak hold (or “Max Hold”) may be necessary to determine the occupied / x dB bandwidth if the device is not transmitting continuously.

The resolution bandwidth (RBW) shall be in the range of 1% to 5% of the actual occupied / x dB bandwidth and the video bandwidth (VBW) shall not be smaller than three times the RBW value. Video averaging is not permitted.

Note: It may be necessary to repeat the measurement a few times until the RBW and VBW are in compliance with the above requirement.

For the 99% emission bandwidth, the trace data points are recovered and directly summed in linear power level terms. The recovered amplitude data points, beginning at the lowest frequency, are placed in a running sum until 0.5% of the total is reached, and that frequency recorded. The process is repeated for the highest frequency data points (starting at the highest

frequency, at the right side of the span, and going down in frequency). This frequency is then recorded. The difference between the two recorded frequencies is the occupied bandwidth (or the 99% emission bandwidth).

5.12.3 TEST PROTOCOL

Temperature 20 – 25 °C
Humidity 30 - 40 %

Technology	Radio Technology	Channel	Resource Blocks / Subcarrier	Bandwidth [MHz]	Nominal BW [MHz]	26 dB BW [kHz]	99 % BW [kHz]
NB-IoT	eFDD 2 QPSK	low	12	0.2	0.2	-	184.37
NB-IoT	eFDD 2 QPSK	mid	12	0.2	0.2	-	186.37
NB-IoT	eFDD 2 QPSK	high	12	0.2	0.2	-	186.37
NB-IoT	eFDD 2 BPSK	low	1	0.2	0.2	-	114.23
NB-IoT	eFDD 2 BPSK	mid	1	0.2	0.2	-	114.23
NB-IoT	eFDD 2 BPSK	high	1	0.2	0.2	-	112.22

Remark: Please see next sub-clause for the measurement plot.

5.12.4 MEASUREMENT PLOT (EXAMPLE PLOT, SHOWING WORST CASE, IF APPLICABLE)

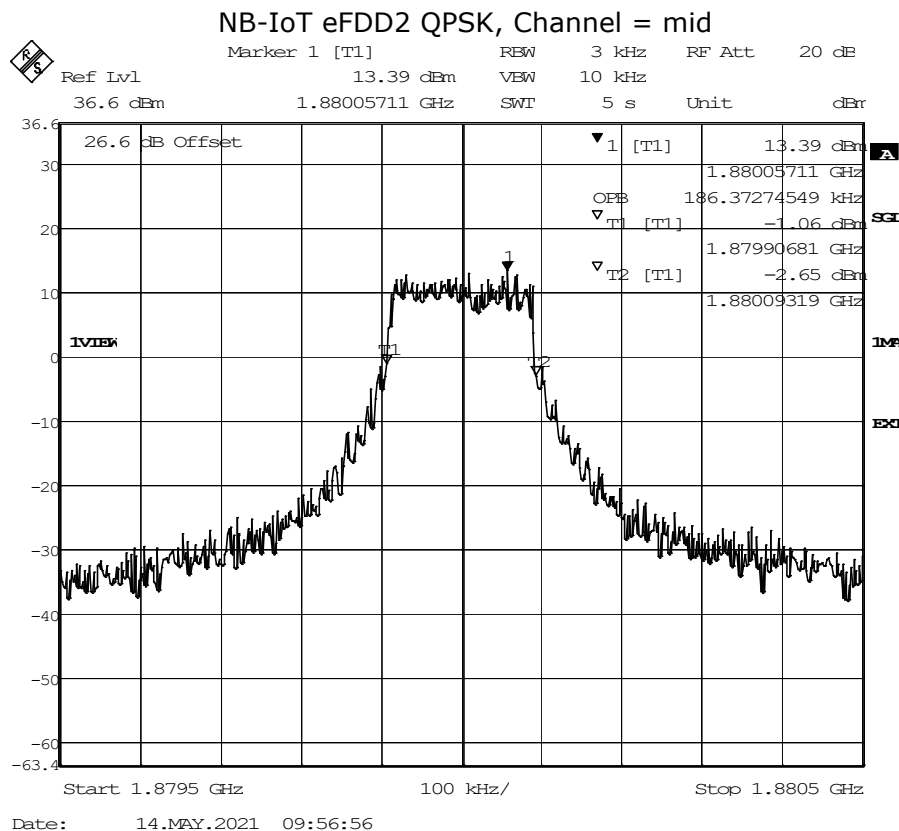

5.12.5 TEST EQUIPMENT USED

- Radio Lab

5.13 BAND EDGE COMPLIANCE

Standard **FCC PART 24 Subpart E**

The test was performed according to:
ANSI C63.26: 2015

5.13.1 TEST DESCRIPTION

This test case is intended to demonstrate compliance to the applicable conducted spurious emission test case per § 2.1051 and RSS-GEN 6.13. The limit comes from the applicable rule part and ISSED RSS-Standard for the operating band of the cellular device.

The EUT was connected to the test setup according to the following diagram:

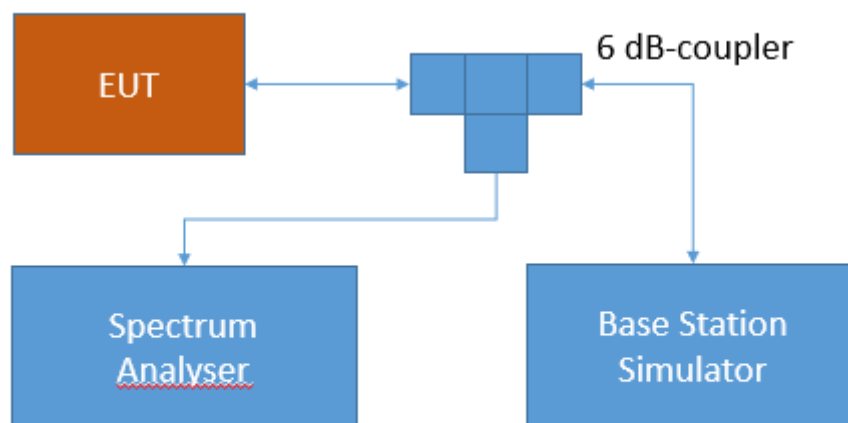

Test Setup FCC Part 22/24/27/90 Cellular;
Band edge compliance

The attenuation of the measuring and stimulus path are known for each measured frequency and are considered.

The Spectrum Analyzer settings can be directly found in the measurement diagrams.

5.13.2 TEST REQUIREMENTS / LIMITS

FCC Part 2.1051; Measurement required: Spurious emissions at antenna terminal:

The radio frequency voltage or powers generated within the equipment and appearing on a spurious frequency shall be checked at the equipment output terminals when properly loaded with a suitable artificial antenna. Curves or equivalent data shall show the magnitude of each harmonic and other spurious emission that can be detected when the equipment is operated