

FCC Measurement/Technical Report on SARA-R510M8S

FCC ID: XPYUBX19KM01
IC: 8595A-UBX19KM01

Test Report Reference: MDE_UBLOX_1905_FCC_01_rev01

Test Laboratory:

7layers GmbH
Borsigstrasse 11
40880 Ratingen
Germany



Deutsche
Akkreditierungsstelle
D-PL-12140-01-01
D-PL-12140-01-02
D-PL-12140-01-03

Note:

The following test results relate only to the devices specified in this document. This report shall not be reproduced in parts without the written approval of the test laboratory.

7layers GmbH
Borsigstraße 11
40880 Ratingen, Germany
T +49 (0) 2102 749 0
F +49 (0) 2102 749 350

Geschäftsführer/
Managing Directors:
Frank Spiller
Bernhard Retka
Alexandre Norré-Oudard

Registergericht/registered:
Düsseldorf HRB 75554
USt-Id.-Nr./VAT-No. DE203159652
Steuer-Nr./TAX-No. 147/5869/0385

*a Bureau Veritas
Group Company*

www.7layers.com

Table of Contents

1	Applied Standards and Test Summary	4
1.1	Applied Standards	4
1.2	FCC-IC Correlation Table	7
1.3	Measurement Summary / Signatures	10
2	Revision History	22
3	Administrative Data	23
3.1	Testing Laboratory	23
3.2	Project Data	23
3.3	Applicant Data	23
3.4	Manufacturer Data	23
4	Test object Data	24
4.1	General EUT Description	24
4.2	EUT Main components	24
4.3	Ancillary Equipment	24
4.4	Auxiliary Equipment	24
4.5	EUT Setups	25
4.6	Operating Modes	25
4.7	Product labelling	26
5	Test Results	27
5.1	RF Output power	27
5.2	Frequency stability	30
5.3	Spurious emissions at antenna terminals	33
5.4	Field strength of spurious radiation	36
5.5	Emission and occupied bandwidth	42
5.6	Band edge compliance	46
5.7	Peak-average-ratio	49
5.8	RF Output power	52
5.9	Frequency stability	55
5.10	Spurious emissions at antenna terminal	58
5.11	Field strength of spurious radiation	61
5.12	Emission and occupied bandwidth	67
5.13	Band edge compliance	71
5.14	Peak to Average Ratio	74
5.15	RF Output Power	77
5.16	Frequency stability	81
5.17	Spurious emissions at antenna terminals	86
5.18	Field strength of spurious radiation	93
5.19	Emission and occupied bandwidth	103

5.20	Band edge compliance	107
5.21	Peak to Average Ratio	113
5.22	RF Output Power	117
5.23	Frequency Stability	120
5.24	Spurious Emissions at antenna terminals	122
5.25	Field strength of spurious radiation	125
5.26	Emission and Occupied Bandwidth	132
5.27	Peak to Average Ratio	136
6	Test Equipment	139
7	Antenna Factors, Cable Loss and Sample Calculations	144
7.1	LISN R&S ESH3-Z5 (150 kHz – 30 MHz)	144
7.2	Antenna R&S HFH2-Z2 (9 kHz – 30 MHz)	145
7.3	Antenna R&S HL562 (30 MHz – 1 GHz)	146
7.4	Antenna R&S HF907 (1 GHz – 18 GHz)	147
7.5	Antenna EMCO 3160-09 (18 GHz – 26.5 GHz)	148
7.6	Antenna EMCO 3160-10 (26.5 GHz – 40 GHz)	149
8	Measurement Uncertainties	150
9	Photo Report	151

1 APPLIED STANDARDS AND TEST SUMMARY

1.1 APPLIED STANDARDS

Type of Authorization

Certification for a cellular mobile device.

Applicable FCC Rules

Prepared in accordance with the requirements of FCC Rules and Regulations as listed in 47 CFR Ch.1 Parts 2 and 22, (10-1-18 Edition). The following subparts are applicable to the results in this test report.

Part 2, Subpart J - Equipment Authorization Procedures, Certification

Part 22, Subpart H - Cellular Radiotelephone Service

§ 22.905 - Channels for cellular service

§ 22.913 - Effective radiated power limits

§ 22.917 - Emission limitations for cellular equipment

The tests were selected and performed with reference to:

- FCC Public Notice 971168 applying "Measurement guidance for certification of licensed digital transmitters" 971168 D01 v03r01, 2018-04-09
- ANSI C63.26: 2015

Type of Authorization

Certification for a cellular mobile device.

Applicable FCC Rules

Prepared in accordance with the requirements of FCC Rules and Regulations as listed in 47 CFR Ch.1 Parts 2 and 90, (10-1-18 Edition). The following subparts are applicable to the results in this test report.

Part 2, Subpart J - Equipment Authorization Procedures, Certification

Part 90; Private Land Mobile Radio Services

Subpart S—REGULATIONS GOVERNING LICENSING AND USE OF FREQUENCIES IN THE 806-824, 851-869, 896-901, AND 935-940 MHZ BANDS

Subpart R—REGULATIONS GOVERNING THE LICENSING AND USE OF FREQUENCIES IN THE 763-775 AND 793-805 MHZ BANDS

§ 90.635 – Limitations on power and antenna height
§ 90.543 – Emission limitations
§ 90.539 – Frequency stability

The tests were selected and performed with reference to:

- FCC Public Notice 971168 applying "Measurement guidance for certification of licensed digital transmitters" 971168 D01 v03r01, 2018-04-09
- ANSI C63.26: 2015

Type of Authorization

Certification for a cellular mobile device.

Applicable FCC Rules

Prepared in accordance with the requirements of FCC Rules and Regulations as listed in 47 CFR Ch.1 Parts 2 and 24, (10-1-18 Edition). The following subparts are applicable to the results in this test report.

Part 2, Subpart J - Equipment Authorization Procedures, Certification

Part 24, Subpart E – Broadband PCS

§ 24.232 – Power and antenna height limits
§ 24.235 – Frequency stability
§ 24.238 – Emission limitations for Broadband PCS equipment

The tests were selected and performed with reference to:

- FCC Public Notice 971168 applying "Measurement guidance for certification of licensed digital transmitters" 971168 D01 v03r01, 2018-04-09
- ANSI C63.26: 2015

Type of Authorization

Certification for a cellular mobile device.

Applicable FCC Rules

Prepared in accordance with the requirements of FCC Rules and Regulations as listed in 47 CFR Ch.1 Parts 2 and 27, (10-1-18 Edition). The following subparts are applicable to the results in this test report.

Part 2, Subpart J - Equipment Authorization Procedures, Certification

Part 27; Miscellaneous Wireless Communications Services
Subpart C – Technical standards

- § 27.50 – Power and duty cycle limits
- § 27.53 – Emission limits
- § 27.54 – Frequency stability

The tests were selected and performed with reference to:

- FCC Public Notice 971168 applying “Measurement guidance for certification of licensed digital transmitters” 971168 D01 v03r01, 2018-04-09
- ANSI C63.26: 2015

Summary Test Results:

The EUT complied with all performed tests as listed in chapter 1.3 Measurement Summary / Signatures.

1.2 FCC-IC CORRELATION TABLE

**Correlation of measurement requirements for
Cellular Mobile Devices
from
FCC and ISED Canada**

FCC Part 22

Measurement	FCC reference	ISED reference
RF Output Power	§ 2.1046 § 22.913	RSS-GEN Issue 5, 6.12 RSS-132 Issue 3, 5.4
Peak-Average-Ratio	-	RSS 132 Issue 3: 5.4
Emission and Occupied bandwidth	§ 2.1049	RSS-GEN Issue 5, 6.7
Spurious Emission at Antenna Terminals	§ 2.1051 § 22.917	RSS-GEN Issue 5, 6.13 RSS-132 Issue 3, 5.5
Band Edge Compliance	§ 2.1051 § 22.917	RSS-GEN Issue 4, 6.13 RSS-132 Issue 3, 5.5
Frequency stability	§ 2.1055 § 22.355	RSS-GEN Issue 5, 6.11 RSS-132 Issue 3: 5.3
Field strength of spurious radiation	§ 2.1053 § 22.917	RSS-GEN Issue 5, 6.13 RSS-132 Issue 3: 5.5

FCC Part 90

Measurement	FCC reference	ISED reference
RF Output Power	§ 2.1046 § 90.635	RSS-GEN Issue 5, 6.12
Peak to Average-Ratio	§ 90.635	
Emission and Occupied bandwidth	§ 2.1049	RSS-GEN Issue 5, 6.7
Spurious Emission at Antenna Terminals	§ 2.1051 § 90.543	RSS-GEN Issue 5, 6.13
Band Edge Compliance	§ 2.1051 § 90.543	RSS-GEN Issue 5, 6.13
Frequency stability	§ 2.1055 § 90.539	RSS-GEN Issue 5, 6.11
Field strength of spurious radiation	§ 2.1053 § 90.543	RSS-GEN Issue 5, 6.13

FCC Part 24

Measurement	FCC reference	ISED reference
RF Output Power	§ 2.1046 § 24.232	RSS-GEN Issue 5, 6.12 RSS-133 Issue 6, 6.4
Peak-Average-Ratio	§ 24.232	RSS 133 Issue 6: 6.4
Emission and Occupied bandwidth	§ 2.1049	RSS-GEN Issue 5, 6.7
Spurious Emission at Antenna Terminals	§ 2.1051 § 24.238	RSS-GEN Issue 5, 6.13 RSS-133 Issue 6, 6.5
Band Edge Compliance	§ 2.1051 § 24.238	RSS-GEN Issue 5, 6.13 RSS-133 Issue 6, 6.5
Frequency stability	§ 2.1055 § 24.235	RSS-GEN Issue 5, 6.11 RSS-133 Issue 6: 6.3
Field strength of spurious radiation	§ 2.1053 § 24.236	RSS-GEN Issue 5, 6.13 RSS-133 Issue 6: 6.5

FCC Part 27

Measurement	FCC reference	ISED reference
RF Output Power	§ 2.1046 § 27.50	RSS-GEN Issue 5, 6.12 RSS-130 Issue 2, 4.6.2/4.6.3 RSS-139 Issue 3, 6.5 RSS-199 Issue 3, 4.4
Peak to Average-Ratio	§ 27.50	RSS-130 Issue 2: 4.6.1 RSS 139 Issue 3: 6.5 RSS-199 Issue 3, 4.4
Emission and Occupied bandwidth	§ 2.1049	RSS-GEN Issue 5, 6.7
Spurious Emission at Antenna Terminals	§ 2.1051 § 27.53	RSS-GEN Issue 5, 6.13 RSS-130 Issue 2: 4.7.1/4.7.2 RSS-139 Issue 3, 6.6 RSS-199 Issue 3, 4.5
Band Edge Compliance	§ 2.1051 § 27.53	RSS-GEN Issue 5, 6.13 RSS-130 Issue 2: 4.7.1/4.7.2 RSS-139 Issue 3, 6.6 RSS-199 Issue 3, 4.5
Frequency stability	§ 2.1055 § 27.54	RSS-GEN Issue 5, 6.11 RSS-130 Issue 2: 4.5 RSS-139 Issue 3: 6.4 RSS-199 Issue 3, 4.3
Field strength of spurious radiation	§ 2.1053 § 27.53	RSS-GEN Issue 5, 6.13 RSS-130 Issue 2: 4.7.1/4.7.2 RSS-139 Issue 3: 6.6 RSS-199 Issue 3, 4.5

1.3 MEASUREMENT SUMMARY / SIGNATURES

47 CFR CHAPTER I FCC PART 22

§ 2.1046 § 22.913

Subpart H

RF Output power

The measurement was performed according to ANSI C63.26: 2015

Final Result

OP-Mode

Technology, Radio Technology, Operating Frequency, ChBW, Ressource Blocks, Measurement method

	Setup	Date	FCC	IC
CAT-M1, eFDD 26 16QAM, high channel, 1.4 MHz, 1, conducted	S01_AR11	2020-01-28	Passed	Passed
CAT-M1, eFDD 26 16QAM, high channel, 1.4 MHz, 5, conducted	S01_AR11	2020-01-28	Passed	Passed
CAT-M1, eFDD 26 16QAM, low channel, 1.4 MHz, 1, conducted	S01_AR11	2020-01-28	Passed	Passed
CAT-M1, eFDD 26 16QAM, low channel, 1.4 MHz, 5, conducted	S01_AR11	2020-01-28	Passed	Passed
CAT-M1, eFDD 26 16QAM, mid channel, 1.4 MHz, 1, conducted	S01_AR11	2020-01-28	Passed	Passed
CAT-M1, eFDD 26 16QAM, mid channel, 1.4 MHz, 5, conducted	S01_AR11	2020-01-28	Passed	Passed
CAT-M1, eFDD 26 QPSK, high channel, 1.4 MHz, 1, conducted	S01_AR11	2020-01-28	Passed	Passed
CAT-M1, eFDD 26 QPSK, high channel, 1.4 MHz, 3, conducted	S01_AR11	2020-01-28	Passed	Passed
CAT-M1, eFDD 26 QPSK, high channel, 1.4 MHz, 6, conducted	S01_AR11	2020-01-28	Passed	Passed
CAT-M1, eFDD 26 QPSK, low channel, 1.4 MHz, 1, conducted	S01_AR11	2020-01-28	Passed	Passed
CAT-M1, eFDD 26 QPSK, low channel, 1.4 MHz, 3, conducted	S01_AR11	2020-01-28	Passed	Passed
CAT-M1, eFDD 26 QPSK, low channel, 1.4 MHz, 6, conducted	S01_AR11	2020-01-28	Passed	Passed
CAT-M1, eFDD 26 QPSK, mid channel, 1.4 MHz, 1, conducted	S01_AR11	2020-01-28	Passed	Passed
CAT-M1, eFDD 26 QPSK, mid channel, 1.4 MHz, 3, conducted	S01_AR11	2020-01-28	Passed	Passed
CAT-M1, eFDD 26 QPSK, mid channel, 1.4 MHz, 6, conducted	S01_AR11	2020-01-28	Passed	Passed
CAT-M1, eFDD 5 16QAM, high channel, 1.4 MHz, 1, conducted	S01_AR11	2020-01-28	Passed	Passed
CAT-M1, eFDD 5 16QAM, high channel, 1.4 MHz, 5, conducted	S01_AR11	2020-01-28	Passed	Passed
CAT-M1, eFDD 5 16QAM, low channel, 1.4 MHz, 1, conducted	S01_AR11	2020-01-28	Passed	Passed
CAT-M1, eFDD 5 16QAM, low channel, 1.4 MHz, 5, conducted	S01_AR11	2020-01-28	Passed	Passed
CAT-M1, eFDD 5 16QAM, mid channel, 1.4 MHz, 1, conducted	S01_AR11	2020-01-28	Passed	Passed
CAT-M1, eFDD 5 16QAM, mid channel, 1.4 MHz, 5, conducted	S01_AR11	2020-01-28	Passed	Passed
CAT-M1, eFDD 5 QPSK, high channel, 1.4 MHz, 1, conducted	S01_AR11	2020-01-28	Passed	Passed
CAT-M1, eFDD 5 QPSK, high channel, 1.4 MHz, 3, conducted	S01_AR11	2020-01-28	Passed	Passed
CAT-M1, eFDD 5 QPSK, high channel, 1.4 MHz, 6, conducted	S01_AR11	2020-01-28	Passed	Passed
CAT-M1, eFDD 5 QPSK, low channel, 1.4 MHz, 1, conducted	S01_AR11	2020-01-28	Passed	Passed
CAT-M1, eFDD 5 QPSK, low channel, 1.4 MHz, 3, conducted	S01_AR11	2020-01-28	Passed	Passed
CAT-M1, eFDD 5 QPSK, low channel, 1.4 MHz, 6, conducted	S01_AR11	2020-01-28	Passed	Passed
CAT-M1, eFDD 5 QPSK, mid channel, 1.4 MHz, 1, conducted	S01_AR11	2020-01-28	Passed	Passed
CAT-M1, eFDD 5 QPSK, mid channel, 1.4 MHz, 3, conducted	S01_AR11	2020-01-28	Passed	Passed
CAT-M1, eFDD 5 QPSK, mid channel, 1.4 MHz, 6, conducted	S01_AR11	2020-01-28	Passed	Passed

47 CFR CHAPTER I FCC PART 22 § 2.1055 § 22.355
Subpart H

Frequency stability
 The measurement was performed according to ANSI C63.26: 2015 **Final Result**

OP-Mode	Setup	Date	FCC	IC
Technology, Radio Technology, Operating Frequency, ChBW, Ressource Blocks, Measurement method				
CAT-M1, eFDD 5 QPSK, mid channel, 1.4 MHz, 1, conducted	S01_AR11	2020-01-27	Passed	Passed
CAT-M1, eFDD 26 QPSK, mid channel, 1.4 MHz, 1, conducted COMMENT: eFDD26 was tested for Part90	-	-	-	-

47 CFR CHAPTER I FCC PART 22 § 2.1051 § 22.917
Subpart H

Spurious emissions at antenna terminals
 The measurement was performed according to ANSI C63.26: 2015 **Final Result**

OP-Mode	Setup	Date	FCC	IC
Technology, Radio Technology, Operating Frequency, ChBW, Ressource Blocks, Measurement method				
CAT-M1, eFDD 26 QPSK, high channel, 1.4 MHz, 1, conducted	S01_AR11	2020-01-28	Passed	Passed
CAT-M1, eFDD 26 QPSK, low channel, 1.4 MHz, 1, conducted	S01_AR11	2020-01-28	Passed	Passed
CAT-M1, eFDD 26 QPSK, mid channel, 1.4 MHz, 1, conducted	S01_AR11	2020-01-28	Passed	Passed
CAT-M1, eFDD 5 QPSK, high channel, 1.4 MHz, 1, conducted	S01_AR11	2020-01-27	Passed	Passed
CAT-M1, eFDD 5 QPSK, low channel, 1.4 MHz, 1, conducted	S01_AR11	2020-01-27	Passed	Passed
CAT-M1, eFDD 5 QPSK, mid channel, 1.4 MHz, 1, conducted	S01_AR11	2020-01-27	Passed	Passed

47 CFR CHAPTER I FCC PART 22 § 2.1053 § 22.917
Subpart H

Field strength of spurious radiation
 The measurement was performed according to ANSI C63.26: 2015 **Final Result**

OP-Mode	Setup	Date	FCC	IC
Technology, Radio Technology, Operating Frequency, ChBW, Ressource Blocks, Measurement method				
CAT-M1, eFDD 26 QPSK, high channel, 1.4 MHz, 1, radiated	S01_AR11	2020-01-31	Passed	Passed
CAT-M1, eFDD 26 QPSK, low channel, 1.4 MHz, 1, radiated	S01_AR11	2020-01-31	Passed	Passed
CAT-M1, eFDD 26 QPSK, mid channel, 1.4 MHz, 1, radiated	S01_AR11	2020-01-31	Passed	Passed
CAT-M1, eFDD 5 QPSK, high channel, 1.4 MHz, 1, radiated	S01_AR11	2020-01-31	Passed	Passed
CAT-M1, eFDD 5 QPSK, low channel, 1.4 MHz, 1, radiated	S01_AR11	2020-01-31	Passed	Passed
CAT-M1, eFDD 5 QPSK, mid channel, 1.4 MHz, 1, radiated	S01_AR11	2020-01-31	Passed	Passed

47 CFR CHAPTER I FCC PART 22 § 2.1049
Subpart H

Emission and occupied bandwidth
 The measurement was performed according to ANSI C63.26: 2015 **Final Result**

OP-Mode	Setup	Date	FCC	IC
Technology, Radio Technology, Operating Frequency, ChBW, Ressource Blocks, Measurement method				
CAT-M1, eFDD 26 16QAM, high channel, 1.4 MHz, 5, conducted	S01_AR11	2020-01-22	Passed	Passed
CAT-M1, eFDD 26 16QAM, low channel, 1.4 MHz, 5, conducted	S01_AR11	2020-01-22	Passed	Passed
CAT-M1, eFDD 26 16QAM, mid channel, 1.4 MHz, 5, conducted	S01_AR11	2020-01-22	Passed	Passed

47 CFR CHAPTER I FCC PART 22 § 2.1049
Subpart H

Emission and occupied bandwidth

The measurement was performed according to ANSI C63.26: 2015

Final Result

OP-Mode	Setup	Date	FCC	IC
Technology, Radio Technology, Operating Frequency, ChBW, Ressource Blocks, Measurement method				
CAT-M1, eFDD 26 QPSK, high channel, 1.4 MHz, 6, conducted	S01_AR11	2020-01-22	Passed	Passed
CAT-M1, eFDD 26 QPSK, low channel, 1.4 MHz, 6, conducted	S01_AR11	2020-01-22	Passed	Passed
CAT-M1, eFDD 26 QPSK, mid channel, 1.4 MHz, 6, conducted	S01_AR11	2020-01-22	Passed	Passed
CAT-M1, eFDD 5 16QAM, high channel, 1.4 MHz, 5, conducted	S01_AR11	2020-01-22	Passed	Passed
CAT-M1, eFDD 5 16QAM, low channel, 1.4 MHz, 5, conducted	S01_AR11	2020-01-22	Passed	Passed
CAT-M1, eFDD 5 16QAM, mid channel, 1.4 MHz, 5, conducted	S01_AR11	2020-01-22	Passed	Passed
CAT-M1, eFDD 5 QPSK, high channel, 1.4 MHz, 6, conducted	S01_AR11	2020-01-22	Passed	Passed
CAT-M1, eFDD 5 QPSK, low channel, 1.4 MHz, 6, conducted	S01_AR11	2020-01-22	Passed	Passed
CAT-M1, eFDD 5 QPSK, mid channel, 1.4 MHz, 6, conducted	S01_AR11	2020-01-22	Passed	Passed

47 CFR CHAPTER I FCC PART 22 § 2.1051 § 22.917
Subpart H

Band edge compliance

The measurement was performed according to ANSI C63.26: 2015

Final Result

OP-Mode	Setup	Date	FCC	IC
Technology, Radio Technology, Operating Frequency, ChBW, Ressource Blocks, Measurement method				
CAT-M1, eFDD 26 16QAM, high channel, 1.4 MHz, 5, conducted	S01_AR11	2020-01-21	Passed	Passed
CAT-M1, eFDD 26 16QAM, low channel, 1.4 MHz, 5, conducted	S01_AR11	2020-01-21	Passed	Passed
CAT-M1, eFDD 26 QPSK, high channel, 1.4 MHz, 6, conducted	S01_AR11	2020-01-21	Passed	Passed
CAT-M1, eFDD 26 QPSK, low channel, 1.4 MHz, 6, conducted	S01_AR11	2020-01-21	Passed	Passed
CAT-M1, eFDD 5 16QAM, high channel, 1.4 MHz, 5, conducted	S01_AR11	2020-01-27	Passed	Passed
CAT-M1, eFDD 5 16QAM, low channel, 1.4 MHz, 5, conducted	S01_AR11	2020-01-27	Passed	Passed
CAT-M1, eFDD 5 QPSK, high channel, 1.4 MHz, 6, conducted	S01_AR11	2020-01-27	Passed	Passed
CAT-M1, eFDD 5 QPSK, low channel, 1.4 MHz, 6, conducted	S01_AR11	2020-01-27	Passed	Passed

47 CFR CHAPTER I FCC PART 22 -
Subpart H

Peak-average-ratio

The measurement was performed according to ANSI C63.26: 2015

Final Result

OP-Mode	Setup	Date	FCC	IC
Technology, Radio Technology, Operating Frequency, ChBW, Ressource Blocks, Measurement method				
CAT-M1, eFDD 26 16QAM, high channel, 1.4 MHz, 5, conducted	S01_AR11	2020-01-29	Passed	Passed
CAT-M1, eFDD 26 16QAM, low channel, 1.4 MHz, 5, conducted	S01_AR11	2020-01-29	Passed	Passed
CAT-M1, eFDD 26 16QAM, mid channel, 1.4 MHz, 5, conducted	S01_AR11	2020-01-29	Passed	Passed
CAT-M1, eFDD 26 QPSK, high channel, 1.4 MHz, 6, conducted	S01_AR11	2020-01-29	Passed	Passed
CAT-M1, eFDD 26 QPSK, low channel, 1.4 MHz, 6, conducted	S01_AR11	2020-01-29	Passed	Passed
CAT-M1, eFDD 26 QPSK, mid channel, 1.4 MHz, 6, conducted	S01_AR11	2020-01-29	Passed	Passed
CAT-M1, eFDD 5 16QAM, high channel, 1.4 MHz, 5, conducted	S01_AR11	2020-01-29	Passed	Passed
CAT-M1, eFDD 5 16QAM, low channel, 1.4 MHz, 5, conducted	S01_AR11	2020-01-29	Passed	Passed
CAT-M1, eFDD 5 16QAM, mid channel, 1.4 MHz, 5, conducted	S01_AR11	2020-01-29	Passed	Passed
CAT-M1, eFDD 5 QPSK, high channel, 1.4 MHz, 6, conducted	S01_AR11	2020-01-29	Passed	Passed
CAT-M1, eFDD 5 QPSK, low channel, 1.4 MHz, 6, conducted	S01_AR11	2020-01-29	Passed	Passed

47 CFR CHAPTER I FCC PART 22 -
Subpart H

Peak-average-ratio
 The measurement was performed according to ANSI C63.26: 2015 **Final Result**

OP-Mode	Setup	Date	FCC	IC
Technology, Radio Technology, Operating Frequency, ChBW, Ressource Blocks, Measurement method				
CAT-M1, eFDD 5 QPSK, mid channel, 1.4 MHz, 6, conducted	S01_AR11	2020-01-29	Passed	Passed

47 CFR CHAPTER I FCC PART 24 § 2.1046 § 24.232
Subpart E

RF Output power
 The measurement was performed according to ANSI C63.26: 2015 **Final Result**

OP-Mode	Setup	Date	FCC	IC
Technology, Radio Technology, Operating Frequency, ChBW, Ressource Blocks, Measurement method				
CAT-M1, eFDD 2 16QAM, high channel, 1.4 MHz, 1, conducted	S01_AR11	2020-01-27	Passed	Passed
CAT-M1, eFDD 2 16QAM, high channel, 1.4 MHz, 5, conducted	S01_AR11	2020-01-27	Passed	Passed
CAT-M1, eFDD 2 16QAM, low channel, 1.4 MHz, 1, conducted	S01_AR11	2020-01-27	Passed	Passed
CAT-M1, eFDD 2 16QAM, low channel, 1.4 MHz, 5, conducted	S01_AR11	2020-01-27	Passed	Passed
CAT-M1, eFDD 2 16QAM, mid channel, 1.4 MHz, 1, conducted	S01_AR11	2020-01-27	Passed	Passed
CAT-M1, eFDD 2 16QAM, mid channel, 1.4 MHz, 5, conducted	S01_AR11	2020-01-27	Passed	Passed
CAT-M1, eFDD 2 QPSK, high channel, 1.4 MHz, 1, conducted	S01_AR11	2020-01-27	Passed	Passed
CAT-M1, eFDD 2 QPSK, high channel, 1.4 MHz, 3, conducted	S01_AR11	2020-01-27	Passed	Passed
CAT-M1, eFDD 2 QPSK, high channel, 1.4 MHz, 6, conducted	S01_AR11	2020-01-27	Passed	Passed
CAT-M1, eFDD 2 QPSK, low channel, 1.4 MHz, 1, conducted	S01_AR11	2020-01-27	Passed	Passed
CAT-M1, eFDD 2 QPSK, low channel, 1.4 MHz, 3, conducted	S01_AR11	2020-01-27	Passed	Passed
CAT-M1, eFDD 2 QPSK, low channel, 1.4 MHz, 6, conducted	S01_AR11	2020-01-27	Passed	Passed
CAT-M1, eFDD 2 QPSK, mid channel, 1.4 MHz, 1, conducted	S01_AR11	2020-01-27	Passed	Passed
CAT-M1, eFDD 2 QPSK, mid channel, 1.4 MHz, 3, conducted	S01_AR11	2020-01-27	Passed	Passed
CAT-M1, eFDD 2 QPSK, mid channel, 1.4 MHz, 6, conducted	S01_AR11	2020-01-27	Passed	Passed
CAT-M1, eFDD 25 16QAM, high channel, 1.4 MHz, 1, conducted	S01_AR11	2020-01-28	Passed	Passed
CAT-M1, eFDD 25 16QAM, high channel, 1.4 MHz, 5, conducted	S01_AR11	2020-01-28	Passed	Passed
CAT-M1, eFDD 25 16QAM, low channel, 1.4 MHz, 1, conducted	S01_AR11	2020-01-28	Passed	Passed
CAT-M1, eFDD 25 16QAM, low channel, 1.4 MHz, 5, conducted	S01_AR11	2020-01-28	Passed	Passed
CAT-M1, eFDD 25 16QAM, mid channel, 1.4 MHz, 1, conducted	S01_AR11	2020-01-28	Passed	Passed
CAT-M1, eFDD 25 16QAM, mid channel, 1.4 MHz, 5, conducted	S01_AR11	2020-01-28	Passed	Passed
CAT-M1, eFDD 25 QPSK, high channel, 1.4 MHz, 1, conducted	S01_AR11	2020-01-28	Passed	Passed
CAT-M1, eFDD 25 QPSK, high channel, 1.4 MHz, 3, conducted	S01_AR11	2020-01-28	Passed	Passed
CAT-M1, eFDD 25 QPSK, high channel, 1.4 MHz, 6, conducted	S01_AR11	2020-01-28	Passed	Passed
CAT-M1, eFDD 25 QPSK, low channel, 1.4 MHz, 1, conducted	S01_AR11	2020-01-28	Passed	Passed
CAT-M1, eFDD 25 QPSK, low channel, 1.4 MHz, 3, conducted	S01_AR11	2020-01-28	Passed	Passed
CAT-M1, eFDD 25 QPSK, low channel, 1.4 MHz, 6, conducted	S01_AR11	2020-01-28	Passed	Passed
CAT-M1, eFDD 25 QPSK, mid channel, 1.4 MHz, 1, conducted	S01_AR11	2020-01-28	Passed	Passed
CAT-M1, eFDD 25 QPSK, mid channel, 1.4 MHz, 3, conducted	S01_AR11	2020-01-28	Passed	Passed
CAT-M1, eFDD 25 QPSK, mid channel, 1.4 MHz, 6, conducted	S01_AR11	2020-01-28	Passed	Passed

47 CFR CHAPTER I FCC PART 24 § 2.1055 § 24.235
Subpart E

Frequency stability
 The measurement was performed according to ANSI C63.26: 2015 **Final Result**

OP-Mode	Setup	Date	FCC	IC
Technology, Radio Technology, Operating Frequency, ChBW, Ressource Blocks, Measurement method				
CAT-M1, eFDD 2 QPSK, mid channel, 1.4 MHz, 1, conducted	S01_AR11	2020-01-27	Passed	Passed
CAT-M1, eFDD 25 QPSK, mid channel, 1.4 MHz, 1, conducted	S01_AR11	2020-01-27	Passed	Passed

47 CFR CHAPTER I FCC PART 24 § 2.1051 § 24.238
Subpart E

Spurious emissions at antenna terminal
 The measurement was performed according to ANSI C63.26: 2015 **Final Result**

OP-Mode	Setup	Date	FCC	IC
Technology, Radio Technology, Operating Frequency, ChBW, Ressource Blocks, Measurement method				
CAT-M1, eFDD 2 QPSK, high channel, 1.4 MHz, 1, conducted	S01_AR11	2020-01-22	Passed	Passed
CAT-M1, eFDD 2 QPSK, low channel, 1.4 MHz, 1, conducted	S01_AR11	2020-01-22	Passed	Passed
CAT-M1, eFDD 2 QPSK, mid channel, 1.4 MHz, 1, conducted	S01_AR11	2020-01-22	Passed	Passed
CAT-M1, eFDD 25 QPSK, high channel, 1.4 MHz, 1, conducted	S01_AR11	2020-01-22	Passed	Passed
CAT-M1, eFDD 25 QPSK, low channel, 1.4 MHz, 1, conducted	S01_AR11	2020-01-22	Passed	Passed
CAT-M1, eFDD 25 QPSK, mid channel, 1.4 MHz, 1, conducted	S01_AR11	2020-01-22	Passed	Passed

47 CFR CHAPTER I FCC PART 24 § 2.1053 § 24.236
Subpart E

Field strength of spurious radiation
 The measurement was performed according to ANSI C63.26: 2015 **Final Result**

OP-Mode	Setup	Date	FCC	IC
Technology, Radio Technology, Operating Frequency, ChBW, Ressource Blocks, Measurement method				
CAT-M1, eFDD 2 QPSK, high channel, 1.4 MHz, 1, radiated	S01_AR11	2020-01-31	Passed	Passed
CAT-M1, eFDD 2 QPSK, low channel, 1.4 MHz, 1, radiated	S01_AR11	2020-01-31	Passed	Passed
CAT-M1, eFDD 2 QPSK, mid channel, 1.4 MHz, 1, radiated	S01_AR11	2020-01-31	Passed	Passed
CAT-M1, eFDD 25 QPSK, high channel, 1.4 MHz, 1, radiated	S01_AR11	2020-01-31	Passed	Passed
CAT-M1, eFDD 25 QPSK, low channel, 1.4 MHz, 1, radiated	S01_AR11	2020-01-31	Passed	Passed
CAT-M1, eFDD 25 QPSK, mid channel, 1.4 MHz, 1, radiated	S01_AR11	2020-01-31	Passed	Passed

47 CFR CHAPTER I FCC PART 24 § 2.1049
Subpart E

Emission and occupied bandwidth
 The measurement was performed according to ANSI C63.26: 2015 **Final Result**

OP-Mode	Setup	Date	FCC	IC
Technology, Radio Technology, Operating Frequency, ChBW, Ressource Blocks, Measurement method				
CAT-M1, eFDD 2 16QAM, high channel, 1.4 MHz, 5, conducted	S01_AR11	2020-01-22	Passed	Passed
CAT-M1, eFDD 2 16QAM, low channel, 1.4 MHz, 5, conducted	S01_AR11	2020-01-22	Passed	Passed
CAT-M1, eFDD 2 16QAM, mid channel, 1.4 MHz, 5, conducted	S01_AR11	2020-01-22	Passed	Passed
CAT-M1, eFDD 2 QPSK, high channel, 1.4 MHz, 6, conducted	S01_AR11	2020-01-22	Passed	Passed
CAT-M1, eFDD 2 QPSK, low channel, 1.4 MHz, 6, conducted	S01_AR11	2020-01-22	Passed	Passed

47 CFR CHAPTER I FCC PART 24 § 2.1049
Subpart E

Emission and occupied bandwidth

The measurement was performed according to ANSI C63.26: 2015

Final Result

OP-Mode Technology, Radio Technology, Operating Frequency, ChBW, Ressource Blocks, Measurement method	Setup	Date	FCC	IC
CAT-M1, eFDD 2 QPSK, mid channel, 1.4 MHz, 6, conducted	S01_AR11	2020-01-22	Passed	Passed
CAT-M1, eFDD 25 16QAM, high channel, 1.4 MHz, 5, conducted	S01_AR11	2020-01-22	Passed	Passed
CAT-M1, eFDD 25 16QAM, low channel, 1.4 MHz, 5, conducted	S01_AR11	2020-01-22	Passed	Passed
CAT-M1, eFDD 25 16QAM, mid channel, 1.4 MHz, 5, conducted	S01_AR11	2020-01-22	Passed	Passed
CAT-M1, eFDD 25 QPSK, high channel, 1.4 MHz, 6, conducted	S01_AR11	2020-01-22	Passed	Passed
CAT-M1, eFDD 25 QPSK, low channel, 1.4 MHz, 6, conducted	S01_AR11	2020-01-22	Passed	Passed
CAT-M1, eFDD 25 QPSK, mid channel, 1.4 MHz, 6, conducted	S01_AR11	2020-01-22	Passed	Passed

47 CFR CHAPTER I FCC PART 24 § 2.1051 § 24.238
Subpart E

Band edge compliance

The measurement was performed according to ANSI C63.26: 2015

Final Result

OP-Mode Technology, Radio Technology, Operating Frequency, ChBW, Ressource Blocks, Measurement method	Setup	Date	FCC	IC
CAT-M1, eFDD 2 16QAM, high channel, 1.4 MHz, 5, conducted	S01_AR11	2020-01-27	Passed	Passed
CAT-M1, eFDD 2 16QAM, low channel, 1.4 MHz, 5, conducted	S01_AR11	2020-01-27	Passed	Passed
CAT-M1, eFDD 2 QPSK, high channel, 1.4 MHz, 6, conducted	S01_AR11	2020-01-27	Passed	Passed
CAT-M1, eFDD 2 QPSK, low channel, 1.4 MHz, 6, conducted	S01_AR11	2020-01-27	Passed	Passed
CAT-M1, eFDD 25 16QAM, high channel, 1.4 MHz, 5, conducted	S01_AR11	2020-01-27	Passed	Passed
CAT-M1, eFDD 25 16QAM, low channel, 1.4 MHz, 5, conducted	S01_AR11	2020-01-27	Passed	Passed
CAT-M1, eFDD 25 QPSK, high channel, 1.4 MHz, 6, conducted	S01_AR11	2020-01-27	Passed	Passed
CAT-M1, eFDD 25 QPSK, low channel, 1.4 MHz, 6, conducted	S01_AR11	2020-01-27	Passed	Passed

47 CFR CHAPTER I FCC PART 24 § 24.232
Subpart E

Peak to Average Ratio

The measurement was performed according to ANSI C63.26: 2015

Final Result

OP-Mode Technology, Radio Technology, Operating Frequency, ChBW, Ressource Blocks, Measurement method	Setup	Date	FCC	IC
CAT-M1, eFDD 2 16QAM, high channel, 1.4 MHz, 5, conducted	S01_AR11	2020-01-29	Passed	Passed
CAT-M1, eFDD 2 16QAM, low channel, 1.4 MHz, 5, conducted	S01_AR11	2020-01-29	Passed	Passed
CAT-M1, eFDD 2 16QAM, mid channel, 1.4 MHz, 5, conducted	S01_AR11	2020-01-29	Passed	Passed
CAT-M1, eFDD 2 QPSK, high channel, 1.4 MHz, 6, conducted	S01_AR11	2020-01-29	Passed	Passed
CAT-M1, eFDD 2 QPSK, low channel, 1.4 MHz, 6, conducted	S01_AR11	2020-01-29	Passed	Passed
CAT-M1, eFDD 2 QPSK, mid channel, 1.4 MHz, 6, conducted	S01_AR11	2020-01-29	Passed	Passed
CAT-M1, eFDD 25 16QAM, high channel, 1.4 MHz, 5, conducted	S01_AR11	2020-01-29	Passed	Passed
CAT-M1, eFDD 25 16QAM, low channel, 1.4 MHz, 5, conducted	S01_AR11	2020-01-29	Passed	Passed
CAT-M1, eFDD 25 16QAM, mid channel, 1.4 MHz, 5, conducted	S01_AR11	2020-01-29	Passed	Passed
CAT-M1, eFDD 25 QPSK, high channel, 1.4 MHz, 6, conducted	S01_AR11	2020-01-29	Passed	Passed
CAT-M1, eFDD 25 QPSK, low channel, 1.4 MHz, 6, conducted	S01_AR11	2020-01-29	Passed	Passed
CAT-M1, eFDD 25 QPSK, mid channel, 1.4 MHz, 6, conducted	S01_AR11	2020-01-29	Passed	Passed

47 CFR CHAPTER I FCC PART 27
Subpart C

§ 2.1046 § 27.50

RF Output Power

The measurement was performed according to ANSI C63.26: 2015

Final Result

OP-Mode	Setup	Date	FCC	IC
Technology, Radio Technology, Operating Frequency, ChBW, Ressource Blocks, Measurement method				
CAT-M1, eFDD 12 16QAM, high channel, 1.4 MHz, 1, conducted	S01_AR11	2020-01-28	Passed	Passed
CAT-M1, eFDD 12 16QAM, high channel, 1.4 MHz, 5, conducted	S01_AR11	2020-01-28	Passed	Passed
CAT-M1, eFDD 12 16QAM, low channel, 1.4 MHz, 1, conducted	S01_AR11	2020-01-28	Passed	Passed
CAT-M1, eFDD 12 16QAM, low channel, 1.4 MHz, 5, conducted	S01_AR11	2020-01-28	Passed	Passed
CAT-M1, eFDD 12 16QAM, mid channel, 1.4 MHz, 1, conducted	S01_AR11	2020-01-28	Passed	Passed
CAT-M1, eFDD 12 16QAM, mid channel, 1.4 MHz, 5, conducted	S01_AR11	2020-01-28	Passed	Passed
CAT-M1, eFDD 12 QPSK, high channel, 1.4 MHz, 1, conducted	S01_AR11	2020-01-28	Passed	Passed
CAT-M1, eFDD 12 QPSK, high channel, 1.4 MHz, 3, conducted	S01_AR11	2020-01-28	Passed	Passed
CAT-M1, eFDD 12 QPSK, high channel, 1.4 MHz, 6, conducted	S01_AR11	2020-01-28	Passed	Passed
CAT-M1, eFDD 12 QPSK, low channel, 1.4 MHz, 1, conducted	S01_AR11	2020-01-28	Passed	Passed
CAT-M1, eFDD 12 QPSK, low channel, 1.4 MHz, 3, conducted	S01_AR11	2020-01-28	Passed	Passed
CAT-M1, eFDD 12 QPSK, low channel, 1.4 MHz, 6, conducted	S01_AR11	2020-01-28	Passed	Passed
CAT-M1, eFDD 12 QPSK, mid channel, 1.4 MHz, 1, conducted	S01_AR11	2020-01-28	Passed	Passed
CAT-M1, eFDD 12 QPSK, mid channel, 1.4 MHz, 3, conducted	S01_AR11	2020-01-28	Passed	Passed
CAT-M1, eFDD 12 QPSK, mid channel, 1.4 MHz, 6, conducted	S01_AR11	2020-01-28	Passed	Passed
CAT-M1, eFDD 13 16QAM, high channel, 1.4 MHz, 1, conducted	S01_AR11	2020-01-28	Passed	Passed
CAT-M1, eFDD 13 16QAM, high channel, 1.4 MHz, 5, conducted	S01_AR11	2020-01-28	Passed	Passed
CAT-M1, eFDD 13 16QAM, low channel, 1.4 MHz, 1, conducted	S01_AR11	2020-01-28	Passed	Passed
CAT-M1, eFDD 13 16QAM, low channel, 1.4 MHz, 5, conducted	S01_AR11	2020-01-28	Passed	Passed
CAT-M1, eFDD 13 16QAM, mid channel, 1.4 MHz, 1, conducted	S01_AR11	2020-01-28	Passed	Passed
CAT-M1, eFDD 13 16QAM, mid channel, 1.4 MHz, 5, conducted	S01_AR11	2020-01-28	Passed	Passed
CAT-M1, eFDD 13 QPSK, high channel, 1.4 MHz, 1, conducted	S01_AR11	2020-01-28	Passed	Passed
CAT-M1, eFDD 13 QPSK, high channel, 1.4 MHz, 3, conducted	S01_AR11	2020-01-28	Passed	Passed
CAT-M1, eFDD 13 QPSK, high channel, 1.4 MHz, 6, conducted	S01_AR11	2020-01-28	Passed	Passed
CAT-M1, eFDD 13 QPSK, low channel, 1.4 MHz, 1, conducted	S01_AR11	2020-01-28	Passed	Passed
CAT-M1, eFDD 13 QPSK, low channel, 1.4 MHz, 3, conducted	S01_AR11	2020-01-28	Passed	Passed
CAT-M1, eFDD 13 QPSK, low channel, 1.4 MHz, 6, conducted	S01_AR11	2020-01-28	Passed	Passed
CAT-M1, eFDD 13 QPSK, mid channel, 1.4 MHz, 1, conducted	S01_AR11	2020-01-28	Passed	Passed
CAT-M1, eFDD 13 QPSK, mid channel, 1.4 MHz, 3, conducted	S01_AR11	2020-01-28	Passed	Passed
CAT-M1, eFDD 13 QPSK, mid channel, 1.4 MHz, 6, conducted	S01_AR11	2020-01-28	Passed	Passed
CAT-M1, eFDD 13 16QAM, high channel, 1.4 MHz, 1, conducted	S01_AR11	2020-01-28	Passed	Passed
CAT-M1, eFDD 13 16QAM, high channel, 1.4 MHz, 5, conducted	S01_AR11	2020-01-28	Passed	Passed
CAT-M1, eFDD 4 16QAM, high channel, 1.4 MHz, 1, conducted	S01_AR11	2020-01-28	Passed	Passed
CAT-M1, eFDD 4 16QAM, high channel, 1.4 MHz, 5, conducted	S01_AR11	2020-01-28	Passed	Passed
CAT-M1, eFDD 4 16QAM, low channel, 1.4 MHz, 1, conducted	S01_AR11	2020-01-28	Passed	Passed
CAT-M1, eFDD 4 16QAM, low channel, 1.4 MHz, 5, conducted	S01_AR11	2020-01-28	Passed	Passed
CAT-M1, eFDD 4 16QAM, mid channel, 1.4 MHz, 1, conducted	S01_AR11	2020-01-28	Passed	Passed
CAT-M1, eFDD 4 16QAM, mid channel, 1.4 MHz, 5, conducted	S01_AR11	2020-01-28	Passed	Passed
CAT-M1, eFDD 4 QPSK, high channel, 1.4 MHz, 1, conducted	S01_AR11	2020-01-28	Passed	Passed
CAT-M1, eFDD 4 QPSK, high channel, 1.4 MHz, 3, conducted	S01_AR11	2020-01-28	Passed	Passed
CAT-M1, eFDD 4 QPSK, high channel, 1.4 MHz, 6, conducted	S01_AR11	2020-01-28	Passed	Passed
CAT-M1, eFDD 4 QPSK, low channel, 1.4 MHz, 1, conducted	S01_AR11	2020-01-28	Passed	Passed
CAT-M1, eFDD 4 QPSK, low channel, 1.4 MHz, 3, conducted	S01_AR11	2020-01-28	Passed	Passed
CAT-M1, eFDD 4 QPSK, low channel, 1.4 MHz, 6, conducted	S01_AR11	2020-01-28	Passed	Passed
CAT-M1, eFDD 4 QPSK, mid channel, 1.4 MHz, 1, conducted	S01_AR11	2020-01-28	Passed	Passed

47 CFR CHAPTER I FCC PART 27 § 2.1046 § 27.50
Subpart C

RF Output Power
 The measurement was performed according to ANSI C63.26: 2015 **Final Result**

OP-Mode	Setup	Date	FCC	IC
Technology, Radio Technology, Operating Frequency, ChBW, Ressource Blocks, Measurement method				
CAT-M1, eFDD 4 QPSK, mid channel, 1.4 MHz, 3, conducted	S01_AR11	2020-01-28	Passed	Passed
CAT-M1, eFDD 4 QPSK, mid channel, 1.4 MHz, 6, conducted	S01_AR11	2020-01-28	Passed	Passed

47 CFR CHAPTER I FCC PART 27 § 2.1055 § 27.54
Subpart C

Frequency stability
 The measurement was performed according to ANSI C63.26: 2015 **Final Result**

OP-Mode	Setup	Date	FCC	IC
Technology, Radio Technology, Operating Frequency, ChBW, Ressource Blocks, Measurement method				
CAT-M1, eFDD 12 QPSK, mid channel, 1.4 MHz, 1, conducted	S01_AR11	2020-01-27	Passed	Passed
CAT-M1, eFDD 13 QPSK, mid channel, 1.4 MHz, 1, conducted	S01_AR11	2020-01-27	Passed	Passed
CAT-M1, eFDD 4 QPSK, mid channel, 1.4 MHz, 1, conducted	S01_AR11	2020-01-27	Passed	Passed

47 CFR CHAPTER I FCC PART 27 § 2.1051 § 27.53
Subpart C

Spurious emissions at antenna terminals
 The measurement was performed according to ANSI C63.26: 2015 **Final Result**

OP-Mode	Setup	Date	FCC	IC
Technology, Radio Technology, Operating Frequency, ChBW, Ressource Blocks, Measurement method				
CAT-M1, eFDD 12 QPSK, high channel, 1.4 MHz, 1, conducted	S01_AR11	2020-01-26	Passed	Passed
CAT-M1, eFDD 12 QPSK, low channel, 1.4 MHz, 1, conducted	S01_AR11	2020-01-26	Passed	Passed
CAT-M1, eFDD 12 QPSK, mid channel, 1.4 MHz, 1, conducted	S01_AR11	2020-01-26	Passed	Passed
CAT-M1, eFDD 13 QPSK, high channel, 1.4 MHz, 1, conducted	S01_AR11	2020-01-26	Passed	Passed
CAT-M1, eFDD 13 QPSK, low channel, 1.4 MHz, 1, conducted	S01_AR11	2020-01-26	Passed	Passed
CAT-M1, eFDD 13 QPSK, mid channel, 1.4 MHz, 1, conducted	S01_AR11	2020-01-26	Passed	Passed
CAT-M1, eFDD 4 QPSK, high channel, 1.4 MHz, 1, conducted	S01_AR11	2020-01-26	Passed	Passed
CAT-M1, eFDD 4 QPSK, low channel, 1.4 MHz, 1, conducted	S01_AR11	2020-01-26	Passed	Passed
CAT-M1, eFDD 4 QPSK, mid channel, 1.4 MHz, 1, conducted	S01_AR11	2020-01-26	Passed	Passed

47 CFR CHAPTER I FCC PART 27 § 2.1053 § 27.53
Subpart C

Field strength of spurious radiation
 The measurement was performed according to ANSI C63.26: 2015 **Final Result**

OP-Mode	Setup	Date	FCC	IC
Technology, Radio Technology, Operating Frequency, ChBW, Ressource Blocks, Measurement method				
CAT-M1, eFDD 12 QPSK, high channel, 1.4 MHz, 1, radiated	S01_AR11	2020-01-31	Passed	Passed
CAT-M1, eFDD 12 QPSK, low channel, 1.4 MHz, 1, radiated	S01_AR11	2020-01-31	Passed	Passed
CAT-M1, eFDD 12 QPSK, mid channel, 1.4 MHz, 1, radiated	S01_AR11	2020-01-31	Passed	Passed
CAT-M1, eFDD 13 QPSK, high channel, 1.4 MHz, 1, radiated	S01_AR11	2020-01-31	Passed	Passed
CAT-M1, eFDD 13 QPSK, low channel, 1.4 MHz, 1, radiated	S01_AR11	2020-01-31	Passed	Passed

47 CFR CHAPTER I FCC PART 27 § 2.1053 § 27.53
Subpart C

Field strength of spurious radiation

The measurement was performed according to ANSI C63.26: 2015

Final Result

OP-Mode	Setup	Date	FCC	IC
Technology, Radio Technology, Operating Frequency, ChBW, Ressource Blocks, Measurement method				
CAT-M1, eFDD 13 QPSK, mid channel, 1.4 MHz, 1, radiated	S01_AR11	2020-01-31	Passed	Passed
CAT-M1, eFDD 4 QPSK, high channel, 1.4 MHz, 1, radiated	S01_AR11	2020-01-31	Passed	Passed
CAT-M1, eFDD 4 QPSK, low channel, 1.4 MHz, 1, radiated	S01_AR11	2020-01-31	Passed	Passed
CAT-M1, eFDD 4 QPSK, mid channel, 1.4 MHz, 1, radiated	S01_AR11	2020-01-31	Passed	Passed

47 CFR CHAPTER I FCC PART 27 § 2.1049
Subpart C

Emission and occupied bandwidth

The measurement was performed according to ANSI C63.26: 2015

Final Result

OP-Mode	Setup	Date	FCC	IC
Technology, Radio Technology, Operating Frequency, ChBW, Ressource Blocks, Measurement method				
CAT-M1, eFDD 12 16QAM, high channel, 1.4 MHz, 5, conducted	S01_AR11	2020-01-22	Passed	Passed
CAT-M1, eFDD 12 16QAM, low channel, 1.4 MHz, 5, conducted	S01_AR11	2020-01-22	Passed	Passed
CAT-M1, eFDD 12 16QAM, mid channel, 1.4 MHz, 5, conducted	S01_AR11	2020-01-22	Passed	Passed
CAT-M1, eFDD 12 QPSK, high channel, 1.4 MHz, 6, conducted	S01_AR11	2020-01-22	Passed	Passed
CAT-M1, eFDD 12 QPSK, low channel, 1.4 MHz, 6, conducted	S01_AR11	2020-01-22	Passed	Passed
CAT-M1, eFDD 12 QPSK, mid channel, 1.4 MHz, 6, conducted	S01_AR11	2020-01-22	Passed	Passed
CAT-M1, eFDD 13 16QAM, high channel, 1.4 MHz, 5, conducted	S01_AR11	2020-01-22	Passed	Passed
CAT-M1, eFDD 13 16QAM, low channel, 1.4 MHz, 5, conducted	S01_AR11	2020-01-22	Passed	Passed
CAT-M1, eFDD 13 16QAM, mid channel, 1.4 MHz, 5, conducted	S01_AR11	2020-01-22	Passed	Passed
CAT-M1, eFDD 13 QPSK, high channel, 1.4 MHz, 6, conducted	S01_AR11	2020-01-22	Passed	Passed
CAT-M1, eFDD 13 QPSK, low channel, 1.4 MHz, 6, conducted	S01_AR11	2020-01-22	Passed	Passed
CAT-M1, eFDD 13 QPSK, mid channel, 1.4 MHz, 6, conducted	S01_AR11	2020-01-22	Passed	Passed
CAT-M1, eFDD 4 16QAM, high channel, 1.4 MHz, 5, conducted	S01_AR11	2020-01-22	Passed	Passed
CAT-M1, eFDD 4 16QAM, low channel, 1.4 MHz, 5, conducted	S01_AR11	2020-01-22	Passed	Passed
CAT-M1, eFDD 4 16QAM, mid channel, 1.4 MHz, 5, conducted	S01_AR11	2020-01-22	Passed	Passed
CAT-M1, eFDD 4 QPSK, high channel, 1.4 MHz, 6, conducted	S01_AR11	2020-01-22	Passed	Passed
CAT-M1, eFDD 4 QPSK, low channel, 1.4 MHz, 6, conducted	S01_AR11	2020-01-22	Passed	Passed
CAT-M1, eFDD 4 QPSK, mid channel, 1.4 MHz, 6, conducted	S01_AR11	2020-01-22	Passed	Passed

47 CFR CHAPTER I FCC PART 27 § 2.1051 § 27.53
Subpart C

Band edge compliance

The measurement was performed according to ANSI C63.26: 2015

Final Result

OP-Mode	Setup	Date	FCC	IC
Technology, Radio Technology, Operating Frequency, ChBW, Ressource Blocks, Measurement method				
CAT-M1, eFDD 12 16QAM, high channel, 1.4 MHz, 5, conducted	S01_AR11	2020-01-27	Passed	Passed
CAT-M1, eFDD 12 16QAM, low channel, 1.4 MHz, 5, conducted	S01_AR11	2020-01-27	Passed	Passed
CAT-M1, eFDD 12 QPSK, high channel, 1.4 MHz, 6, conducted	S01_AR11	2020-01-27	Passed	Passed
CAT-M1, eFDD 12 QPSK, low channel, 1.4 MHz, 6, conducted	S01_AR11	2020-01-27	Passed	Passed
CAT-M1, eFDD 13 16QAM, high channel, 1.4 MHz, 5, conducted	S01_AR11	2020-01-28	Passed	Passed
CAT-M1, eFDD 13 16QAM, low channel, 1.4 MHz, 5, conducted	S01_AR11	2020-01-28	Passed	Passed

47 CFR CHAPTER I FCC PART 27 § 2.1051 § 27.53
Subpart C

Band edge compliance

The measurement was performed according to ANSI C63.26: 2015

Final Result

OP-Mode	Setup	Date	FCC	IC
Technology, Radio Technology, Operating Frequency, ChBW, Ressource Blocks, Measurement method				
CAT-M1, eFDD 13 QPSK, high channel, 1.4 MHz, 6, conducted	S01_AR11	2020-01-28	Passed	Passed
CAT-M1, eFDD 13 QPSK, low channel, 1.4 MHz, 6, conducted	S01_AR11	2020-01-28	Passed	Passed
CAT-M1, eFDD 4 16QAM, high channel, 1.4 MHz, 5, conducted	S01_AR11	2020-01-27	Passed	Passed
CAT-M1, eFDD 4 16QAM, low channel, 1.4 MHz, 5, conducted	S01_AR11	2020-01-27	Passed	Passed
CAT-M1, eFDD 4 QPSK, high channel, 1.4 MHz, 6, conducted	S01_AR11	2020-01-27	Passed	Passed
CAT-M1, eFDD 4 QPSK, low channel, 1.4 MHz, 6, conducted	S01_AR11	2020-01-27	Passed	Passed

47 CFR CHAPTER I FCC PART 27 § 27.50
Subpart C

Peak to Average Ratio

The measurement was performed according to ANSI C63.26: 2015

Final Result

OP-Mode	Setup	Date	FCC	IC
Technology, Radio Technology, Operating Frequency, ChBW, Ressource Blocks, Measurement method				
CAT-M1, eFDD 12 16QAM, high channel, 1.4 MHz, 5, conducted	S01_AR11	2020-01-29	Passed	Passed
CAT-M1, eFDD 12 16QAM, low channel, 1.4 MHz, 5, conducted	S01_AR11	2020-01-29	Passed	Passed
CAT-M1, eFDD 12 16QAM, mid channel, 1.4 MHz, 5, conducted	S01_AR11	2020-01-29	Passed	Passed
CAT-M1, eFDD 12 QPSK, high channel, 1.4 MHz, 6, conducted	S01_AR11	2020-01-29	Passed	Passed
CAT-M1, eFDD 12 QPSK, low channel, 1.4 MHz, 6, conducted	S01_AR11	2020-01-29	Passed	Passed
CAT-M1, eFDD 12 QPSK, mid channel, 1.4 MHz, 6, conducted	S01_AR11	2020-01-29	Passed	Passed
CAT-M1, eFDD 13 16QAM, high channel, 1.4 MHz, 5, conducted	S01_AR11	2020-01-29	Passed	Passed
CAT-M1, eFDD 13 16QAM, low channel, 1.4 MHz, 5, conducted	S01_AR11	2020-01-29	Passed	Passed
CAT-M1, eFDD 13 16QAM, mid channel, 1.4 MHz, 5, conducted	S01_AR11	2020-01-29	Passed	Passed
CAT-M1, eFDD 13 QPSK, high channel, 1.4 MHz, 6, conducted	S01_AR11	2020-01-29	Passed	Passed
CAT-M1, eFDD 13 QPSK, low channel, 1.4 MHz, 6, conducted	S01_AR11	2020-01-29	Passed	Passed
CAT-M1, eFDD 13 QPSK, mid channel, 1.4 MHz, 6, conducted	S01_AR11	2020-01-29	Passed	Passed
CAT-M1, eFDD 4 16QAM, high channel, 1.4 MHz, 5, conducted	S01_AR11	2020-01-29	Passed	Passed
CAT-M1, eFDD 4 16QAM, low channel, 1.4 MHz, 5, conducted	S01_AR11	2020-01-29	Passed	Passed
CAT-M1, eFDD 4 16QAM, mid channel, 1.4 MHz, 5, conducted	S01_AR11	2020-01-29	Passed	Passed
CAT-M1, eFDD 4 QPSK, high channel, 1.4 MHz, 6, conducted	S01_AR11	2020-01-29	Passed	Passed
CAT-M1, eFDD 4 QPSK, low channel, 1.4 MHz, 6, conducted	S01_AR11	2020-01-29	Passed	Passed
CAT-M1, eFDD 4 QPSK, mid channel, 1.4 MHz, 6, conducted	S01_AR11	2020-01-29	Passed	Passed

47 CFR CHAPTER I FCC PART 90 § 2.1046 § 90.635
Subpart S

RF Output Power

The measurement was performed according to ANSI C63.26: 2015

Final Result

OP-Mode	Setup	Date	FCC	IC
Technology, Radio Technology, Operating Frequency, ChBW, Ressource Blocks, Measurement method				
CAT-M1, eFDD 26 16QAM, high channel, 1.4 MHz, 1, conducted	S01_AR11	2020-01-31	Passed	Passed
CAT-M1, eFDD 26 16QAM, high channel, 1.4 MHz, 5, conducted	S01_AR11	2020-01-31	Passed	Passed
CAT-M1, eFDD 26 16QAM, low channel, 1.4 MHz, 1, conducted	S01_AR11	2020-01-31	Passed	Passed
CAT-M1, eFDD 26 16QAM, low channel, 1.4 MHz, 5, conducted	S01_AR11	2020-01-31	Passed	Passed

47 CFR CHAPTER I FCC PART 90 § 2.1046 § 90.635
Subpart S

RF Output Power

The measurement was performed according to ANSI C63.26: 2015

Final Result

OP-Mode	Setup	Date	FCC	IC
Technology, Radio Technology, Operating Frequency, ChBW, Ressource Blocks, Measurement method				
CAT-M1, eFDD 26 16QAM, mid channel, 1.4 MHz, 1, conducted	S01_AR11	2020-01-31	Passed	Passed
CAT-M1, eFDD 26 16QAM, mid channel, 1.4 MHz, 5, conducted	S01_AR11	2020-01-31	Passed	Passed
CAT-M1, eFDD 26 QPSK, high channel, 1.4 MHz, 1, conducted	S01_AR11	2020-01-31	Passed	Passed
CAT-M1, eFDD 26 QPSK, high channel, 1.4 MHz, 3, conducted	S01_AR11	2020-01-31	Passed	Passed
CAT-M1, eFDD 26 QPSK, high channel, 1.4 MHz, 6, conducted	S01_AR11	2020-01-31	Passed	Passed
CAT-M1, eFDD 26 QPSK, low channel, 1.4 MHz, 1, conducted	S01_AR11	2020-01-31	Passed	Passed
CAT-M1, eFDD 26 QPSK, low channel, 1.4 MHz, 3, conducted	S01_AR11	2020-01-31	Passed	Passed
CAT-M1, eFDD 26 QPSK, low channel, 1.4 MHz, 6, conducted	S01_AR11	2020-01-31	Passed	Passed
CAT-M1, eFDD 26 QPSK, mid channel, 1.4 MHz, 1, conducted	S01_AR11	2020-01-31	Passed	Passed
CAT-M1, eFDD 26 QPSK, mid channel, 1.4 MHz, 3, conducted	S01_AR11	2020-01-31	Passed	Passed
CAT-M1, eFDD 26 QPSK, mid channel, 1.4 MHz, 6, conducted	S01_AR11	2020-01-31	Passed	Passed

47 CFR CHAPTER I FCC PART 90 § 2.1055 § 90.539
Subpart S

Frequency Stability

The measurement was performed according to ANSI C63.26: 2015

Final Result

OP-Mode	Setup	Date	FCC	IC
Technology, Radio Technology, Operating Frequency, ChBW, Ressource Blocks, Measurement method				
CAT-M1, eFDD 26 QPSK, mid channel, 1.4 MHz, 1, conducted	S01_AR11	2020-01-27	Passed	Passed

47 CFR CHAPTER I FCC PART 90 § 2.1051 § 90.543
Subpart S

Spurious Emissions at antenna terminals

The measurement was performed according to ANSI C63.26: 2015

Final Result

OP-Mode	Setup	Date	FCC	IC
Technology, Radio Technology, Operating Frequency, ChBW, Ressource Blocks, Measurement method				
CAT-M1, eFDD 26 QPSK, high channel, 1.4 MHz, 1, conducted	S01_AR11	2020-01-31	Passed	Passed
CAT-M1, eFDD 26 QPSK, low channel, 1.4 MHz, 1, conducted	S01_AR11	2020-01-31	Passed	Passed
CAT-M1, eFDD 26 QPSK, mid channel, 1.4 MHz, 1, conducted	S01_AR11	2020-01-31	Passed	Passed

47 CFR CHAPTER I FCC PART 90 § 2.1049
Subpart S

Emission and Occupied Bandwidth

The measurement was performed according to ANSI C63.26: 2015

Final Result

OP-Mode	Setup	Date	FCC	IC
Technology, Radio Technology, Operating Frequency, ChBW, Ressource Blocks, Measurement method				
CAT-M1, eFDD 26 16QAM, high channel, 1.4 MHz, 5, conducted	S01_AR11	2020-01-22	Passed	Passed
CAT-M1, eFDD 26 16QAM, low channel, 1.4 MHz, 5, conducted	S01_AR11	2020-01-22	Passed	Passed
CAT-M1, eFDD 26 16QAM, mid channel, 1.4 MHz, 5, conducted	S01_AR11	2020-01-22	Passed	Passed
CAT-M1, eFDD 26 QPSK, high channel, 1.4 MHz, 6, conducted	S01_AR11	2020-01-22	Passed	Passed

47 CFR CHAPTER I FCC PART 90 § 2.1049
Subpart S

Emission and Occupied Bandwidth

The measurement was performed according to ANSI C63.26: 2015

Final Result

OP-Mode	Setup	Date	FCC	IC
Technology, Radio Technology, Operating Frequency, ChBW, Ressource Blocks, Measurement method				
CAT-M1, eFDD 26 QPSK, low channel, 1.4 MHz, 6, conducted	S01_AR11	2020-01-22	Passed	Passed
CAT-M1, eFDD 26 QPSK, mid channel, 1.4 MHz, 6, conducted	S01_AR11	2020-01-22	Passed	Passed

47 CFR CHAPTER I FCC PART 90 § 90.635
Subpart S

Peak to Average Ratio

The measurement was performed according to ANSI C63.26: 2015

Final Result

OP-Mode	Setup	Date	FCC	IC
Technology, Radio Technology, Operating Frequency, ChBW, Ressource Blocks, Measurement method				
CAT-M1, eFDD 26 16QAM, high channel, 1.4 MHz, 5, conducted	S01_AR11	2020-01-29	Passed	Passed
CAT-M1, eFDD 26 16QAM, low channel, 1.4 MHz, 5, conducted	S01_AR11	2020-01-29	Passed	Passed
CAT-M1, eFDD 26 16QAM, mid channel, 1.4 MHz, 5, conducted	S01_AR11	2020-01-29	Passed	Passed
CAT-M1, eFDD 26 QPSK, high channel, 1.4 MHz, 6, conducted	S01_AR11	2020-01-29	Passed	Passed
CAT-M1, eFDD 26 QPSK, low channel, 1.4 MHz, 6, conducted	S01_AR11	2020-01-29	Passed	Passed
CAT-M1, eFDD 26 QPSK, mid channel, 1.4 MHz, 6, conducted	S01_AR11	2020-01-29	Passed	Passed

N/A: Not applicable

N/P: Not performed

2 REVISION HISTORY

Report version control			
Version	Release date	Change Description	Version validity
initial	2020-02-13	--	invalid
rev01	2020-02-25	Corrected RSS reference	valid

COMMENT: -

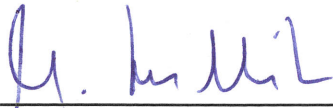

(responsible for accreditation scope)
Dipl.-Ing. Marco Kullik

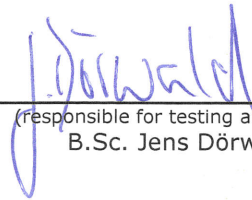

(responsible for testing and report)
B.Sc. Jens Dörwald



7 layers GmbH, Borsigstr. 11
40880 Ratingen, Germany
Phone +49 (0)2102 749 0

3 ADMINISTRATIVE DATA

3.1 TESTING LABORATORY

Company Name: 7layers GmbH
Address: Borsigstr. 11
40880 Ratingen
Germany

The test facility is accredited by the following accreditation organisation:

Laboratory accreditation no: DAkkS D-PL-12140-01-01 | D-PL-12140-01-02 | D-PL-12140-01-03
FCC Designation Number: DE0015
FCC Test Firm Registration: 929146
ISED CAB Identifier: DE0007; ISED#: 3699A
Responsible for accreditation scope: Dipl.-Ing. Marco Kullik
Report Template Version: 2019-12-16

3.2 PROJECT DATA

Responsible for testing and report: B.Sc. Jens Dörwald
Employees who performed the tests: documented internally at 7Layers
Date of Report: 2020-02-25
Testing Period: 2020-01-21 to 2020-01-31

3.3 APPLICANT DATA

Company Name: u-blox AG
Address: Zürcherstrasse 68
8800 Thalwil
Switzerland
Contact Person: Mr. Giulio Comar

3.4 MANUFACTURER DATA

Company Name: please see Applicant Data
Address:
Contact Person:

4 TEST OBJECT DATA

4.1 GENERAL EUT DESCRIPTION

Kind of Device product description	LTE CAT-M1 module.
Product name	SARA-R510M8S
Type	-
Declared EUT data by the supplier	
Power Supply Type	DC
General product description	The EUT is LTE CAT-M1 module. It supports the relevant bands for FCC Approval LTE CAT-M1: eFDD2 / LTE eFDD4 / eFDD5 / eFDD12 / eFDD13 / eFDD25 /eFDD26
Nominal Voltage / Frequency	3.8 V DC

4.2 EUT MAIN COMPONENTS

Sample Name	Sample Code	Description
ar11	ar11	radiated & conducted sample
Sample Parameter	Value	
Serial No.	357862090047590	
HW Version	352D00	
SW Version	00.11	
Comment	-	

NOTE: The short description is used to simplify the identification of the EUT in this test report.

4.3 ANCILLARY EQUIPMENT

For the purposes of this test report, ancillary equipment is defined as equipment which is used in conjunction with the EUT to provide operational and control features to the EUT. It is necessary to configure the system in a typical fashion, as a customer would normally use it. But nevertheless Ancillary Equipment can influence the test results.

Device	Details (Manufacturer, Type Model, OUT Code)	Description
-	-	-

4.4 AUXILIARY EQUIPMENT

For the purposes of this test report, auxiliary equipment is defined as equipment which is used temporarily to enable operational and control features especially used for the tests of the EUT

which is not used during normal operation or equipment that is used during the tests in combination with the EUT but is not subject of this test report. It is necessary to configure the system in a typical fashion, as a customer would normally use it. But nevertheless Auxiliary Equipment can influence the test results.

Device	Details (Manufacturer, Type Model, HW, SW, S/N)	Description
Antenna	-	-

4.5 EUT SETUPS

This chapter describes the combination of EUTs and equipment used for testing. The rationale for selecting the EUTs, ancillary and auxiliary equipment and interconnecting cables, is to test a representative configuration meeting the requirements of the referenced standards.

Setup	Combination of EUTs	Description and Rationale
S01_AR11	ar11	radiated & conducted sample

4.6 OPERATING MODES

This chapter describes the operating modes of the EUTs used for testing.

4.6.1 TEST CHANNELS

FCC Part 24

LTE CAT-M1 eFDD 2	LOW	MID	HIGH
Channel	18607	18900	19193
Frequency [MHz]	1850.7	1880	1909.3

FCC Part 27

LTE CAT-M1 eFDD 4	LOW	MID	HIGH
Channel	19957	20175	20393
Frequency [MHz]	1710.7	1732.5	1754.3

FCC Part 22

LTE CAT-M1 eFDD 5	LOW	MID	HIGH
Channel	20407	20525	20643
Frequency [MHz]	824.7	836.5	848.3

FCC Part 27

LTE CAT-M1 eFDD 12	LOW	MID	HIGH
Channel	23017	23095	23173
Frequency [MHz]	699.7	707.5	715.3

FCC Part 27

LTE CAT-M1 eFDD 13	LOW	MID	HIGH
Channel	23205	23230	23255
Frequency [MHz]	777.7	780.3	786.3

FCC Part 24

LTE CAT-M1 eFDD 25	LOW	MID	HIGH
Channel	26047	26365	26683
Frequency [MHz]	1850.7	1882.5	1914.3

FCC Part 22

LTE CAT-M1 eFDD 26	LOW	MID	HIGH
Channel	26797	26915	27033
Frequency [MHz]	824.7	836.5	848.3

FCC Part 90

LTE CAT-M1 eFDD26	LOW	MID	HIGH
Channel	26697	26740	26783
Frequency [MHz]	814.7	819	823.3

4.7 PRODUCT LABELLING

4.7.1 FCC ID LABEL

Please refer to the documentation of the applicant.

4.7.2 LOCATION OF THE LABEL ON THE EUT

Please refer to the documentation of the applicant.

5 TEST RESULTS

5.1 RF OUTPUT POWER

Standard **FCC PART 22 Subpart H**

The test was performed according to:
ANSI C63.26: 2015

5.1.1 TEST DESCRIPTION

This test case is intended to demonstrate compliance to the applicable RF Output power test case per § 2.1046 and RSS-GEN 6.12. The limit and the requirements come from the applicable rule part and ISED RSS-Standard for the operating band of the cellular device.

The EUT was connected to the test setup according to the following diagram:

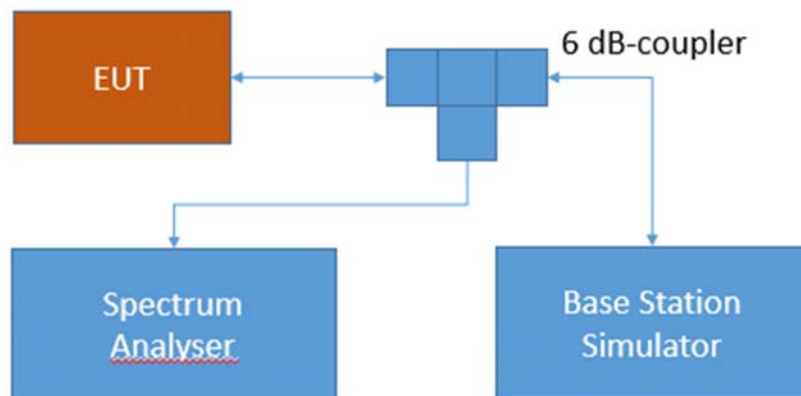

Test Setup FCC Part 22/24/27/90 Cellular;
RF Output power

The attenuation of the measuring and stimulus path are known for each measured frequency and are considered.

The Spectrum Analyser settings can be directly found in the measurement diagrams.

5.1.2 TEST REQUIREMENTS / LIMITS

FCC Part 22, § 22.913

(a) *Maximum ERP.* The ERP of transmitters in the Cellular Radiotelephone Service must not exceed the limits in this section.

(5) The ERP of mobile transmitters and auxiliary test transmitters must not exceed 7 watts.

RSS-132; 5.4 Transmitter Output Power and Equivalent Isotropically Radiated Power

The transmitter output power shall be measured in terms of average power. The equivalent isotropically radiated power (e.i.r.p.) for mobile equipment shall not exceed 11.5 watts.

5.1.3 TEST PROTOCOL

Temperature 22 °C

Humidity 36 %

Radio Technology	Channel	Ressource Blocks / Subcarrier	Band-width [MHz]	RMS Cond. Power [dBm]	FCC EIRP Limit [W]	IC EIRP Limit [W]	Max. Antenna Gain FCC [dBi]	Max. Antenna Gain IC [dBi]
CAT-M1 eFDD 5 QPSK	low	1	1.4	23.00	11.5	11.5	17.6	17.6
CAT-M1 eFDD 5 QPSK	low	3	1.4	21.88	11.5	11.5	18.72	18.72
CAT-M1 eFDD 5 QPSK	low	6	1.4	20.84	11.5	11.5	19.76	19.76
CAT-M1 eFDD 5 QPSK	mid	1	1.4	22.81	11.5	11.5	17.79	17.79
CAT-M1 eFDD 5 QPSK	mid	3	1.4	21.83	11.5	11.5	18.77	18.77
CAT-M1 eFDD 5 QPSK	mid	6	1.4	20.93	11.5	11.5	19.67	19.67
CAT-M1 eFDD 5 QPSK	high	1	1.4	22.81	11.5	11.5	17.79	17.79
CAT-M1 eFDD 5 QPSK	high	3	1.4	21.85	11.5	11.5	18.75	18.75
CAT-M1 eFDD 5 QPSK	high	6	1.4	20.85	11.5	11.5	19.75	19.75
CAT-M1 eFDD 5 16QAM	low	1	1.4	21.63	11.5	11.5	18.97	18.97
CAT-M1 eFDD 5 16QAM	low	5	1.4	21.02	11.5	11.5	19.58	19.58
CAT-M1 eFDD 5 16QAM	mid	1	1.4	21.52	11.5	11.5	19.08	19.08
CAT-M1 eFDD 5 16QAM	mid	5	1.4	21.13	11.5	11.5	19.47	19.47
CAT-M1 eFDD 5 16QAM	high	1	1.4	21.72	11.5	11.5	18.88	18.88
CAT-M1 eFDD 5 16QAM	high	5	1.4	21.08	11.5	11.5	19.52	19.52
CAT-M1 eFDD 26 QPSK	low	1	1.4	22.57	11.5	11.5	18.03	18.03
CAT-M1 eFDD 26 QPSK	low	3	1.4	21.45	11.5	11.5	19.15	19.15
CAT-M1 eFDD 26 QPSK	low	6	1.4	20.38	11.5	11.5	20.22	20.22
CAT-M1 eFDD 26 QPSK	mid	1	1.4	22.36	11.5	11.5	18.24	18.24
CAT-M1 eFDD 26 QPSK	mid	3	1.4	21.39	11.5	11.5	19.21	19.21
CAT-M1 eFDD 26 QPSK	mid	6	1.4	20.49	11.5	11.5	20.11	20.11
CAT-M1 eFDD 26 QPSK	high	1	1.4	22.37	11.5	11.5	18.23	18.23
CAT-M1 eFDD 26 QPSK	high	3	1.4	21.40	11.5	11.5	19.2	19.2
CAT-M1 eFDD 26 QPSK	high	6	1.4	20.41	11.5	11.5	20.19	20.19
CAT-M1 eFDD 26 16QAM	low	1	1.4	21.26	11.5	11.5	19.34	19.34
CAT-M1 eFDD 26 16QAM	low	5	1.4	20.60	11.5	11.5	20	20
CAT-M1 eFDD 26 16QAM	mid	1	1.4	21.01	11.5	11.5	19.59	19.59
CAT-M1 eFDD 26 16QAM	mid	5	1.4	20.73	11.5	11.5	19.87	19.87
CAT-M1 eFDD 26 16QAM	high	1	1.4	21.14	11.5	11.5	19.46	19.46
CAT-M1 eFDD 26 16QAM	high	5	1.4	20.64	11.5	11.5	19.96	19.96

Remark: Please see next sub-clause for the measurement plot.

5.1.4 MEASUREMENT PLOT (SHOWING THE HIGHEST VALUE, "WORST CASE")
CAT-M1 eFDD 5 QPSK, RB=1, Channel = low

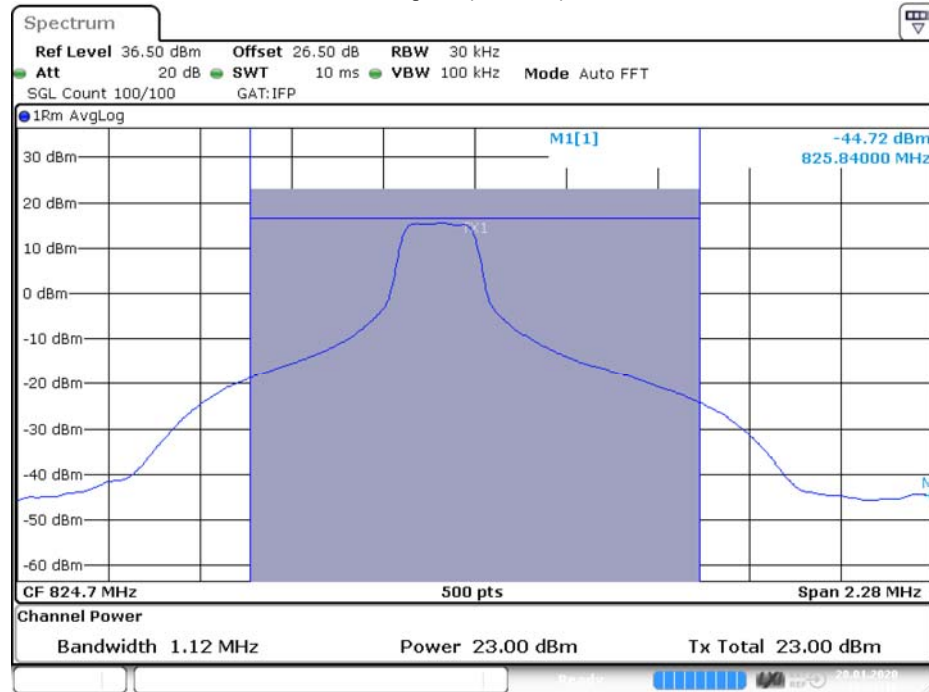

Date: 28. JAN. 2020 13:08:17

5.1.5 TEST EQUIPMENT USED

- Radio Lab

5.2 FREQUENCY STABILITY

Standard **FCC PART 22 Subpart H**

The test was performed according to:
ANSI C63.26: 2015

5.2.1 TEST DESCRIPTION

This test case is intended to demonstrate compliance to the applicable frequency stability test case per § 2.1055 and RSS-GEN 6.11. The limit and the requirements come from the applicable rule part and ISED RSS-Standard for the operating band of the cellular device.

The EUT was connected to the test setup according to the following diagram:



Test Setup FCC Part 22/24/27/90 Cellular;
Frequency stability

The attenuation of the measuring / stimulus path is known for each measured frequency and are considered.

5.2.2 TEST REQUIREMENTS / LIMITS

FCC Part 22, § 22.355

Except as otherwise provided in this part, the carrier frequency of each transmitter in the Public Mobile Services must be maintained within the tolerances given in Table C-1 of this section.

Table C-1—Frequency Tolerance for Transmitters in the Public Mobile Services

Frequency Range [MHz]	Mobile Devices > 3 W [ppm]	Mobile Devices ≤ 3 W [ppm]
25 – 50	20.0	50.0
50 – 450	5.0	50.0
450 – 512	5.0	5.0
821 – 896	2.5	2.5
928 - 929	n/a	n/a
929 – 960	n/a	n/a
2110 - 2220	n/a	n/a

RSS-132; 5.3 Frequency Stability

The carrier frequency shall not depart from the reference frequency in excess of ± 2.5 ppm for mobile stations.

In lieu of meeting the above stability values, the test report may show that the frequency stability is sufficient to ensure that the occupied bandwidth stays within each of the sub-bands (see Section 5.1) when tested to the temperature and supply voltage variations specified in RSS-Gen.

5.2.3 TEST PROTOCOL

CAT-M1 eFDD 5 QPSK, RB=6, Channel = mid

Temp. °C	Duration min	Voltage	Limit Hz	Freq. error Average (Hz)	Freq. error Max. (Hz)	Verdict
-30	0	normal	2091.25	-2	-6	passed
-30	5			5	11	passed
-30	10			3	8	passed
-20	0	normal	2091.25	10	14	passed
-20	5			11	16	passed
-20	10			7	11	passed
-10	0	normal	2091.25	10	16	passed
-10	5			13	19	passed
-10	10			-4	-11	passed
0	0	normal	2091.25	-1	-7	passed
0	5			4	8	passed
0	10			5	9	passed
10	0	normal	2091.25	-4	-10	passed
10	5			6	11	passed
10	10			5	10	passed
20	0	low	2091.25	1	6	passed
20	5			-3	-8	passed
20	10			-4	-7	passed
20	0	normal	2091.25	-1	-7	passed
20	5			1	5	passed
20	10			-5	-9	passed
20	0	high	2091.25	-2	-6	passed
20	5			-3	-8	passed
20	10			-4	-9	passed
30	0	normal	2091.25	7	10	passed
30	5			6	9	passed
30	10			10	13	passed
40	0	normal	2091.25	-6	-9	passed
40	5			-4	-7	passed
40	10			2	6	passed
50	0	normal	2091.25	-2	-9	passed
50	5			4	14	passed
50	10			-1	-11	passed

Remark: Please see next sub-clause for the measurement plot.

COMMENT:

For eFDD26 the test "Frequency Stability" was performed on Channel 26740 (819 MHz) which is covered by Part 90.

5.2.4 TEST EQUIPMENT USED

- Radio Lab

5.3 SPURIOUS EMISSIONS AT ANTENNA TERMINALS

Standard **FCC PART 22 Subpart H**

The test was performed according to:
ANSI C63.26: 2015

5.3.1 TEST DESCRIPTION

This test case is intended to demonstrate compliance to the applicable conducted spurious emission test case per § 2.1051 and RSS-GEN 6.13. The limit comes from the applicable rule part and ISED RSS-Standard for the operating band of the cellular device.

The EUT was connected to the test setup according to the following diagram:

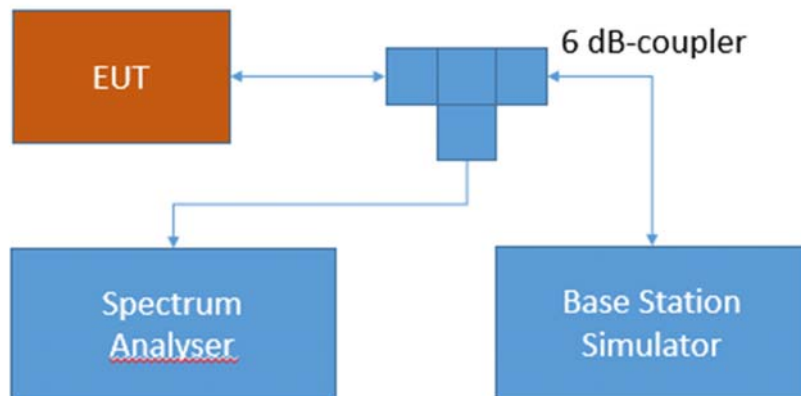

Test Setup FCC Part 22/24/27/90 Cellular;
Spurious Emissions at antenna terminal

The attenuation of the measuring and stimulus path are known for each measured frequency and are considered.

The Spectrum Analyser settings can be directly found in the measurement diagrams.

5.3.2 TEST REQUIREMENTS / LIMITS

FCC Part 2.1051; Measurement required: Spurious emissions at antenna terminal:

The radio frequency voltage or powers generated within the equipment and appearing on a spurious frequency shall be checked at the equipment output terminals when properly loaded with a suitable artificial antenna. Curves or equivalent data shall show the magnitude of each harmonic and other spurious emission that can be detected when the equipment is operated under the conditions specified in §2.1049 as appropriate. The magnitude of spurious emissions which are attenuated more than 20 dB below the permissible value need not be specified.

Part 22, Subpart H – Cellular Radiotelephone Service

§22 917 – Emission limitations for cellular equipment

(a) *Out of band emissions.* The power of any emission outside of the authorized operating frequency ranges must be attenuated below the transmitting power (P) by a factor of at least $43 + 10 \log(P)$ dB.

RSS-132; 5.5 Transmitter Unwanted Emissions

Mobile and base station equipment shall comply with the limits in (i) and (ii) below.

1. In the first 1.0 MHz band immediately outside and adjacent to each of the sub-bands specified in Section 5.1, the power of emissions per any 1% of the occupied bandwidth shall be attenuated (in dB) below the transmitter output power P (dBW) by at least $43 + 10 \log_{10} p$ (watts).
2. After the first 1.0 MHz immediately outside and adjacent to each of the sub-bands, the power of emissions in any 100 kHz bandwidth shall be attenuated (in dB) below the transmitter output power P (dBW) by at least $43 + 10 \log_{10} p$ (watts). If the measurement is performed using 1% of the occupied bandwidth, power integration over 100 kHz is required.

5.3.3 TEST PROTOCOL

Ambient temperature: 24 °C
Relative humidity: 38 %

Radio Technology	Channel	Detector	Trace	Resolution Bandwidth /kHz	Frequency /MHz	Peak Value /dBm	Limit /dBm	Margin to Limit /dB
CAT-M1 eFDD5	low	rms	maxhold	5	823.9	-26.42	-17.5	8.92
CAT-M1 eFDD5	mid	rms	maxhold	-	-	-	-13	>20
CAT-M1 eFDD5	high	rms	maxhold	-	-	-	-13	>20

Radio Technology	Channel	Detector	Trace	Resolution Bandwidth /kHz	Frequency /MHz	Peak Value /dBm	Limit /dBm	Margin to Limit /dB
CAT-M1 eFDD26	low	rms	maxhold	5	823.9	-25.06	-17.5	7.56
CAT-M1 eFDD26	mid	rms	maxhold	-	-	-	-13	>20
CAT-M1 eFDD26	high	rms	maxhold	-	-	-	-13	>20

Remark: Please see next sub-clause for the measurement plot.

5.3.4 MEASUREMENT PLOT (SHOWING THE HIGHEST VALUE, "WORST CASE")
CAT-M1 eFDD 26 QPSK, RB=1, Channel = low

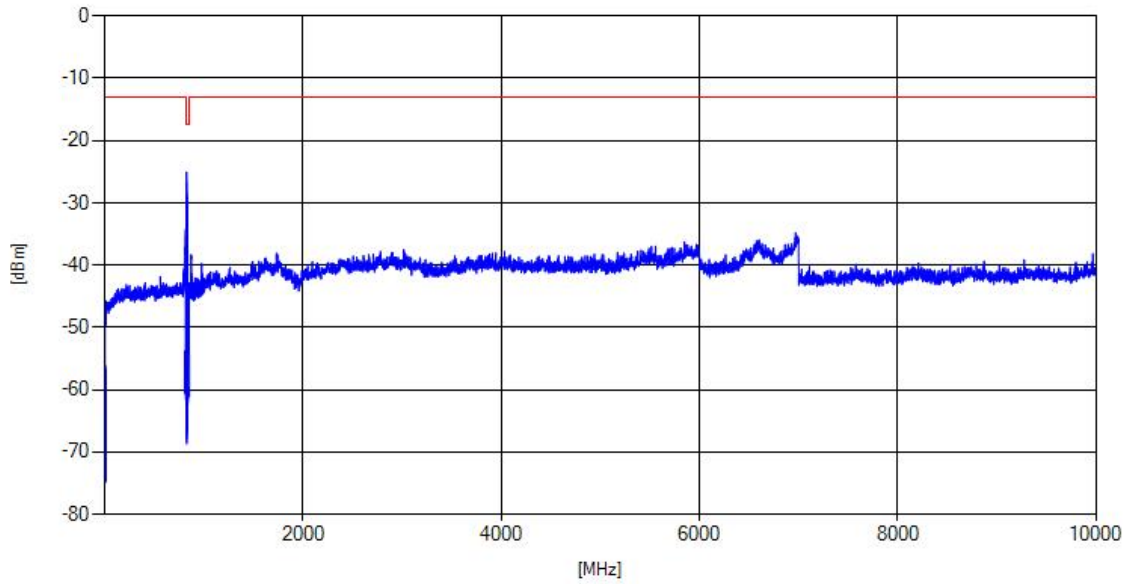

5.3.5 TEST EQUIPMENT USED

- Radio Lab

5.4 FIELD STRENGTH OF SPURIOUS RADIATION

Standard **FCC PART 22 Subpart H**

The test was performed according to:
ANSI C63.26: 2015

5.4.1 TEST DESCRIPTION

This test case is intended to demonstrate compliance to the applicable radiated spurious emission measurements per § 2.1053 and RSS-GEN 6.13. The limit and requirements come from the applicable rule part and ISSED RSS-Standard for the operating band of the cellular device.

The EUT was connected to the test setup according to the following diagram:

Frequency Range: 30 MHz – 1 GHz:

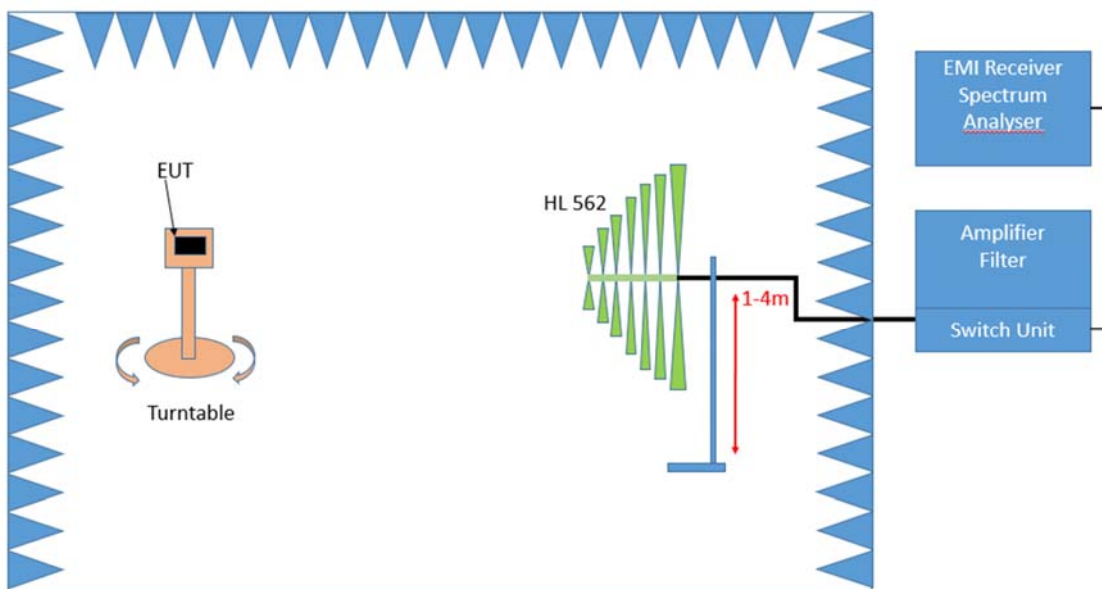

Test Setup; Spurious Emission Radiated (SAC), 30 MHz- 1GHz

Frequency Range: 1 GHz – 26.5 GHz

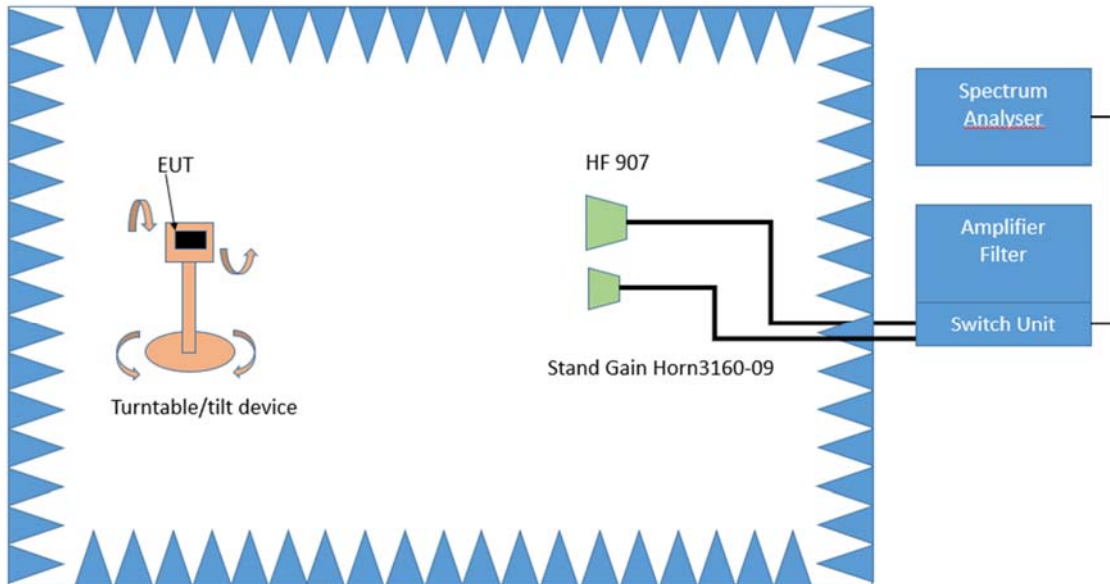

Test Setup; Spurious Emission Radiated (FAC), 1 GHz-26.5 GHz

The test set-up was made in accordance to the general provisions of ANSI C63.26 in a typical installation configuration. The Equipment Under Test (EUT) was set up on a non-conductive table 1.0 x 2.0 m² in the semi-anechoic chamber. The influence of the EUT support table that is used between 30–1000 MHz was evaluated.

The measurement procedure is implemented into the EMI test software EMC32 from R&S.

Exploratory tests are performed at 3 orthogonal axes to determine the worst-case orientation of a body-worn or handheld EUT. The final test on all kind of EUTs is also performed at 3 axes. A pre-check is performed while the EUT is powered from a DC power source.

1. Measurement above 30 MHz and up to 1 GHz

Step 1: Preliminary scan

This is a preliminary test to identify the highest amplitudes relative to the limit.

Settings for step 1:

- Antenna distance: 3 m
- Detector: Peak
- RBW: 100 kHz
- VBW: 300 kHz
- Sweep time: coupled
- Turntable angle range: -180° to 90°
- Turntable step size: 90°
- Height variation range: 1 – 3 m
- Height variation step size: 2 m
- Polarisation: Horizontal + Vertical

Intention of this step is, to determine the radiated EMI-profile of the EUT. Afterwards the relevant emissions for the final measurement are identified.

Step 2: Adjustment measurement

In this step the accuracy of the turntable azimuth and antenna height will be improved. This is necessary to find out the maximum value of every frequency.

For each frequency, which was determined the turntable azimuth and antenna height will be adjusted. The turntable azimuth will slowly vary by $\pm 45^\circ$ around this value. During this action, the value of emission is continuously measured. The turntable azimuth at the highest emission

will be recorded and adjusted. In this position, the antenna height will also slowly vary by ± 100 cm around the antenna height determined. During this action, the value of emission is also continuously measured. The antenna height of the highest emission will also be recorded and adjusted.

- Detector: Peak
- Measured frequencies: in step 1 determined frequencies
- RBW: 100 kHz
- VBW: 300 kHz
- Sweep time: coupled
- Turntable angle range: $\pm 45^\circ$ around the determined value
- Height variation range: ± 100 cm around the determined value
- Antenna Polarisation: max. value determined in step 1

Step 3: Final measurement with RMS detector

With the settings determined in step 3, the final measurement will be performed:

EMI receiver settings for step 4:

- Detector: RMQ
- Measured frequencies: in step 1 determined frequencies
- RBW: 100 kHz
- VBW: 300 kHz
- Sweep time: 1 s

After the measurement a plot will be generated which contains a diagram with the results of the preliminary scan and a chart with the frequencies and values of the results of the final measurement.

3. Measurement above 1 GHz

The following modifications apply to the measurement procedure for the frequency range above 1 GHz:

Step 1:

The Equipment Under Test (EUT) was set up on a non-conductive support (tilt device) at 1.5 m height in the fully-anechoic chamber.

All steps were performed with one height (1.5 m) of the receiving antenna only.

The EUT is turned during the preliminary measurement across the elevation axis, with a step size of 45° .

The turn table step size (azimuth angle) for the preliminary measurement is 45° .

- Antenna distance: 3 m
- Detector: Peak
- RBW: 1 MHz
- VBW: 3 MHz
- Sweep time: coupled
- Turntable angle range: -180° to 135°
- Turntable step size: 45°
- Polarisation: Horizontal + Vertical

Step 2:

Due to the fact, that in this frequency range the test is performed in a fully anechoic room, the height scan of the receiving antenna instep 2 is omitted. Instead of this, a maximum search with a step size $\pm 45^\circ$ for the elevation axis is performed.

The turn table azimuth will slowly vary by $\pm 22.5^\circ$.

The elevation angle will slowly vary by $\pm 45^\circ$

EMI receiver settings (for all steps):

- Detector: Peak,
- RBW: 1 MHz
- VBW: 3 MHz

- Sweep time: coupled

Step 3:

Spectrum analyser settings for step 3:

- Detector: RMS
- Measured frequencies: in step 1 determined frequencies
- RBW: 1 MHz
- VBW: 3 MHz
- Sweep Time: 1 s

5.4.2 TEST REQUIREMENTS / LIMITS

FCC Part 2.1053; Measurement required: Field strength of spurious radiation:

Measurements shall be made to detect spurious emissions that may be radiated directly from the cabinet, control circuits, power leads, or intermediate circuit elements under normal conditions of installation and operation. Curves or equivalent data shall be supplied showing the magnitude of each harmonic and other spurious emission. For this test, single sideband, independent sideband, and controlled carrier transmitters shall be modulated under the conditions specified in paragraph (c) of §2.1049, as appropriate.

Part 22, Subpart H – Cellular Radiotelephone Service

§ 22.917 – Emission limitations for cellular equipment

(a) *Out of band emissions.* The power of any emission outside of the authorized operating frequency ranges must be attenuated below the transmitting power (P) by a factor of at least $43 + 10 \log(P)$ dB.

RSS-132; 5.5 Transmitter Unwanted Emissions

Mobile and base station equipment shall comply with the limits in (i) and (ii) below.

1. In the first 1.0 MHz band immediately outside and adjacent to each of the sub-bands specified in Section 5.1, the power of emissions per any 1% of the occupied bandwidth shall be attenuated (in dB) below the transmitter output power P (dBW) by at least $43 + 10 \log_{10} p$ (watts).
2. After the first 1.0 MHz immediately outside and adjacent to each of the sub-bands, the power of emissions in any 100 kHz bandwidth shall be attenuated (in dB) below the transmitter output power P (dBW) by at least $43 + 10 \log_{10} p$ (watts). If the measurement is performed using 1% of the occupied bandwidth, power integration over 100 kHz is required.

5.4.3 TEST PROTOCOL

Ambient temperature: 22 °C
Relative humidity: 35 %

Radio Technology	Channel	Detector	Trace	Resolution Bandwidth /kHz	Frequency /MHz	Peak Value /dBm	Limit /dBm	Margin to Limit /dB
CAT-M1 eFDD5	low	rms	maxhold	50	823.9	-29.61	-13	16.61
CAT-M1 eFDD5	mid	rms	maxhold	-	-	-	-13	>20
CAT-M1 eFDD5	high	rms	maxhold	-	-	-	-13	>20

Radio Technology	Channel	Detector	Trace	Resolution Bandwidth /kHz	Frequency /MHz	Peak Value /dBm	Limit /dBm	Margin to Limit /dB
CAT-M1 eFDD26	low	rms	maxhold	50	824	-29.3	-13	16.3
CAT-M1 eFDD26	mid	rms	maxhold	-	-	-	-13	>20
CAT-M1 eFDD26	high	rms	maxhold	-	-	-	-13	>20

Remark: Please see next sub-clause for the measurement plot.

5.4.4 MEASUREMENT PLOT (SHOWING THE HIGHEST VALUE, "WORST CASE") CAT-M1 eFDD 26 QPSK, RB=1, Channel = low 30 MHz – 1 GHz

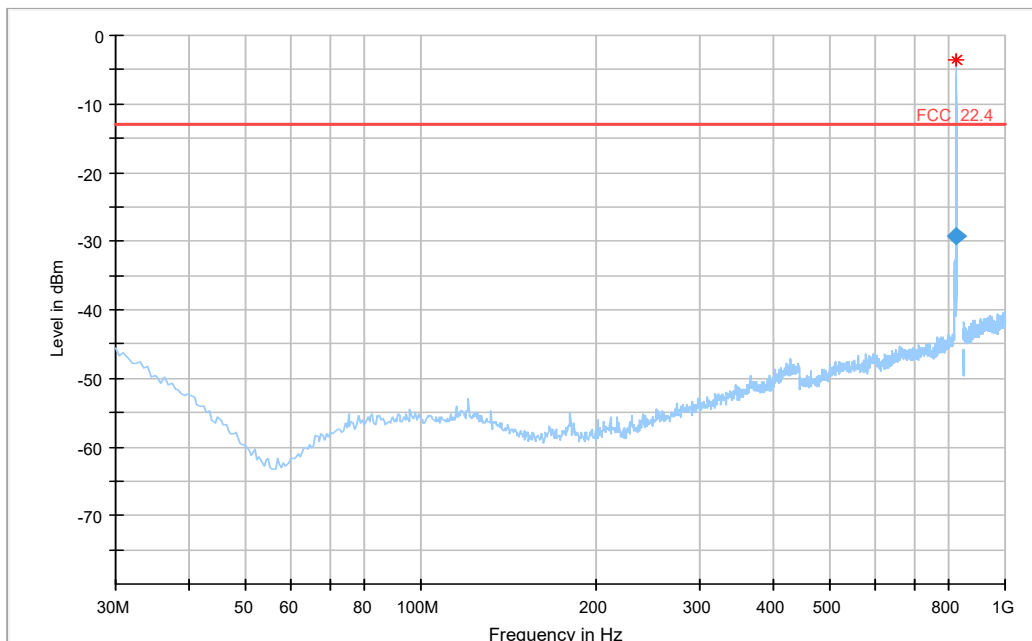

Frequency (MHz)	RMS (dBm)	Limit (dBm)	Margin (dB)	Meas. Time (ms)	Bandwidth (kHz)	Height (cm)	Pol	Azimuth (deg)	Corr. (dB)
824.0	-29.30	-13.00	16.30	1000.0	50.000	110.0	H	80.0	-73.8

1 GHz – 10 GHz

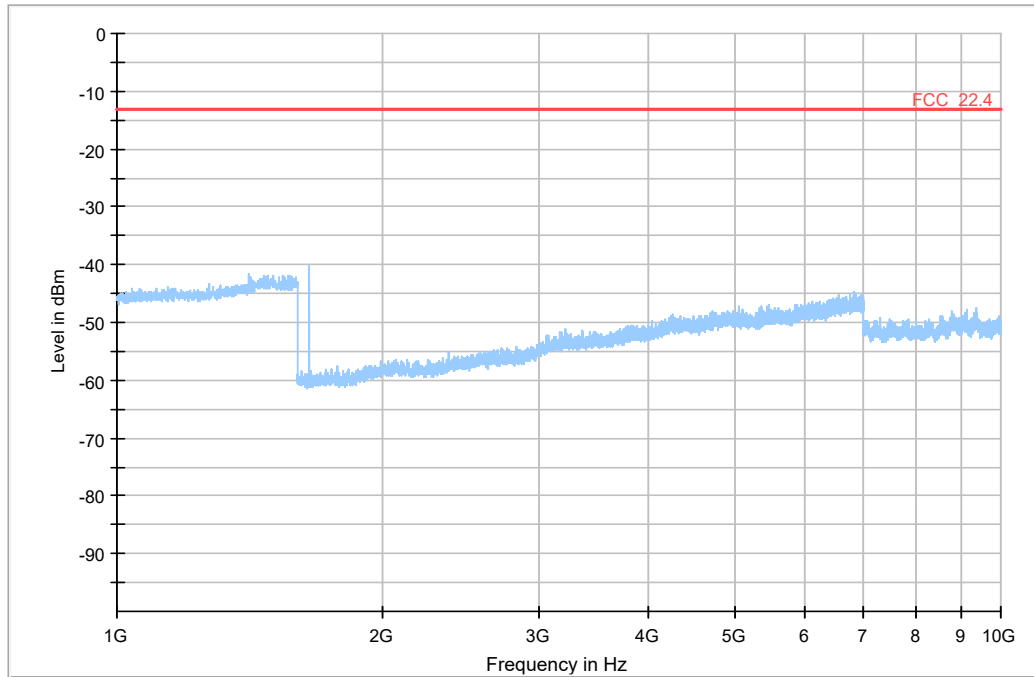

5.4.5 TEST EQUIPMENT USED

- Radiated Emissions

5.5 EMISSION AND OCCUPIED BANDWIDTH

Standard **FCC PART 22 Subpart H**

The test was performed according to:
ANSI C63.26: 2015

5.5.1 TEST DESCRIPTION

This test case is intended to demonstrate compliance to the applicable conducted spurious emission test case per FCC §2.1049 and RSS-GEN 6.7. The limit and the requirements come from the applicable rule part and ISSED RSS-Standard for the operating band of the cellular device.

The EUT was connected to the test setups according to the following diagram:

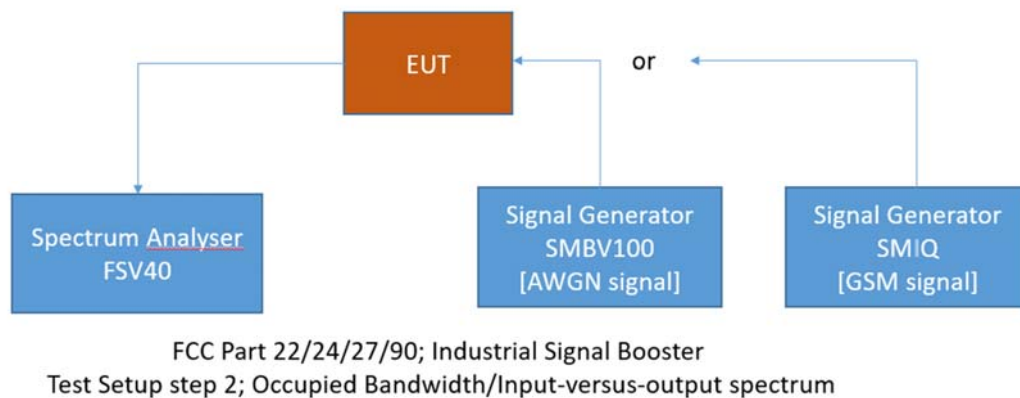
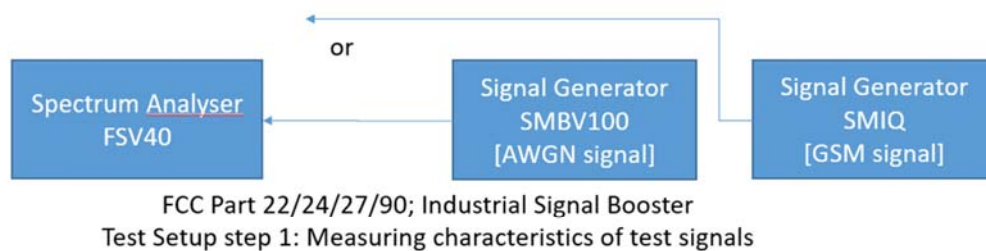

The attenuation of the measuring and stimulus path are known for each measured frequency and are considered.

The Spectrum Analyzer settings can be directly found in the measurement diagrams.

5.5.2 TEST REQUIREMENTS / LIMITS

FCC Part 2.1049; Occupied Bandwidth:

The occupied bandwidth, that is the frequency bandwidth such that, below its lower and above its upper frequency limits, the mean powers radiated are each equal to 0.5 percent of the total mean power radiated by a given emission shall be measured under the following conditions as applicable:

(h) Transmitters employing digital modulation techniques—when modulated by an input signal such that its amplitude and symbol rate represent the maximum rated conditions under which the equipment will be operated. The signal shall be applied through any filter networks, pseudo-random generators or other devices required in normal service. Additionally, the occupied bandwidth shall be shown for operation with any devices used for modifying the spectrum when such devices are optional at the discretion of the user.

(i) Transmitters designed for other types of modulation—when modulated by an appropriate signal of sufficient amplitude to be representative of the type of service in which used. A description of the input signal should be supplied.

RSS-GEN; 6.6 Occupied Bandwidth

The emission bandwidth (\times dB) is defined as the frequency range between two points, one above and one below the carrier frequency, at which the spectral density of the emission is attenuated \times dB below the maximum in-band spectral density of the modulated signal. Spectral density (power per unit bandwidth) is to be measured with a detector of resolution bandwidth in the range of 1% to 5% of the anticipated emission bandwidth, and a video bandwidth at least $3\times$ the resolution bandwidth.

When the occupied bandwidth limit is not stated in the applicable RSS or reference measurement method, the transmitted signal bandwidth shall be reported as the 99% emission bandwidth, as calculated or measured.

5.5.3 TEST PROTOCOL

Ambient temperature: 22 °C
Relative humidity: 35 %

Radio Technology	Channel	Resource Blocks / Subcarrier	Bandwidth [MHz]	Nominal BW [MHz]	99 % BW [kHz]	Verdict
CAT-M1 eFDD 5 QPSK	low	6	1.4	1.4	1118.24	Passed
CAT-M1 eFDD 5 QPSK	mid	6	1.4	1.4	1130.26	Passed
CAT-M1 eFDD 5 QPSK	high	6	1.4	1.4	1130.26	Passed
CAT-M1 eFDD 5 16QAM	low	5	1.4	1.4	967.94	Passed
CAT-M1 eFDD 5 16QAM	mid	5	1.4	1.4	967.94	Passed
CAT-M1 eFDD 5 16QAM	high	5	1.4	1.4	967.94	Passed
CAT-M1 eFDD 26 QPSK	low	6	1.4	1.4	1124.25	Passed
CAT-M1 eFDD 26 QPSK	mid	6	1.4	1.4	1130.26	Passed
CAT-M1 eFDD 26 QPSK	high	6	1.4	1.4	1130.26	Passed
CAT-M1 eFDD 26 16QAM	low	5	1.4	1.4	961.92	Passed
CAT-M1 eFDD 26 16QAM	mid	5	1.4	1.4	967.94	Passed
CAT-M1 eFDD 26 16QAM	high	5	1.4	1.4	967.94	Passed

Remark: Please see next sub-clause for the measurement plot.

5.5.4 MEASUREMENT PLOT (SHOWING THE HIGHEST VALUE, "WORST CASE")

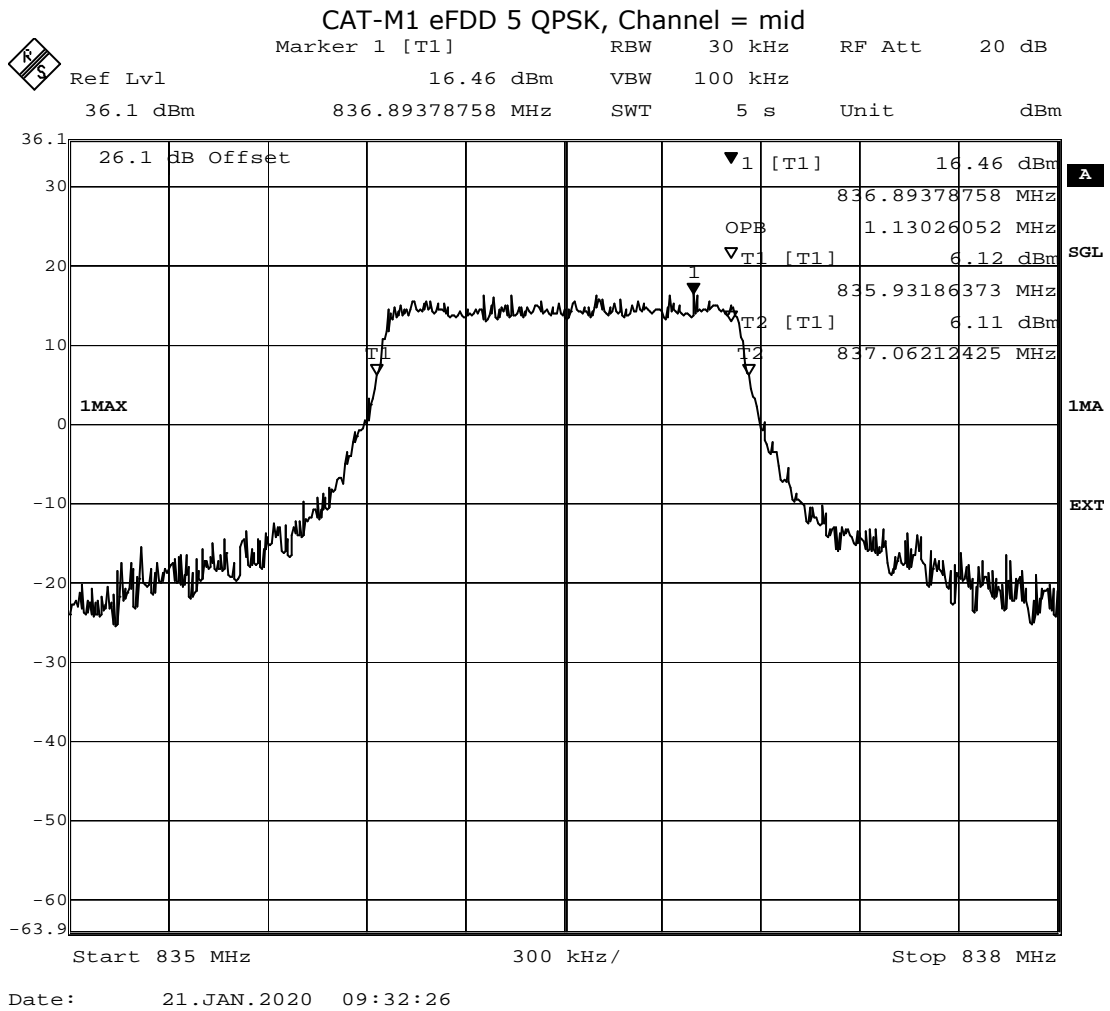

5.5.5 TEST EQUIPMENT USED

- Radio Lab

5.6 BAND EDGE COMPLIANCE

Standard **FCC PART 22 Subpart H**

The test was performed according to:
ANSI C63.26: 2015

5.6.1 TEST DESCRIPTION

This test case is intended to demonstrate compliance to the applicable conducted spurious emission test case per § 2.1051 and RSS-GEN 6.13. The limit comes from the applicable rule part and ISED RSS-Standard for the operating band of the cellular device.

The EUT was connected to the test setup according to the following diagram:

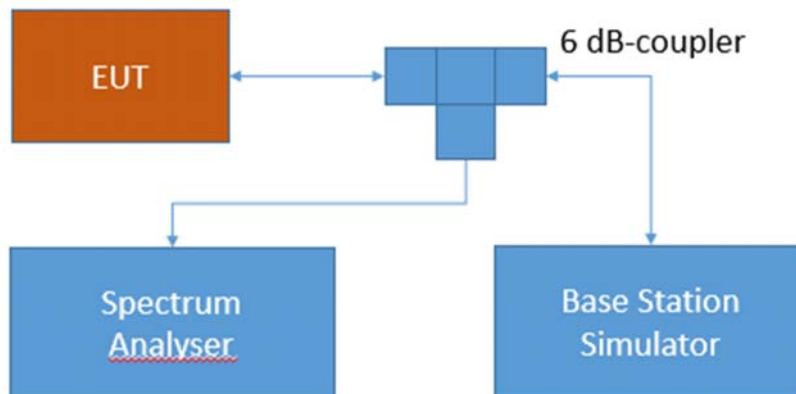

Test Setup FCC Part 22/24/27/90 Cellular;
Band edge compliance

The attenuation of the measuring and stimulus path are known for each measured frequency and are considered.

The Spectrum Analyser settings can be directly found in the measurement diagrams.

5.6.2 TEST REQUIREMENTS / LIMITS

FCC Part 2.1051; Measurement required: Spurious emissions at antenna terminal:

The radio frequency voltage or powers generated within the equipment and appearing on a spurious frequency shall be checked at the equipment output terminals when properly loaded with a suitable artificial antenna. Curves or equivalent data shall show the magnitude of each harmonic and other spurious emission that can be detected when the equipment is operated under the conditions specified in §2.1049 as appropriate. The magnitude of spurious emissions which are attenuated more than 20 dB below the permissible value need not be specified.

Part 22, Subpart H – Cellular Radiotelephone Service

§22 917 – Emission limitations for cellular equipment

(a) *Out of band emissions.* The power of any emission outside of the authorized operating frequency ranges must be attenuated below the transmitting power (P) by a factor of at least $43 + 10 \log(P)$ dB.

RSS-132; 5.5 Transmitter Unwanted Emissions

Mobile and base station equipment shall comply with the limits in (i) and (ii) below.

1. In the first 1.0 MHz band immediately outside and adjacent to each of the sub-bands specified in Section 5.1, the power of emissions per any 1% of the occupied bandwidth shall be attenuated (in dB) below the transmitter output power P (dBW) by at least $43 + 10 \log_{10} p$ (watts).
2. After the first 1.0 MHz immediately outside and adjacent to each of the sub-bands, the power of emissions in any 100 kHz bandwidth shall be attenuated (in dB) below the transmitter output power P (dBW) by at least $43 + 10 \log_{10} p$ (watts). If the measurement is performed using 1% of the occupied bandwidth, power integration over 100 kHz is required.

5.6.3 TEST PROTOCOL

Radio Technology	Channel	Ressource Blocks / Subcarrier	Bandwidth [MHz]	RMS [dBm]	Limit [dBm]	Margin to Limit [dB]
CAT-M1 eFDD 5 QPSK	low	6	1.4	-22.82	-13	9.82
CAT-M1 eFDD 5 QPSK	high	6	1.4	-22.44	-13	9.44
CAT-M1 eFDD 5 16QAM	low	5	1.4	-21.74	-13	8.74
CAT-M1 eFDD 5 16QAM	high	5	1.4	-25.15	-13	12.15
CAT-M1 eFDD 26 QPSK	low	6	1.4	-22.94	-13	9.94
CAT-M1 eFDD 26 QPSK	high	6	1.4	-21.74	-13	8.74
CAT-M1 eFDD 26 16QAM	low	5	1.4	-23.07	-13	10.07
CAT-M1 eFDD 26 16QAM	high	5	1.4	-25.31	-13	12.31

Remark: Please see next sub-clause for the measurement plot.

5.7 PEAK-AVERAGE-RATIO

Standard **FCC PART 22 Subpart H**

The test was performed according to:
ANSI C63.26: 2015

5.7.1 TEST DESCRIPTION

This test case is intended to demonstrate compliance of the EUT to the peak-to-average limits and requirements of the applicable rule part and ISED RSS-Standard for the operating band of the cellular device.

The EUT was connected to the test setup according to the following diagram:

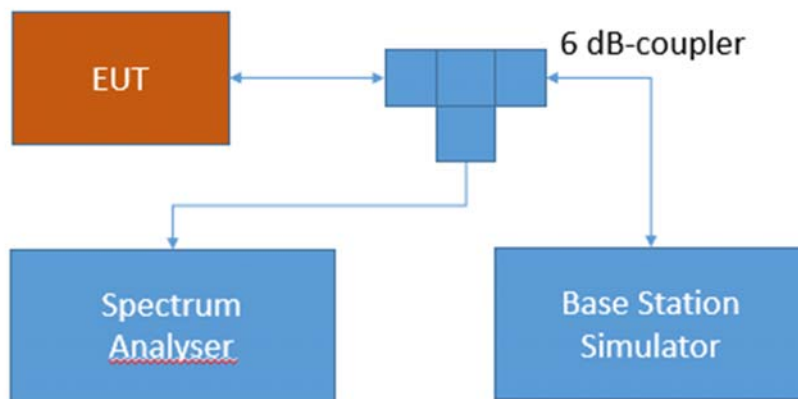

Test Setup FCC Part 22/24/27/90 Cellular;
Peak-average ratio

The attenuation of the measuring and stimulus path are known for each measured frequency and are considered.

The Spectrum Analyser settings can be directly found in the measurement diagrams. The internal CCDF (complementary cumulative distribution function) of the spectrum analyser is used for this measurement

5.7.2 TEST REQUIREMENTS / LIMITS

FCC Part 22, § 22.913

There exists no applicable limit

RSS-132; 5.4 Transmitter Output Power and Equivalent Isotropically Radiated Power

In addition, the peak-to-average power ratio (PAPR) of the transmitter shall not exceed 13 dB for more than 0.1% of the time using a signal corresponding to the highest PAPR during periods of continuous transmission.

5.7.3 TEST PROTOCOL

Ambient temperature: 24 °C
Relative humidity: 38 %

Radio Technology	Channel	Ressource Blocks / Subcarrier	Bandwidth [MHz]	Peak to Average Ratio [dB]	Limit (IC) [dB]
CAT-M1 eFDD 5 QPSK	low	6	1.4	8.32	13
CAT-M1 eFDD 5 QPSK	mid	6	1.4	8.38	13
CAT-M1 eFDD 5 QPSK	high	6	1.4	8.49	13
CAT-M1 eFDD 5 16QAM	low	5	1.4	8.67	13
CAT-M1 eFDD 5 16QAM	mid	5	1.4	8.67	13
CAT-M1 eFDD 5 16QAM	high	5	1.4	9.04	13
CAT-M1 eFDD 26 QPSK	low	6	1.4	8.32	13
CAT-M1 eFDD 26 QPSK	mid	6	1.4	7.57	13
CAT-M1 eFDD 26 QPSK	high	6	1.4	7.86	13
CAT-M1 eFDD 26 16QAM	low	5	1.4	8.64	13
CAT-M1 eFDD 26 16QAM	mid	5	1.4	8.06	13
CAT-M1 eFDD 26 16QAM	high	5	1.4	8.64	13

Remark: Please see next sub-clause for the measurement plot.

5.7.4 MEASUREMENT PLOT (SHOWING THE HIGHEST VALUE, "WORST CASE")
 CAT-M1 eFDD 5 16QAM, Channel = high

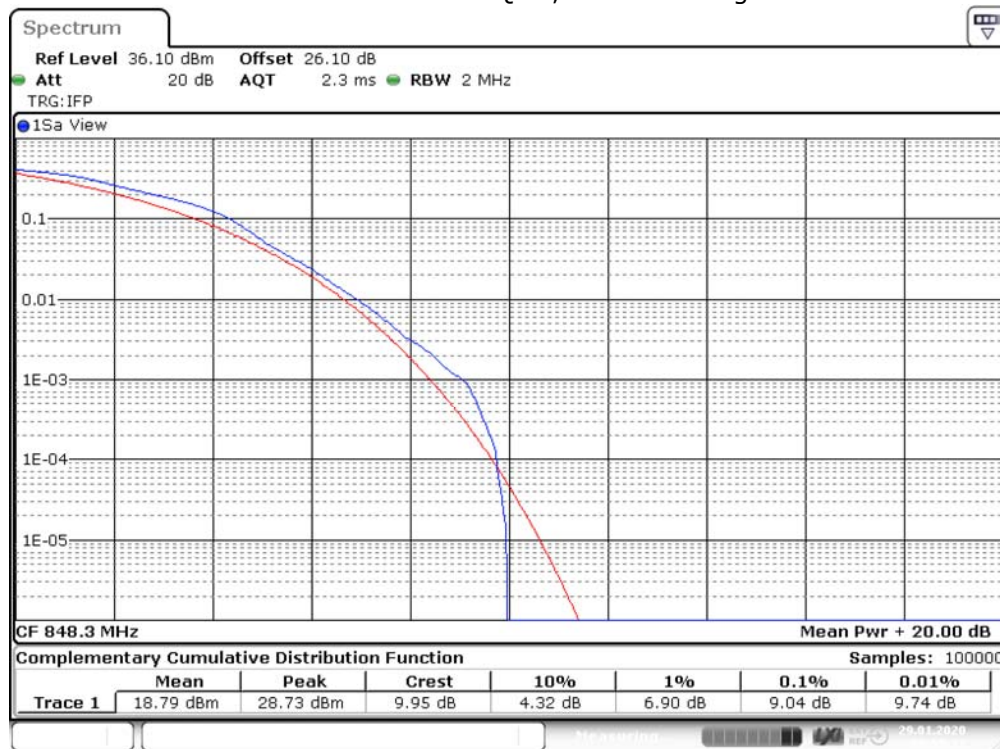

Date: 29. JAN 2020 08:55:13

5.7.5 TEST EQUIPMENT USED

- Radio Lab

5.8 RF OUTPUT POWER

Standard **FCC PART 24 Subpart E**

The test was performed according to:
ANSI C63.26: 2015

5.8.1 TEST DESCRIPTION

This test case is intended to demonstrate compliance to the applicable RF Output power test case per § 2.1046 and RSS-GEN 6.12. The limit and the requirements come from the applicable rule part and ISED RSS-Standard for the operating band of the cellular device.

The EUT was connected to the test setup according to the following diagram:

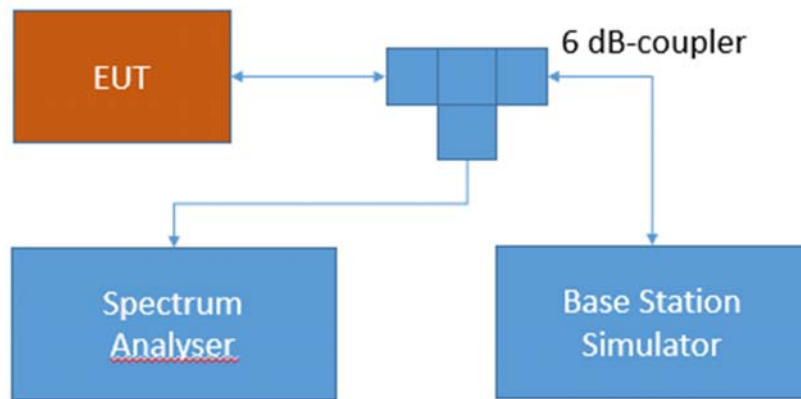

Test Setup FCC Part 22/24/27/90 Cellular;
RF Output power

The attenuation of the measuring and stimulus path are known for each measured frequency and are considered.

The Spectrum Analyzer settings can be directly found in the measurement diagrams.

5.8.2 TEST REQUIREMENTS / LIMITS

FCC Part 24, § 24.232

(c) Mobile and portable stations are limited to 2 watts EIRP and the equipment must employ a means for limiting power to the minimum necessary for successful communications.

RSS-133; 6.4 Transmitter Output Power and Equivalent Isotropically Radiated Power

The equivalent isotropically radiated power (e.i.r.p.) for transmitters shall not exceed the limits given in SRSP-510.

SRSP-510; 5.1.2 Radiated Power and Antenna Height Limits – Mobile Stations

Mobile stations and hand-held portables are limited to 2 watts maximum e.i.r.p. The equipment shall employ means to limit the power to the minimum necessary for successful communication.

5.8.3 TEST PROTOCOL

Ambient temperature: 24 °C
Relative humidity: 38 %

Radio Technology	Channel	Resource Blocks / Sub-carrier	Bandwidth [MHz]	RMS Conducted Power [dBm]	FCC EIRP Limit [W]	IC EIRP Limit [W]	Maximum Antenna Gain FCC [dBi]	Maximum Antenna Gain IC [dBi]
CAT-M1 eFDD 2 QPSK	low	1	1.4	22.57	2	2	10.43	10.43
CAT-M1 eFDD 2 QPSK	low	3	1.4	21.42	2	2	11.58	11.58
CAT-M1 eFDD 2 QPSK	low	6	1.4	20.4	2	2	12.6	12.6
CAT-M1 eFDD 2 QPSK	mid	1	1.4	22.43	2	2	10.57	10.57
CAT-M1 eFDD 2 QPSK	mid	3	1.4	21.38	2	2	11.62	11.62
CAT-M1 eFDD 2 QPSK	mid	6	1.4	20.27	2	2	12.73	12.73
CAT-M1 eFDD 2 QPSK	high	1	1.4	22.67	2	2	10.33	10.33
CAT-M1 eFDD 2 QPSK	high	3	1.4	21.48	2	2	11.52	11.52
CAT-M1 eFDD 2 QPSK	high	6	1.4	20.52	2	2	12.48	12.48
CAT-M1 eFDD 2 16QAM	low	1	1.4	20.87	2	2	12.13	12.13
CAT-M1 eFDD 2 16QAM	low	5	1.4	20.62	2	2	12.38	12.38
CAT-M1 eFDD 2 16QAM	mid	1	1.4	20.9	2	2	12.1	12.1
CAT-M1 eFDD 2 16QAM	mid	5	1.4	20.41	2	2	12.59	12.59
CAT-M1 eFDD 2 16QAM	high	1	1.4	21.16	2	2	11.84	11.84
CAT-M1 eFDD 2 16QAM	high	5	1.4	20.64	2	2	12.36	12.36
CAT-M1 eFDD 25 QPSK	low	1	1.4	22.62	2	2	10.38	10.38
CAT-M1 eFDD 25 QPSK	low	3	1.4	21.43	2	2	11.57	11.57
CAT-M1 eFDD 25 QPSK	low	6	1.4	20.42	2	2	12.58	12.58
CAT-M1 eFDD 25 QPSK	mid	1	1.4	22.5	2	2	10.5	10.5
CAT-M1 eFDD 25 QPSK	mid	3	1.4	21.45	2	2	11.55	11.55
CAT-M1 eFDD 25 QPSK	mid	6	1.4	20.38	2	2	12.62	12.62
CAT-M1 eFDD 25 QPSK	high	1	1.4	22.59	2	2	10.41	10.41
CAT-M1 eFDD 25 QPSK	high	3	1.4	21.52	2	2	11.48	11.48
CAT-M1 eFDD 25 QPSK	high	6	1.4	20.37	2	2	12.63	12.63
CAT-M1 eFDD 25 16QAM	low	1	1.4	20.89	2	2	12.11	12.11
CAT-M1 eFDD 25 16QAM	low	5	1.4	20.53	2	2	12.47	12.47
CAT-M1 eFDD 25 16QAM	mid	1	1.4	20.88	2	2	12.12	12.12
CAT-M1 eFDD 25 16QAM	mid	5	1.4	20.55	2	2	12.45	12.45
CAT-M1 eFDD 25 16QAM	high	1	1.4	20.95	2	2	12.05	12.05
CAT-M1 eFDD 25 16QAM	high	5	1.4	20.61	2	2	12.39	12.39

Remark: Please see next sub-clause for the measurement plot.

5.8.4 MEASUREMENT PLOT (SHOWING THE HIGHEST VALUE, "WORST CASE")
 CAT-M1 eFDD 2 QPSK, RB = 1, Channel = high

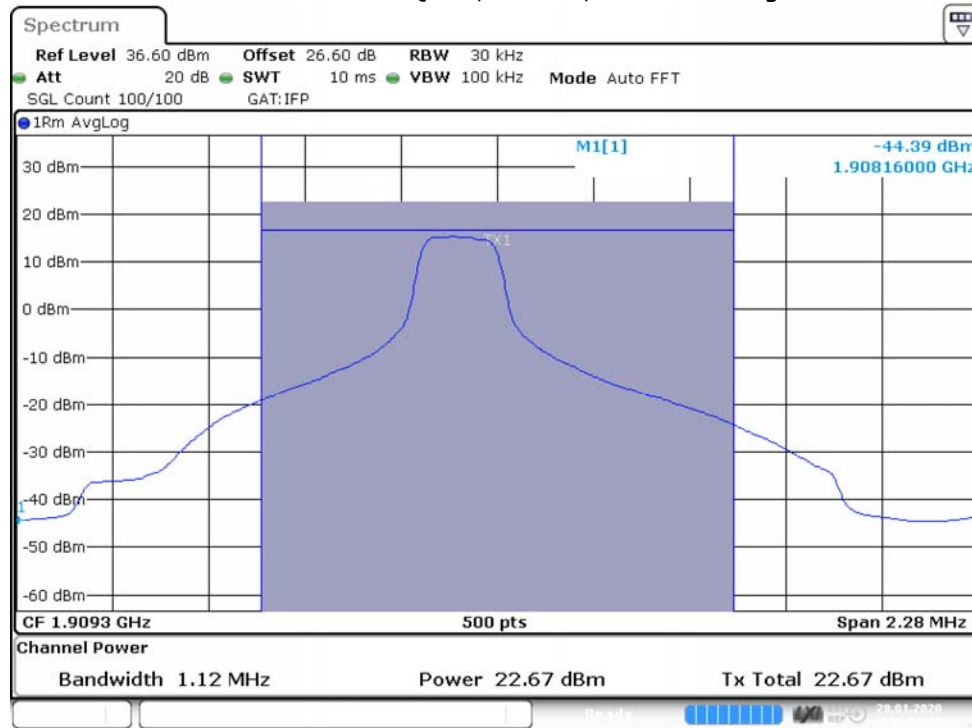

Date: 28.JAN.2020 12:59:57

5.8.5 TEST EQUIPMENT USED

- Radio Lab

5.9 FREQUENCY STABILITY

Standard **FCC PART 24 Subpart E**

The test was performed according to:
ANSI C63.26: 2015

5.9.1 TEST DESCRIPTION

This test case is intended to demonstrate compliance to the applicable frequency stability test case per § 2.1055 and RSS-GEN 6.11. The limit and the requirements come from the applicable rule part and ISED RSS-Standard for the operating band of the cellular device.

The EUT was connected to the test setup according to the following diagram:



Test Setup FCC Part 22/24/27/90 Cellular;
Frequency stability

The attenuation of the measuring / stimulus path is known for each measured frequency and are considered.

5.9.2 TEST REQUIREMENTS / LIMITS

FCC Part 24, § 24.235

The frequency stability shall be sufficient to ensure that the fundamental emission stays within the authorized frequency block.

RSS-133; 6.3 Frequency Stability

The carrier frequency shall not depart from the reference frequency, in excess of ± 2.5 ppm for mobile stations.

In lieu of meeting the above stability values, the test report may show that the frequency stability is sufficient to ensure that the emission bandwidth stays within the operating frequency block when tested to the temperature and supply voltage variations specified in RSS-Gen.

5.9.3 TEST PROTOCOL

CAT-M1 eFDD 2 QPSK, RB=6, Channel = mid

Temp. °C	Duration min	Voltage	Limit Hz	Freq. error Average (Hz)	Freq. error Max. (Hz)	Verdict
-30	0	normal	4700	2	11	passed
-30	5			4	9	passed
-30	10			2	7	passed
-20	0	normal	4700	1	8	passed
-20	5			3	8	passed
-20	10			4	3	passed
-10	0	normal	4700	0	14	passed
-10	5			2	12	passed
-10	10			-2	11	passed
0	0	normal	4700	-1	6	passed
0	5			3	7	passed
0	10			0	5	passed
10	0	normal	4700	5	6	passed
10	5			-3	6	passed
10	10			-3	4	passed
20	0	low	4700	2	13	passed
20	5			2	7	passed
20	10			1	16	passed
20	0	normal	4700	4	12	passed
20	5			3	10	passed
20	10			4	13	passed
20	0	high	4700	1	9	passed
20	5			2	10	passed
20	10			2	9	passed
30	0	normal	4700	4	12	passed
30	5			-3	13	passed
30	10			-4	15	passed
40	0	normal	4700	-5	8	passed
40	5			-3	9	passed
40	10			-4	10	passed
50	0	normal	4700	3	7	passed
50	5			4	11	passed
50	10			4	9	passed

CAT-M1 eFDD 25 QPSK, RB=6, Channel = mid

Temp. °C	Duration min	Voltage	Limit Hz	Freq. error Average (Hz)	Freq. error Max. (Hz)	Verdict
-30	0	normal	4706.25	-8	-16	passed
-30	5			-11	-28	passed
-30	10			-18	-26	passed
-20	0	normal	4706.25	9	21	passed
-20	5			20	29	passed
-20	10			26	35	passed
-10	0	normal	4706.25	21	27	passed
-10	5			-9	-15	passed
-10	10			1	11	passed
0	0	normal	4706.25	6	18	passed
0	5			3	15	passed
0	10			-3	-14	passed
10	0	normal	4706.25	8	16	passed
10	5			8	18	passed
10	10			4	13	passed
20	0	low	4706.25	-18	-27	passed
20	5			-6	-15	passed
20	10			-10	-17	passed
20	0	normal	4706.25	-2	-14	passed
20	5			-8	-22	passed
20	10			-6	-20	passed
20	0	high	4706.25	9	22	passed
20	5			1	14	passed
20	10			8	17	passed
30	0	normal	4706.25	4	16	passed
30	5			3	13	passed
30	10			1	7	passed
40	0	normal	4706.25	14	23	passed
40	5			18	26	passed
40	10			24	32	passed
50	0	normal	4706.25	6	17	passed
50	5			15	24	passed
50	10			17	25	passed

5.9.4 TEST EQUIPMENT USED

- Radio Lab

5.10 SPURIOUS EMISSIONS AT ANTENNA TERMINAL

Standard **FCC PART 24 Subpart E**

The test was performed according to:
ANSI C63.26: 2015

5.10.1 TEST DESCRIPTION

This test case is intended to demonstrate compliance to the applicable conducted spurious emission test case per § 2.1051 and RSS-GEN 6.13. The limit comes from the applicable rule part and ISED RSS-Standard for the operating band of the cellular device.

The EUT was connected to the test setup according to the following diagram:

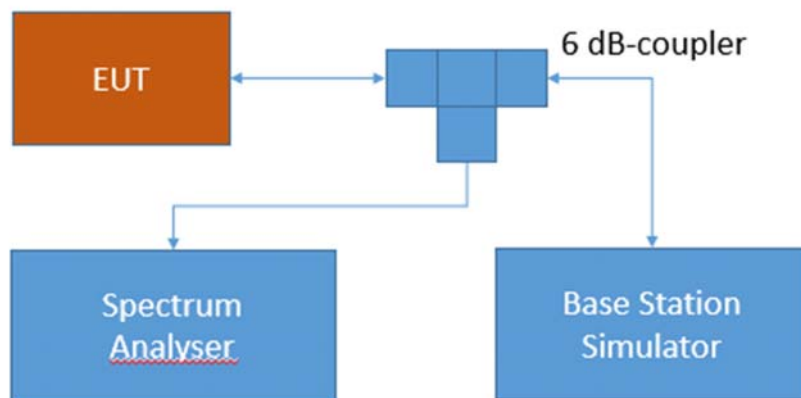

Test Setup FCC Part 22/24/27/90 Cellular;
Spurious Emissions at antenna terminal

The attenuation of the measuring and stimulus path are known for each measured frequency and are considered.

The Spectrum Analyzer settings can be directly found in the measurement diagrams.

5.10.2 TEST REQUIREMENTS / LIMITS

FCC Part 2.1051; Measurement required: Spurious emissions at antenna terminal:

The radio frequency voltage or powers generated within the equipment and appearing on a spurious frequency shall be checked at the equipment output terminals when properly loaded with a suitable artificial antenna. Curves or equivalent data shall show the magnitude of each harmonic and other spurious emission that can be detected when the equipment is operated

under the conditions specified in §2.1049 as appropriate. The magnitude of spurious emissions which are attenuated more than 20 dB below the permissible value need not be specified.

Part 24, Subpart E – Broadband PCS; Band 2

§24.238 – Emission limitations for Broadband PCS equipment

(a) *Out of band emissions.* The power of any emission outside of the authorized operating frequency ranges must be attenuated below the transmitting power (P) by a factor of at least $43 + 10 \log(P)$ dB.

RSS-133; 6.5 Transmitter Unwanted Emissions

6.5.1 Out-of-Block Emissions

Equipment shall comply with the limits in (i) and (ii) below.

- i. In the 1.0 MHz bands immediately outside and adjacent to the equipment’s operating frequency block, the emission power per any 1% of the emission bandwidth shall be attenuated (in dB) below the transmitter output power P (dBW) by at least $43 + 10 \log_{10}(P)$ dB.
- ii. After the first 1.0 MHz, the emission power in any 1 MHz bandwidth shall be attenuated (in dB) below the transmitter output power P (dBW) by at least $43 + 10 \log_{10}(P)$ dB. If the measurement is performed using 1% of the emission bandwidth, power integration over 1.0 MHz is required.

5.10.3 TEST PROTOCOL

Ambient temperature: 24 °C
Relative humidity: 38 %

Radio Technology	Channel	Detector	Trace	Resolution Bandwidth /kHz	Frequency /MHz	Peak Value /dBm	Limit /dBm	Margin to Limit /dB
eFDD2	low	rms	maxhold	5	1849.9	-27.77	-17.5	10.27
eFDD2	mid	rms	maxhold	-	-	-	-13	>20
eFDD2	high	rms	maxhold	-	-	-	-13	>20

Radio Technology	Channel	Detector	Trace	Resolution Bandwidth /kHz	Frequency /MHz	Peak Value /dBm	Limit /dBm	Margin to Limit /dB
eFDD25	low	rms	maxhold	5	1850	-28.24	-17.5	10.74
eFDD25	mid	rms	maxhold	-	-	-	-13	>20
eFDD25	high	rms	maxhold	-	-	-	-13	>20

Remark: Please see next sub-clause for the measurement plot.

5.10.4 MEASUREMENT PLOT (SHOWING THE HIGHEST VALUE, "WORST CASE")
CAT-M1 eFDD 2 QPSK, RB=1, Channel = low

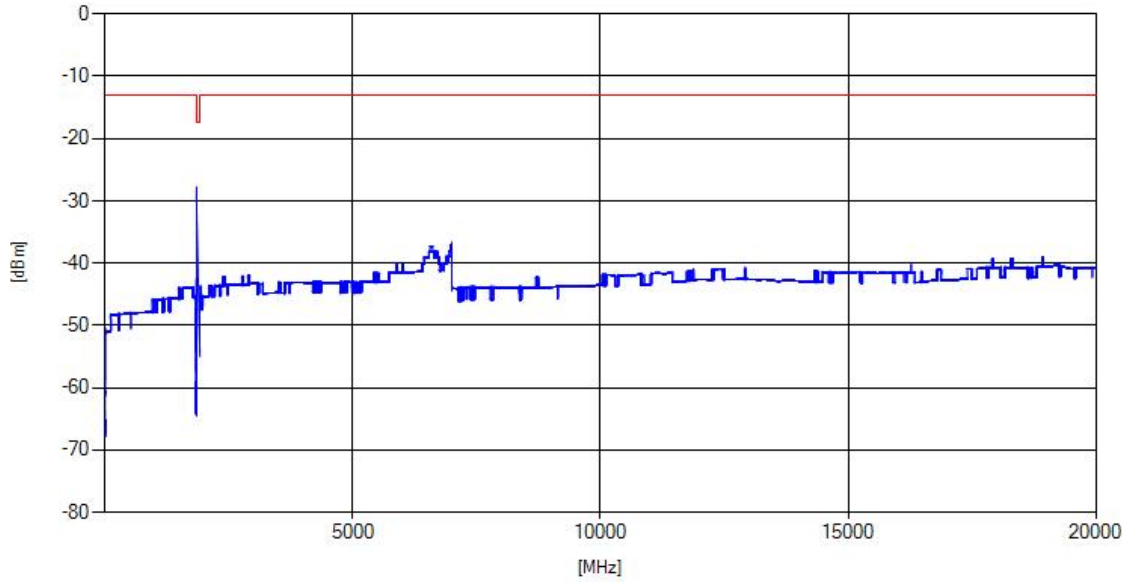

5.10.5 TEST EQUIPMENT USED

- Radio Lab

5.11 FIELD STRENGTH OF SPURIOUS RADIATION

Standard **FCC PART 24 Subpart E**

The test was performed according to:
ANSI C63.26: 2015

5.11.1 TEST DESCRIPTION

This test case is intended to demonstrate compliance to the applicable radiated spurious emission measurements per § 2.1053 and RSS-GEN 6.13. The limit and requirements come from the applicable rule part and ISSED RSS-Standard for the operating band of the cellular device.

The EUT was connected to the test setup according to the following diagram:

Frequency Range: 30 MHz – 1 GHz:

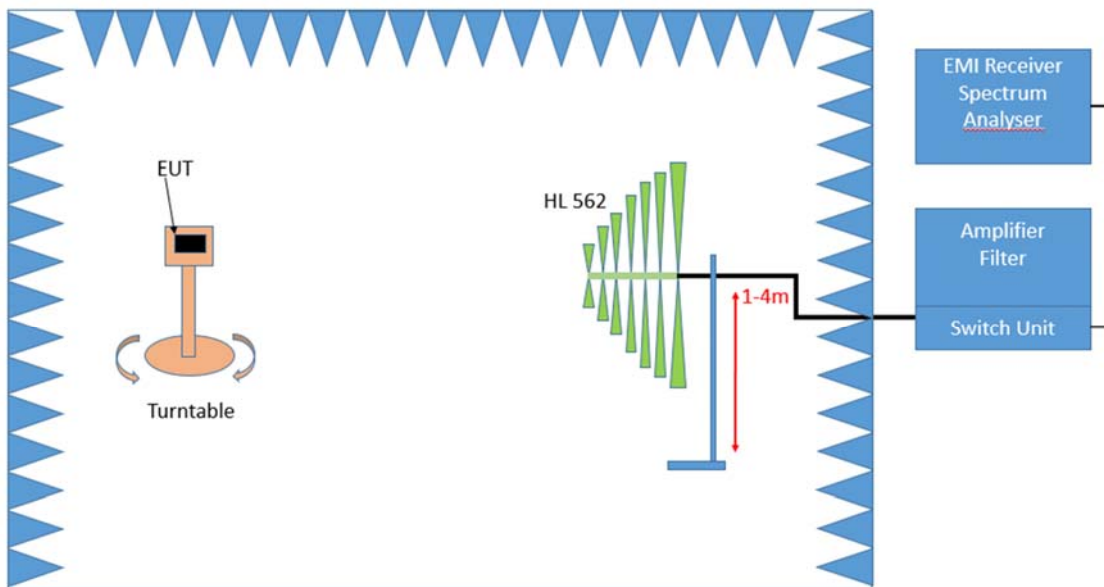

Test Setup; Spurious Emission Radiated (SAC), 30 MHz- 1GHz

Frequency Range: 1 GHz – 26.5 GHz

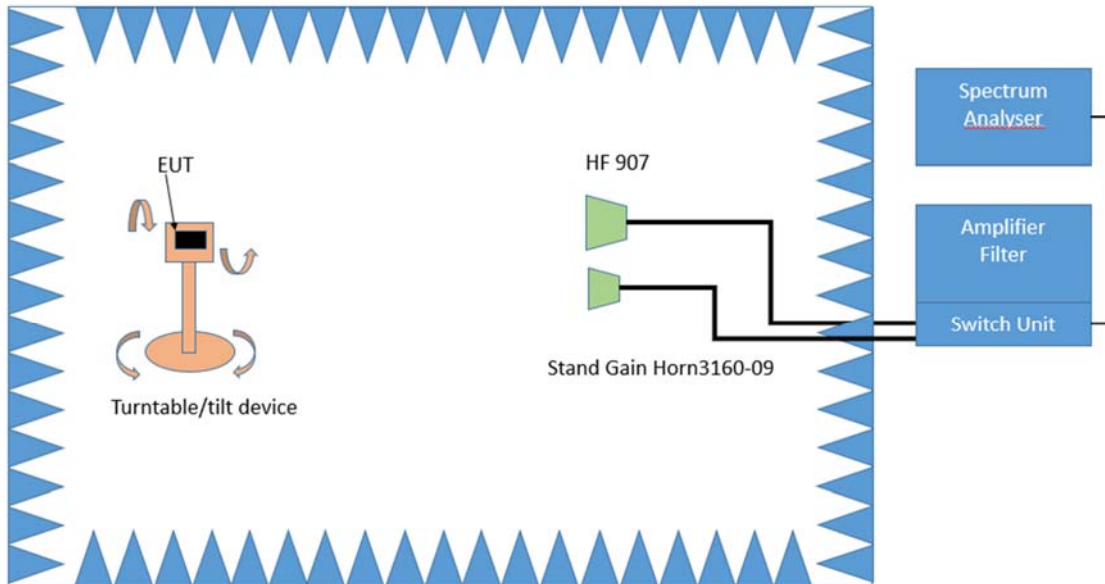

Test Setup; Spurious Emission Radiated (FAC), 1 GHz-26.5 GHz

The test set-up was made in accordance to the general provisions of ANSI C63.26 in a typical installation configuration. The Equipment Under Test (EUT) was set up on a non-conductive table 1.0 x 2.0 m² in the semi-anechoic chamber. The influence of the EUT support table that is used between 30–1000 MHz was evaluated.

The measurement procedure is implemented into the EMI test software EMC32 from R&S. Exploratory tests are performed at 3 orthogonal axes to determine the worst-case orientation of a body-worn or handheld EUT. The final test on all kind of EUTs is also performed at 3 axes. A pre-check is performed while the EUT is powered from a DC power source.

1. Measurement above 30 MHz and up to 1 GHz

Step 1: Preliminary scan

This is a preliminary test to identify the highest amplitudes relative to the limit.

Settings for step 1:

- Antenna distance: 3 m
- Detector: Peak
- RBW: 100 kHz
- VBW: 300 kHz
- Sweep time: coupled
- Turntable angle range: -180° to 90°
- Turntable step size: 90°
- Height variation range: 1 – 3 m
- Height variation step size: 2 m
- Polarisation: Horizontal + Vertical

Intention of this step is, to determine the radiated EMI-profile of the EUT. Afterwards the relevant emissions for the final measurement are identified.

Step 2: Adjustment measurement

In this step the accuracy of the turntable azimuth and antenna height will be improved. This is necessary to find out the maximum value of every frequency.

For each frequency, which was determined the turntable azimuth and antenna height will be adjusted. The turntable azimuth will slowly vary by $\pm 45^\circ$ around this value. During this action, the value of emission is continuously measured. The turntable azimuth at the highest emission will be recorded and adjusted. In this position, the antenna height will also slowly vary by \pm

100 cm around the antenna height determined. During this action, the value of emission is also continuously measured. The antenna height of the highest emission will also be recorded and adjusted.

- Detector: Peak
- Measured frequencies: in step 1 determined frequencies
- RBW: 100 kHz
- VBW: 300 kHz
- Sweep time: coupled
- Turntable angle range: $\pm 45^\circ$ around the determined value
- Height variation range: ± 100 cm around the determined value
- Antenna Polarisation: max. value determined in step 1

Step 3: Final measurement with RMS detector

With the settings determined in step 3, the final measurement will be performed:

EMI receiver settings for step 4:

- Detector: RMQ
- Measured frequencies: in step 1 determined frequencies
- RBW: 100 kHz
- VBW: 300 kHz
- Sweep time: 1 s

After the measurement a plot will be generated which contains a diagram with the results of the preliminary scan and a chart with the frequencies and values of the results of the final measurement.

3. Measurement above 1 GHz

The following modifications apply to the measurement procedure for the frequency range above 1 GHz:

Step 1:

The Equipment Under Test (EUT) was set up on a non-conductive support (tilt device) at 1.5 m height in the fully-anechoic chamber.

All steps were performed with one height (1.5 m) of the receiving antenna only.

The EUT is turned during the preliminary measurement across the elevation axis, with a step size of 45° .

The turn table step size (azimuth angle) for the preliminary measurement is 45° .

- Antenna distance: 3 m
- Detector: Peak
- RBW: 1 MHz
- VBW: 3 MHz
- Sweep time: coupled
- Turntable angle range: -180° to 135°
- Turntable step size: 45°
- Polarisation: Horizontal + Vertical

Step 2:

Due to the fact, that in this frequency range the test is performed in a fully anechoic room, the height scan of the receiving antenna instep 2 is omitted. Instead of this, a maximum search with a step size $\pm 45^\circ$ for the elevation axis is performed.

The turn table azimuth will slowly vary by $\pm 22.5^\circ$.

The elevation angle will slowly vary by $\pm 45^\circ$

EMI receiver settings (for all steps):

- Detector: Peak,
- RBW: 1 MHz
- VBW: 3 MHz
- Sweep time: coupled

Step 3:

Spectrum analyser settings for step 3:

- Detector: RMS
- Measured frequencies: in step 1 determined frequencies
- RBW: 1 MHz
- VBW: 3 MHz
- Sweep Time: 1 s

5.11.2 TEST REQUIREMENTS / LIMITS

FCC Part 2.1053; Measurement required: Field strength of spurious radiation:

Measurements shall be made to detect spurious emissions that may be radiated directly from the cabinet, control circuits, power leads, or intermediate circuit elements under normal conditions of installation and operation. Curves or equivalent data shall be supplied showing the magnitude of each harmonic and other spurious emission. For this test, single sideband, independent sideband, and controlled carrier transmitters shall be modulated under the conditions specified in paragraph (c) of §2.1049, as appropriate.

Part 24, Subpart E – Broadband PCS

§ 24.238 – Emission limitations for Broadband PCS equipment

- a) Out of band emissions. The power of any emission outside of the authorized operating frequency ranges must be attenuated below the transmitting power (P) by a factor of at least $43 + 10 \log(P)$ dB.
- b) Measurement procedure. Compliance with these rules is based on the use of measurement instrumentation employing a resolution bandwidth of 1 MHz or greater. However, in the 1 MHz bands immediately outside and adjacent to the frequency block a resolution bandwidth of at least one percent of the emission bandwidth of the fundamental emission of the transmitter may be employed. A narrower resolution bandwidth is permitted in all cases to improve measurement accuracy provided the measured power is integrated over the full required measurement bandwidth (i.e. 1 MHz or 1 percent of emission bandwidth, as specified). The emission bandwidth is defined as the width of the signal between two points, one below the carrier center frequency and one above the carrier center frequency, outside of which all emissions are attenuated at least 26 dB below the transmitter power.

RSS-133; 6.5 Transmitter Unwanted Emissions

Mobile and base station equipment shall comply with the limits in (1) and (2) below.

1. In the 1.0 MHz bands immediately outside and adjacent to the equipment's operating frequency block, the emission power per any 1% of the emission bandwidth shall be attenuated (in dB) below the transmitter output power P (dBW) by at least $43 + 10 \log_{10} P$ (watts).
2. After the first 1.0 MHz, the emission power in any 1 MHz bandwidth shall be attenuated (in dB) below the transmitter output power P (dBW) by at least $43 + 10 \log_{10} P$ (watts). If the measurement is performed using 1% of the emission bandwidth, power integration over 1.0 MHz is required.

5.11.3 TEST PROTOCOL

Ambient temperature: 24 °C
Relative humidity: 38 %

Radio Technology	Channel	Detector	Trace	Resolution Bandwidth /kHz	Frequency /MHz	Peak Value /dBm	Limit /dBm	Margin to Limit /dB
eFDD2	low	rms	maxhold	100	1848.8	-37.9	-23	14.9
eFDD2	mid	rms	maxhold	-	-	-	-13	>20
eFDD2	high	rms	maxhold	100	1911.4	-46.1	-23	23.1

Radio Technology	Channel	Detector	Trace	Resolution Bandwidth /kHz	Frequency /MHz	Peak Value /dBm	Limit /dBm	Margin to Limit /dB
eFDD25	low	rms	maxhold	1000	1847.58	-36.5	-13	23.5
eFDD25	mid	rms	maxhold	-	-	-	-13	>20
eFDD25	high	rms	maxhold	1000	1917.64	-35.6	-13	>20

Remark: Please see next sub-clause for the measurement plot.

5.11.4 MEASUREMENT PLOT (SHOWING THE HIGHEST VALUE, "WORST CASE")

CAT-M1 eFDD 2 QPSK, RB=1, Channel = low
30 MHz – 1 GHz

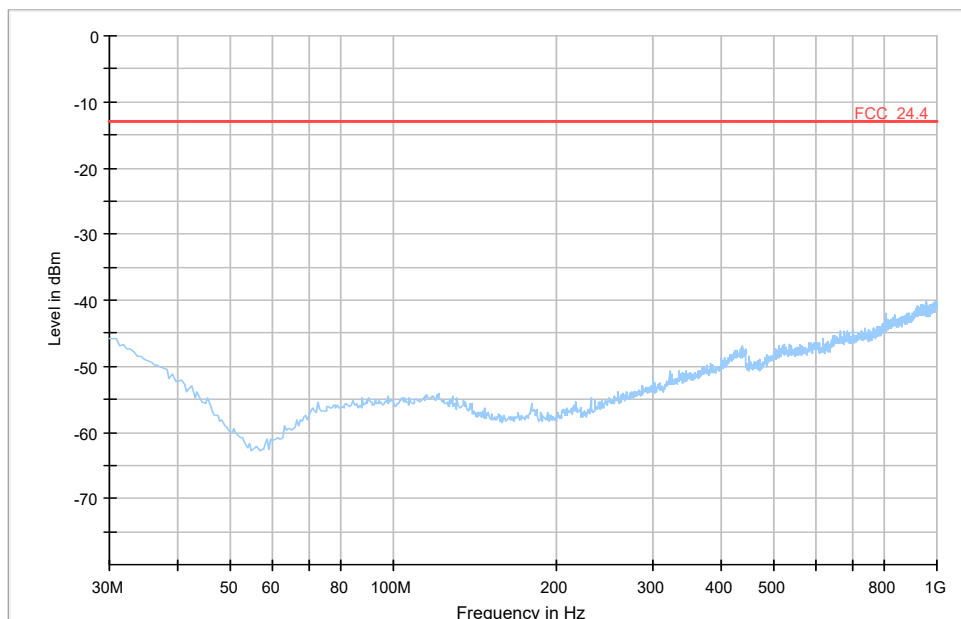

Final Result

Frequency (MHz)	RMS (dBm)	Limit (dBm)	Margin	Meas. Time (ms)	Bandwidth	Height	Pol	Azimuth	Corr. (dB)	Comment
---	---	---	---	---	---	---	---	---	---	---

1 GHz – 20 GHz

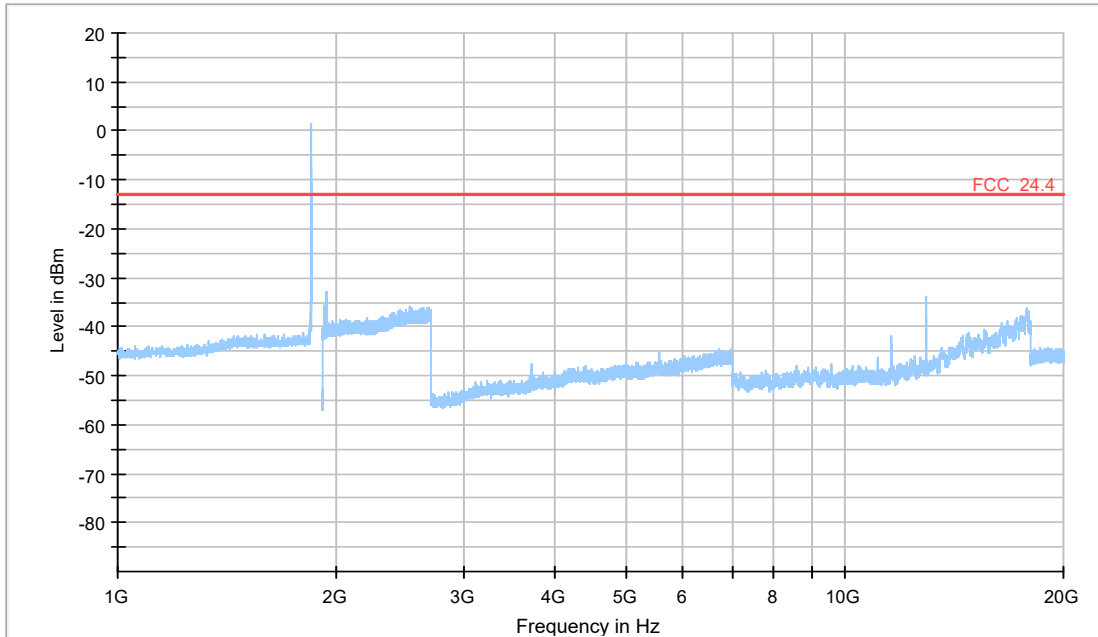

final measurement at lower band edge

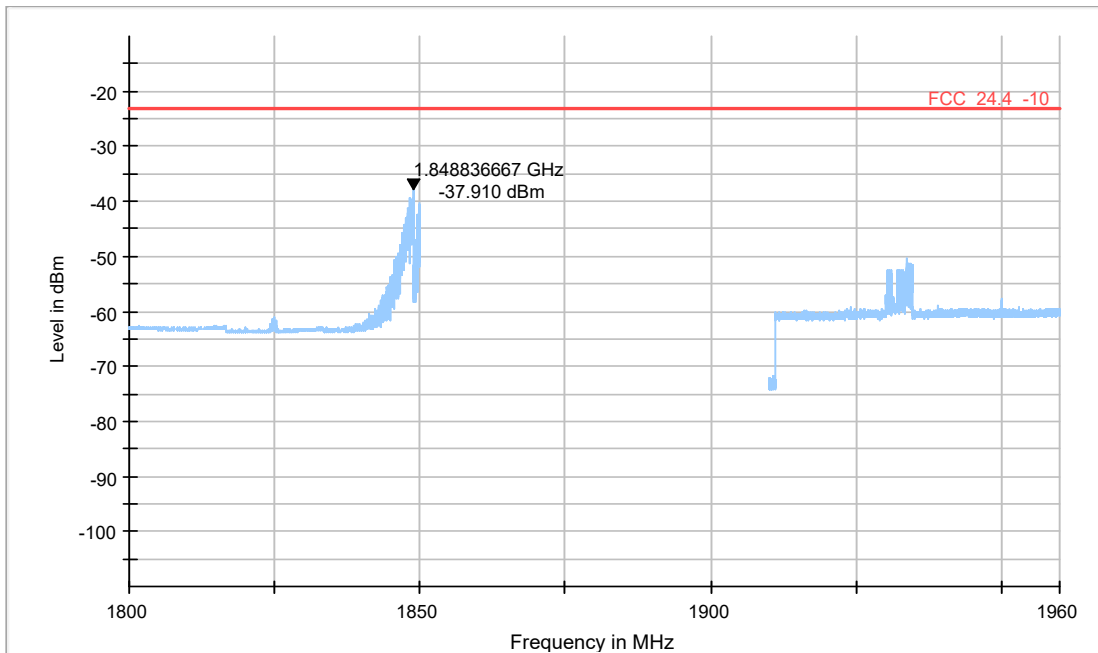

5.11.5 TEST EQUIPMENT USED

- Radiated Emissions

5.12 EMISSION AND OCCUPIED BANDWIDTH

Standard **FCC PART 24 Subpart E**

The test was performed according to:
ANSI C63.26: 2015

5.12.1 TEST DESCRIPTION

This test case is intended to demonstrate compliance to the applicable conducted spurious emission test case per FCC §2.1049 and RSS-GEN 6.7. The limit and the requirements come from the applicable rule part and ISSED RSS-Standard for the operating band of the cellular device.

The EUT was connected to the test setups according to the following diagram:

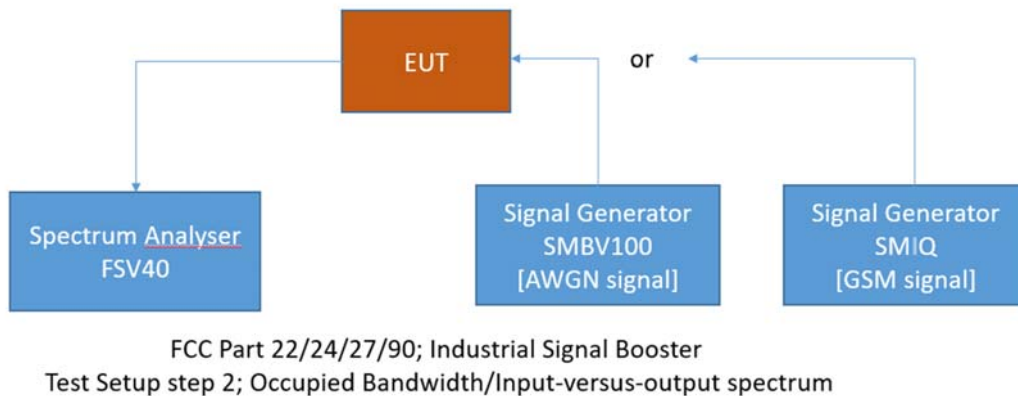
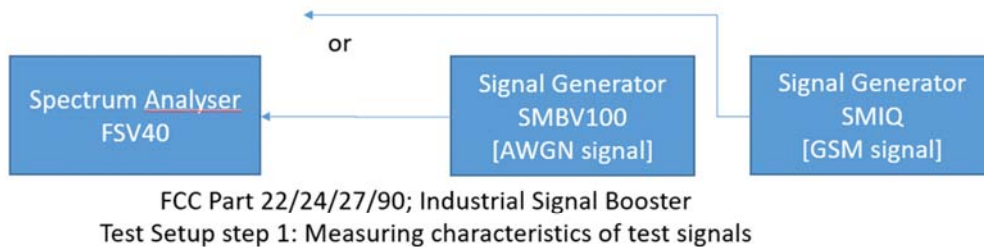

The attenuation of the measuring and stimulus path are known for each measured frequency and are considered.

The Spectrum Analyser settings can be directly found in the measurement diagrams.

5.12.2 TEST REQUIREMENTS / LIMITS

FCC Part 2.1049; Occupied Bandwidth:

The occupied bandwidth, that is the frequency bandwidth such that, below its lower and above its upper frequency limits, the mean powers radiated are each equal to 0.5 percent of the total mean power radiated by a given emission shall be measured under the following conditions as applicable:

(h) Transmitters employing digital modulation techniques—when modulated by an input signal such that its amplitude and symbol rate represent the maximum rated conditions under which the equipment will be operated. The signal shall be applied through any filter networks, pseudo-random generators or other devices required in normal service. Additionally, the occupied bandwidth shall be shown for operation with any devices used for modifying the spectrum when such devices are optional at the discretion of the user.

(i) Transmitters designed for other types of modulation—when modulated by an appropriate signal of sufficient amplitude to be representative of the type of service in which used. A description of the input signal should be supplied.

RSS-GEN; 6.7 Occupied Bandwidth (or 99% emission bandwidth) and x dB bandwidth

The occupied bandwidth or the “99% emission bandwidth” is defined as the frequency range between two points, one above and the other below the carrier frequency, within which 99% of the total transmitted power of the fundamental transmitted emission is contained. The occupied bandwidth shall be reported for all equipment in addition to the specified bandwidth required in the applicable RSSs.

In some cases, the “x dB bandwidth” is required, which is defined as the frequency range between two points, one at the lowest frequency below and one at the highest frequency above the carrier frequency, at which the maximum power level of the transmitted emission is attenuated x dB below the maximum in-band power level of the modulated signal, where the two points are on the outskirts of the in-band emission.

The following conditions shall be observed for measuring the occupied bandwidth and x dB bandwidth:

The transmitter shall be operated at its maximum carrier power measured under normal test conditions.

The span of the spectrum analyzer shall be set large enough to capture all products of the modulation process, including the emission skirts, around the carrier frequency, but small enough to avoid having other emissions (e.g. on adjacent channels) within the span. The detector of the spectrum analyzer shall be set to “Sample”. However, a peak, or peak hold, may be used in place of the sampling detector since this usually produces a wider bandwidth than the actual bandwidth (worst-case measurement). Use of a peak hold (or “Max Hold”) may be necessary to determine the occupied / x dB bandwidth if the device is not transmitting continuously.

The resolution bandwidth (RBW) shall be in the range of 1% to 5% of the actual occupied / x dB bandwidth and the video bandwidth (VBW) shall not be smaller than three times the RBW value. Video averaging is not permitted.

Note: It may be necessary to repeat the measurement a few times until the RBW and VBW are in compliance with the above requirement.

For the 99% emission bandwidth, the trace data points are recovered and directly summed in linear power level terms. The recovered amplitude data points, beginning at the lowest frequency, are placed in a running sum until 0.5% of the total is reached, and that frequency recorded. The process is repeated for the highest frequency data points (starting at the highest frequency, at the right side of the span, and going down in frequency). This frequency is then recorded. The difference between the two recorded frequencies is the occupied bandwidth (or the 99% emission bandwidth).

5.12.3 TEST PROTOCOL

Ambient temperature: 24 °C
Relative humidity: 38 %

Radio Technology	Channel	Resource Blocks / Subcarrier	Bandwidth (MHz)	Nominal BW [MHz]	99 % BW [kHz]
CAT-M1 eFDD 2 QPSK	low	6	1.4	1.4	1118.24
CAT-M1 eFDD 2 QPSK	mid	6	1.4	1.4	1124.25
CAT-M1 eFDD 2 QPSK	high	6	1.4	1.4	1124.25
CAT-M1 eFDD 2 16QAM	low	5	1.4	1.4	967.94
CAT-M1 eFDD 2 16QAM	mid	5	1.4	1.4	973.95
CAT-M1 eFDD 2 16QAM	high	5	1.4	1.4	967.94
CAT-M1 eFDD 25 QPSK	low	6	1.4	1.4	1124.25
CAT-M1 eFDD 25 QPSK	mid	6	1.4	1.4	1124.25
CAT-M1 eFDD 25 QPSK	high	6	1.4	1.4	1130.26
CAT-M1 eFDD 25 16QAM	low	5	1.4	1.4	967.94
CAT-M1 eFDD 25 16QAM	mid	5	1.4	1.4	967.94
CAT-M1 eFDD 25 16QAM	high	5	1.4	1.4	967.94

Remark: Please see next sub-clause for the measurement plot.

5.12.4 MEASUREMENT PLOT (SHOWING THE HIGHEST VALUE, "WORST CASE")

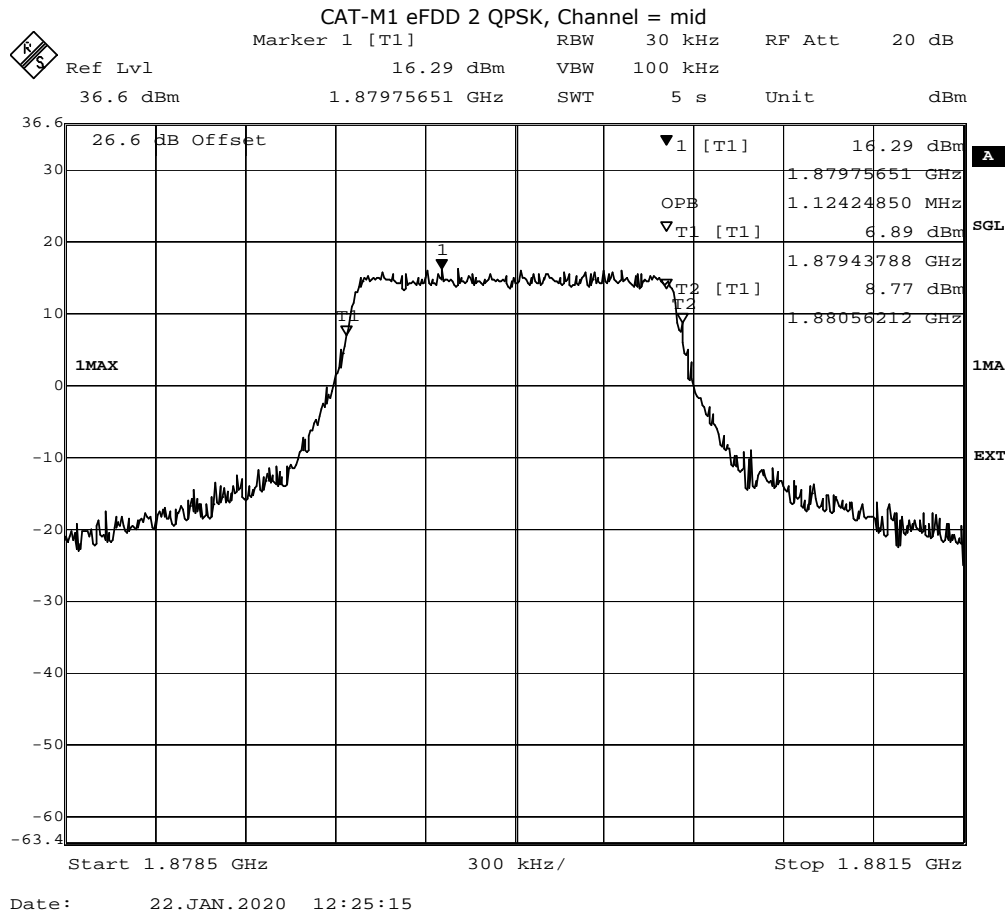

5.12.5 TEST EQUIPMENT USED

5.13 BAND EDGE COMPLIANCE

Standard **FCC PART 24 Subpart E**

The test was performed according to:
ANSI C63.26: 2015

5.13.1 TEST DESCRIPTION

This test case is intended to demonstrate compliance to the applicable conducted spurious emission test case per § 2.1051 and RSS-GEN 6.13. The limit comes from the applicable rule part and ISED RSS-Standard for the operating band of the cellular device.

The EUT was connected to the test setup according to the following diagram:

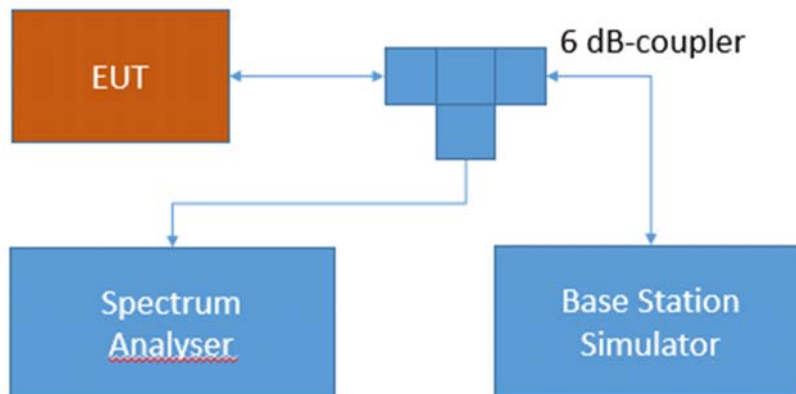

Test Setup FCC Part 22/24/27/90 Cellular;
Band edge compliance

The attenuation of the measuring and stimulus path are known for each measured frequency and are considered.

The Spectrum Analyzer settings can be directly found in the measurement diagrams.

5.13.2 TEST REQUIREMENTS / LIMITS

FCC Part 2.1051; Measurement required: Spurious emissions at antenna terminal:

The radio frequency voltage or powers generated within the equipment and appearing on a spurious frequency shall be checked at the equipment output terminals when properly loaded with a suitable artificial antenna. Curves or equivalent data shall show the magnitude of each harmonic and other spurious emission that can be detected when the equipment is operated under the conditions specified in §2.1049 as appropriate. The magnitude of spurious emissions which are attenuated more than 20 dB below the permissible value need not be specified.

Part 24, Subpart E – Broadband PCS

§24.238 – Emission limitations for Broadband PCS equipment

- a) Out of band emissions. The power of any emission outside of the authorized operating frequency ranges must be attenuated below the transmitting power (P) by a factor of at least $43 + 10 \log(P)$ dB.
- b) Measurement procedure. Compliance with these rules is based on the use of measurement instrumentation employing a resolution bandwidth of 1 MHz or greater. However, in the 1 MHz bands immediately outside and adjacent to the frequency block a resolution bandwidth of at least one percent of the emission bandwidth of the fundamental emission of the transmitter may be employed. A narrower resolution bandwidth is permitted in all cases to improve measurement accuracy provided the measured power is integrated over the full required measurement bandwidth (i.e. 1 MHz or 1 percent of emission bandwidth, as specified). The emission bandwidth is defined as the width of the signal between two points, one below the carrier center frequency and one above the carrier center frequency, outside of which all emissions are attenuated at least 26 dB below the transmitter power.

RSS-133; 6.5 Transmitter Unwanted Emissions

Mobile and base station equipment shall comply with the limits in (1) and (2) below.

1. In the 1.0 MHz bands immediately outside and adjacent to the equipment's operating frequency block, the emission power per any 1% of the emission bandwidth shall be attenuated (in dB) below the transmitter output power P (dBW) by at least $43 + 10 \log_{10}p$ (watts).
2. After the first 1.0 MHz, the emission power in any 1 MHz bandwidth shall be attenuated (in dB) below the transmitter output power P (dBW) by at least $43 + 10 \log_{10}p$ (watts). If the measurement is performed using 1% of the emission bandwidth, power integration over 1.0 MHz is required.

7

5.13.3 TEST PROTOCOL

Ambient temperature: 24 °C
 Relative humidity: 38 %

Radio Technology	Channel	Ressource Blocks / Subcarrier	Bandwidth (MHz)	RMS [dBm]	Limit /dBm	Margin to Limit /dB
CAT-M1 eFDD 2 QPSK	low	6	1.4	-24.32	-13	11.32
CAT-M1 eFDD 2 QPSK	high	6	1.4	-24	-13	11
CAT-M1 eFDD 2 16QAM	low	5	1.4	-22.44	-13	9.44
CAT-M1 eFDD 2 16QAM	high	5	1.4	-27.14	-13	14.14
CAT-M1 eFDD 25 QPSK	low	6	1.4	-23.55	-13	10.55
CAT-M1 eFDD 25 QPSK	high	6	1.4	-23.4	-13	10.4
CAT-M1 eFDD 25 16QAM	low	5	1.4	-22.19	-13	9.19
CAT-M1 eFDD 25 16QAM	high	5	1.4	-27.84	-13	14.84

Remark: Please see next sub-clause for the measurement plot.

5.13.4 MEASUREMENT PLOT (SHOWING THE HIGHEST VALUE, "WORST CASE")

5.13.5 TEST EQUIPMENT USED

5.14 PEAK TO AVERAGE RATIO

Standard **FCC PART 24 Subpart E**

The test was performed according to:
ANSI C63.26: 2015

5.14.1 TEST DESCRIPTION

This test case is intended to demonstrate compliance of the EUT to the peak-to-average limits and requirements of the applicable rule part and ISED RSS-Standard for the operating band of the cellular device.

The EUT was connected to the test setup according to the following diagram:

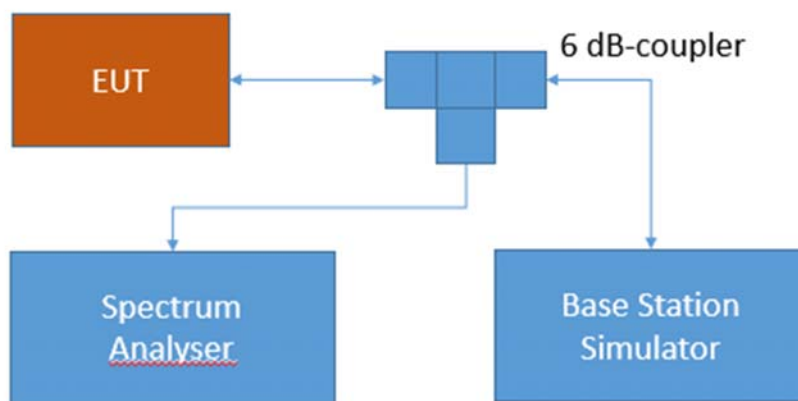

Test Setup FCC Part 22/24/27/90 Cellular;
Peak-average ratio

The attenuation of the measuring and stimulus path are known for each measured frequency and are considered.

The Spectrum Analyser settings can be directly found in the measurement diagrams. The internal CCDF (complementary cumulative distribution function) of the spectrum analyser is used for this measurement

5.14.2 TEST REQUIREMENTS / LIMITS

FCC Part 24, § 24.232

(d) Power measurements for transmissions by stations authorized under this section may be made either in accordance with a Commission-approved average power technique or in compliance with paragraph (e) of this section. In both instances, equipment employed must be authorized in accordance with the provisions of §24.51. In measuring transmissions in this

band using an average power technique, the peak-to-average ratio (PAR) of the transmission may not exceed 13 dB.

RSS-133; 6.4 Transmitter Output Power and Equivalent Isotropically Radiated Power

In addition, the peak-to-average power ratio (PAPR) of the transmitter shall not exceed 13 dB for more than 0.1% of the time using a signal corresponding to the highest PAPR during periods of continuous transmission.

5.14.3 TEST PROTOCOL

Ambient temperature: 24 °C
Relative humidity: 38 %

Radio Technology	Channel	Ressource Blocks / Subcarrier	Bandwidth [MHz]	Peak to Average Ratio	Limit (IC) [dB]
CAT-M1 eFDD 2 QPSK	low	6	1.4	8.29	13
CAT-M1 eFDD 2 QPSK	mid	6	1.4	7.83	13
CAT-M1 eFDD 2 QPSK	high	6	1.4	7.04	13
CAT-M1 eFDD 2 16QAM	low	5	1.4	9.19	13
CAT-M1 eFDD 2 16QAM	mid	5	1.4	8.06	13
CAT-M1 eFDD 2 16QAM	high	5	1.4	7.39	13
CAT-M1 eFDD 25 QPSK	low	6	1.4	8.14	13
CAT-M1 eFDD 25 QPSK	mid	6	1.4	7.07	13
CAT-M1 eFDD 25 QPSK	high	6	1.4	6.70	13
CAT-M1 eFDD 25 16QAM	low	5	1.4	8.23	13
CAT-M1 eFDD 25 16QAM	mid	5	1.4	7.77	13
CAT-M1 eFDD 25 16QAM	high	5	1.4	7.33	13

Remark: Please see next sub-clause for the measurement plot.

5.14.4 MEASUREMENT PLOT (SHOWING THE HIGHEST VALUE, "WORST CASE")
 CAT-M1 eFDD 2 16QAM, Channel = low

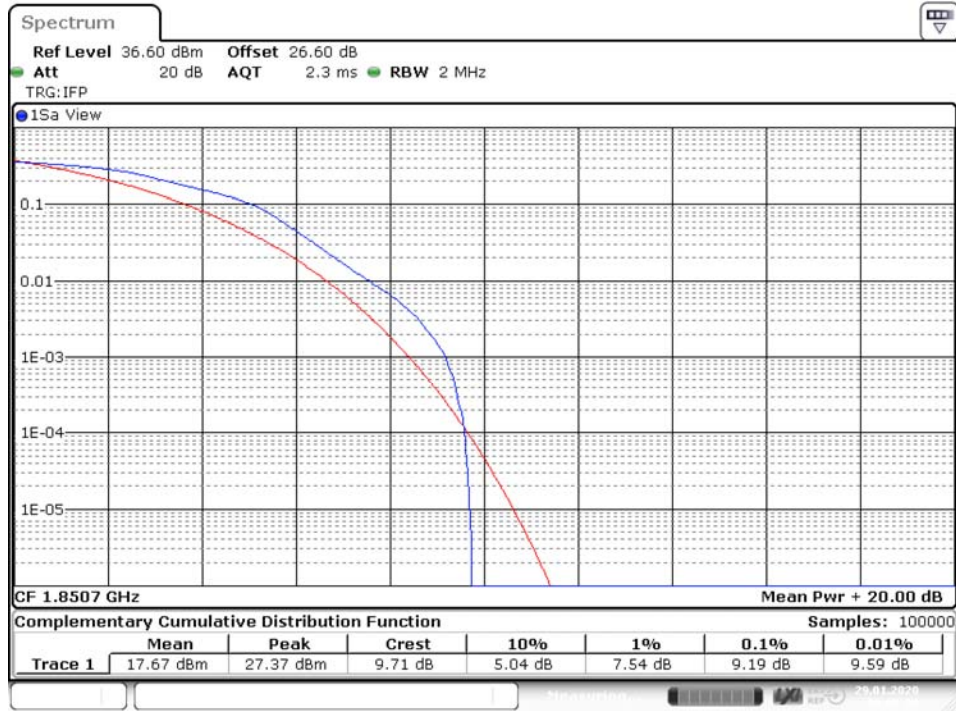

Date: 29. JAN. 2020 09:07:00

5.14.5 TEST EQUIPMENT USED

- Radio Lab

5.15 RF OUTPUT POWER

Standard **FCC PART 27 Subpart C**

The test was performed according to:
ANSI C63.26: 2015

5.15.1 TEST DESCRIPTION

This test case is intended to demonstrate compliance to the applicable RF Output power test case per § 2.1046 and RSS-GEN 6.12. The limit and the requirements come from the applicable rule part and ISSED RSS-Standard for the operating band of the cellular device.

The EUT was connected to the test setup according to the following diagram:

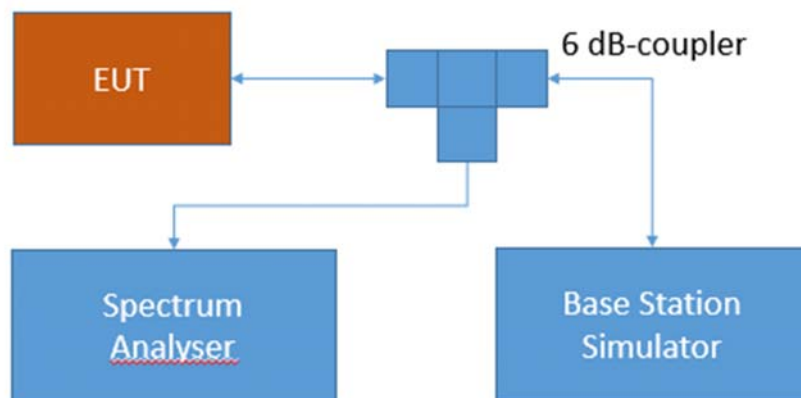

Test Setup FCC Part 22/24/27/90 Cellular;
RF Output power

The attenuation of the measuring and stimulus path are known for each measured frequency and are considered.

The Spectrum Analyser settings can be directly found in the measurement diagrams.

5.15.2 TEST REQUIREMENTS / LIMITS

FCC Part 27; Miscellaneous Wireless Communication Services

Subpart C – Technical standards

§ 27.50 - Power limits and duty cycle

Band 13:

(b) The following power limits apply to transmitters operating in the 746-758 MHz, 775-788 MHz and 805-806 MHz bands:

(10) Portable stations (hand-held devices) transmitting in the 746-757 MHz, 776-788 MHz, and 805-806 MHz bands are limited to 3 watts ERP.

RSS-130; 4.6.3 Transmitter Output Power

The e.r.p. shall not exceed 3 watts for portable equipment and indoor fixed subscriber equipment.

Band 12:

c) The following power and antenna height requirements apply to stations transmitting in the 600 MHz band and the 698-746 MHz band:

(10) Portable stations (hand-held devices) in the 600 MHz uplink band and the 698-746 MHz band, and fixed and mobile stations in the 600 MHz uplink band are limited to 3 watts ERP.

RSS-130; 4.6.3 Transmitter Output Power

The e.r.p. shall not exceed 3 watts for portable equipment and indoor fixed subscriber equipment.

Band 4/10/66:

d) The following power and antenna height requirements apply to stations transmitting in the 1695-1710 MHz, 1710-1755 MHz, 1755-1780 MHz, 1915-1920 MHz, 1995-2000 MHz, 2000-2020 MHz, 2110-2155 MHz, 2155-2180 MHz and 2180-2200 MHz bands:

(4) Fixed, mobile, and portable (hand-held) stations operating in the 1710-1755 MHz band and mobile and portable stations operating in the 1695-1710 MHz and 1755-1780 MHz bands are limited to 1 watt EIRP. Fixed stations operating in the 1710-1755 MHz band are limited to a maximum antenna height of 10 meters above ground. Mobile and portable stations operating in these bands must employ a means for limiting power to the minimum.

RSS-139; 6.5 Transmitter Output Power

The equivalent isotropically radiated power (e.i.r.p.) for mobile and portable transmitters shall not exceed one watt.

Band 17:

(c) The following power requirements apply to stations transmitting in the 600 MHz band and the 698-746 MHz band:

(10) Portable stations (hand-held devices) in the 600 MHz uplink band and the 698-746 MHz band, and fixed and mobile stations in the 600 MHz uplink band are limited to 3 watts ERP.

RSS-130; 4.6.3 Transmitter Output

The e.r.p. shall not exceed 3 watts for portable equipment and indoor fixed subscriber equipment.

Band 7:

(h) The following power limits shall apply in the BRS and EBS:

(2) Mobile and other user stations. Mobile stations are limited to 2.0 watts EIRP. All user stations are limited to 2.0 watts transmitter output power.

RSS-199; 4.4 Transmitter output power and equivalent isotropically power (e.i.r.p.)

The transmitter output power shall be measured in terms of average value.

For mobile subscriber equipment, the e.i.r.p. shall not exceed 2 W. For fixed subscriber equipment, the transmitter output power shall not exceed 2 W and the e.i.r.p. shall be limited to 40 W.

For equipment with multiple antennas, the transmitter output power and e.i.r.p shall be measured according to ANSI C63.26-2015.

Test Protocol

Ambient temperature: 24 °C
Relative humidity: 38 %

Radio Technology	Channel	Res-source Blocks	Band-width [MHz]	RMS Conducted Power (dBm)	FCC EIRP Limit (W)	IC EIRP Limit (W)	Maximum Antenna Gain FCC (dBi)	Maximum Antenna Gain IC (dBi)
CAT-M1 eFDD 4 QPSK	low	1	1.4	23.17	1	1	6.83	6.83
CAT-M1 eFDD 4 QPSK	low	3	1.4	21.91	1	1	8.09	8.09
CAT-M1 eFDD 4 QPSK	low	6	1.4	20.35	1	1	9.65	9.65
CAT-M1 eFDD 4 QPSK	mid	1	1.4	22.93	1	1	7.07	7.07
CAT-M1 eFDD 4 QPSK	mid	3	1.4	21.63	1	1	8.37	8.37
CAT-M1 eFDD 4 QPSK	mid	6	1.4	20.24	1	1	9.76	9.76
CAT-M1 eFDD 4 QPSK	high	1	1.4	23.00	1	1	7	7
CAT-M1 eFDD 4 QPSK	high	3	1.4	21.68	1	1	8.32	8.32
CAT-M1 eFDD 4 QPSK	high	6	1.4	20.61	1	1	9.39	9.39
CAT-M1 eFDD 4 16QAM	low	1	1.4	21.30	1	1	8.7	8.7
CAT-M1 eFDD 4 16QAM	low	5	1.4	20.45	1	1	9.55	9.55
CAT-M1 eFDD 4 16QAM	mid	1	1.4	21.03	1	1	8.97	8.97
CAT-M1 eFDD 4 16QAM	mid	5	1.4	20.40	1	1	9.6	9.6
CAT-M1 eFDD 4 16QAM	high	1	1.4	21.32	1	1	8.68	8.68
CAT-M1 eFDD 4 16QAM	high	5	1.4	20.77	1	1	9.23	9.23
CAT-M1 eFDD 12 QPSK	low	1	1.4	22.21	1	1	7.79	7.79
CAT-M1 eFDD 12 QPSK	low	3	1.4	20.94	1	1	9.06	9.06
CAT-M1 eFDD 12 QPSK	low	6	1.4	20.14	1	1	9.86	9.86
CAT-M1 eFDD 12 QPSK	mid	1	1.4	22.13	1	1	7.87	7.87
CAT-M1 eFDD 12 QPSK	mid	3	1.4	21.15	1	1	8.85	8.85
CAT-M1 eFDD 12 QPSK	mid	6	1.4	20.06	1	1	9.94	9.94
CAT-M1 eFDD 12 QPSK	high	1	1.4	22.12	1	1	7.88	7.88
CAT-M1 eFDD 12 QPSK	high	3	1.4	21.11	1	1	8.89	8.89
CAT-M1 eFDD 12 QPSK	high	6	1.4	20.09	1	1	9.91	9.91
CAT-M1 eFDD 12 16QAM	low	1	1.4	20.77	1	1	9.23	9.23
CAT-M1 eFDD 12 16QAM	low	5	1.4	20.35	1	1	9.65	9.65
CAT-M1 eFDD 12 16QAM	mid	1	1.4	20.66	1	1	9.34	9.34
CAT-M1 eFDD 12 16QAM	mid	5	1.4	20.31	1	1	9.69	9.69
CAT-M1 eFDD 12 16QAM	high	1	1.4	20.35	1	1	9.65	9.65
CAT-M1 eFDD 12 16QAM	high	5	1.4	20.31	1	1	9.69	9.69
CAT-M1 eFDD 13 QPSK	low	1	1.4	22.59	3	3	12.18	12.18
CAT-M1 eFDD 13 QPSK	low	3	1.4	21.47	3	3	13.3	13.3
CAT-M1 eFDD 13 QPSK	low	6	1.4	20.26	3	3	14.51	14.51
CAT-M1 eFDD 13 QPSK	mid	1	1.4	22.62	3	3	12.15	12.15
CAT-M1 eFDD 13 QPSK	mid	3	1.4	21.48	3	3	13.29	13.29
CAT-M1 eFDD 13 QPSK	mid	6	1.4	20.27	3	3	14.5	14.5
CAT-M1 eFDD 13 QPSK	high	1	1.4	22.6	3	3	12.17	12.17
CAT-M1 eFDD 13 QPSK	high	3	1.4	21.46	3	3	13.31	13.31
CAT-M1 eFDD 13 QPSK	high	6	1.4	20.17	3	3	14.6	14.6
CAT-M1 eFDD 13 16QAM	low	1	1.4	20.77	3	3	14	14
CAT-M1 eFDD 13 16QAM	low	5	1.4	20.44	3	3	14.33	14.33
CAT-M1 eFDD 13 16QAM	mid	1	1.4	20.95	3	3	13.82	13.82
CAT-M1 eFDD 13 16QAM	mid	5	1.4	20.55	3	3	14.22	14.22
CAT-M1 eFDD 13 16QAM	high	1	1.4	20.98	3	3	13.79	13.79
CAT-M1 eFDD 13 16QAM	high	5	1.4	20.51	3	3	14.26	14.26

Remark: Please see next sub-clause for the measurement plot.

5.15.3 MEASUREMENT PLOT (SHOWING THE HIGHEST VALUE, "WORST CASE")
 CAT-M1 eFDD 4 QPSK, RB = 1, Channel = low

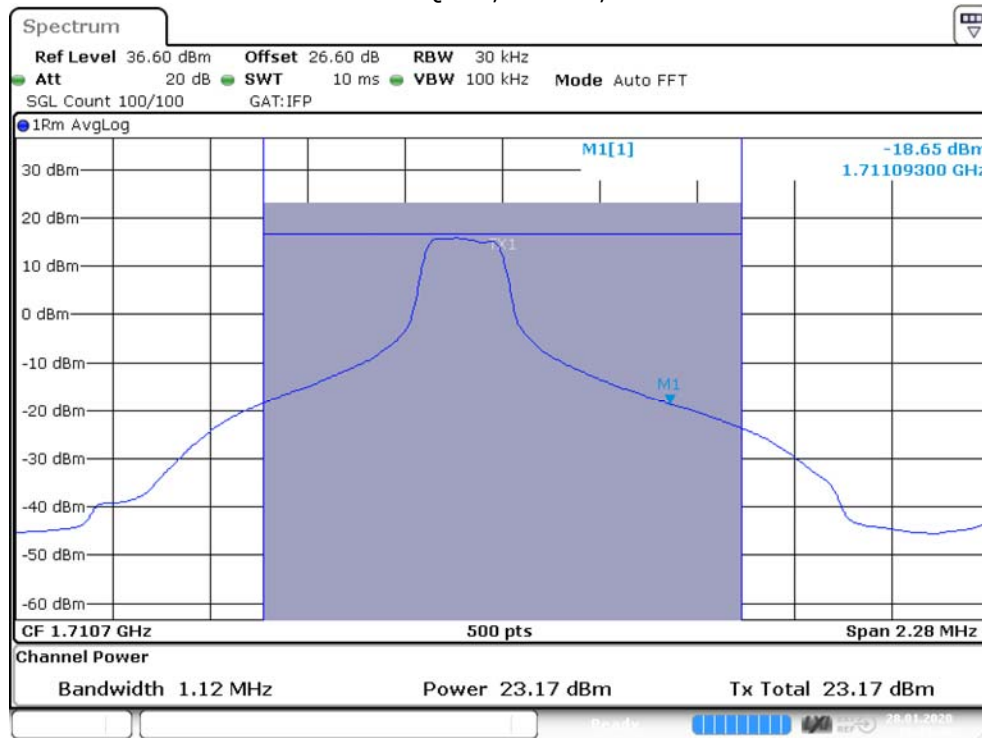

Date: 28 JAN 2020 12:28:40

5.15.4 TEST EQUIPMENT USED

- Radio Lab

5.16 FREQUENCY STABILITY

Standard **FCC PART 27 Subpart C**

The test was performed according to:
ANSI C63.26: 2015

5.16.1 TEST DESCRIPTION

This test case is intended to demonstrate compliance to the applicable frequency stability test case per § 2.1055 and RSS-GEN 6.11. The limit and the requirements come from the applicable rule part and ISED RSS-Standard for the operating band of the cellular device.

The EUT was connected to the test setup according to the following diagram:



Test Setup FCC Part 22/24/27/90 Cellular;
Frequency stability

The attenuation of the measuring / stimulus path is known for each measured frequency and are considered.

5.16.2 TEST REQUIREMENTS / LIMITS

FCC Part 27; Miscellaneous Wireless Communication Services

Subpart C – Technical standards

§ 27.54 - Frequency stability

All Bands

The frequency stability shall be sufficient to ensure that the fundamental emissions stay within the authorized bands of operation.

Band 12/13/17:

RSS-130; 4.5 Transmitter frequency stability

For equipment that is capable of transmitting numerous channels simultaneously for different applications (e.g. LTE and narrowband – Internet of Things (IoT)), the occupied bandwidth shall be the bandwidth representing the sum of the occupied bandwidths of these channels.

The frequency stability shall be sufficient to ensure that the occupied bandwidth remains within each frequency block range when tested at the temperature and supply voltage variations specified in RSS-Gen.

Band 4/10/66:

RSS-139; 6.4 Frequency Stability

The frequency stability shall be sufficient to ensure that the occupied bandwidth stays within the operating frequency block when tested to the temperature and supply voltage variations specified in RSS-Gen.

Band 7:

RSS-199; 4.3 Transmitter frequency stability

The transmitter frequency stability limit shall be determined as follows:

- a. the frequency offset shall be measured according to the procedure described in RSS-Gen and recorded.
- b. using a resolution bandwidth equal to that permitted within the 1 MHz band immediately outside the channel edge, as found in section 4.5, reference points will be selected at the unwanted emission limits, which comply with the attenuation specified in section 4.5 for the type of device under test, on the emission mask of the lowest and highest channels. The frequency at these points shall be recorded as fL and fH respectively.

The applicant shall ensure compliance with frequency stability requirements by showing that fL minus the frequency offset and fH plus the frequency offset is within the frequency range in which the equipment is designed to operate.

5.16.3 TEST PROTOCOL

CAT-M1 eFDD 4 QPSK, Channel = mid

Temp. °C	Duration min	Voltage	Limit Hz	Freq. error Average (Hz)	Freq. error Max. (Hz)	Verdict
-30	0	normal	4331.25	6	13	passed
-30	5			9	18	passed
-30	10			13	26	passed
-20	0	normal	4331.25	4	11	passed
-20	5			4	12	passed
-20	10			8	16	passed
-10	0	normal	4331.25	5	13	passed
-10	5			2	11	passed
-10	10			1	-8	passed
0	0	normal	4331.25	-9	-15	passed
0	5			-14	-22	passed
0	10			-13	-21	passed
10	0	normal	4331.25	4	11	passed
10	5			7	13	passed
10	10			8	13	passed
20	0	low	4331.25	14	21	passed
20	5			7	18	passed
20	10			7	14	passed
20	0	normal	4331.25	6	16	passed
20	5			-5	-14	passed
20	10			-3	-10	passed
20	0	high	4331.25	5	14	passed
20	5			2	7	passed
20	10			-7	-20	passed
30	0	normal	4331.25	10	21	passed
30	5			4	10	passed
30	10			15	27	passed
40	0	normal	4331.25	-8	-17	passed
40	5			-5	-12	passed
40	10			5	13	passed
50	0	normal	4331.25	9	12	passed
50	5			7	10	passed
50	10			12	16	passed

CAT-M1 eFDD 12 QPSK, Channel = mid

Temp. °C	Duration min	Voltage	Limit Hz	Freq. error Average (Hz)	Freq. error Max. (Hz)	Verdict
-30	0	normal	1955	-7	11	passed
-30	5			-8	13	passed
-30	10			-4	-14	passed
-20	0	normal	1955	-3	-16	passed
-20	5			-6	8	passed
-20	10			-7	-19	passed
-10	0	normal	1955	-11	-12	passed
-10	5			-7	20	passed
-10	10			-4	-14	passed
0	0	normal	1955	-8	-8	passed
0	5			-3	-14	passed
0	10			-10	17	passed
10	0	normal	1955	-6	12	passed
10	5			-4	13	passed
10	10			-3	19	passed
20	0	low	1955	-7	4	passed
20	5			-13	8	passed
20	10			-11	-21	passed
20	0	normal	1955	-9	-9	passed
20	5			-10	-13	passed
20	10			-4	-9	passed
20	0	high	1955	-8	18	passed
20	5			-13	16	passed
20	10			-10	14	passed
30	0	normal	1955	-8	16	passed
30	5			-4	11	passed
30	10			-8	13	passed
40	0	normal	1955	-5	-16	passed
40	5			-7	-10	passed
40	10			-2	23	passed
50	0	normal	1955	-5	14	passed
50	5			-11	-16	passed
50	10			-9	-15	passed

CAT-M1 eFDD 13 QPSK, Channel = mid

Temp. °C	Duration min	Voltage	Limit Hz	Freq. error Average (Hz)	Freq. error Max. (Hz)	Verdict
-30	0	normal	1955	2	12	passed
-30	5			3	16	passed
-30	10			-1	11	passed
-20	0	normal	1955	-6	13	passed
-20	5			-4	17	passed
-20	10			3	9	passed
-10	0	normal	1955	-8	14	passed
-10	5			6	8	passed
-10	10			-3	11	passed
0	0	normal	1955	7	13	passed
0	5			3	18	passed
0	10			1	21	passed
10	0	normal	1955	-7	16	passed
10	5			-6	14	passed
10	10			4	23	passed
20	0	low	1955	11	15	passed
20	5			-2	10	passed
20	10			-3	18	passed
20	0	normal	1955	-9	14	passed
20	5			-8	16	passed
20	10			-10	15	passed
20	0	high	1955	4	17	passed
20	5			4	17	passed
20	10			5	21	passed
30	0	normal	1955	-6	13	passed
30	5			-7	18	passed
30	10			10	16	passed
40	0	normal	1955	13	15	passed
40	5			7	21	passed
40	10			11	19	passed
50	0	normal	1955	-7	13	passed
50	5			-6	10	passed
50	10			9	17	passed

5.16.4 TEST EQUIPMENT USED

- Radio Lab

5.17 SPURIOUS EMISSIONS AT ANTENNA TERMINALS

Standard **FCC PART 27 Subpart C**

The test was performed according to:
ANSI C63.26: 2015

5.17.1 TEST DESCRIPTION

This test case is intended to demonstrate compliance to the applicable conducted spurious emission test case per § 2.1051 and RSS-GEN 6.13. The limit comes from the applicable rule part and ISED RSS-Standard for the operating band of the cellular device.

The EUT was connected to the test setup according to the following diagram:

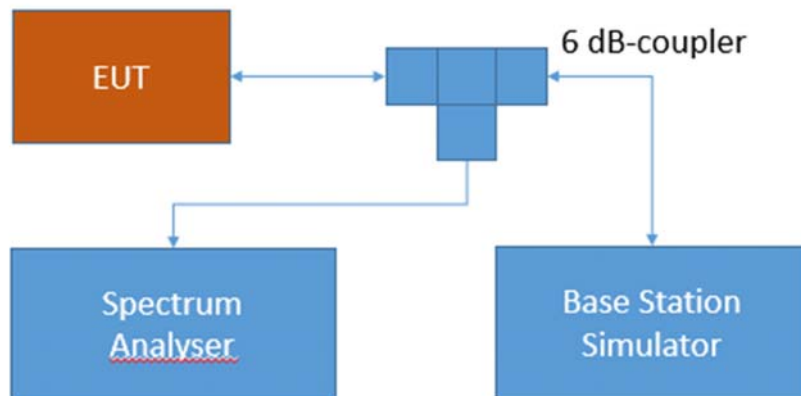

Test Setup FCC Part 22/24/27/90 Cellular;
Spurious Emissions at antenna terminal

The attenuation of the measuring and stimulus path are known for each measured frequency and are considered.

The Spectrum Analyser settings can be directly found in the measurement diagrams.

5.17.2 TEST REQUIREMENTS / LIMITS

FCC Part 2.1051; Measurement required: Spurious emissions at antenna terminal:

The radio frequency voltage or powers generated within the equipment and appearing on a spurious frequency shall be checked at the equipment output terminals when properly loaded with a suitable artificial antenna. Curves or equivalent data shall show the magnitude of each harmonic and other spurious emission that can be detected when the equipment is operated under the conditions specified in §2.1049 as appropriate. The magnitude of spurious emissions which are attenuated more than 20 dB below the permissible value need not be specified.

FCC Part 27; Miscellaneous Wireless Communication Services

Subpart C – Technical standards

§27.53 – Emission limits

Band 13

(c) For operations in the 746-758 MHz band and the 776-788 MHz band, the power of any emission outside the licensee's frequency band(s) of operation shall be attenuated below the transmitter power (P) within the licensed band(s) of operation, measured in watts, in accordance with the following:

(1) On any frequency outside the 746-758 MHz band, the power of any emission shall be attenuated outside the band below the transmitter power (P) by at least $43 + 10 \log (P)$ dB;

(2) On any frequency outside the 776-788 MHz band, the power of any emission shall be attenuated outside the band below the transmitter power (P) by at least $43 + 10 \log (P)$ dB;

(3) On all frequencies between 763-775 MHz and 793-805 MHz, by a factor not less than $76 + 10 \log (P)$ dB in a 6.25 kHz band segment, for base and fixed stations;

(4) On all frequencies between 763-775 MHz and 793-805 MHz, by a factor not less than $65 + 10 \log (P)$ dB in a 6.25 kHz band segment, for mobile and portable stations;

(5) Compliance with the provisions of paragraphs (c)(1) and (c)(2) of this section is based on the use of measurement instrumentation employing a resolution bandwidth of 100 kHz or greater. However, in the 100 kHz bands immediately outside and adjacent to the frequency block, a resolution bandwidth of at least 30 kHz may be employed;

(f) For operations in the 746-758 MHz, 775-788 MHz, and 805-806 MHz bands, emissions in the band 1559-1610 MHz shall be limited to -70 dBW/MHz equivalent isotropically radiated power (EIRP) for wideband signals, and -80 dBW EIRP for discrete emissions of less than 700 Hz bandwidth. For the purpose of equipment authorization, a transmitter shall be tested with an antenna that is representative of the type that will be used with the equipment in normal operation.

(6) Compliance with the provisions of paragraphs (c)(3) and (c)(4) of this section is based on the use of measurement instrumentation such that the reading taken with any resolution bandwidth setting should be adjusted to indicate spectral energy in a 6.25 kHz segment.

RSS-130; 4.7.1 General unwanted emissions limits

The unwanted emissions in any 100 kHz bandwidth on any frequency outside the low frequency edge and the high frequency edge of each frequency block range(s), shall be attenuated below the transmitter power, P (dBW), by at least $43 + 10 \log_{10} p$ (watts), dB. However, in the 100 kHz band immediately outside of the equipment's frequency block range, a resolution bandwidth of 30 kHz may be employed.

RSS-130; 4.7.2 Additional unwanted emissions limits

In addition to the limit outlined in section 4.7.1 above, equipment operating in the frequency bands 746-756 MHz and 777-787 MHz shall also comply with the following restrictions:

- a. the power of any unwanted emissions in any 6.25 kHz bandwidth for all frequencies between 763-775 MHz and 793-806 MHz shall be attenuated below the transmitter power, P (dBW), by at least:
 - i. $76 + 10 \log_{10} p$ (watts), dB, for base and fixed equipment and
 - ii. $65 + 10 \log_{10} p$ (watts), dB, for mobile and portable equipment
- b. the e.i.r.p. in the band 1559-1610 MHz shall not exceed -70 dBW/MHz for wideband signal and -80 dBW for discrete emission with bandwidth less than 700 Hz.

Band 12:

(g) For operations in the 600 MHz band and the 698-746 MHz band, the power of any emission outside a licensee's frequency band(s) of operation shall be attenuated below the transmitter power (P) within the licensed band(s) of operation, measured in watts, by at least $43 + 10 \log(P)$ dB. Compliance with this provision is based on the use of measurement instrumentation employing a resolution bandwidth of 100 kilohertz or greater. However, in the 100 kilohertz bands immediately outside and adjacent to a licensee's frequency block, a resolution bandwidth of at least 30 kHz may be employed.

RSS-130; 4.7.1 General unwanted emissions limits

The unwanted emissions in any 100 kHz bandwidth on any frequency outside the low frequency edge and the high frequency edge of each frequency block range(s), shall be attenuated below the transmitter power, P (dBW), by at least $43 + 10 \log_{10} p$ (watts), dB. However, in the 100 kHz band immediately outside of the equipment's frequency block range, a resolution bandwidth of 30 kHz may be employed.

RSS-130; 4.7.2 Additional unwanted emissions limits

In addition to the limit outlined in section 4.7.1 above, equipment operating in the frequency bands 746-756 MHz and 777-787 MHz shall also comply with the following restrictions:

- a. the power of any unwanted emissions in any 6.25 kHz bandwidth for all frequencies between 763-775 MHz and 793-806 MHz shall be attenuated below the transmitter power, P (dBW), by at least:
 - i. $76 + 10 \log_{10} p$ (watts), dB, for base and fixed equipment and
 - ii. $65 + 10 \log_{10} p$ (watts), dB, for mobile and portable equipment
- b. the e.i.r.p. in the band 1559-1610 MHz shall not exceed -70 dBW/MHz for wideband signal and -80 dBW for discrete emission with bandwidth less than 700 Hz.

Band 4/10/66:

(h) *AWS emission limits— (1) General protection levels.* Except as otherwise specified below, for operations in the 1695-1710 MHz, 1710-1755 MHz, 1755-1780 MHz, 1915-1920 MHz, 1995-2000 MHz, 2000-2020 MHz, 2110-2155 MHz, 2155-2180 MHz, and 2180-2200 bands, the power of any emission outside a licensee's frequency block shall be attenuated below the transmitter power (P) in watts by at least $43 + 10 \log_{10}(P)$ dB.

RSS-139; 6.6 Transmitter Unwanted Emissions

Equipment shall comply with the limits in (i) and (ii) below.

- i. In the first 1.0 MHz bands immediately outside and adjacent to the equipment's smallest operating frequency block, which can contain the equipment's occupied bandwidth, the emission power per any 1% of the emission bandwidth shall be attenuated below the transmitter output power P (in dBW) by at least $43 + 10 \log_{10} p$ (watts) dB.
- ii. After the first 1.0 MHz outside the equipment's smallest operating frequency block, which can contain the equipment's occupied bandwidth, the emission power in any 1 MHz bandwidth shall be attenuated below the transmitter output power P (in dBW) by at least $43 + 10 \log_{10} p$ (watts) dB.

Band 7:

(m) For BRS and EBS stations, the power of any emissions outside the licensee's frequency bands of operation shall be attenuated below the transmitter power (P) measured in watts in accordance with the standards below. If a licensee has multiple contiguous channels, out-of-band emissions shall be measured from the upper and lower edges of the contiguous channels.

(4) For mobile digital stations, the attenuation factor shall be not less than $40 + 10 \log (P)$ dB on all frequencies between the channel edge and 5 megahertz from the channel edge, $43 + 10 \log (P)$ dB on all frequencies between 5 megahertz and X megahertz from the channel edge, and $55 + 10 \log (P)$ dB on all frequencies more than X megahertz from the channel edge, where X is the greater of 6 megahertz or the actual emission bandwidth as defined in paragraph (m)(6) of this section. In addition, the attenuation factor shall not be less than $43 + 10 \log (P)$ dB on all frequencies between 2490.5 MHz and 2496 MHz and $55 + 10 \log (P)$ dB at or below 2490.5 MHz. Mobile Satellite Service licensees operating on frequencies below 2495 MHz may also submit a documented interference complaint against BRS licensees operating on channel BRS Channel 1 on the same terms and conditions as adjacent channel BRS or EBS licensees.

RSS-199; 4.5 Transmitter unwanted emissions

In the 1 MHz band immediately outside and adjacent to the channel edge, the unwanted emission power shall be measured with a resolution bandwidth of at least 1% of the occupied bandwidth for base station and fixed subscriber equipment, and 2% for mobile subscriber equipment. Beyond the 1 MHz band, a resolution bandwidth of 1 MHz shall be used. A narrower resolution bandwidth can be used, provided that the measured power is integrated over the full required measurement bandwidth of 1 MHz, or 1% or 2% of the occupied bandwidth, as applicable.

Equipment shall comply with the following unwanted emission limits:

b. for mobile subscriber equipment, the power of any unwanted emissions measured as above shall be attenuated (in dB) below the transmitter power, P (dBW), by at least:

$40 + 10 \log_{10} p$ from the channel edges to 5 MHz away

$43 + 10 \log_{10} p$ between 5 MHz and X MHz from the channel edges, and

$55 + 10 \log_{10} p$ at X MHz and beyond from the channel edges

In addition, the attenuation shall not be less than $43 + 10 \log_{10} p$ on all frequencies between 2490.5 MHz and 2496 MHz, and $55 + 10 \log_{10} p$ at or below 2490.5 MHz.

In (b), p is the transmitter power measured in watts and X is 6 MHz or the equipment occupied bandwidth, whichever is greater.

Band 17:

(g) For operations in the 600 MHz band and the 698-746 MHz band, the power of any emission outside a licensee's frequency band(s) of operation shall be attenuated below the transmitter power (P) within the licensed band(s) of operation, measured in watts, by at least $43 + 10 \log(P)$ dB. Compliance with this provision is based on the use of measurement instrumentation employing a resolution bandwidth of 100 kilohertz or greater. However, in the 100 kilohertz bands immediately outside and adjacent to a licensee's frequency block, a resolution bandwidth of at least 30 kHz may be employed.

RSS-130; 4.7.1 General unwanted emissions limits

The unwanted emissions in any 100 kHz bandwidth on any frequency outside the low frequency edge and the high frequency edge of each frequency block range(s), shall be attenuated below the transmitter power, P (dBW), by at least $43 + 10 \log_{10} p$ (watts), dB. However, in the 100 kHz band immediately outside of the equipment's frequency block range, a resolution bandwidth of 30 kHz may be employed.

RSS-130; 4.7.2 Additional unwanted emissions limits

In addition to the limit outlined in section 4.7.1 above, equipment operating in the frequency bands 746-756 MHz and 777-787 MHz shall also comply with the following restrictions:

- a. the power of any unwanted emissions in any 6.25 kHz bandwidth for all frequencies between 763-775 MHz and 793-806 MHz shall be attenuated below the transmitter power, P (dBW), by at least:
 - i. $76 + 10 \log_{10} p$ (watts), dB, for base and fixed equipment and
 - ii. $65 + 10 \log_{10} p$ (watts), dB, for mobile and portable equipment
- b. the e.i.r.p. in the band 1559-1610 MHz shall not exceed -70 dBW/MHz for wideband signal and -80 dBW for discrete emission with bandwidth less than 700 Hz.

5.17.3 TEST PROTOCOL

Ambient temperature: 24 °C
 Relative humidity: 38 %

Radio Technology	Channel	Detector	Trace	Resolution Bandwidth /kHz	Frequency /MHz	Peak Value /dBm	Limit /dBm	Margin to Limit /dB
eFDD4	low	rms	maxhold	5	1709.9	-24.35	-17.5	6.85
eFDD4	mid	rms	maxhold	-	-	-	-13	>20
eFDD4	high	rms	maxhold	5	1755	-24.3	-17.5	6.8

Radio Technology	Channel	Detector	Trace	Resolution Bandwidth /kHz	Frequency /MHz	Peak Value /dBm	Limit /dBm	Margin to Limit /dB
eFDD12	low	rms	maxhold	-	-	-	-13	>20
eFDD12	mid	rms	maxhold	-	-	-	-13	>20
eFDD12	high	rms	maxhold	-	-	-	-13	>20

Radio Technology	Channel	Detector	Trace	Resolution Bandwidth /kHz	Frequency /MHz	Peak Value /dBm	Limit /dBm	Margin to Limit /dB
eFDD13	low	rms	maxhold	-	-	-	-13	>20
eFDD13	mid	rms	maxhold	-	-	-	-13	>20
eFDD13	high	rms	maxhold	-	-	-	-13	>20

Remark: Please see next sub-clause for the measurement plot.

5.17.4 MEASUREMENT PLOT (SHOWING THE HIGHEST VALUE, "WORST CASE")
CAT-M1 eFDD4 QPSK, RB = 1, Channel = high

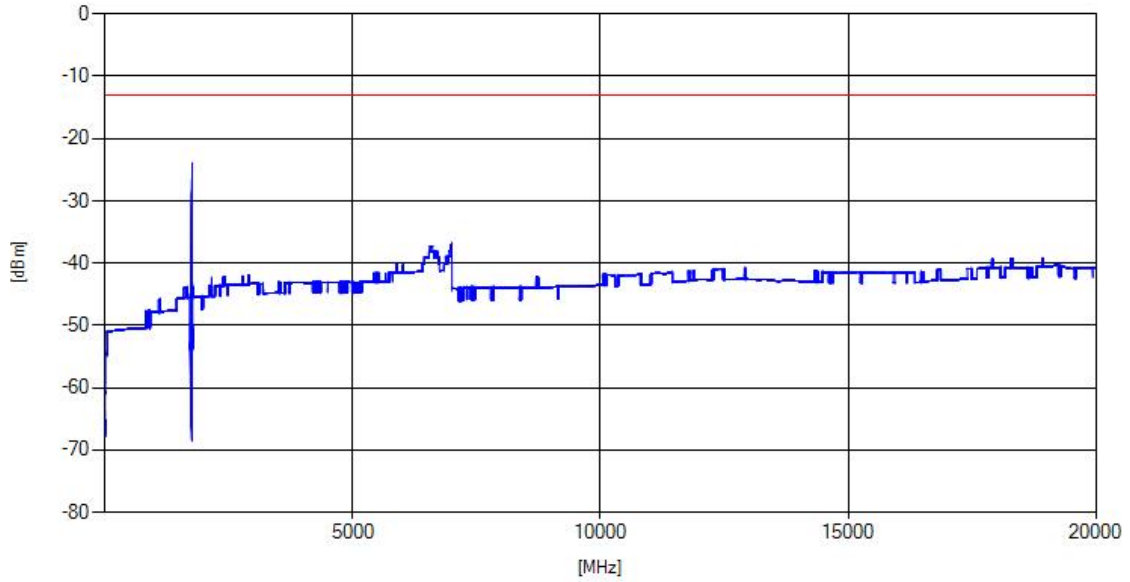

5.17.5 TEST EQUIPMENT USED

- Radio Lab

5.18 FIELD STRENGTH OF SPURIOUS RADIATION

Standard **FCC PART 27 Subpart C**

The test was performed according to:
ANSI C63.26: 2015

5.18.1 TEST DESCRIPTION

This test case is intended to demonstrate compliance to the applicable radiated spurious emission measurements per § 2.1053 and RSS-GEN 6.13. The limit and requirements come from the applicable rule part and ISSED RSS-Standard for the operating band of the cellular device.

The EUT was connected to the test setup according to the following diagram:

Frequency Range: 30 MHz – 1 GHz:

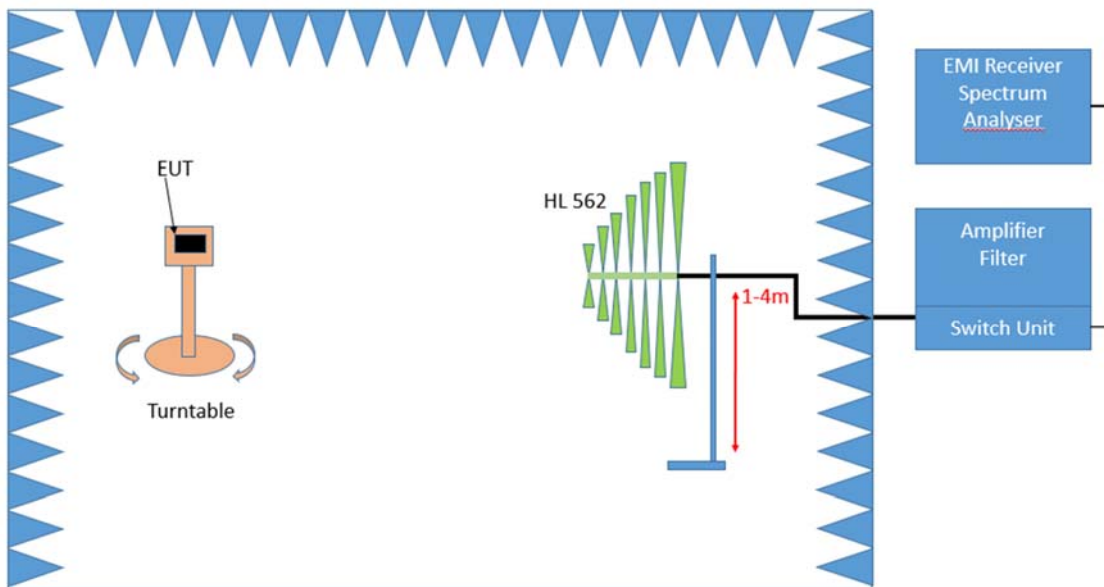

Test Setup; Spurious Emission Radiated (SAC), 30 MHz- 1GHz

Frequency Range: 1 GHz – 26.5 GHz

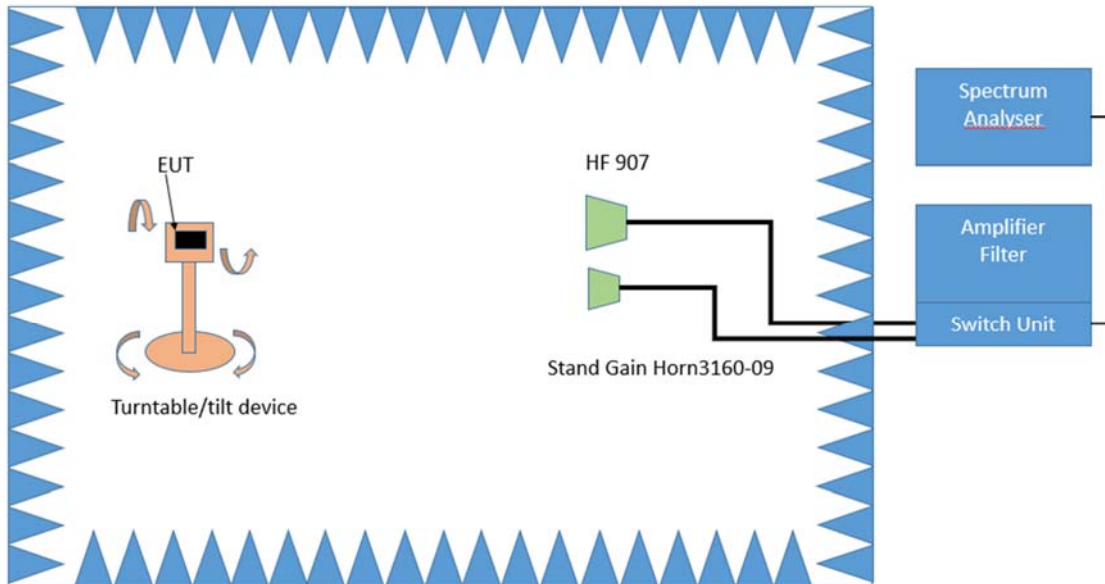

Test Setup; Spurious Emission Radiated (FAC), 1 GHz-26.5 GHz

The test set-up was made in accordance to the general provisions of ANSI C63.26 in a typical installation configuration. The Equipment Under Test (EUT) was set up on a non-conductive table 1.0 x 2.0 m² in the semi-anechoic chamber. The influence of the EUT support table that is used between 30–1000 MHz was evaluated.

The measurement procedure is implemented into the EMI test software EMC32 from R&S. Exploratory tests are performed at 3 orthogonal axes to determine the worst-case orientation of a body-worn or handheld EUT. The final test on all kind of EUTs is also performed at 3 axes. A pre-check is performed while the EUT is powered from a DC power source.

1. Measurement above 30 MHz and up to 1 GHz

Step 1: Preliminary scan

This is a preliminary test to identify the highest amplitudes relative to the limit.

Settings for step 1:

- Antenna distance: 3 m
- Detector: Peak
- RBW: 100 kHz
- VBW: 300 kHz
- Sweep time: coupled
- Turntable angle range: -180° to 90°
- Turntable step size: 90°
- Height variation range: 1 – 3 m
- Height variation step size: 2 m
- Polarisation: Horizontal + Vertical

Intention of this step is, to determine the radiated EMI-profile of the EUT. Afterwards the relevant emissions for the final measurement are identified.

Step 2: Adjustment measurement

In this step the accuracy of the turntable azimuth and antenna height will be improved. This is necessary to find out the maximum value of every frequency.

For each frequency, which was determined the turntable azimuth and antenna height will be adjusted. The turntable azimuth will slowly vary by $\pm 45^\circ$ around this value. During this action, the value of emission is continuously measured. The turntable azimuth at the highest emission will be recorded and adjusted. In this position, the antenna height will also slowly vary by \pm

100 cm around the antenna height determined. During this action, the value of emission is also continuously measured. The antenna height of the highest emission will also be recorded and adjusted.

- Detector: Peak
- Measured frequencies: in step 1 determined frequencies
- RBW: 100 kHz
- VBW: 300 kHz
- Sweep time: coupled
- Turntable angle range: $\pm 45^\circ$ around the determined value
- Height variation range: ± 100 cm around the determined value
- Antenna Polarisation: max. value determined in step 1

Step 3: Final measurement with RMS detector

With the settings determined in step 3, the final measurement will be performed:

EMI receiver settings for step 4:

- Detector: RMQ
- Measured frequencies: in step 1 determined frequencies
- RBW: 100 kHz
- VBW: 300 kHz
- Sweep time: 1 s

After the measurement a plot will be generated which contains a diagram with the results of the preliminary scan and a chart with the frequencies and values of the results of the final measurement.

3. Measurement above 1 GHz

The following modifications apply to the measurement procedure for the frequency range above 1 GHz:

Step 1:

The Equipment Under Test (EUT) was set up on a non-conductive support (tilt device) at 1.5 m height in the fully-anechoic chamber.

All steps were performed with one height (1.5 m) of the receiving antenna only.

The EUT is turned during the preliminary measurement across the elevation axis, with a step size of 45° .

The turn table step size (azimuth angle) for the preliminary measurement is 45° .

- Antenna distance: 3 m
- Detector: Peak
- RBW: 1 MHz
- VBW: 3 MHz
- Sweep time: coupled
- Turntable angle range: -180° to 135°
- Turntable step size: 45°
- Polarisation: Horizontal + Vertical

Step 2:

Due to the fact, that in this frequency range the test is performed in a fully anechoic room, the height scan of the receiving antenna in step 2 is omitted. Instead of this, a maximum search with a step size $\pm 45^\circ$ for the elevation axis is performed.

The turn table azimuth will slowly vary by $\pm 22.5^\circ$.

The elevation angle will slowly vary by $\pm 45^\circ$

EMI receiver settings (for all steps):

- Detector: Peak,
- RBW: 1 MHz
- VBW: 3 MHz
- Sweep time: coupled

Step 3:

Spectrum analyser settings for step 3:

- Detector: RMS
- Measured frequencies: in step 1 determined frequencies
- RBW: 1 MHz
- VBW: 3 MHz
- Sweep Time: 1 s

5.18.2 TEST REQUIREMENTS / LIMITS

FCC Part 2.1053; Measurement required: Field strength of spurious radiation:

Measurements shall be made to detect spurious emissions that may be radiated directly from the cabinet, control circuits, power leads, or intermediate circuit elements under normal conditions of installation and operation. Curves or equivalent data shall be supplied showing the magnitude of each harmonic and other spurious emission. For this test, single sideband, independent sideband, and controlled carrier transmitters shall be modulated under the conditions specified in paragraph (c) of §2.1049, as appropriate.

FCC Part 27; Miscellaneous Wireless Communication Services

Subpart C – Technical standards

§27.53 – Emission limits

Band 13

(c) For operations in the 746-758 MHz band and the 776-788 MHz band, the power of any emission outside the licensee's frequency band(s) of operation shall be attenuated below the transmitter power (P) within the licensed band(s) of operation, measured in watts, in accordance with the following:

(1) On any frequency outside the 746-758 MHz band, the power of any emission shall be attenuated outside the band below the transmitter power (P) by at least $43 + 10 \log (P)$ dB;

(2) On any frequency outside the 776-788 MHz band, the power of any emission shall be attenuated outside the band below the transmitter power (P) by at least $43 + 10 \log (P)$ dB;

(3) On all frequencies between 763-775 MHz and 793-805 MHz, by a factor not less than $76 + 10 \log (P)$ dB in a 6.25 kHz band segment, for base and fixed stations;

(4) On all frequencies between 763-775 MHz and 793-805 MHz, by a factor not less than $65 + 10 \log (P)$ dB in a 6.25 kHz band segment, for mobile and portable stations;

(5) Compliance with the provisions of paragraphs (c)(1) and (c)(2) of this section is based on the use of measurement instrumentation employing a resolution bandwidth of 100 kHz or greater. However, in the 100 kHz bands immediately outside and adjacent to the frequency block, a resolution bandwidth of at least 30 kHz may be employed;

(f) For operations in the 746-758 MHz, 776-788 MHz, and 805-806 MHz bands, emissions in the band 1559-1610 MHz shall be limited to -70 dBW/MHz equivalent isotropically radiated power (EIRP) for wideband signals, and -80 dBW EIRP for discrete emissions of less than 700 Hz bandwidth. For the purpose of equipment authorization, a transmitter shall be tested with an antenna that is representative of the type that will be used with the equipment in normal operation.

(6) Compliance with the provisions of paragraphs (c)(3) and (c)(4) of this section is based on the use of measurement instrumentation such that the reading taken with any resolution bandwidth setting should be adjusted to indicate spectral energy in a 6.25 kHz segment.

RSS-130; 4.7.1 General unwanted emissions limits

The unwanted emissions in any 100 kHz bandwidth on any frequency outside the low frequency edge and the high frequency edge of each frequency block range(s), shall be attenuated below the transmitter power, P (dBW), by at least $43 + 10 \log_{10} p$ (watts), dB. However, in the 100 kHz band immediately outside of the equipment's frequency block range, a resolution bandwidth of 30 kHz may be employed.

RSS-130; 4.7.2 Additional unwanted emissions limits

In addition to the limit outlined in section 4.7.1 above, equipment operating in the frequency bands 746-756 MHz and 777-787 MHz shall also comply with the following restrictions:

- a. the power of any unwanted emissions in any 6.25 kHz bandwidth for all frequencies between 763-775 MHz and 793-806 MHz shall be attenuated below the transmitter power, P (dBW), by at least:
 - i. $76 + 10 \log_{10} p$ (watts), dB, for base and fixed equipment and
 - ii. $65 + 10 \log_{10} p$ (watts), dB, for mobile and portable equipment
- b. the e.i.r.p. in the band 1559-1610 MHz shall not exceed -70 dBW/MHz for wideband signal and -80 dBW for discrete emission with bandwidth less than 700 Hz.

Band 12:

(g) For operations in the 600 MHz band and the 698-746 MHz band, the power of any emission outside a licensee's frequency band(s) of operation shall be attenuated below the transmitter power (P) within the licensed band(s) of operation, measured in watts, by at least $43 + 10 \log (P)$ dB. Compliance with this provision is based on the use of measurement instrumentation employing a resolution bandwidth of 100 kilohertz or greater. However, in the 100 kilohertz bands immediately outside and adjacent to a licensee's frequency block, a resolution bandwidth of at least 30 kHz may be employed.

RSS-130; 4.7.1 General unwanted emissions limits

The unwanted emissions in any 100 kHz bandwidth on any frequency outside the low frequency edge and the high frequency edge of each frequency block range(s), shall be attenuated below the transmitter power, P (dBW), by at least $43 + 10 \log_{10} p$ (watts), dB. However, in the 100 kHz band immediately outside of the equipment's frequency block range, a resolution bandwidth of 30 kHz may be employed.

RSS-130; 4.7.2 Additional unwanted emissions limits

In addition to the limit outlined in section 4.7.1 above, equipment operating in the frequency bands 746-756 MHz and 777-787 MHz shall also comply with the following restrictions:

- a. the power of any unwanted emissions in any 6.25 kHz bandwidth for all frequencies between 763-775 MHz and 793-806 MHz shall be attenuated below the transmitter power, P (dBW), by at least:
 - i. $76 + 10 \log_{10} p$ (watts), dB, for base and fixed equipment and
 - ii. $65 + 10 \log_{10} p$ (watts), dB, for mobile and portable equipment
- b. the e.i.r.p. in the band 1559-1610 MHz shall not exceed -70 dBW/MHz for wideband signal and -80 dBW for discrete emission with bandwidth less than 700 Hz.

Band 4/10/66:

(h) *AWS emission limits—(1) General protection levels.* Except as otherwise specified below, for operations in the 1695-1710 MHz, 1710-1755 MHz, 1755-1780 MHz, 1915-1920 MHz, 1995-2000 MHz, 2000-2020 MHz, 2110-2155 MHz, 2155-2180 MHz, and 2180-2200 bands, the power of any emission outside a licensee's frequency block shall be attenuated below the transmitter power (P) in watts by at least $43 + 10 \log_{10} (P)$ dB.

RSS-139; 6.6 Transmitter Unwanted Emissions

Equipment shall comply with the limits in (i) and (ii) below.

- i. In the first 1.0 MHz bands immediately outside and adjacent to the equipment's smallest operating frequency block, which can contain the equipment's occupied bandwidth, the emission power per any 1% of the emission bandwidth shall be attenuated below the transmitter output power P (in dBW) by at least $43 + 10 \log_{10} p$ (watts) dB.
- ii. After the first 1.0 MHz outside the equipment's smallest operating frequency block, which can contain the equipment's occupied bandwidth, the emission power in any 1 MHz bandwidth shall be attenuated below the transmitter output power P (in dBW) by at least $43 + 10 \log_{10} p$ (watts) dB.

Band 7:

(m) For BRS and EBS stations, the power of any emissions outside the licensee's frequency bands of operation shall be attenuated below the transmitter power (P) measured in watts in accordance with the standards below. If a licensee has multiple contiguous channels, out-of-band emissions shall be measured from the upper and lower edges of the contiguous channels.

(4) For mobile digital stations, the attenuation factor shall be not less than $40 + 10 \log (P)$ dB on all frequencies between the channel edge and 5 megahertz from the channel edge, $43 + 10 \log (P)$ dB on all frequencies between 5 megahertz and X megahertz from the channel edge, and $55 + 10 \log (P)$ dB on all frequencies more than X megahertz from the channel edge, where X is the greater of 6 megahertz or the actual emission bandwidth as defined in paragraph (m)(6) of this section. In addition, the attenuation factor shall not be less than $43 + 10 \log (P)$ dB on all frequencies between 2490.5 MHz and 2496 MHz and $55 + 10 \log (P)$ dB at or below 2490.5 MHz. Mobile Satellite Service licensees operating on frequencies below 2495 MHz may also submit a documented interference complaint against BRS licensees operating on channel BRS Channel 1 on the same terms and conditions as adjacent channel BRS or EBS licensees.

RSS-199; 4.5 Transmitter unwanted emissions

In the 1 MHz band immediately outside and adjacent to the channel edge, the unwanted emission power shall be measured with a resolution bandwidth of at least 1% of the occupied bandwidth for base station and fixed subscriber equipment, and 2% for mobile subscriber equipment. Beyond the 1 MHz band, a resolution bandwidth of 1 MHz shall be used. A narrower resolution bandwidth can be used, provided that the measured power is integrated over the full required measurement bandwidth of 1 MHz, or 1% or 2% of the occupied bandwidth, as applicable.

Equipment shall comply with the following unwanted emission limits:

b. for mobile subscriber equipment, the power of any unwanted emissions measured as above shall be attenuated (in dB) below the transmitter power, P (dBW), by at least:

$40 + 10 \log_{10} p$ from the channel edges to 5 MHz away

$43 + 10 \log_{10} p$ between 5 MHz and X MHz from the channel edges, and

$55 + 10 \log_{10} p$ at X MHz and beyond from the channel edges

In addition, the attenuation shall not be less than $43 + 10 \log_{10} p$ on all frequencies between 2490.5 MHz and 2496 MHz, and $55 + 10 \log_{10} p$ at or below 2490.5 MHz.

In (b), p is the transmitter power measured in watts and X is 6 MHz or the equipment occupied bandwidth, whichever is greater.

Band 17:

(g) For operations in the 600 MHz band and the 698-746 MHz band, the power of any emission outside a licensee's frequency band(s) of operation shall be attenuated below the transmitter power (P) within the licensed band(s) of operation, measured in watts, by at least $43 + 10 \log(P)$ dB. Compliance with this provision is based on the use of measurement instrumentation employing a resolution bandwidth of 100 kilohertz or greater. However, in the 100 kilohertz bands immediately outside and adjacent to a licensee's frequency block, a resolution bandwidth of at least 30 kHz may be employed.

RSS-130; 4.7.1 General unwanted emissions limits

The unwanted emissions in any 100 kHz bandwidth on any frequency outside the low frequency edge and the high frequency edge of each frequency block range(s), shall be below the transmitter power, P (dBW), by at least $43 + 10 \log_{10} p$ (watts), dB. However, in the 100 kHz band immediately outside of the equipment's frequency block range, a resolution bandwidth of 30 kHz may be employed.

RSS-130; 4.7.2 Additional unwanted emissions limits

In attenuated addition to the limit outlined in section 4.7.1 above, equipment operating in the frequency bands 746-756 MHz and 777-787 MHz shall also comply with the following restrictions:

- a. the power of any unwanted emissions in any 6.25 kHz bandwidth for all frequencies between 763-775 MHz and 793-806 MHz shall be attenuated below the transmitter power, P (dBW), by at least:
 - i. $76 + 10 \log_{10} p$ (watts), dB, for base and fixed equipment and
 - ii. $65 + 10 \log_{10} p$ (watts), dB, for mobile and portable equipment
- b. the e.i.r.p. in the band 1559-1610 MHz shall not exceed -70 dBW/MHz for wideband signal and -80 dBW for discrete emission with bandwidth less than 700 Hz.

5.18.3 TEST PROTOCOL

Ambient temperature: 24 °C
Relative humidity: 38 %

Radio Technology	Channel	Detector	Trace	Resolution Bandwidth /kHz	Frequency /MHz	Peak Value /dBm	Limit /dBm	Margin to Limit /dB
eFDD4	low	rms	maxhold	-	-	-	-13	>20
eFDD4	mid	rms	maxhold	-	-	-	-13	>20
eFDD4	high	rms	maxhold	-	-	-	-13	>20

Radio Technology	Channel	Detector	Trace	Resolution Bandwidth /kHz	Frequency /MHz	Peak Value /dBm	Limit /dBm	Margin to Limit /dB
eFDD12	low	rms	maxhold	-	-	-	-13	>20
eFDD12	mid	rms	maxhold	-	-	-	-13	>20
eFDD12	high	rms	maxhold	-	-	-	-13	>20

Radio Technology	Channel	Detector	Trace	Resolution Bandwidth /kHz	Frequency /MHz	Peak Value /dBm	Limit /dBm	Margin to Limit /dB
eFDD13	low	rms	maxhold	1000	1559.1	-43.7	-40	3.7
eFDD13	mid	rms	maxhold	1000	1563.8	-44.9	-40	4.9
eFDD13	high	rms	maxhold	1000	1568.5	-46.8	-40	6.8

Remark: Please see next sub-clause for the measurement plot.

5.18.4 MEASUREMENT PLOT (SHOWING THE HIGHEST VALUE, "WORST CASE")

CAT-M1 eFDD13 QPSK, RB = 1, Channel = low
30 MHz - 1 GHz

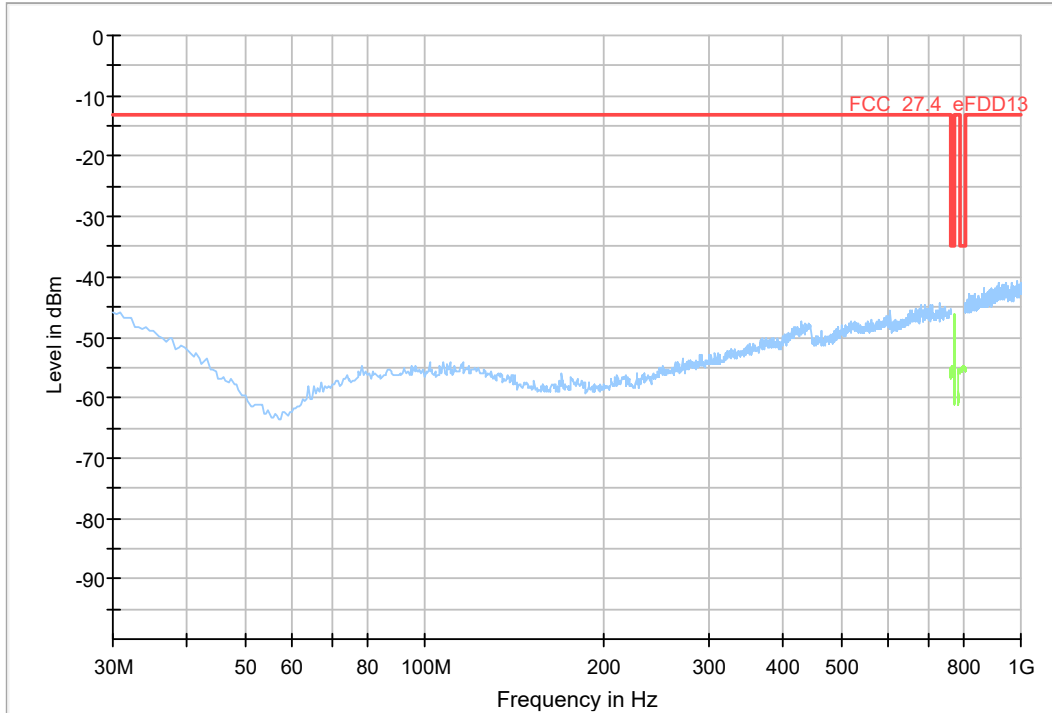

1 GHz - 10 GHz

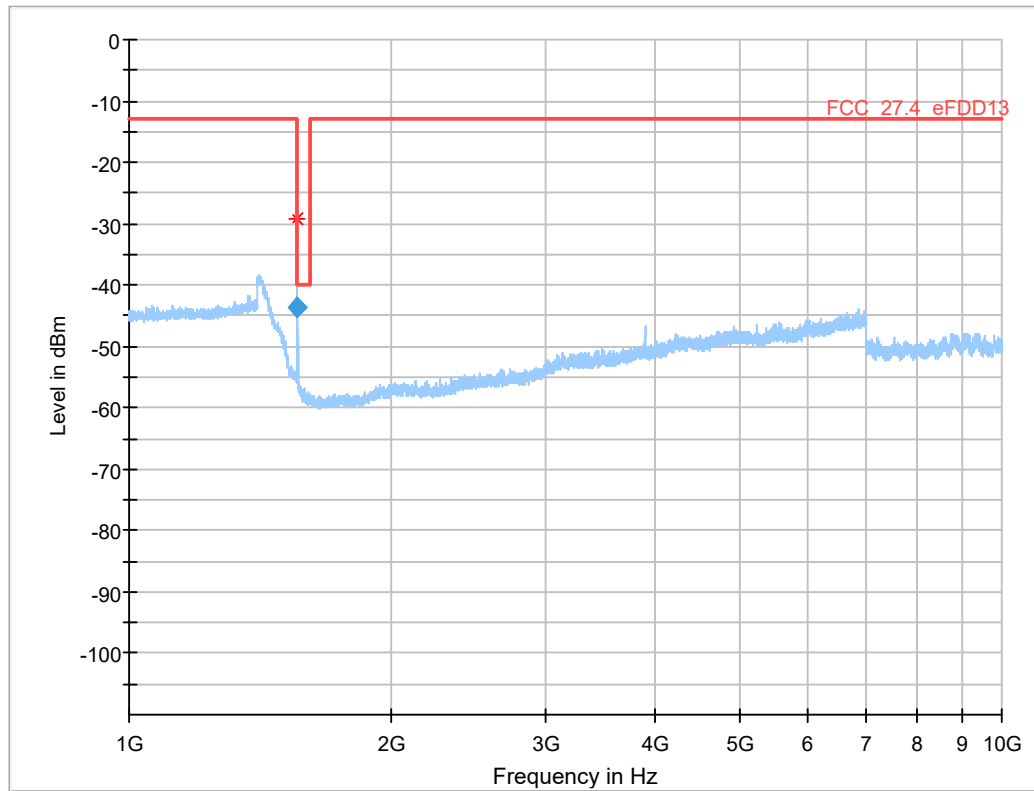

Final Result

Frequency (MHz)	RMS (dBm)	Limit (dBm)	Margin (dB)	Meas. Time (ms)	Bandwidth (kHz)	Height (cm)	Pol	Azimuth (deg)	Elevation (deg)	Corr. (dB)
1559.133	-43.7	-40.00	3.69	1000.0	1000.000	150.0	V	-136.0	89.0	-100.0

5.18.5 TEST EQUIPMENT USED

- Radiated Emissions

5.19 EMISSION AND OCCUPIED BANDWIDTH

Standard **FCC PART 27 Subpart C**

The test was performed according to:
ANSI C63.26: 2015

5.19.1 TEST DESCRIPTION

This test case is intended to demonstrate compliance to the applicable conducted spurious emission test case per FCC §2.1049 and RSS-GEN 6.7. The limit and the requirements come from the applicable rule part and ISSED RSS-Standard for the operating band of the cellular device.

The EUT was connected to the test setups according to the following diagram:

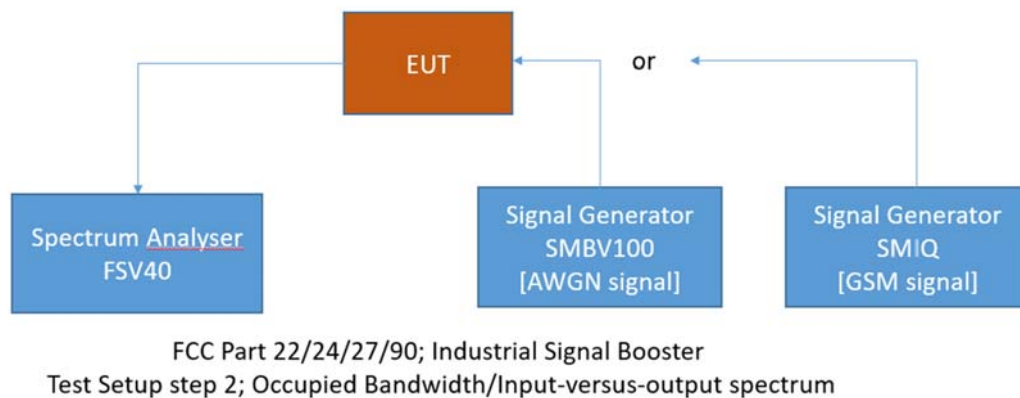
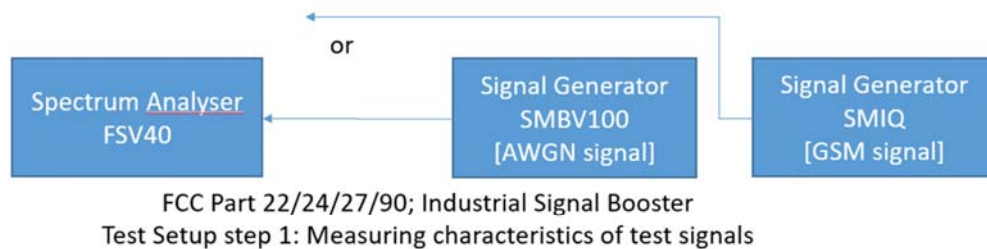

The attenuation of the measuring and stimulus path are known for each measured frequency and are considered.

The Spectrum Analyzer settings can be directly found in the measurement diagrams.

5.19.2 TEST REQUIREMENTS / LIMITS

FCC Part 2.1049; Occupied Bandwidth:

The occupied bandwidth, that is the frequency bandwidth such that, below its lower and above its upper frequency limits, the mean powers radiated are each equal to 0.5 percent of the total mean power radiated by a given emission shall be measured under the following conditions as applicable:

(h) Transmitters employing digital modulation techniques—when modulated by an input signal such that its amplitude and symbol rate represent the maximum rated conditions under which the equipment will be operated. The signal shall be applied through any filter networks, pseudo-random generators or other devices required in normal service. Additionally, the occupied bandwidth shall be shown for operation with any devices used for modifying the spectrum when such devices are optional at the discretion of the user.

(i) Transmitters designed for other types of modulation—when modulated by an appropriate signal of sufficient amplitude to be representative of the type of service in which used. A description of the input signal should be supplied.

RSS-GEN; 6.7 Occupied Bandwidth

The emission bandwidth (\times dB) is defined as the frequency range between two points, one above and one below the carrier frequency, at which the spectral density of the emission is attenuated \times dB below the maximum in-band spectral density of the modulated signal. Spectral density (power per unit bandwidth) is to be measured with a detector of resolution bandwidth in the range of 1% to 5% of the anticipated emission bandwidth, and a video bandwidth at least $3\times$ the resolution bandwidth.

When the occupied bandwidth limit is not stated in the applicable RSS or reference measurement method, the transmitted signal bandwidth shall be reported as the 99% emission bandwidth, as calculated or measured.

The transmitter shall be operated at its maximum carrier power measured under normal test conditions.

The span of the analyzer shall be set to capture all products of the modulation process, including the emission skirts.

The resolution bandwidth (RBW) shall be in the range of 1% to 5% of the occupied bandwidth (OBW) and video bandwidth (VBW) shall be approximately $3\times$ RBW.

Note: Video averaging is not permitted.

A peak, or peak hold, may be used in place of the sampling detector as this may produce a wider bandwidth than the actual bandwidth (worst-case measurement). Use of a peak hold may be necessary to determine the occupied bandwidth if the device is not transmitting continuously.

The trace data points are recovered and are directly summed in linear power level terms. The recovered amplitude data points, beginning at the lowest frequency, are placed in a running sum until 0.5% of the total is reached and that frequency recorded. The process is repeated for the highest frequency data points (starting at the highest frequency, at the right side of the span, and going down in frequency). This frequency is then recorded. The difference between the two recorded frequencies is the 99% occupied bandwidth.

5.19.3 TEST PROTOCOL

Ambient temperature: 24 °C
Relative humidity: 38 %

Radio Technology	Channel	Ressource Blocks / Subcarrier	Bandwidth (MHz)	Nominal BW [MHz]	99 % BW [kHz]
eFDD 4 QPSK	low	6	1.4	1.4	1124.25
eFDD 4 QPSK	mid	6	1.4	1.4	1124.25
eFDD 4 QPSK	high	6	1.4	1.4	1130.26
eFDD 4 16QAM	low	5	1.4	1.4	967.94
eFDD 4 16QAM	mid	5	1.4	1.4	973.95
eFDD 4 16QAM	high	5	1.4	1.4	973.95
eFDD 12 QPSK	low	6	1.4	1.4	1130.26
eFDD 12 QPSK	mid	6	1.4	1.4	1136.27
eFDD 12 QPSK	high	6	1.4	1.4	1124.25
eFDD 12 16QAM	low	5	1.4	1.4	967.94
eFDD 12 16QAM	mid	5	1.4	1.4	967.94
eFDD 12 16QAM	high	5	1.4	1.4	961.92
eFDD 13 QPSK	low	6	1.4	1.4	1124.25
eFDD 13 QPSK	mid	6	1.4	1.4	1130.26
eFDD 13 QPSK	high	6	1.4	1.4	1124.25
eFDD 13 16QAM	low	5	1.4	1.4	967.94
eFDD 13 16QAM	mid	5	1.4	1.4	967.94
eFDD 13 16QAM	high	5	1.4	1.4	961.92

Remark: Please see next sub-clause for the measurement plot.

5.19.4 MEASUREMENT PLOT (SHOWING THE HIGHEST VALUE, "WORST CASE")

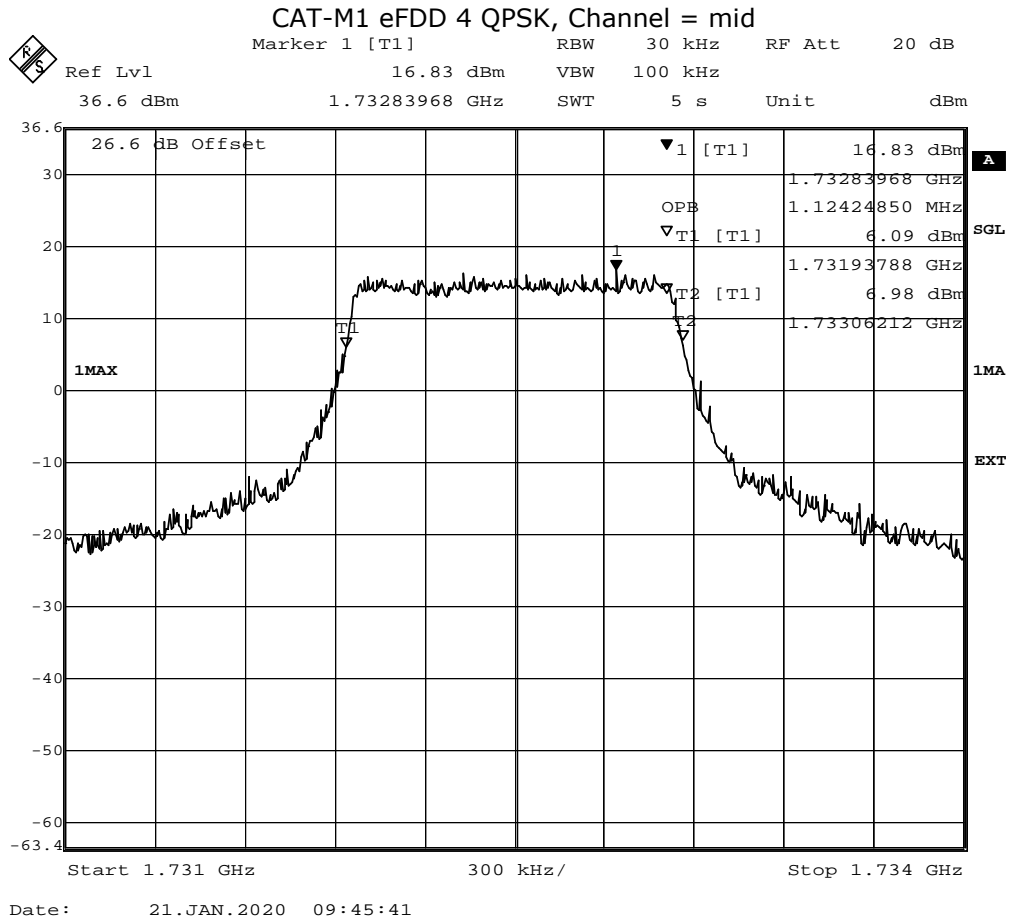

5.19.5 TEST EQUIPMENT USED

- Radio Lab

5.20 BAND EDGE COMPLIANCE

Standard **FCC PART 27 Subpart C**

The test was performed according to:
ANSI C63.26: 2015

5.20.1 TEST DESCRIPTION

This test case is intended to demonstrate compliance to the applicable conducted spurious emission test case per § 2.1051 and RSS-GEN 6.13. The limit comes from the applicable rule part and ISED RSS-Standard for the operating band of the cellular device.

The EUT was connected to the test setup according to the following diagram:

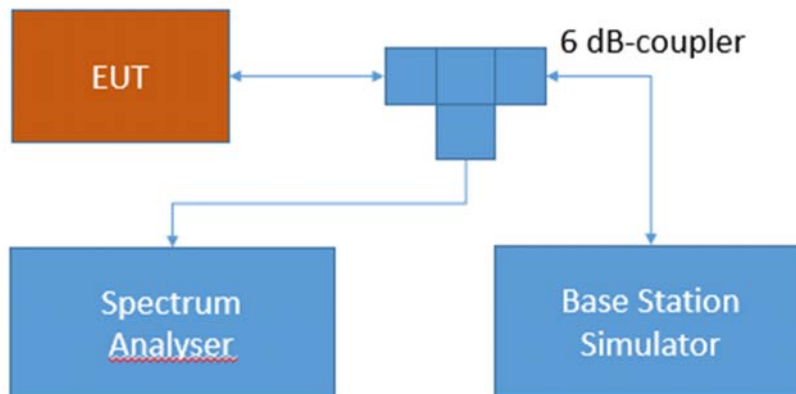

Test Setup FCC Part 22/24/27/90 Cellular;
Band edge compliance

The attenuation of the measuring and stimulus path are known for each measured frequency and are considered.

The Spectrum Analyser settings can be directly found in the measurement diagrams.

5.20.2 TEST REQUIREMENTS / LIMITS

FCC Part 2.1051; Measurement required: Spurious emissions at antenna terminal:

The radio frequency voltage or powers generated within the equipment and appearing on a spurious frequency shall be checked at the equipment output terminals when properly loaded with a suitable artificial antenna. Curves or equivalent data shall show the magnitude of each harmonic and other spurious emission that can be detected when the equipment is operated under the conditions specified in §2.1049 as appropriate. The magnitude of spurious emissions which are attenuated more than 20 dB below the permissible value need not be specified.

FCC Part 27; Miscellaneous Wireless Communication Services

Subpart C – Technical standards

§27.53 - Emission limits

Band 13

(c) For operations in the 746-758 MHz band and the 776-788 MHz band, the power of any emission outside the licensee's frequency band(s) of operation shall be attenuated below the transmitter power (P) within the licensed band(s) of operation, measured in watts, in accordance with the following:

(1) On any frequency outside the 746-758 MHz band, the power of any emission shall be attenuated outside the band below the transmitter power (P) by at least $43 + 10 \log (P)$ dB;

(2) On any frequency outside the 776-788 MHz band, the power of any emission shall be attenuated outside the band below the transmitter power (P) by at least $43 + 10 \log (P)$ dB;

(3) On all frequencies between 763-775 MHz and 793-805 MHz, by a factor not less than $76 + 10 \log (P)$ dB in a 6.25 kHz band segment, for base and fixed stations;

(4) On all frequencies between 763-775 MHz and 793-805 MHz, by a factor not less than $65 + 10 \log (P)$ dB in a 6.25 kHz band segment, for mobile and portable stations;

(5) Compliance with the provisions of paragraphs (c)(1) and (c)(2) of this section is based on the use of measurement instrumentation employing a resolution bandwidth of 100 kHz or greater. However, in the 100 kHz bands immediately outside and adjacent to the frequency block, a resolution bandwidth of at least 30 kHz may be employed;

(f) For operations in the 746-758 MHz, 775-788 MHz, and 805-806 MHz bands, emissions in the band 1559-1610 MHz shall be limited to -70 dBW/MHz equivalent isotropically radiated power (EIRP) for wideband signals, and -80 dBW EIRP for discrete emissions of less than 700 Hz bandwidth. For the purpose of equipment authorization, a transmitter shall be tested with an antenna that is representative of the type that will be used with the equipment in normal operation.

(6) Compliance with the provisions of paragraphs (c)(3) and (c)(4) of this section is based on the use of measurement instrumentation such that the reading taken with any resolution bandwidth setting should be adjusted to indicate spectral energy in a 6.25 kHz segment.

RSS-130; 4.7.1 General unwanted emissions limits

The unwanted emissions in any 100 kHz bandwidth on any frequency outside the low frequency edge and the high frequency edge of each frequency block range(s), shall be attenuated below the transmitter power, P (dBW), by at least $43 + 10 \log_{10} p$ (watts), dB. However, in the 100 kHz band immediately outside of the equipment's frequency block range, a resolution bandwidth of 30 kHz may be employed.

RSS-130; 4.7.2 Additional unwanted emissions limits

In addition to the limit outlined in section 4.7.1 above, equipment operating in the frequency bands 746-756 MHz and 777-787 MHz shall also comply with the following restrictions:

- a. the power of any unwanted emissions in any 6.25 kHz bandwidth for all frequencies between 763-775 MHz and 793-806 MHz shall be attenuated below the transmitter power, P (dBW), by at least:
 - i. $76 + 10 \log_{10} p$ (watts), dB, for base and fixed equipment and
 - ii. $65 + 10 \log_{10} p$ (watts), dB, for mobile and portable equipment
- b. the e.i.r.p. in the band 1559-1610 MHz shall not exceed -70 dBW/MHz for wideband signal and -80 dBW for discrete emission with bandwidth less than 700 Hz.

Band 12:

(g) For operations in the 600 MHz band and the 698-746 MHz band, the power of any emission outside a licensee's frequency band(s) of operation shall be attenuated below the transmitter power (P) within the licensed band(s) of operation, measured in watts, by at least $43 + 10 \log(P)$ dB. Compliance with this provision is based on the use of measurement instrumentation employing a resolution bandwidth of 100 kilohertz or greater. However, in the 100 kilohertz bands immediately outside and adjacent to a licensee's frequency block, a resolution bandwidth of at least 30 kHz may be employed.

RSS-130; 4.7.1 General unwanted emissions limits

The unwanted emissions in any 100 kHz bandwidth on any frequency outside the low frequency edge and the high frequency edge of each frequency block range(s), shall be attenuated below the transmitter power, P (dBW), by at least $43 + 10 \log_{10} p$ (watts), dB. However, in the 100 kHz band immediately outside of the equipment's frequency block range, a resolution bandwidth of 30 kHz may be employed.

RSS-130; 4.7.2 Additional unwanted emissions limits

In addition to the limit outlined in section 4.7.1 above, equipment operating in the frequency bands 746-756 MHz and 777-787 MHz shall also comply with the following restrictions:

- a. the power of any unwanted emissions in any 6.25 kHz bandwidth for all frequencies between 763-775 MHz and 793-806 MHz shall be attenuated below the transmitter power, P (dBW), by at least:
 - i. $76 + 10 \log_{10} p$ (watts), dB, for base and fixed equipment and
 - ii. $65 + 10 \log_{10} p$ (watts), dB, for mobile and portable equipment
- b. the e.i.r.p. in the band 1559-1610 MHz shall not exceed -70 dBW/MHz for wideband signal and -80 dBW for discrete emission with bandwidth less than 700 Hz.

Band 4/10/66:

(h) *AWS emission limits— (1) General protection levels.* Except as otherwise specified below, for operations in the 1695-1710 MHz, 1710-1755 MHz, 1755-1780 MHz, 1915-1920 MHz, 1995-2000 MHz, 2000-2020 MHz, 2110-2155 MHz, 2155-2180 MHz, and 2180-2200 bands, the power of any emission outside a licensee's frequency block shall be attenuated below the transmitter power (P) in watts by at least $43 + 10 \log_{10}(P)$ dB.

RSS-139; 6.6 Transmitter Unwanted Emissions

Equipment shall comply with the limits in (i) and (ii) below.

- i. In the first 1.0 MHz bands immediately outside and adjacent to the equipment's smallest operating frequency block, which can contain the equipment's occupied bandwidth, the emission power per any 1% of the emission bandwidth shall be attenuated below the transmitter output power P (in dBW) by at least $43 + 10 \log_{10} p$ (watts) dB.
- ii. After the first 1.0 MHz outside the equipment's smallest operating frequency block, which can contain the equipment's occupied bandwidth, the emission power in any 1 MHz bandwidth shall be attenuated below the transmitter output power P (in dBW) by at least $43 + 10 \log_{10} p$ (watts) dB.

Band 7:

(m) For BRS and EBS stations, the power of any emissions outside the licensee's frequency bands of operation shall be attenuated below the transmitter power (P) measured in watts in accordance with the standards below. If a licensee has multiple contiguous channels, out-of-band emissions shall be measured from the upper and lower edges of the contiguous channels.

(4) For mobile digital stations, the attenuation factor shall be not less than $40 + 10 \log (P)$ dB on all frequencies between the channel edge and 5 megahertz from the channel edge, $43 + 10 \log (P)$ dB on all frequencies between 5 megahertz and X megahertz from the channel edge, and $55 + 10 \log (P)$ dB on all frequencies more than X megahertz from the channel edge, where X is the greater of 6 megahertz or the actual emission bandwidth as defined in paragraph (m)(6) of this section. In addition, the attenuation factor shall not be less than $43 + 10 \log (P)$ dB on all frequencies between 2490.5 MHz and 2496 MHz and $55 + 10 \log (P)$ dB at or below 2490.5 MHz. Mobile Satellite Service licensees operating on frequencies below 2495 MHz may also submit a documented interference complaint against BRS licensees operating on channel BRS Channel 1 on the same terms and conditions as adjacent channel BRS or EBS licensees.

RSS-199; 4.5 Transmitter unwanted emissions

In the 1 MHz band immediately outside and adjacent to the channel edge, the unwanted emission power shall be measured with a resolution bandwidth of at least 1% of the occupied bandwidth for base station and fixed subscriber equipment, and 2% for mobile subscriber equipment. Beyond the 1 MHz band, a resolution bandwidth of 1 MHz shall be used. A narrower resolution bandwidth can be used, provided that the measured power is integrated over the full required measurement bandwidth of 1 MHz, or 1% or 2% of the occupied bandwidth, as applicable.

Equipment shall comply with the following unwanted emission limits:

b. for mobile subscriber equipment, the power of any unwanted emissions measured as above shall be attenuated (in dB) below the transmitter power, P (dBW), by at least:

$40 + 10 \log_{10} p$ from the channel edges to 5 MHz away

$43 + 10 \log_{10} p$ between 5 MHz and X MHz from the channel edges, and

$55 + 10 \log_{10} p$ at X MHz and beyond from the channel edges

In addition, the attenuation shall not be less than $43 + 10 \log_{10} p$ on all frequencies between 2490.5 MHz and 2496 MHz, and $55 + 10 \log_{10} p$ at or below 2490.5 MHz.

In (b), p is the transmitter power measured in watts and X is 6 MHz or the equipment occupied bandwidth, whichever is greater.

Band 17:

(g) For operations in the 600 MHz band and the 698-746 MHz band, the power of any emission outside a licensee's frequency band(s) of operation shall be attenuated below the transmitter power (P) within the licensed band(s) of operation, measured in watts, by at least $43 + 10 \log(P)$ dB. Compliance with this provision is based on the use of measurement instrumentation employing a resolution bandwidth of 100 kilohertz or greater. However, in the 100 kilohertz bands immediately outside and adjacent to a licensee's frequency block, a resolution bandwidth of at least 30 kHz may be employed.

RSS-130; 4.7.1 General unwanted emissions limits

The unwanted emissions in any 100 kHz bandwidth on any frequency outside the low frequency edge and the high frequency edge of each frequency block range(s), shall be attenuated below the transmitter power, P (dBW), by at least $43 + 10 \log_{10} p$ (watts), dB. However, in the 100 kHz band immediately outside of the equipment's frequency block range, a resolution bandwidth of 30 kHz may be employed.

RSS-130; 4.7.2 Additional unwanted emissions limits

In addition to the limit outlined in section 4.7.1 above, equipment operating in the frequency bands 746-756 MHz and 777-787 MHz shall also comply with the following restrictions:

- a. the power of any unwanted emissions in any 6.25 kHz bandwidth for all frequencies between 763-775 MHz and 793-806 MHz shall be attenuated below the transmitter power, P (dBW), by at least:
 - i. $76 + 10 \log_{10} p$ (watts), dB, for base and fixed equipment and
 - ii. $65 + 10 \log_{10} p$ (watts), dB, for mobile and portable equipment
- b. the e.i.r.p. in the band 1559-1610 MHz shall not exceed -70 dBW/MHz for wideband signal and -80 dBW for discrete emission with bandwidth less than 700 Hz.

5.20.3 TEST PROTOCOL

Ambient temperature: 24 °C
Relative humidity: 38 %

Radio Technology	Channel	Ressource Blocks	Band-width [MHz]	RMS [dBm]	Limit /dBm	Margin to Limit /dB
CAT-M1 eFDD 4 QPSK	low	6	1.4	-23.65	-13	10.65
CAT-M1 eFDD 4 QPSK	high	6	1.4	-23.7	-13	10.7
CAT-M1 eFDD 4 16QAM	low	5	1.4	-22.67	-13	9.67
CAT-M1 eFDD 4 16QAM	high	5	1.4	-27.14	-13	14.14
CAT-M1 eFDD 12 QPSK	low	6	1.4	-20.68	-13	7.68
CAT-M1 eFDD 12 QPSK	high	6	1.4	-21.61	-13	8.61
CAT-M1 eFDD 12 16QAM	low	5	1.4	-19.48	-13	6.48
CAT-M1 eFDD 12 16QAM	high	5	1.4	-24.76	-13	11.76
CAT-M1 eFDD 13 QPSK	low	6	1.4	-21.51	-13	8.51
CAT-M1 eFDD 13 QPSK	high	6	1.4	-22.2	-13	9.2
CAT-M1 eFDD 13 16QAM	low	5	1.4	-20.78	-13	7.78
CAT-M1 eFDD 13 16QAM	high	5	1.4	-25.31	-13	12.31

Remark: Please see next sub-clause for the measurement plot.

5.21 PEAK TO AVERAGE RATIO

Standard **FCC PART 27 Subpart C**

The test was performed according to:
ANSI C63.26: 2015

5.21.1 TEST DESCRIPTION

This test case is intended to demonstrate compliance of the EUT to the peak-to-average limits and requirements of the applicable rule part and ISED RSS-Standard for the operating band of the cellular device.

The EUT was connected to the test setup according to the following diagram:

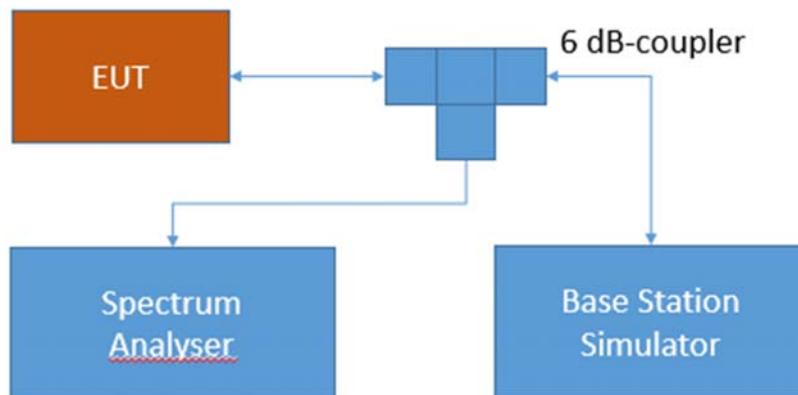

Test Setup FCC Part 22/24/27/90 Cellular;
Peak-average ratio

The attenuation of the measuring and stimulus path are known for each measured frequency and are considered.

The Spectrum Analyzer settings can be directly found in the measurement diagrams. The internal CCDF (complementary cumulative distribution function) of the spectrum analyser is used for this measurement

5.21.2 TEST REQUIREMENTS / LIMITS

FCC Part 27; Miscellaneous Wireless Communication Services

Subpart C – Technical standards

§ 27.50 - Power limits and duty cycle

Band 13:

No applicable PAPR limit.

RSS-130; 4.6.1 General

The transmitter output power shall be measured in terms of average power. In addition, the peak-to-average power ratio (PAPR) of the transmitter shall not exceed 13 dB for more than 0.1% of the time and shall use a signal corresponding to the highest PAPR during periods of continuous transmission.

Band 12:

No applicable PAPR limit.

RSS-130; 4.6.1 General

The transmitter output power shall be measured in terms of average power. In addition, the peak-to-average power ratio (PAPR) of the transmitter shall not exceed 13 dB for more than 0.1% of the time and shall use a signal corresponding to the highest PAPR during periods of continuous transmission.

Band 4/10/66:

d) The following power and antenna height requirements apply to stations transmitting in the 1695-1710 MHz, 1710-1755 MHz, 1755-1780 MHz, 1915-1920 MHz, 1995-2000 MHz, 2000-2020 MHz, 2110-2155 MHz, 2155-2180 MHz and 2180-2200 MHz bands:

(5) Equipment employed must be authorized in accordance with the provisions of §24.51. Power measurements for transmissions by stations authorized under this section may be made either in accordance with a Commission-approved average power technique or in compliance with paragraph (d)(6) of this section. In measuring transmissions in this band using an average power technique, the peak-to-average ratio (PAR) of the transmission may not exceed 13 dB.

RSS-139; 6.5 Transmitter Output Power

In addition, the peak to average power ratio (PAPR) of the equipment shall not exceed 13 dB for more than 0.1% of the time, using a signal that corresponds to the highest PAPR during periods of continuous transmission.

Band 17:

No applicable PAPR limit.

RSS-130; 4.6.1 General

The transmitter output power shall be measured in terms of average power. In addition, the peak-to-average power ratio (PAPR) of the transmitter shall not exceed 13 dB for more than

0.1% of the time and shall use a signal corresponding to the highest PAPR during periods of continuous transmission.

Band 7:

No applicable PAPR limit.

RSS-199; 4.4 Transmitter output power and equivalent isotropical power (e.i.r.p.)

In addition, the peak-to-average power ratio (PAPR) of the transmitter shall not exceed 13 dB for more than 0.1% of the time and shall use a signal corresponding to the highest PAPR during periods of continuous transmission.

For equipment with multiple antennas, the transmitter output power and e.i.r.p shall be measured according to ANSI C63.26-2015.

5.21.3 TEST PROTOCOL

Ambient temperature: 24 °C
Relative humidity: 38 %

Radio Technology	Channel	Ressource Blocks	Bandwidth [MHz]	Peak to Average Ratio	Limit (IC) [dB]
CAT-M1 eFDD 4 QPSK	low	6	1.4	7.39	13
CAT-M1 eFDD 4 QPSK	mid	6	1.4	7.45	13
CAT-M1 eFDD 4 QPSK	high	6	1.4	7.57	13
CAT-M1 eFDD 4 16QAM	low	5	1.4	7.68	13
CAT-M1 eFDD 4 16QAM	mid	5	1.4	8.52	13
CAT-M1 eFDD 4 16QAM	high	5	1.4	8.03	13
CAT-M1 eFDD 12 QPSK	low	6	1.4	7.19	13
CAT-M1 eFDD 12 QPSK	mid	6	1.4	7.07	13
CAT-M1 eFDD 12 QPSK	high	6	1.4	7.45	13
CAT-M1 eFDD 12 16QAM	low	5	1.4	8.09	13
CAT-M1 eFDD 12 16QAM	mid	5	1.4	8.35	13
CAT-M1 eFDD 12 16QAM	high	5	1.4	7.91	13
CAT-M1 eFDD 13 QPSK	low	6	1.4	7.74	13
CAT-M1 eFDD 13 QPSK	mid	6	1.4	7.57	13
CAT-M1 eFDD 13 QPSK	high	6	1.4	7.68	13
CAT-M1 eFDD 13 16QAM	low	5	1.4	8.32	13
CAT-M1 eFDD 13 16QAM	mid	5	1.4	8.46	13
CAT-M1 eFDD 13 16QAM	high	5	1.4	8.41	13

Remark: Please see next sub-clause for the measurement plot.

5.21.4 MEASUREMENT PLOT (SHOWING THE HIGHEST VALUE, "WORST CASE")
 CAT-M1 eFDD 4 16QAM, Channel = mid

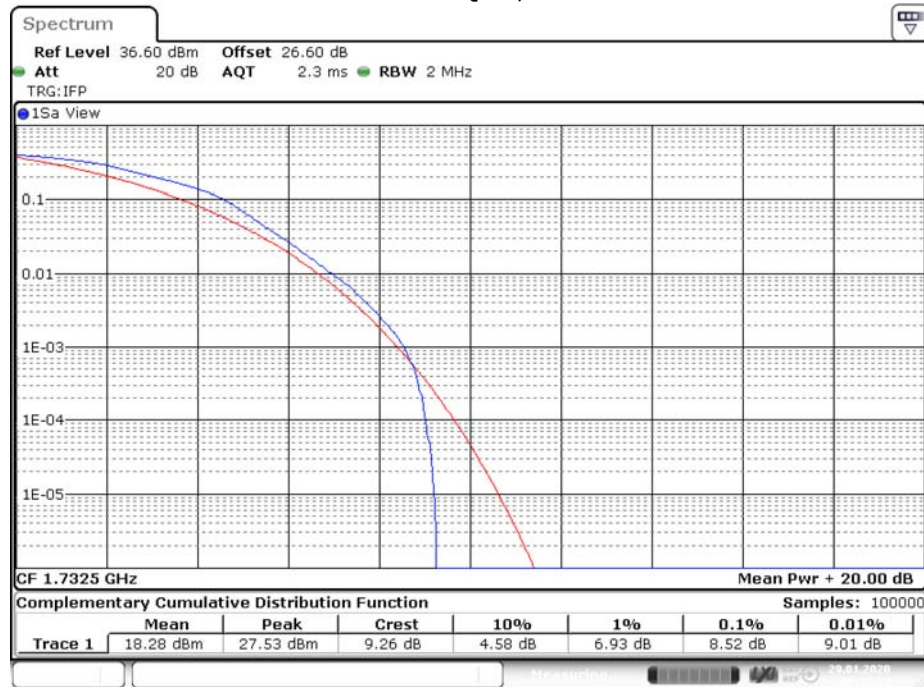

Date: 29.JAN.2020 09:15:55

5.21.5 TEST EQUIPMENT USED

- Radio Lab

5.22 RF OUTPUT POWER

Standard **FCC PART 90 Subpart S**

The test was performed according to:
ANSI C63.26: 2015

5.22.1 TEST DESCRIPTION

This test case is intended to demonstrate compliance to the applicable RF Output power test case per § 2.1046 and RSS-GEN 6.12. The limit and the requirements come from the applicable rule part and ISED RSS-Standard for the operating band of the cellular device.

The EUT was connected to the test setup according to the following diagram:

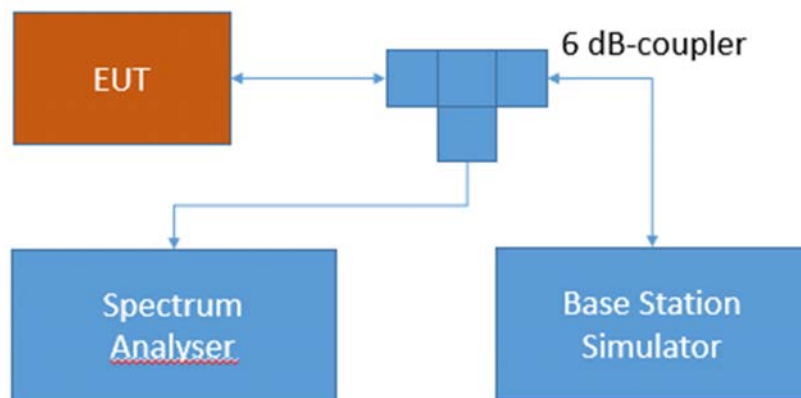

Test Setup FCC Part 22/24/27/90 Cellular;
RF Output power

The attenuation of the measuring and stimulus path are known for each measured frequency and are considered.

The Spectrum Analyser settings can be directly found in the measurement diagrams.

5.22.2 TEST REQUIREMENTS / LIMITS

Part 90; PRIVATE LAND MOBILE RADIO SERVICES

Subpart S—Regulations Governing Licensing and Use of Frequencies in the 806-824, 851-869, 896-901, and 935-940 MHz Bands

§90.635 Limitations on power and antenna height.

(b) The maximum output power of the transmitter for mobile stations is 100 watts (20 dBw).

5.22.3 TEST PROTOCOL

Ambient temperature: 24 °C
Relative humidity: 38 %

Radio Technology	Channel	Res- source Blocks	Band- width [MHz]	RMS Conducted Power [dBm]	FCC EIRP Limit [W]	IC EIRP Limit [W]	Maximum Antenna Gain FCC [dBi]	Maximum Antenna Gain IC [dBi]
CAT-M1 eFDD 26 QPSK	low	1	1.4	22.56	1	1	7.44	7.44
CAT-M1 eFDD 26 QPSK	low	3	1.4	21.46	1	1	8.54	8.54
CAT-M1 eFDD 26 QPSK	low	6	1.4	20.46	1	1	9.54	9.54
CAT-M1 eFDD 26 QPSK	mid	1	1.4	22.64	1	1	7.36	7.36
CAT-M1 eFDD 26 QPSK	mid	3	1.4	21.54	1	1	8.46	8.46
CAT-M1 eFDD 26 QPSK	mid	6	1.4	20.48	1	1	9.52	9.52
CAT-M1 eFDD 26 QPSK	high	1	1.4	22.57	1	1	7.43	7.43
CAT-M1 eFDD 26 QPSK	high	3	1.4	21.48	1	1	8.52	8.52
CAT-M1 eFDD 26 QPSK	high	6	1.4	20.41	1	1	9.59	9.59
CAT-M1 eFDD 26 16QAM	low	1	1.4	21.17	1	1	8.83	8.83
CAT-M1 eFDD 26 16QAM	low	5	1.4	20.65	1	1	9.35	9.35
CAT-M1 eFDD 26 16QAM	mid	1	1.4	21.19	1	1	8.81	8.81
CAT-M1 eFDD 26 16QAM	mid	5	1.4	20.73	1	1	9.27	9.27
CAT-M1 eFDD 26 16QAM	high	1	1.4	21.26	1	1	8.74	8.74
CAT-M1 eFDD 26 16QAM	high	5	1.4	20.62	1	1	9.38	9.38

Remark: Please see next sub-clause for the measurement plot.

5.22.4 MEASUREMENT PLOT (SHOWING THE HIGHEST VALUE, "WORST CASE")

CAT-M1 eFDD 26 QPSK, RB = 1, Channel = mid

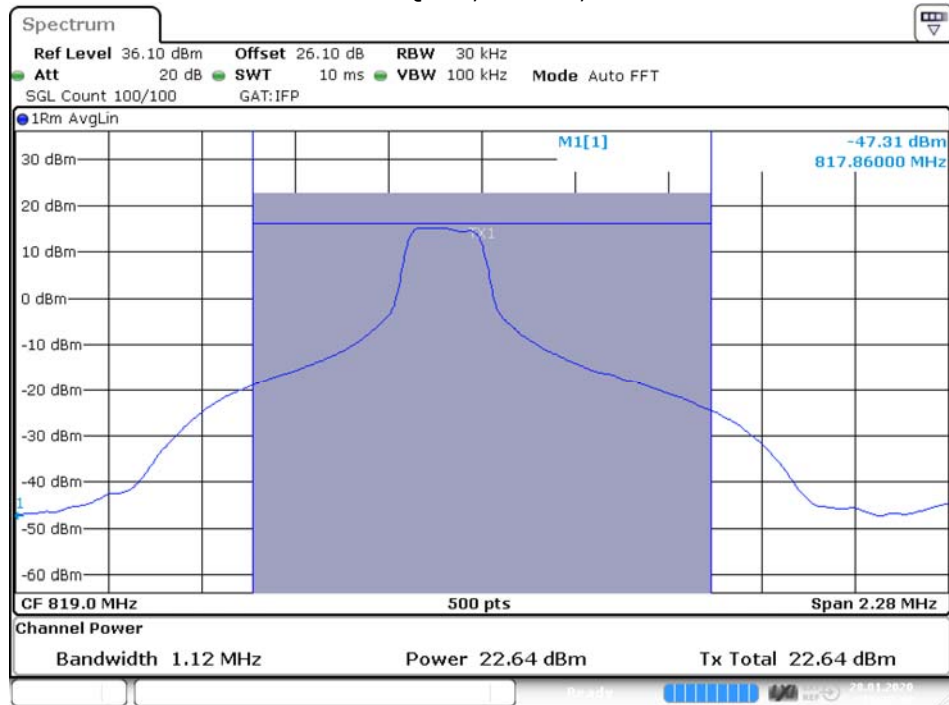

Date: 28.JAN.2020 15:32:50

5.22.5 TEST EQUIPMENT USED

- Radio Lab

5.23 FREQUENCY STABILITY

Standard **FCC PART 90 Subpart S**

The test was performed according to:
ANSI C63.26: 2015

5.23.1 TEST DESCRIPTION

This test case is intended to demonstrate compliance to the applicable frequency stability test case per § 2.1055 and RSS-GEN 6.11. The limit and the requirements come from the applicable rule part and ISED RSS-Standard for the operating band of the cellular device.

The EUT was connected to the test setup according to the following diagram:



Test Setup FCC Part 22/24/27/90 Cellular;
Frequency stability

The attenuation of the measuring / stimulus path is known for each measured frequency and are considered.

5.23.2 TEST REQUIREMENTS / LIMITS

FCC Part 90,

§ 90.213

- (a) Unless noted elsewhere, transmitters used in the services governed by this part must have a minimum frequency stability as specified in the following table.

Table Minimum Frequency Stability

[Parts per million (ppm)]

Frequency range (MHz)	Mobile stations	
	Over 2 watts output power	2 watts or less output power
809-824	2.5	2.5
851-854	1.5	1.5

5.23.3 TEST PROTOCOL

Temp. °C	Duration min	Voltage	Limit Hz	Freq. error Average (Hz)	Freq. error Max. (Hz)	Verdict
-30	0	normal	2047.5	1	6	passed
-30	5			-6	-11	passed
-30	10			-3	-7	passed
-20	0	normal	2047.5	3	9	passed
-20	5			5	10	passed
-20	10			5	12	passed
-10	0	normal	2047.5	5	8	passed
-10	5			3	6	passed
-10	10			3	7	passed
0	0	normal	2047.5	-8	-12	passed
0	5			-3	-8	passed
0	10			-5	-11	passed
10	0	normal	2047.5	-8	-11	passed
10	5			-3	-8	passed
10	10			-9	-12	passed
20	0	low	2047.5	-3	-9	passed
20	5			-2	-7	passed
20	10			-3	-9	passed
20	0	normal	2047.5	0	5	passed
20	5			3	8	passed
20	10			2	6	passed
20	0	high	2047.5	-6	-13	passed
20	5			-7	-11	passed
20	10			-6	-11	passed
30	0	normal	2047.5	1	7	passed
30	5			-5	-9	passed
30	10			-5	-9	passed
40	0	normal	2047.5	-4	-10	passed
40	5			-5	-11	passed
40	10			-8	-12	passed
50	0	normal	2047.5	-6	-8	passed
50	5			-2	-6	passed
50	10			-6	-11	passed

5.23.4 TEST EQUIPMENT USED

- Radio Lab

5.24 SPURIOUS EMISSIONS AT ANTENNA TERMINALS

Standard **FCC PART 90 Subpart S**

The test was performed according to:
ANSI C63.26: 2015

5.24.1 TEST DESCRIPTION

This test case is intended to demonstrate compliance to the applicable conducted spurious emission test case per § 2.1051 and RSS-GEN 6.13. The limit comes from the applicable rule part and ISED RSS-Standard for the operating band of the cellular device.

The EUT was connected to the test setup according to the following diagram:

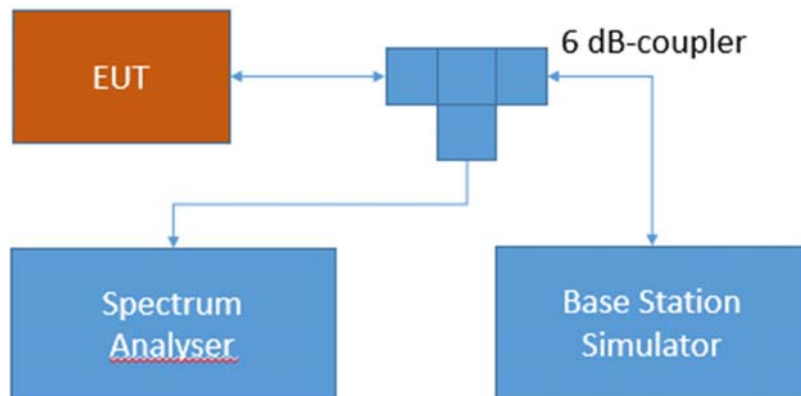

Test Setup FCC Part 22/24/27/90 Cellular;
Spurious Emissions at antenna terminal

The attenuation of the measuring and stimulus path are known for each measured frequency and are considered.

The Spectrum Analyser settings can be directly found in the measurement diagrams.

5.24.2 TEST REQUIREMENTS / LIMITS

FCC Part 2.1051; Measurement required: Spurious emissions at antenna terminal:

The radio frequency voltage or powers generated within the equipment and appearing on a spurious frequency shall be checked at the equipment output terminals when properly loaded with a suitable artificial antenna. Curves or equivalent data shall show the magnitude of each harmonic and other spurious emission that can be detected when the equipment is operated under the conditions specified in §2.1049 as appropriate. The magnitude of spurious emissions which are attenuated more than 20 dB below the permissible value need not be specified.

Part 90; PRIVATE LAND MOBILE RADIO SERVICES

Subpart R—Regulations Governing the Licensing and Use of Frequencies in the 763-775 and 793-805 MHz Bands

§90.543 – Emission limitations.

(a) The adjacent channel power (ACP) requirements for transmitters designed for various channel sizes are shown in the following tables. Mobile station requirements apply to handheld, car mounted and control station units. The tables specify a value for the ACP as a function of the displacement from the channel center frequency and measurement bandwidth. In the following tables, "(s)" indicates a swept measurement may be used.

Subpart S—Regulations Governing the Licensing and Use of Frequencies in the 806-824, 851-869, 869-901 and 935-940 MHz Bands

§90.543 – Emission limitations.

(a) On any frequency in an MTA licensee's spectrum block that is adjacent to a non-MTA frequency, the power of any emission shall be attenuated below the transmitter power (P) by at least 43 plus 10 log₁₀(P) decibels or 80 decibels, whichever is the lesser attenuation.

Note: The measurements of emission power can be expressed in peak or average values, provided they are expressed in the same parameters as the transmitter power.

(b) When an emission outside of the authorized bandwidth causes harmful interference, the Commission may, at its discretion, require greater attenuation than specified in this section.

5.24.3 TEST PROTOCOL

Ambient temperature: 24 °C
 Relative humidity: 38 %

Radio Technology	Channel	Detector	Trace	Resolution Bandwidth /kHz	Frequency /MHz	Peak Value /dBm	Limit /dBm	Margin to Limit /dB
eFDD26	low	rms	maxhold	5	813.9	-24.02	-17.5	6.52
eFDD26	mid	rms	maxhold	-	-	-	-13	>20
eFDD26	high	rms	maxhold	-	-	-	-13	>20

Remark: Please see next sub-clause for the measurement plot.

5.24.4 MEASUREMENT PLOT (SHOWING THE HIGHEST VALUE, "WORST CASE")

CAT-M1 eFDD 26 QPSK, RB = 1, Channel = low

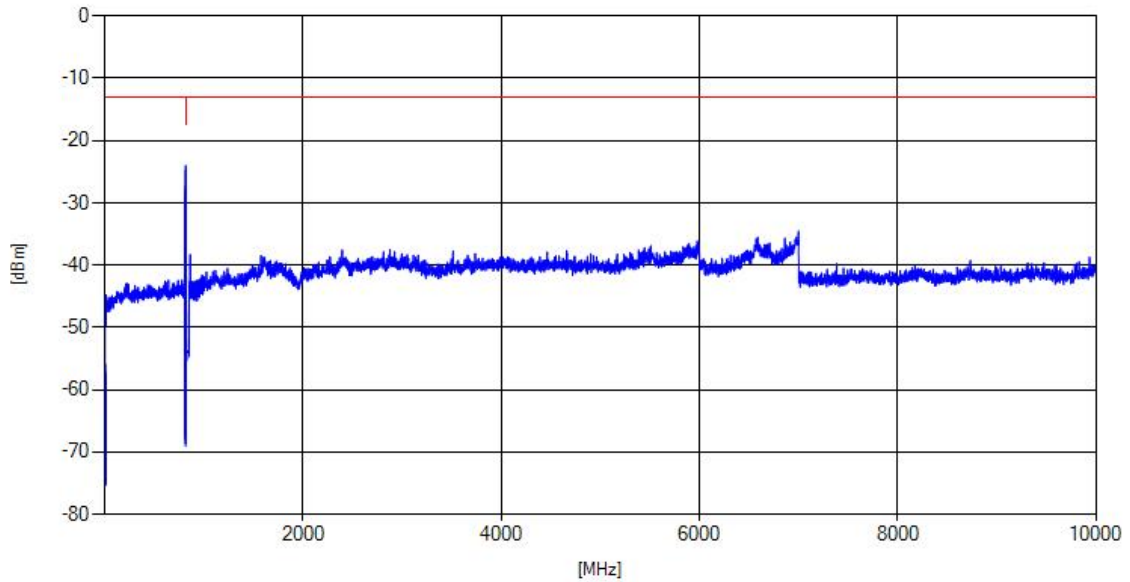

5.24.5 TEST EQUIPMENT USED

- Radio Lab

5.25 FIELD STRENGTH OF SPURIOUS RADIATION

Standard **FCC PART 90 Subpart S**

The test was performed according to:
ANSI C63.26: 2015

5.25.1 TEST DESCRIPTION

This test case is intended to demonstrate compliance to the applicable radiated spurious emission measurements per § 2.1053 and RSS-GEN 6.13. The limit and requirements come from the applicable rule part and ISSED RSS-Standard for the operating band of the cellular device.

The EUT was connected to the test setup according to the following diagram:

Frequency Range: 30 MHz – 1 GHz:

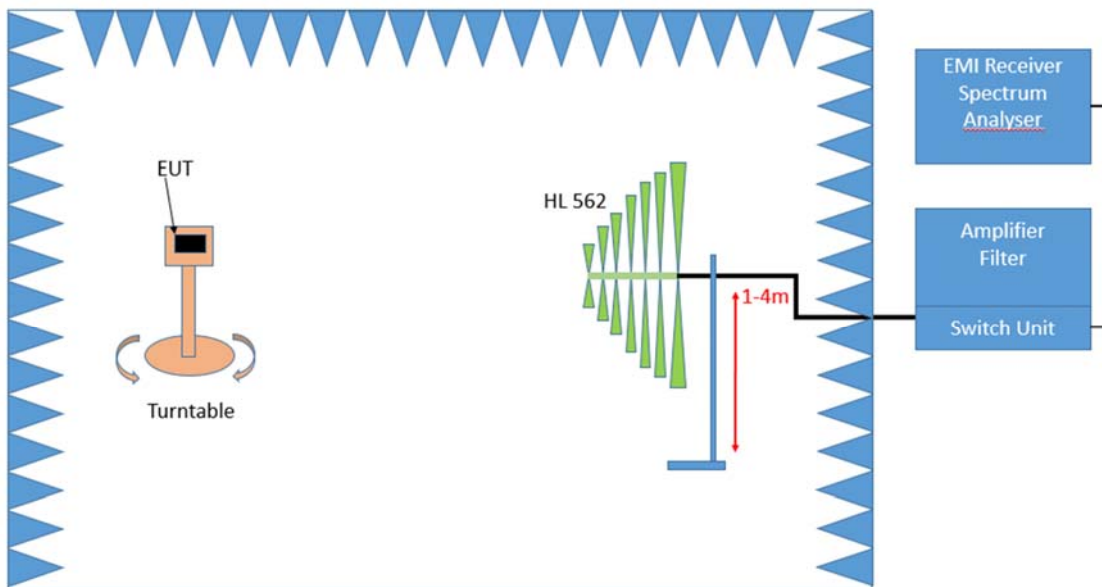

Test Setup; Spurious Emission Radiated (SAC), 30 MHz- 1GHz

Frequency Range: 1 GHz – 26.5 GHz

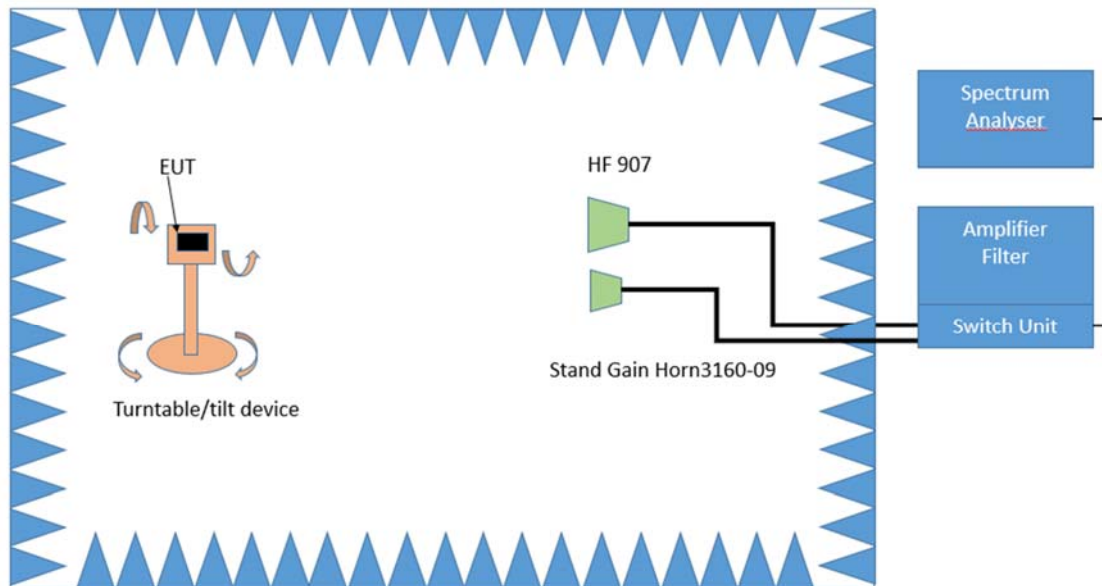

Test Setup; Spurious Emission Radiated (FAC), 1 GHz-26.5 GHz

The test set-up was made in accordance to the general provisions of ANSI C63.26 in a typical installation configuration. The Equipment Under Test (EUT) was set up on a non-conductive table 1.0 x 2.0 m² in the semi-anechoic chamber. The influence of the EUT support table that is used between 30–1000 MHz was evaluated.

The measurement procedure is implemented into the EMI test software EMC32 from R&S. Exploratory tests are performed at 3 orthogonal axes to determine the worst-case orientation of a body-worn or handheld EUT. The final test on all kind of EUTs is also performed at 3 axes. A pre-check is performed while the EUT is powered from a DC power source.

1. Measurement above 30 MHz and up to 1 GHz

Step 1: Preliminary scan

This is a preliminary test to identify the highest amplitudes relative to the limit.

Settings for step 1:

- Antenna distance: 3 m
- Detector: Peak
- RBW: 100 kHz
- VBW: 300 kHz
- Sweep time: coupled
- Turntable angle range: -180° to 90°
- Turntable step size: 90°
- Height variation range: 1 – 3 m
- Height variation step size: 2 m
- Polarisation: Horizontal + Vertical

Intention of this step is, to determine the radiated EMI-profile of the EUT. Afterwards the relevant emissions for the final measurement are identified.

Step 2: Adjustment measurement

In this step the accuracy of the turntable azimuth and antenna height will be improved. This is necessary to find out the maximum value of every frequency.

For each frequency, which was determined the turntable azimuth and antenna height will be adjusted. The turntable azimuth will slowly vary by $\pm 45^\circ$ around this value. During this action, the value of emission is continuously measured. The turntable azimuth at the highest emission will be recorded and adjusted. In this position, the antenna height will also slowly vary by \pm

100 cm around the antenna height determined. During this action, the value of emission is also continuously measured. The antenna height of the highest emission will also be recorded and adjusted.

- Detector: Peak
- Measured frequencies: in step 1 determined frequencies
- RBW: 100 kHz
- VBW: 300 kHz
- Sweep time: coupled
- Turntable angle range: $\pm 45^\circ$ around the determined value
- Height variation range: ± 100 cm around the determined value
- Antenna Polarisation: max. value determined in step 1

Step 3: Final measurement with RMS detector

With the settings determined in step 3, the final measurement will be performed:

EMI receiver settings for step 4:

- Detector: RMQ
- Measured frequencies: in step 1 determined frequencies
- RBW: 100 kHz
- VBW: 300 kHz
- Sweep time: 1 s

After the measurement a plot will be generated which contains a diagram with the results of the preliminary scan and a chart with the frequencies and values of the results of the final measurement.

3. Measurement above 1 GHz

The following modifications apply to the measurement procedure for the frequency range above 1 GHz:

Step 1:

The Equipment Under Test (EUT) was set up on a non-conductive support (tilt device) at 1.5 m height in the fully-anechoic chamber.

All steps were performed with one height (1.5 m) of the receiving antenna only.

The EUT is turned during the preliminary measurement across the elevation axis, with a step size of 45° .

The turn table step size (azimuth angle) for the preliminary measurement is 45° .

- Antenna distance: 3 m
- Detector: Peak
- RBW: 1 MHz
- VBW: 3 MHz
- Sweep time: coupled
- Turntable angle range: -180° to 135°
- Turntable step size: 45°
- Polarisation: Horizontal + Vertical

Step 2:

Due to the fact, that in this frequency range the test is performed in a fully anechoic room, the height scan of the receiving antenna in step 2 is omitted. Instead of this, a maximum search with a step size $\pm 45^\circ$ for the elevation axis is performed.

The turn table azimuth will slowly vary by $\pm 22.5^\circ$.

The elevation angle will slowly vary by $\pm 45^\circ$

EMI receiver settings (for all steps):

- Detector: Peak,
- RBW: 1 MHz
- VBW: 3 MHz
- Sweep time: coupled

Step 3:

Spectrum analyser settings for step 3:

- Detector: RMS
- Measured frequencies: in step 1 determined frequencies
- RBW: 1 MHz
- VBW: 3 MHz
- Sweep Time: 1 s

5.25.2 TEST REQUIREMENTS / LIMITS

FCC Part 2.1051; Measurement required: Spurious emissions at antenna terminal:

The radio frequency voltage or powers generated within the equipment and appearing on a spurious frequency shall be checked at the equipment output terminals when properly loaded with a suitable artificial antenna. Curves or equivalent data shall show the magnitude of each harmonic and other spurious emission that can be detected when the equipment is operated under the conditions specified in §2.1049 as appropriate. The magnitude of spurious emissions which are attenuated more than 20 dB below the permissible value need not be specified.

Part 90; PRIVATE LAND MOBILE RADIO SERVICES

Subpart R—Regulations Governing the Licensing and Use of Frequencies in the 763-775 and 793-805 MHz Bands

§90.543 – Emission limitations.

(a) The adjacent channel power (ACP) requirements for transmitters designed for various channel sizes are shown in the following tables. Mobile station requirements apply to handheld, car mounted and control station units. The tables specify a value for the ACP as a function of the displacement from the channel center frequency and measurement bandwidth. In the following tables, "(s)" indicates a swept measurement may be used.

Subpart S—Regulations Governing the Licensing and Use of Frequencies in the 806-824, 851-869, 869-901 and 935-940 MHz Bands

§90.543 – Emission limitations.

(a) On any frequency in an MTA licensee's spectrum block that is adjacent to a non-MTA frequency, the power of any emission shall be attenuated below the transmitter power (P) by at least 43 plus $10 \log_{10}(P)$ decibels or 80 decibels, whichever is the lesser attenuation.

Note: The measurements of emission power can be expressed in peak or average values, provided they are expressed in the same parameters as the transmitter power.

(b) When an emission outside of the authorized bandwidth causes harmful interference, the Commission may, at its discretion, require greater attenuation than specified in this section.

5.25.3 TEST PROTOCOL

Ambient temperature: 24 °C
Relative humidity: 38 %

Radio Technology	Channel	Detector	Trace	Resolution Bandwidth /kHz	Frequency /MHz	Peak Value /dBm	Limit /dBm	Margin to Limit /dB
eFDD26	low	rms	maxhold	100	813.9	-27.47	-13	14.47
eFDD26	mid	rms	maxhold	-	-	-	-13	>20
eFDD26	high	rms	maxhold	-	-	-	-13	>20

Remark: Please see next sub-clause for the measurement plot.

5.25.4 MEASUREMENT PLOT (SHOWING THE HIGHEST VALUE, "WORST CASE")

CAT-M1 eFDD 26 QPSK, RB=1, Channel = low
30 MHz - 1 GHz

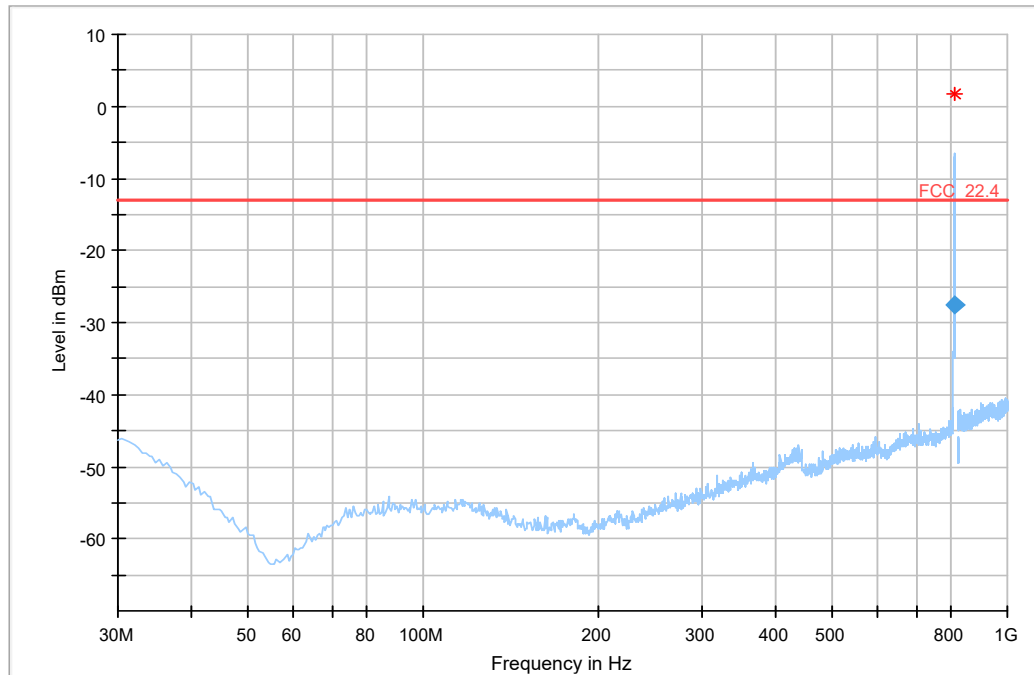

Final Result

Frequency (MHz)	RMS (dBm)	Limit (dBm)	Margin (dB)	Meas. Time (ms)	Bandwidth (kHz)	Height (cm)	Pol	Azimuth (deg)	Corr. (dB)
813.938000	-27.47	-13.00	14.47	1000.0	100.000	110.0	H	80.0	-74.2

1 GHz – 20 GHz

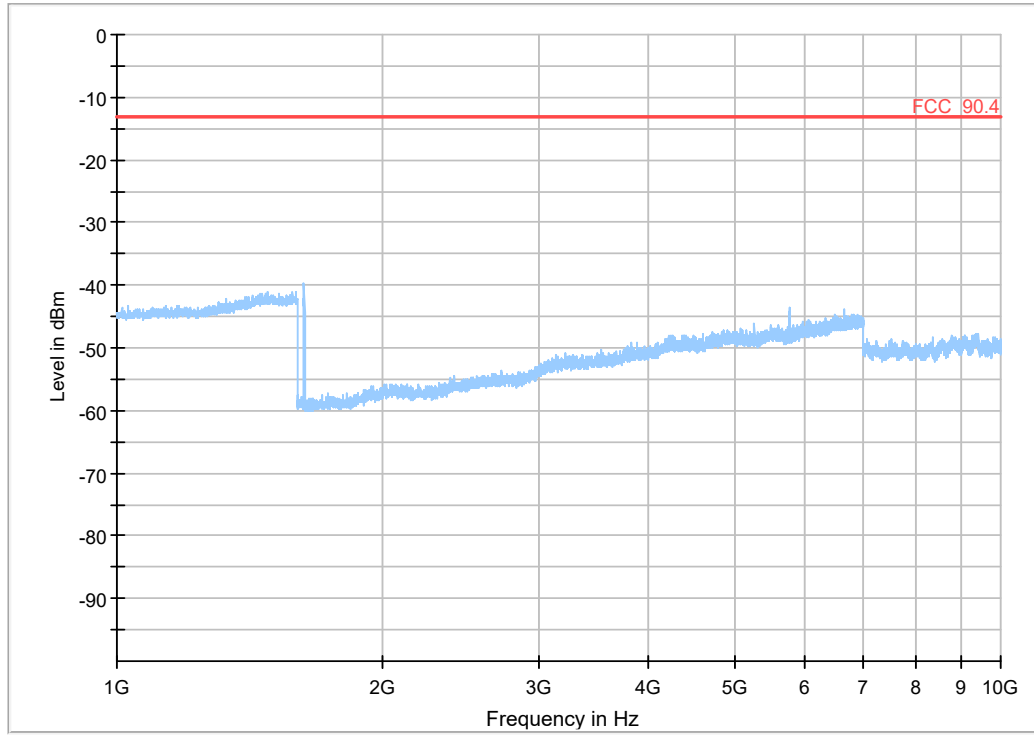

5.25.5 TEST EQUIPMENT USED

- Radiated Emissions

5.26 EMISSION AND OCCUPIED BANDWIDTH

Standard **FCC PART 90 Subpart S**

The test was performed according to:
ANSI C63.26: 2015

5.26.1 TEST DESCRIPTION

This test case is intended to demonstrate compliance to the applicable conducted spurious emission test case per FCC §2.1049 and RSS-GEN 6.7. The limit and the requirements come from the applicable rule part and ISSED RSS-Standard for the operating band of the cellular device.

The EUT was connected to the test setups according to the following diagram:

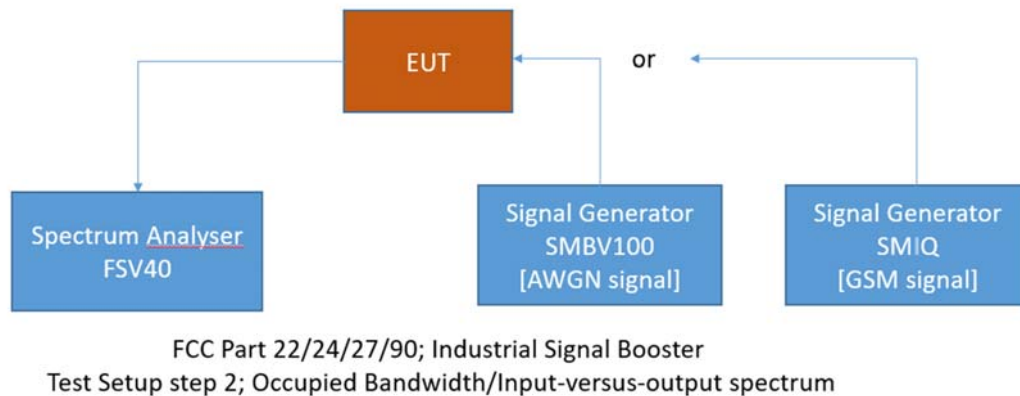
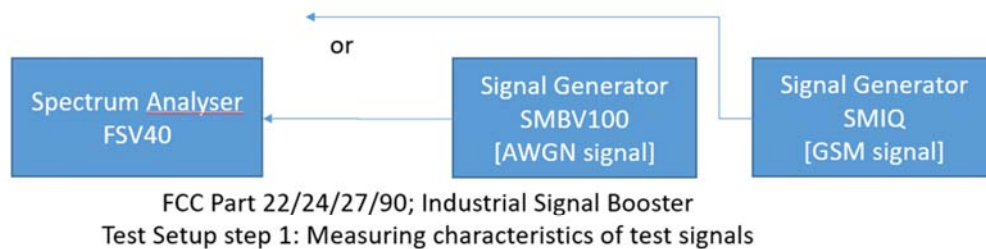

The attenuation of the measuring and stimulus path are known for each measured frequency and are considered.

The Spectrum Analyzer settings can be directly found in the measurement diagrams.

5.26.2 TEST REQUIREMENTS / LIMITS

FCC Part 2.1049; Occupied Bandwidth:

The occupied bandwidth, that is the frequency bandwidth such that, below its lower and above its upper frequency limits, the mean powers radiated are each equal to 0.5 percent of the total mean power radiated by a given emission shall be measured under the following conditions as applicable:

(h) Transmitters employing digital modulation techniques—when modulated by an input signal such that its amplitude and symbol rate represent the maximum rated conditions under which the equipment will be operated. The signal shall be applied through any filter networks, pseudo-random generators or other devices required in normal service. Additionally, the occupied bandwidth shall be shown for operation with any devices used for modifying the spectrum when such devices are optional at the discretion of the user.

(i) Transmitters designed for other types of modulation—when modulated by an appropriate signal of sufficient amplitude to be representative of the type of service in which used. A description of the input signal should be supplied.

RSS-GEN; 6.7 Occupied Bandwidth

The emission bandwidth (\times dB) is defined as the frequency range between two points, one above and one below the carrier frequency, at which the spectral density of the emission is attenuated \times dB below the maximum in-band spectral density of the modulated signal. Spectral density (power per unit bandwidth) is to be measured with a detector of resolution bandwidth in the range of 1% to 5% of the anticipated emission bandwidth, and a video bandwidth at least $3\times$ the resolution bandwidth.

When the occupied bandwidth limit is not stated in the applicable RSS or reference measurement method, the transmitted signal bandwidth shall be reported as the 99% emission bandwidth, as calculated or measured.

The transmitter shall be operated at its maximum carrier power measured under normal test conditions.

The span of the analyzer shall be set to capture all products of the modulation process, including the emission skirts.

The resolution bandwidth (RBW) shall be in the range of 1% to 5% of the occupied bandwidth (OBW) and video bandwidth (VBW) shall be approximately $3\times$ RBW.

Note: Video averaging is not permitted.

A peak, or peak hold, may be used in place of the sampling detector as this may produce a wider bandwidth than the actual bandwidth (worst-case measurement). Use of a peak hold may be necessary to determine the occupied bandwidth if the device is not transmitting continuously.

The trace data points are recovered and are directly summed in linear power level terms. The recovered amplitude data points, beginning at the lowest frequency, are placed in a running sum until 0.5% of the total is reached and that frequency recorded. The process is repeated for the highest frequency data points (starting at the highest frequency, at the right side of the span, and going down in frequency). This frequency is then recorded. The difference between the two recorded frequencies is the 99% occupied bandwidth.

5.26.3 TEST PROTOCOL

Ambient temperature: 24 °C
Relative humidity: 38 %

Radio Technology	Channel	Ressource Blocks	Bandwidth (MHz)	Nominal BW [MHz]	99 % BW [kHz]
eFDD 26 QPSK	low	6	1.4	1.4	1124.25
eFDD 26 QPSK	mid	6	1.4	1.4	1130.26
eFDD 26 QPSK	high	6	1.4	1.4	1124.25
eFDD 26 16QAM	low	5	1.4	1.4	967.94
eFDD 26 16QAM	mid	5	1.4	1.4	961.92
eFDD 26 16QAM	high	5	1.4	1.4	961.92

Remark: Please see next sub-clause for the measurement plot.

5.26.4 MEASUREMENT PLOT (SHOWING THE HIGHEST VALUE, "WORST CASE")

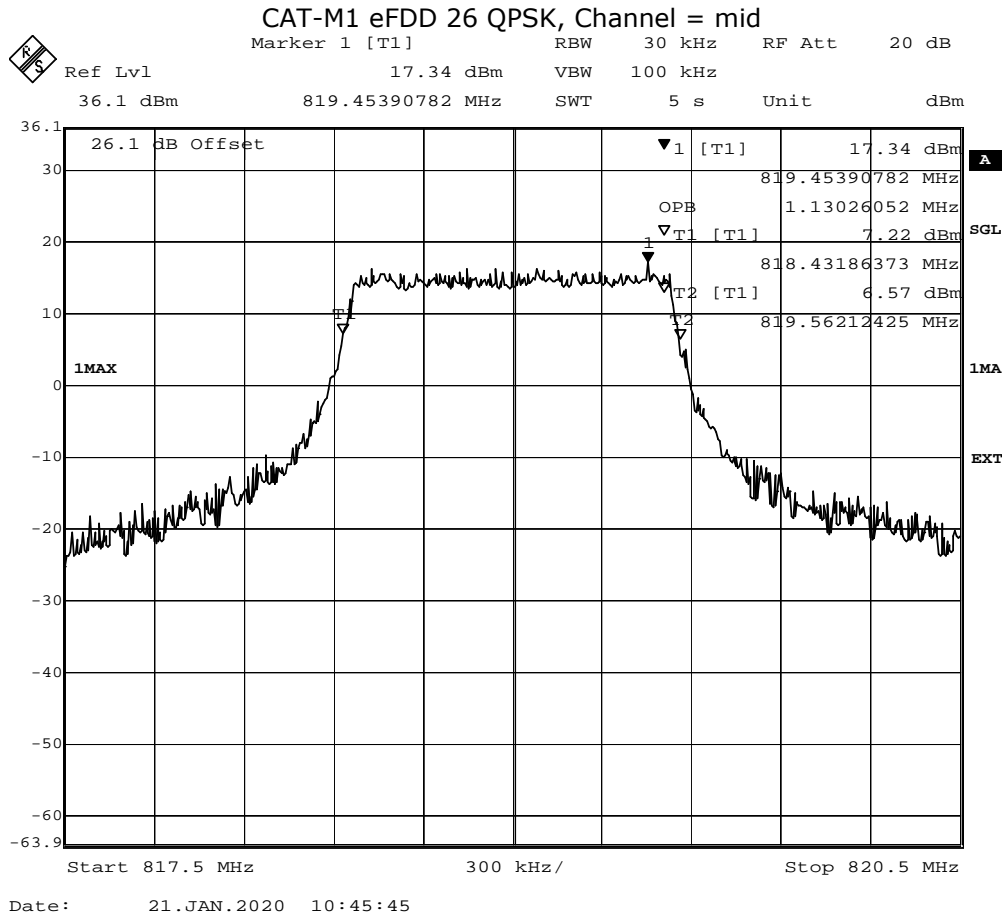

5.26.5 TEST EQUIPMENT USED

- Radio Lab

5.27 PEAK TO AVERAGE RATIO

Standard **FCC PART 90 Subpart S**

The test was performed according to:
ANSI C63.26: 2015

5.27.1 TEST DESCRIPTION

This test case is intended to demonstrate compliance of the EUT to the peak-to-average limits and requirements of the applicable rule part and ISED RSS-Standard for the operating band of the cellular device.

The EUT was connected to the test setup according to the following diagram:

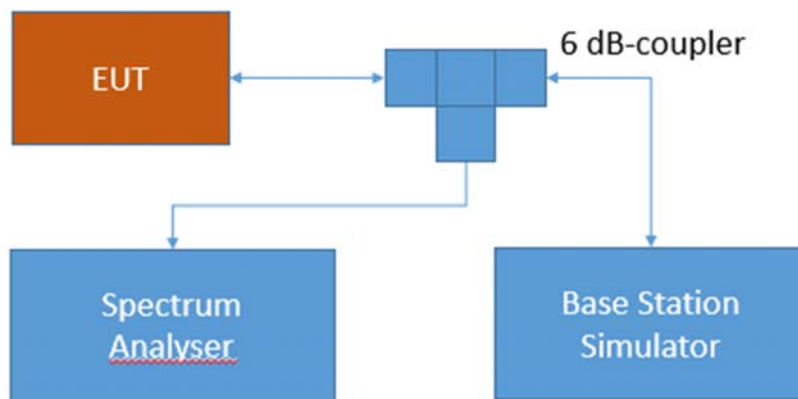

Test Setup FCC Part 22/24/27/90 Cellular;
Peak-average ratio

The attenuation of the measuring and stimulus path are known for each measured frequency and are considered.

The Spectrum Analyser settings can be directly found in the measurement diagrams. The internal CCDF (complementary cumulative distribution function) of the spectrum analyser is used for this measurement

5.27.2 TEST REQUIREMENTS / LIMITS

Part 90; PRIVATE LAND MOBILE RADIO SERVICES

Subpart S—Regulations Governing Licensing and Use of Frequencies in the 806-824, 851-869, 896-901, and 935-940 MHz Bands

§90.635 Limitations on power and antenna height.

(b) The maximum output power of the transmitter for mobile stations is 100 watts (20 dBw).

5.27.3 TEST PROTOCOL

Ambient temperature: 24 °C
Relative humidity: 38 %

Radio Technology	Channel	Res- source Blocks	Bandwidth [MHz]	Peak to Average Ratio	Limit (IC) [dB]
CAT-M1 eFDD 26 QPSK	low	6	1.4	6.67	13
CAT-M1 eFDD 26 QPSK	mid	6	1.4	7.54	13
CAT-M1 eFDD 26 QPSK	high	6	1.4	7.54	13
CAT-M1 eFDD 26 16QAM	low	5	1.4	8.35	13
CAT-M1 eFDD 26 16QAM	mid	5	1.4	8.03	13
CAT-M1 eFDD 26 16QAM	high	5	1.4	8.61	13

Remark: Please see next sub-clause for the measurement plot.

5.27.4 MEASUREMENT PLOT (SHOWING THE HIGHEST VALUE, "WORST CASE")
 CAT-M1 eFDD 26 16QAM, Channel = high

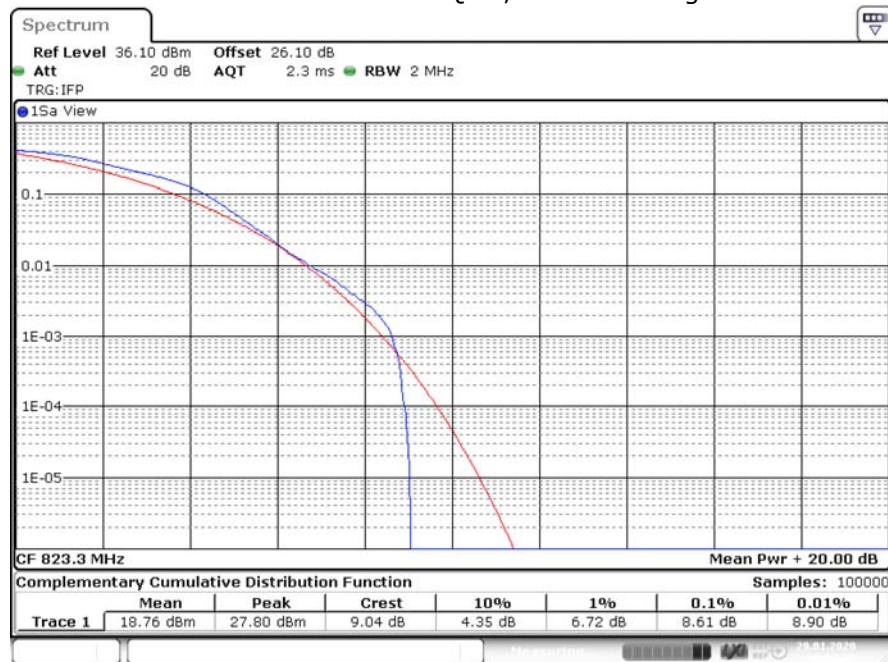

Date: 29.JAN.2020 09:50:23

5.27.5 TEST EQUIPMENT USED

- Radio Lab

6 TEST EQUIPMENT

- 1 Radiated Emissions
Lab to perform radiated emission tests

Ref.No.	Device Name	Description	Manufacturer	Serial Number	Last Calibration	Calibration Due
1.1	MFS	Rubidium Frequency Normal MFS	Datum GmbH	002	2019-10	2020-10
1.2	N5000/NP	Filter for EUT, 2 Lines, 250 V, 16 A	ETS-LINDGREN	241515		
1.3	Opus10 TPR (8253.00)	T/P Logger 13	Lufft Mess- und Regeltechnik GmbH	13936	2019-05	2021-05
1.4	ESW44	EMI Receiver / Spectrum Analyzer	Rohde & Schwarz GmbH & Co. KG	101603	2019-12	2021-12
1.5	Anechoic Chamber 01	SAC/FAR, 10.58 m x 6.38 m x 6.00 m	Frankonia	none	2018-06	2020-06
1.6	HL 562 ULTRALOG	Biconical-log-per antenna (30 MHz - 3 GHz) with HL 562E biconicals	Rohde & Schwarz GmbH & Co. KG	830547/003	2018-07	2021-07
1.7	AMF-7D00101800-30-10P-R	Broadband Amplifier 100 MHz - 18 GHz	Miteq			
1.8	5HC2700/12750-1.5-KK	High Pass Filter	Trilithic	9942012		
1.9	ASP 1.2/1.8-10 kg	Antenna Mast	Maturo GmbH	-		
1.10	Anechoic Chamber 03	FAR, 8.80m x 4.60m x 4.05m (l x w x h)	Albatross Projects	P26971-647-001-PRB	2018-06	2020-06
1.11	SMBV100A	Vector Signal Generator 9 kHz - 3.2 GHz (GNSS / Broadcast Signalling Unit)	Rohde & Schwarz GmbH & Co. KG	260001	2018-01	2021-01
1.12	Fluke 177	Digital Multimeter 03 (Multimeter)	Fluke Europe B.V.	86670383	2018-04	2020-04
1.13	WRD1920/1980-5/22-5EESD	Tunable Band Reject Filter	Wainwright Instruments GmbH	11		
1.14	TDS 784C	Digital Oscilloscope [SA2] (Aux)	Tektronix	B021311		
1.15	foRS232 Unit 2	Fibre optic link RS232	PONTIS Messtechnik GmbH	4031516037		
1.16	PONTIS Con4101	PONTIS Camera Controller		6061510370		

Ref.No.	Device Name	Description	Manufacturer	Serial Number	Last Calibration	Calibration Due
1.17	NRVD	Power Meter	Rohde & Schwarz GmbH & Co. KG	828110/016	2019-08	2020-08
1.18	OLS-1 R	Fibre optic link USB 1.1	Ingenieurbüro Scheiba	018		
1.19	HF 906	Double-ridged horn	Rohde & Schwarz	357357/002	2018-09	2021-09
1.20	JS4-18002600-32-5P	Broadband Amplifier 18 GHz - 26 GHz	Miteq	849785		
1.21	FSW 43	Spectrum Analyzer	Rohde & Schwarz	103779	2019-02	2021-02
1.22	3160-09	Standard Gain / Pyramidal Horn Antenna 26.5 GHz	EMCO Elektronik GmbH	00083069		
1.23	foRS232 Unit 1	Fibre optic link RS232	PONTIS Messtechnik GmbH	4021516036		
1.24	FSP3	Spectrum Analyzer	Rohde & Schwarz GmbH & Co. KG	836722/011		
1.25	WHKX 7.0/18G-8SS	High Pass Filter	Wainwright Instruments GmbH	09		
1.26	DS 420S	Turn Table 2 m diameter	HD GmbH	420/573/99		
1.27	4HC1600/12750-1.5-KK	High Pass Filter	Trilithic	9942011		
1.28	foUSB-M Converter 2	Fibre optic link USB 2.0	PONTIS Messtechnik GmbH	4471520061		
1.29	WRCD1879.8-0.2/40-10EE	Notch Filter Ultra Stable	Wainwright Instruments GmbH	16		
1.30	SMB100A	Signal Generator 100 kHz - 40 GHz	Rohde & Schwarz Vertriebs-GmbH	181486	2019-11	2021-11
1.31	JS4-00102600-42-5A	Broadband Amplifier 30 MHz - 26 GHz	Miteq	619368		
1.32	TT 1.5 WI	Turn Table	Maturo GmbH	-		
1.33	HL 562 ULTRALOG	Biconical-log-per Antenna (30 MHz - 3 GHz)	Rohde & Schwarz GmbH & Co. KG	100609	2019-05	2022-05
1.34	HF 906	Double-ridged horn	Rohde & Schwarz	357357/001	2018-03	2021-03
1.35	foCAN (v 4.0)	Fibre optic link CAN	Audio GmbH (PONTIS EMC)	492 1607 014		
1.36	CMW 500	CMW 500 Flex 2	Rohde & Schwarz GmbH & Co. KG	155999-Ei	2019-09	2022-09
1.37	CMU 200	"CMU1" Universal Radio Communication Tester	Rohde & Schwarz GmbH & Co. KG	102366	2017-12	2020-12
1.38	3160-10	Standard Gain / Pyramidal Horn Antenna 40 GHz	EMCO Elektronik GmbH	00086675		
1.39	MA4985-XP-ET	Bore Sight Antenna Mast	innco systems GmbH	none		

Ref.No.	Device Name	Description	Manufacturer	Serial Number	Last Calibration	Calibration Due
1.40	CBT	Bluetooth Tester "CBT-02" incl. BLE-Option	Rohde & Schwarz	100302	2018-03	2021-03
1.41	CMW 500	callbox with SUA, BT, 2G, 3G, LTE, AUDIO, UL/DL fading	Rohde & Schwarz GmbH & Co. KG	163529-bw	2017-07	2020-07
1.42	A8455-4	4 Way Power Divider (SMA)		-		
1.43	JUN-AIR Mod. 6-15	Air Compressor	JUN-AIR Deutschland GmbH	612582		
1.44	foEthernet_M	Fibre optic link Ethernet / Gb-LAN	PONTIS Messtechnik GmbH	4841516023		
1.45	5HC3500/18000-1.2-KK	High Pass Filter	Trilithic	200035008		
1.46	OLS-1 M	Fibre optic link USB 1.1	Ingenieurbüro Scheiba	018		
1.47	HFH2-Z2	Loop Antenna	Rohde & Schwarz	829324/006	2018-01	2021-01
1.48	Voltcraft M-3860M	Digital Multimeter 01 (Multimeter)	Conrad	IJ096055		
1.49	CMW 500	callbox, 2G, 3G, LTE, WLAN, BT, Audio	Rohde & Schwarz GmbH & Co. KG	149268-Qf	2018-04	2021-04
1.50	Opus10 THI (8152.00)	T/H Logger 12	Lufft Mess- und Regeltechnik GmbH	12482	2019-06	2021-06
1.51	UNI-T UT195E	True RMS Digital Multimeter	UNI-T UNI-TREND TECHNOLOGY (CHINA) CO., LTD.	C190729561		
1.52	foEthernet_M	Fibre optic link Ethernet / Gb-LAN	PONTIS Messtechnik GmbH	4841516022		
1.53	JS4-00101800-35-5P	Broadband Amplifier 30 MHz - 18 GHz	Miteq	896037		
1.54	AS 620 P	Antenna Mast (pneumatic polarisation)	HD GmbH	620/37		
1.55	6005D (30 V / 5 A)	Laboratory Power Supply 120 V 60 Hz	Peaktech	81062045		
1.56	TD1.5-10kg	EUT Tilt Device (Rohacell)	Maturo GmbH	TD1.5-10kg/024/3790709		
1.57	Innco Systems CO3000	Controller for bore sight mast SAC	innco systems GmbH	CO3000/967/39371016/L		
1.58	NRV-Z1	Sensor Head B	Rohde & Schwarz GmbH & Co. KG	827753/006	2019-08	2020-08
1.59	HF 907-2	Double-ridged horn	Rohde & Schwarz	102817	2019-04	2022-04
1.60	foCAN (v 4.0)	Fibre optic link CAN	Audivo GmbH (PONTIS EMC)	492 1607 013		
1.61	PAS 2.5 - 10 kg	Antenna Mast	Maturo GmbH	-		

Ref.No.	Device Name	Description	Manufacturer	Serial Number	Last Calibration	Calibration Due
1.62	AFS42-00101800-25-S-42	Broadband Amplifier 25 MHz - 18 GHz	Miteq	2035324		
1.63	WRCA800/960-0.2/40-6EEK	Tunable Notch Filter	Wainwright Instruments GmbH	20		
1.64	AM 4.0	Antenna Mast 4 m	Maturo GmbH	AM4.0/180/11920513		
1.65	HF 907	Double-ridged horn	Rohde & Schwarz	102444	2018-07	2021-07
1.66	E4408B	Spectrum Analyser (9 kHz to 26.5 GHz)	Agilent Technologies Deutschland GmbH	MY45103714		

2 Radio Lab
Conducted Radio Test Lab

Ref.No.	Device Name	Description	Manufacturer	Serial Number	Last Calibration	Calibration Due
2.1	SMB100A	Signal Generator 9 kHz - 6 GHz	Rohde & Schwarz	107695	2017-07	2020-07
2.2	1575	Broadband Resistive Power Divider DC to 40 GHz	API Weinschel, Inc.	4070		
2.3	FSV30	Signal Analyzer 10 Hz - 30 GHz	Rohde & Schwarz	103005	2018-04	2020-04
2.4	Fluke 177	Digital Multimeter 03 (Multimeter)	Fluke Europe B.V.	86670383	2018-04	2020-04
2.5	WRD1920/1980-5/22-5EESD	Tunable Band Reject Filter	Wainwright Instruments GmbH	11		
2.6	WRCD1879.8-0.2/40-10EE	Notch Filter Ultra Stable	Wainwright Instruments GmbH	16		
2.7	FSIQ26	Signal Analyser 20 Hz to 26.5 GHz	Rohde & Schwarz GmbH & Co. KG	840061/005	2019-06	2021-06
2.8	Chroma 6404	AC Source	Chroma ATE INC.	64040001304		
2.9	Temperature Chamber VT 4002	Temperature Chamber Vötsch 03	Vötsch	58566002150010	2018-04	2020-04
2.10	A8455-4	4 Way Power Divider (SMA)		-		
2.11	Opus10 THI (8152.00)	T/H Logger 03	Lufft Mess- und Regeltechnik GmbH	7482	2019-06	2021-06
2.12	UNI-T UT195E	True RMS Digital Multimeter	UNI-T UNI-TREND TECHNOLOGY (CHINA) CO., LTD.	C190729561		
2.13	SMBV100A	Vector Signal Generator 9 kHz - 6 GHz	Rohde & Schwarz	259291	2019-11	2022-11
2.14	Temperature Chamber VT 4002	Temperature Chamber Vötsch 05	Vötsch	58566080550010	2018-04	2020-04

Ref.No.	Device Name	Description	Manufacturer	Serial Number	Last Calibration	Calibration Due
2.15	WRCA800/960-0.2/40-6EEK	Tunable Notch Filter	Wainwright Instruments GmbH	20		

The calibration interval is the time interval between "Last Calibration" and "Calibration Due"

7 ANTENNA FACTORS, CABLE LOSS AND SAMPLE CALCULATIONS

This chapter contains the antenna factors with their corresponding path loss of the used measurement path for all antennas as well as the insertion loss of the LISN.

7.1 LISN R&S ESH3-Z5 (150 KHZ – 30 MHZ)

Frequency MHz	Corr. dB	LISN insertion loss ESH3- Z5 dB	cable loss (incl. 10 dB atten- uator) dB
0.15	10.1	0.1	10.0
5	10.3	0.1	10.2
7	10.5	0.2	10.3
10	10.5	0.2	10.3
12	10.7	0.3	10.4
14	10.7	0.3	10.4
16	10.8	0.4	10.4
18	10.9	0.4	10.5
20	10.9	0.4	10.5
22	11.1	0.5	10.6
24	11.1	0.5	10.6
26	11.2	0.5	10.7
28	11.2	0.5	10.7
30	11.3	0.5	10.8

Sample calculation

$U_{LISN} \text{ (dB } \mu\text{V)} = U \text{ (dB } \mu\text{V)} + \text{Corr. (dB)}$
 $U = \text{Receiver reading}$
 LISN Insertion loss = Voltage Division Factor of LISN
 Corr. = sum of single correction factors of used LISN, cables, switch units (if used)
 Linear interpolation will be used for frequencies in between the values in the table.

7.2 ANTENNA R&S HFH2-Z2 (9 KHZ – 30 MHZ)

Frequency MHz	AF HFH-Z2		cable loss 1 (inside chamber)	cable loss 2 (outside chamber)	cable loss 3 (switch unit)	cable loss 4 (to receiver)	distance corr. (-40 dB/ decade)	d _{Limit} (meas. distance (limit))	d _{used} (meas. distance (used))
	dB (1/m)	Corr. dB							
0.009	20.50	-79.6	0.1	0.1	0.1	0.1	-80	300	3
0.01	20.45	-79.6	0.1	0.1	0.1	0.1	-80	300	3
0.015	20.37	-79.6	0.1	0.1	0.1	0.1	-80	300	3
0.02	20.36	-79.6	0.1	0.1	0.1	0.1	-80	300	3
0.025	20.38	-79.6	0.1	0.1	0.1	0.1	-80	300	3
0.03	20.32	-79.6	0.1	0.1	0.1	0.1	-80	300	3
0.05	20.35	-79.6	0.1	0.1	0.1	0.1	-80	300	3
0.08	20.30	-79.6	0.1	0.1	0.1	0.1	-80	300	3
0.1	20.20	-79.6	0.1	0.1	0.1	0.1	-80	300	3
0.2	20.17	-79.6	0.1	0.1	0.1	0.1	-80	300	3
0.3	20.14	-79.6	0.1	0.1	0.1	0.1	-80	300	3
0.49	20.12	-79.6	0.1	0.1	0.1	0.1	-80	300	3
0.490001	20.12	-39.6	0.1	0.1	0.1	0.1	-40	30	3
0.5	20.11	-39.6	0.1	0.1	0.1	0.1	-40	30	3
0.8	20.10	-39.6	0.1	0.1	0.1	0.1	-40	30	3
1	20.09	-39.6	0.1	0.1	0.1	0.1	-40	30	3
2	20.08	-39.6	0.1	0.1	0.1	0.1	-40	30	3
3	20.06	-39.6	0.1	0.1	0.1	0.1	-40	30	3
4	20.05	-39.5	0.2	0.1	0.1	0.1	-40	30	3
5	20.05	-39.5	0.2	0.1	0.1	0.1	-40	30	3
6	20.02	-39.5	0.2	0.1	0.1	0.1	-40	30	3
8	19.95	-39.5	0.2	0.1	0.1	0.1	-40	30	3
10	19.83	-39.4	0.2	0.1	0.2	0.1	-40	30	3
12	19.71	-39.4	0.2	0.1	0.2	0.1	-40	30	3
14	19.54	-39.4	0.2	0.1	0.2	0.1	-40	30	3
16	19.53	-39.3	0.3	0.1	0.2	0.1	-40	30	3
18	19.50	-39.3	0.3	0.1	0.2	0.1	-40	30	3
20	19.57	-39.3	0.3	0.1	0.2	0.1	-40	30	3
22	19.61	-39.3	0.3	0.1	0.2	0.1	-40	30	3
24	19.61	-39.3	0.3	0.1	0.2	0.1	-40	30	3
26	19.54	-39.3	0.3	0.1	0.2	0.1	-40	30	3
28	19.46	-39.2	0.3	0.1	0.3	0.1	-40	30	3
30	19.73	-39.1	0.4	0.1	0.3	0.1	-40	30	3

Sample calculation

$$E \text{ (dB } \mu\text{V/m)} = U \text{ (dB } \mu\text{V)} + \text{AF (dB 1/m)} + \text{Corr. (dB)}$$

U = Receiver reading

AF = Antenna factor

Corr. = sum of single correction factors of used cables, switch unit, distance correction, amplifier (if applicable)

distance correction = $-40 * \text{LOG} (d_{\text{Limit}} / d_{\text{used}})$

Linear interpolation will be used for frequencies in between the values in the table.

Table shows an extract of values

7.3 ANTENNA R&S HL562 (30 MHZ – 1 GHZ)

($d_{Limit} = 3 \text{ m}$)

Frequency	AF R&S HL562	Corr.	cable loss 1 (inside chamber)	cable loss 2 (outside chamber)	cable loss 3 (switch unit)	cable loss 4 (to receiver)	distance corr. (-20 dB/decade)	d_{Limit} (meas. distance (limit))	d_{used} (meas. distance (used))
MHz	dB (1/m)	dB	dB	dB	dB	dB	dB	m	m
30	18.6	0.6	0.29	0.04	0.23	0.02	0.0	3	3
50	6.0	0.9	0.39	0.09	0.32	0.08	0.0	3	3
100	9.7	1.2	0.56	0.14	0.47	0.08	0.0	3	3
150	7.9	1.6	0.73	0.20	0.59	0.12	0.0	3	3
200	7.6	1.9	0.84	0.21	0.70	0.11	0.0	3	3
250	9.5	2.1	0.98	0.24	0.80	0.13	0.0	3	3
300	11.0	2.3	1.04	0.26	0.89	0.15	0.0	3	3
350	12.4	2.6	1.18	0.31	0.96	0.13	0.0	3	3
400	13.6	2.9	1.28	0.35	1.03	0.19	0.0	3	3
450	14.7	3.1	1.39	0.38	1.11	0.22	0.0	3	3
500	15.6	3.2	1.44	0.39	1.20	0.19	0.0	3	3
550	16.3	3.5	1.55	0.46	1.24	0.23	0.0	3	3
600	17.2	3.5	1.59	0.43	1.29	0.23	0.0	3	3
650	18.1	3.6	1.67	0.34	1.35	0.22	0.0	3	3
700	18.5	3.6	1.67	0.42	1.41	0.15	0.0	3	3
750	19.1	4.1	1.87	0.54	1.46	0.25	0.0	3	3
800	19.6	4.1	1.90	0.46	1.51	0.25	0.0	3	3
850	20.1	4.4	1.99	0.60	1.56	0.27	0.0	3	3
900	20.8	4.7	2.14	0.60	1.63	0.29	0.0	3	3
950	21.1	4.8	2.22	0.60	1.66	0.33	0.0	3	3
1000	21.6	4.9	2.23	0.61	1.71	0.30	0.0	3	3

($d_{Limit} = 10 \text{ m}$)

30	18.6	-9.9	0.29	0.04	0.23	0.02	-10.5	10	3
50	6.0	-9.6	0.39	0.09	0.32	0.08	-10.5	10	3
100	9.7	-9.2	0.56	0.14	0.47	0.08	-10.5	10	3
150	7.9	-8.8	0.73	0.20	0.59	0.12	-10.5	10	3
200	7.6	-8.6	0.84	0.21	0.70	0.11	-10.5	10	3
250	9.5	-8.3	0.98	0.24	0.80	0.13	-10.5	10	3
300	11.0	-8.1	1.04	0.26	0.89	0.15	-10.5	10	3
350	12.4	-7.9	1.18	0.31	0.96	0.13	-10.5	10	3
400	13.6	-7.6	1.28	0.35	1.03	0.19	-10.5	10	3
450	14.7	-7.4	1.39	0.38	1.11	0.22	-10.5	10	3
500	15.6	-7.2	1.44	0.39	1.20	0.19	-10.5	10	3
550	16.3	-7.0	1.55	0.46	1.24	0.23	-10.5	10	3
600	17.2	-6.9	1.59	0.43	1.29	0.23	-10.5	10	3
650	18.1	-6.9	1.67	0.34	1.35	0.22	-10.5	10	3
700	18.5	-6.8	1.67	0.42	1.41	0.15	-10.5	10	3
750	19.1	-6.3	1.87	0.54	1.46	0.25	-10.5	10	3
800	19.6	-6.3	1.90	0.46	1.51	0.25	-10.5	10	3
850	20.1	-6.0	1.99	0.60	1.56	0.27	-10.5	10	3
900	20.8	-5.8	2.14	0.60	1.63	0.29	-10.5	10	3
950	21.1	-5.6	2.22	0.60	1.66	0.33	-10.5	10	3
1000	21.6	-5.6	2.23	0.61	1.71	0.30	-10.5	10	3

Sample calculation

$E \text{ (dB } \mu\text{V/m)} = U \text{ (dB } \mu\text{V)} + AF \text{ (dB 1/m)} + Corr. \text{ (dB)}$
 U = Receiver reading
 AF = Antenna factor
 Corr. = sum of single correction factors of used cables, switch unit, distance correction, amplifier (if applicable)
 distance correction = $-20 * \text{LOG} (d_{Limit} / d_{used})$
 Linear interpolation will be used for frequencies in between the values in the table.
 Tables show an extract of values.

7.4 ANTENNA R&S HF907 (1 GHZ – 18 GHZ)

Frequency	AF R&S HF907	Corr.
MHz	dB (1/m)	dB
1000	24.4	-19.4
2000	28.5	-17.4
3000	31.0	-16.1
4000	33.1	-14.7
5000	34.4	-13.7
6000	34.7	-12.7
7000	35.6	-11.0

cable loss 1 (relay + cable inside chamber)	cable loss 2 (outside chamber)	cable loss 3 (switch unit, atten- uator & pre-amp)	cable loss 4 (to receiver)		
dB	dB	dB	dB		
0.99	0.31	-21.51	0.79		
1.44	0.44	-20.63	1.38		
1.87	0.53	-19.85	1.33		
2.41	0.67	-19.13	1.31		
2.78	0.86	-18.71	1.40		
2.74	0.90	-17.83	1.47		
2.82	0.86	-16.19	1.46		

Frequency	AF R&S HF907	Corr.
MHz	dB (1/m)	dB
3000	31.0	-23.4
4000	33.1	-23.3
5000	34.4	-21.7
6000	34.7	-21.2
7000	35.6	-19.8

cable loss 1 (relay inside chamber)	cable loss 2 (inside chamber)	cable loss 3 (outside chamber)	cable loss 4 (switch unit, atten- uator & pre-amp)	cable loss 5 (to receiver)	used for FCC 15.247
dB	dB	dB	dB	dB	
0.47	1.87	0.53	-27.58	1.33	
0.56	2.41	0.67	-28.23	1.31	
0.61	2.78	0.86	-27.35	1.40	
0.58	2.74	0.90	-26.89	1.47	
0.66	2.82	0.86	-25.58	1.46	

Frequency	AF R&S HF907	Corr.
MHz	dB (1/m)	dB
7000	35.6	-57.3
8000	36.3	-56.3
9000	37.1	-55.3
10000	37.5	-56.2
11000	37.5	-55.3
12000	37.6	-53.7
13000	38.2	-53.5
14000	39.9	-56.3
15000	40.9	-54.1
16000	41.3	-54.1
17000	42.8	-54.4
18000	44.2	-54.7

cable loss 1 (relay inside chamber)	cable loss 2 (High Pass)	cable loss 3 (pre- amp)	cable loss 4 (inside chamber)	cable loss 5 (outside chamber)	cable loss 6 (to receiver)
dB	dB	dB	dB	dB	dB
0.56	1.28	-62.72	2.66	0.94	1.46
0.69	0.71	-61.49	2.84	1.00	1.53
0.68	0.65	-60.80	3.06	1.09	1.60
0.70	0.54	-61.91	3.28	1.20	1.67
0.80	0.61	-61.40	3.43	1.27	1.70
0.84	0.42	-59.70	3.53	1.26	1.73
0.83	0.44	-59.81	3.75	1.32	1.83
0.91	0.53	-63.03	3.91	1.40	1.77
0.98	0.54	-61.05	4.02	1.44	1.83
1.23	0.49	-61.51	4.17	1.51	1.85
1.36	0.76	-62.36	4.34	1.53	2.00
1.70	0.53	-62.88	4.41	1.55	1.91

Sample calculation

$$E \text{ (dB } \mu\text{V/m)} = U \text{ (dB } \mu\text{V)} + \text{AF (dB 1/m)} + \text{Corr. (dB)}$$

U = Receiver reading

AF = Antenna factor

Corr. = sum of single correction factors of used cables, switch unit, distance correction, amplifier (if applicable)

Linear interpolation will be used for frequencies in between the values in the table.

Tables show an extract of values.

7.5 ANTENNA EMCO 3160-09 (18 GHZ – 26.5 GHZ)

Frequency MHz	AF EMCO 3160-09 dB (1/m)	Corr. dB	cable loss 1 (inside chamber) dB	cable loss 2 (pre- amp) dB	cable loss 3 (inside chamber) dB	cable loss 4 (switch unit) dB	cable loss 5 (to receiver) dB
18000	40.2	-23.5	0.72	-35.85	6.20	2.81	2.65
18500	40.2	-23.2	0.69	-35.71	6.46	2.76	2.59
19000	40.2	-22.0	0.76	-35.44	6.69	3.15	2.79
19500	40.3	-21.3	0.74	-35.07	7.04	3.11	2.91
20000	40.3	-20.3	0.72	-34.49	7.30	3.07	3.05
20500	40.3	-19.9	0.78	-34.46	7.48	3.12	3.15
21000	40.3	-19.1	0.87	-34.07	7.61	3.20	3.33
21500	40.3	-19.1	0.90	-33.96	7.47	3.28	3.19
22000	40.3	-18.7	0.89	-33.57	7.34	3.35	3.28
22500	40.4	-19.0	0.87	-33.66	7.06	3.75	2.94
23000	40.4	-19.5	0.88	-33.75	6.92	3.77	2.70
23500	40.4	-19.3	0.90	-33.35	6.99	3.52	2.66
24000	40.4	-19.8	0.88	-33.99	6.88	3.88	2.58
24500	40.4	-19.5	0.91	-33.89	7.01	3.93	2.51
25000	40.4	-19.3	0.88	-33.00	6.72	3.96	2.14
25500	40.5	-20.4	0.89	-34.07	6.90	3.66	2.22
26000	40.5	-21.3	0.86	-35.11	7.02	3.69	2.28
26500	40.5	-21.1	0.90	-35.20	7.15	3.91	2.36

Sample calculation

$$E \text{ (dB } \mu\text{V/m)} = U \text{ (dB } \mu\text{V)} + \text{AF (dB 1/m)} + \text{Corr. (dB)}$$

U = Receiver reading

AF = Antenna factor

Corr. = sum of single correction factors of used cables, switch unit, distance correction, amplifier (if applicable)

Linear interpolation will be used for frequencies in between the values in the table.

Table shows an extract of values.

7.6 ANTENNA EMCO 3160-10 (26.5 GHZ – 40 GHZ)

Frequency GHz	AF EMCO 3160-10	Corr. dB	cable loss 1 (inside chamber)	cable loss 2 (outside chamber)	cable loss 3 (switch unit)	cable loss 4 (to receiver)	distance corr. (-20 dB/ decade)	d _{Limit} (meas. distance (limit))	d _{used} (meas. distance (used))
	dB (1/m)		dB	dB	dB	dB	dB	m	m
26.5	43.4	-11.2	4.4				-9.5	3	1.0
27.0	43.4	-11.2	4.4				-9.5	3	1.0
28.0	43.4	-11.1	4.5				-9.5	3	1.0
29.0	43.5	-11.0	4.6				-9.5	3	1.0
30.0	43.5	-10.9	4.7				-9.5	3	1.0
31.0	43.5	-10.8	4.7				-9.5	3	1.0
32.0	43.5	-10.7	4.8				-9.5	3	1.0
33.0	43.6	-10.7	4.9				-9.5	3	1.0
34.0	43.6	-10.6	5.0				-9.5	3	1.0
35.0	43.6	-10.5	5.1				-9.5	3	1.0
36.0	43.6	-10.4	5.1				-9.5	3	1.0
37.0	43.7	-10.3	5.2				-9.5	3	1.0
38.0	43.7	-10.2	5.3				-9.5	3	1.0
39.0	43.7	-10.2	5.4				-9.5	3	1.0
40.0	43.8	-10.1	5.5				-9.5	3	1.0

Sample calculation

$$E \text{ (dB } \mu\text{V/m)} = U \text{ (dB } \mu\text{V)} + AF \text{ (dB 1/m)} + Corr. \text{ (dB)}$$

U = Receiver reading

AF = Antenna factor

Corr. = sum of single correction factors of used cables, switch unit, distance correction, amplifier (if applicable)

Linear interpolation will be used for frequencies in between the values in the table.

distance correction = $-20 * \text{LOG} (d_{\text{Limit}} / d_{\text{used}})$

Linear interpolation will be used for frequencies in between the values in the table.

Table shows an extract of values.

8 MEASUREMENT UNCERTAINTIES

Test Case(s)	Parameter	Uncertainty
- Field strength of spurious radiation	Field Strength	± 5.5 dB
- Emission and Occupied Bandwidth	Power Frequency	± 2.9 dB ± 11.2 kHz
- RF Output Power - Peak to Average Ratio	Power	± 2.2 dB
- Band Edge Compliance - Spurious Emissions at Antenna Terminal	Power Frequency	± 2.2 dB ± 11.2 kHz
- Frequency Stability	Frequency	± 25 Hz

The measurement uncertainties for all parameters are calculated with an expansion factor (coverage factor) $k = 1.96$. This means, that the true value is in the corresponding interval with a probability of 95 %.

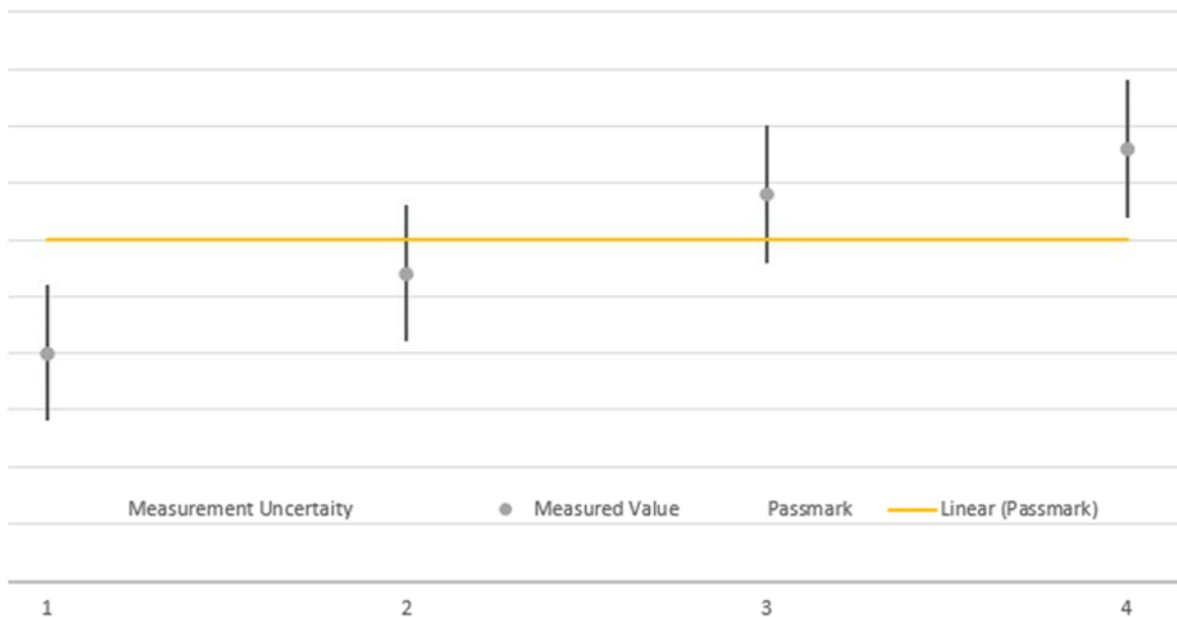

The verdicts in this test report are given according the above diagram:

Case	Measured Value	Uncertainty Range	Verdict
1	below pass mark	below pass mark	Passed
2	below pass mark	within pass mark	Passed
3	above pass mark	within pass mark	Failed
4	above pass mark	above pass mark	Failed

That means, the laboratory applies, as decision rule (see ISO/IEC 17025:2017), the so called shared risk principle.

9 PHOTO REPORT

Please see separate photo report.