



Test Report No.: W7L-P22080014RF03



FCC TEST REPORT (PART 27)

Applicant:	Particle Industries, Inc
Address:	325 9th Street, San Francisco, CA 94103, United States Of America

Manufacturer or Supplier:	Particle Industries, Inc
Address:	325 9th Street, San Francisco, CA 94103, United States Of America
Product:	TC-3
Brand Name:	FarmHQ
Model Name:	MON404-CODA
FCC ID:	2AEMI-CODA
Date of tests:	Aug. 15, 2022 ~ Sep. 26, 2022

The tests have been carried out according to the requirements of the following standard:

- FCC Part 27, Subpart C, M ANSI/TIA/EIA-603-D
- FCC Part 2 ANSI/TIA/EIA-603-E ANSI C63.26-2015

CONCLUSION: The submitted sample was found to COMPLY with the test requirement

Prepared by Simon Wang Engineer / Mobile Department	Approved by Luke Lu Manager / Mobile Department
Date: Sep. 26, 2022	Date: Sep. 26, 2022

This report is governed by, and incorporates by reference, the Conditions of Testing as posted at the date of issuance of this report at <http://www.bureauveritas.com/home/about-us/our-business/cps/about-us/terms-conditions/> and is intended for your exclusive use. Any copying or replication of this report to or for any other person or entity, or use of our name or trademark, is permitted only with our prior written permission. This report sets forth our findings solely with respect to the test samples identified herein. The results set forth in this report are not indicative or representative of the quality or characteristics of the lot from which a test sample was taken or any similar or identical product unless specifically and expressly noted. Our report includes all of the tests requested by you and the results thereof based upon the information that you provided to us. Measurement uncertainty is only provided upon request for accredited tests. Statements of conformity are based on simple acceptance criteria without taking measurement uncertainty into account, unless otherwise requested in writing. You have 60 days from date of issuance of this report to notify us of any material error or omission caused by our negligence or if you require measurement uncertainty; provided, however, that such notice shall be in writing and shall specifically address the issue you wish to raise. A failure to raise such issue within the prescribed time shall constitute your unqualified acceptance of the completeness of this report, the tests conducted and the correctness of the report contents.



TABLE OF CONTENTS

RELEASE CONTROL RECORD	4
1 SUMMARY OF TEST RESULTS	5
1.1 MEASUREMENT UNCERTAINTY	6
1.2 TEST SITE AND INSTRUMENTS	7
2 GENERAL INFORMATION	8
2.1 GENERAL DESCRIPTION OF EUT.....	8
2.2 CONFIGURATION OF SYSTEM UNDER TEST	11
2.3 DESCRIPTION OF SUPPORT UNITS	12
2.4 TEST ITEM AND TEST CONFIGURATION	12
2.5 GENERAL DESCRIPTION OF APPLIED STANDARDS	16
3 TEST TYPES AND RESULTS	17
3.1 OUTPUT POWER MEASUREMENT	17
3.1.1 LIMITS OF OUTPUT POWER MEASUREMENT	17
3.1.2 TEST PROCEDURES	17
3.1.3 TEST SETUP.....	18
3.1.4 TEST RESULTS	19
3.2 FREQUENCY STABILITY MEASUREMENT	37
3.2.1 LIMITS OF FREQUENCY STABILITY MEASUREMENT	37
3.2.2 TEST PROCEDURE	37
3.2.3 TEST SETUP	37
3.2.4 TEST RESULTS	38
3.3 OCCUPIED BANDWIDTH MEASUREMENT	62
3.3.1 LIMITS OF OCCUPIED BANDWIDTH MEASUREMENT	62
3.3.2 TEST SETUP.....	62
3.3.3 TEST PROCEDURES	62
3.3.4 TEST RESULTS	63
3.4 BAND EDGE MEASUREMENT.....	64
3.4.1 LIMITS OF BAND EDGE MEASUREMENT	64
3.4.2 TEST SETUP.....	65
3.4.3 TEST PROCEDURES	65
3.4.4 TEST RESULTS	66
3.5 CONDUCTED SPURIOUS EMISSIONS.....	67
3.5.1 LIMITS OF CONDUCTED SPURIOUS EMISSIONS MEASUREMENT	67
3.5.2 TEST PROCEDURE	67
3.5.3 TEST SETUP	67
3.5.4 TEST RESULTS	68
3.6 RADIATED EMISSION MEASUREMENT	69
3.6.1 LIMITS OF RADIATED EMISSION MEASUREMENT	69
3.6.2 TEST PROCEDURES	69
3.6.3 DEVIATION FROM TEST STANDARD	69
3.6.4 TEST SETUP.....	70
3.6.5 TEST RESULTS	72
3.7 PEAK TO AVERAGE RATIO	148
3.7.1 LIMITS OF PEAK TO AVERAGE RATIO MEASUREMENT.....	148
3.7.2 TEST SETUP.....	148
3.7.3 TEST PROCEDURES	148
3.7.4 TEST RESULTS	149



**BUREAU
VERITAS**

Test Report No.: W7L-P22080014RF03

4 INFORMATION ON THE TESTING LABORATORIES	150
5 MODIFICATIONS RECORDERS FOR ENGINEERING CHANGES TO THE EUT BY THE LAB.	151



Test Report No.: W7L-P22080014RF03

RELEASE CONTROL RECORD

ISSUE NO.	REASON FOR CHANGE	DATE ISSUED
W7L-P22080014RF03	Original release	Sep. 26, 2022

1 SUMMARY OF TEST RESULTS

The EUT has been tested according to the following specifications:

APPLIED STANDARD: FCC PART 27 & PART 2		
STANDARD SECTION	TEST TYPE	RESULT
§2.1046	Coducted Output Power	Compliance
§27.50(b)(10) §27.50(c)(10)	Equivalent Radiated Power (Band12) (Band13)	Compliance
§27.50(d)(4) §27.50(h)(2)	Equivalent Isotropically Radiated Power (Band4)	Compliance
§2.1055 §27.54	Frequency Stability	Compliance
§2.1049	Occupied Bandwidth	See Note
§2.1051 §27.53(c)(2)(4) §27.53(g) §27.53(h) §27.53(m)(4)(6)	Band Edge Measurements	See Note
§2.1051 §27.53(c)(2)(4) §27.53(g) §27.53(h) §27.53(m)(4)(6)	Conducted Spurious Emissions	See Note
§2.1053 §27.53(c)(2)(4) §27.53(f) §27.53(g) §27.53(h) §27.53(m)(4)(6)	Radiated Spurious Emissions	Compliance
NA	Peak to average ratio	See Note

NOTE: Refer to Module report R2007A0435-R6, FCC ID: XMR201707BG96.



BUREAU
VERITAS

Test Report No.: W7L-P22080014RF03

1.1 MEASUREMENT UNCERTAINTY

Where relevant, the following measurement uncertainty levels have been estimated for tests performed on the EUT as specified in CISPR 16-4-2:

MEASUREMENT	UNCERTAINTY
Frequency Stability	± 76.97Hz
Radiated emissions (9KHz~30MHz)	±2.68dB
Radiated emissions & Radiated Power (30MHz~1GMHz)	±4.98dB
Radiated emissions & Radiated Power (1GMHz ~6GMHz)	±4.70dB
Radiated emissions (6GMHz ~18GMHz)	±4.60dB
Radiated emissions (18GMHz ~40GMHz)	±4.12dB
Conducted emissions	±4.01dB
Occupied Channel Bandwidth	±43.58KHz
Conducted Output power	±2.06dB
Band Edge Measurements	±4.70dB

This uncertainty represents an expanded uncertainty expressed at approximately the 95% confidence level using a coverage factor of k=2.

1.2 TEST SITE AND INSTRUMENTS

Equipment	Manufacturer	Model No.	Serial No.	Last Cal.	Next Cal.
MXE EMI Receiver	KEYSIGHT	N9038A-544	MY54450026	Feb. 18,22	Feb. 17,23
EXA Signal Analyzer	KEYSIGHT	N9010A-544	MY54510355	May.15,22	May.14,23
Loop Antenna	Schwarzbeck	FMZB 1519B	00173	Sep.05,21	Sep.04,22
Loop Antenna	Schwarzbeck	FMZB 1519B	00173	Sep.04,22	Sep.03,23
Bilog Antenna	ETS-LINDGRE N	3143B	00161965	Mar. 06,22	Mar. 05,23
Horn Antenna	ETS-LINDGRE N	3117	00168692	Mar. 06,22	Mar. 05,23
Horn Antenna (18GHz-40GHz)	N/A	QWH-SL-18-40-K- SG/QMS-00361	15433	Aug. 25, 21	Aug. 24, 22
Horn Antenna (18GHz-40GHz)	N/A	QWH-SL-18-40-K- SG/QMS-00361	15433	Aug. 24, 22	Aug. 23, 23
Radio Communication Analyzer	ANRITSU	MT8820C	6201465426	Feb. 15,22	Feb. 14,23
Signal Pre-Amplifier	EMSI	EMC 9135	980249	May.12,22	May.11,23
Signal Pre-Amplifier	EMSI	EMC 012645B	980257	May.12,22	May.11,23
Signal Pre-Amplifier	EMSI	EMC 184045B	980259	Feb. 21,22	Feb.20,23
3m Semi-anechoic Chamber	ETS-LINDGRE N	9m*6m*6m	Euroshieldpn- CT0001143-121 6	May. 19,20	May. 18,23
Test Software	E3	V 9.160323	N/A	N/A	N/A
Test Software	JS1120	3.1.36	N/A	N/A	N/A
10dB Attenuator	JFW/USA	50HF-010-SMA	1505	May. 07,22	May. 06,23
Power Meter	Anritsu	ML2495A	1506002	Feb. 22,22	Feb. 21,23
Power Sensor	Anritsu	MA2411B	1339352	May. 07,22	May. 06,23
Temperature Chamber	ESPEC	SH-242	93000855	May. 12,22	May. 11,23
MXG Analog Microvave Signal Generator	KEYSIGHT	N5183A	MY50143024	Feb. 18,22	Feb. 17,23
Base station R&S CMW500	Rohde&Schwa rz	CMW500	153085	May.12,22	May.11,23
DC Source	Agilent	U8002A	64827	May. 07,22	May. 06,23

- NOTE:**
1. The calibration interval of the above test instruments is 12 months or 36 months and the calibrations are traceable to CEPREI/CHINA, GRGT/CHINA and NIM/CHINA.
 2. The test was performed in 3m Semi-anechoic Chamber and RF Oven Room.
 3. The horn antenna is used only for the measurement of emission frequency above 1GHz if tested.
 4. The FCC Site Registration No. is 525120; The Designation No. is CN1171.

2 GENERAL INFORMATION

2.1 GENERAL DESCRIPTION OF EUT

PRODUCT	TC-3		
BRAND NAME	FarmHQ		
MODEL NAME	MON404-CODA		
NOMINAL VOLTAGE	30Vdc (DC Source) 3.7Vdc (Li-ion, battery)		
MODULATION TECHNOLOGY	LTE	QPSK, 16QAM	
FREQUENCY RANGE	LTE Band 4 Channel Bandwidth: 1.4MHz	1710.7MHz ~ 1754.3MHz	
	LTE Band 4 Channel Bandwidth: 3MHz	1711.5MHz ~ 1753.5MHz	
	LTE Band 4 Channel Bandwidth: 5MHz	1712.5MHz ~ 1752.5MHz	
	LTE Band 4 Channel Bandwidth: 10MHz	1715MHz ~ 1750MHz	
	LTE Band 4 Channel Bandwidth: 15MHz	1717.5MHz ~ 1747.5 MHz	
	LTE Band 4 Channel Bandwidth: 20MHz	1720MHz ~ 1745MHz	
	LTE Band 12 Channel Bandwidth: 1.4MHz	699.7MHz ~ 715.3MHz	
	LTE Band 12 Channel Bandwidth: 3MHz	700.5MHz ~ 714.5MHz	
	LTE Band 12 Channel Bandwidth: 5MHz	701.5MHz ~ 713.5MHz	
	LTE Band 12 Channel Bandwidth: 10MHz	704MHz ~ 711MHz	
	LTE Band 13 Channel Bandwidth: 5MHz	779.5MHz ~ 784.5MHz	
	LTE Band 13 Channel Bandwidth: 10MHz	782MHz	
	EMISSION DESIGNATOR	LTE Band 4 Channel Bandwidth: 1.4MHz	QPSK: 1M11G7D
			16QAM: 939KW7D
LTE Band 4 Channel Bandwidth: 3MHz		QPSK: 1M15G7D	
		16QAM: 981KW7D	
LTE Band 4 Channel Bandwidth: 5MHz		QPSK: 1M13G7D	
		16QAM: 1M02W7D	
LTE Band 4 Channel Bandwidth: 10MHz		QPSK: 1M18G7D	
		16QAM: 1M07W7D	



**BUREAU
VERITAS**

Test Report No.: W7L-P22080014RF03

EMISSION DESIGNATOR	LTE Band 4 Channel Bandwidth: 15MHz	QPSK: 1M20G7D 16QAM: 1M06W7D
	LTE Band 4 Channel Bandwidth: 20MHz	QPSK: 1M21G7D 16QAM: 1M11W7D
	LTE Band 12 Channel Bandwidth: 1.4MHz	QPSK: 1M11G7D 16QAM: 939KW7D
	LTE Band 12 Channel Bandwidth: 3MHz	QPSK: 1M15G7D 16QAM: 985KW7D
	LTE Band 12 Channel Bandwidth: 5MHz	QPSK: 1M14G7D 16QAM: 976KW7D
	LTE Band 12 Channel Bandwidth: 10MHz	QPSK: 1M21G7D 16QAM: 1M08W7D
	LTE Band 13 Channel Bandwidth: 5MHz	QPSK: 1M15G7D 16QAM: 977KW7D
	LTE Band 13 Channel Bandwidth: 10MHz	QPSK: 1M18G7D 16QAM: 1M03W7D
	MAX. EIRP POWER	LTE Band 4 Channel Bandwidth: 1.4MHz
LTE Band 4 Channel Bandwidth: 3MHz		411.15mW
LTE Band 4 Channel Bandwidth: 5MHz		414.95mW
LTE Band 4 Channel Bandwidth: 10MHz		411.15mW
LTE Band 4 Channel Bandwidth: 15MHz		412.10mW
LTE Band 4 Channel Bandwidth: 20MHz		415.91mW
LTE Band 12 Channel Bandwidth: 1.4MHz		149.62mW
LTE Band 12 Channel Bandwidth: 3MHz		149.97mW
LTE Band 12 Channel Bandwidth: 5MHz		149.97mW
LTE Band 12 Channel Bandwidth: 10MHz		151.36mW
LTE Band 13 Channel Bandwidth: 5MHz		155.60mW
LTE Band 13 Channel Bandwidth: 10MHz		156.68mW



BUREAU
VERITAS

Test Report No.: W7L-P22080014RF03

ANTENNA TYPE	Internal Antenna with 3.47 gain for LTE4 Internal Antenna with 1.7 gain for LTE12 Internal Antenna with 1.7gain for LTE13 Magnet Mount Antenna with 1.26gain for LTE4 Magnet Mount Antenna with -3.26gain for LTE12 Magnet Mount Antenna with -3.26gain for LTE13
HW VERSION	v1.2.0
SW VERSION	v3.3.0
I/O PORTS	Refer to user's manual
CABLE SUPPLIED	N/A
EXTREME TEMPERATURE	-40-85 °C
EXTREME VOLTAGE	Battery 3.6V - 4.2V
	DC 8V – 48 V

NOTE:

1. For a more detailed features description, please refer to the manufacturer's specifications or the user's manual.
2. The EUT incorporates a SISO function. Physically, the EUT provides one completed transmitter and one receiver.

MODULATION MODE	TX FUNCTION
LTE	1TX/1RX

3. For the test results, the EUT had been tested with all conditions. But only the worst case was shown in test report.

List of Accessory:

ACCESSORIES	BRAND	MANUFACTURER	MODEL	SPECIFICATION
Battery		Guang Dong Zhao Neng Technology Co.,Ltd	18650-4P	Capacity : 3.7Vdc, 11800mAh

2.2 CONFIGURATION OF SYSTEM UNDER TEST

FOR RADIATION EMISSION

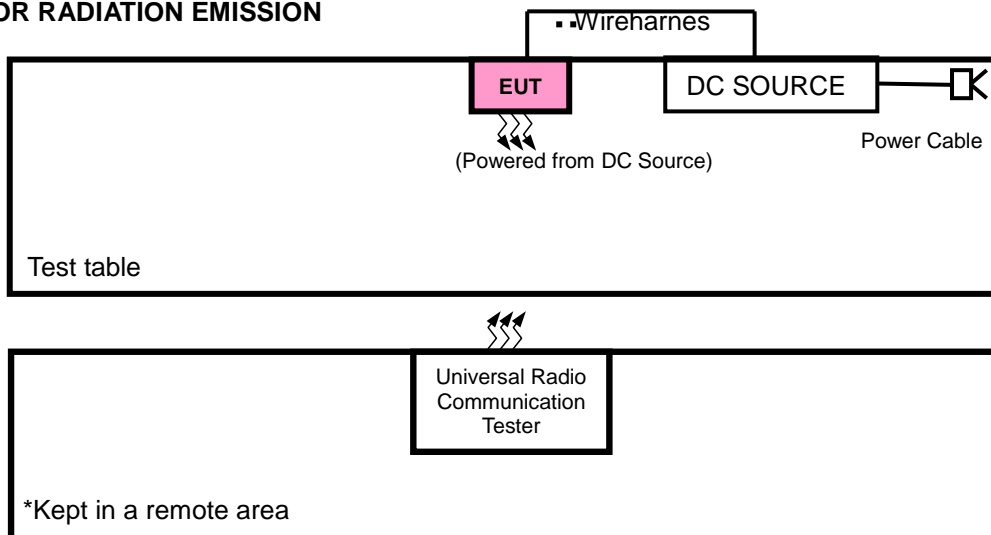

2.3 DESCRIPTION OF SUPPORT UNITS

The EUT has been tested as an independent unit together with other necessary accessories or support units. The following support units or accessories were used to form a representative test configuration during the tests.

NO.	PRODUCT	BRAND	MODEL NO.	SERIAL NO.	FCC ID
1	DC source	Agilent	U8002A	N/A	N/A
2	Power Cable	N/A	N/A	N/A	N/A

NO.	SIGNAL CABLE DESCRIPTION OF THE ABOVE SUPPORT UNITS
1	Wireharness - 4PH

2.4 TEST ITEM AND TEST CONFIGURATION

Pre-Scan has been conducted to determine the worst-case mode from all possible combinations between available modulations, data rates, XYZ axis and antenna ports. The worst case in EIRP and radiated emission was found when positioned on X-plane for LTE. Following channel(s) was (were) selected for the final test as listed below, pre-scan A and B mode, worst case is A mode and only Frequency Stability embody two sets of data, other data embody mode A :

EUT CONFIGURE MODE	DESCRIPTION
A	EUT + DC Source with LTE link
B	EUT + Battery with LTE link

LTE BAND 4

EUT CONFIGURE MODE	TEST ITEM	AVAILABLE CHANNEL	TESTED CHANNEL	CHANNEL BANDWIDTH	MODULATION	MODE
A/B	EIRP	19957 to 20393	19957, 20175, 20393	1.4MHz	QPSK, 16QAM	1 RB / 0 RB Offset
		19965 to 20385	19965, 20175, 20385	3MHz	QPSK, 16QAM	1 RB / 0 RB Offset
		19975 to 20375	19975, 20175, 20375	5MHz	QPSK, 16QAM	1 RB / 0 RB Offset
		20000 to 20350	20000, 20175, 20350	10MHz	QPSK, 16QAM	1 RB / 0 RB Offset
		20025 to 20325	20025, 20175, 20325	15MHz	QPSK, 16QAM	1 RB / 0 RB Offset
		20050 to 20300	20050, 20175, 20300	20MHz	QPSK, 16QAM	1 RB / 0 RB Offset
A/B	FREQUENCY STABILITY	19957 to 20393	19957, 20175, 20393	1.4MHz	QPSK, 16QAM	6 RB / 0 RB Offset
		19965 to 20385	19965, 20175, 20385	3MHz	QPSK, 16QAM	6 RB / 0 RB Offset
		19975 to 20375	19975, 20175, 20375	5MHz	QPSK, 16QAM	6 RB / 0 RB Offset
		20000 to 20350	20000, 20175, 20350	10MHz	QPSK, 16QAM	6 RB / 0 RB Offset
		20025 to 20325	20025, 20175, 20325	15MHz	QPSK, 16QAM	6 RB / 0 RB Offset
		20050 to 20300	20050, 20175, 20300	20MHz	QPSK, 16QAM	6 RB / 0 RB Offset

A/B	RADIATED EMISSION	19957 to 20393	20175	1.4MHz	QPSK	1 RB / 0 RB Offset
		19965 to 20385	20175	3MHz	QPSK	1 RB / 0 RB Offset
		19975 to 20375	20175	5MHz	QPSK	1 RB / 0 RB Offset
		20000 to 20350	20175	10MHz	QPSK	1 RB / 0 RB Offset
		20025 to 20325	20025, 20175, 20325	15MHz	QPSK	1 RB / 0 RB Offset
		20050 to 20300	20050, 20175, 20300	20MHz	QPSK	1 RB / 0 RB Offset

Note: This device was tested under all bandwidths, RB configurations and modulations. The worst case was found in QPSK modulation.

LTE BAND 12 MODE

EUT CONFIGURE MODE	TEST ITEM	AVAILABLE CHANNEL	TESTED CHANNEL	CHANNEL BANDWIDTH	MODULATION	MODE
A/B	ERP	23017 to 23173	23017, 23095 , 23173	1.4MHz	QPSK, 16QAM	1 RB / 0 RB Offset
		23025 to 23165	23025, 23095 ,23165	3MHz	QPSK, 16QAM	1 RB / 0 RB Offset
		23035 to 23155	23035, 23095 ,23155	5MHz	QPSK, 16QAM	1 RB / 0 RB Offset
		23060 to 23130	23060, 23095 ,23130	10MHz	QPSK, 16QAM	1 RB / 0 RB Offset
A/B	FREQUENCY STABILITY	23017 to 23173	23017, 23095 , 23173	1.4MHz	QPSK, 16QAM	6 RB / 0 RB Offset
		23025 to 23165	23025, 23095 ,23165	3MHz	QPSK, 16QAM	6 RB / 0 RB Offset
		23035 to 23155	23035, 23095 ,23155	5MHz	QPSK, 16QAM	6 RB / 0 RB Offset
		23060 to 23130	23060, 23095 ,23130	10MHz	QPSK, 16QAM	6 RB / 0 RB Offset
A/B	RADIATED EMISSION	23017 to 23173	23095	1.4MHz	QPSK	1 RB / 0 RB Offset
		23025 to 23165	23095	3MHz	QPSK	1 RB / 0 RB Offset
		23035 to 23155	23035, 23095 ,23155	5MHz	QPSK	1 RB / 0 RB Offset
		23060 to 23130	23060, 23095 ,23130	10MHz	QPSK	1 RB / 0 RB Offset

Note: This device was tested under all bandwidths, RB configurations and modulations. The worst case was found in QPSK modulation.

LTE BAND 13 MODE

EUT CONFIGURE MODE	TEST ITEM	AVAILABLE CHANNEL	TESTED CHANNEL	CHANNEL BANDWIDTH	MODULATION	MODE
A/B	ERP	23205 to 23255	20025, 20175, 20325	5MHz	QPSK, 16QAM	1 RB / 0 RB Offset
		23230	23230	10MHz	QPSK, 16QAM	1 RB / 0 RB Offset
A/B	FREQUENCY STABILITY	23205 to 23255	20025, 20325	1.4MHz	QPSK	6 RB / 0 RB Offset
		23230	23230	10MHz	QPSK	6 RB / 0 RB Offset
A/B	RADIATED EMISSION	23205 to 23255	20025, 20175, 20325	5MHz	QPSK	1 RB / 0 RB Offset
		23230	23230	10MHz	QPSK	1 RB / 0 RB Offset

Note: This device was tested under all bandwidths, RB configurations and modulations. The worst case was found in QPSK modulation.



Test Report No.: W7L-P22080014RF03

TEST CONDITION:

TEST ITEM	ENVIRONMENTAL CONDITIONS	INPUT POWER	TESTED BY
ERP	23deg. C, 70%RH	DC 30V By DC Source	Jace Hu
FREQUENCY STABILITY	23deg. C, 70%RH	DC 3.7V By Battery DC 30V By DC Source	James Fu
RADIATED EMISSION	23deg. C, 70%RH	DC 30V By DC Source	Jace Hu



Test Report No.: W7L-P22080014RF03

2.5 GENERAL DESCRIPTION OF APPLIED STANDARDS

The EUT is a RF product. According to the specifications of the manufacturer, it must comply with the requirements of the following standards:

FCC 47 CFR Part 2

FCC 47 CFR Part 27

KDB 971168 D01 Power Meas License Digital Systems v03r01

ANSI/TIA/EIA-603-D

ANSI/TIA/EIA-603-E

ANSI C63.26-2015

NOTE: All test items have been performed and recorded as per the above standards.

3 TEST TYPES AND RESULTS

3.1 OUTPUT POWER MEASUREMENT

3.1.1 LIMITS OF OUTPUT POWER MEASUREMENT

The radiated peak output power shall be according to the specific rule Part 27.50(h)(2) that “User stations are limited to 2 watts” and 27.50(i) specific that “Peak transmit power must be measure over any interval of continuous transmission using instrumentation calibration in terms of rms-equivalent voltage.”

Fixed, mobile, and portable (hand-held) stations operating in the 1710-1755 MHz band and mobile and portable stations operating in the 1695-1710 MHz and 1755-1780 MHz bands are limited to 1 watt EIRP

According to the specific rule Part 27.50(b)(10) and 27.50(c)(10) Fixed, mobile, and Portable stations (hand-held devices) transmitting in the 698-746 MHz, 746-757 MHz, 776-788 MHz, and 805-806 MHz bands are limited to 3 watts ERP.

3.1.2 TEST PROCEDURES

EIRP MEASUREMENT:

Per KDB 971168 D01 Power Meas License Digital Systems v03r01 or subclause 5.2.5.5 of ANSI C63.26-2015, the relevant equation for determining the ERP or EIRP from the conducted RF output power measured using the guidance provided above is:

$$\text{ERP or EIRP} = P_{\text{Meas}} + G_{\text{T}} - L_{\text{C}}$$

Where:

ERP or EIRP = effective radiated power or equivalent isotropically radiated power, respectively

(expressed in the same units as P_{Meas} , typically dBW or dBm);

P_{Meas} = measured transmitter output power or PSD, in dBm or dBW;

G_{T} = gain of the transmitting antenna, in dBd (ERP) or dBi (EIRP);

L_{C} = signal attenuation in the connecting cable between the transmitter and antenna, in dB.

CONDUCTED POWER MEASUREMENT:

- a. The EUT was set up for the maximum power with LTE link data modulation and link up with simulator.
- b. Set the EUT to transmit under low, middle and high channel and record the power level shown on simulator.



Test Report No.: W7L-P22080014RF03

3.1.3 TEST SETUP

CONDUCTED POWER MEASUREMENT:

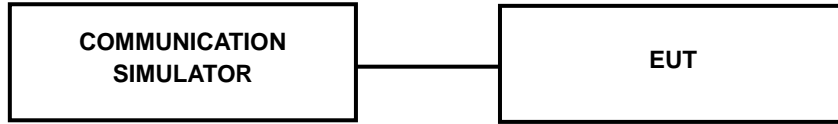

For the actual test configuration, please refer to the attached file (Test Setup Photo).

3.1.4 TEST RESULTS

NOTE: Pre-scan battery supply and DC SOURCE, Worse case is DC SOURCE

AVERAGE CONDUCTED OUTPUT POWER (dBm)

LTE Band 4

Band/BW	Modulation	RB Size	RB Offset	Low CH 19957	Mid CH 20175	High CH 20393
				Frequency 1710.7 MHz	Frequency 1732.5 MHz	Frequency 1754.3 MHz
4/ 1.4	QPSK	1	0	22.56	22.55	22.70
		1	5	22.52	22.53	22.64
		3	0	22.46	22.49	22.58
		3	3	22.52	22.49	22.62
		6	0	22.48	22.48	22.57
	16QAM	1	0	22.50	22.50	22.65
		1	5	22.42	22.43	22.58
		3	0	22.38	22.45	22.55
		3	3	22.52	22.50	22.61
		6	0	22.44	22.54	22.60

Band/BW	Modulation	RB Size	RB Offset	Low CH 19965	Mid CH 20175	High CH 20385
				Frequency 1711.5 MHz	Frequency 1732.5 MHz	Frequency 1753.5 MHz
4/ 3	QPSK	1	0	22.51	22.54	22.67
		1	5	22.48	22.54	22.64
		3	0	22.43	22.46	22.58
		3	3	22.49	22.56	22.66
		6	0	22.44	22.49	22.55
	16QAM	1	0	22.53	22.49	22.69
		1	5	22.36	22.47	22.55
		3	0	22.40	22.38	22.58
		3	3	22.55	22.53	22.54
		6	0	22.45	22.48	22.59

Band/BW	Modulation	RB Size	RB Offset	Low CH 19975	Mid CH 20175	High CH 20375
				Frequency 1712.5 MHz	Frequency 1732.5 MHz	Frequency 1752.5 MHz
4/ 5	QPSK	1	0	22.52	22.53	22.71
		1	5	22.51	22.54	22.61
		3	0	22.41	22.49	22.61
		3	3	22.50	22.52	22.66
		6	0	22.41	22.52	22.54
	16QAM	1	0	22.53	22.49	22.68
		1	5	22.36	22.45	22.52
		3	0	22.40	22.39	22.55
		3	3	22.49	22.50	22.60
		6	0	22.42	22.54	22.59

Band/BW	Modulation	RB Size	RB Offset	Low CH 20000	Mid CH 20175	High CH 20350
				Frequency 1715 MHz	Frequency 1732.5 MHz	Frequency 1750 MHz
4/ 10	QPSK	1	0	22.49	22.57	22.67
		1	5	22.52	22.53	22.64
		3	0	22.46	22.49	22.58
		3	3	22.50	22.49	22.62
		6	0	22.46	22.48	22.57
	16QAM	1	0	22.53	22.50	22.65
		1	5	22.38	22.43	22.58
		3	0	22.44	22.38	22.59
		3	3	22.48	22.51	22.57
		6	0	22.47	22.50	22.63

Band/BW	Modulation	RB Size	RB Offset	Low CH 20025	Mid CH 20175	High CH 20325
				Frequency 1717.5 MHz	Frequency 1732.5 MHz	Frequency 1747.5 MHz
4/ 15	QPSK	1	0	22.53	22.58	22.66
		1	5	22.53	22.58	22.62
		3	0	22.39	22.44	22.64
		3	3	22.56	22.53	22.65
		6	0	22.46	22.53	22.53
	16QAM	1	0	22.51	22.52	22.68
		1	5	22.38	22.49	22.57
		3	0	22.43	22.40	22.58
		3	3	22.55	22.50	22.54
		6	0	22.44	22.53	22.61

Band/BW	Modulation	RB Size	RB Offset	Low CH 20050	Mid CH 20175	High CH 20300
				Frequency 1720 MHz	Frequency 1732.5 MHz	Frequency 1745 MHz
4/ 20	QPSK	1	0	22.57	22.61	22.72
		1	5	22.55	22.59	22.66
		3	0	22.47	22.51	22.66
		3	3	22.57	22.57	22.68
		6	0	22.49	22.54	22.59
	16QAM	1	0	22.55	22.57	22.70
		1	5	22.44	22.51	22.60
		3	0	22.46	22.46	22.60
		3	3	22.56	22.55	22.62
		6	0	22.50	22.56	22.65

LTE Band 12

Band/BW	Modulation	RB Size	RB Offset	Low CH 23017	Mid CH 23095	High CH 23173
				Frequency 699.7 MHz	Frequency 707.5 MHz	Frequency 715.3 MHz
12/ 1.4	QPSK	1	0	21.97	21.99	22.20
		1	5	22.00	21.91	22.18
		3	0	22.00	22.06	22.13
		3	3	21.93	21.89	22.12
		6	0	21.98	21.97	22.15
	16QAM	1	0	21.96	21.96	22.18
		1	5	21.88	21.88	22.08
		3	0	21.87	21.98	22.07
		3	3	21.93	21.94	22.18
		6	0	21.85	21.88	22.04

Band/BW	Modulation	RB Size	RB Offset	Low CH 23025	Mid CH 23095	High CH 23165
				Frequency 700.5 MHz	Frequency 707.5 MHz	Frequency 714.5 MHz
12/ 3	QPSK	1	0	21.99	22.01	22.19
		1	5	21.96	21.92	22.18
		3	0	21.93	22.06	22.15
		3	3	21.90	21.96	22.16
		6	0	21.95	21.98	22.09
	16QAM	1	0	21.93	22.02	22.21
		1	5	21.85	21.91	22.06
		3	0	21.92	21.93	22.10
		3	3	21.95	21.92	22.14
		6	0	21.85	21.82	22.07

Band/BW	Modulation	RB Size	RB Offset	Low CH 23035	Mid CH 23095	High CH 23155
				Frequency 701.5 MHz	Frequency 707.5 MHz	Frequency 713.5 MHz
12/ 5	QPSK	1	0	22.00	21.96	22.20
		1	5	22.01	21.89	22.18
		3	0	21.93	22.07	22.16
		3	3	21.94	21.92	22.17
		6	0	21.93	22.01	22.12
	16QAM	1	0	21.94	21.98	22.21
		1	5	21.82	21.94	22.05
		3	0	21.89	21.97	22.06
		3	3	21.90	21.94	22.17
		6	0	21.85	21.83	22.04

Band/BW	Modulation	RB Size	RB Offset	Low CH 23060	Mid CH 23095	High CH 23130
				Frequency 704 MHz	Frequency 707.5 MHz	Frequency 711 MHz
12/ 10	QPSK	1	0	22.05	22.03	22.25
		1	5	22.03	21.97	22.20
		3	0	22.01	22.08	22.21
		3	3	21.98	21.97	22.18
		6	0	21.99	22.03	22.17
	16QAM	1	0	22.01	22.03	22.23
		1	5	21.90	21.96	22.10
		3	0	21.95	21.99	22.12
		3	3	21.97	21.99	22.19
		6	0	21.91	21.90	22.09



**BUREAU
VERITAS**

Test Report No.: W7L-P22080014RF03

LTE Band 13

Band/BW	Modulation	RB Size	RB Offset	Low CH 23205	Mid CH 23230	High CH 23255
				Frequency 779.5 MHz	Frequency 782.0 MHz	Frequency 784.5 MHz
13/ 5	QPSK	1	0	22.32	22.36	22.35
		1	5	22.36	22.30	22.37
		3	0	22.27	22.22	22.24
		3	3	22.26	22.24	22.30
		6	0	22.36	22.35	22.29
	16QAM	1	0	22.21	22.20	22.22
		1	5	22.19	22.16	22.20
		3	0	22.28	22.22	22.29
		3	3	22.28	22.32	22.31
		6	0	22.28	22.22	22.29

Band/BW	Modulation	RB Size	RB Offset	/	Mid CH 23230	/
				/	Frequency 782.0 MHz	/
13/ 10	QPSK	1	0	/	22.40	/
		1	5	/	22.38	/
		3	0	/	22.29	/
		3	3	/	22.32	/
		6	0	/	22.37	/
	16QAM	1	0	/	22.28	/
		1	5	/	22.22	/
		3	0	/	22.30	/
		3	3	/	22.36	/
		6	0	/	22.30	/



**BUREAU
VERITAS**

Test Report No.: W7L-P22080014RF03

EIRP

Internal Antenna:

LTE BAND 4

CHANNEL BANDWIDTH: 1.4MHz QPSK

Channel	Frequency (MHz)	Conducted Power (dBm)	G _T -L _c (dB)	EIRP (dBm)	EIRP (mW)	Limit (W)
19957	1710.7	22.56	3.47	26.03	400.87	1
20175	1732.5	22.55	3.47	26.02	399.94	1
20393	1754.3	22.7	3.47	26.17	414.00	1

CHANNEL BANDWIDTH: 1.4MHz 16QAM

Channel	Frequency (MHz)	Conducted Power (dBm)	G _T -L _c (dB)	EIRP (dBm)	EIRP (mW)	Limit (W)
19957	1710.7	22.52	3.47	25.99	397.19	1
20175	1732.5	22.54	3.47	26.01	399.02	1
20393	1754.3	22.65	3.47	26.12	409.26	1

CHANNEL BANDWIDTH: 3MHz QPSK

Channel	Frequency (MHz)	Conducted Power (dBm)	G _T -L _c (dB)	EIRP (dBm)	EIRP (mW)	Limit (W)
19965	1711.5	22.51	3.47	25.98	396.28	1
20175	1732.5	22.56	3.47	26.03	400.87	1
20385	1753.5	22.67	3.47	26.14	411.15	1

CHANNEL BANDWIDTH: 3MHz 16QAM

Channel	Frequency (MHz)	Conducted Power (dBm)	G _T -L _c (dB)	EIRP (dBm)	EIRP (mW)	Limit (W)
19965	1711.5	22.55	3.47	26.02	399.94	1
20175	1732.5	22.53	3.47	26	398.11	1
20385	1753.5	22.54	3.47	26.01	399.02	1

CHANNEL BANDWIDTH: 5MHz QPSK

Channel	Frequency (MHz)	Conducted Power (dBm)	G _T -L _c (dB)	EIRP (dBm)	EIRP (mW)	Limit (W)
19975	1712.5	22.52	3.47	25.99	397.19	1
20175	1732.5	22.54	3.47	26.01	399.02	1
20375	1752.5	22.71	3.47	26.18	414.95	1

CHANNEL BANDWIDTH: 5MHz 16QAM

Channel	Frequency (MHz)	Conducted Power (dBm)	G _T -L _c (dB)	EIRP (dBm)	EIRP (mW)	Limit (W)
19975	1712.5	22.53	3.47	26	398.11	1
20175	1732.5	22.54	3.47	26.01	399.02	1
20375	1752.5	22.68	3.47	26.15	412.1	1

CHANNEL BANDWIDTH: 10MHz QPSK

Channel	Frequency (MHz)	Conducted Power (dBm)	G _T -L _c (dB)	EIRP (dBm)	EIRP (mW)	Limit (W)
20000	1715	22.52	3.47	25.99	397.19	1
20175	1732.5	22.57	3.47	26.04	401.79	1
20350	1750	22.67	3.47	26.14	411.15	1

CHANNEL BANDWIDTH: 10MHz 16QAM

Channel	Frequency (MHz)	Conducted Power (dBm)	G _T -L _c (dB)	EIRP (dBm)	EIRP (mW)	Limit (W)
20000	1715	22.53	3.47	26	398.11	1
20175	1732.5	22.51	3.47	25.98	396.28	1
20350	1750	22.65	3.47	26.12	409.26	1

CHANNEL BANDWIDTH: 15MHz QPSK

Channel	Frequency (MHz)	Conducted Power (dBm)	G _T -L _c (dB)	EIRP (dBm)	EIRP (mW)	Limit (W)
20025	1717.5	22.56	3.47	26.03	400.87	1
20175	1732.5	22.58	3.47	26.05	402.72	1
20325	1747.5	22.66	3.47	26.13	410.20	1

CHANNEL BANDWIDTH: 15MHz 16QAM

Channel	Frequency (MHz)	Conducted Power (dBm)	G _T -L _c (dB)	EIRP (dBm)	EIRP (mW)	Limit (W)
20025	1717.5	22.55	3.47	26.02	399.94	1
20175	1732.5	22.53	3.47	26	398.11	1
20325	1747.5	22.68	3.47	26.15	412.10	1

CHANNEL BANDWIDTH: 20MHz QPSK

Channel	Frequency (MHz)	Conducted Power (dBm)	G _T -L _c (dB)	EIRP (dBm)	EIRP (mW)	Limit (W)
20050	1720	22.57	3.47	26.04	401.79	1
20175	1732.5	22.61	3.47	26.08	405.51	1
20300	1745	22.72	3.47	26.19	415.91	1

CHANNEL BANDWIDTH: 20MHz 16QAM

Channel	Frequency (MHz)	Conducted Power (dBm)	G _T -L _c (dB)	EIRP (dBm)	EIRP (mW)	Limit (W)
20050	1720	22.56	3.47	26.03	400.87	1
20175	1732.5	22.57	3.47	26.04	401.79	1
20300	1745	22.7	3.47	26.17	414	1

LTE BAND 12

CHANNEL BANDWIDTH: 1.4MHz QPSK

Channel	Frequency (MHz)	Conducted Power (dBm)	G _T -L _c (dB)	ERP (dBm)	ERP (mW)	Limit (W)
23017	699.7	22	1.7	21.55	142.89	3
23095	707.5	22.06	1.7	21.61	144.88	3
23173	715.3	22.2	1.7	21.75	149.62	3

CHANNEL BANDWIDTH: 1.4MHz 16QAM

Channel	Frequency (MHz)	Conducted Power (dBm)	G _T -L _c (dB)	ERP (dBm)	ERP (mW)	Limit (W)
23017	699.7	21.96	1.7	21.51	141.58	3
23095	707.5	21.98	1.7	21.53	142.23	3
23173	715.3	22.18	1.7	21.73	148.94	3

CHANNEL BANDWIDTH: 3MHz QPSK

Channel	Frequency (MHz)	Conducted Power (dBm)	G _T -L _c (dB)	ERP (dBm)	ERP (mW)	Limit (W)
23025	700.5	21.99	1.7	21.54	142.56	3
23095	707.5	22.06	1.7	21.61	144.88	3
23165	714.5	22.19	1.7	21.74	149.28	3

CHANNEL BANDWIDTH: 3MHz 16QAM

Channel	Frequency (MHz)	Conducted Power (dBm)	G _T -L _c (dB)	ERP (dBm)	ERP (mW)	Limit (W)
23025	700.5	21.95	1.7	21.5	141.25	3
23095	707.5	22.02	1.7	21.57	143.55	3
23165	714.5	22.21	1.7	21.76	149.97	3

CHANNEL BANDWIDTH: 5MHz QPSK

Channel	Frequency (MHz)	Conducted Power (dBm)	G _T -L _c (dB)	ERP (dBm)	ERP (mW)	Limit (W)
23035	701.5	22.01	1.7	21.56	143.22	3
23095	707.5	22.07	1.7	21.62	145.21	3
23155	713.5	22.2	1.7	21.75	149.62	3

CHANNEL BANDWIDTH: 5MHz 16QAM

Channel	Frequency (MHz)	Conducted Power (dBm)	G _T -L _c (dB)	ERP (dBm)	ERP (mW)	Limit (W)
23035	701.5	21.94	1.7	21.49	140.93	3
23095	707.5	21.98	1.7	21.53	142.23	3
23155	713.5	22.21	1.7	21.76	149.97	3

CHANNEL BANDWIDTH: 10MHz QPSK

Channel	Frequency (MHz)	Conducted Power (dBm)	G _T -L _c (dB)	ERP (dBm)	ERP (mW)	Limit (W)
23060	704	22.05	1.7	21.6	144.54	3
23095	707.5	22.08	1.7	21.63	145.55	3
23130	711	22.25	1.7	21.8	151.36	3

CHANNEL BANDWIDTH: 10MHz 16QAM

Channel	Frequency (MHz)	Conducted Power (dBm)	G _T -L _c (dB)	ERP (dBm)	ERP (mW)	Limit (W)
23060	704	22.01	1.7	21.56	143.22	3
23095	707.5	22.03	1.7	21.58	143.88	3
23130	711	22.23	1.7	21.78	150.66	3

REMARKS: ERP Output Power (dBm) = EIRP (dBm) -2.15(dB).



LTE BAND 13

CHANNEL BANDWIDTH: 5MHz QPSK

Channel	Frequency (MHz)	Conducted Power (dBm)	G _T -L _C (dB)	ERP (dBm)	ERP (mW)	Limit (W)
23205	779.5	22.36	1.7	21.91	155.24	3
23230	782	22.36	1.7	21.91	155.24	3
23255	784.5	22.37	1.7	21.92	155.60	3

CHANNEL BANDWIDTH: 5MHz 16QAM

Channel	Frequency (MHz)	Conducted Power (dBm)	G _T -L _C (dB)	ERP (dBm)	ERP (mW)	Limit (W)
23205	779.5	22.28	1.7	21.83	152.41	3
23230	782	22.32	1.7	21.87	153.82	3
23255	784.5	22.31	1.7	21.86	153.46	3

CHANNEL BANDWIDTH: 10MHz QPSK

Channel	Frequency (MHz)	Conducted Power (dBm)	G _T -L _C (dB)	ERP (dBm)	ERP (mW)	Limit (W)
-	-	-	-	-	-	-
23230	782	22.4	1.7	21.95	156.68	3
-	-	-	-	-	-	-

CHANNEL BANDWIDTH: 10MHz 16QAM

Channel	Frequency (MHz)	Conducted Power (dBm)	G _T -L _C (dB)	ERP (dBm)	ERP (mW)	Limit (W)
-	-	-	-	-	-	-
23230	782	22.36	1.7	21.91	155.24	3
-	-	-	-	-	-	-

REMARKS: ERP Output Power (dBm) = EIRP (dBm) -2.15(dB).



**BUREAU
VERITAS**

Test Report No.: W7L-P22080014RF03

Magnet mount Antenna:

LTE BAND 4

CHANNEL BANDWIDTH: 1.4MHz QPSK

Channel	Frequency (MHz)	Conducted Power (dBm)	G _T -L _c (dB)	EIRP (dBm)	EIRP (mW)	Limit (W)
19957	1710.7	22.56	1.26	23.82	240.99	1
20175	1732.5	22.55	1.26	23.81	240.44	1
20393	1754.3	22.7	1.26	23.96	248.89	1

CHANNEL BANDWIDTH: 1.4MHz 16QAM

Channel	Frequency (MHz)	Conducted Power (dBm)	G _T -L _c (dB)	EIRP (dBm)	EIRP (mW)	Limit (W)
19957	1710.7	22.52	1.26	23.78	238.78	1
20175	1732.5	22.54	1.26	23.8	239.88	1
20393	1754.3	22.65	1.26	23.91	246.04	1

CHANNEL BANDWIDTH: 3MHz QPSK

Channel	Frequency (MHz)	Conducted Power (dBm)	G _T -L _c (dB)	EIRP (dBm)	EIRP (mW)	Limit (W)
19965	1711.5	22.51	1.26	23.77	238.23	1
20175	1732.5	22.56	1.26	23.82	240.99	1
20385	1753.5	22.67	1.26	23.93	247.17	1

CHANNEL BANDWIDTH: 3MHz 16QAM

Channel	Frequency (MHz)	Conducted Power (dBm)	G _T -L _c (dB)	EIRP (dBm)	EIRP (mW)	Limit (W)
19965	1711.5	22.55	1.26	23.81	240.44	1
20175	1732.5	22.53	1.26	23.79	239.33	1
20385	1753.5	22.54	1.26	23.8	239.88	1

CHANNEL BANDWIDTH: 5MHz QPSK

Channel	Frequency (MHz)	Conducted Power (dBm)	G _T -L _c (dB)	EIRP (dBm)	EIRP (mW)	Limit (W)
19975	1712.5	22.52	1.26	23.78	238.78	1
20175	1732.5	22.54	1.26	23.8	239.88	1
20375	1752.5	22.71	1.26	23.97	249.46	1

CHANNEL BANDWIDTH: 5MHz 16QAM

Channel	Frequency (MHz)	Conducted Power (dBm)	G _T -L _c (dB)	EIRP (dBm)	EIRP (mW)	Limit (W)
19975	1712.5	22.53	1.26	23.79	239.33	1
20175	1732.5	22.54	1.26	23.8	239.88	1
20375	1752.5	22.68	1.26	23.94	247.74	1

CHANNEL BANDWIDTH: 10MHz QPSK

Channel	Frequency (MHz)	Conducted Power (dBm)	G _T -L _c (dB)	EIRP (dBm)	EIRP (mW)	Limit (W)
20000	1715	22.52	1.26	23.78	238.78	1
20175	1732.5	22.57	1.26	23.83	241.55	1
20350	1750	22.67	1.26	23.93	247.17	1

CHANNEL BANDWIDTH: 10MHz 16QAM

Channel	Frequency (MHz)	Conducted Power (dBm)	G _T -L _c (dB)	EIRP (dBm)	EIRP (mW)	Limit (W)
20000	1715	22.53	1.26	23.79	239.33	1
20175	1732.5	22.51	1.26	23.77	238.23	1
20350	1750	22.65	1.26	23.91	246.04	1

CHANNEL BANDWIDTH: 15MHz QPSK

Channel	Frequency (MHz)	Conducted Power (dBm)	G _T -L _c (dB)	EIRP (dBm)	EIRP (mW)	Limit (W)
20025	1717.5	22.56	1.26	23.82	240.99	1
20175	1732.5	22.58	1.26	23.84	242.1	1
20325	1747.5	22.66	1.26	23.92	246.6	1

CHANNEL BANDWIDTH: 15MHz 16QAM

Channel	Frequency (MHz)	Conducted Power (dBm)	G _T -L _c (dB)	EIRP (dBm)	EIRP (mW)	Limit (W)
20025	1717.5	22.55	1.26	23.81	240.44	1
20175	1732.5	22.53	1.26	23.79	239.33	1
20325	1747.5	22.68	1.26	23.94	247.74	1

CHANNEL BANDWIDTH: 20MHz QPSK

Channel	Frequency (MHz)	Conducted Power (dBm)	G _T -L _c (dB)	EIRP (dBm)	EIRP (mW)	Limit (W)
20050	1720	22.57	1.26	23.83	241.55	1
20175	1732.5	22.61	1.26	23.87	243.78	1
20300	1745	22.72	1.26	23.98	250.03	1

CHANNEL BANDWIDTH: 20MHz 16QAM

Channel	Frequency (MHz)	Conducted Power (dBm)	G _T -L _c (dB)	EIRP (dBm)	EIRP (mW)	Limit (W)
20050	1720	22.56	1.26	23.82	240.99	1
20175	1732.5	22.57	1.26	23.83	241.55	1
20300	1745	22.7	1.26	23.96	248.89	1

LTE BAND 12

CHANNEL BANDWIDTH: 1.4MHz QPSK

Channel	Frequency (MHz)	Conducted Power (dBm)	G _T -L _c (dB)	ERP (dBm)	ERP (mW)	Limit (W)
23017	699.7	22	-3.26	16.59	45.6	3
23095	707.5	22.06	-3.26	16.65	46.24	3
23173	715.3	22.2	-3.26	16.79	47.75	3

CHANNEL BANDWIDTH: 1.4MHz 16QAM

Channel	Frequency (MHz)	Conducted Power (dBm)	G _T -L _c (dB)	ERP (dBm)	ERP (mW)	Limit (W)
23017	699.7	21.96	-3.26	16.55	45.19	3
23095	707.5	21.98	-3.26	16.57	45.39	3
23173	715.3	22.18	-3.26	16.77	47.53	3

CHANNEL BANDWIDTH: 3MHz QPSK

Channel	Frequency (MHz)	Conducted Power (dBm)	G _T -L _c (dB)	ERP (dBm)	ERP (mW)	Limit (W)
23025	700.5	21.99	-3.26	16.58	45.5	3
23095	707.5	22.06	-3.26	16.65	46.24	3
23165	714.5	22.19	-3.26	16.78	47.64	3

CHANNEL BANDWIDTH: 3MHz 16QAM

Channel	Frequency (MHz)	Conducted Power (dBm)	G _T -L _c (dB)	ERP (dBm)	ERP (mW)	Limit (W)
23025	700.5	21.95	-3.26	16.54	45.08	3
23095	707.5	22.02	-3.26	16.61	45.81	3
23165	714.5	22.21	-3.26	16.8	47.86	3

CHANNEL BANDWIDTH: 5MHz QPSK

Channel	Frequency (MHz)	Conducted Power (dBm)	G _T -L _c (dB)	ERP (dBm)	ERP (mW)	Limit (W)
23035	701.5	22.01	-3.26	16.6	45.71	3
23095	707.5	22.07	-3.26	16.66	46.34	3
23155	713.5	22.2	-3.26	16.79	47.75	3

CHANNEL BANDWIDTH: 5MHz 16QAM

Channel	Frequency (MHz)	Conducted Power (dBm)	G _T -L _c (dB)	ERP (dBm)	ERP (mW)	Limit (W)
23035	701.5	21.94	-3.26	16.53	44.98	3
23095	707.5	21.98	-3.26	16.57	45.39	3
23155	713.5	22.21	-3.26	16.8	47.86	3

CHANNEL BANDWIDTH: 10MHz QPSK

Channel	Frequency (MHz)	Conducted Power (dBm)	G _T -L _c (dB)	ERP (dBm)	ERP (mW)	Limit (W)
23060	704	22.05	-3.26	16.64	46.13	3
23095	707.5	22.08	-3.26	16.67	46.45	3
23130	711	22.25	-3.26	16.84	48.31	3

CHANNEL BANDWIDTH: 10MHz 16QAM

Channel	Frequency (MHz)	Conducted Power (dBm)	G _T -L _c (dB)	ERP (dBm)	ERP (mW)	Limit (W)
23060	704	22.01	-3.26	16.6	45.71	3
23095	707.5	22.03	-3.26	16.62	45.92	3
23130	711	22.23	-3.26	16.82	48.08	3

REMARKS: ERP Output Power (dBm) = EIRP (dBm) -2.15(dB).



BUREAU
VERITAS

Test Report No.: W7L-P22080014RF03

LTE BAND 13

CHANNEL BANDWIDTH: 5MHz QPSK

Channel	Frequency (MHz)	Conducted Power (dBm)	G _T -L _c (dB)	ERP (dBm)	ERP (mW)	Limit (W)
23205	779.5	22.36	-3.26	16.95	49.55	3
23230	782	22.36	-3.26	16.95	49.55	3
23255	784.5	22.37	-3.26	16.96	49.66	3

CHANNEL BANDWIDTH: 5MHz 16QAM

Channel	Frequency (MHz)	Conducted Power (dBm)	G _T -L _c (dB)	ERP (dBm)	ERP (mW)	Limit (W)
23205	779.5	22.28	-3.26	16.87	48.64	3
23230	782	22.32	-3.26	16.91	49.09	3
23255	784.5	22.31	-3.26	16.9	48.98	3

CHANNEL BANDWIDTH: 10MHz QPSK

Channel	Frequency (MHz)	Conducted Power (dBm)	G _T -L _c (dB)	ERP (dBm)	ERP (mW)	Limit (W)
-	-	-	-	-	-	-
23230	782	22.4	-3.26	16.99	50	3
-	-	-	-	-	-	-

CHANNEL BANDWIDTH: 10MHz 16QAM

Channel	Frequency (MHz)	Conducted Power (dBm)	G _T -L _c (dB)	ERP (dBm)	ERP (mW)	Limit (W)
-	-	-	-	-	-	-
23230	782	22.36	-3.26	16.95	49.55	3
-	-	-	-	-	-	-

REMARKS: ERP Output Power (dBm) = EIRP (dBm) -2.15(dB).

3.2 FREQUENCY STABILITY MEASUREMENT

3.2.1 LIMITS OF FREQUENCY STABILITY MEASUREMENT

The frequency stability shall be sufficient to ensure that the fundamental emissions stay within the authorized bands of operation.

3.2.2 TEST PROCEDURE

- a. Device is placed at the oven room. The oven room could control the temperatures and humidity. Power warm up is at least 15 min and power applied should perform before recording frequency error.
- b. Connect the external power supply to the DC input power supply or battery power supply. The test voltage range is from minimum to maximum working voltage. Each step shall be record the frequency error rate.
- c. The temperature range step is 10 degrees in this test items. All temperature levels shall be hold the $\pm 0.5^{\circ}\text{C}$ during the measurement testing. The each temperature step shall be at least 0.5 hours, consider the EUT could be test under the stability condition.

NOTE: The frequency error was recorded frequency error from the communication simulator.

3.2.3 TEST SETUP

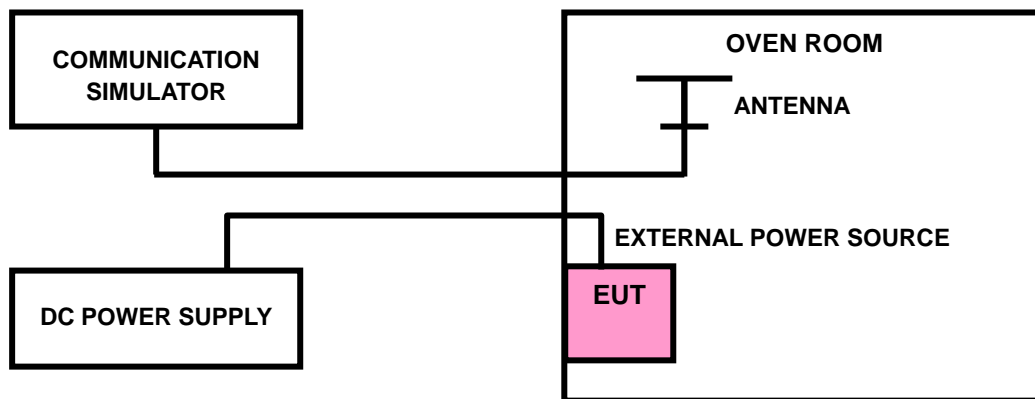



3.2.4 TEST RESULTS

Test EUT Configure mode A (battery) and EUT Configure mode B (DC SOURCE), Details as below:

LTE BAND 4 (BATTERY)

FREQUENCY ERROR VS. VOLTAGE

VOLTAGE (Volts)	1.4MHz		LIMIT (ppm)
	FREQUENCY ERROR (ppm)		
	Low Channel	High Channel	
V _{nor} (3.7V)	0.0021	0.0023	2.5
V _{min} (3.6V)	-0.0031	-0.0030	2.5
V _{max} (4.2V)	0.0021	0.0021	2.5

NOTE: The applicant defined the normal working voltage of the EUT is from V_{min} Vdc to V_{max} Vdc.

FREQUENCY ERROR vs. TEMPERATURE.

TEMP. (°C)	1.4MHz		LIMIT (ppm)
	FREQUENCY ERROR (ppm)		
	Low Channel	High Channel	
-40	-0.0060	-0.0086	2.5
-30	-0.0058	-0.0056	2.5
-20	-0.0054	-0.0056	2.5
-10	-0.0042	-0.0042	2.5
0	-0.0038	-0.0035	2.5
10	-0.0024	-0.0025	2.5
20	-0.0019	-0.0019	2.5
30	-0.0019	-0.0010	2.5
40	-0.0007	-0.0008	2.5
50	-0.0002	-0.0001	2.5
85	-0.0020	-0.0077	2.5

FREQUENCY ERROR VS. VOLTAGE

VOLTAGE (Volts)	3MHz		LIMIT (ppm)
	FREQUENCY ERROR (ppm)		
	Low Channel	High Channel	
$V_{nor(3.7V)}$	0.0021	0.0021	2.5
$V_{min(3.6V)}$	-0.0021	-0.0025	2.5
$V_{max(4.2V)}$	0.0018	0.0018	2.5

NOTE: The applicant defined the normal working voltage of the EUT is from V_{min} Vdc to V_{max} Vdc.

FREQUENCY ERROR vs. TEMPERATURE.

TEMP. (°C)	3MHz		LIMIT (ppm)
	FREQUENCY ERROR (ppm)		
	Low Channel	High Channel	
-40	-0.0041	-0.0066	2.5
-30	-0.0059	-0.0059	2.5
-20	-0.0099	-0.0101	2.5
-10	-0.0083	-0.0083	2.5
0	-0.0075	-0.0072	2.5
10	-0.0055	-0.0050	2.5
20	-0.0039	-0.0040	2.5
30	-0.0027	-0.0036	2.5
40	-0.0022	-0.0019	2.5
50	-0.0004	-0.0005	2.5
85	-0.0006	-0.0015	2.5

FREQUENCY ERROR VS. VOLTAGE

VOLTAGE (Volts)	5MHz		LIMIT (ppm)
	FREQUENCY ERROR (ppm)		
	Low Channel	High Channel	
$V_{nor}(3.7V)$	0.0021	0.0024	2.5
$V_{min}(3.6V)$	-0.0023	-0.0030	2.5
$V_{max}(4.2V)$	0.0021	0.0021	2.5

NOTE: The applicant defined the normal working voltage of the EUT is from V_{min} Vdc to V_{max} Vdc.

FREQUENCY ERROR vs. TEMPERATURE.

TEMP. (°C)	5MHz		LIMIT (ppm)
	FREQUENCY ERROR (ppm)		
	Low Channel	High Channel	
-40	-0.0042	-0.0038	2.5
-30	-0.0062	-0.0058	2.5
-20	-0.0050	-0.0050	2.5
-10	-0.0041	-0.0042	2.5
0	-0.0036	-0.0035	2.5
10	-0.0023	-0.0026	2.5
20	-0.0020	-0.0018	2.5
30	-0.0014	-0.0012	2.5
40	-0.0006	-0.0008	2.5
50	-0.0003	-0.0001	2.5
85	-0.0025	-0.0033	2.5

FREQUENCY ERROR VS. VOLTAGE

VOLTAGE (Volts)	10MHz		LIMIT (ppm)
	FREQUENCY ERROR (ppm)		
	Low Channel	High Channel	
$V_{nor(3.7V)}$	0.0026	0.0023	2.5
$V_{min(3.6V)}$	-0.0031	-0.0030	2.5
$V_{max(4.2V)}$	0.0026	0.0024	2.5

NOTE: The applicant defined the normal working voltage of the EUT is from V_{min} Vdc to V_{max} Vdc.

FREQUENCY ERROR vs. TEMPERATURE.

TEMP. (°C)	10MHz		LIMIT (ppm)
	FREQUENCY ERROR (ppm)		
	Low Channel	High Channel	
-40	-0.0062	-0.0046	2.5
-30	-0.0059	-0.0057	2.5
-20	-0.0054	-0.0053	2.5
-10	-0.0041	-0.0041	2.5
0	-0.0038	-0.0037	2.5
10	-0.0022	-0.0023	2.5
20	-0.0017	-0.0020	2.5
30	-0.0018	-0.0011	2.5
40	-0.0008	-0.0006	2.5
50	-0.0002	-0.0003	2.5
85	-0.0019	-0.0006	2.5

FREQUENCY ERROR VS. VOLTAGE

VOLTAGE (Volts)	15MHz		LIMIT (ppm)
	FREQUENCY ERROR (ppm)		
	Low Channel	High Channel	
$V_{nor(3.7V)}$	0.0026	0.0024	2.5
$V_{min(3.6V)}$	-0.0031	-0.0030	2.5
$V_{max(4.2V)}$	0.0024	0.0024	2.5

NOTE: The applicant defined the normal working voltage of the EUT is from V_{min} Vdc to V_{max} Vdc.

FREQUENCY ERROR vs. TEMPERATURE.

TEMP. (°C)	15MHz		LIMIT (ppm)
	FREQUENCY ERROR (ppm)		
	Low Channel	High Channel	
-40	-0.0023	-0.0061	2.5
-30	-0.0060	-0.0059	2.5
-20	-0.0053	-0.0055	2.5
-10	-0.0041	-0.0041	2.5
0	-0.0037	-0.0036	2.5
10	-0.0021	-0.0026	2.5
20	-0.0019	-0.0020	2.5
30	-0.0016	-0.0010	2.5
40	-0.0005	-0.0007	2.5
50	-0.0002	-0.0001	2.5
85	-0.0023	-0.0014	2.5

FREQUENCY ERROR VS. VOLTAGE

VOLTAGE (Volts)	20MHz		LIMIT (ppm)
	FREQUENCY ERROR (ppm)		
	Low Channel	High Channel	
$V_{nor(3.7V)}$	0.0026	0.0023	2.5
$V_{min(3.6V)}$	-0.0030	-0.0031	2.5
$V_{max(4.2V)}$	0.0024	0.0024	2.5

NOTE: The applicant defined the normal working voltage of the EUT is from V_{min} Vdc to V_{max} Vdc.

FREQUENCY ERROR vs. TEMPERATURE.

TEMP. (°C)	20MHz		LIMIT (ppm)
	FREQUENCY ERROR (ppm)		
	Low Channel	High Channel	
-40	-0.0041	-0.0064	2.5
-30	-0.0059	-0.0061	2.5
-20	-0.0054	-0.0049	2.5
-10	-0.0042	-0.0040	2.5
0	-0.0037	-0.0035	2.5
10	-0.0021	-0.0023	2.5
20	-0.0019	-0.0017	2.5
30	-0.0015	-0.0011	2.5
40	-0.0008	-0.0007	2.5
50	-0.0002	-0.0001	2.5
85	-0.0017	-0.0044	2.5

LTE BAND 12 (BATTERY)

FREQUENCY ERROR VS. VOLTAGE

VOLTAGE (Volts)	1.4MHz		LIMIT (ppm)
	FREQUENCY ERROR (ppm)		
	Low Channel	High Channel	
$V_{nor(3.7V)}$	0.0027	0.0029	2.5
$V_{min(3.6V)}$	-0.0038	-0.0035	2.5
$V_{max(4.2V)}$	0.0026	0.0025	2.5

NOTE: The applicant defined the normal working voltage of the EUT is from V_{min} Vdc to V_{max} Vdc.

FREQUENCY ERROR vs. TEMPERATURE.

TEMP. (°C)	1.4MHz		LIMIT (ppm)
	FREQUENCY ERROR (ppm)		
	Low Channel	High Channel	
-40	-0.0160	-0.0099	2.5
-30	-0.0139	-0.0149	2.5
-20	-0.0122	-0.0123	2.5
-10	-0.0100	-0.0097	2.5
0	-0.0094	-0.0091	2.5
10	-0.0052	-0.0058	2.5
20	-0.0051	-0.0048	2.5
30	-0.0028	-0.0041	2.5
40	-0.0017	-0.0013	2.5
50	-0.0007	-0.0004	2.5
85	-0.0025	-0.0063	2.5

FREQUENCY ERROR VS. VOLTAGE

VOLTAGE (Volts)	3MHz		LIMIT (ppm)
	FREQUENCY ERROR (ppm)		
	Low Channel	High Channel	
$V_{nor(3.7V)}$	0.0026	0.0025	2.5
$V_{min(3.6V)}$	-0.0026	-0.0031	2.5
$V_{max(4.2V)}$	0.0024	0.0022	2.5

NOTE: The applicant defined the normal working voltage of the EUT is from V_{min} Vdc to V_{max} Vdc.

FREQUENCY ERROR vs. TEMPERATURE.

TEMP. (°C)	3MHz		LIMIT (ppm)
	FREQUENCY ERROR (ppm)		
	Low Channel	High Channel	
-40	-0.0187	-0.0196	2.5
-30	-0.0148	-0.0145	2.5
-20	-0.0129	-0.0125	2.5
-10	-0.0105	-0.0099	2.5
0	-0.0088	-0.0092	2.5
10	-0.0061	-0.0060	2.5
20	-0.0043	-0.0045	2.5
30	-0.0028	-0.0026	2.5
40	-0.0023	-0.0021	2.5
50	-0.0007	0.0001	2.5
85	-0.0016	0.0020	2.5

FREQUENCY ERROR VS. VOLTAGE

VOLTAGE (Volts)	5MHz		LIMIT (ppm)
	FREQUENCY ERROR (ppm)		
	Low Channel	High Channel	
$V_{nor(3.7V)}$	0.0026	0.0031	2.5
$V_{min(3.6V)}$	-0.0029	-0.0034	2.5
$V_{max(4.2V)}$	0.0026	0.0025	2.5

NOTE: The applicant defined the normal working voltage of the EUT is from V_{min} Vdc to V_{max} Vdc.

FREQUENCY ERROR vs. TEMPERATURE.

TEMP. (°C)	5MHz		LIMIT (ppm)
	FREQUENCY ERROR (ppm)		
	Low Channel	High Channel	
-40	-0.0140	-0.0132	2.5
-30	-0.0153	-0.0149	2.5
-20	-0.0125	-0.0135	2.5
-10	-0.0105	-0.0101	2.5
0	-0.0095	-0.0093	2.5
10	-0.0052	-0.0058	2.5
20	-0.0049	-0.0042	2.5
30	-0.0049	-0.0035	2.5
40	-0.0018	-0.0017	2.5
50	-0.0002	-0.0004	2.5
85	-0.0007	-0.0009	2.5

FREQUENCY ERROR VS. VOLTAGE

VOLTAGE (Volts)	10MHz		LIMIT (ppm)
	FREQUENCY ERROR (ppm)		
	Low Channel	High Channel	
$V_{nor(3.7V)}$	0.0033	0.0026	2.5
$V_{min(3.6V)}$	-0.0037	-0.0036	2.5
$V_{max(4.2V)}$	0.0035	0.0029	2.5

NOTE: The applicant defined the normal working voltage of the EUT is from V_{min} Vdc to V_{max} Vdc.

FREQUENCY ERROR vs. TEMPERATURE.

TEMP. (°C)	10MHz		LIMIT (ppm)
	FREQUENCY ERROR (ppm)		
	Low Channel	High Channel	
-40	-0.0120	-0.0112	2.5
-30	-0.0145	-0.0139	2.5
-20	-0.0132	-0.0132	2.5
-10	-0.0098	-0.0096	2.5
0	-0.0091	-0.0088	2.5
10	-0.0066	-0.0057	2.5
20	-0.0046	-0.0044	2.5
30	-0.0028	-0.0041	2.5
40	-0.0019	-0.0016	2.5
50	0.0003	-0.0006	2.5
85	0.0014	-0.0036	2.5



BUREAU
VERITAS

Test Report No.: W7L-P22080014RF03

LTE BAND 13 (BATTERY)

FREQUENCY ERROR VS. VOLTAGE

VOLTAGE (Volts)	5MHz		LIMIT (ppm)
	FREQUENCY ERROR (ppm)		
	Low Channel	High Channel	
$V_{nor}(3.7V)$	0.0023	0.0019	2.5
$V_{min}(3.6V)$	-0.0026	-0.0025	2.5
$V_{max}(4.2V)$	0.0017	0.0016	2.5

NOTE: The applicant defined the normal working voltage of the EUT is from V_{min} Vdc to V_{max} Vdc.

FREQUENCY ERROR vs. TEMPERATURE.

TEMP. (°C)	5MHz		LIMIT (ppm)
	FREQUENCY ERROR (ppm)		
	Low Channel	High Channel	
-40	-0.0117	-0.0160	2.5
-30	-0.0132	-0.0134	2.5
-20	-0.0123	-0.0121	2.5
-10	-0.0108	-0.0107	2.5
0	-0.0088	-0.0085	2.5
10	-0.0074	-0.0066	2.5
20	-0.0058	-0.0057	2.5
30	-0.0047	-0.0045	2.5
40	-0.0026	-0.0024	2.5
50	-0.0009	-0.0005	2.5
85	-0.0019	-0.0010	2.5

FREQUENCY ERROR VS. VOLTAGE

VOLTAGE (Volts)	10MHz	LIMIT (ppm)
	FREQUENCY ERROR (ppm)	
	Mid Channel	
$V_{nor(3.7V)}$	0.0027	2.5
$V_{min(3.6V)}$	-0.0025	2.5
$V_{max(4.2V)}$	0.0018	2.5

NOTE: The applicant defined the normal working voltage of the EUT is from V_{min} Vdc to V_{max} Vdc.

FREQUENCY ERROR vs. TEMPERATURE.

TEMP. (°C)	10MHz	LIMIT (ppm)
	FREQUENCY ERROR (ppm)	
	Mid Channel	
-40	-0.0121	2.5
-30	-0.0136	2.5
-20	-0.0115	2.5
-10	-0.0096	2.5
0	-0.0074	2.5
10	-0.0058	2.5
20	-0.0043	2.5
30	-0.0025	2.5
40	-0.0009	2.5
50	0.0007	2.5
85	0.0004	2.5

LTE BAND 4 (DC SOURCE)

FREQUENCY ERROR VS. VOLTAGE

VOLTAGE (Volts)	1.4MHz		LIMIT (ppm)
	FREQUENCY ERROR (ppm)		
	Low Channel	High Channel	
$V_{nor(30V)}$	0.0024	0.0027	2.5
$V_{min(8V)}$	-0.0033	-0.0035	2.5
$V_{max(48V)}$	0.0023	0.0022	2.5

NOTE: The applicant defined the normal working voltage of the EUT is from V_{min} Vdc to V_{max} Vdc.

FREQUENCY ERROR vs. TEMPERATURE.

TEMP. (°C)	1.4MHz		LIMIT (ppm)
	FREQUENCY ERROR (ppm)		
	Low Channel	High Channel	
-40	-0.0060	-0.0080	2.5
-30	-0.0057	-0.0058	2.5
-20	-0.0056	-0.0056	2.5
-10	-0.0048	-0.0046	2.5
0	-0.0042	-0.0045	2.5
10	-0.0039	-0.0036	2.5
20	-0.0032	-0.0030	2.5
30	-0.0025	-0.0023	2.5
40	-0.0021	-0.0020	2.5
50	-0.0018	-0.0016	2.5
85	-0.0030	-0.0045	2.5

FREQUENCY ERROR VS. VOLTAGE

VOLTAGE (Volts)	3MHz		LIMIT (ppm)
	FREQUENCY ERROR (ppm)		
	Low Channel	High Channel	
$V_{nor(30V)}$	0.0026	0.0024	2.5
$V_{min(8V)}$	-0.0023	-0.0026	2.5
$V_{max(48V)}$	0.0019	0.0016	2.5

NOTE: The applicant defined the normal working voltage of the EUT is from V_{min} Vdc to V_{max} Vdc.

FREQUENCY ERROR vs. TEMPERATURE.

TEMP. (°C)	3MHz		LIMIT (ppm)
	FREQUENCY ERROR (ppm)		
	Low Channel	High Channel	
-40	-0.0012	-0.0068	2.5
-30	-0.0062	-0.0059	2.5
-20	-0.0060	-0.0057	2.5
-10	-0.0079	-0.0068	2.5
0	-0.0074	-0.0070	2.5
10	-0.0068	-0.0054	2.5
20	-0.0054	-0.0050	2.5
30	-0.0043	-0.0041	2.5
40	-0.0038	-0.0036	2.5
50	-0.0026	-0.0029	2.5
85	-0.0016	-0.0079	2.5

FREQUENCY ERROR VS. VOLTAGE

VOLTAGE (Volts)	5MHz		LIMIT (ppm)
	FREQUENCY ERROR (ppm)		
	Low Channel	High Channel	
$V_{nor}(30V)$	0.0025	0.0029	2.5
$V_{min}(8V)$	-0.0028	-0.0037	2.5
$V_{max}(48V)$	0.0027	0.0026	2.5

NOTE: The applicant defined the normal working voltage of the EUT is from V_{min} Vdc to V_{max} Vdc.

FREQUENCY ERROR vs. TEMPERATURE.

TEMP. (°C)	5MHz		LIMIT (ppm)
	FREQUENCY ERROR (ppm)		
	Low Channel	High Channel	
-40	-0.0059	-0.0064	2.5
-30	-0.0063	-0.0093	2.5
-20	-0.0058	-0.0056	2.5
-10	-0.0054	-0.0051	2.5
0	-0.0045	-0.0046	2.5
10	-0.0042	-0.0041	2.5
20	-0.0038	-0.0036	2.5
30	-0.0031	-0.0030	2.5
40	-0.0028	-0.0027	2.5
50	-0.0023	-0.0022	2.5
85	-0.0024	-0.0027	2.5

FREQUENCY ERROR VS. VOLTAGE

VOLTAGE (Volts)	10MHz		LIMIT (ppm)
	FREQUENCY ERROR (ppm)		
	Low Channel	High Channel	
$V_{nor(30V)}$	0.0028	0.0026	2.5
$V_{min(8V)}$	-0.0034	-0.0033	2.5
$V_{max(48V)}$	0.0028	0.0025	2.5

NOTE: The applicant defined the normal working voltage of the EUT is from V_{min} Vdc to V_{max} Vdc.

FREQUENCY ERROR vs. TEMPERATURE.

TEMP. (°C)	10MHz		LIMIT (ppm)
	FREQUENCY ERROR (ppm)		
	Low Channel	High Channel	
-40	-0.0046	-0.0034	2.5
-30	-0.0053	-0.0057	2.5
-20	-0.0054	-0.0056	2.5
-10	-0.0041	-0.0041	2.5
0	-0.0044	-0.0042	2.5
10	-0.0038	-0.0037	2.5
20	-0.0032	-0.0033	2.5
30	-0.0029	-0.0027	2.5
40	-0.0025	-0.0024	2.5
50	-0.0022	-0.0020	2.5
85	-0.0004	-0.0069	2.5

FREQUENCY ERROR VS. VOLTAGE

VOLTAGE (Volts)	15MHz		LIMIT (ppm)
	FREQUENCY ERROR (ppm)		
	Low Channel	High Channel	
$V_{nor(30V)}$	0.0027	0.0029	2.5
$V_{min(8V)}$	-0.0036	-0.0034	2.5
$V_{max(48V)}$	0.0029	0.0027	2.5

NOTE: The applicant defined the normal working voltage of the EUT is from V_{min} Vdc to V_{max} Vdc.

FREQUENCY ERROR vs. TEMPERATURE.

TEMP. (°C)	15MHz		LIMIT (ppm)
	FREQUENCY ERROR (ppm)		
	Low Channel	High Channel	
-40	-0.0049	-0.0021	2.5
-30	-0.0059	-0.0057	2.5
-20	-0.0053	-0.0050	2.5
-10	-0.0048	-0.0044	2.5
0	-0.0042	-0.0040	2.5
10	-0.0043	-0.0041	2.5
20	-0.0038	-0.0035	2.5
30	-0.0034	-0.0032	2.5
40	-0.0028	-0.0026	2.5
50	-0.0025	-0.0023	2.5
85	-0.0031	-0.0058	2.5

FREQUENCY ERROR VS. VOLTAGE

VOLTAGE (Volts)	20MHz		LIMIT (ppm)
	FREQUENCY ERROR (ppm)		
	Low Channel	High Channel	
$V_{nor(30V)}$	0.0023	0.0026	2.5
$V_{min(8V)}$	-0.0034	-0.0032	2.5
$V_{max(48V)}$	0.0025	0.0022	2.5

NOTE: The applicant defined the normal working voltage of the EUT is from V_{min} Vdc to V_{max} Vdc.

FREQUENCY ERROR vs. TEMPERATURE.

TEMP. (°C)	20MHz		LIMIT (ppm)
	FREQUENCY ERROR (ppm)		
	Low Channel	High Channel	
-40	-0.0039	-0.0047	2.5
-30	-0.0057	-0.0059	2.5
-20	-0.0055	-0.0053	2.5
-10	-0.0048	-0.0046	2.5
0	-0.0044	-0.0042	2.5
10	-0.0040	-0.0040	2.5
20	-0.0038	-0.0036	2.5
30	-0.0033	-0.0031	2.5
40	-0.0026	-0.0029	2.5
50	-0.0023	-0.0020	2.5
85	-0.003	0.0052	2.5

LTE BAND 12 (DC SOURCE)

FREQUENCY ERROR VS. VOLTAGE

VOLTAGE (Volts)	1.4MHz		LIMIT (ppm)
	FREQUENCY ERROR (ppm)		
	Low Channel	High Channel	
$V_{nor(30V)}$	0.0029	0.0027	2.5
$V_{min(8V)}$	-0.0035	-0.0032	2.5
$V_{max(48V)}$	0.0023	0.0020	2.5

NOTE: The applicant defined the normal working voltage of the EUT is from V_{min} Vdc to V_{max} Vdc.

FREQUENCY ERROR vs. TEMPERATURE.

TEMP. (°C)	1.4MHz		LIMIT (ppm)
	FREQUENCY ERROR (ppm)		
	Low Channel	High Channel	
-40	-0.0087	-0.0321	2.5
-30	-0.0117	-0.0115	2.5
-20	-0.0106	-0.0101	2.5
-10	-0.0100	-0.0099	2.5
0	-0.0091	-0.0093	2.5
10	-0.0064	-0.0063	2.5
20	-0.0053	-0.0050	2.5
30	-0.0048	-0.0045	2.5
40	-0.0041	-0.0040	2.5
50	-0.0038	-0.0036	2.5
85	-0.0024	-0.0053	2.5

FREQUENCY ERROR VS. VOLTAGE

VOLTAGE (Volts)	3MHz		LIMIT (ppm)
	FREQUENCY ERROR (ppm)		
	Low Channel	High Channel	
$V_{nor(30V)}$	0.0027	0.0026	2.5
$V_{min(8V)}$	-0.0024	-0.0035	2.5
$V_{max(48V)}$	0.0026	0.0023	2.5

NOTE: The applicant defined the normal working voltage of the EUT is from V_{min} Vdc to V_{max} Vdc.

FREQUENCY ERROR vs. TEMPERATURE.

TEMP. (°C)	3MHz		LIMIT (ppm)
	FREQUENCY ERROR (ppm)		
	Low Channel	High Channel	
-40	-0.0102	-0.0187	2.5
-30	-0.0142	-0.0135	2.5
-20	-0.0127	-0.0123	2.5
-10	-0.0107	-0.0096	2.5
0	-0.0089	-0.0095	2.5
10	-0.0074	-0.0071	2.5
20	-0.0065	-0.0060	2.5
30	-0.0057	-0.0052	2.5
40	-0.0046	-0.0044	2.5
50	-0.0032	0.0030	2.5
85	-0.0051	0.0026	2.5

FREQUENCY ERROR VS. VOLTAGE

VOLTAGE (Volts)	5MHz		LIMIT (ppm)
	FREQUENCY ERROR (ppm)		
	Low Channel	High Channel	
$V_{nor(30V)}$	0.0028	0.0034	2.5
$V_{min(8V)}$	-0.0027	-0.0035	2.5
$V_{max(48V)}$	0.0028	0.0026	2.5

NOTE: The applicant defined the normal working voltage of the EUT is from V_{min} Vdc to V_{max} Vdc.

FREQUENCY ERROR vs. TEMPERATURE.

TEMP. (°C)	5MHz		LIMIT (ppm)
	FREQUENCY ERROR (ppm)		
	Low Channel	High Channel	
-40	-0.0101	-0.0127	2.5
-30	-0.0155	-0.0148	2.5
-20	-0.0127	-0.0130	2.5
-10	-0.0106	-0.0100	2.5
0	-0.0090	-0.0096	2.5
10	-0.0080	-0.0078	2.5
20	-0.0065	-0.0065	2.5
30	-0.0056	-0.0051	2.5
40	-0.0047	-0.0040	2.5
50	-0.0039	-0.0037	2.5
85	-0.0043	-0.0082	2.5

FREQUENCY ERROR VS. VOLTAGE

VOLTAGE (Volts)	10MHz		LIMIT (ppm)
	FREQUENCY ERROR (ppm)		
	Low Channel	High Channel	
$V_{nor(30V)}$	0.0030	0.0028	2.5
$V_{min(8V)}$	-0.0034	-0.0038	2.5
$V_{max(48V)}$	0.0030	0.0028	2.5

NOTE: The applicant defined the normal working voltage of the EUT is from V_{min} Vdc to V_{max} Vdc.

FREQUENCY ERROR vs. TEMPERATURE.

TEMP. (°C)	10MHz		LIMIT (ppm)
	FREQUENCY ERROR (ppm)		
	Low Channel	High Channel	
-40	-0.0117	-0.0154	2.5
-30	-0.0148	-0.0136	2.5
-20	-0.0134	-0.0131	2.5
-10	-0.0096	-0.0097	2.5
0	-0.0090	-0.0084	2.5
10	-0.0067	-0.0063	2.5
20	-0.0058	-0.0051	2.5
30	-0.0048	-0.0043	2.5
40	-0.0037	-0.0034	2.5
50	0.0032	-0.0030	2.5
85	0.0012	-0.0008	2.5



LTE BAND 13 (DC SOURCE)

FREQUENCY ERROR VS. VOLTAGE

VOLTAGE (Volts)	5MHz		LIMIT (ppm)
	FREQUENCY ERROR (ppm)		
	Low Channel	High Channel	
V _{nor} (30V)	0.0026	0.0019	2.5
V _{min} (8V)	-0.0029	-0.0024	2.5
V _{max} (48V)	0.0018	0.0017	2.5

NOTE: The applicant defined the normal working voltage of the EUT is from V_{min} Vdc to V_{max} Vdc.

FREQUENCY ERROR vs. TEMPERATURE.

TEMP. (°C)	5MHz		LIMIT (ppm)
	FREQUENCY ERROR (ppm)		
	Low Channel	High Channel	
-40	-0.0115	-0.0139	2.5
-30	-0.0131	-0.0129	2.5
-20	-0.0125	-0.0123	2.5
-10	-0.0111	-0.0106	2.5
0	-0.0095	-0.0091	2.5
10	-0.0084	-0.0080	2.5
20	-0.0071	-0.0075	2.5
30	-0.0068	-0.0064	2.5
40	-0.0057	-0.0053	2.5
50	-0.0046	-0.0043	2.5
85	-0.0028	-0.0050	2.5

FREQUENCY ERROR VS. VOLTAGE

VOLTAGE (Volts)	10MHz	LIMIT (ppm)
	FREQUENCY ERROR (ppm)	
	Mid Channel	
$V_{nor(30V)}$	0.0028	2.5
$V_{min(8V)}$	-0.0026	2.5
$V_{max(48V)}$	0.0019	2.5

NOTE: The applicant defined the normal working voltage of the EUT is from V_{min} Vdc to V_{max} Vdc.

FREQUENCY ERROR vs. TEMPERATURE.

TEMP. (°C)	10MHz	LIMIT (ppm)
	FREQUENCY ERROR (ppm)	
	Mid Channel	
-40	-0.0110	2.5
-30	-0.0134	2.5
-20	-0.0118	2.5
-10	-0.0094	2.5
0	-0.0085	2.5
10	-0.0067	2.5
20	-0.0055	2.5
30	-0.0047	2.5
40	-0.0036	2.5
50	0.0025	2.5
85	0.0021	2.5

3.3 OCCUPIED BANDWIDTH MEASUREMENT

3.3.1 LIMITS OF OCCUPIED BANDWIDTH MEASUREMENT

The width of a frequency band such that, below the lower and above the upper frequency limits, the mean powers emitted are each equal to a specified percentage 0.5 % of the total mean power of a given emission.

3.3.2 TEST SETUP

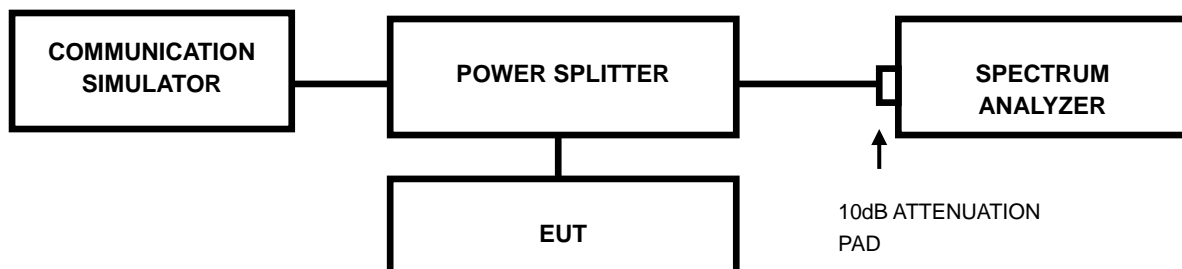

3.3.3 TEST PROCEDURES

- The conducted occupied bandwidth used the power splitter via EUT RF power connector between simulation base station and spectrum analyzer.
- Use OBW measurement function of Spectrum analyzer to measure 99 % occupied bandwidth.



Test Report No.: W7L-P22080014RF03

3.3.4 TEST RESULTS

Please Refer to Module report R2007A0435-R6.



3.4 BAND EDGE MEASUREMENT

3.4.1 LIMITS OF BAND EDGE MEASUREMENT

According to FCC 27.53(c) specified that For operations in the 746-758 MHz band and the 776-788 MHz band , the power of any emission shall be attenuated outside the band below the transmitter power (P) by at least $43 + 10 \log (P)$ dB. However, in the 100 kilohertz bands immediately outside and adjacent to a licensee's frequency block, a resolution bandwidth of at least 30 kHz may be employed. In addition, the power of any unwanted emission in an 6.25kHz bandwidth for all frequencies between 763-775 MHz and 793-806 MHz shall be attenuated below the transmitter power, P(dBW), by at least $65 + 10 \log 10p(P)$, dB, for mobile and portable equipment.

According to FCC 27.53(g) specified that For operations in the 600 MHz band and the 698-746 MHz band, the power of any emission outside a licensee's frequency band(s) of operation shall be attenuated below the transmitter power (P) within the licensed band(s) of operation, measured in watts, by at least $43 + 10 \log (P)$ dB. However, in the 100 kilohertz bands immediately outside and adjacent to a licensee's frequency block, a resolution bandwidth of at least 30 kHz may be employed.

According to FCC 27.53(h) specified that For operations in the 1710-1755 MHz band, the power of any emission outside a licensee's frequency band(s) of operation shall be attenuated below the transmitter power (P) within the licensed band(s) of operation, measured in watts, by at least $43 + 10 \log (P)$ dB. However, in the 1 megahertz bands immediately outside and adjacent to the licensee's frequency block, a resolution bandwidth of at least one percent of the emission bandwidth of the fundamental emission of the transmitter may be employed.

According to FCC 27.53(m)(4) specified that For mobile digital stations, the attenuation factor shall be not less than $40 + 10 \log (P)$ dB on all frequencies between the channel edge and 5 megahertz from the channel edge, $43 + 10 \log (P)$ dB on all frequencies between 5 megahertz and X megahertz from the channel edge, and $55 + 10 \log (P)$ dB on all frequencies more than X megahertz from the channel edge, where X is the greater of 6 megahertz or the actual emission bandwidth as defined in paragraph (m)(6) of this section. In addition, the attenuation factor shall not be less that $43 + 10 \log (P)$ dB on all frequencies between 2490.5 MHz and 2496 MHz and $55 + 10 \log (P)$ dB at or below 2490.5 MHz. Mobile Satellite Service licensees operating on frequencies below 2495 MHz may also submit a documented interference complaint against BRS licensees operating on channel BRS Channel 1 on the same terms and conditions as adjacent channel BRS or EBS licensees. For mobile digital stations, in the 1 megahertz bands immediately outside and adjacent to the frequency block a resolution bandwidth of at least two percent may be employed.

3.4.2 TEST SETUP

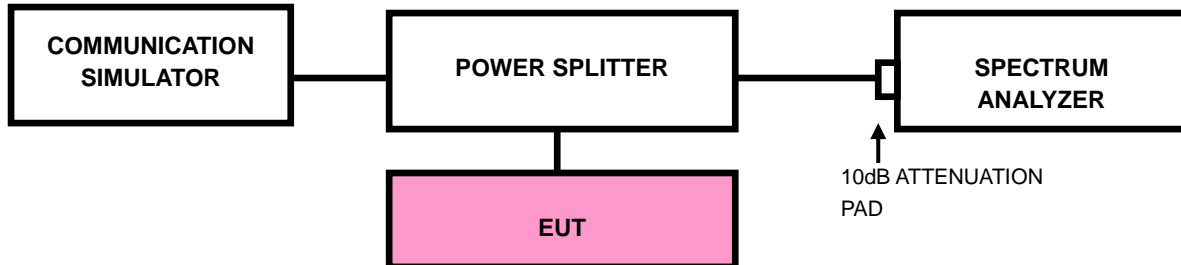

3.4.3 TEST PROCEDURES

- a. All measurements were done at low and high operational frequency range.
- b. The center frequency of spectrum is the band edge frequency and span is 1~5 MHz.
RBW of the spectrum is 10kHz and VBW of the spectrum is 30kHz (LTE bandwidth for (1.4M/3M/5M/10M/15M/20M)1RB/0RB&1RB/MAXRB).
- c. The center frequency of spectrum is the band edge frequency and span is 1~5 MHz.
RBW of the spectrum is $\geq 1\% \cdot \text{EBW}$ kHz and VBW of the spectrum is $3 \cdot \text{RBW}$ kHz.
(LTE bandwidth 1.4M/3M/5M/10M/15M/20MHz).
- d. Record the max trace plot into the test report.



Test Report No.: W7L-P22080014RF03

3.4.4 TEST RESULTS

Please Refer to Module report R2007A0435-R6.

3.5 CONDUCTED SPURIOUS EMISSIONS

3.5.1 LIMITS OF CONDUCTED SPURIOUS EMISSIONS MEASUREMENT

The power of any emission outside of the authorized operating frequency ranges must be attenuated below the transmitting power (P) by a factor of at least $43 + 10 \log(P)$ dB. The emission limit equal to -13dBm .

For:LTE Band7&7C

The power of any emission outside a licensee's frequency block shall be attenuated below the transmitter power (P) by at least $55 + 10 \log_{10}(P)$ dB. The limit of emission is equal to -25dBm .

3.5.2 TEST PROCEDURE

- a. The EUT makes a phone call to the communication simulator. All measurements were done at low, middle and high operational frequency range.
- b. Measuring frequency range is from 30MHz up to a frequency including its 10th harmonic. 10dB attenuation pad is connected with spectrum. RBW=1MHz and VBW=3MHz is used for conducted emission measurement.

3.5.3 TEST SETUP

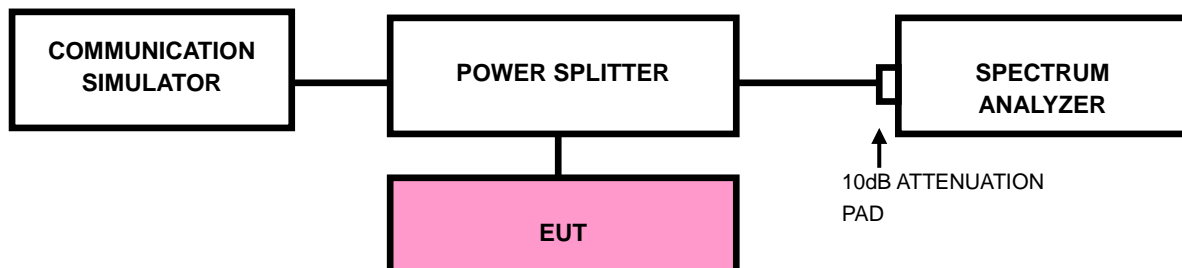



**BUREAU
VERITAS**

Test Report No.: W7L-P22080014RF03

3.5.4 TEST RESULTS

NOTE : The 9K~30MHz amplitude of spurious emissions attenuated more than 20 dB below the permissible value is not required in the report.

Please Refer to Module report R2007A0435-R6.



3.6 RADIATED EMISSION MEASUREMENT

3.6.1 LIMITS OF RADIATED EMISSION MEASUREMENT

The power of any emission outside of the authorized operating frequency ranges must be attenuated below the transmitting power (P) by a factor of at least $43 + 10 \log(P)$ dB. The emission limit equal to -13dBm .

For: LTE Band7/7C

The power of any emission outside a licensee's frequency block shall be attenuated below the transmitter power (P) by at least $55 + 10 \log_{10}(P)$ dB. The limit of emission is equal to -25dBm .

3.6.2 TEST PROCEDURES

- a. Substitution method is used for E.I.R.P measurement. In the semi-anechoic chamber, EUT placed on the 0.8m height of Turn Table, rotated the table around 360 degrees to search the maximum radiation power and receiver antenna shall be rotated vertical and horizontal polarization and moved height from 1m to 4m to find the maximum polar radiated power. The "Read Value" is the spectrum reading the maximum power value.
- b. The substitution horn antenna is substituted for EUT at the same position and signals generator export the CW signal to the substitution antenna via a TX cable. Rotated the Turn Table and moved receiving antenna to find the maximum radiation power. Adjust output power level of S.G to get a Value of spectrum reading equal to "Read Value " of step a. Record the power level of S.G.
- c. $\text{EIRP} = \text{Output power level of S.G} - \text{TX cable loss} + \text{Antenna gain of substitution horn}$.
- d. E.R.P power can be calculated form E.I.R.P power by subtracting the gain of dipole, $\text{E.R.P power} = \text{E.I.P.R power} - 2.15\text{dBi}$.

NOTE: The resolution bandwidth of spectrum analyzer is 1 MHz and the video bandwidth is 3 MHz.

3.6.3 DEVIATION FROM TEST STANDARD

No deviation

3.6.4 TEST SETUP

< Frequency Range below 30MHz >

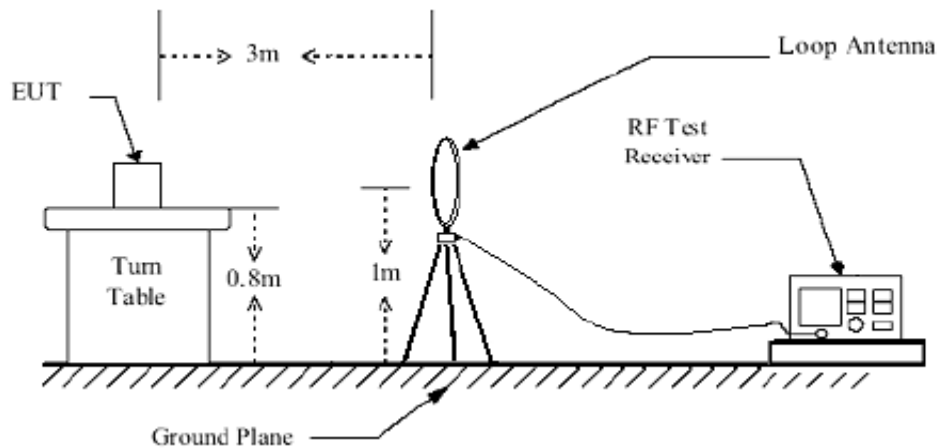

< Frequency Range 30MHz~1GHz >

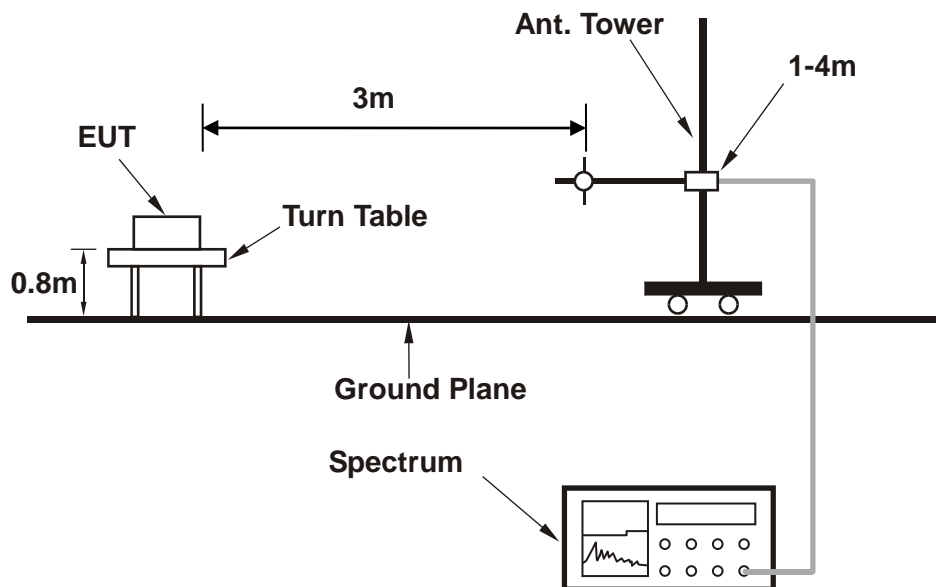

<Frequency Range above 1GHz>

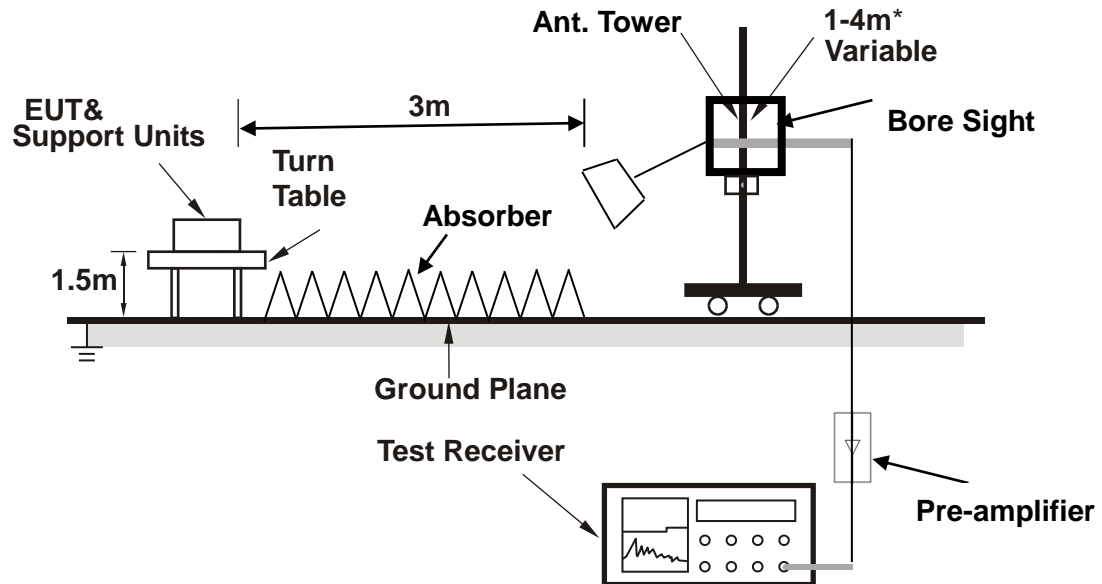

Note: Above 1G is a directional antenna depends on the EUT height and the antenna 3dB beamwidth both, refer to section 7.3 of CISPR 16-2-3.

For the actual test configuration, please refer to the attached file (Test Setup Photo).



3.6.5 TEST RESULTS

NOTE : 1.The 9K~30MHz amplitude of spurious emissions attenuated more than 20 dB below the permissible value is not required in the report.

2.Pre-scan battery supply and DC SOURCE,Worse case is DC SOURCE

BELOW 1GHz WORST-CASE DATA 1(With the antenna)

30 MHz – 1GHz data:

LTE Band 12

CHANNEL BANDWIDTH: 3MHz / QPSK

MODE	TX channel 23095	FREQUENCY RANGE	Below 1000MHz
ENVIRONMENTAL CONDITIONS	23deg. C, 70%RH	INPUT POWER	DC30V
TESTED BY	Jace Hu		
ANTENNA POLARITY & TEST DISTANCE: HORIZONTAL AT 3 M			

	Freq	Level	Read Level	Limit Line	Over Limit	Factor	Remark	Pol/Phase
	MHz	dBm/m	dBm	dBm/m	dB	dB/m		
1	54.250	-56.70	-38.98	-13.00	-43.70	-17.72	Peak	Horizontal
2	132.820	-61.17	-40.42	-13.00	-48.17	-20.75	Peak	Horizontal
3 PP	256.010	-51.34	-39.77	-13.00	-38.34	-11.57	Peak	Horizontal
4	321.970	-54.32	-42.39	-13.00	-41.32	-11.93	Peak	Horizontal
5	435.460	-57.77	-48.38	-13.00	-44.77	-9.39	Peak	Horizontal
6	479.110	-57.53	-48.91	-13.00	-44.53	-8.62	Peak	Horizontal

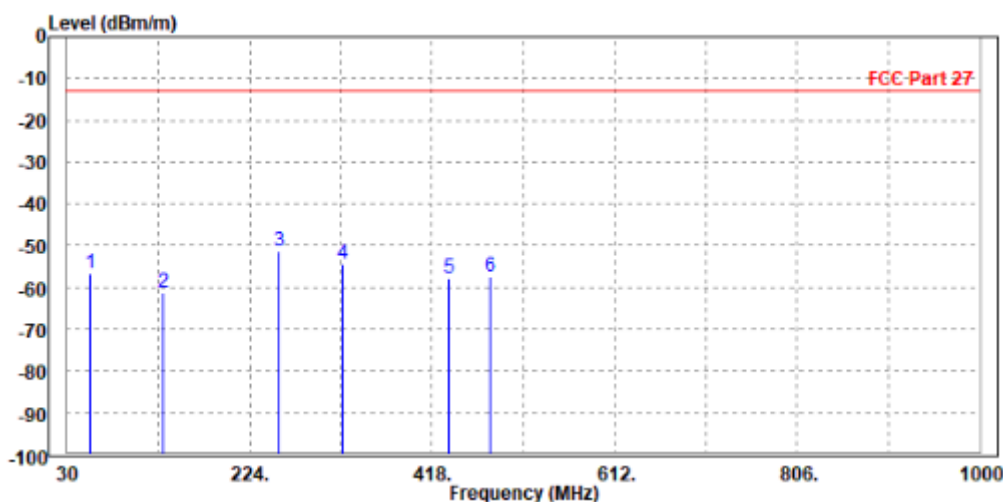



Test Report No.: W7L-P22080014RF03

MODE	TX channel 23095	FREQUENCY RANGE	Below 1000MHz
ENVIRONMENTAL CONDITIONS	23deg. C, 70%RH	INPUT POWER	DC30V
TESTED BY	Jace Hu		
ANTENNA POLARITY & TEST DISTANCE: VERTICAL AT 3 M			

	Freq	Level	Read Level	Limit Line	Over Limit	Factor	Remark	Pol/Phase
	MHz	dBm/m	dBm	dBm/m	dB	dB/m		
1	54.250	-59.17	-34.58	-13.00	-46.17	-24.59	Peak	Vertical
2	118.270	-59.11	-45.08	-13.00	-46.11	-14.03	Peak	Vertical
3 PP	132.820	-55.53	-41.65	-13.00	-42.53	-13.88	Peak	Vertical
4	237.580	-64.05	-49.35	-13.00	-51.05	-14.70	Peak	Vertical
5	326.820	-64.02	-53.69	-13.00	-51.02	-10.33	Peak	Vertical
6	486.870	-59.73	-51.53	-13.00	-46.73	-8.20	Peak	Vertical

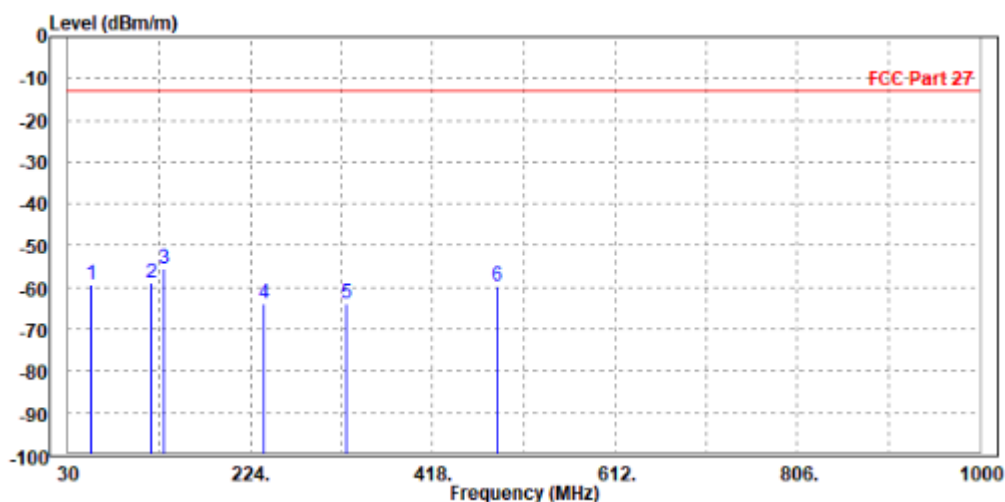



**BUREAU
VERITAS**

Test Report No.: W7L-P22080014RF03

ABOVE 1GHz

Note: For higher frequency, the emission is too low to be detected.

LTE Band 4

CHANNEL BANDWIDTH: 1.4MHz / QPSK

CH 19957

MODE	TX channel 19957	FREQUENCY RANGE	Above 1000MHz
ENVIRONMENTAL CONDITIONS	23deg. C, 70%RH	INPUT POWER	DC30V
TESTED BY	Jace Hu		
ANTENNA POLARITY & TEST DISTANCE: HORIZONTAL AT 3 M			

	Read	Limit	Over				
Freq	Level	Level	Line	Limit	Factor	Remark	Pol/Phase
MHz	dBm/m	dBm	dBm/m	dB	dB/m		
1 PP 3418.000	-38.19	-45.40	-13.00	-25.19	7.21	Peak	Horizontal
2 5132.100	-49.62	-59.52	-13.00	-36.62	9.90	Peak	Horizontal

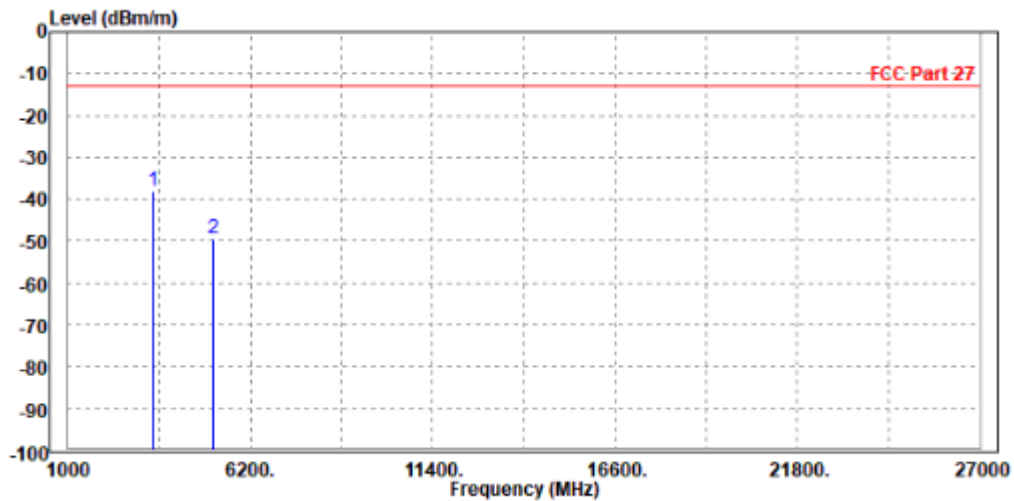



Test Report No.: W7L-P22080014RF03

MODE	TX channel 19957	FREQUENCY RANGE	Above 1000MHz
ENVIRONMENTAL CONDITIONS	23deg. C, 70%RH	INPUT POWER	DC30V
TESTED BY	Jace Hu		
ANTENNA POLARITY & TEST DISTANCE: VERTICAL AT 3 M			

	Freq	Level	Read Level	Limit Line	Over Limit	Factor	Remark	Pol/Phase
	MHz	dBm/m	dBm	dBm/m	dB	dB/m		
1	PP 3421.400	-36.46	-43.66	-13.00	-23.46	7.20	Peak	Vertical
2	5134.000	-49.61	-60.00	-13.00	-36.61	10.39	Peak	Vertical

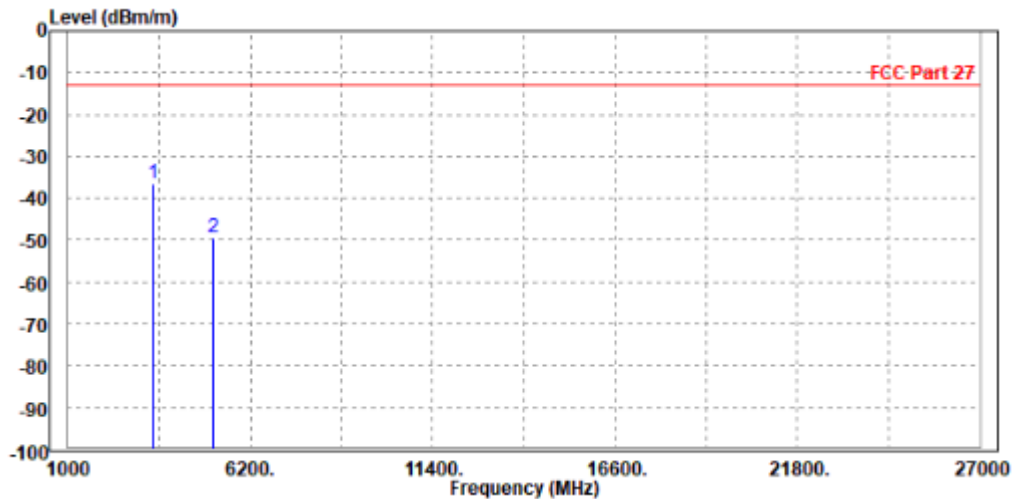



**BUREAU
VERITAS**

Test Report No.: W7L-P22080014RF03

CH 20175

MODE	TX channel 20175	FREQUENCY RANGE	Above 1000MHz
ENVIRONMENTAL CONDITIONS	23deg. C, 70%RH	INPUT POWER	DC30V
TESTED BY	Jace Hu		
ANTENNA POLARITY & TEST DISTANCE: HORIZONTAL AT 3 M			

	Freq	Level	Read Level	Limit	Over Limit	Factor	Remark	Pol/Phase
	MHz	dBm/m	dBm	dBm/m	dB	dB/m		
1	PP 3465.000	-42.65	-49.92	-13.00	-29.65	7.27	Peak	Horizontal
2	5186.000	-50.61	-60.59	-13.00	-37.61	9.98	Peak	Horizontal

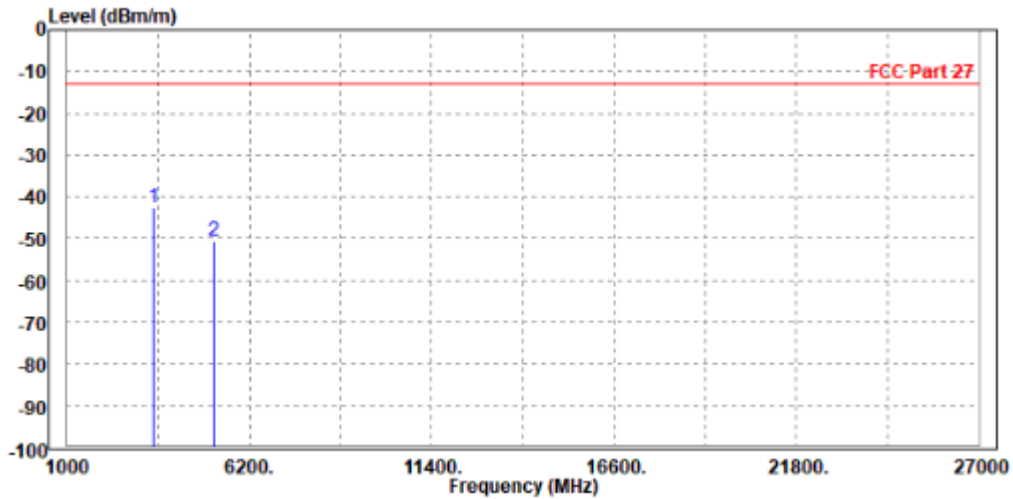



Test Report No.: W7L-P22080014RF03

MODE	TX channel 20175	FREQUENCY RANGE	Above 1000MHz
ENVIRONMENTAL CONDITIONS	23deg. C, 70%RH	INPUT POWER	DC30V
TESTED BY	Jace Hu		
ANTENNA POLARITY & TEST DISTANCE: VERTICAL AT 3 M			

	Freq	Level	Read Level	Limit Line	Over Limit	Factor	Remark	Pol/Phase
	MHz	dBm/m	dBm	dBm/m	dB	dB/m		
1	PP 3470.000	-35.69	-42.96	-13.00	-22.69	7.27	Peak	Vertical
2	5197.500	-50.29	-60.74	-13.00	-37.29	10.45	Peak	Vertical

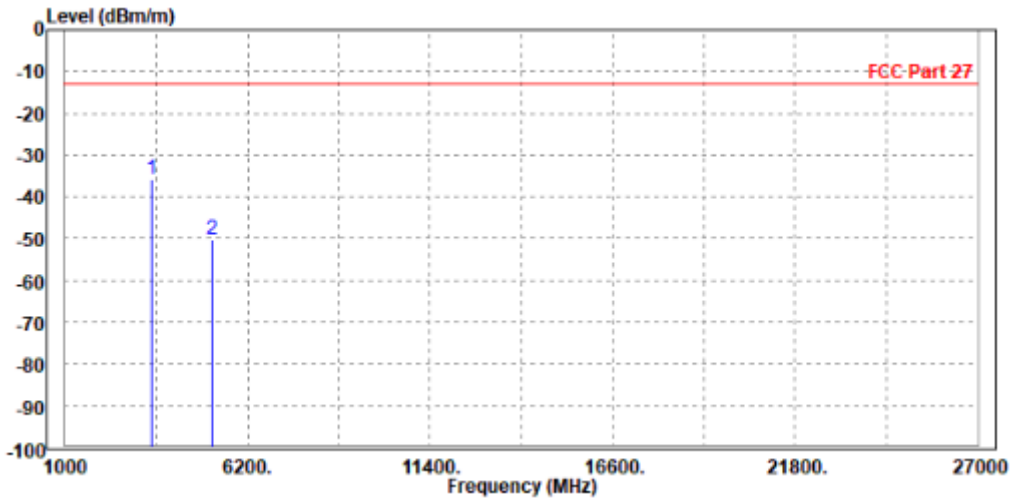



**BUREAU
VERITAS**

Test Report No.: W7L-P22080014RF03

CH 20393

MODE	TX channel 20393	FREQUENCY RANGE	Above 1000MHz
ENVIRONMENTAL CONDITIONS	23deg. C, 70%RH	INPUT POWER	DC30V
TESTED BY	Jace Hu		
ANTENNA POLARITY & TEST DISTANCE: HORIZONTAL AT 3 M			

	Freq	Level	Read Level	Limit Line	Over Limit	Factor	Remark	Pol/Phase
	MHz	dBm/m	dBm	dBm/m	dB	dB/m		
1	PP 3508.600	-40.99	-48.33	-13.00	-27.99	7.34	Peak	Horizontal
2	5264.000	-51.12	-61.22	-13.00	-38.12	10.10	Peak	Horizontal

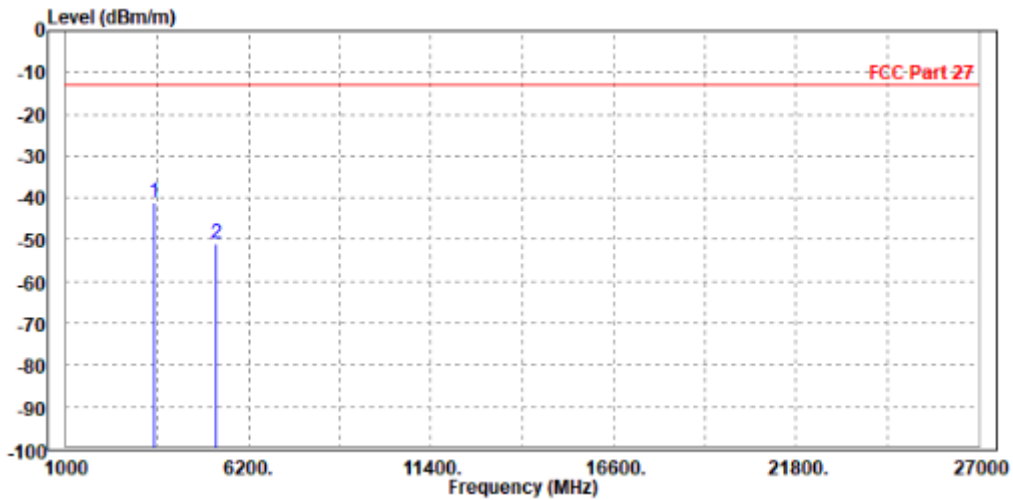



Test Report No.: W7L-P22080014RF03

MODE	TX channel 20393	FREQUENCY RANGE	Above 1000MHz
ENVIRONMENTAL CONDITIONS	23deg. C, 70%RH	INPUT POWER	DC30V
TESTED BY	Jace Hu		
ANTENNA POLARITY & TEST DISTANCE: VERTICAL AT 3 M			

	Read	Limit	Over				
Freq	Level	Level	Line	Limit	Factor	Remark	Pol/Phase
MHz	dBm/m	dBm	dBm/m	dB	dB/m		
1 PP 3496.000	-39.49	-46.80	-13.00	-26.49	7.31	Peak	Vertical
2 5262.900	-49.67	-60.18	-13.00	-36.67	10.51	Peak	Vertical

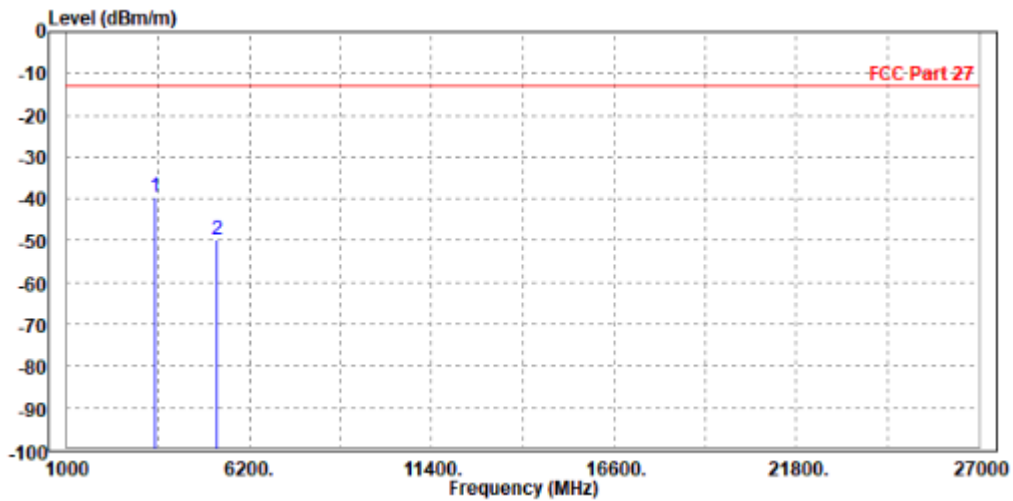



BUREAU VERITAS

Test Report No.: W7L-P22080014RF03

CHANNEL BANDWIDTH: 3MHz / QPSK

MODE	TX channel 20175	FREQUENCY RANGE	Above 1000MHz
ENVIRONMENTAL CONDITIONS	23deg. C, 70%RH	INPUT POWER	DC30V
TESTED BY	Jace Hu		
ANTENNA POLARITY & TEST DISTANCE: HORIZONTAL AT 3 M			

	Freq	Level	Read Level	Limit Line	Over Limit	Factor	Remark	Pol/Phase
	MHz	dBm/m	dBm	dBm/m	dB	dB/m		
1	PP 3470.000	-36.02	-43.30	-13.00	-23.02	7.28	Peak	Horizontal
2	5197.500	-51.61	-61.61	-13.00	-38.61	10.00	Peak	Horizontal

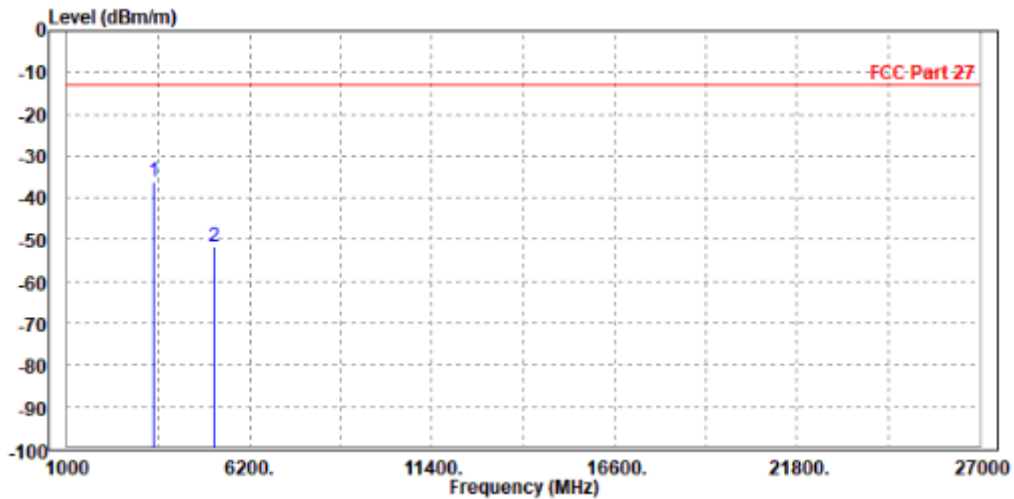



Test Report No.: W7L-P22080014RF03

MODE	TX channel 20175	FREQUENCY RANGE	Above 1000MHz
ENVIRONMENTAL CONDITIONS	23deg. C, 70%RH	INPUT POWER	DC30V
TESTED BY	Jace Hu		
ANTENNA POLARITY & TEST DISTANCE: VERTICAL AT 3 M			

	Freq	Level	Read Level	Limit Line	Over Limit	Factor	Remark	Pol/Phase
	MHz	dBm/m	dBm	dBm/m	dB	dB/m		
1	PP 3465.000	-39.67	-46.93	-13.00	-26.67	7.26	Peak	Vertical
2	5186.000	-50.27	-60.71	-13.00	-37.27	10.44	Peak	Vertical

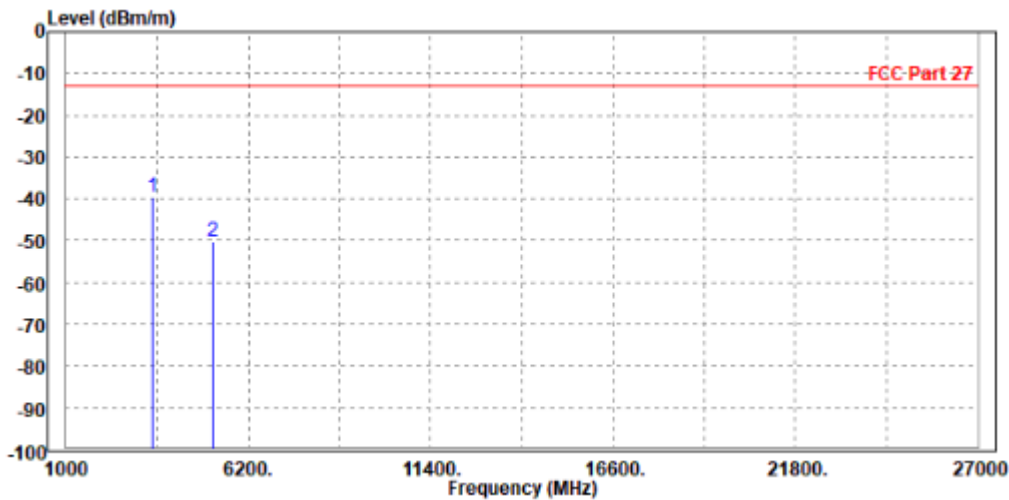



**BUREAU
VERITAS**

Test Report No.: W7L-P22080014RF03

CHANNEL BANDWIDTH: 5MHz / QPSK

MODE	TX channel 20175	FREQUENCY RANGE	Above 1000MHz
ENVIRONMENTAL CONDITIONS	23deg. C, 70%RH	INPUT POWER	DC30V
TESTED BY	Jace Hu		
ANTENNA POLARITY & TEST DISTANCE: HORIZONTAL AT 3 M			

	Freq	Level	Read Level	Limit Line	Over Limit	Factor	Remark	Pol/Phase
	MHz	dBm/m	dBm	dBm/m	dB	dB/m		
1	PP 3465.000	-44.35	-51.62	-13.00	-31.35	7.27	Peak	Horizontal
2	5186.000	-51.19	-61.17	-13.00	-38.19	9.98	Peak	Horizontal

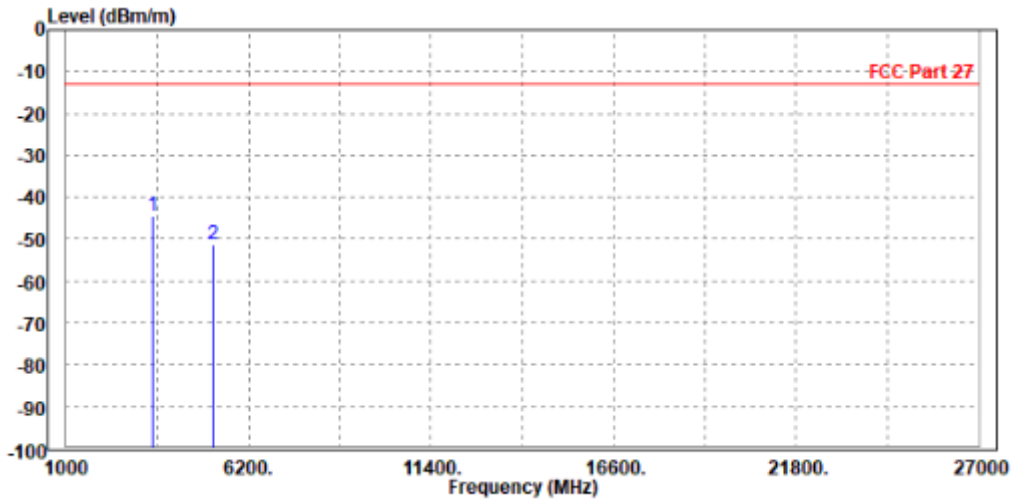



Test Report No.: W7L-P22080014RF03

MODE	TX channel 20175	FREQUENCY RANGE	Above 1000MHz
ENVIRONMENTAL CONDITIONS	23deg. C, 70%RH	INPUT POWER	DC30V
TESTED BY	Jace Hu		
ANTENNA POLARITY & TEST DISTANCE: VERTICAL AT 3 M			

	Freq	Level	Read Level	Limit Line	Over Limit	Factor	Remark	Pol/Phase
	MHz	dBm/m	dBm	dBm/m	dB	dB/m		
1	PP 3470.000	-36.77	-44.04	-13.00	-23.77	7.27	Peak	Vertical
2	5197.500	-50.94	-61.39	-13.00	-37.94	10.45	Peak	Vertical

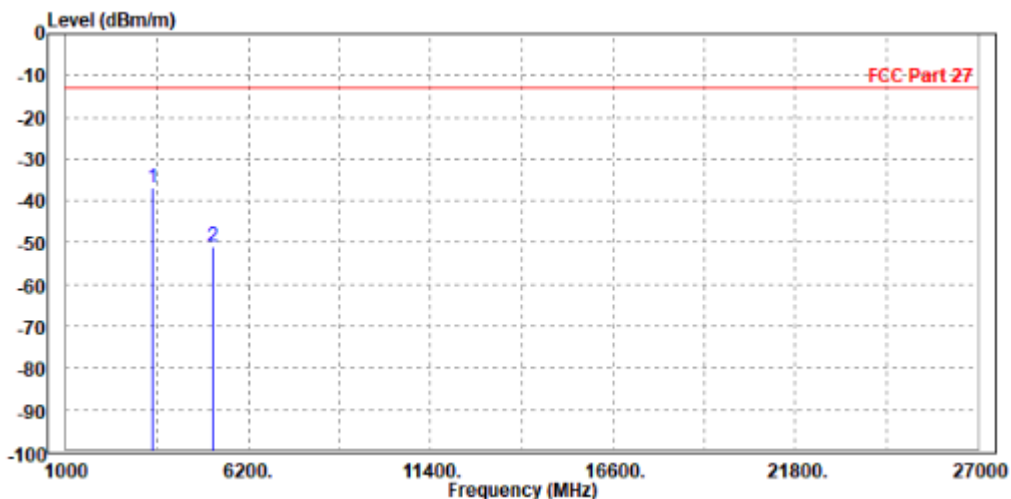



**BUREAU
VERITAS**

Test Report No.: W7L-P22080014RF03

CHANNEL BANDWIDTH: 10MHz / QPSK

MODE	TX channel 20175	FREQUENCY RANGE	Above 1000MHz
ENVIRONMENTAL CONDITIONS	23deg. C, 70%RH	INPUT POWER	DC30V
TESTED BY	Jace Hu		
ANTENNA POLARITY & TEST DISTANCE: HORIZONTAL AT 3 M			

	Freq	Level	Read Level	Limit Line	Over Limit	Factor	Remark	Pol/Phase
	MHz	dBm/m	dBm	dBm/m	dB	dB/m		
1	PP 3465.000	-43.92	-51.19	-13.00	-30.92	7.27	Peak	Horizontal
2	5186.000	-51.83	-61.81	-13.00	-38.83	9.98	Peak	Horizontal

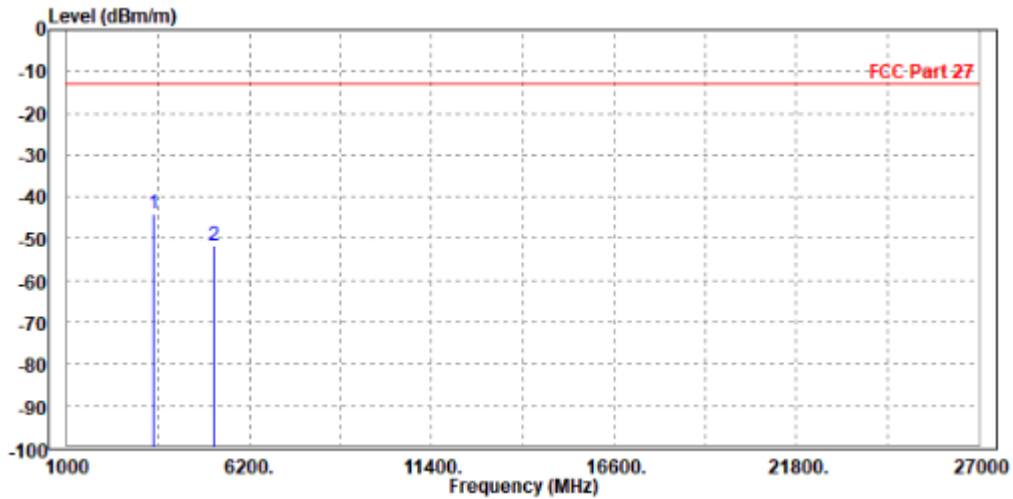



Test Report No.: W7L-P22080014RF03

MODE	TX channel 20175	FREQUENCY RANGE	Above 1000MHz
ENVIRONMENTAL CONDITIONS	23deg. C, 70%RH	INPUT POWER	DC30V
TESTED BY	Jace Hu		
ANTENNA POLARITY & TEST DISTANCE: VERTICAL AT 3 M			

	Freq	Level	Read Level	Limit Line	Over Limit	Factor	Remark	Pol/Phase
	MHz	dBm/m	dBm	dBm/m	dB	dB/m		
1	PP 3470.000	-38.09	-45.36	-13.00	-25.09	7.27	Peak	Vertical
2	5197.500	-50.46	-60.91	-13.00	-37.46	10.45	Peak	Vertical

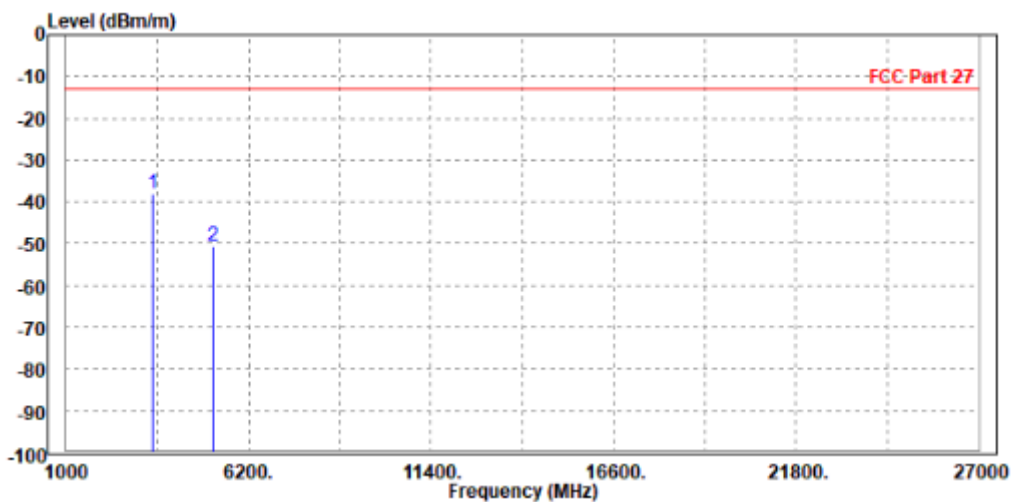



BUREAU VERITAS

Test Report No.: W7L-P22080014RF03

CHANNEL BANDWIDTH: 15MHz / QPSK

MODE	TX channel 20175	FREQUENCY RANGE	Above 1000MHz
ENVIRONMENTAL CONDITIONS	23deg. C, 70%RH	INPUT POWER	DC30V
TESTED BY	Jace Hu		
ANTENNA POLARITY & TEST DISTANCE: HORIZONTAL AT 3 M			

	Freq	Level	Read Level	Limit Line	Over Limit	Factor	Remark	Pol/Phase
	MHz	dBm/m	dBm	dBm/m	dB	dB/m		
1	PP 3470.000	-40.95	-48.23	-13.00	-27.95	7.28	Peak	Horizontal
2	5197.500	-52.08	-62.08	-13.00	-39.08	10.00	Peak	Horizontal

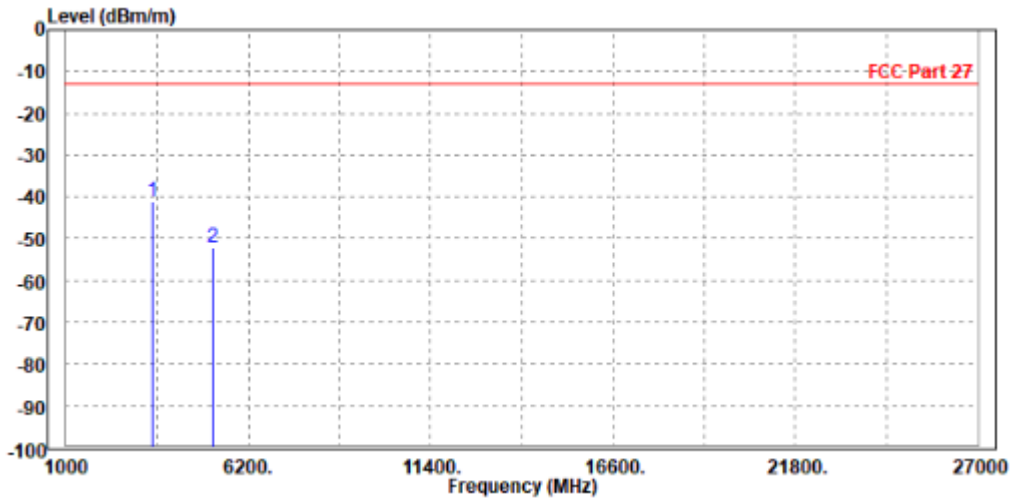



Test Report No.: W7L-P22080014RF03

MODE	TX channel 20175	FREQUENCY RANGE	Above 1000MHz
ENVIRONMENTAL CONDITIONS	23deg. C, 70%RH	INPUT POWER	DC30V
TESTED BY	Jace Hu		
ANTENNA POLARITY & TEST DISTANCE: VERTICAL AT 3 M			

	Freq	Level	Read Level	Limit Line	Over Limit	Factor	Remark	Pol/Phase
	MHz	dBm/m	dBm	dBm/m	dB	dB/m		
1	PP 3465.000	-42.86	-50.12	-13.00	-29.86	7.26	Peak	Vertical
2	5186.000	-50.72	-61.16	-13.00	-37.72	10.44	Peak	Vertical

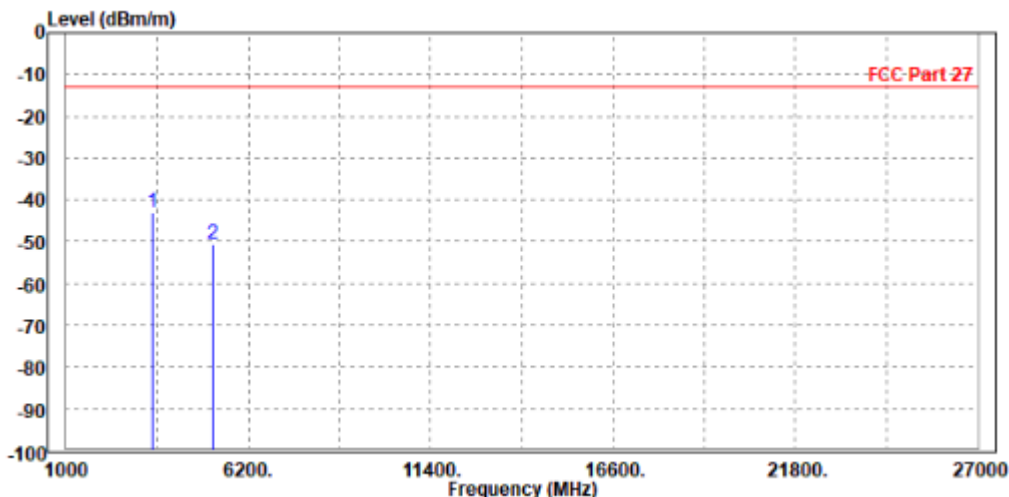



**BUREAU
VERITAS**

Test Report No.: W7L-P22080014RF03

CHANNEL BANDWIDTH: 20MHz / QPSK

MODE	TX channel 20175	FREQUENCY RANGE	Above 1000MHz
ENVIRONMENTAL CONDITIONS	23deg. C, 70%RH	INPUT POWER	DC30V
TESTED BY	Jace Hu		
ANTENNA POLARITY & TEST DISTANCE: HORIZONTAL AT 3 M			

	Freq	Level	Read Level	Limit Line	Over Limit	Factor	Remark	Pol/Phase
	MHz	dBm/m	dBm	dBm/m	dB	dB/m		
1	PP 3465.000	-39.36	-46.63	-13.00	-26.36	7.27	Peak	Horizontal
2	5186.000	-50.93	-60.91	-13.00	-37.93	9.98	Peak	Horizontal

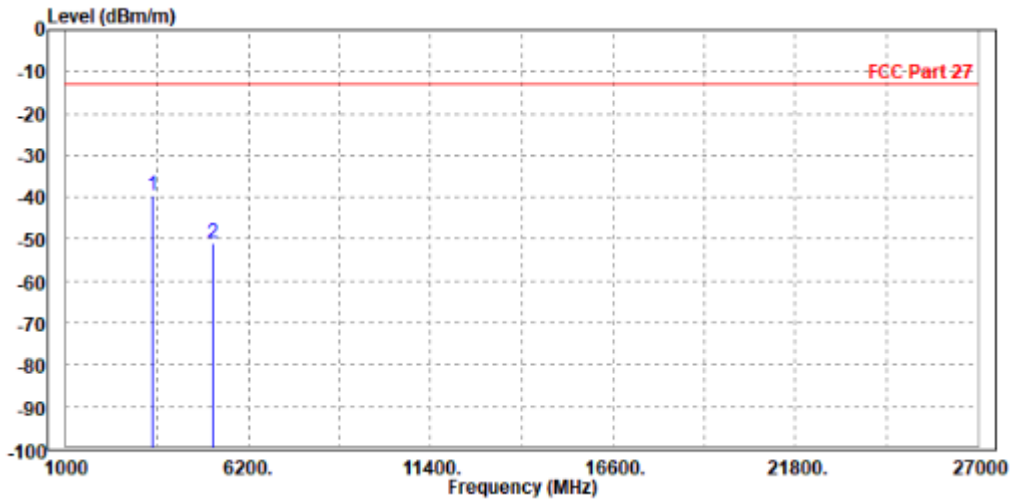



Test Report No.: W7L-P22080014RF03

MODE	TX channel 20175	FREQUENCY RANGE	Above 1000MHz
ENVIRONMENTAL CONDITIONS	23deg. C, 70%RH	INPUT POWER	DC30V
TESTED BY	Jace Hu		
ANTENNA POLARITY & TEST DISTANCE: VERTICAL AT 3 M			

	Freq	Level	Read Level	Limit Line	Over Limit	Factor	Remark	Pol/Phase
	MHz	dBm/m	dBm	dBm/m	dB	dB/m		
1	PP 3470.000	-36.98	-44.25	-13.00	-23.98	7.27	Peak	Vertical
2	5197.500	-51.11	-61.56	-13.00	-38.11	10.45	Peak	Vertical

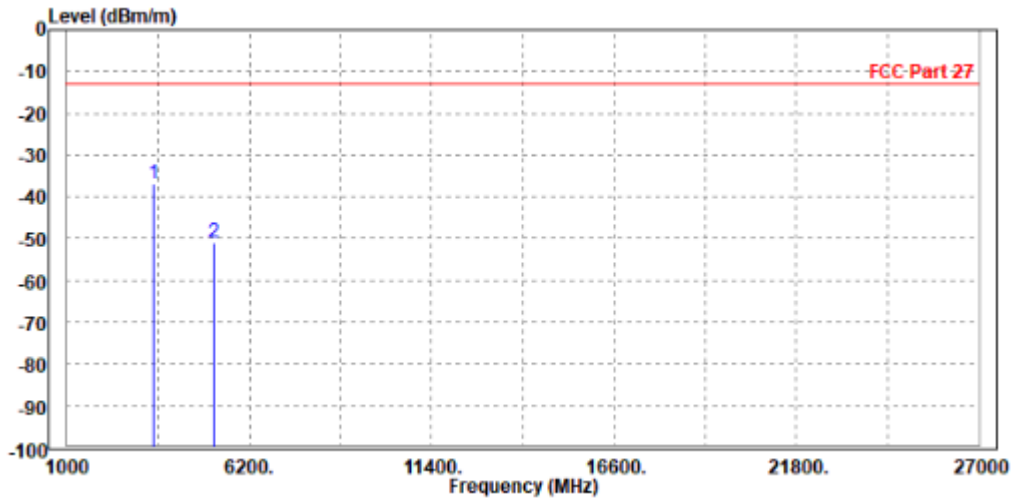



Test Report No.: W7L-P22080014RF03

LTE BAND 12

CHANNEL BANDWIDTH: 1.4MHz / QPSK

MODE	TX channel 23095	FREQUENCY RANGE	Above 1000MHz
ENVIRONMENTAL CONDITIONS	23deg. C, 70%RH	INPUT POWER	DC30V
TESTED BY	Jace Hu		
ANTENNA POLARITY & TEST DISTANCE: HORIZONTAL AT 3 M			

	Freq	Level	Read Level	Limit Line	Over Limit	Factor	Remark	Pol/Phase
	MHz	dBm/m	dBm	dBm/m	dB	dB/m		
1 PP	1415.000	-27.86	-27.21	-13.00	-14.86	-0.65	Peak	Horizontal
2	2118.000	-42.17	-46.22	-13.00	-29.17	4.05	Peak	Horizontal

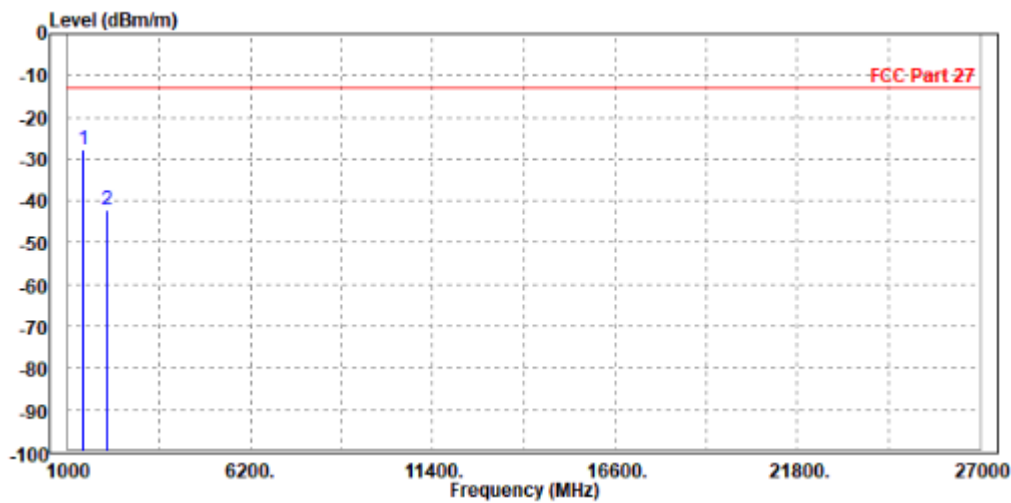



Test Report No.: W7L-P22080014RF03

MODE	TX channel 23095	FREQUENCY RANGE	Above 1000MHz
ENVIRONMENTAL CONDITIONS	23deg. C, 70%RH	INPUT POWER	DC30V
TESTED BY	Jace Hu		
ANTENNA POLARITY & TEST DISTANCE: VERTICAL AT 3 M			

	Freq	Level	Read Level	Limit Line	Over Limit	Factor	Remark	Pol/Phase
	MHz	dBm/m	dBm	dBm/m	dB	dB/m		
1	PP 1416.000	-26.27	-25.87	-13.00	-13.27	-0.40	Peak	Vertical
2	2122.500	-37.46	-41.38	-13.00	-24.46	3.92	Peak	Vertical

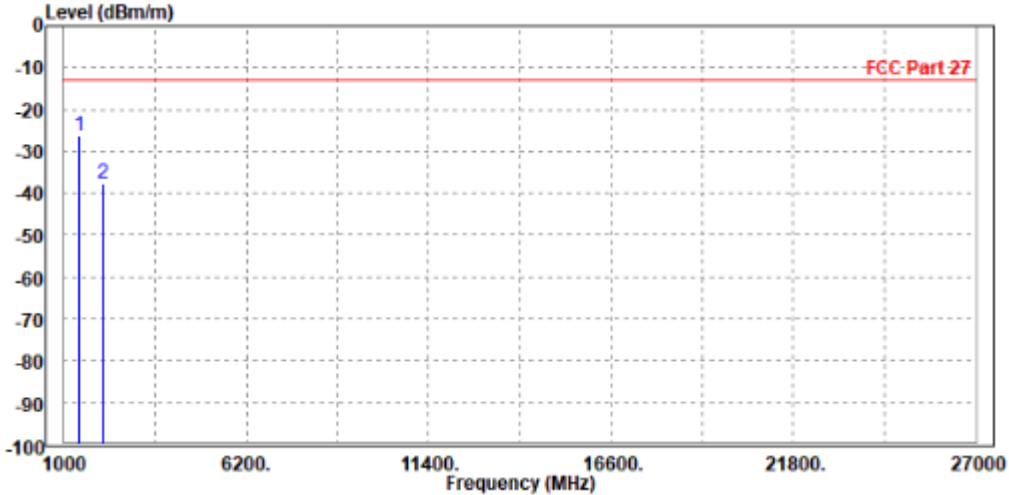



**BUREAU
VERITAS**

Test Report No.: W7L-P22080014RF03

CHANNEL BANDWIDTH: 3MHz / QPSK

CH23025

MODE	TX channel 23025	FREQUENCY RANGE	Above 1000MHz
ENVIRONMENTAL CONDITIONS	23deg. C, 70%RH	INPUT POWER	DC30V
TESTED BY	Jace Hu		
ANTENNA POLARITY & TEST DISTANCE: HORIZONTAL AT 3 M			

	Freq	Level	Read Level	Limit Line	Over Limit	Factor	Remark	Pol/Phase
	MHz	dBm/m	dBm	dBm/m	dB	dB/m		
1	PP 1390.000	-32.64	-31.93	-13.00	-19.64	-0.71	Peak	Horizontal
2	2092.000	-43.93	-47.88	-13.00	-30.93	3.95	Peak	Horizontal

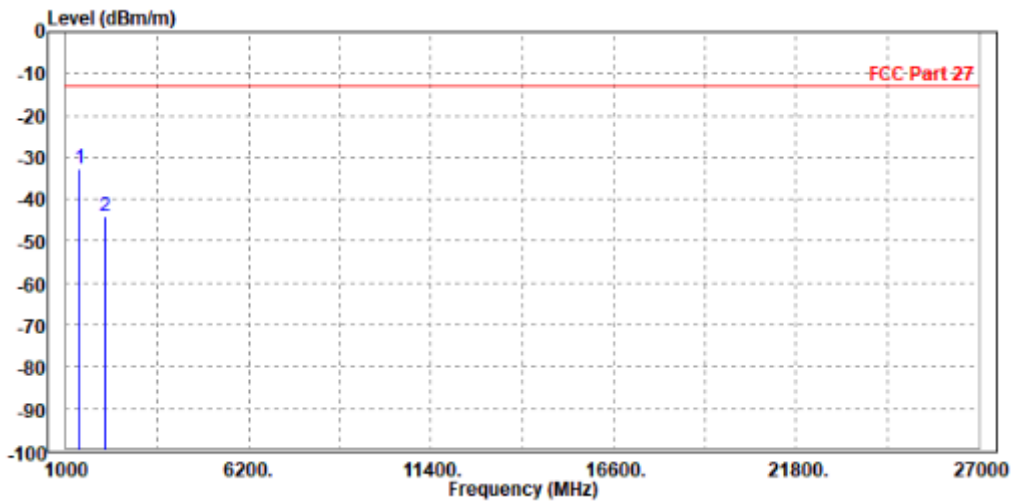



Test Report No.: W7L-P22080014RF03

MODE	TX channel 23025	FREQUENCY RANGE	Above 1000MHz
ENVIRONMENTAL CONDITIONS	23deg. C, 70%RH	INPUT POWER	DC30V
TESTED BY	Jace Hu		
ANTENNA POLARITY & TEST DISTANCE: VERTICAL AT 3 M			

	Freq	Level	Read Level	Limit Line	Over Limit	Factor	Remark	Pol/Phase
	MHz	dBm/m	dBm	dBm/m	dB	dB/m		
1	PP 1390.000	-35.13	-34.61	-13.00	-22.13	-0.52	Peak	Vertical
2	2101.500	-55.54	-59.40	-13.00	-42.54	3.86	Peak	Vertical

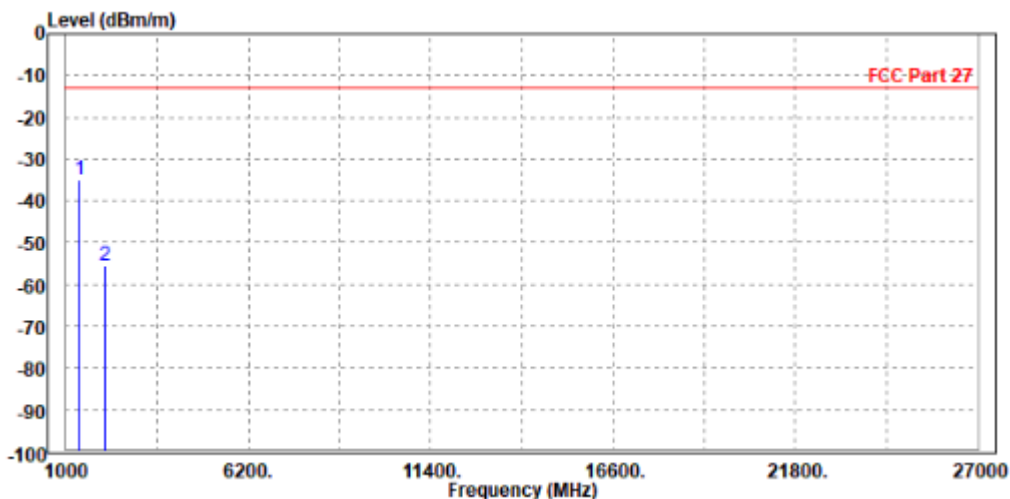



Test Report No.: W7L-P22080014RF03

CH23095

MODE	TX channel 23095	FREQUENCY RANGE	Above 1000MHz
ENVIRONMENTAL CONDITIONS	23deg. C, 70%RH	INPUT POWER	DC30V
TESTED BY	Jace Hu		
ANTENNA POLARITY & TEST DISTANCE: HORIZONTAL AT 3 M			

	Freq	Level	Read Level	Limit Line	Over Limit	Factor	Remark	Pol/Phase
	MHz	dBm/m	dBm	dBm/m	dB	dB/m		
1	PP 1416.000	-24.19	-23.55	-13.00	-11.19	-0.64	Peak	Horizontal
2	2122.500	-41.09	-45.15	-13.00	-28.09	4.06	Peak	Horizontal

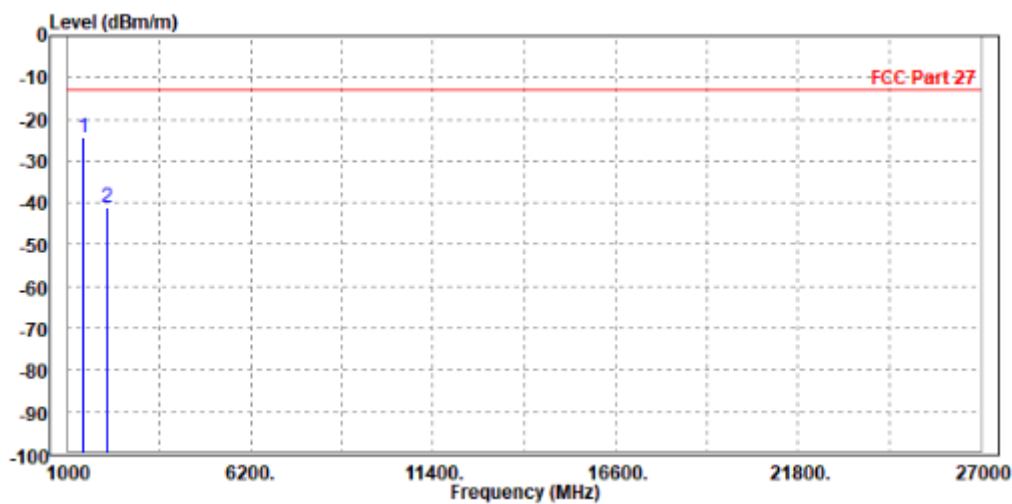



Test Report No.: W7L-P22080014RF03

MODE	TX channel 23095	FREQUENCY RANGE	Above 1000MHz
ENVIRONMENTAL CONDITIONS	23deg. C, 70%RH	INPUT POWER	DC30V
TESTED BY	Jace Hu		
ANTENNA POLARITY & TEST DISTANCE: VERTICAL AT 3 M			

	Freq	Level	Read Level	Limit Line	Over Limit	Factor	Remark	Pol/Phase
	MHz	dBm/m	dBm	dBm/m	dB	dB/m		
1	PP 1415.000	-23.10	-22.69	-13.00	-10.10	-0.41	Peak	Vertical
2	2118.000	-38.79	-42.69	-13.00	-25.79	3.90	Peak	Vertical

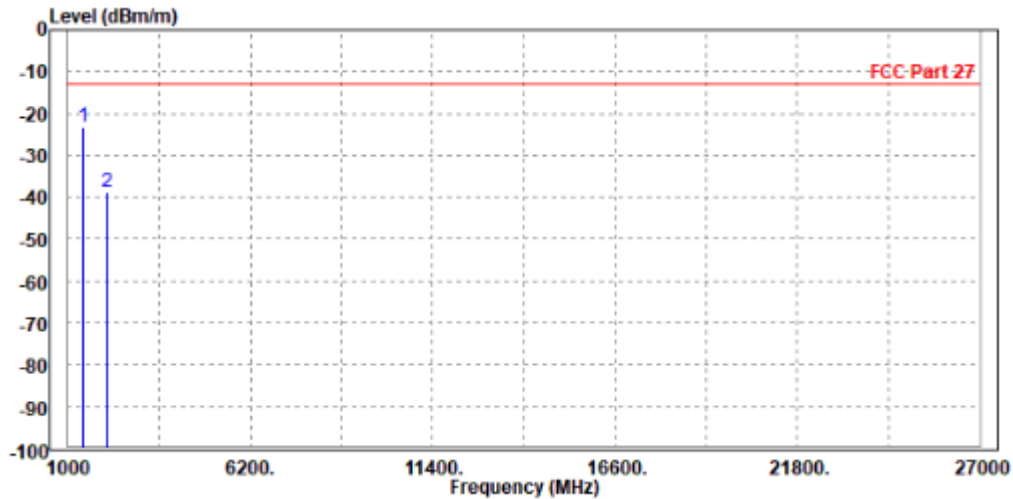



Test Report No.: W7L-P22080014RF03

CH23165

MODE	TX channel 23165	FREQUENCY RANGE	Above 1000MHz
ENVIRONMENTAL CONDITIONS	23deg. C, 70%RH	INPUT POWER	DC30V
TESTED BY	Jace Hu		
ANTENNA POLARITY & TEST DISTANCE: HORIZONTAL AT 3 M			

	Freq	Level	Read Level	Limit Line	Over Limit	Factor	Remark	Pol/Phase
	MHz	dBm/m	dBm	dBm/m	dB	dB/m		
1	PP 1416.000	-25.24	-24.60	-13.00	-12.24	-0.64	Peak	Horizontal
2	2144.000	-32.46	-36.60	-13.00	-19.46	4.14	Peak	Horizontal

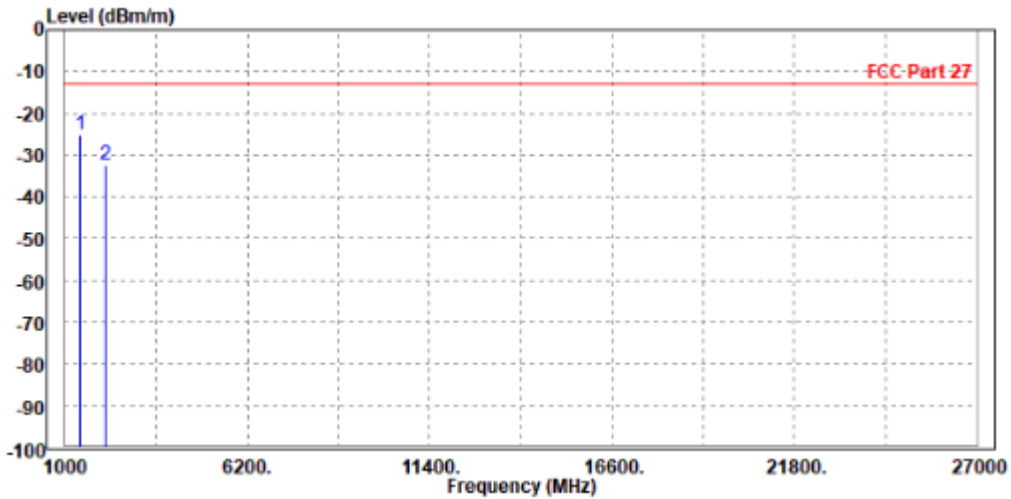



Test Report No.: W7L-P22080014RF03

MODE	TX channel 23165	FREQUENCY RANGE	Above 1000MHz
ENVIRONMENTAL CONDITIONS	23deg. C, 70%RH	INPUT POWER	DC30V
TESTED BY	Jace Hu		
ANTENNA POLARITY & TEST DISTANCE: VERTICAL AT 3 M			

	Read	Limit	Over			
Freq	Level	Level	Line	Limit	Factor	Remark
MHz	dBm/m	dBm	dBm/m	dB	dB/m	Pol/Phase
1 PP 1416.000	-32.47	-32.07	-13.00	-19.47	-0.40	Peak Vertical
2 2144.000	-40.57	-44.54	-13.00	-27.57	3.97	Peak Vertical





Test Report No.: W7L-P22080014RF03

CHANNEL BANDWIDTH: 5MHz / QPSK

MODE	TX channel 23095	FREQUENCY RANGE	Above 1000MHz
ENVIRONMENTAL CONDITIONS	23deg. C, 70%RH	INPUT POWER	DC30V
TESTED BY	Jace Hu		
ANTENNA POLARITY & TEST DISTANCE: HORIZONTAL AT 3 M			

	Freq	Level	Read Level	Limit Line	Over Limit	Factor	Remark	Pol/Phase
	MHz	dBm/m	dBm	dBm/m	dB	dB/m		
1	PP 1415.000	-26.11	-25.46	-13.00	-13.11	-0.65	Peak	Horizontal
2	2118.000	-42.04	-46.09	-13.00	-29.04	4.05	Peak	Horizontal

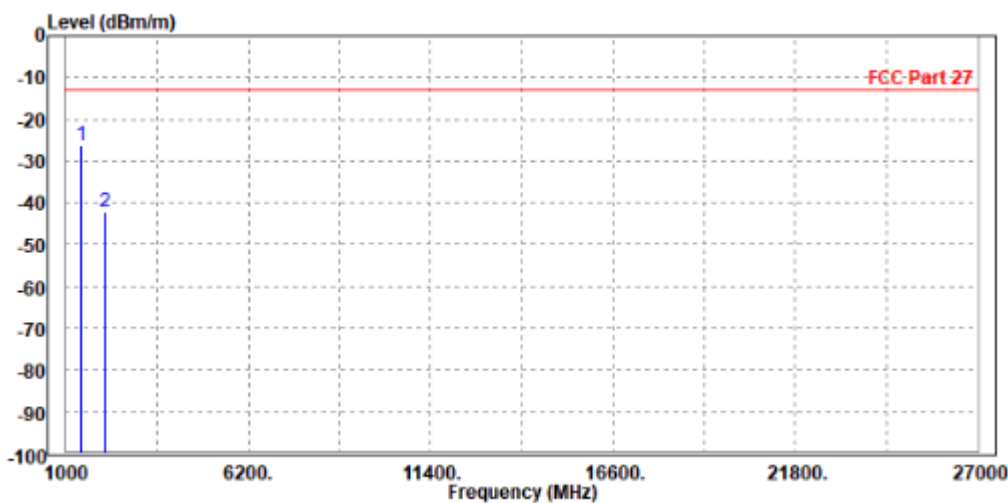



Test Report No.: W7L-P22080014RF03

MODE	TX channel 23095	FREQUENCY RANGE	Above 1000MHz
ENVIRONMENTAL CONDITIONS	23deg. C, 70%RH	INPUT POWER	DC30V
TESTED BY	Jace Hu		
ANTENNA POLARITY & TEST DISTANCE: VERTICAL AT 3 M			

	Freq	Level	Read Level	Limit Line	Over Limit	Factor	Remark	Pol/Phase
	MHz	dBm/m	dBm	dBm/m	dB	dB/m		
1	PP 1416.000	-23.94	-23.54	-13.00	-10.94	-0.40	Peak	Vertical
2	2122.500	-36.03	-39.95	-13.00	-23.03	3.92	Peak	Vertical

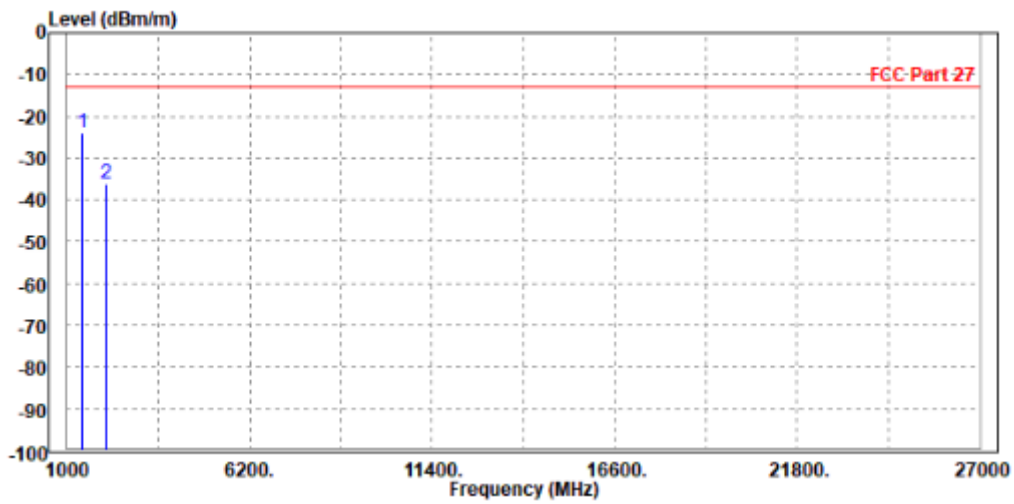



Test Report No.: W7L-P22080014RF03

CHANNEL BANDWIDTH: 10MHz / QPSK

MODE	TX channel 23095	FREQUENCY RANGE	Above 1000MHz
ENVIRONMENTAL CONDITIONS	23deg. C, 70%RH	INPUT POWER	DC30V
TESTED BY	Jace Hu		
ANTENNA POLARITY & TEST DISTANCE: HORIZONTAL AT 3 M			

	Freq	Level	Read Level	Limit Line	Over Limit	Factor	Remark	Pol/Phase
	MHz	dBm/m	dBm	dBm/m	dB	dB/m		
1	PP 1415.000	-28.14	-27.49	-13.00	-15.14	-0.65	Peak	Horizontal
2	2118.000	-46.52	-50.57	-13.00	-33.52	4.05	Peak	Horizontal

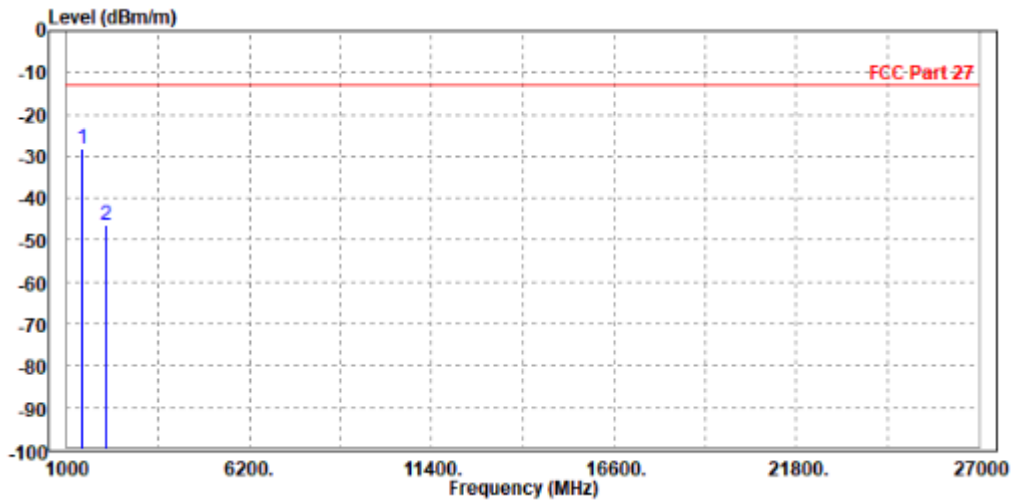



Test Report No.: W7L-P22080014RF03

MODE	TX channel 23095	FREQUENCY RANGE	Above 1000MHz
ENVIRONMENTAL CONDITIONS	23deg. C, 70%RH	INPUT POWER	DC30V
TESTED BY	Jace Hu		
ANTENNA POLARITY & TEST DISTANCE: VERTICAL AT 3 M			

	Freq	Level	Read Level	Limit Line	Over Limit	Factor	Remark	Pol/Phase
	MHz	dBm/m	dBm	dBm/m	dB	dB/m		
1	PP 1416.000	-23.76	-23.36	-13.00	-10.76	-0.40	Peak	Vertical
2	2122.500	-39.52	-43.44	-13.00	-26.52	3.92	Peak	Vertical

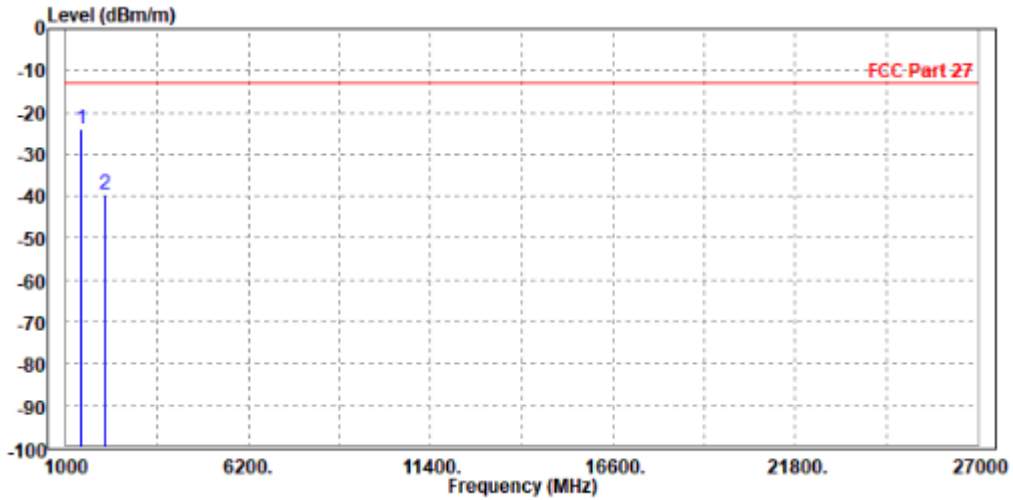



Test Report No.: W7L-P22080014RF03

LTE B13

CHANNEL BANDWIDTH: 5MHz / QPSK

CH23205

MODE	TX channel 23205	FREQUENCY RANGE	Above 1000MHz
ENVIRONMENTAL CONDITIONS	23deg. C, 70%RH	INPUT POWER	DC30V
TESTED BY	Jace Hu		
ANTENNA POLARITY & TEST DISTANCE: HORIZONTAL AT 3 M			

	Freq	Level	Read Level	Limit Line	Over Limit	Factor	Remark	Pol/Phase
	MHz	dBm/m	dBm	dBm/m	dB	dB/m		
1	PP 1572.000	-57.05	-57.21	-40.00	-17.05	0.16	Peak	Horizontal
2	2338.500	-47.93	-52.78	-13.00	-34.93	4.85	Peak	Horizontal

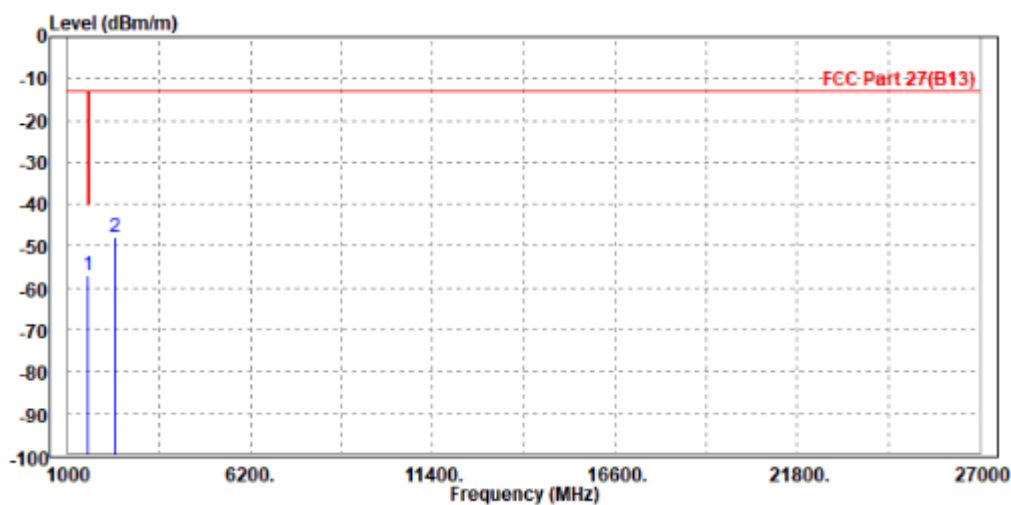



Test Report No.: W7L-P22080014RF03

MODE	TX channel 23205	FREQUENCY RANGE	Above 1000MHz
ENVIRONMENTAL CONDITIONS	23deg. C, 70%RH	INPUT POWER	DC30V
TESTED BY	Jace Hu		
ANTENNA POLARITY & TEST DISTANCE: VERTICAL AT 3 M			

	Freq	Level	Read Level	Limit Line	Over Limit	Factor	Remark	Pol/Phase
	MHz	dBm/m	dBm	dBm/m	dB	dB/m		
1	PP 1559.000	-56.82	-57.21	-40.00	-16.82	0.39	Peak	Vertical
2	2326.000	-45.91	-50.38	-13.00	-32.91	4.47	Peak	Vertical

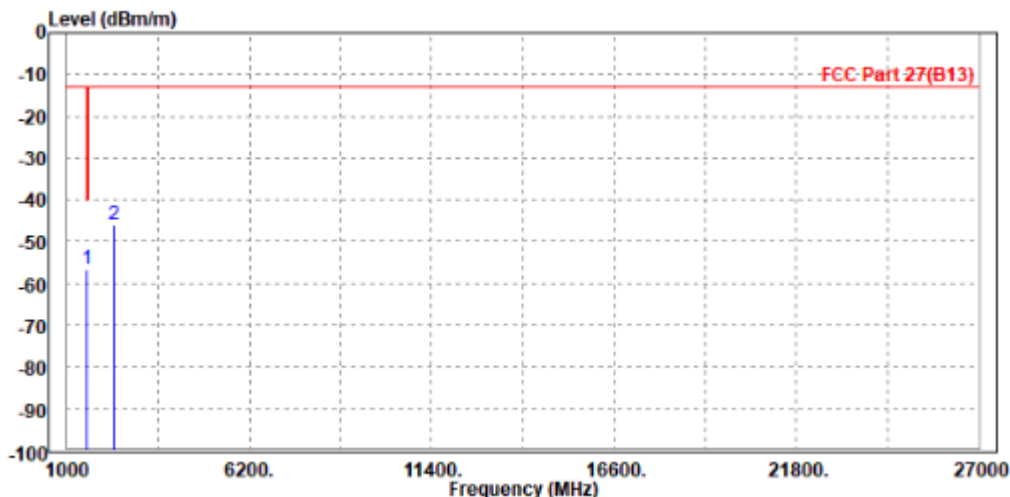



Test Report No.: W7L-P22080014RF03

CH23230

MODE	TX channel 23230	FREQUENCY RANGE	Above 1000MHz
ENVIRONMENTAL CONDITIONS	23deg. C, 70%RH	INPUT POWER	DC30V
TESTED BY	Jace Hu		
ANTENNA POLARITY & TEST DISTANCE: HORIZONTAL AT 3 M			

	Freq	Level	Read Level	Limit	Over Limit	Factor	Remark	Pol/Phase
	MHz	dBm/m	dBm	dBm/m	dB	dB/m		
1	PP 1564.000	-54.67	-54.77	-40.00	-14.67	0.10	Peak	Horizontal
2	2352.000	-48.94	-53.84	-13.00	-35.94	4.90	Peak	Horizontal

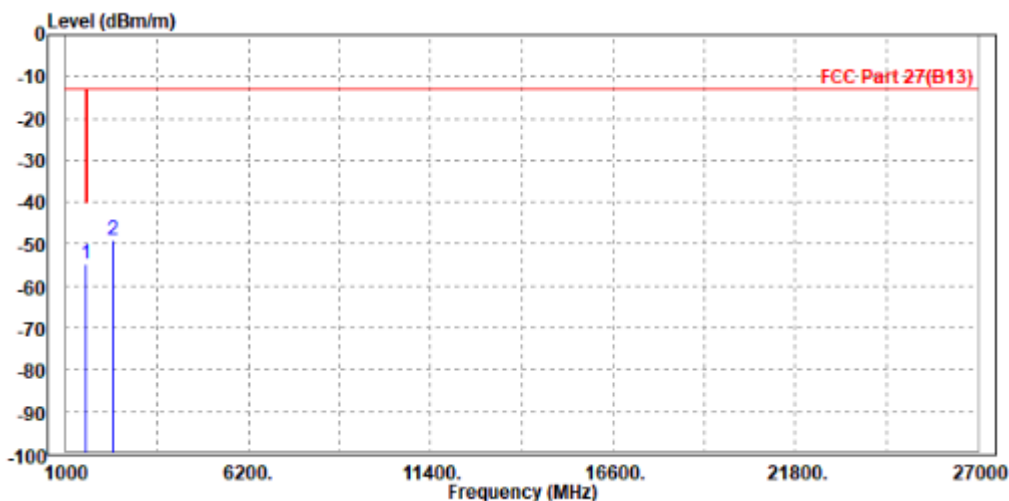



Test Report No.: W7L-P22080014RF03

MODE	TX channel 23230	FREQUENCY RANGE	Above 1000MHz
ENVIRONMENTAL CONDITIONS	23deg. C, 70%RH	INPUT POWER	DC30V
TESTED BY	Jace Hu		
ANTENNA POLARITY & TEST DISTANCE: VERTICAL AT 3 M			

	Read	Limit	Over			
Freq	Level	Level	Line	Limit	Factor	Remark
MHz	dBm/m	dBm	dBm/m	dB	dB/m	
1 PP 1572.000	-54.35	-54.84	-40.00	-14.35	0.49	Peak Vertical
2 2346.000	-49.30	-53.82	-13.00	-36.30	4.52	Peak Vertical

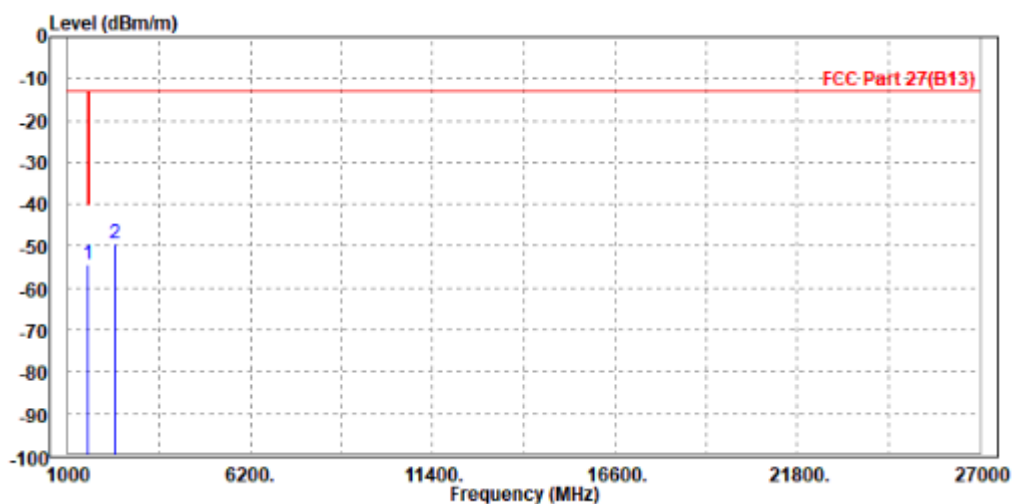



Test Report No.: W7L-P22080014RF03

CH23255

MODE	TX channel 23255	FREQUENCY RANGE	Above 1000MHz
ENVIRONMENTAL CONDITIONS	23deg. C, 70%RH	INPUT POWER	DC30V
TESTED BY	Jace Hu		
ANTENNA POLARITY & TEST DISTANCE: HORIZONTAL AT 3 M			

	Freq	Level	Read Level	Limit	Over Limit	Factor	Remark	Pol/Phase
	MHz	dBm/m	dBm	dBm/m	dB	dB/m		
1	PP 1572.000	-58.95	-59.11	-40.00	-18.95	0.16	Peak	Horizontal
2	2353.500	-54.06	-58.97	-13.00	-41.06	4.91	Peak	Horizontal

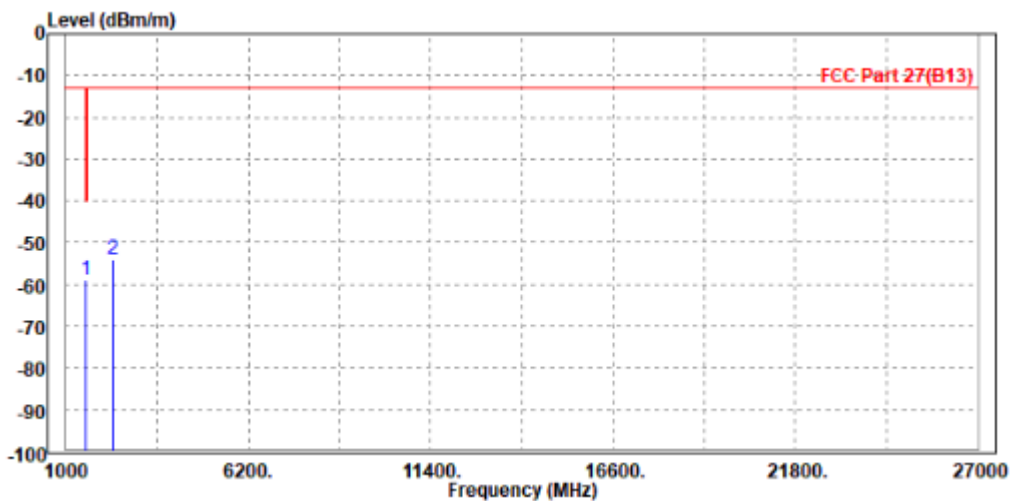



Test Report No.: W7L-P22080014RF03

MODE	TX channel 23255	FREQUENCY RANGE	Above 1000MHz
ENVIRONMENTAL CONDITIONS	23deg. C, 70%RH	INPUT POWER	DC30V
TESTED BY	Jace Hu		
ANTENNA POLARITY & TEST DISTANCE: VERTICAL AT 3 M			

	Freq	Level	Read Level	Limit Line	Over Limit	Factor	Remark	Pol/Phase
	MHz	dBm/m	dBm	dBm/m	dB	dB/m		
1	PP 1572.000	-58.30	-58.79	-40.00	-18.30	0.49	Peak	Vertical
2	2353.500	-45.66	-50.20	-13.00	-32.66	4.54	Peak	Vertical

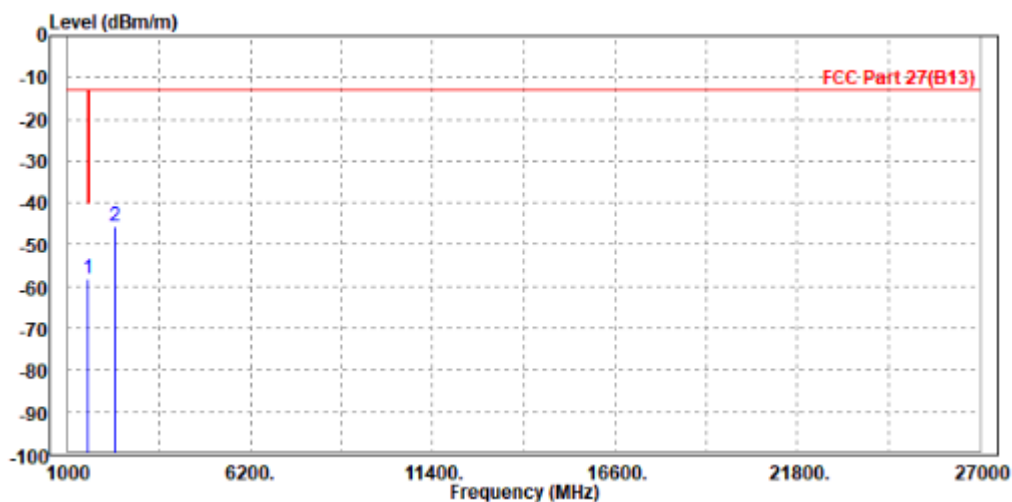



Test Report No.: W7L-P22080014RF03

CHANNEL BANDWIDTH: 10MHz /QPSK

CH23230

MODE	TX channel 23230	FREQUENCY RANGE	Above 1000MHz
ENVIRONMENTAL CONDITIONS	23deg. C, 70%RH	INPUT POWER	DC30V
TESTED BY	Jace Hu		
ANTENNA POLARITY & TEST DISTANCE: HORIZONTAL AT 3 M			

	Freq	Level	Read Level	Limit Line	Over Limit	Factor	Remark	Pol/Phase
	MHz	dBm/m	dBm	dBm/m	dB	dB/m		
1	PP 1572.000	-58.53	-58.69	-40.00	-18.53	0.16	Peak	Horizontal
2	2346.000	-52.51	-57.39	-13.00	-39.51	4.88	Peak	Horizontal

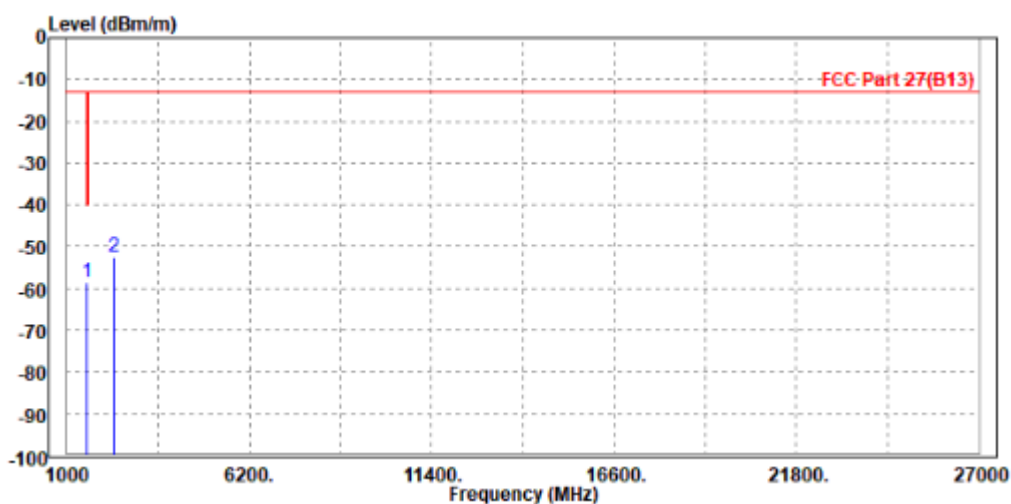



Test Report No.: W7L-P22080014RF03

MODE	TX channel 23230	FREQUENCY RANGE	Above 1000MHz
ENVIRONMENTAL CONDITIONS	23deg. C, 70%RH	INPUT POWER	DC30V
TESTED BY	Jace Hu		
ANTENNA POLARITY & TEST DISTANCE: VERTICAL AT 3 M			

	Freq	Level	Read Level	Limit Line	Over Limit	Factor	Remark	Pol/Phase
	MHz	dBm/m	dBm	dBm/m	dB	dB/m		
1	PP 1564.000	-57.74	-58.17	-40.00	-17.74	0.43	Peak	Vertical
2	2352.000	-44.79	-49.33	-13.00	-31.79	4.54	Peak	Vertical

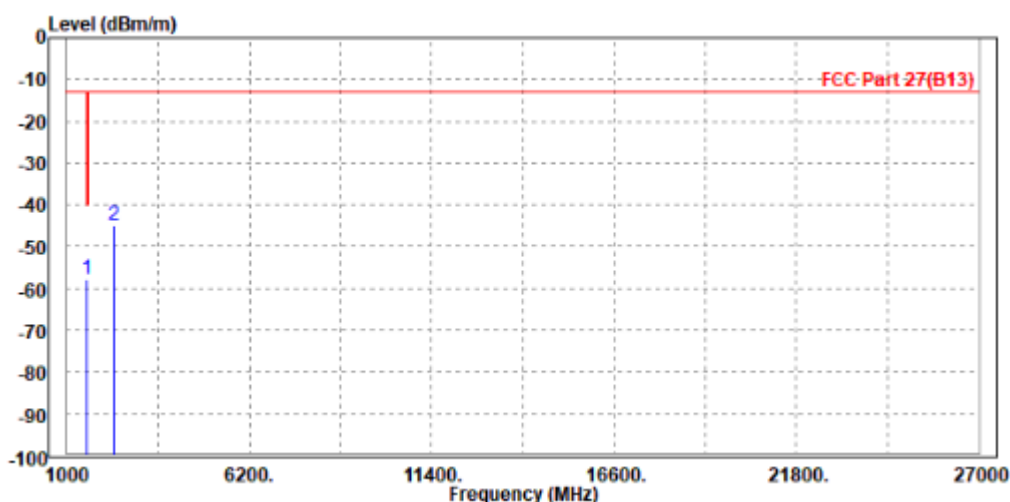



**BUREAU
VERITAS**

Test Report No.: W7L-P22080014RF03

BELOW 1GHz WORST-CASE DATA 2(Without antenna)

30 MHz – 1GHz data:

LTE Band 13

CHANNEL BANDWIDTH: 5MHz / QPSK

MODE	TX channel 23255	FREQUENCY RANGE	Below 1000MHz
ENVIRONMENTAL CONDITIONS	23deg. C, 70%RH	INPUT POWER	DC30V
TESTED BY	Jace Hu		
ANTENNA POLARITY & TEST DISTANCE: HORIZONTAL AT 3 M			

	Freq	Level	Read Level	Limit	Over Limit	Factor	Remark	Pol/Phase
	MHz	dBm/m	dBm	dBm/m	dB	dB/m		
1 PP	62.980	-50.99	-31.51	-13.00	-37.99	-19.48	Peak	Horizontal
2	138.640	-56.81	-37.24	-13.00	-43.81	-19.57	Peak	Horizontal
3	244.370	-52.73	-40.61	-13.00	-39.73	-12.12	Peak	Horizontal
4	350.100	-56.13	-44.89	-13.00	-43.13	-11.24	Peak	Horizontal
5	489.780	-53.26	-44.83	-13.00	-40.26	-8.43	Peak	Horizontal
6	552.830	-51.85	-45.82	-13.00	-38.85	-6.03	Peak	Horizontal

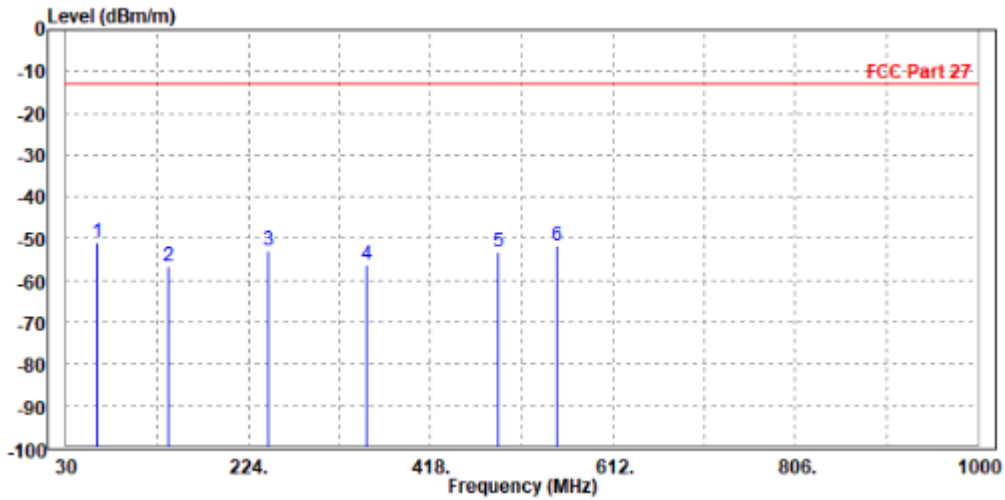



Test Report No.: W7L-P22080014RF03

MODE	TX channel 23255	FREQUENCY RANGE	Below 1000MHz
ENVIRONMENTAL CONDITIONS	23deg. C, 70%RH	INPUT POWER	DC30V
TESTED BY	Jace Hu		
ANTENNA POLARITY & TEST DISTANCE: VERTICAL AT 3 M			

	Freq	Level	Read Level	Limit Line	Over Limit	Factor	Remark	Pol/Phase
	MHz	dBm/m	dBm	dBm/m	dB	dB/m		
1	62.010	-46.63	-23.64	-13.00	-33.63	-22.99	Peak	Vertical
2	135.730	-58.23	-44.74	-13.00	-45.23	-13.49	Peak	Vertical
3	252.130	-58.20	-44.72	-13.00	-45.20	-13.48	Peak	Vertical
4	327.790	-60.47	-50.16	-13.00	-47.47	-10.31	Peak	Vertical
5	453.890	-56.22	-47.72	-13.00	-43.22	-8.50	Peak	Vertical
6	655.650	-57.74	-52.07	-13.00	-44.74	-5.67	Peak	Vertical

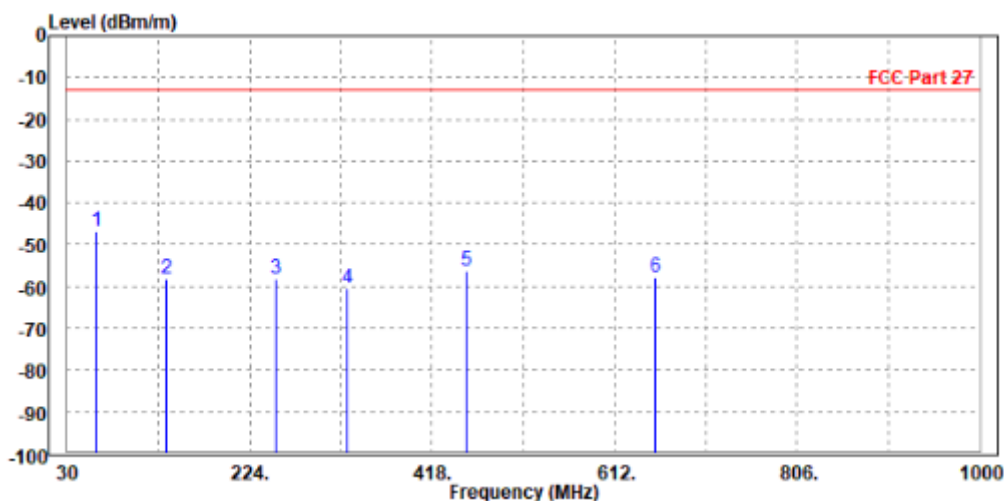



**BUREAU
VERITAS**

Test Report No.: W7L-P22080014RF03

ABOVE 1GHz

Note: For higher frequency, the emission is too low to be detected.

LTE Band 4

CHANNEL BANDWIDTH: 1.4MHz / QPSK

MODE	TX channel 20175	FREQUENCY RANGE	Above 1000MHz
ENVIRONMENTAL CONDITIONS	23deg. C, 70%RH	INPUT POWER	DC30V
TESTED BY	Jace Hu		
ANTENNA POLARITY & TEST DISTANCE: HORIZONTAL AT 3 M			

	Freq	Level	Read Level	Limit Line	Over Limit	Factor	Remark	Pol/Phase
	MHz	dBm/m	dBm	dBm/m	dB	dB/m		
1	PP 3465.000	-39.18	-46.45	-13.00	-26.18	7.27	Peak	Horizontal
2	5186.000	-40.94	-50.92	-13.00	-27.94	9.98	Peak	Horizontal

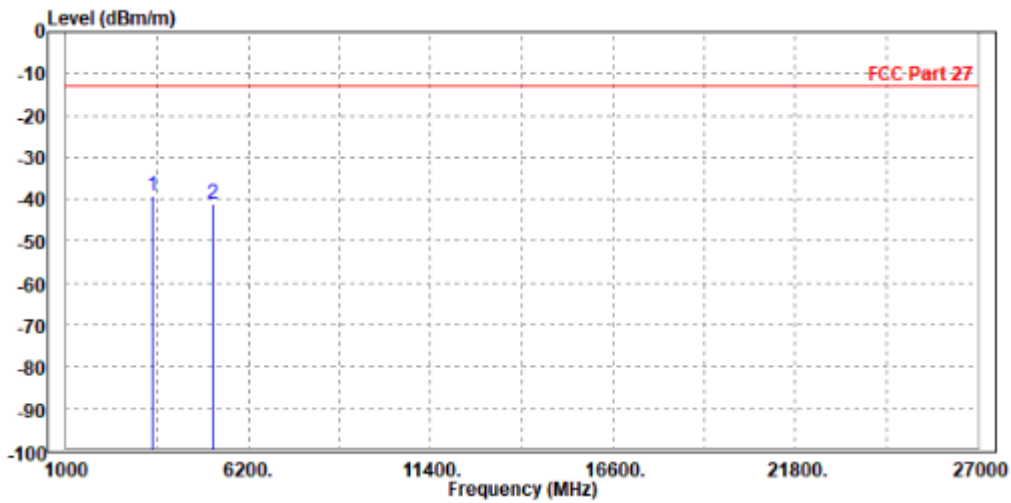



Test Report No.: W7L-P22080014RF03

MODE	TX channel 20175	FREQUENCY RANGE	Above 1000MHz
ENVIRONMENTAL CONDITIONS	23deg. C, 70%RH	INPUT POWER	DC30V
TESTED BY	Jace Hu		
ANTENNA POLARITY & TEST DISTANCE: VERTICAL AT 3 M			

	Freq	Level	Read Level	Limit Line	Over Limit	Factor	Remark	Pol/Phase
	MHz	dBm/m	dBm	dBm/m	dB	dB/m		
1 PP	3470.000	-38.33	-45.60	-13.00	-25.33	7.27	Peak	Vertical
2	5197.500	-41.35	-51.80	-13.00	-28.35	10.45	Peak	Vertical

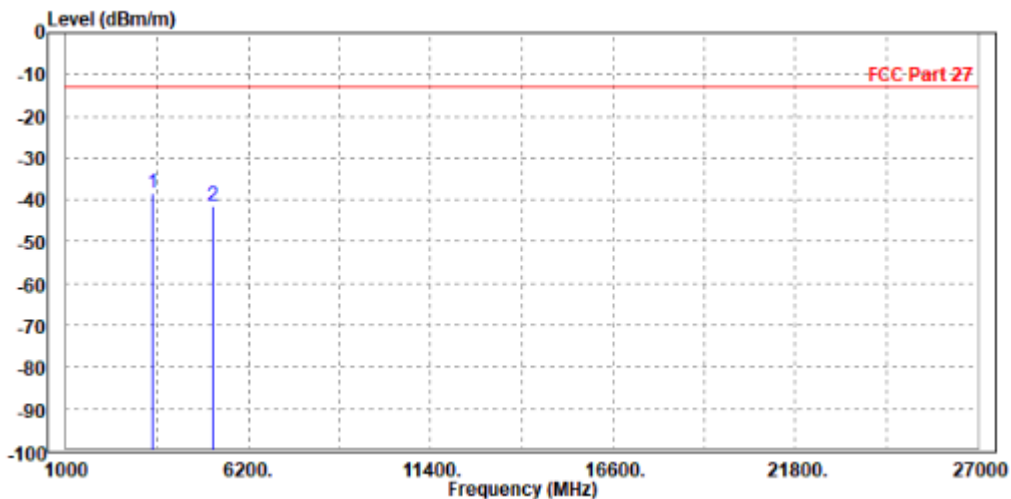



**BUREAU
VERITAS**

Test Report No.: W7L-P22080014RF03

CHANNEL BANDWIDTH: 3MHz / QPSK

MODE	TX channel 20175	FREQUENCY RANGE	Above 1000MHz
ENVIRONMENTAL CONDITIONS	23deg. C, 70%RH	INPUT POWER	DC30V
TESTED BY	Jace Hu		
ANTENNA POLARITY & TEST DISTANCE: HORIZONTAL AT 3 M			

	Freq	Level	Read Level	Limit Line	Over Limit	Factor	Remark	Pol/Phase
	MHz	dBm/m	dBm	dBm/m	dB	dB/m		
1	PP 3470.000	-39.57	-46.85	-13.00	-26.57	7.28	Peak	Horizontal
2	5197.500	-39.90	-49.90	-13.00	-26.90	10.00	Peak	Horizontal

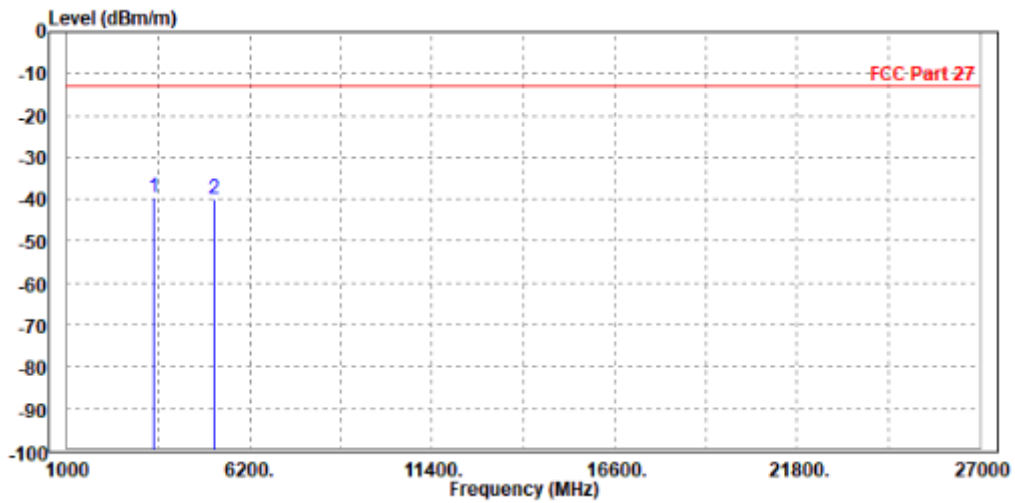



Test Report No.: W7L-P22080014RF03

MODE	TX channel 20175	FREQUENCY RANGE	Above 1000MHz
ENVIRONMENTAL CONDITIONS	23deg. C, 70%RH	INPUT POWER	DC30V
TESTED BY	Jace Hu		
ANTENNA POLARITY & TEST DISTANCE: VERTICAL AT 3 M			

	Read	Limit	Over			
Freq	Level	Level	Line	Limit	Factor	Remark
MHz	dBm/m	dBm	dBm/m	dB	dB/m	
1 PP 3465.000	-38.56	-45.82	-13.00	-25.56	7.26	Peak Vertical
2 5186.000	-46.47	-56.91	-13.00	-33.47	10.44	Peak Vertical

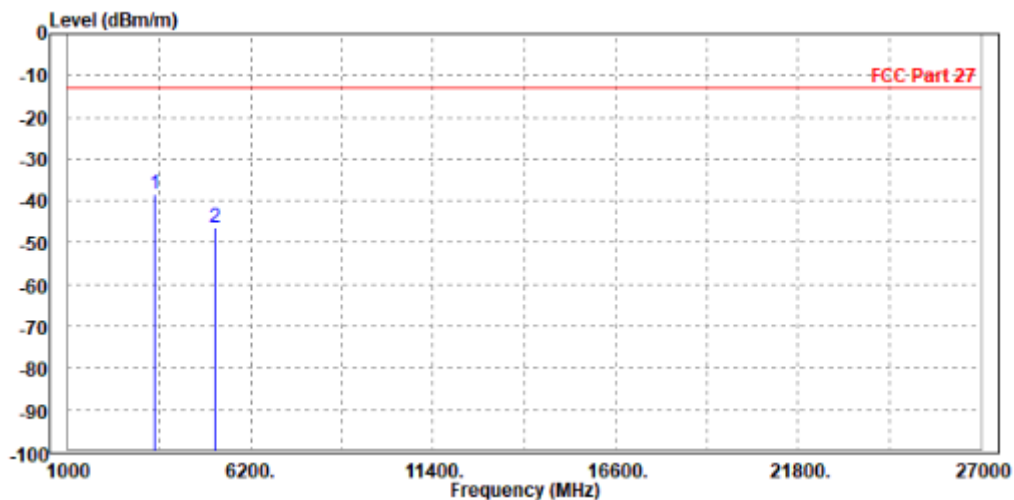



**BUREAU
VERITAS**

Test Report No.: W7L-P22080014RF03

CHANNEL BANDWIDTH: 5MHz / QPSK

MODE	TX channel 20175	FREQUENCY RANGE	Above 1000MHz
ENVIRONMENTAL CONDITIONS	23deg. C, 70%RH	INPUT POWER	DC30V
TESTED BY	Jace Hu		
ANTENNA POLARITY & TEST DISTANCE: HORIZONTAL AT 3 M			

	Freq	Level	Read Level	Limit Line	Over Limit	Factor	Remark	Pol/Phase
	MHz	dBm/m	dBm	dBm/m	dB	dB/m		
1	PP 3465.000	-43.44	-50.71	-13.00	-30.44	7.27	Peak	Horizontal
2	5186.000	-43.66	-53.64	-13.00	-30.66	9.98	Peak	Horizontal

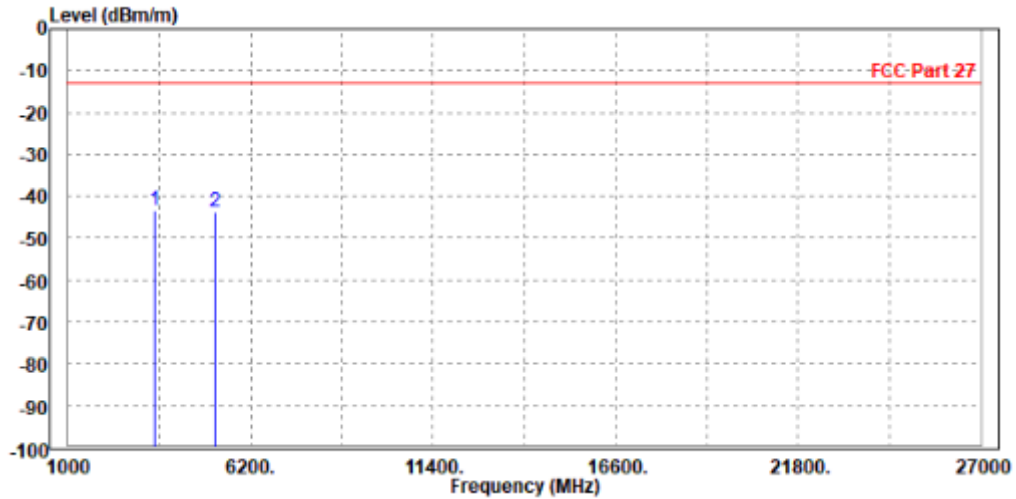



Test Report No.: W7L-P22080014RF03

MODE	TX channel 20175	FREQUENCY RANGE	Above 1000MHz
ENVIRONMENTAL CONDITIONS	23deg. C, 70%RH	INPUT POWER	DC30V
TESTED BY	Jace Hu		
ANTENNA POLARITY & TEST DISTANCE: VERTICAL AT 3 M			

	Freq	Level	Read Level	Limit Line	Over Limit	Factor	Remark	Pol/Phase
	MHz	dBm/m	dBm	dBm/m	dB	dB/m		
1	PP 3470.000	-38.77	-46.04	-13.00	-25.77	7.27	Peak	Vertical
2	5197.500	-48.77	-59.22	-13.00	-35.77	10.45	Peak	Vertical

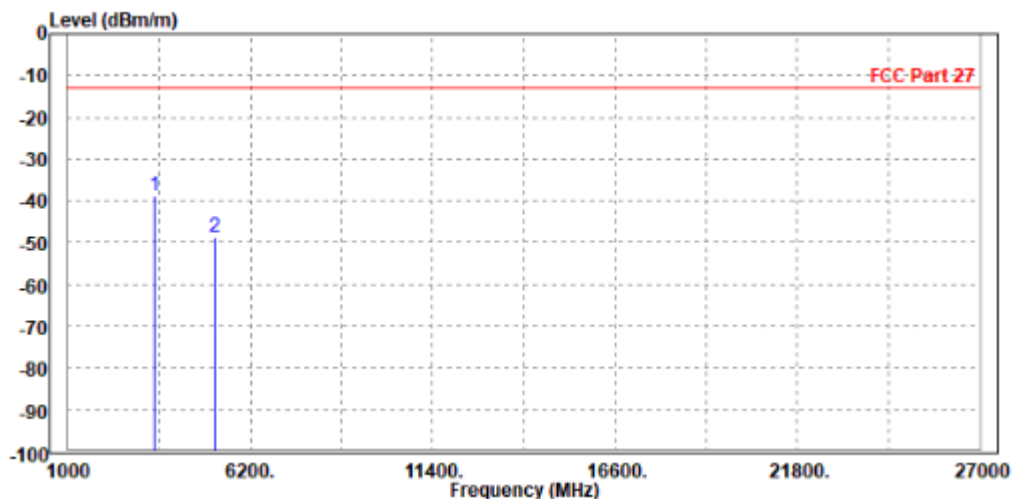



**BUREAU
VERITAS**

Test Report No.: W7L-P22080014RF03

**CHANNEL BANDWIDTH: 10MHz / QPSK
CH20000**

MODE	TX channel 20000	FREQUENCY RANGE	Above 1000MHz
ENVIRONMENTAL CONDITIONS	23deg. C, 70%RH	INPUT POWER	DC30V
TESTED BY	Jace Hu		
ANTENNA POLARITY & TEST DISTANCE: HORIZONTAL AT 3 M			

	Freq	Level	Read Level	Limit Line	Over Limit	Factor	Remark	Pol/Phase
	MHz	dBm/m	dBm	dBm/m	dB	dB/m		
1	PP 3418.000	-41.00	-48.21	-13.00	-28.00	7.21	Peak	Horizontal
2	5145.000	-43.90	-53.82	-13.00	-30.90	9.92	Peak	Horizontal

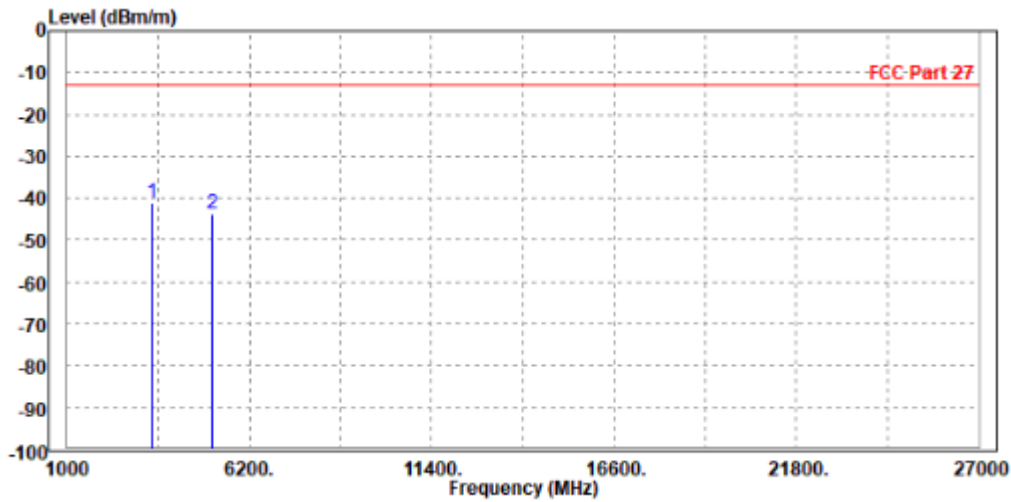



Test Report No.: W7L-P22080014RF03

MODE	TX channel 20000	FREQUENCY RANGE	Above 1000MHz
ENVIRONMENTAL CONDITIONS	23deg. C, 70%RH	INPUT POWER	DC30V
TESTED BY	Jace Hu		
ANTENNA POLARITY & TEST DISTANCE: VERTICAL AT 3 M			

	Freq	Level	Read Level	Limit Line	Over Limit	Factor	Remark	Pol/Phase
	MHz	dBm/m	dBm	dBm/m	dB	dB/m		
1	PP 3430.000	-37.12	-44.33	-13.00	-24.12	7.21	Peak	Vertical
2	5134.000	-47.97	-58.36	-13.00	-34.97	10.39	Peak	Vertical

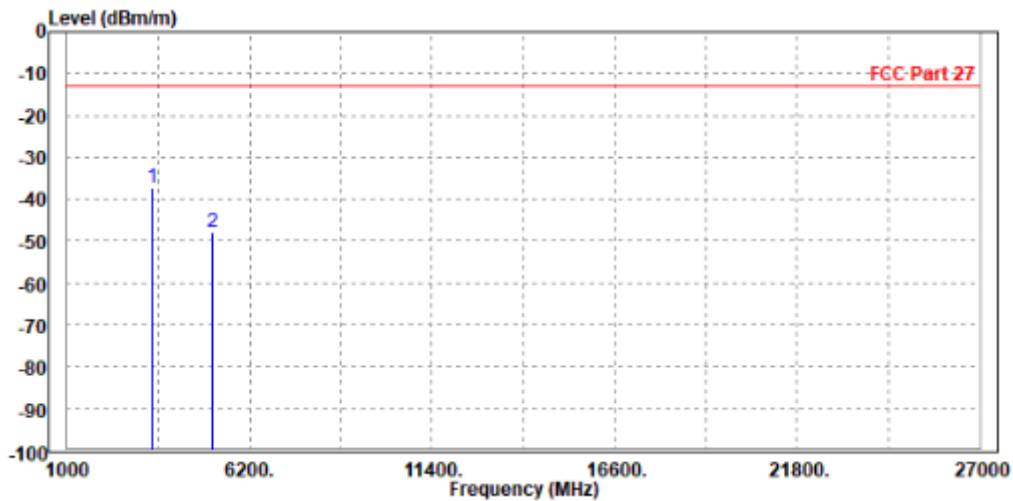



**BUREAU
VERITAS**

Test Report No.: W7L-P22080014RF03

CH20175

MODE	TX channel 20175	FREQUENCY RANGE	Above 1000MHz
ENVIRONMENTAL CONDITIONS	23deg. C, 70%RH	INPUT POWER	DC30V
TESTED BY	Jace Hu		
ANTENNA POLARITY & TEST DISTANCE: HORIZONTAL AT 3 M			

	Freq	Level	Read Level	Limit Line	Over Limit	Factor	Remark	Pol/Phase
	MHz	dBm/m	dBm	dBm/m	dB	dB/m		
1	PP 3470.000	-40.31	-47.59	-13.00	-27.31	7.28	Peak	Horizontal
2	5197.500	-45.02	-55.02	-13.00	-32.02	10.00	Peak	Horizontal

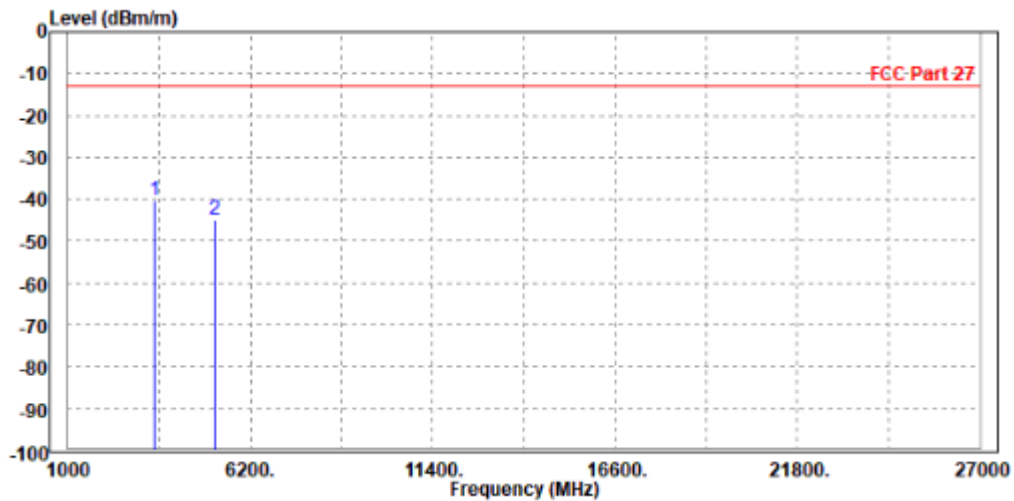



Test Report No.: W7L-P22080014RF03

MODE	TX channel 20175	FREQUENCY RANGE	Above 1000MHz
ENVIRONMENTAL CONDITIONS	23deg. C, 70%RH	INPUT POWER	DC30V
TESTED BY	Jace Hu		
ANTENNA POLARITY & TEST DISTANCE: VERTICAL AT 3 M			

	Freq	Level	Read Level	Limit Line	Over Limit	Factor	Remark	Pol/Phase
	MHz	dBm/m	dBm	dBm/m	dB	dB/m		
1 PP	3465.000	-37.95	-45.21	-13.00	-24.95	7.26	Peak	Vertical
2	5186.000	-47.67	-58.11	-13.00	-34.67	10.44	Peak	Vertical

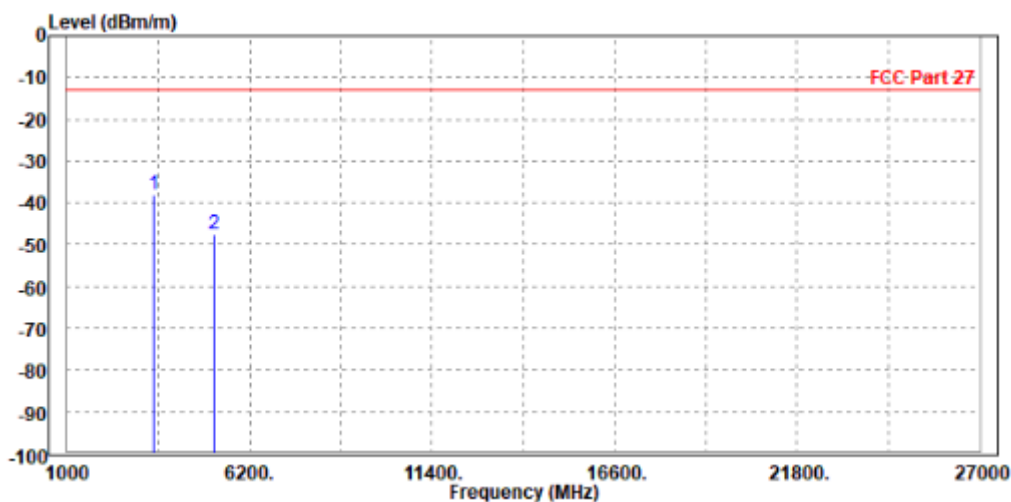



**BUREAU
VERITAS**

Test Report No.: W7L-P22080014RF03

CH20350

MODE	TX channel 20350	FREQUENCY RANGE	Above 1000MHz
ENVIRONMENTAL CONDITIONS	23deg. C, 70%RH	INPUT POWER	DC30V
TESTED BY	Jace Hu		
ANTENNA POLARITY & TEST DISTANCE: HORIZONTAL AT 3 M			

	Freq	Level	Read Level	Limit Line	Over Limit	Factor	Remark	Pol/Phase
	MHz	dBm/m	dBm	dBm/m	dB	dB/m		
1	3500.000	-42.20	-49.52	-13.00	-29.20	7.32	Peak	Horizontal
2 PP	5238.000	-36.29	-46.35	-13.00	-23.29	10.06	Peak	Horizontal

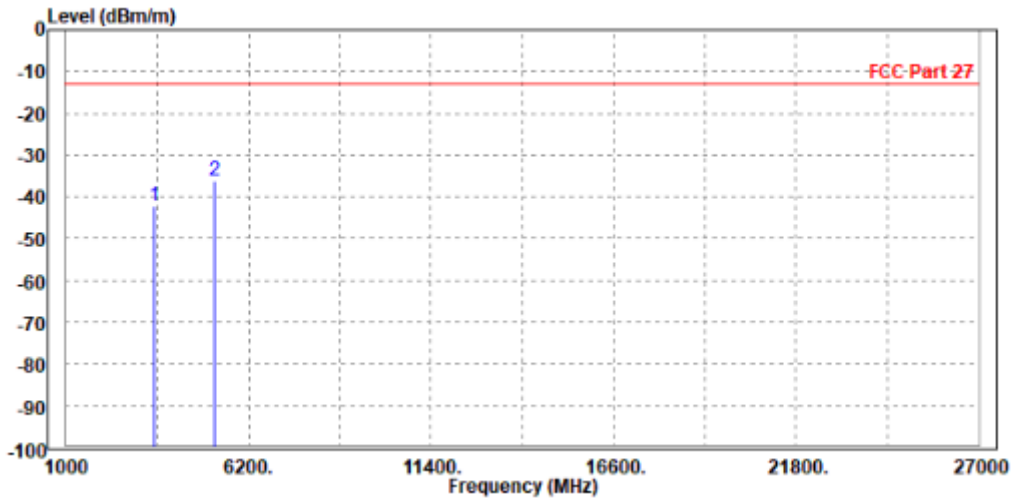



Test Report No.: W7L-P22080014RF03

MODE	TX channel 20350	FREQUENCY RANGE	Above 1000MHz
ENVIRONMENTAL CONDITIONS	23deg. C, 70%RH	INPUT POWER	DC30V
TESTED BY	Jace Hu		
ANTENNA POLARITY & TEST DISTANCE: VERTICAL AT 3 M			

	Freq	Level	Read Level	Limit Line	Over Limit	Factor	Remark	Pol/Phase
	MHz	dBm/m	dBm	dBm/m	dB	dB/m		
1	PP 3496.000	-40.62	-47.93	-13.00	-27.62	7.31	Peak	Vertical
2	5250.000	-44.85	-55.35	-13.00	-31.85	10.50	Peak	Vertical

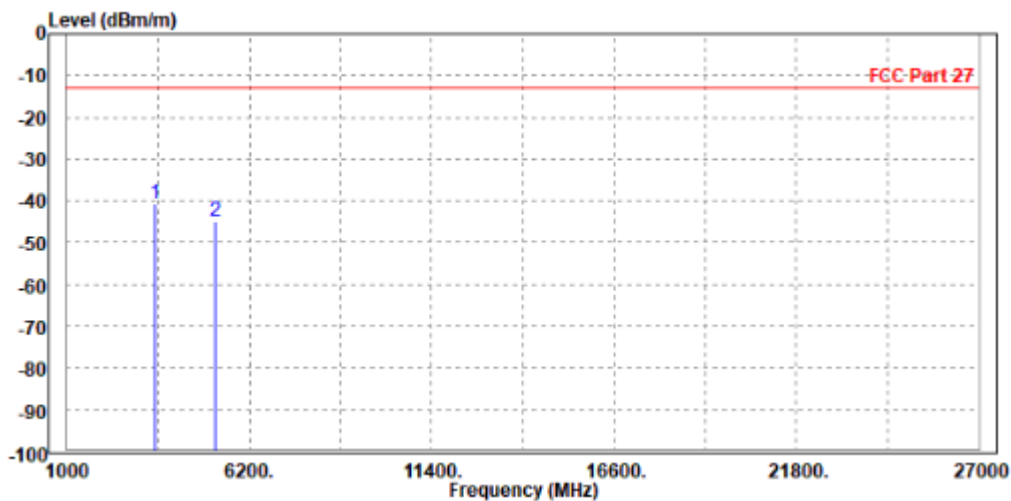



**BUREAU
VERITAS**

Test Report No.: W7L-P22080014RF03

CHANNEL BANDWIDTH: 15MHz / QPSK

MODE	TX channel 20175	FREQUENCY RANGE	Above 1000MHz
ENVIRONMENTAL CONDITIONS	23deg. C, 70%RH	INPUT POWER	DC30V
TESTED BY	Jace Hu		
ANTENNA POLARITY & TEST DISTANCE: HORIZONTAL AT 3 M			

	Freq	Level	Read Level	Limit Line	Over Limit	Factor	Remark	Pol/Phase
	MHz	dBm/m	dBm	dBm/m	dB	dB/m		
1	3470.000	-44.96	-52.24	-13.00	-31.96	7.28	Peak	Horizontal
2 PP	5197.500	-43.80	-53.80	-13.00	-30.80	10.00	Peak	Horizontal

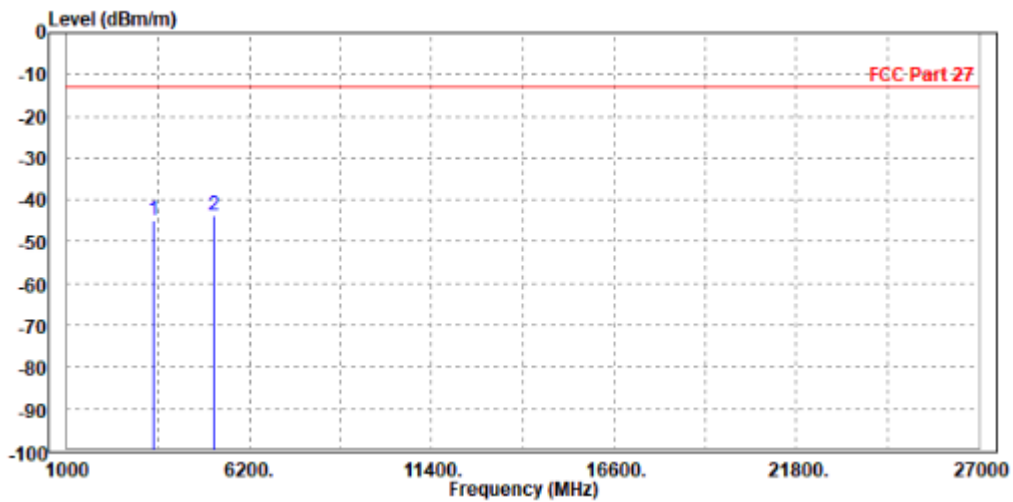



Test Report No.: W7L-P22080014RF03

MODE	TX channel 20175	FREQUENCY RANGE	Above 1000MHz
ENVIRONMENTAL CONDITIONS	23deg. C, 70%RH	INPUT POWER	DC30V
TESTED BY	Jace Hu		
ANTENNA POLARITY & TEST DISTANCE: VERTICAL AT 3 M			

	Freq	Level	Read Level	Limit Line	Over Limit	Factor	Remark	Pol/Phase
	MHz	dBm/m	dBm	dBm/m	dB	dB/m		
1 PP	3465.000	-38.15	-45.41	-13.00	-25.15	7.26	Peak	Vertical
2	5186.000	-44.65	-55.09	-13.00	-31.65	10.44	Peak	Vertical

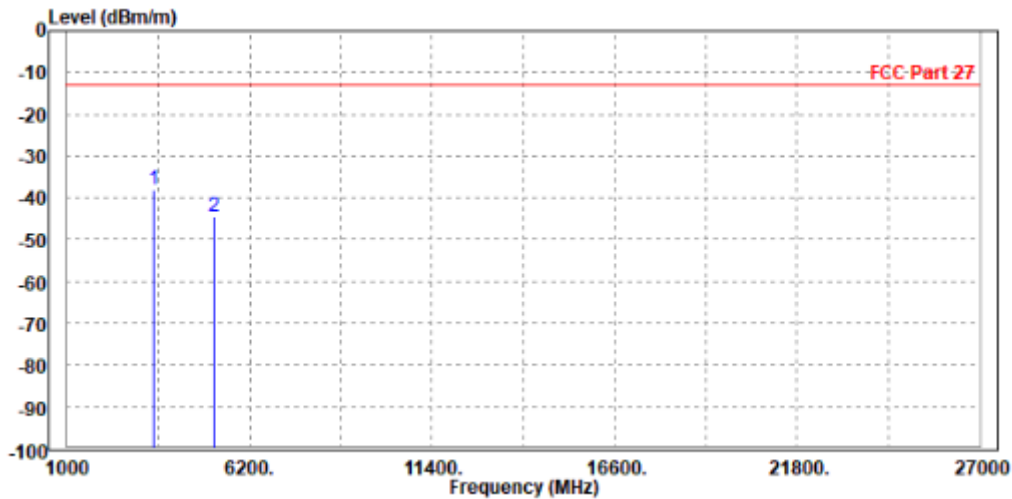



**BUREAU
VERITAS**

Test Report No.: W7L-P22080014RF03

CHANNEL BANDWIDTH: 20MHz / QPSK

MODE	TX channel 20175	FREQUENCY RANGE	Above 1000MHz
ENVIRONMENTAL CONDITIONS	23deg. C, 70%RH	INPUT POWER	DC30V
TESTED BY	Jace Hu		
ANTENNA POLARITY & TEST DISTANCE: HORIZONTAL AT 3 M			

	Freq	Level	Read Level	Limit Line	Over Limit	Factor	Remark	Pol/Phase
	MHz	dBm/m	dBm	dBm/m	dB	dB/m		
1	PP 3465.000	-40.58	-47.85	-13.00	-27.58	7.27	Peak	Horizontal
2	5186.000	-46.22	-56.20	-13.00	-33.22	9.98	Peak	Horizontal

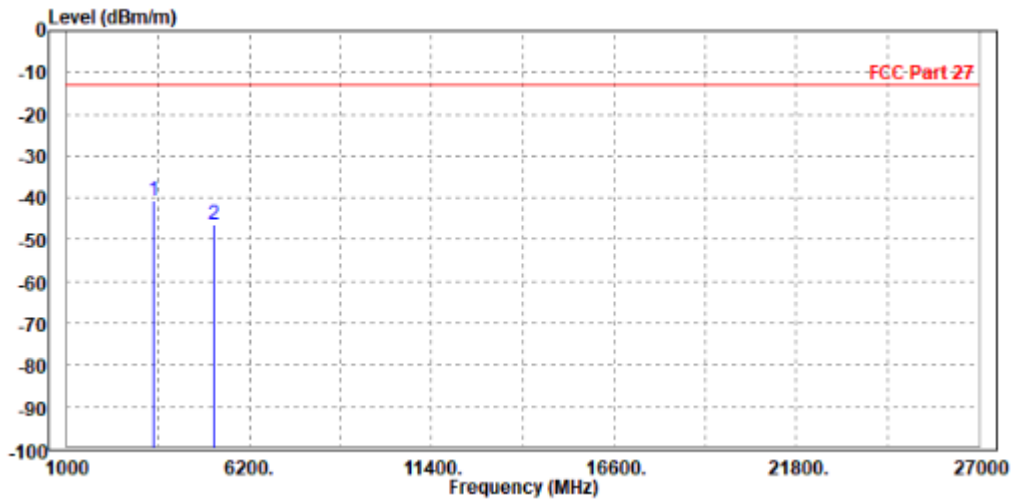



Test Report No.: W7L-P22080014RF03

MODE	TX channel 20175	FREQUENCY RANGE	Above 1000MHz
ENVIRONMENTAL CONDITIONS	23deg. C, 70%RH	INPUT POWER	DC30V
TESTED BY	Jace Hu		
ANTENNA POLARITY & TEST DISTANCE: VERTICAL AT 3 M			

	Freq	Level	Read Level	Limit Line	Over Limit	Factor	Remark	Pol/Phase
	MHz	dBm/m	dBm	dBm/m	dB	dB/m		
1	PP 3470.000	-42.20	-49.47	-13.00	-29.20	7.27	Peak	Vertical
2	5197.500	-44.43	-54.88	-13.00	-31.43	10.45	Peak	Vertical

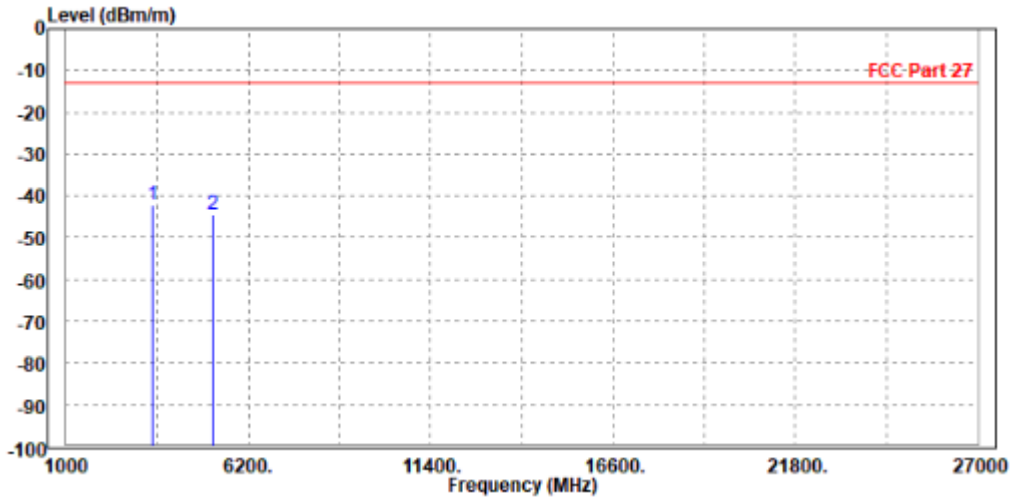



Test Report No.: W7L-P22080014RF03

LTE BAND 12

CHANNEL BANDWIDTH: 1.4MHz / QPSK

CH23017

MODE	TX channel 23017	FREQUENCY RANGE	Above 1000MHz
ENVIRONMENTAL CONDITIONS	23deg. C, 70%RH	INPUT POWER	DC30V
TESTED BY	Jace Hu		
ANTENNA POLARITY & TEST DISTANCE: HORIZONTAL AT 3 M			

	Freq	Level	Read Level	Limit Line	Over Limit	Factor	Remark	Pol/Phase
	MHz	dBm/m	dBm	dBm/m	dB	dB/m		
1	PP 1390.000	-36.73	-36.02	-13.00	-23.73	-0.71	Peak	Horizontal
2	2099.100	-40.78	-44.76	-13.00	-27.78	3.98	Peak	Horizontal

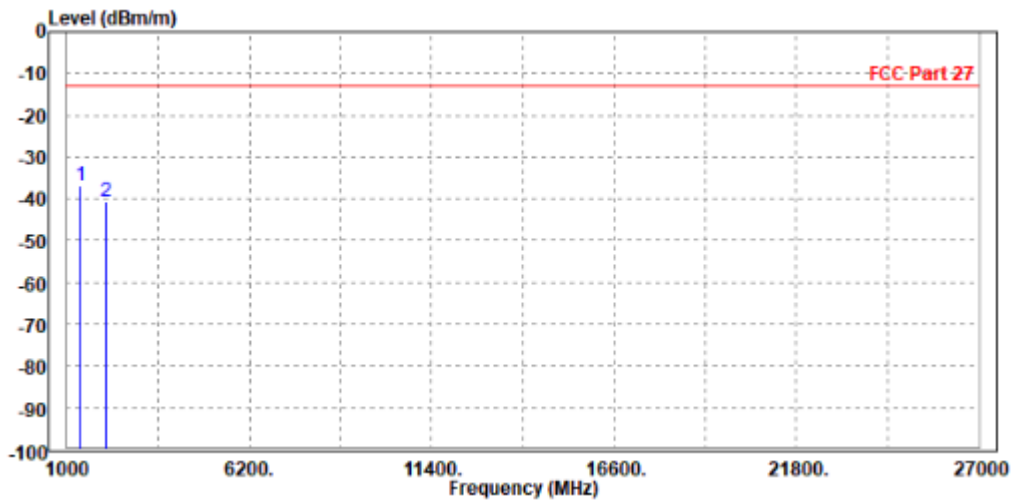



Test Report No.: W7L-P22080014RF03

MODE	TX channel 23017	FREQUENCY RANGE	Above 1000MHz
ENVIRONMENTAL CONDITIONS	23deg. C, 70%RH	INPUT POWER	DC30V
TESTED BY	Jace Hu		
ANTENNA POLARITY & TEST DISTANCE: VERTICAL AT 3 M			

	Freq	Level	Read Level	Limit Line	Over Limit	Factor	Remark	Pol/Phase
	MHz	dBm/m	dBm	dBm/m	dB	dB/m		
1	1399.400	-49.44	-48.97	-13.00	-36.44	-0.47	Peak	Vertical
2 PP	2092.000	-39.49	-43.32	-13.00	-26.49	3.83	Peak	Vertical

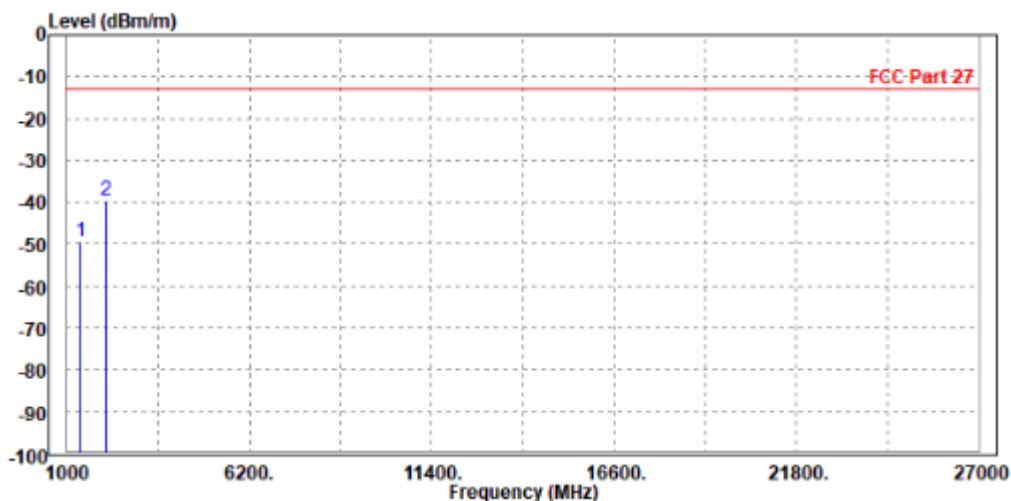



**BUREAU
VERITAS**

Test Report No.: W7L-P22080014RF03

CH23095

MODE	TX channel 23095	FREQUENCY RANGE	Above 1000MHz
ENVIRONMENTAL CONDITIONS	23deg. C, 70%RH	INPUT POWER	DC30V
TESTED BY	Jace Hu		
ANTENNA POLARITY & TEST DISTANCE: HORIZONTAL AT 3 M			

	Freq	Level	Read Level	Limit Line	Over Limit	Factor	Remark	Pol/Phase
	MHz	dBm/m	dBm	dBm/m	dB	dB/m		
1	PP 1416.000	-34.57	-33.93	-13.00	-21.57	-0.64	Peak	Horizontal
2	2122.500	-45.64	-49.70	-13.00	-32.64	4.06	Peak	Horizontal

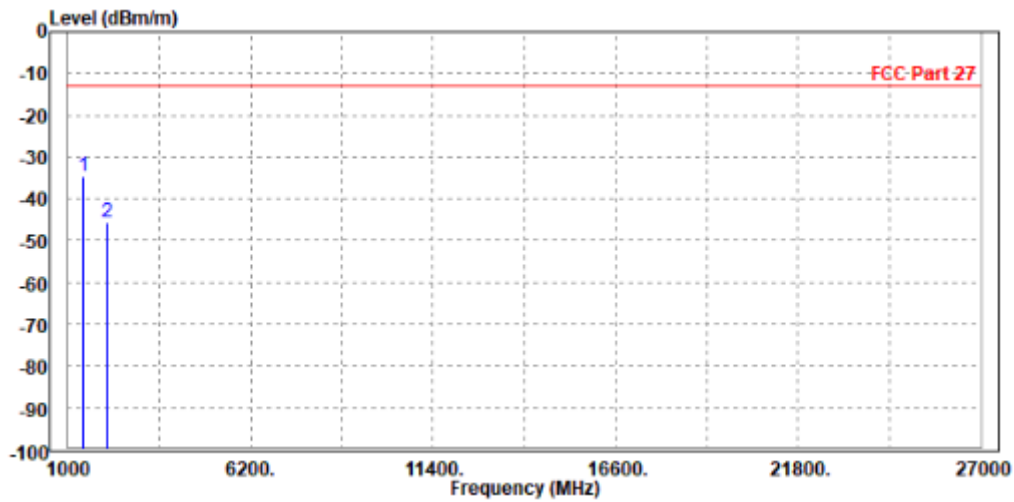



Test Report No.: W7L-P22080014RF03

MODE	TX channel 23095	FREQUENCY RANGE	Above 1000MHz
ENVIRONMENTAL CONDITIONS	23deg. C, 70%RH	INPUT POWER	DC30V
TESTED BY	Jace Hu		
ANTENNA POLARITY & TEST DISTANCE: VERTICAL AT 3 M			

	Freq	Level	Read Level	Limit Line	Over Limit	Factor	Remark	Pol/Phase
	MHz	dBm/m	dBm	dBm/m	dB	dB/m		
1	PP 1415.000	-33.92	-33.51	-13.00	-20.92	-0.41	Peak	Vertical
2	2118.000	-39.78	-43.68	-13.00	-26.78	3.90	Peak	Vertical

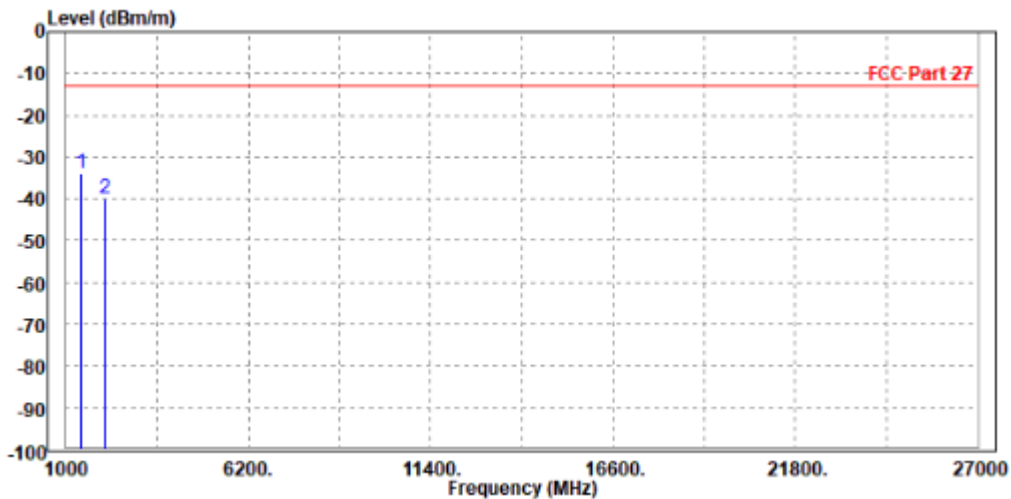



BUREAU VERITAS

Test Report No.: W7L-P22080014RF03

CH23173

MODE	TX channel 23173	FREQUENCY RANGE	Above 1000MHz
ENVIRONMENTAL CONDITIONS	23deg. C, 70%RH	INPUT POWER	DC30V
TESTED BY	Jace Hu		
ANTENNA POLARITY & TEST DISTANCE: HORIZONTAL AT 3 M			

	Freq	Level	Read Level	Limit Line	Over Limit	Factor	Remark	Pol/Phase
	MHz	dBm/m	dBm	dBm/m	dB	dB/m		
1	1430.600	-43.69	-43.08	-13.00	-30.69	-0.61	Peak	Horizontal
2 PP	2144.000	-39.28	-43.42	-13.00	-26.28	4.14	Peak	Horizontal

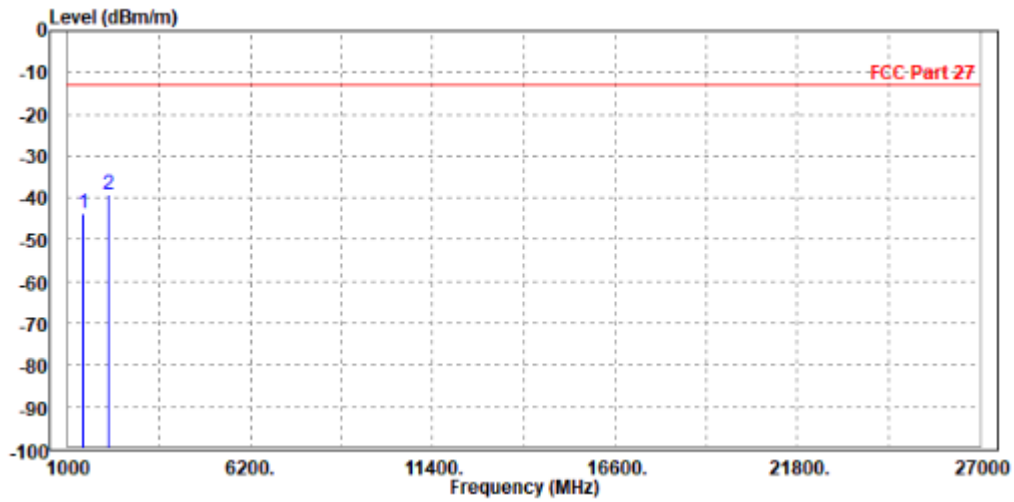



Test Report No.: W7L-P22080014RF03

MODE	TX channel 23173	FREQUENCY RANGE	Above 1000MHz
ENVIRONMENTAL CONDITIONS	23deg. C, 70%RH	INPUT POWER	DC30V
TESTED BY	Jace Hu		
ANTENNA POLARITY & TEST DISTANCE: VERTICAL AT 3 M			

	Freq	Level	Read Level	Limit Line	Over Limit	Factor	Remark	Pol/Phase
	MHz	dBm/m	dBm	dBm/m	dB	dB/m		
1	1442.000	-44.65	-44.36	-13.00	-31.65	-0.29	Peak	Vertical
2 PP	2145.900	-36.06	-40.04	-13.00	-23.06	3.98	Peak	Vertical

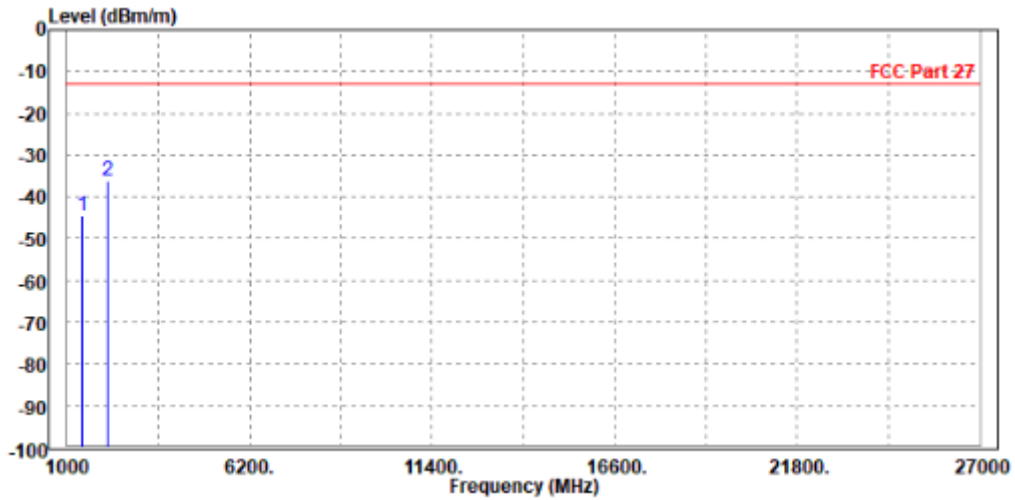



BUREAU VERITAS

Test Report No.: W7L-P22080014RF03

CHANNEL BANDWIDTH: 3MHz / QPSK

CH23095

MODE	TX channel 23095	FREQUENCY RANGE	Above 1000MHz
ENVIRONMENTAL CONDITIONS	23deg. C, 70%RH	INPUT POWER	DC30V
TESTED BY	Jace Hu		
ANTENNA POLARITY & TEST DISTANCE: HORIZONTAL AT 3 M			

	Freq	Level	Read Level	Limit Line	Over Limit	Factor	Remark	Pol/Phase
	MHz	dBm/m	dBm	dBm/m	dB	dB/m		
1	PP 1415.000	-42.68	-42.03	-13.00	-29.68	-0.65	Peak	Horizontal
2	2118.000	-44.99	-49.04	-13.00	-31.99	4.05	Peak	Horizontal

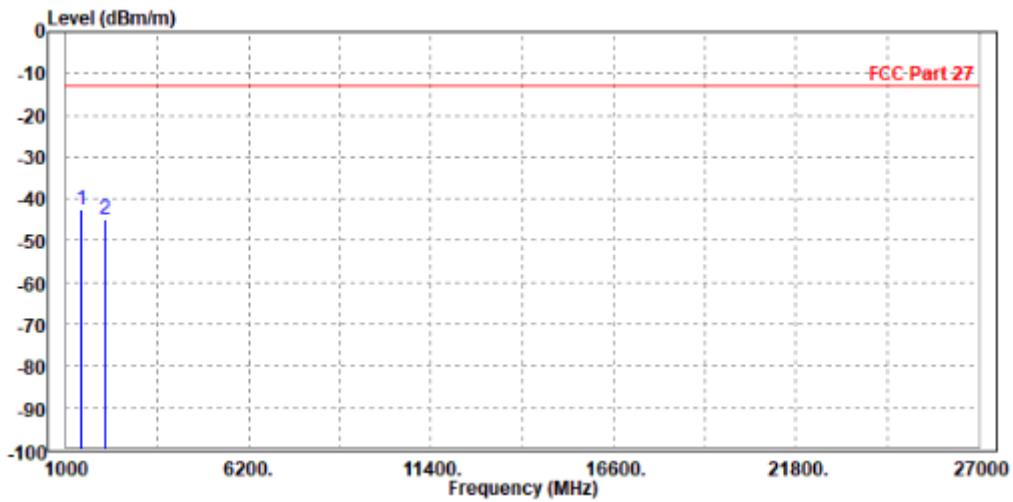



Test Report No.: W7L-P22080014RF03

MODE	TX channel 23095	FREQUENCY RANGE	Above 1000MHz
ENVIRONMENTAL CONDITIONS	23deg. C, 70%RH	INPUT POWER	DC30V
TESTED BY	Jace Hu		
ANTENNA POLARITY & TEST DISTANCE: VERTICAL AT 3 M			

	Freq	Level	Read Level	Limit Line	Over Limit	Factor	Remark	Pol/Phase
	MHz	dBm/m	dBm	dBm/m	dB	dB/m		
1	1416.000	-39.44	-39.04	-13.00	-26.44	-0.40	Peak	Vertical
2 PP	2122.500	-37.49	-41.41	-13.00	-24.49	3.92	Peak	Vertical

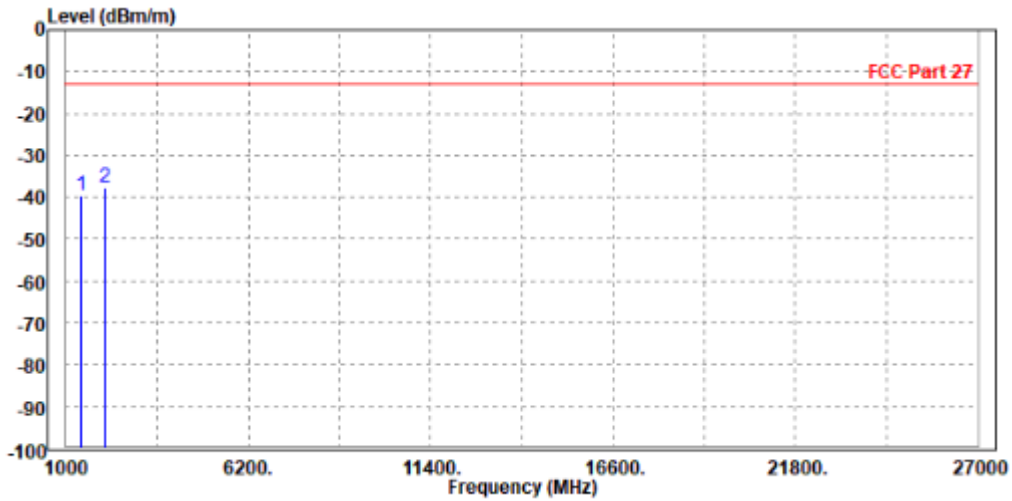



Test Report No.: W7L-P22080014RF03

CHANNEL BANDWIDTH: 5MHz / QPSK

MODE	TX channel 23095	FREQUENCY RANGE	Above 1000MHz
ENVIRONMENTAL CONDITIONS	23deg. C, 70%RH	INPUT POWER	DC30V
TESTED BY	Jace Hu		
ANTENNA POLARITY & TEST DISTANCE: HORIZONTAL AT 3 M			

	Freq	Level	Read Level	Limit Line	Over Limit	Factor	Remark	Pol/Phase
	MHz	dBm/m	dBm	dBm/m	dB	dB/m		
1	1416.000	-45.61	-44.97	-13.00	-32.61	-0.64	Peak	Horizontal
2 PP	2122.500	-39.39	-43.45	-13.00	-26.39	4.06	Peak	Horizontal

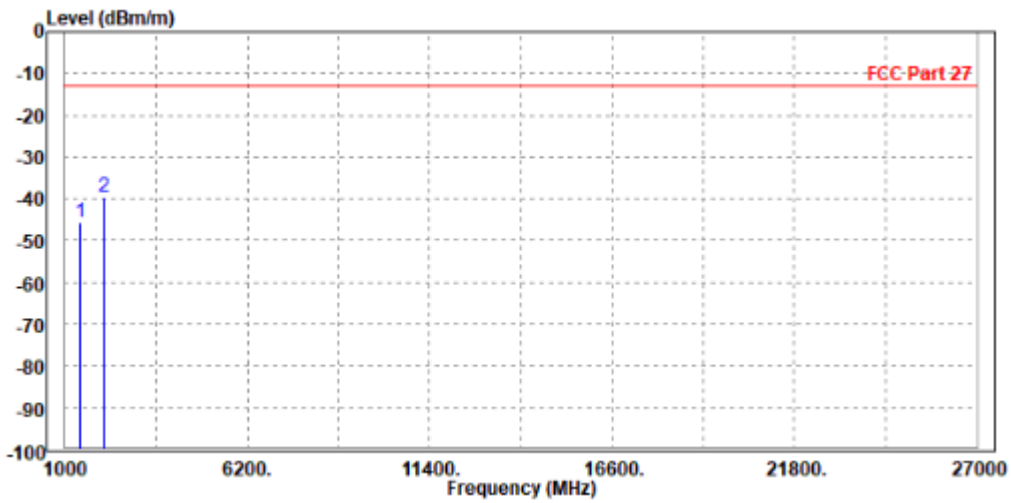



Test Report No.: W7L-P22080014RF03

MODE	TX channel 23095	FREQUENCY RANGE	Above 1000MHz
ENVIRONMENTAL CONDITIONS	23deg. C, 70%RH	INPUT POWER	DC30V
TESTED BY	Jace Hu		
ANTENNA POLARITY & TEST DISTANCE: VERTICAL AT 3 M			

	Freq	Level	Read Level	Limit Line	Over Limit	Factor	Remark	Pol/Phase
	MHz	dBm/m	dBm	dBm/m	dB	dB/m		
1	1415.000	-47.66	-47.25	-13.00	-34.66	-0.41	Peak	Vertical
2 PP	2118.000	-43.39	-47.29	-13.00	-30.39	3.90	Peak	Vertical

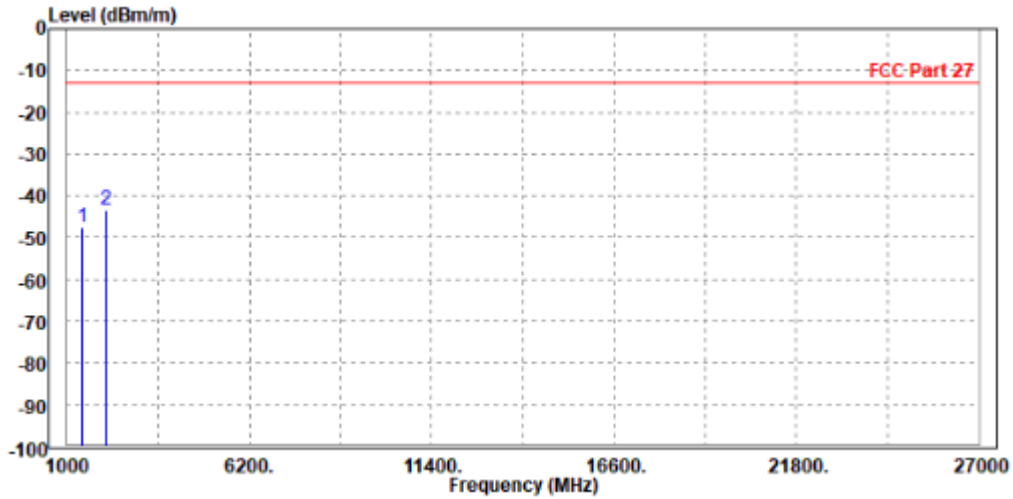



Test Report No.: W7L-P22080014RF03

CHANNEL BANDWIDTH: 10MHz / QPSK

MODE	TX channel 23095	FREQUENCY RANGE	Above 1000MHz
ENVIRONMENTAL CONDITIONS	23deg. C, 70%RH	INPUT POWER	DC30V
TESTED BY	Jace Hu		
ANTENNA POLARITY & TEST DISTANCE: HORIZONTAL AT 3 M			

	Freq	Level	Read Level	Limit Line	Over Limit	Factor	Remark	Pol/Phase
	MHz	dBm/m	dBm	dBm/m	dB	dB/m		
1	1416.000	-53.77	-53.13	-13.00	-40.77	-0.64	Peak	Horizontal
2 PP	2122.500	-50.61	-54.67	-13.00	-37.61	4.06	Peak	Horizontal

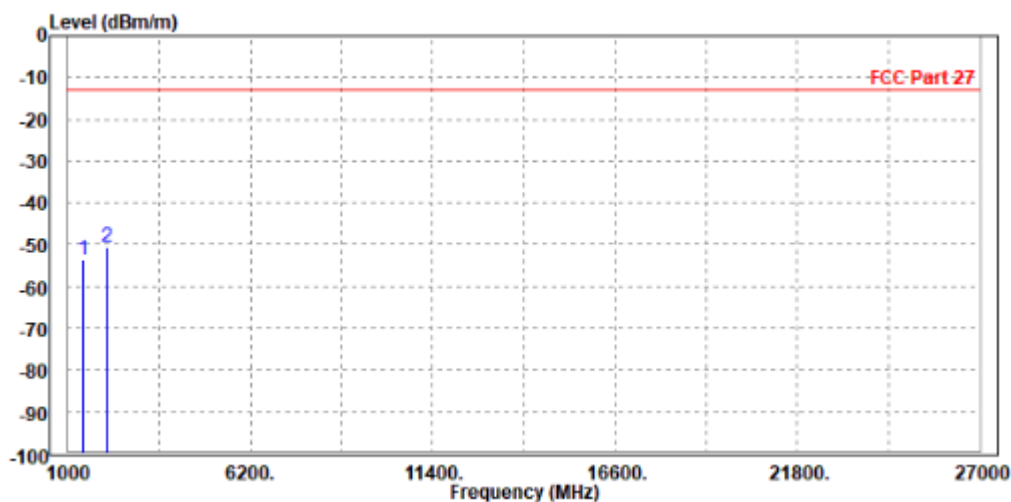



Test Report No.: W7L-P22080014RF03

MODE	TX channel 23095	FREQUENCY RANGE	Above 1000MHz
ENVIRONMENTAL CONDITIONS	23deg. C, 70%RH	INPUT POWER	DC30V
TESTED BY	Jace Hu		
ANTENNA POLARITY & TEST DISTANCE: VERTICAL AT 3 M			

	Freq	Level	Read Level	Limit Line	Over Limit	Factor	Remark	Pol/Phase
	MHz	dBm/m	dBm	dBm/m	dB	dB/m		
1	1416.000	-49.87	-49.47	-13.00	-36.87	-0.40	Peak	Vertical
2	PP 2122.500	-39.44	-43.36	-13.00	-26.44	3.92	Peak	Vertical

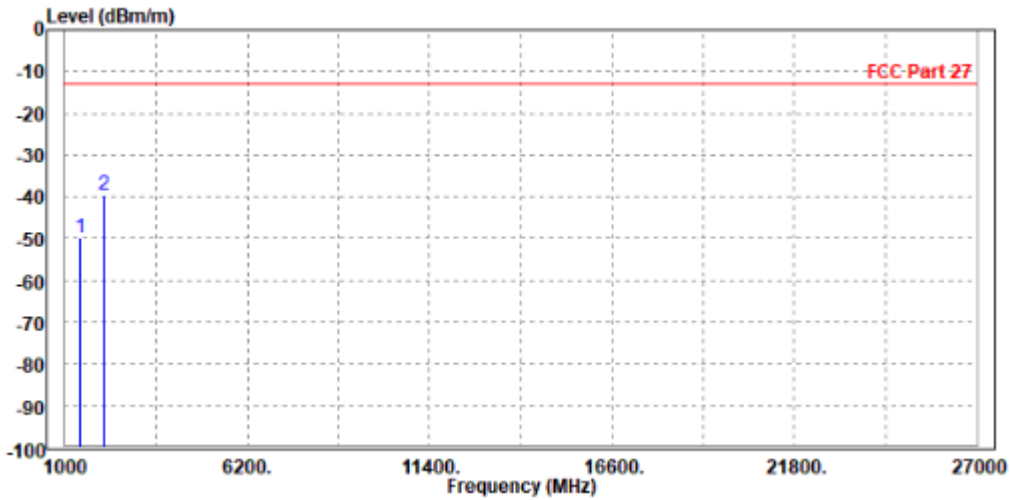



Test Report No.: W7L-P22080014RF03

LTE B13

CHANNEL BANDWIDTH: 5MHz / QPSK

CH23205

MODE	TX channel 23205	FREQUENCY RANGE	Above 1000MHz
ENVIRONMENTAL CONDITIONS	23deg. C, 70%RH	INPUT POWER	DC30V
TESTED BY	Jace Hu		
ANTENNA POLARITY & TEST DISTANCE: HORIZONTAL AT 3 M			

	Freq	Level	Read Level	Limit Line	Over Limit	Factor	Remark	Pol/Phase
	MHz	dBm/m	dBm	dBm/m	dB	dB/m		
1	PP 1572.000	-45.35	-45.51	-40.00	-5.35	0.16	Peak	Horizontal
2	2338.500	-33.29	-38.14	-13.00	-20.29	4.85	Peak	Horizontal

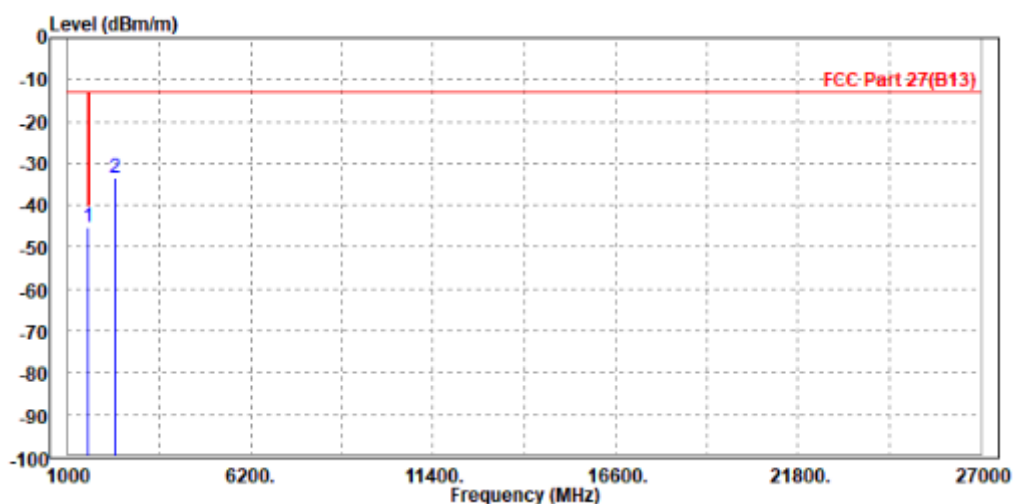



**BUREAU
VERITAS**

Test Report No.: W7L-P22080014RF03

MODE	TX channel 23205	FREQUENCY RANGE	Above 1000MHz
ENVIRONMENTAL CONDITIONS	23deg. C, 70%RH	INPUT POWER	DC30V
TESTED BY	Jace Hu		
ANTENNA POLARITY & TEST DISTANCE: VERTICAL AT 3 M			

	Freq	Level	Read Level	Limit Line	Over Limit	Factor	Remark	Pol/Phase
	MHz	dBm/m	dBm	dBm/m	dB	dB/m		
1	PP 1559.000	-53.56	-53.95	-40.00	-13.56	0.39	Peak	Vertical
2	2326.000	-32.54	-37.01	-13.00	-19.54	4.47	Peak	Vertical

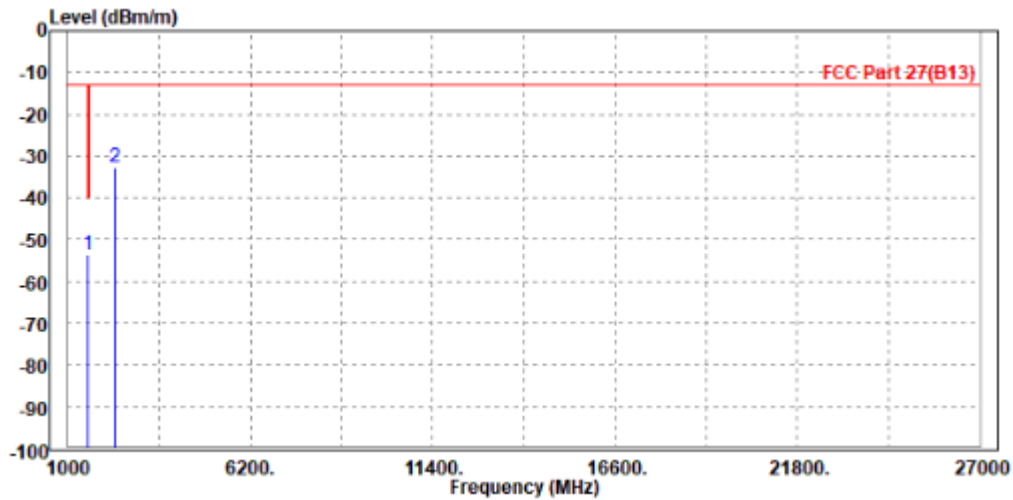



Test Report No.: W7L-P22080014RF03

CH23230

MODE	TX channel 23230	FREQUENCY RANGE	Above 1000MHz
ENVIRONMENTAL CONDITIONS	23deg. C, 70%RH	INPUT POWER	DC30V
TESTED BY	Jace Hu		
ANTENNA POLARITY & TEST DISTANCE: HORIZONTAL AT 3 M			

	Freq	Level	Read Level	Limit Line	Over Limit	Factor	Remark	Pol/Phase
	MHz	dBm/m	dBm	dBm/m	dB	dB/m		
1	PP 1564.000	-45.35	-45.45	-40.00	-5.35	0.10	Peak	Horizontal
2	2352.000	-24.67	-29.57	-13.00	-11.67	4.90	Peak	Horizontal

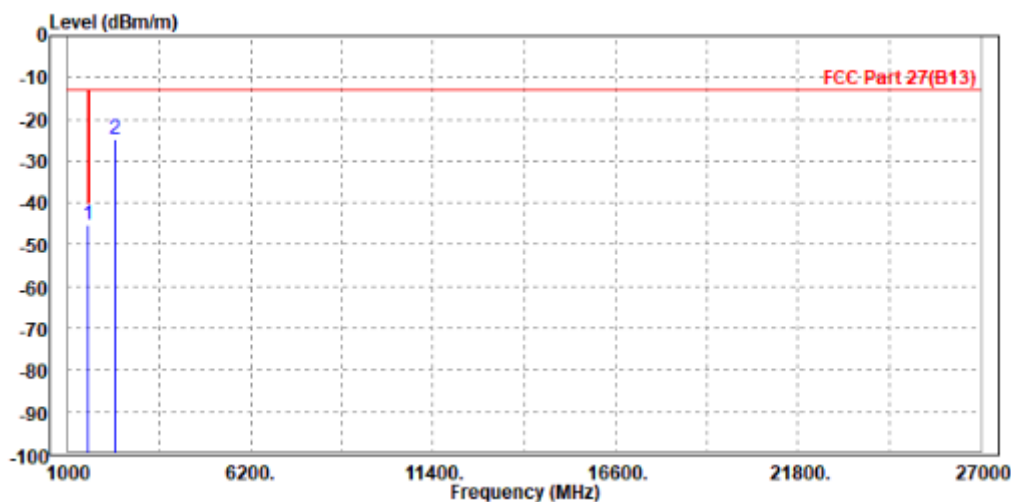



Test Report No.: W7L-P22080014RF03

MODE	TX channel 23230	FREQUENCY RANGE	Above 1000MHz
ENVIRONMENTAL CONDITIONS	23deg. C, 70%RH	INPUT POWER	DC30V
TESTED BY	Jace Hu		
ANTENNA POLARITY & TEST DISTANCE: VERTICAL AT 3 M			

	Freq	Level	Read Level	Limit Line	Over Limit	Factor	Remark	Pol/Phase
	MHz	dBm/m	dBm	dBm/m	dB	dB/m		
1	PP 1572.000	-55.55	-56.04	-40.00	-15.55	0.49	Peak	Vertical
2	2346.000	-33.99	-38.51	-13.00	-20.99	4.52	Peak	Vertical

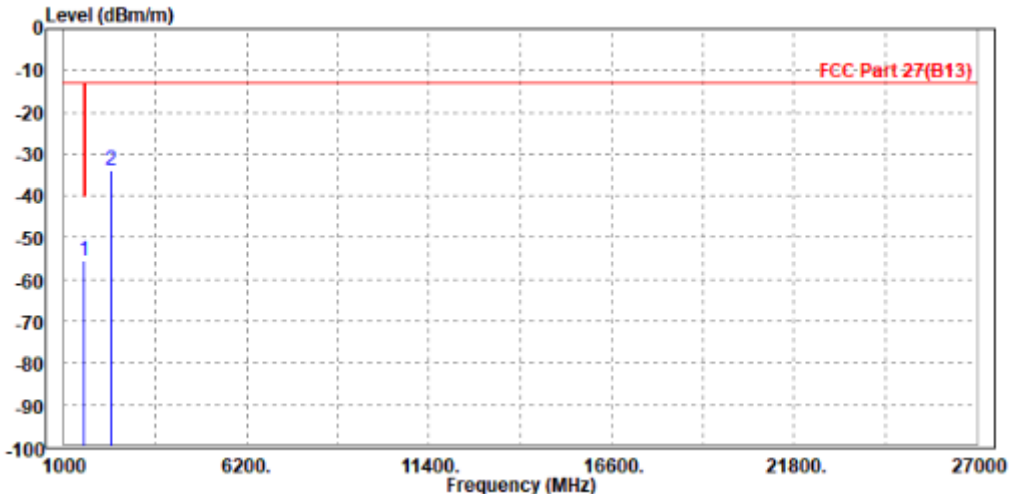



Test Report No.: W7L-P22080014RF03

CH23255

MODE	TX channel 23255	FREQUENCY RANGE	Above 1000MHz
ENVIRONMENTAL CONDITIONS	23deg. C, 70%RH	INPUT POWER	DC30V
TESTED BY	Jace Hu		
ANTENNA POLARITY & TEST DISTANCE: HORIZONTAL AT 3 M			

	Freq	Level	Read Level	Limit Line	Over Limit	Factor	Remark	Pol/Phase
	MHz	dBm/m	dBm	dBm/m	dB	dB/m		
1	PP 1569.000	-43.51	-43.65	-40.00	-3.51	0.14	Peak	Horizontal
2	2352.000	-28.65	-33.55	-13.00	-15.65	4.90	Peak	Horizontal

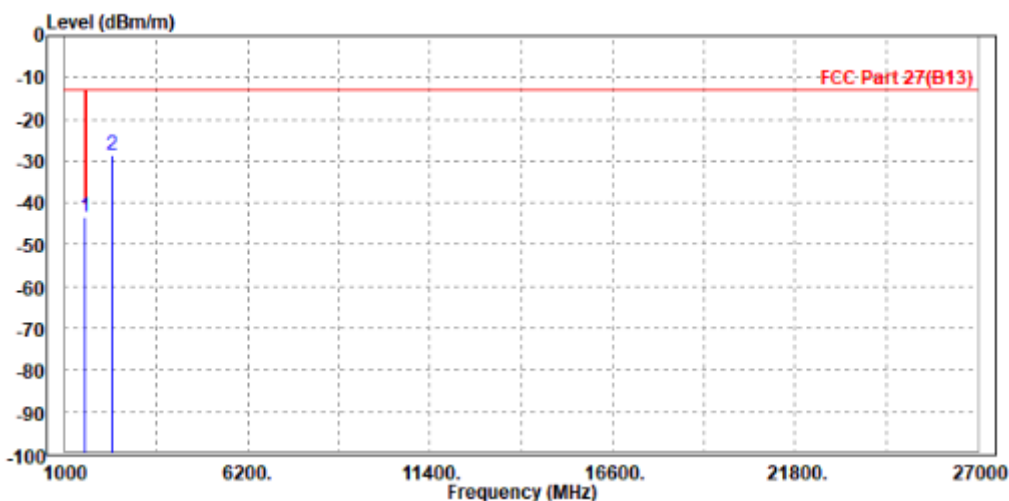



Test Report No.: W7L-P22080014RF03

MODE	TX channel 23255	FREQUENCY RANGE	Above 1000MHz
ENVIRONMENTAL CONDITIONS	23deg. C, 70%RH	INPUT POWER	DC30V
TESTED BY	Jace Hu		
ANTENNA POLARITY & TEST DISTANCE: VERTICAL AT 3 M			

	Freq	Level	Read Level	Limit Line	Over Limit	Factor	Remark	Pol/Phase
	MHz	dBm/m	dBm	dBm/m	dB	dB/m		
1	PP 1572.000	-54.37	-54.86	-40.00	-14.37	0.49	Peak	Vertical
2	2352.000	-31.19	-35.73	-13.00	-18.19	4.54	Peak	Vertical

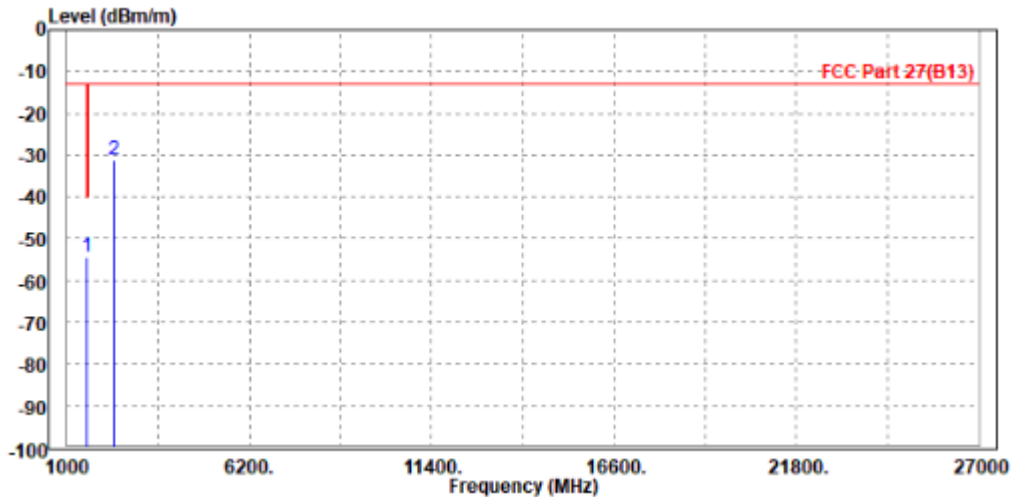



Test Report No.: W7L-P22080014RF03

CHANNEL BANDWIDTH: 10MHz /QPSK

CH23230

MODE	TX channel 23230	FREQUENCY RANGE	Above 1000MHz
ENVIRONMENTAL CONDITIONS	23deg. C, 70%RH	INPUT POWER	DC30V
TESTED BY	Jace Hu		
ANTENNA POLARITY & TEST DISTANCE: HORIZONTAL AT 3 M			

	Freq	Level	Read Level	Limit Line	Over Limit	Factor	Remark	Pol/Phase
	MHz	dBm/m	dBm	dBm/m	dB	dB/m		
1 PP	1564.000	-48.16	-48.26	-40.00	-8.16	0.10	Peak	Horizontal
2	2352.000	-36.04	-40.94	-13.00	-23.04	4.90	Peak	Horizontal

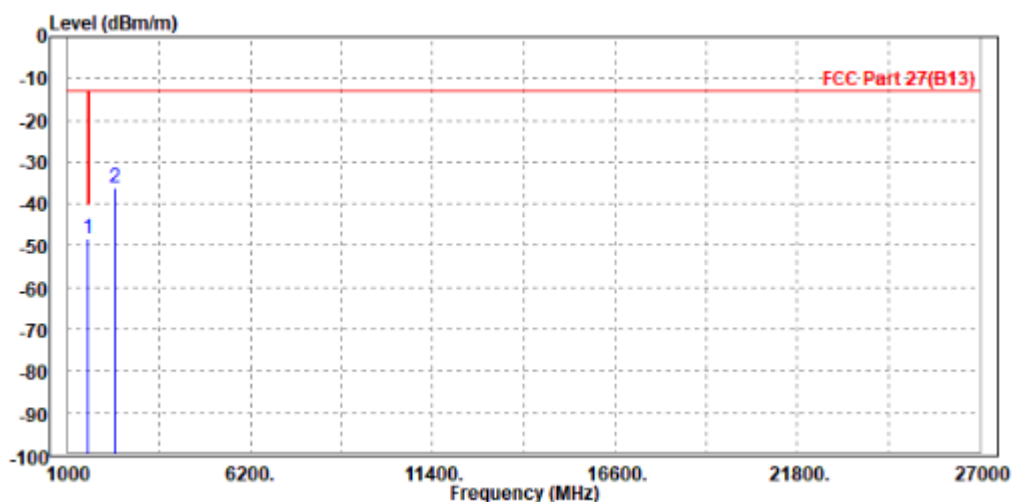



Test Report No.: W7L-P22080014RF03

MODE	TX channel 23230	FREQUENCY RANGE	Above 1000MHz
ENVIRONMENTAL CONDITIONS	23deg. C, 70%RH	INPUT POWER	DC30V
TESTED BY	Jace Hu		
ANTENNA POLARITY & TEST DISTANCE: VERTICAL AT 3 M			

	Freq	Level	Read Level	Limit Line	Over Limit	Factor	Remark	Pol/Phase
	MHz	dBm/m	dBm	dBm/m	dB	dB/m		
1	PP 1572.000	-58.04	-58.53	-40.00	-18.04	0.49	Peak	Vertical
2	2346.000	-34.87	-39.39	-13.00	-21.87	4.52	Peak	Vertical

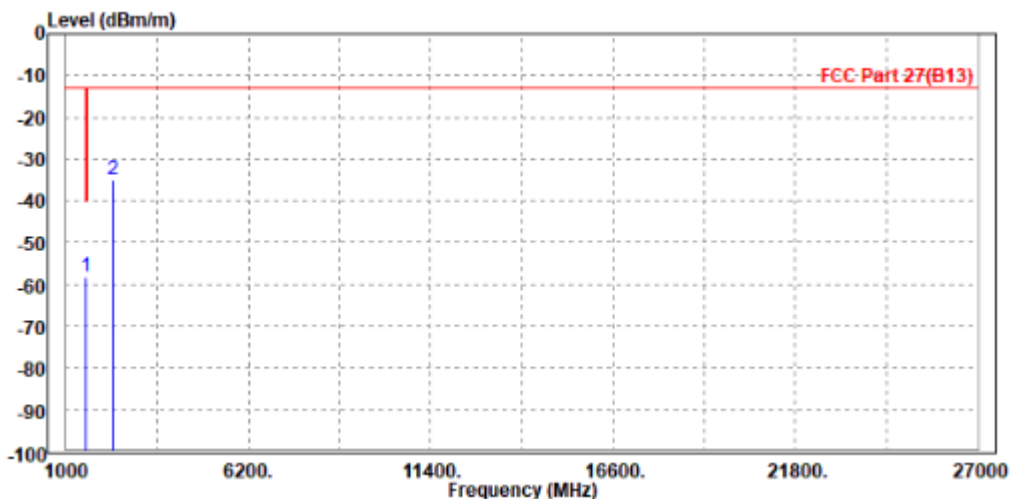

3.7 PEAK TO AVERAGE RATIO

3.7.1 LIMITS OF PEAK TO AVERAGE RATIO MEASUREMENT

In measuring transmissions in this band using an average power technique, the peak to-average ratio (PAR) of the transmission may not exceed 13 dB

3.7.2 TEST SETUP

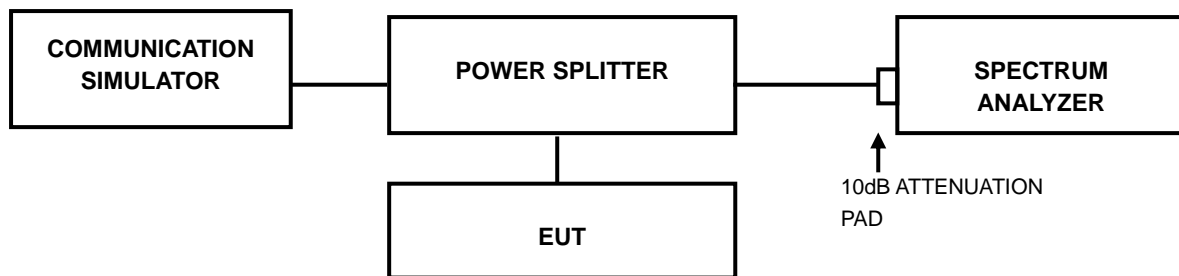

3.7.3 TEST PROCEDURES

1. Set resolution/measurement bandwidth \geq signal's occupied bandwidth;
2. Set the number of counts to a value that stabilizes the measured CCDF curve;
3. Record the maximum PAPR level associated with a probability of 0.1%.



Test Report No.: W7L-P22080014RF03

3.7.4 TEST RESULTS

Please Refer to Module report R2007A0435-R6.



Test Report No.: W7L-P22080014RF03

4 INFORMATION ON THE TESTING LABORATORIES

We, BV 7LAYERS COMMUNICATIONS TECHNOLOGY (SHENZHEN) CO. LTD., were founded in 2015 to provide our best service in EMC, Radio, Telecom and Safety consultation. Our laboratories are accredited and approved according to ISO/IEC 17025.

If you have any comments, please feel free to contact us at the following:

Shenzhen EMC/RF Lab:

Tel: +86-755-88696566

Fax: +86-755-88696577

Email: customerservice.sw@bureauveritas.com

Web Site: www.adt.com.tw

The address and road map of all our labs can be found in our web site also.



Test Report No.: W7L-P22080014RF03

5 MODIFICATIONS RECORDERS FOR ENGINEERING CHANGES TO THE EUT BY THE LAB

No any modifications are made to the EUT by the lab during the test.

---END---