



Test Report No.: W7L-P22080014RF01



FCC TEST REPORT (PART 22)

Applicant:	Particle Industries, Inc
Address:	325 9th Street, San Francisco, CA 94103, United States Of America

Manufacturer or Supplier:	Particle Industries, Inc
Address:	325 9th Street, San Francisco, CA 94103, United States Of America
Product:	TC-3
Brand Name:	FarmHQ
Model Name:	MON404-CODA
FCC ID:	2AEMI-CODA
Date of tests:	Aug. 15, 2022 ~ Sep. 26, 2022

The tests have been carried out according to the requirements of the following standard:

- FCC PART 22, Subpart H
- ANSI/TIA/EIA-603-D
- ANSI/TIA/EIA-603-E
- FCC Part 2
- ANSI C63.26-2015

CONCLUSION: The submitted sample was found to COMPLY with the test requirement

Prepared by Simon Wang Engineer / Mobile Department	Approved by Luke Lu Manager / Mobile Department
Date: Sep. 26, 2022	Date: Sep. 26, 2022

This report is governed by, and incorporates by reference, the Conditions of Testing as posted at the date of issuance of this report at <http://www.bureauveritas.com/home/about-us/our-business/cps/about-us/terms-conditions/> and is intended for your exclusive use. Any copying or replication of this report to or for any other person or entity, or use of our name or trademark, is permitted only with our prior written permission. This report sets forth our findings solely with respect to the test samples identified herein. The results set forth in this report are not indicative or representative of the quality or characteristics of the lot from which a test sample was taken or any similar or identical product unless specifically and expressly noted. Our report includes all of the tests requested by you and the results thereof based upon the information that you provided to us. Measurement uncertainty is only provided upon request for accredited tests. Statements of conformity are based on simple acceptance criteria without taking measurement uncertainty into account, unless otherwise requested in writing. You have 60 days from date of issuance of this report to notify us of any material error or omission caused by our negligence or if you require measurement uncertainty; provided, however, that such notice shall be in writing and shall specifically address the issue you wish to raise. A failure to raise such issue within the prescribed time shall constitute your unqualified acceptance of the completeness of this report, the tests conducted and the correctness of the report contents.



TABLE OF CONTENTS

RELEASE CONTROL RECORD4

1 SUMMARY OF TEST RESULTS.....5

1.1 MEASUREMENT UNCERTAINTY5

1.2 TEST SITE AND INSTRUMENTS6

2 GENERAL INFORMATION7

2.1 GENERAL DESCRIPTION OF EUT7

2.2 CONFIGURATION OF SYSTEM UNDER TEST9

2.3 DESCRIPTION OF SUPPORT UNITS10

2.4 TEST ITEM AND TEST CONFIGURATION.....10

2.5 EUT OPERATING CONDITIONS13

2.6 GENERAL DESCRIPTION OF APPLIED STANDARDS14

3 TEST TYPES AND RESULTS.....15

3.1 OUTPUT POWER MEASUREMENT15

3.1.1 LIMITS OF OUTPUT POWER MEASUREMENT15

3.1.2 TEST PROCEDURES15

3.1.3 TEST SETUP16

3.1.4 TEST RESULTS16

3.2 FREQUENCY STABILITY MEASUREMENT22

3.2.1 LIMITS OF FREQUENCY STABILITY MEASUREMENT22

3.2.2 TEST PROCEDURE22

3.2.3 TEST SETUP22

3.2.4 TEST RESULTS23

3.3 OCCUPIED BANDWIDTH MEASUREMENT31

3.3.1 LIMITS OF OCCUPIED BANDWIDTH MEASUREMENT31

3.3.2 TEST SETUP31

3.3.3 TEST PROCEDURES31

3.3.4 TEST RESULTS32

3.4 BAND EDGE MEASUREMENT33

3.4.1 LIMITS OF BAND EDGE MEASUREMENT33

3.4.2 TEST SETUP33

3.4.3 TEST PROCEDURES34

3.4.4 TEST RESULTS35

3.5 CONDUCTED SPURIOUS EMISSIONS.....36

3.5.1 LIMITS OF CONDUCTED SPURIOUS EMISSIONS MEASUREMENT36

3.5.2 TEST PROCEDURE36

3.5.3 TEST SETUP36

3.5.4 TEST RESULTS37

3.6 RADIATED EMISSION MEASUREMENT38

3.6.1 LIMITS OF RADIATED EMISSION MEASUREMENT38

3.6.2 TEST PROCEDURES38

3.6.3 DEVIATION FROM TEST STANDARD38



**BUREAU
VERITAS**

Test Report No.: W7L-P22080014RF01

3.6.4	TEST SETUP	39
3.6.5	TEST RESULTS	41
3.7	PEAK TO AVERAGE RATIO	69
3.7.1	LIMITS OF PEAK TO AVERAGE RATIO MEASUREMENT	69
3.7.2	TEST SETUP	69
3.7.3	TEST PROCEDURES	69
3.7.4	TEST RESULTS	70
4	PHOTOGRAPHS OF THE TEST CONFIGURATION	71
5	INFORMATION ON THE TESTING LABORATORIES	72
6	MODIFICATIONS RECORDERS FOR ENGINEERING CHANGES TO THE EUT BY THE LAB	73



BUREAU
VERITAS

Test Report No.: W7L-P22080014RF01

RELEASE CONTROL RECORD

ISSUE NO.	REASON FOR CHANGE	DATE ISSUED
W7L- P22080014RF01	Original release	Sep. 26, 2022



1 SUMMARY OF TEST RESULTS

The EUT has been tested according to the following specifications:

APPLIED STANDARD: FCC Part 22 & Part 2		
STANDARD SECTION	TEST TYPE	RESULT
§2.1046	Conducted Output Power	Compliance
§22.913 (a)(5)	Effective Radiated Power	Compliance
§2.1055 §22.355	Frequency Stability	Compliance
§2.1049	Occupied Bandwidth	See Note
§22.913 (d)	Peak to average ratio*	See Note
§22.917(a)	Band Edge Measurements	See Note
§2.1051 §22.917(a)	Conducted Spurious Emissions	See Note
§2.1053 §22.917(a)	Radiated Spurious Emissions	Compliance

* Refer to KDB 971168 D01 Power Meas License Digital Systems v03r01.

NOTE: Refer to Module report R2007A0435-R4, FCC ID: XMR201707BG96.

1.1 MEASUREMENT UNCERTAINTY

Where relevant, the following measurement uncertainty levels have been estimated for tests performed on the EUT as specified in CISPR 16-4-2:

MEASUREMENT	UNCERTAINTY
Maximum Peak Output Power	±2.06dB
Frequency Stability	±76.97Hz
Radiated emissions (9KHz~30MHz)	±2.68dB
Radiated emissions (30MHz~1GMHz)	±4.98dB
Radiated emissions (1GMHz ~6GMHz)	±4.70dB
Radiated emissions (6GMHz ~18GMHz)	±4.60dB
Radiated emissions (18GMHz ~40GMHz)	±4.12dB
Conducted emissions	±4.01dB
Occupied Channel Bandwidth	±43.58KHz
Band Edge Measurements	±4.70dB
Peak to average ratio	±0.76dB



This uncertainty represents an expanded uncertainty expressed at approximately the 95% confidence level using a coverage factor of k=2.

1.2 TEST SITE AND INSTRUMENTS

Equipment	Manufacturer	Model No.	Serial No.	Last Cal.	Next Cal.
MXE EMI Receiver	KEYSIGHT	N9038A-544	MY54450026	Feb. 18,22	Feb. 17,23
EXA Signal Analyzer	KEYSIGHT	N9010A-544	MY54510355	May.15,22	May.14,23
Loop Antenna	Schwarzbeck	FMZB 1519B	00173	Sep.05,21	Sep.04,22
Loop Antenna	Schwarzbeck	FMZB 1519B	00173	Sep.04,22	Sep.03,23
Bilog Antenna	ETS-LINDGRE N	3143B	00161965	Mar. 06,22	Mar. 05,23
Horn Antenna	ETS-LINDGRE N	3117	00168692	Mar. 06,22	Mar. 05,23
Horn Antenna (18GHz-40GHz)	N/A	QWH-SL-18-40-K- SG/QMS-00361	15433	Aug. 25, 21	Aug. 24, 22
Horn Antenna (18GHz-40GHz)	N/A	QWH-SL-18-40-K- SG/QMS-00361	15433	Aug. 24, 22	Aug. 23, 23
Radio Communication Analyzer	ANRITSU	MT8820C	6201465426	Feb. 15,22	Feb. 14,23
Signal Pre-Amplifier	EMSI	EMC 9135	980249	May.12,22	May.11,23
Signal Pre-Amplifier	EMSI	EMC 012645B	980257	May.12,22	May.11,23
Signal Pre-Amplifier	EMSI	EMC 184045B	980259	Feb. 21,22	Feb.20,23
3m Semi-anechoic Chamber	ETS-LINDGRE N	9m*6m*6m	Euroshieldpn- CT0001143-121 6	May. 19,20	May. 18,23
Test Software	E3	V 9.160323	N/A	N/A	N/A
Test Software	JS1120	3.1.36	N/A	N/A	N/A
10dB Attenuator	JFW/USA	50HF-010-SMA	1505	May. 07,22	May. 06,23
Power Meter	Anritsu	ML2495A	1506002	Feb. 22,22	Feb. 21,23
Power Sensor	Anritsu	MA2411B	1339352	May. 07,22	May. 06,23
Temperature Chamber	ESPEC	SH-242	93000855	May. 12,22	May. 11,23
MXG Analog Microwave Signal Generator	KEYSIGHT	N5183A	MY50143024	Feb. 18,22	Feb. 17,23
Base station R&S CMW500	Rohde&Schwa rz	CMW500	153085	May.12,22	May.11,23
DC Source	Agilent	U8002A	64827	May. 07,22	May. 06,23

- NOTE:**
1. The calibration interval of the above test instruments is 12 months or 36 months and the calibrations are traceable to CEPREI/CHINA, GRGT/CHINA and NIM/CHINA.
 2. The test was performed in 3m Semi-anechoic Chamber and RF Oven Room.
 3. The horn antenna is used only for the measurement of emission frequency above 1GHz if tested.
 4. The FCC Site Registration No. is 525120; The Designation No. is CN1171.



2 GENERAL INFORMATION

2.1 GENERAL DESCRIPTION OF EUT

PRODUCT	TC-3	
BRAND NAME	FarmHQ	
MODEL NAME	MON404-CODA	
NOMINAL VOLTAGE	30Vdc (DC Source) 3.7Vdc (Li-ion, battery)	
MODULATION TYPE	LTE	QPSK, 16QAM
FREQUENCY RANGE	LTE Band 5 (Channel Bandwidth: 1.4MHz)	824.7MHz ~ 848.3MHz
	LTE Band 5 (Channel Bandwidth: 3MHz)	825.5MHz ~ 847.5MHz
	LTE Band 5 (Channel Bandwidth: 5MHz)	826.5MHz~ 846.5MHz
	LTE Band 5 (Channel Bandwidth: 10MHz)	829MHz ~ 844MHz
MAX. ERP POWER	LTE Band 5 (Channel Bandwidth: 1.4MHz)	181.13mW
	LTE Band 5 (Channel Bandwidth: 3MHz)	181.13mW
	LTE Band 5 (Channel Bandwidth: 5MHz)	181.13mW
	LTE Band 5 (Channel Bandwidth: 10MHz)	182.39mW
EMISSION DESIGNATOR GOGN	LTE Band 5 (Channel Bandwidth: 1.4MHz)	QPSK: 1M11G7D
		16QAM: 947KW7D
	LTE Band 5 (Channel Bandwidth: 3MHz)	QPSK: 1M16G7D
		16QAM: 983KW7D
LTE Band 5 (Channel Bandwidth: 5MHz)	QPSK: 1M15G7D	
	16QAM: 1M01G7D	
LTE Band 5 (Channel Bandwidth: 10MHz)	QPSK: 1M20G7D	
	16QAM: 1M05G7D	
ANTENNA TYPE	Internal Antenna with 1.7dBi gain for LTE B5 Magnet Mount Antenna with -0.17dBi gain for LTE B5	
HW VERSION	v1.2.0	
SW VERSION	v3.3.0	
I/O PORTS	Refer to user's manual	
CABLE SUPPLIED	N/A	
EXTREME TEMPERATURE	-40-85 °C	
EXTREME VOLTAGE	Battery 3.6V - 4.2V	



EXTREME VOLTAGE	DC 8 V-48 V
------------------------	-------------

NOTE:

1. For a more detailed features description, please refer to the manufacturer’s specifications or the user's manual.
2. The EUT incorporates a SISO function. Physically, the EUT provides one completed transmitter and one receiver.

MODULATION MODE	TX FUNCTION
LTE	1TX/1RX

3. For the test results, the EUT had been tested with all conditions. But only the worst case was shown in test report.

List of Accessory:

ACCESSORIES	BRAND	MANUFACTURER	MODEL	SPECIFICATION
Battery		Guang Dong Zhao Neng Technology Co.,Ltd	18650-4P	Capacity: 3.7Vdc, 11800mAh



2.2 CONFIGURATION OF SYSTEM UNDER TEST FOR RADIATION EMISSION

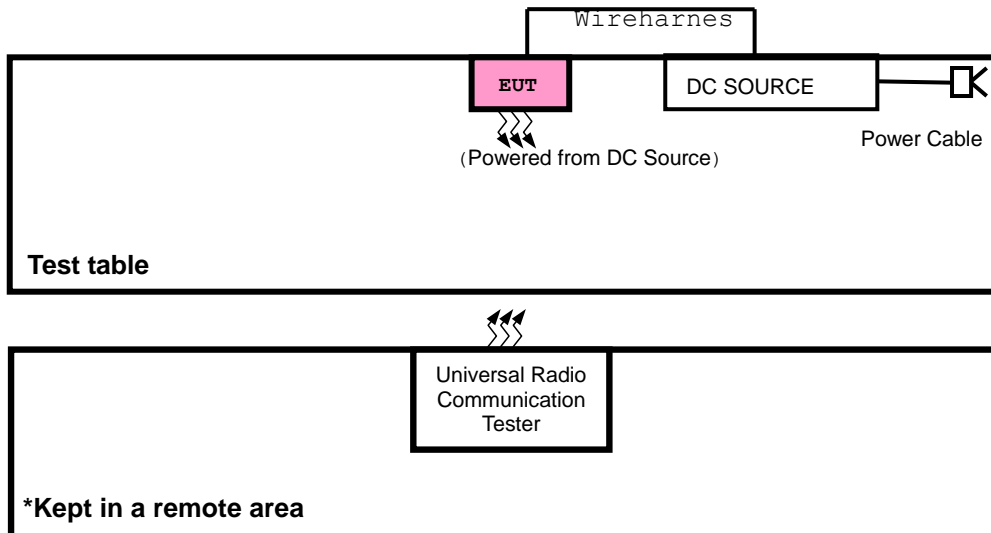



2.3 DESCRIPTION OF SUPPORT UNITS

The EUT has been tested as an independent unit together with other necessary accessories or support units. The following support units or accessories were used to form a representative test configuration during the tests.

NO.	PRODUCT	BRAND	MODEL NO.	SERIAL NO.	FCC ID
1	DC source	Agilent	U8002A	N/A	N/A
2	Power Cable	N/A	N/A	N/A	N/A

NO.	SIGNAL CABLE DESCRIPTION OF THE ABOVE SUPPORT UNITS
1	Wireharness - 4PH

2.4 TEST ITEM AND TEST CONFIGURATION

Pre-Scan has been conducted to determine the worst-case mode from all possible combinations between available modulations, data rates, XYZ axis and antenna ports. The worst case in EIRP and radiated emission was found when positioned on X-plane for LTE. Following channel(s) was (were) selected for the final test as listed below, pre-scan A and B mode, worst case is A mode and only Frequency Stability embody two sets of data, other data embody mode A:

EUT CONFIGURE MODE	DESCRIPTION
A	EUT + DC Source with LTE link
B	EUT+Battery with LTE link



LTE BAND 5 MODE

EUT CONFIGURE MODE	TEST ITEM	Available Channel	Tested Channel	Channel bandwidth	modulation	mode
A/B	ERP	20407 to 20643	20407, 20525, 20643	1.4MHz	QPSK,16QAM	1 RB / 0 RB Offset
		20415 to 20635	20415, 20525, 20635	3MHz	QPSK,16QAM	1 RB / 0 RB Offset
		20425 to 20625	20425, 20525, 20625	5MHz	QPSK,16QAM	1 RB / 0 RB Offset
		20450 to 20600	20450, 20525, 20600	10MHz	QPSK,16QAM	1 RB / 0 RB Offset
A/B	FREQUENCY STABILITY	20407 to 20643	20407, 20525, 20643	1.4MHz	QPSK,16QAM	6 RB / 0 RB Offset
		20415 to 20635	20415, 20525, 20635	3MHz	QPSK,16QAM	6 RB / 0 RB Offset
		20425 to 20625	20425, 20525, 20625	5MHz	QPSK,16QAM	6 RB / 0 RB Offset
		20450 to 20600	20450, 20525, 20600	10MHz	QPSK,16QAM	6 RB / 0 RB Offset
		20415 to 20635	20415, 20525, 20635	3MHz	QPSK,16QAM	6 RB / 0 RB Offset
		20425 to 20625	20425, 20525, 20625	5MHz	QPSK,16QAM	6 RB / 0 RB Offset
		20450 to 20600	20450, 20525, 20600	10MHz	QPSK,16QAM	6 RB / 0 RB Offset



A/B	RADIATED EMISSION	20407 to 20643	20525	1.4MHz	QPSK	1 RB / 0 RB Offset
		20415 to 20635	20525	3MHz	QPSK	1 RB / 0 RB Offset
		20425 to 20625	20525	5MHz	QPSK	1 RB / 0 RB Offset
		20450 to 20600	20450, 20525, 20600	10MHz	QPSK	1 RB / 0 RB Offset

Note: This device was tested under all bandwidths, RB configurations and modulations. The worst case was found in QPSK modulation.



TEST CONDITION:

TEST ITEM	ENVIRONMENTAL CONDITIONS	INPUT POWER	TESTED BY
ERP	23deg. C, 70%RH	DC 30V By DC Source	Jace Hu
FREQUENCY STABILITY	23deg. C, 70%RH	DC30V By DC Source 3.7V By Battery	James Fu
RADIATED EMISSION	23deg. C, 70%RH	DC 30V DC Source	Jace Hu

2.5 EUT OPERATING CONDITIONS

The EUT makes a call to the communication simulator. The communication simulator station system controlled a EUT to export maximum output power under transmission mode and specific channel frequency



**BUREAU
VERITAS**

Test Report No.: W7L-P22080014RF01

2.6 GENERAL DESCRIPTION OF APPLIED STANDARDS

The EUT is a RF product. According to the specifications of the manufacturer, it must comply with the requirements of the following standards:

FCC 47 CFR Part 2

FCC 47 CFR Part 22

KDB 971168 D01 Power Meas License Digital Systems v03r01

ANSI/TIA/EIA-603-D

ANSI/TIA/EIA-603-E

ANSI C63.26-2015

NOTE: All test items have been performed and recorded as per the above standards.



3 TEST TYPES AND RESULTS

3.1 OUTPUT POWER MEASUREMENT

3.1.1 LIMITS OF OUTPUT POWER MEASUREMENT

Mobile / Portable station are limited to 7 watts e.r.p.

3.1.2 TEST PROCEDURES

EIRP / ERP MEASUREMENT:

Per KDB 971168 D01 Power Meas License Digital Systems v03r01 or subclause 5.2.5.5 of ANSI C63.26-2015, the relevant equation for determining the ERP or EIRP from the conducted RF output power measured using the guidance provided above is:

$$\text{ERP or EIRP} = P_{\text{Meas}} + G_{\text{T}} - L_{\text{C}}$$

Where:

ERP or EIRP = effective radiated power or equivalent isotropically radiated power, respectively

(expressed in the same units as P_{Meas} , typically dBW or dBm);

P_{Meas} = measured transmitter output power or PSD, in dBm or dBW;

G_{T} = gain of the transmitting antenna, in dBd (ERP) or dBi (EIRP);

L_{C} = signal attenuation in the connecting cable between the transmitter and antenna, in dB.

CONDUCTED POWER MEASUREMENT:

The EUT was set up for the maximum power with WCDMA link data modulation and link up with simulator. Set the EUT to transmit under low, middle and high channel and record the power level shown on simulator.



3.1.3 TEST SETUP

NOTE: Pre-scan battery supply and DC SOURCE, Worse case is DC SOURCE
EIRP / ERP Measurement:

CONDUCTED POWER MEASUREMENT:

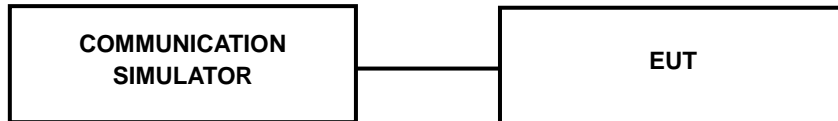

3.1.4 TEST RESULTS

CONDUCTED OUTPUT POWER (dBm)

LTE Band 5

Band/BW	Modulation	RB Size	RB Offset	Low CH 20407	Mid CH 20525	High CH 20643
				Frequency 824.7 MHz	Frequency 836.5 MHz	Frequency 848.3 MHz
5/ 1.4	QPSK	1	0	22.96	23.00	22.92
		1	5	22.80	22.92	22.81
		3	0	22.84	22.92	22.86
		3	3	22.82	23.02	22.86
		6	0	22.85	22.85	22.86
	16QAM	1	0	22.85	22.98	22.84
		1	5	22.76	22.89	22.79
		3	0	22.79	22.90	22.82
		3	3	22.86	23.03	22.86
		6	0	22.69	22.80	22.77

Band/BW	Modulation	RB Size	RB Offset	Low CH 20415	Mid CH 20525	High CH 20635
				Frequency 825.5 MHz	Frequency 836.5 MHz	Frequency 847.5 MHz
5/ 3	QPSK	1	0	22.91	22.99	22.89
		1	5	22.78	22.94	22.84
		3	0	22.84	22.92	22.83
		3	3	22.82	23.02	22.89
		6	0	22.84	22.85	22.83
	16QAM	1	0	22.89	22.92	22.88
		1	5	22.75	22.90	22.76
		3	0	22.81	22.88	22.88
		3	3	22.91	23.03	22.84
		6	0	22.69	22.80	22.72



Band/BW	Modulation	RB Size	RB Offset	Low CH 20425	Mid CH 20525	High CH 20625
				Frequency 826.5 MHz	Frequency 836.5 MHz	Frequency 846.5 MHz
5/ 5	QPSK	1	0	22.93	23.01	22.89
		1	5	22.77	22.98	22.81
		3	0	22.81	22.92	22.89
		3	3	22.82	23.01	22.86
		6	0	22.87	22.82	22.85
	16QAM	1	0	22.83	22.94	22.81
		1	5	22.77	22.92	22.75
		3	0	22.80	22.91	22.88
		3	3	22.84	23.03	22.86
		6	0	22.66	22.87	22.76

Band/BW	Modulation	RB Size	RB Offset	Low CH 20450	Mid CH 20525	High CH 20600
				Frequency 829 MHz	Frequency 836.5 MHz	Frequency 844 MHz
5/ 10	QPSK	1	0	22.97	23.06	22.94
		1	5	22.85	22.99	22.86
		3	0	22.88	22.97	22.91
		3	3	22.90	23.03	22.91
		6	0	22.89	22.90	22.87
	16QAM	1	0	22.91	23.00	22.89
		1	5	22.83	22.94	22.81
		3	0	22.87	22.96	22.90
		3	3	22.92	23.05	22.92
		6	0	22.74	22.88	22.78



ERP POWER (dBm)

Internal Antenna:

LTE BAND 5

CHANNEL BANDWIDTH: 1.4MHz QPSK

Channel	Frequency (MHz)	Conducted Power (dBm)	G _T -L _C (dB)	ERP (dBm)	ERP (mW)	Limit (W)
20407	824.7	22.96	1.7	22.51	178.24	7
20525	836.5	23.02	1.7	22.57	180.72	7
20643	848.3	22.92	1.7	22.47	176.6	7

CHANNEL BANDWIDTH: 1.4MHz 16QAM

Channel	Frequency (MHz)	Conducted Power (dBm)	G _T -L _C (dB)	ERP (dBm)	ERP (mW)	Limit (W)
20407	824.7	22.86	1.7	22.41	174.18	7
20525	836.5	23.03	1.7	22.58	181.13	7
20643	848.3	22.86	1.7	22.41	174.18	7

CHANNEL BANDWIDTH: 3MHz QPSK

Channel	Frequency (MHz)	Conducted Power (dBm)	G _T -L _C (dB)	ERP (dBm)	ERP (mW)	Limit (W)
20415	825.5	22.91	1.7	22.46	176.2	7
20525	836.5	23.02	1.7	22.57	180.72	7
20635	847.5	22.89	1.7	22.44	175.39	7

CHANNEL BANDWIDTH: 3MHz 16QAM

Channel	Frequency (MHz)	Conducted Power (dBm)	G _T -L _C (dB)	ERP (dBm)	ERP (mW)	Limit (W)
20415	825.5	22.91	1.7	22.46	176.2	7
20525	836.5	23.03	1.7	22.58	181.13	7
20635	847.5	22.88	1.7	22.43	174.98	7



CHANNEL BANDWIDTH: 5MHz QPSK

Channel	Frequency (MHz)	Conducted Power (dBm)	G _{T-Lc} (dB)	ERP (dBm)	ERP (mW)	Limit (W)
20425	826.5	22.93	1.7	22.48	177.01	7
20525	836.5	23.01	1.7	22.56	180.3	7
20625	846.5	22.89	1.7	22.44	175.39	7

CHANNEL BANDWIDTH: 5MHz 16QAM

Channel	Frequency (MHz)	Conducted Power (dBm)	G _{T-Lc} (dB)	ERP (dBm)	ERP (mW)	Limit (W)
20425	826.5	22.84	1.7	22.39	173.38	7
20525	836.5	23.03	1.7	22.58	181.13	7
20625	846.5	22.88	1.7	22.43	174.98	7

CHANNEL BANDWIDTH: 10MHz QPSK

Channel	Frequency (MHz)	Conducted Power (dBm)	G _{T-Lc} (dB)	ERP (dBm)	ERP (mW)	Limit (W)
20450	829.0	22.97	1.7	22.52	178.65	7
20525	836.5	23.06	1.7	22.61	182.39	7
20600	844.0	22.94	1.7	22.49	177.42	7

CHANNEL BANDWIDTH: 10MHz 16QAM

Channel	Frequency (MHz)	Conducted Power (dBm)	G _{T-Lc} (dB)	ERP (dBm)	ERP (mW)	Limit (W)
20450	829.0	22.92	1.7	22.47	176.6	7
20525	836.5	23.05	1.7	22.6	181.97	7
20600	844.0	22.92	1.7	22.47	176.6	7

REMARKS: ERP Output Power (dBm) = EIRP (dBm) -2.15(dB).



Magnet Mount Antenna:

LTE BAND 5

CHANNEL BANDWIDTH: 1.4MHz QPSK

Channel	Frequency (MHz)	Conducted Power (dBm)	G _T -L _c (dB)	ERP (dBm)	ERP (mW)	Limit (W)
20407	824.7	22.96	-0.17	20.64	115.88	7
20525	836.5	23.02	-0.17	20.7	117.49	7
20643	848.3	22.92	-0.17	20.6	114.82	7

CHANNEL BANDWIDTH: 1.4MHz 16QAM

Channel	Frequency (MHz)	Conducted Power (dBm)	G _T -L _c (dB)	ERP (dBm)	ERP (mW)	Limit (W)
20407	824.7	22.86	-0.17	20.54	113.24	7
20525	836.5	23.03	-0.17	20.71	117.76	7
20643	848.3	22.86	-0.17	20.54	113.24	7

CHANNEL BANDWIDTH: 3MHz QPSK

Channel	Frequency (MHz)	Conducted Power (dBm)	G _T -L _c (dB)	ERP (dBm)	ERP (mW)	Limit (W)
20415	825.5	22.91	-0.17	20.59	114.55	7
20525	836.5	23.02	-0.17	20.7	117.49	7
20635	847.5	22.89	-0.17	20.57	114.02	7

CHANNEL BANDWIDTH: 3MHz 16QAM

Channel	Frequency (MHz)	Conducted Power (dBm)	G _T -L _c (dB)	ERP (dBm)	ERP (mW)	Limit (W)
20415	825.5	22.91	-0.17	20.59	114.55	7
20525	836.5	23.03	-0.17	20.71	117.76	7
20635	847.5	22.88	-0.17	20.56	113.76	7



CHANNEL BANDWIDTH: 5MHz QPSK

Channel	Frequency (MHz)	Conducted Power (dBm)	G _T -L _C (dB)	ERP (dBm)	ERP (mW)	Limit (W)
20425	826.5	22.93	-0.17	20.61	115.08	7
20525	836.5	23.01	-0.17	20.69	117.22	7
20625	846.5	22.89	-0.17	20.57	114.02	7

CHANNEL BANDWIDTH: 5MHz 16QAM

Channel	Frequency (MHz)	Conducted Power (dBm)	G _T -L _C (dB)	ERP (dBm)	ERP (mW)	Limit (W)
20425	826.5	22.84	-0.17	20.52	112.72	7
20525	836.5	23.03	-0.17	20.71	117.76	7
20625	846.5	22.88	-0.17	20.56	113.76	7

CHANNEL BANDWIDTH: 10MHz QPSK

Channel	Frequency (MHz)	Conducted Power (dBm)	G _T -L _C (dB)	ERP (dBm)	ERP (mW)	Limit (W)
20450	829.0	22.97	-0.17	20.65	116.14	7
20525	836.5	23.06	-0.17	20.74	118.58	7
20600	844.0	22.94	-0.17	20.62	115.35	7

CHANNEL BANDWIDTH: 10MHz 16QAM

Channel	Frequency (MHz)	Conducted Power (dBm)	G _T -L _C (dB)	ERP (dBm)	ERP (mW)	Limit (W)
20450	829.0	22.92	-0.17	20.6	114.82	7
20525	836.5	23.05	-0.17	20.73	118.3	7
20600	844.0	22.92	-0.17	20.6	114.82	7

REMARKS: ERP Output Power (dBm) = EIRP (dBm) -2.15(dB).



3.2 FREQUENCY STABILITY MEASUREMENT

3.2.1 LIMITS OF FREQUENCY STABILITY MEASUREMENT

1.5 ppm is for base and fixed station. 2.5 ppm is for mobile station.

3.2.2 TEST PROCEDURE

- Device is placed at the oven room. The oven room could control the temperatures and humidity. Power warm up is at least 15 min and power applied should perform before recording frequency error.
- Connect the external power supply to the DC input power supply or battery power supply. The test voltage range is from minimum to maximum working voltage. Each step shall be record the frequency error rate.
- The temperature range step is 10 degrees in this test items. All temperature levels shall be hold the $\pm 0.5^{\circ}\text{C}$ during the measurement testing. The each temperature step shall be at least 0.5 hours, consider the EUT could be test under the stability condition.

NOTE: The frequency error was recorded frequency error from the communication simulator.

3.2.3 TEST SETUP

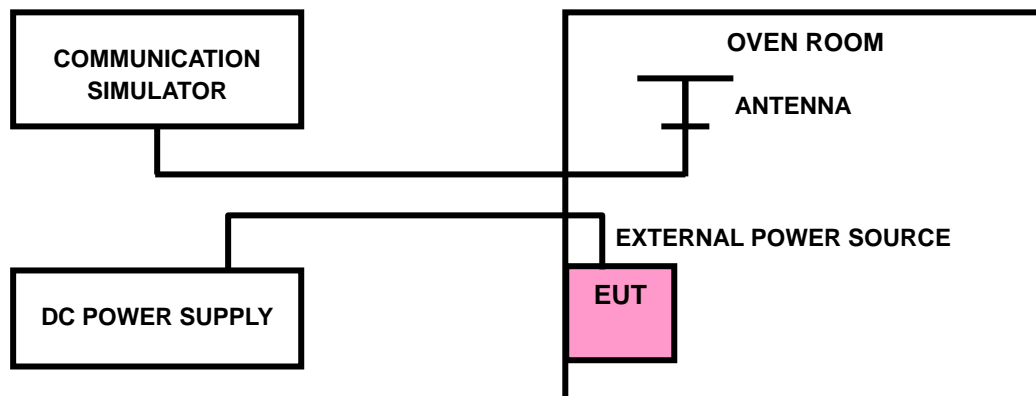



3.2.4 TEST RESULTS

Test EUT Configure mode A (battery) and EUT Configure mode B (DC SOURCE), Details as below:
LTE BAND 5 (BATTERY)

FREQUENCY ERROR VS. VOLTAGE

VOLTAGE (Volts)	1.4MHz		LIMIT (ppm)
	FREQUENCY ERROR (ppm)		
	Low Channel	High Channel	
$V_{nor(3.7V)}$	0.0024	0.0027	2.5
$V_{min(3.6V)}$	-0.0035	-0.0033	2.5
$V_{max(4.2V)}$	0.0023	0.0022	2.5

NOTE: The applicant defined the normal working voltage of the EUT is from V_{min} Vdc to V_{max} Vdc.

FREQUENCY ERROR vs. TEMPERATURE.

TEMP. (°C)	1.4MHz		LIMIT (ppm)
	FREQUENCY ERROR (ppm)		
	Low Channel	High Channel	
-40	-0.0110	-0.0176	2.5
-30	-0.0136	-0.0148	2.5
-20	-0.0121	-0.0122	2.5
-10	-0.0101	-0.0098	2.5
0	-0.0094	-0.0092	2.5
10	-0.0051	-0.0057	2.5
20	-0.0050	-0.0046	2.5
30	-0.0026	-0.0041	2.5
40	-0.0017	-0.0013	2.5
50	-0.0007	-0.0004	2.5
85	-0.0007	-0.0004	2.5



FREQUENCY ERROR VS. VOLTAGE

VOLTAGE (Volts)	3MHz		LIMIT (ppm)
	FREQUENCY ERROR (ppm)		
	Low Channel	High Channel	
$V_{nor(3.7V)}$	0.0024	0.0023	2.5
$V_{min(3.6V)}$	-0.0026	-0.0031	2.5
$V_{max(4.2V)}$	0.0021	0.0020	2.5

NOTE: The applicant defined the normal working voltage of the EUT is from V_{min} Vdc to V_{max} Vdc.

FREQUENCY ERROR vs. TEMPERATURE.

TEMP. (°C)	3MHz		LIMIT (ppm)
	FREQUENCY ERROR (ppm)		
	Low Channel	High Channel	
-40	-0.0104	-0.0136	2.5
-30	-0.0148	-0.0145	2.5
-20	-0.0129	-0.0125	2.5
-10	-0.0106	-0.0098	2.5
0	-0.0089	-0.0091	2.5
10	-0.0061	-0.0059	2.5
20	-0.0042	-0.0041	2.5
30	-0.0028	-0.0027	2.5
40	-0.0022	-0.0023	2.5
50	-0.0007	0.0000	2.5
85	-0.0136	0.0230	2.5

FREQUENCY ERROR VS. VOLTAGE



VOLTAGE (Volts)	5MHz		LIMIT (ppm)
	FREQUENCY ERROR (ppm)		
	Low Channel	High Channel	
V _{nor(3.7V)}	0.0026	0.0031	2.5
V _{min(3.6V)}	-0.0029	-0.0036	2.5
V _{max(4.2V)}	0.0026	0.0025	2.5

NOTE: The applicant defined the normal working voltage of the EUT is from V_{min} Vdc to V_{max} Vdc.

FREQUENCY ERROR vs. TEMPERATURE.

TEMP. (°C)	5MHz		LIMIT (ppm)
	FREQUENCY ERROR (ppm)		
	Low Channel	High Channel	
-40	-0.0132	-0.0112	2.5
-30	-0.0151	-0.0149	2.5
-20	-0.0123	-0.0133	2.5
-10	-0.0103	-0.0100	2.5
0	-0.0094	-0.0093	2.5
10	-0.0054	-0.0057	2.5
20	-0.0047	-0.0044	2.5
30	-0.0048	-0.0034	2.5
40	-0.0018	-0.0017	2.5
50	-0.0005	-0.0003	2.5
85	-0.0017	-0.0032	2.5



FREQUENCY ERROR VS. VOLTAGE

VOLTAGE (Volts)	10MHz		LIMIT (ppm)
	FREQUENCY ERROR (ppm)		
	Low Channel	High Channel	
V _{nor} (3.7V)	0.0032	0.0029	2.5
V _{min} (3.6V)	-0.0037	-0.0036	2.5
V _{max} (4.2V)	0.0031	0.0028	2.5

NOTE: The applicant defined the normal working voltage of the EUT is from V_{min} Vdc to V_{max} Vdc.

FREQUENCY ERROR vs. TEMPERATURE.

TEMP. (°C)	10MHz		LIMIT (ppm)
	FREQUENCY ERROR (ppm)		
	Low Channel	High Channel	
-40	-0.0132	-0.0107	2.5
-30	-0.0145	-0.0139	2.5
-20	-0.0130	-0.0131	2.5
-10	-0.0098	-0.0097	2.5
0	-0.0092	-0.0088	2.5
10	-0.0065	-0.0057	2.5
20	-0.0045	-0.0043	2.5
30	-0.0028	-0.0042	2.5
40	-0.0018	-0.0015	2.5
50	0.0005	-0.0003	2.5
85	-0.0021	-0.0036	2.5



LTE BAND 5 (DC SOURCE)

FREQUENCY ERROR VS. VOLTAGE

VOLTAGE (Volts)	1.4MHz		LIMIT (ppm)
	FREQUENCY ERROR (ppm)		
	Low Channel	High Channel	
V _{nor} (30V)	0.0026	0.0029	2.5
V _{min} (8V)	-0.0037	-0.0034	2.5
V _{max} (48V)	0.0025	0.0025	2.5

NOTE: The applicant defined the normal working voltage of the EUT is from V_{min} Vdc to V_{max} Vdc.

FREQUENCY ERROR vs. TEMPERATURE.

TEMP. (°C)	1.4MHz		LIMIT (ppm)
	FREQUENCY ERROR (ppm)		
	Low Channel	High Channel	
-40	-0.0105	-0.0146	2.5
-30	-0.0137	-0.0149	2.5
-20	-0.0111	-0.0121	2.5
-10	-0.0105	-0.0076	2.5
0	-0.0091	-0.0096	2.5
10	-0.0053	-0.0055	2.5
20	-0.0047	-0.0043	2.5
30	-0.0028	-0.0045	2.5
40	-0.0019	-0.0015	2.5
50	-0.0007	-0.0004	2.5
85	-0.0012	-0.0012	2.5



FREQUENCY ERROR VS. VOLTAGE

VOLTAGE (Volts)	3MHz		LIMIT (ppm)
	FREQUENCY ERROR (ppm)		
	Low Channel	High Channel	
V _{nor} (30V)	0.0024	0.0023	2.5
V _{min} (8V)	-0.0026	-0.0031	2.5
V _{max} (48V)	0.0021	0.0020	2.5

NOTE: The applicant defined the normal working voltage of the EUT is from V_{min} Vdc to V_{max} Vdc.

FREQUENCY ERROR vs. TEMPERATURE.

TEMP. (°C)	3MHz		LIMIT (ppm)
	FREQUENCY ERROR (ppm)		
	Low Channel	High Channel	
-40	-0.0155	-0.0101	2.5
-30	-0.0148	-0.0145	2.5
-20	-0.0129	-0.0125	2.5
-10	-0.0106	-0.0098	2.5
0	-0.0089	-0.0091	2.5
10	-0.0061	-0.0059	2.5
20	-0.0042	-0.0041	2.5
30	-0.0028	-0.0027	2.5
40	-0.0022	-0.0023	2.5
50	-0.0007	0.0000	2.5
85	-0.0012	0.0027	2.5



FREQUENCY ERROR VS. VOLTAGE

VOLTAGE (Volts)	5MHz		LIMIT (ppm)
	FREQUENCY ERROR (ppm)		
	Low Channel	High Channel	
V _{nor} (30V)	0.0026	0.0031	2.5
V _{min} (8V)	-0.0029	-0.0036	2.5
V _{max} (48V)	0.0026	0.0025	2.5

NOTE: The applicant defined the normal working voltage of the EUT is from V_{min} Vdc to V_{max} Vdc.

FREQUENCY ERROR vs. TEMPERATURE.

TEMP. (°C)	5MHz		LIMIT (ppm)
	FREQUENCY ERROR (ppm)		
	Low Channel	High Channel	
-40	-0.0104	-0.0163	2.5
-30	-0.0151	-0.0149	2.5
-20	-0.0123	-0.0133	2.5
-10	-0.0103	-0.0100	2.5
0	-0.0094	-0.0093	2.5
10	-0.0054	-0.0057	2.5
20	-0.0047	-0.0044	2.5
30	-0.0048	-0.0034	2.5
40	-0.0018	-0.0017	2.5
50	-0.0005	-0.0003	2.5
85	-0.0014	-0.0025	2.5



FREQUENCY ERROR VS. VOLTAGE

VOLTAGE (Volts)	10MHz		LIMIT (ppm)
	FREQUENCY ERROR (ppm)		
	Low Channel	High Channel	
V _{nor} (30V)	0.0032	0.0029	2.5
V _{min} (8V)	-0.0037	-0.0036	2.5
V _{max} (48V)	0.0031	0.0028	2.5

NOTE: The applicant defined the normal working voltage of the EUT is from V_{min} Vdc to V_{max} Vdc.

FREQUENCY ERROR vs. TEMPERATURE.

TEMP. (°C)	10MHz		LIMIT (ppm)
	FREQUENCY ERROR (ppm)		
	Low Channel	High Channel	
-40	-0.0121	-0.0203	2.5
-30	-0.0145	-0.0139	2.5
-20	-0.0130	-0.0131	2.5
-10	-0.0098	-0.0097	2.5
0	-0.0092	-0.0088	2.5
10	-0.0065	-0.0057	2.5
20	-0.0045	-0.0043	2.5
30	-0.0028	-0.0042	2.5
40	-0.0018	-0.0015	2.5
50	0.0005	-0.0003	2.5
85	0.0045	-0.0034	2.5



3.3 OCCUPIED BANDWIDTH MEASUREMENT

3.3.1 LIMITS OF OCCUPIED BANDWIDTH MEASUREMENT

The width of a frequency band such that, below the lower and above the upper frequency limits, the mean powers emitted are each equal to a specified percentage 0.5 % of the total mean power of a given emission.

3.3.2 TEST SETUP

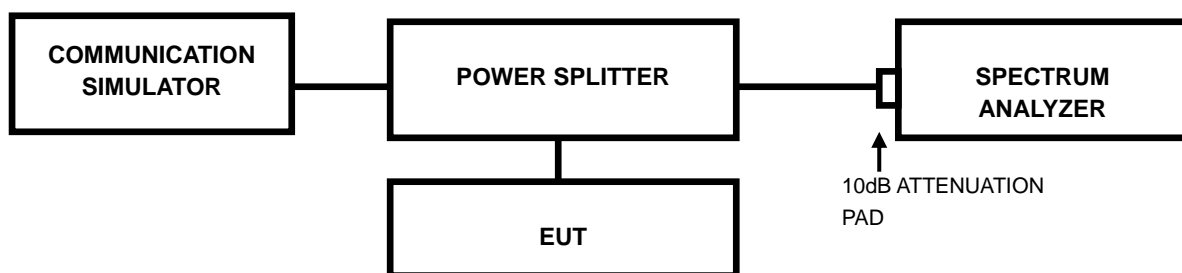

3.3.3 TEST PROCEDURES

- The conducted occupied bandwidth used the power splitter via EUT RF power connector between simulation base station and spectrum analyzer.
- Use OBW measurement function of Spectrum analyzer to measure 99 % occupied bandwidth.



BUREAU
VERITAS

Test Report No.: W7L-P22080014RF01

3.3.4 TEST RESULTS

Please Refer to Module report R2007A0435-R4.

3.4 BAND EDGE MEASUREMENT

3.4.1 LIMITS OF BAND EDGE MEASUREMENT

Power of any emission outside of the authorized operating frequency ranges must be attenuated below the transmitting power (P) by a factor of at least $43 + 10 \log(P)$ dB. In the 1 MHz bands immediately outside and adjacent to the frequency block a resolution bandwidth of at least one percent of the emission bandwidth of the fundamental emission of the transmitter may be employed.

3.4.2 TEST SETUP

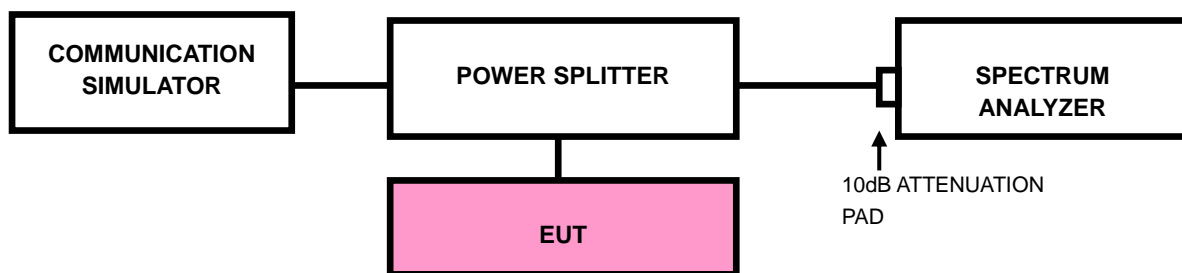



**BUREAU
VERITAS**

Test Report No.: W7L-P22080014RF01

3.4.3 TEST PROCEDURES

- a. All measurements were done at low and high operational frequency range.
- b. The center frequency of spectrum is the band edge frequency and span is 1~5 MHz. RBW of the spectrum is 10kHz and VBW of the spectrum is 30kHz (LTE bandwidth for (1.4M/3M/5M/10M/15M/20M)1RB/0RB&1RB/MAXRB).
- c. The center frequency of spectrum is the band edge frequency and span is 1~5 MHz. RBW of the spectrum is $\geq 1\% \cdot \text{EBW}$ kHz and VBW of the spectrum is $3 \cdot \text{RBW}$ kHz. (LTE bandwidth for (1.4M/3M/5M/10M/15M/20MHz)Full RB/0RB).
- d. Record the max trace plot into the test report.



BUREAU
VERITAS

Test Report No.: W7L-P22080014RF01

3.4.4 TEST RESULTS

Please Refer to Module report R2007A0435-R4.

3.5 CONDUCTED SPURIOUS EMISSIONS

3.5.1 LIMITS OF CONDUCTED SPURIOUS EMISSIONS MEASUREMENT

The power of any emission outside of the authorized operating frequency ranges must be attenuated below the transmitting power (P) by a factor of at least $43 + 10 \log(P)$ dB. The emission limit equal to -13dBm .

3.5.2 TEST PROCEDURE

- a. The EUT makes a phone call to the communication simulator. All measurements were done at low, middle and high operational frequency range.
- b. Measuring frequency range is from 9kHz up to a frequency including its 10th harmonic. 10dB attenuation pad is connected with spectrum. RBW=1MHz and VBW=3MHz is used for conducted emission measurement.

3.5.3 TEST SETUP

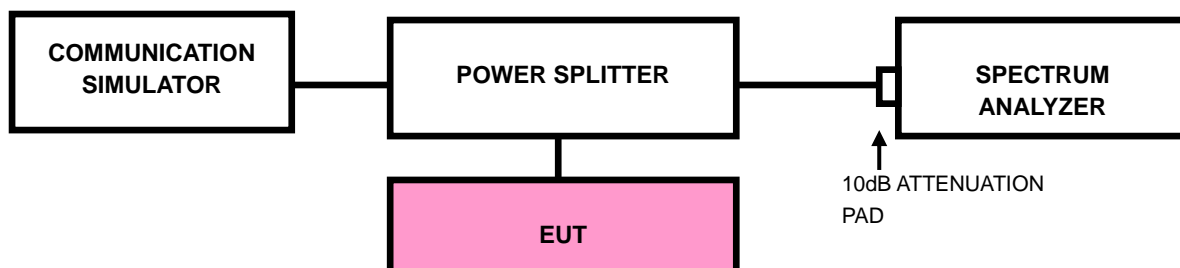



Test Report No.: W7L-P22080014RF01

3.5.4 TEST RESULTS

NOTE : The 9K~30MHz amplitude of spurious emissions attenuated more than 20 dB below the permissible value is not required in the report.

Please Refer to Module report R2007A0435-R4.



3.6 RADIATED EMISSION MEASUREMENT

3.6.1 LIMITS OF RADIATED EMISSION MEASUREMENT

The power of any emission outside of the authorized operating frequency ranges must be attenuated below the transmitting power (P) by a factor of at least $43 + 10 \log(P)$ dB. The emission limit equal to -13dBm .

3.6.2 TEST PROCEDURES

- a. Substitution method is used for E.I.R.P measurement. In the semi-anechoic chamber, EUT placed on the 0.8m height of Turn Table, rotated the table around 360 degrees to search the maximum radiation power and receiver antenna shall be rotated vertical and horizontal polarization and moved height from 1m to 4m to find the maximum polar radiated power. The "Read Value" is the spectrum reading the maximum power value.
- b. The substitution horn antenna is substituted for EUT at the same position and signals generator export the CW signal to the substitution antenna via a TX cable. Rotated the Turn Table and moved receiving antenna to find the maximum radiation power. Adjust output power level of S.G to get a Value of spectrum reading equal to "Read Value " of step a. Record the power level of S.G
- c. $\text{EIRP} = \text{Output power level of S.G} - \text{TX cable loss} + \text{Antenna gain of substitution horn.}$
- d. E.R.P power can be calculated form E.I.R.P power by subtracting the gain of dipole,
 $\text{E.R.P power} = \text{E.I.P.R power} - 2.15\text{dBi.}$

NOTE: The resolution bandwidth and video bandwidth of test receiver/spectrum analyzer is 1MHz/3MHz.

3.6.3 DEVIATION FROM TEST STANDARD

No deviation



3.6.4 TEST SETUP

< Frequency Range below 30MHz >

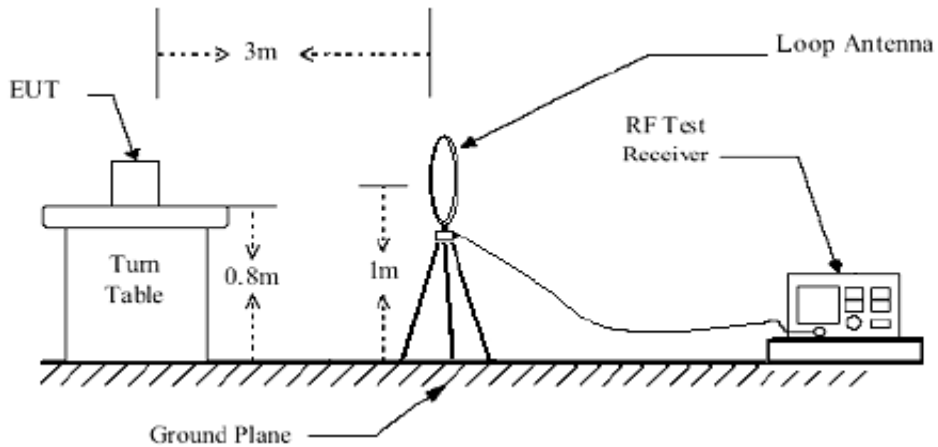

< Frequency Range 30MHz~1GHz >

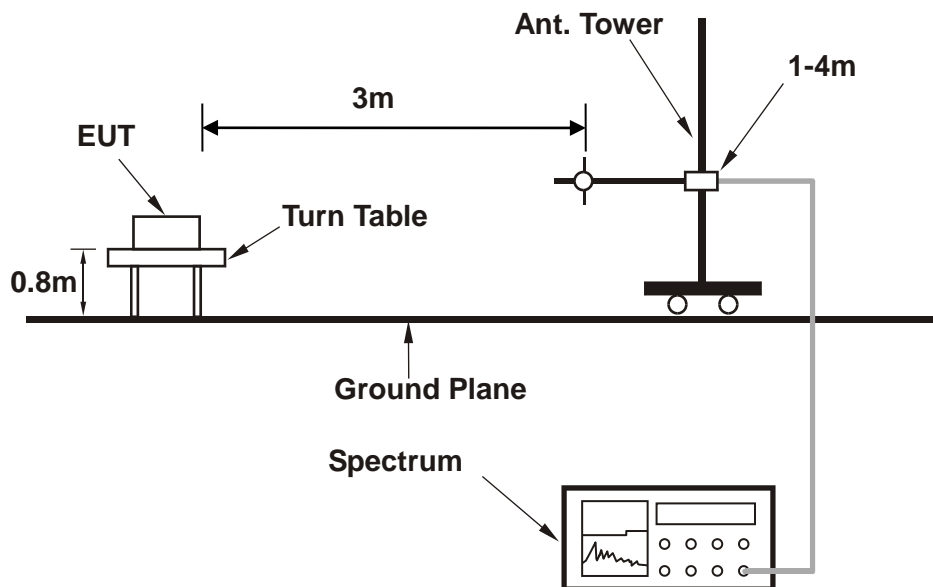



<Frequency Range above 1GHz>

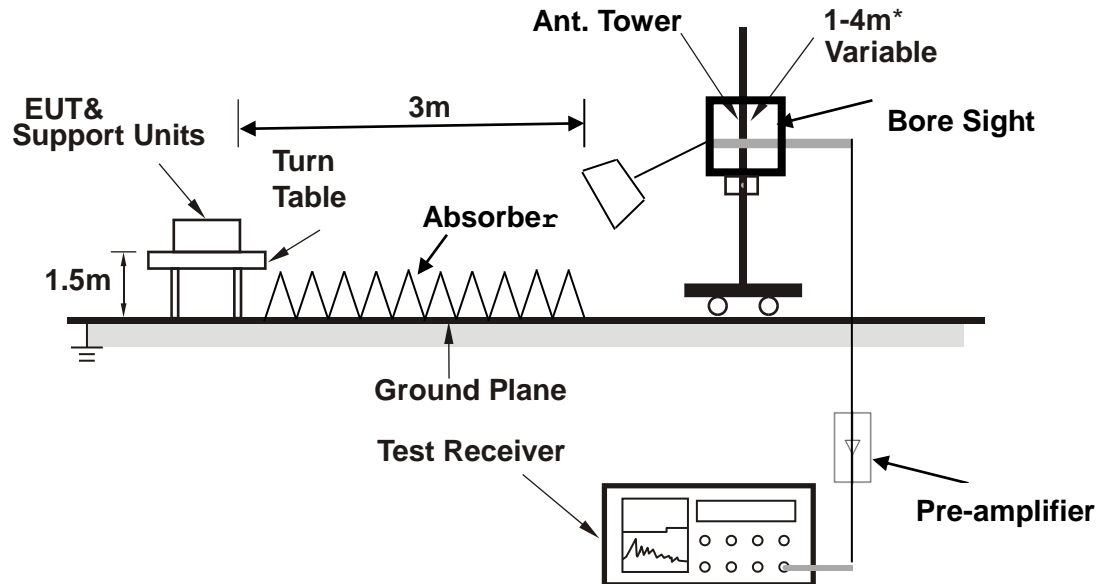

Note: Above 1G is a directional antenna

Depends on the EUT height and the antenna 3dB beamwidth both, refer to section 7.3 of CISPR 16-2-3.

For the actual test configuration, please refer to the attached file (Test Setup Photo).



3.6.5 TEST RESULTS

NOTE : 1.The 9K~30MHz amplitude of spurious emissions attenuated more than 20 dB below the permissible value is not required in the report.

2.Pre-scan battery supply and DC SOURCE,Worse case is DC SOURCE

BELOW 1GHz WORST-CASE DATA 1(Magnet Mount Antenna)

30 MHz – 1GHz data:

LTE Band 5

CHANNEL BANDWIDTH: 1.4MHz / QPSK

MODE	TX channel 20525	FREQUENCY RANGE	Below 1000MHz
ENVIRONMENTAL CONDITIONS	23deg. C, 70%RH	INPUT POWER	DC30V
TESTED BY	Jace Hu		
ANTENNA POLARITY & TEST DISTANCE: HORIZONTAL AT 3 M			

	Freq	Level	Read Level	Limit Line	Over Limit	Factor	Remark	PoI/Phase
	MHz	dBm/m	dBm	dBm/m	dB	dB/m		
1	54.250	-56.80	-39.08	-13.00	-43.80	-17.72	Peak	Horizontal
2	132.820	-61.28	-40.53	-13.00	-48.28	-20.75	Peak	Horizontal
3 PP	259.890	-51.41	-39.76	-13.00	-38.41	-11.65	Peak	Horizontal
4	325.850	-55.34	-43.51	-13.00	-42.34	-11.83	Peak	Horizontal
5	437.400	-57.54	-48.18	-13.00	-44.54	-9.36	Peak	Horizontal
6	482.020	-57.53	-48.96	-13.00	-44.53	-8.57	Peak	Horizontal

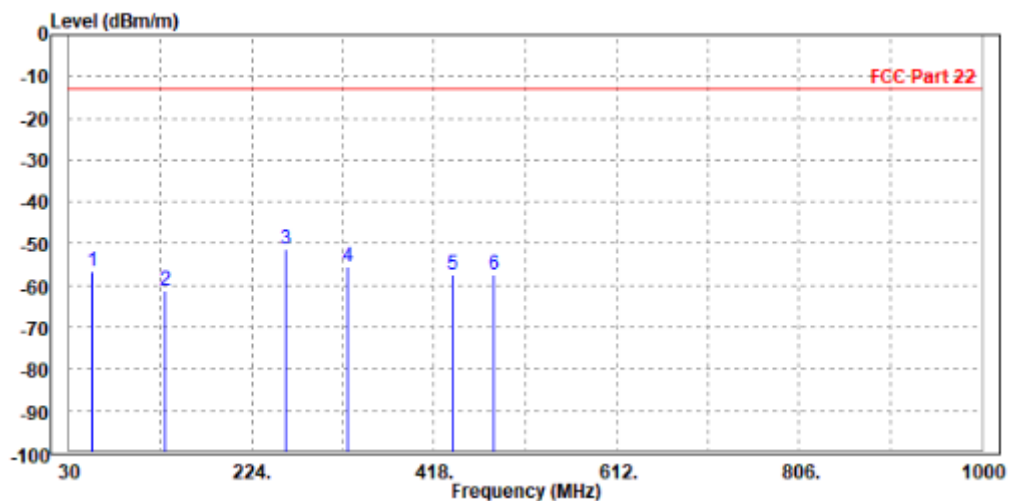



MODE	TX channel 20525	FREQUENCY RANGE	Below 1000MHz
ENVIRONMENTAL CONDITIONS	23deg. C, 70%RH	INPUT POWER	DC30V
TESTED BY	Jace Hu		
ANTENNA POLARITY & TEST DISTANCE: VERTICAL AT 3 M			

	Freq	Level	Read Level	Limit Line	Over Limit	Factor	Remark	Pol/Phase
	MHz	dBm/m	dBm	dBm/m	dB	dB/m		
1	54.250	-58.82	-34.23	-13.00	-45.82	-24.59	Peak	Vertical
2	116.330	-57.83	-44.62	-13.00	-44.83	-13.21	Peak	Vertical
3 PP	132.820	-55.80	-41.92	-13.00	-42.80	-13.88	Peak	Vertical
4	257.950	-63.66	-50.51	-13.00	-50.66	-13.15	Peak	Vertical
5	359.800	-64.29	-54.56	-13.00	-51.29	-9.73	Peak	Vertical
6	435.460	-60.16	-51.49	-13.00	-47.16	-8.67	Peak	Vertical

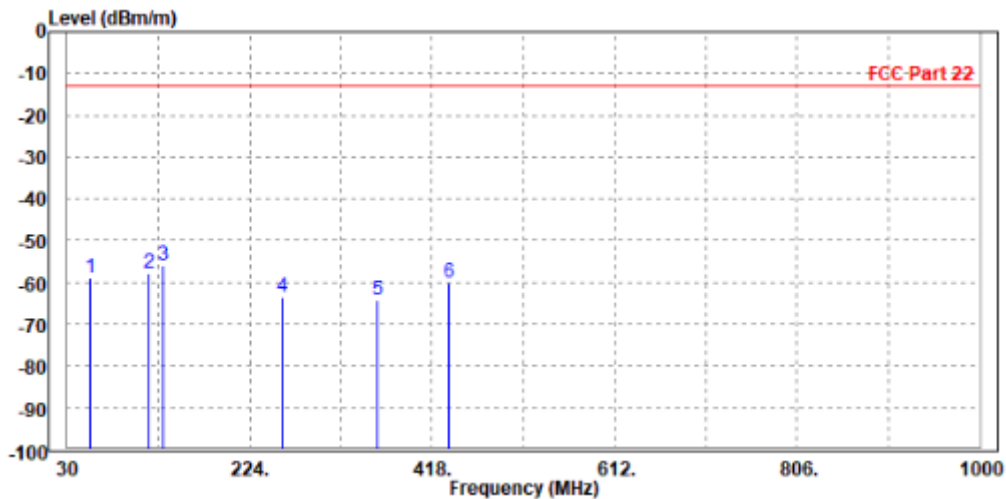



ABOVE 1GHz DATA

Note: For higher frequency, the emission is too low to be detected.

LTE Band 5

CHANNEL BANDWIDTH: 1.4MHz / QPSK

CH20407

MODE	TX channel 20407	FREQUENCY RANGE	Above 1000MHz
ENVIRONMENTAL CONDITIONS	23deg. C, 70%RH	INPUT POWER	DC30V
TESTED BY	Jace Hu		
ANTENNA POLARITY & TEST DISTANCE: HORIZONTAL AT 3 M			

	Freq	Level	Read Level	Limit Line	Over Limit	Factor	Remark	Pol/Phase
	MHz	dBm/m	dBm	dBm/m	dB	dB/m		
1	1648.000	-57.05	-57.82	-13.00	-44.05	0.77	Peak	Horizontal
2 PP	2474.100	-53.37	-58.71	-13.00	-40.37	5.34	Peak	Horizontal

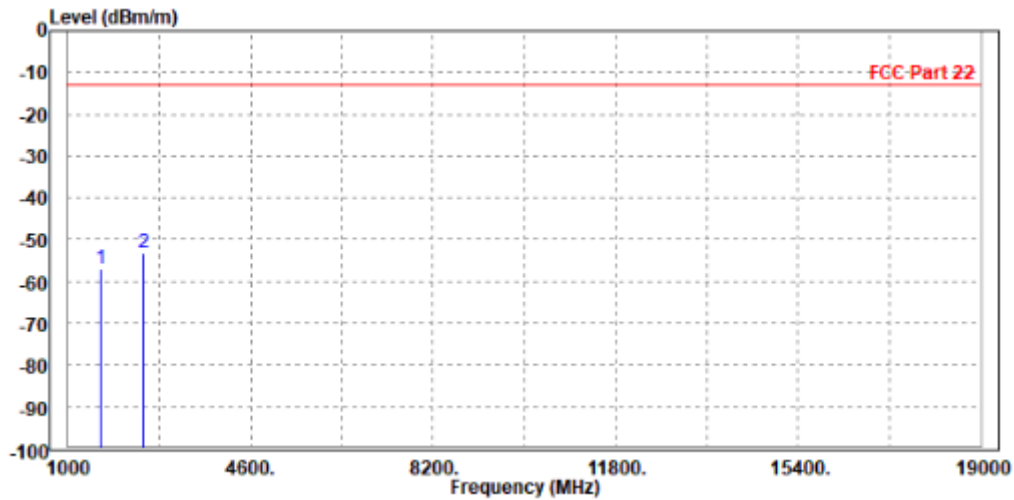



MODE	TX channel 20407	FREQUENCY RANGE	Above 1000MHz
ENVIRONMENTAL CONDITIONS	23deg. C, 70%RH	INPUT POWER	DC30V
TESTED BY	Jace Hu		
ANTENNA POLARITY & TEST DISTANCE: VERTICAL AT 3 M			

	Freq	Level	Read Level	Limit Line	Over Limit	Factor	Remark	Pol/Phase
	MHz	dBm/m	dBm	dBm/m	dB	dB/m		
1	1648.000	-58.22	-59.26	-13.00	-45.22	1.04	Peak	Vertical
2 PP	2474.100	-53.25	-58.12	-13.00	-40.25	4.87	Peak	Vertical

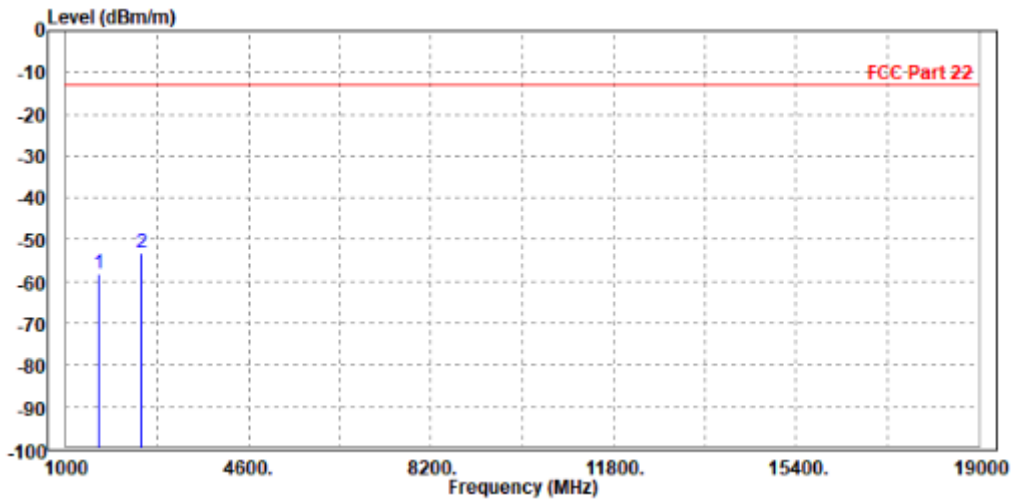



CH20525

MODE	TX channel 20525	FREQUENCY RANGE	Above 1000MHz
ENVIRONMENTAL CONDITIONS	23deg. C, 70%RH	INPUT POWER	DC30V
TESTED BY	Jace Hu		
ANTENNA POLARITY & TEST DISTANCE: HORIZONTAL AT 3 M			

	Freq	Level	Read Level	Limit Line	Over Limit	Factor	Remark	Pol/Phase
	MHz	dBm/m	dBm	dBm/m	dB	dB/m		
1	1673.000	-57.82	-58.80	-13.00	-44.82	0.98	Peak	Horizontal
2 PP	2512.000	-51.54	-57.01	-13.00	-38.54	5.47	Peak	Horizontal

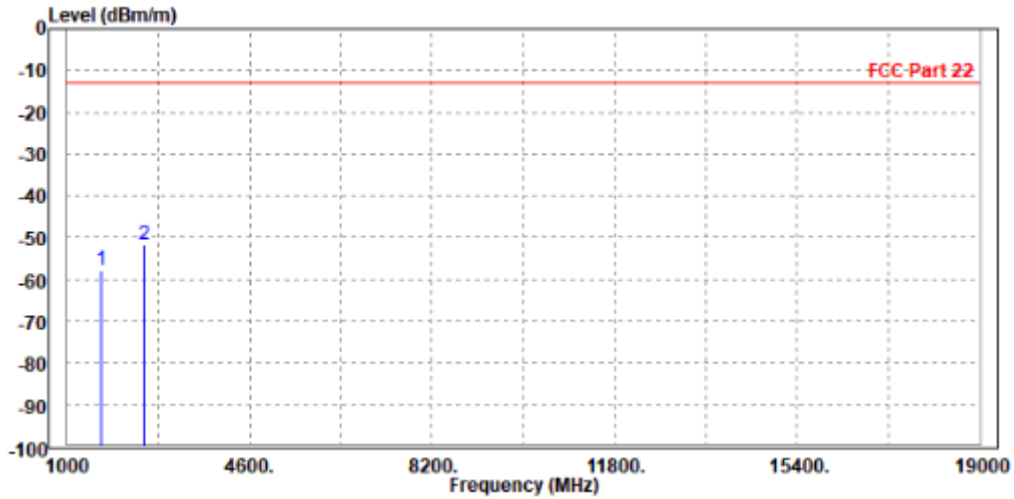



MODE	TX channel 20525	FREQUENCY RANGE	Above 1000MHz
ENVIRONMENTAL CONDITIONS	23deg. C, 70%RH	INPUT POWER	DC30V
TESTED BY	Jace Hu		
ANTENNA POLARITY & TEST DISTANCE: VERTICAL AT 3 M			

	Freq	Level	Read Level	Limit Line	Over Limit	Factor	Remark	Pol/Phase
	MHz	dBm/m	dBm	dBm/m	dB	dB/m		
1	1666.000	-57.97	-59.14	-13.00	-44.97	1.17	Peak	Vertical
2 PP	2509.500	-51.20	-56.17	-13.00	-38.20	4.97	Peak	Vertical

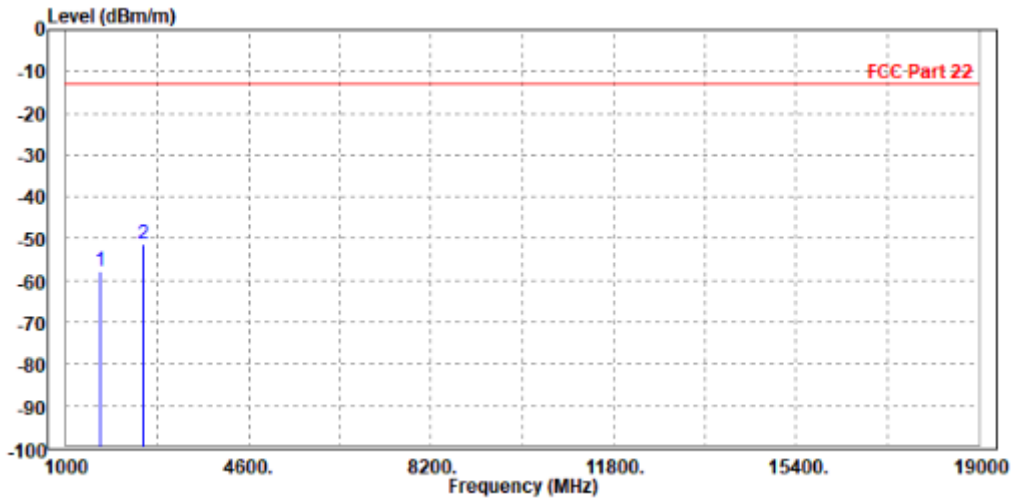



CH20643

MODE	TX channel 20643	FREQUENCY RANGE	Above 1000MHz
ENVIRONMENTAL CONDITIONS	23deg. C, 70%RH	INPUT POWER	DC30V
TESTED BY	Jace Hu		
ANTENNA POLARITY & TEST DISTANCE: HORIZONTAL AT 3 M			

	Freq	Level	Read Level	Limit Line	Over Limit	Factor	Remark	Pol/Phase
	MHz	dBm/m	dBm	dBm/m	dB	dB/m		
1	1696.600	-57.31	-58.48	-13.00	-44.31	1.17	Peak	Horizontal
2 PP	2548.000	-53.06	-58.61	-13.00	-40.06	5.55	Peak	Horizontal

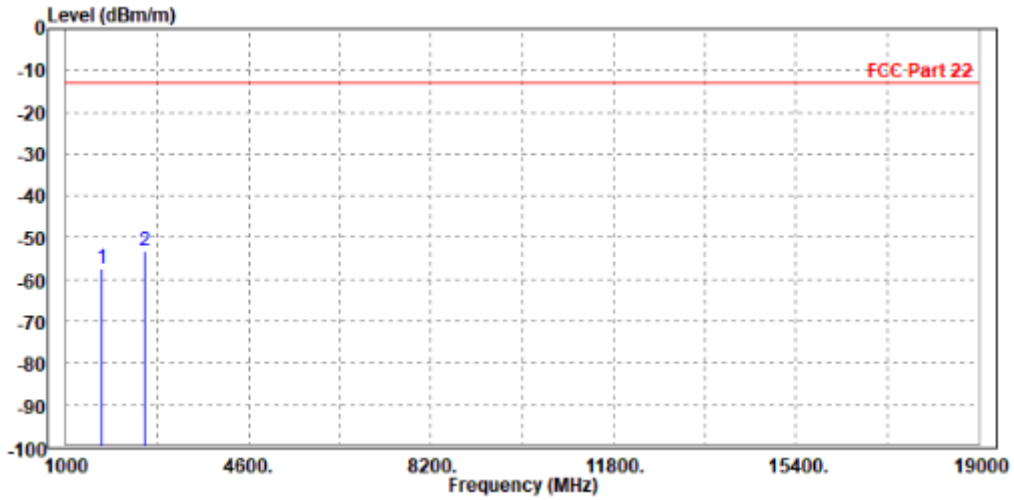



**BUREAU
VERITAS**

Test Report No.: W7L-P22080014RF01

MODE	TX channel 20643	FREQUENCY RANGE	Above 1000MHz
ENVIRONMENTAL CONDITIONS	23deg. C, 70%RH	INPUT POWER	DC30V
TESTED BY	Jace Hu		
ANTENNA POLARITY & TEST DISTANCE: VERTICAL AT 3 M			

	Freq	Level	Read Level	Limit Line	Over Limit	Factor	Remark	Pol/Phase
	MHz	dBm/m	dBm	dBm/m	dB	dB/m		
1	1702.000	-57.44	-58.87	-13.00	-44.44	1.43	Peak	Vertical
2 PP	2544.900	-53.78	-58.86	-13.00	-40.78	5.08	Peak	Vertical

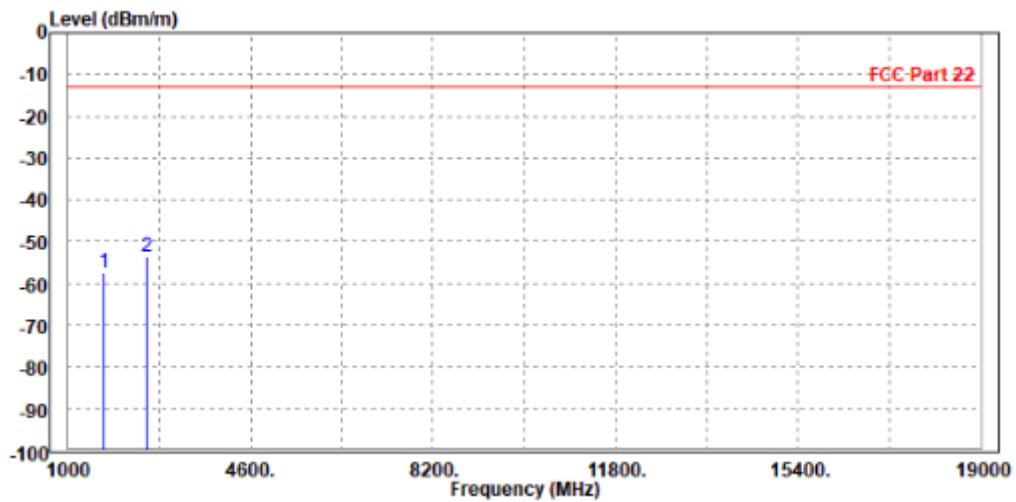



CHANNEL BANDWIDTH: 3MHz / QPSK

MODE	TX channel 20525	FREQUENCY RANGE	Above 1000MHz
ENVIRONMENTAL CONDITIONS	23deg. C, 70%RH	INPUT POWER	DC30V
TESTED BY	Jace Hu		
ANTENNA POLARITY & TEST DISTANCE: HORIZONTAL AT 3 M			

	Freq	Level	Read Level	Limit Line	Over Limit	Factor	Remark	Pol/Phase
	MHz	dBm/m	dBm	dBm/m	dB	dB/m		
1	1666.000	-57.75	-58.67	-13.00	-44.75	0.92	Peak	Horizontal
2 PP	2509.500	-51.46	-56.92	-13.00	-38.46	5.46	Peak	Horizontal

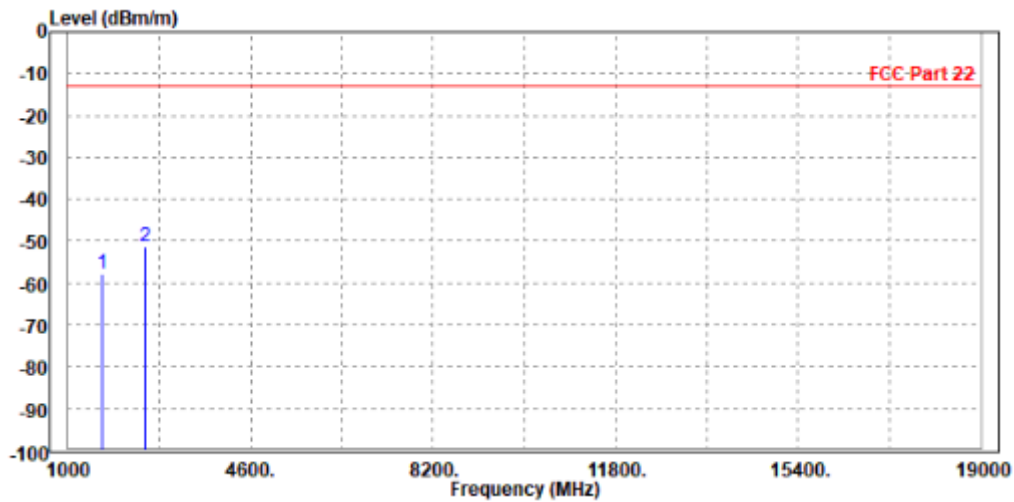



**BUREAU
VERITAS**

Test Report No.: W7L-P22080014RF01

MODE	TX channel 20525	FREQUENCY RANGE	Above 1000MHz
ENVIRONMENTAL CONDITIONS	23deg. C, 70%RH	INPUT POWER	DC30V
TESTED BY	Jace Hu		
ANTENNA POLARITY & TEST DISTANCE: VERTICAL AT 3 M			

	Freq	Level	Read Level	Limit Line	Over Limit	Factor	Remark	Pol/Phase
	MHz	dBm/m	dBm	dBm/m	dB	dB/m		
1	1673.000	-56.62	-57.84	-13.00	-43.62	1.22	Peak	Vertical
2	PP 2512.000	-51.63	-56.61	-13.00	-38.63	4.98	Peak	Vertical

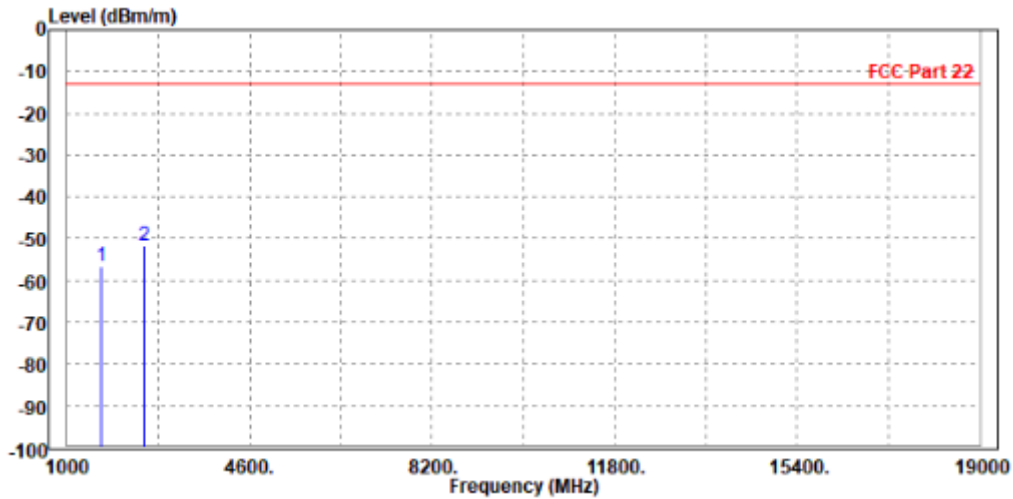



CHANNEL BANDWIDTH: 5MHz / QPSK

MODE	TX channel 20525	FREQUENCY RANGE	Above 1000MHz
ENVIRONMENTAL CONDITIONS	23deg. C, 70%RH	INPUT POWER	DC30V
TESTED BY	Jace Hu		
ANTENNA POLARITY & TEST DISTANCE: HORIZONTAL AT 3 M			

	Freq	Level	Read Level	Limit Line	Over Limit	Factor	Remark	Pol/Phase
	MHz	dBm/m	dBm	dBm/m	dB	dB/m		
1	1673.000	-58.07	-59.05	-13.00	-45.07	0.98	Peak	Horizontal
2 PP	2512.000	-52.65	-58.12	-13.00	-39.65	5.47	Peak	Horizontal

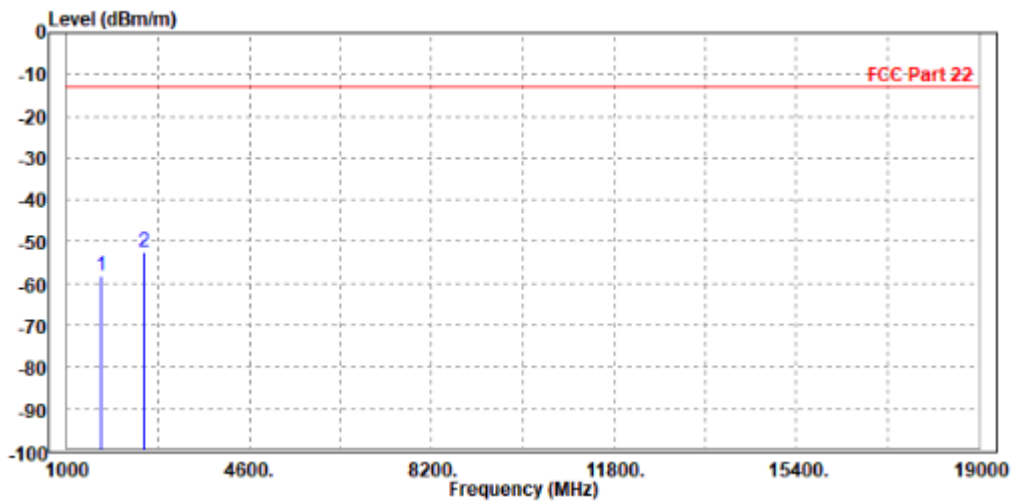



MODE	TX channel 20525	FREQUENCY RANGE	Above 1000MHz
ENVIRONMENTAL CONDITIONS	23deg. C, 70%RH	INPUT POWER	DC30V
TESTED BY	Jace Hu		
ANTENNA POLARITY & TEST DISTANCE: VERTICAL AT 3 M			

	Freq	Level	Read Level	Limit Line	Over Limit	Factor	Remark	Pol/Phase
	MHz	dBm/m	dBm	dBm/m	dB	dB/m		
1	1666.000	-57.18	-58.35	-13.00	-44.18	1.17	Peak	Vertical
2 PP	2509.500	-52.51	-57.48	-13.00	-39.51	4.97	Peak	Vertical

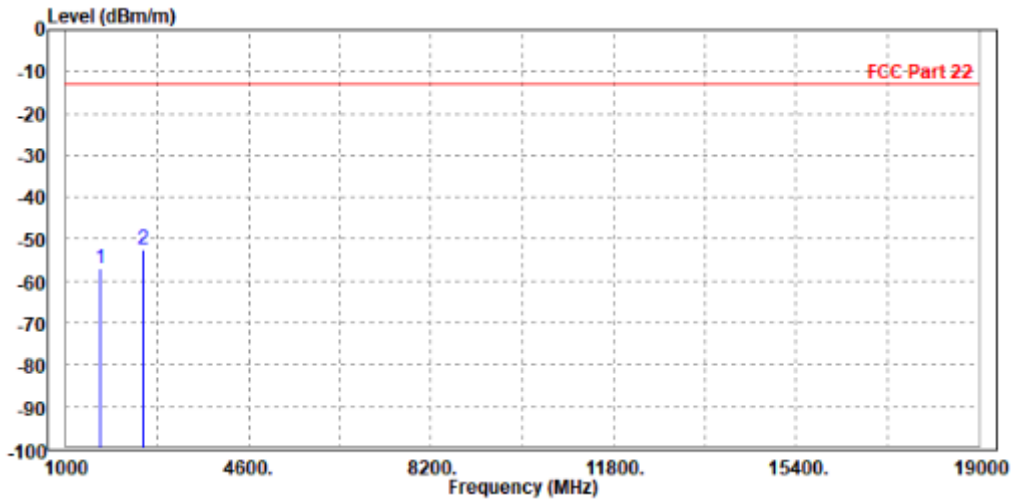



**BUREAU
VERITAS**

Test Report No.: W7L-P22080014RF01

CHANNEL BANDWIDTH: 10MHz / QPSK

MODE	TX channel 20525	FREQUENCY RANGE	Above 1000MHz
ENVIRONMENTAL CONDITIONS	23deg. C, 70%RH	INPUT POWER	DC30V
TESTED BY	Jace Hu		
ANTENNA POLARITY & TEST DISTANCE: HORIZONTAL AT 3 M			

	Freq	Level	Read Level	Limit Line	Over Limit	Factor	Remark	Pol/Phase
	MHz	dBm/m	dBm	dBm/m	dB	dB/m		
1	1673.000	-57.08	-58.06	-13.00	-44.08	0.98	Peak	Horizontal
2 PP	2512.000	-52.57	-58.04	-13.00	-39.57	5.47	Peak	Horizontal

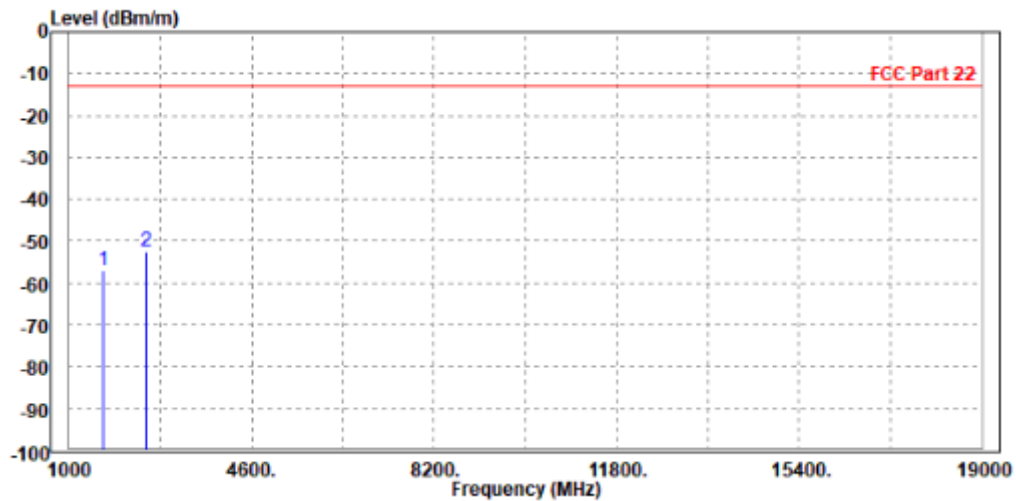



MODE	TX channel 20525	FREQUENCY RANGE	Above 1000MHz
ENVIRONMENTAL CONDITIONS	23deg. C, 70%RH	INPUT POWER	DC30V
TESTED BY	Jace Hu		
ANTENNA POLARITY & TEST DISTANCE: VERTICAL AT 3 M			

	Freq	Level	Read Level	Limit Line	Over Limit	Factor	Remark	Pol/Phase
	MHz	dBm/m	dBm	dBm/m	dB	dB/m		
1	1666.000	-57.02	-58.19	-13.00	-44.02	1.17	Peak	Vertical
2 PP	2509.500	-52.62	-57.59	-13.00	-39.62	4.97	Peak	Vertical

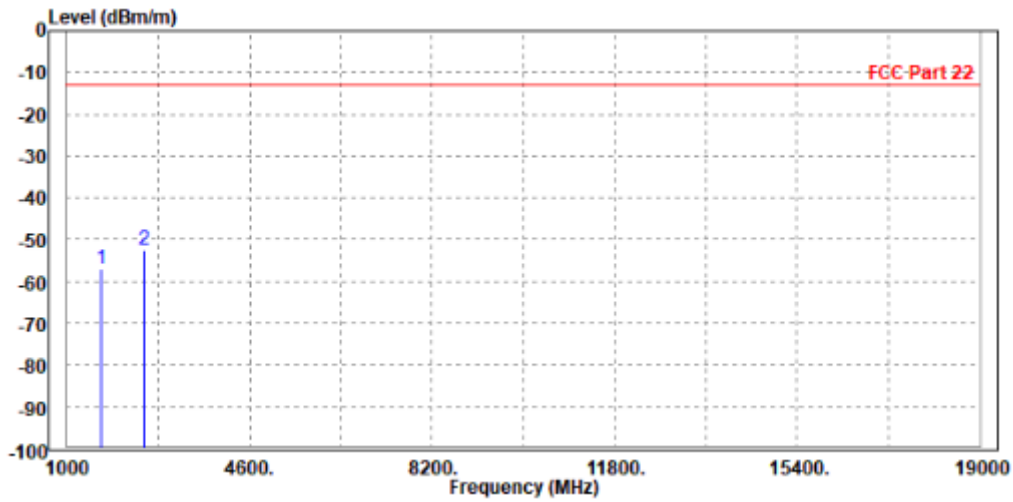



BELOW 1GHz WORST-CASE DATA 2(Internal Antenna)

30 MHz – 1GHz data:

LTE Band 5

CHANNEL BANDWIDTH: 10MHz / QPSK

MODE	TX channel 20525	FREQUENCY RANGE	Below 1000MHz
ENVIRONMENTAL CONDITIONS	23deg. C, 70%RH	INPUT POWER	DC30V
TESTED BY	Jace Hu		
ANTENNA POLARITY & TEST DISTANCE: HORIZONTAL AT 3 M			

	Freq	Level	Read Level	Limit Line	Over Limit	Factor	Remark	Pol/Phase
	MHz	dBm/m	dBm	dBm/m	dB	dB/m		
1	PP 62.010	-50.91	-31.66	-13.00	-37.91	-19.25	Peak	Horizontal
2	138.640	-57.94	-38.37	-13.00	-44.94	-19.57	Peak	Horizontal
3	244.370	-52.37	-40.25	-13.00	-39.37	-12.12	Peak	Horizontal
4	346.220	-57.13	-45.79	-13.00	-44.13	-11.34	Peak	Horizontal
5	447.100	-52.20	-43.01	-13.00	-39.20	-9.19	Peak	Horizontal
6	612.970	-52.07	-47.91	-13.00	-39.07	-4.16	Peak	Horizontal

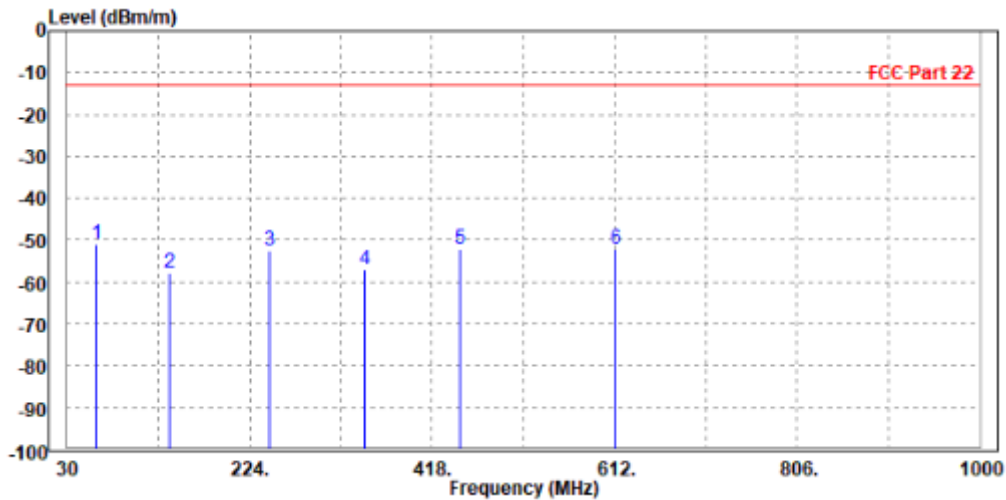



MODE	TX channel 20525	FREQUENCY RANGE	Below 1000MHz
ENVIRONMENTAL CONDITIONS	23deg. C, 70%RH	INPUT POWER	DC30V
TESTED BY	Jace Hu		
ANTENNA POLARITY & TEST DISTANCE: VERTICAL AT 3 M			

	Freq	Level	Read Level	Limit Line	Over Limit	Factor	Remark	Pol/Phase
	MHz	dBm/m	dBm	dBm/m	dB	dB/m		
1	PP	62.980	-47.01	-24.06	-13.00	-34.01	-22.95 Peak	Vertical
2		135.730	-59.20	-45.71	-13.00	-46.20	-13.49 Peak	Vertical
3		251.160	-59.34	-45.81	-13.00	-46.34	-13.53 Peak	Vertical
4		327.790	-60.56	-50.25	-13.00	-47.56	-10.31 Peak	Vertical
5		440.310	-56.05	-47.42	-13.00	-43.05	-8.63 Peak	Vertical
6		677.960	-52.93	-47.44	-13.00	-39.93	-5.49 Peak	Vertical

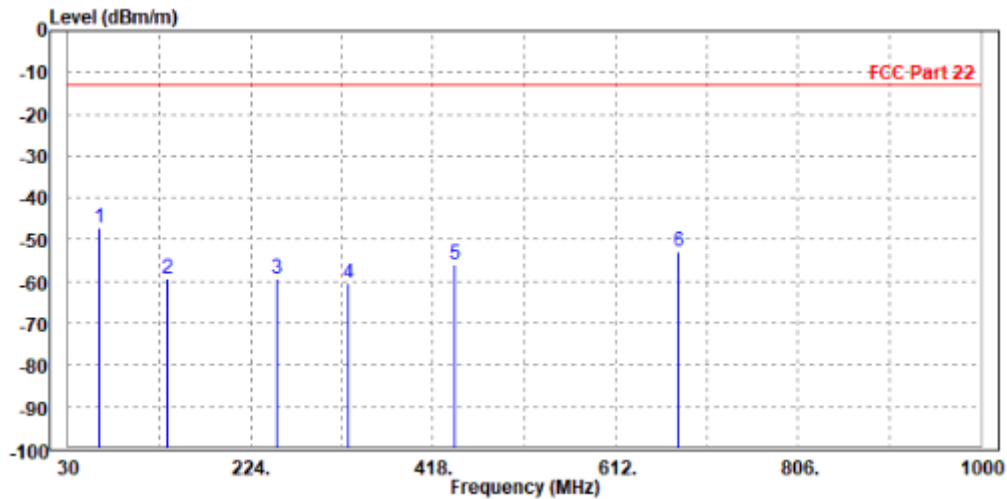



ABOVE 1GHz DATA

Note: For higher frequency, the emission is too low to be detected.

LTE Band 5

CHANNEL BANDWIDTH: 1.4MHz / QPSK

MODE	TX channel 20525	FREQUENCY RANGE	Above 1000MHz
ENVIRONMENTAL CONDITIONS	23deg. C, 70%RH	INPUT POWER	DC30V
TESTED BY	Jace Hu		
ANTENNA POLARITY & TEST DISTANCE: HORIZONTAL AT 3 M			

	Freq	Level	Read Level	Limit Line	Over Limit	Factor	Remark	Pol/Phase
	MHz	dBm/m	dBm	dBm/m	dB	dB/m		
1	PP 1666.000	-47.40	-48.32	-13.00	-34.40	0.92	Peak	Horizontal
2	2512.000	-53.19	-58.66	-13.00	-40.19	5.47	Peak	Horizontal

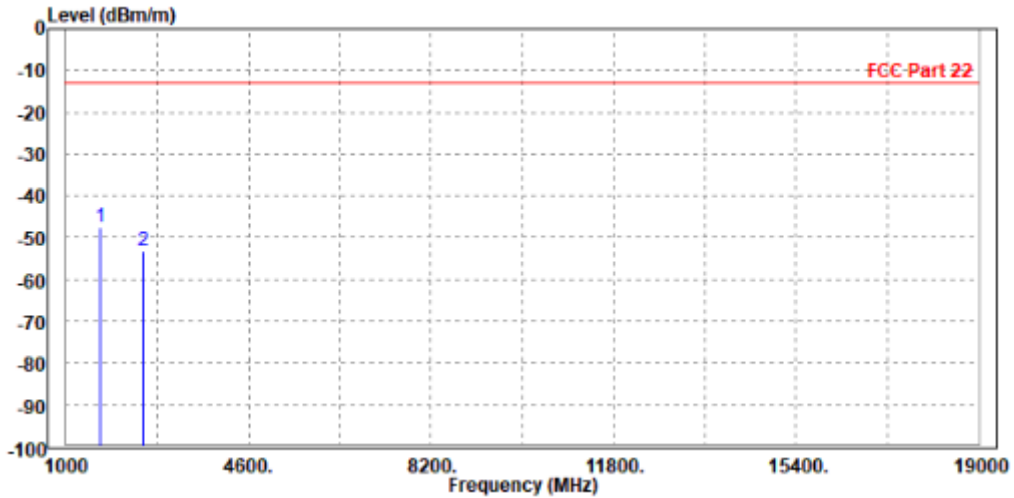



**BUREAU
VERITAS**

Test Report No.: W7L-P22080014RF01

MODE	TX channel 20525	FREQUENCY RANGE	Above 1000MHz
ENVIRONMENTAL CONDITIONS	23deg. C, 70%RH	INPUT POWER	DC30V
TESTED BY	Jace Hu		
ANTENNA POLARITY & TEST DISTANCE: VERTICAL AT 3 M			

	Freq	Level	Read Level	Limit Line	Over Limit	Factor	Remark	Pol/Phase
	MHz	dBm/m	dBm	dBm/m	dB	dB/m		
1	1666.000	-55.86	-57.03	-13.00	-42.86	1.17	Peak	Vertical
2 PP	2509.500	-53.39	-58.36	-13.00	-40.39	4.97	Peak	Vertical

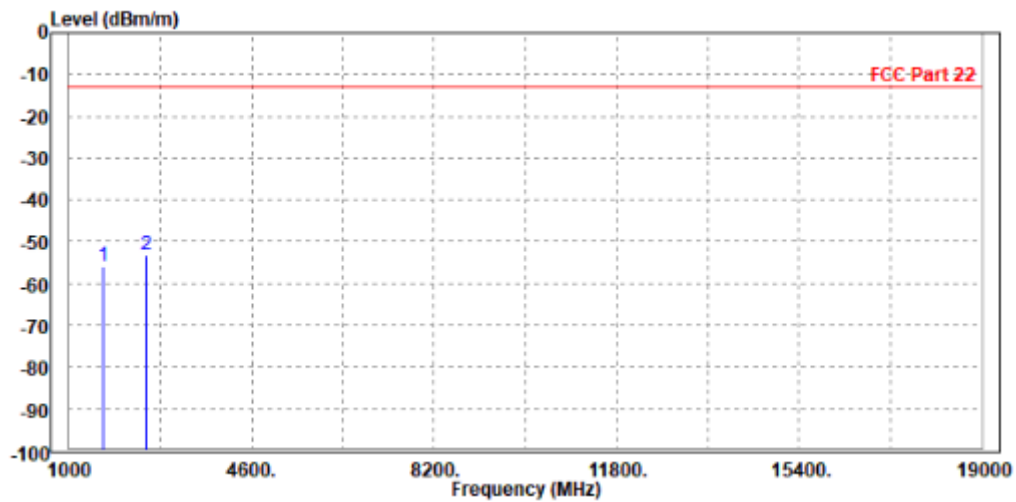



CHANNEL BANDWIDTH: 3MHz / QPSK

MODE	TX channel 20525	FREQUENCY RANGE	Above 1000MHz
ENVIRONMENTAL CONDITIONS	23deg. C, 70%RH	INPUT POWER	DC30V
TESTED BY	Jace Hu		
ANTENNA POLARITY & TEST DISTANCE: HORIZONTAL AT 3 M			

	Freq	Level	Read Level	Limit Line	Over Limit	Factor	Remark	Pol/Phase
	MHz	dBm/m	dBm	dBm/m	dB	dB/m		
1	PP 1666.000	-49.79	-50.71	-13.00	-36.79	0.92	Peak	Horizontal
2	2509.500	-52.97	-58.43	-13.00	-39.97	5.46	Peak	Horizontal

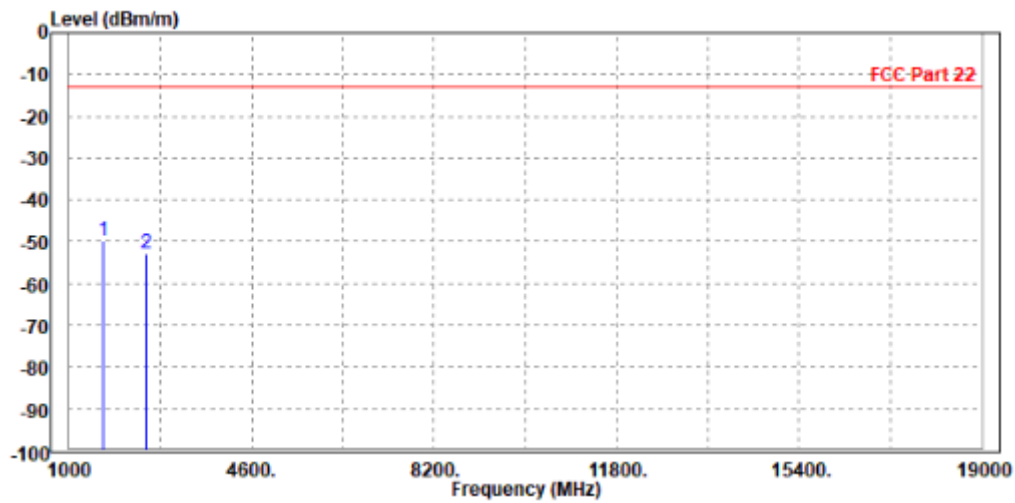



MODE	TX channel 20525	FREQUENCY RANGE	Above 1000MHz
ENVIRONMENTAL CONDITIONS	23deg. C, 70%RH	INPUT POWER	DC30V
TESTED BY	Jace Hu		
ANTENNA POLARITY & TEST DISTANCE: VERTICAL AT 3 M			

	Freq	Level	Read Level	Limit Line	Over Limit	Factor	Remark	Pol/Phase
	MHz	dBm/m	dBm	dBm/m	dB	dB/m		
1	1673.000	-56.80	-58.02	-13.00	-43.80	1.22	Peak	Vertical
2	PP 2512.000	-53.32	-58.30	-13.00	-40.32	4.98	Peak	Vertical

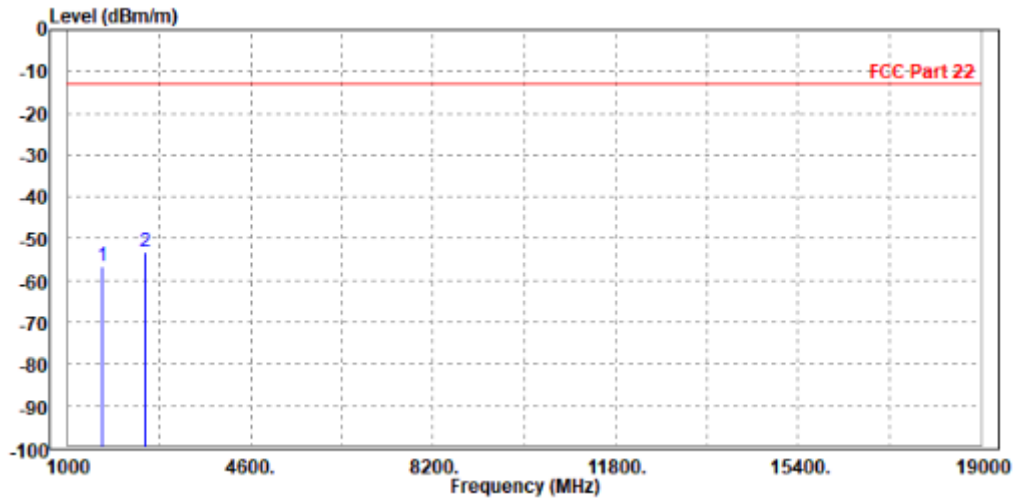



CHANNEL BANDWIDTH: 5MHz / QPSK

MODE	TX channel 20525	FREQUENCY RANGE	Above 1000MHz
ENVIRONMENTAL CONDITIONS	23deg. C, 70%RH	INPUT POWER	DC30V
TESTED BY	Jace Hu		
ANTENNA POLARITY & TEST DISTANCE: HORIZONTAL AT 3 M			

	Freq	Read Level	Limit Level	Over Limit	Factor	Remark	Pol/Phase
	MHz	dBm/m	dBm	dBm/m	dB	dB/m	
1	1673.000	-56.81	-57.79	-13.00	-43.81	0.98	Peak Horizontal
2 PP	2512.000	-53.22	-58.69	-13.00	-40.22	5.47	Peak Horizontal

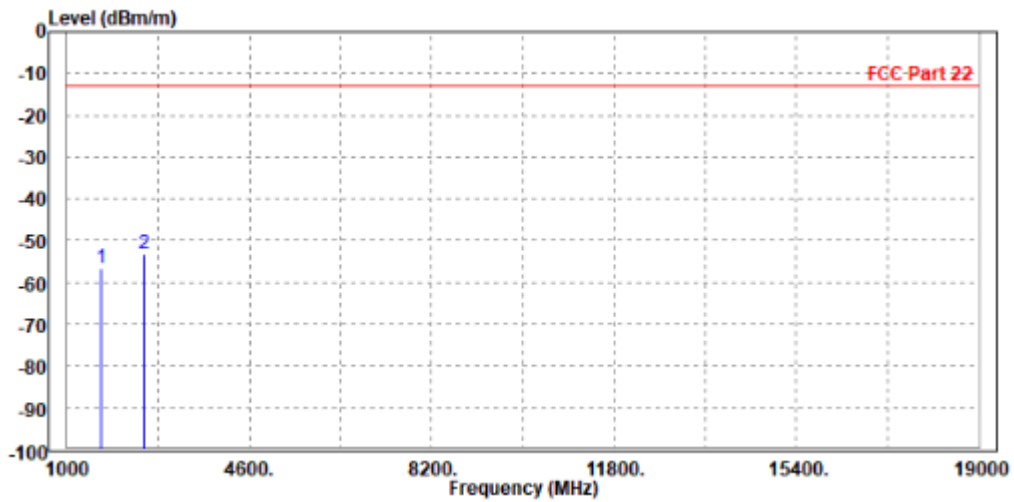



MODE	TX channel 20525	FREQUENCY RANGE	Above 1000MHz
ENVIRONMENTAL CONDITIONS	23deg. C, 70%RH	INPUT POWER	DC30V
TESTED BY	Jace Hu		
ANTENNA POLARITY & TEST DISTANCE: VERTICAL AT 3 M			

	Freq	Level	Read Level	Limit Line	Over Limit	Factor	Remark	Pol/Phase
	MHz	dBm/m	dBm	dBm/m	dB	dB/m		
1	1666.000	-56.85	-58.02	-13.00	-43.85	1.17	Peak	Vertical
2 PP	2509.500	-52.56	-57.53	-13.00	-39.56	4.97	Peak	Vertical

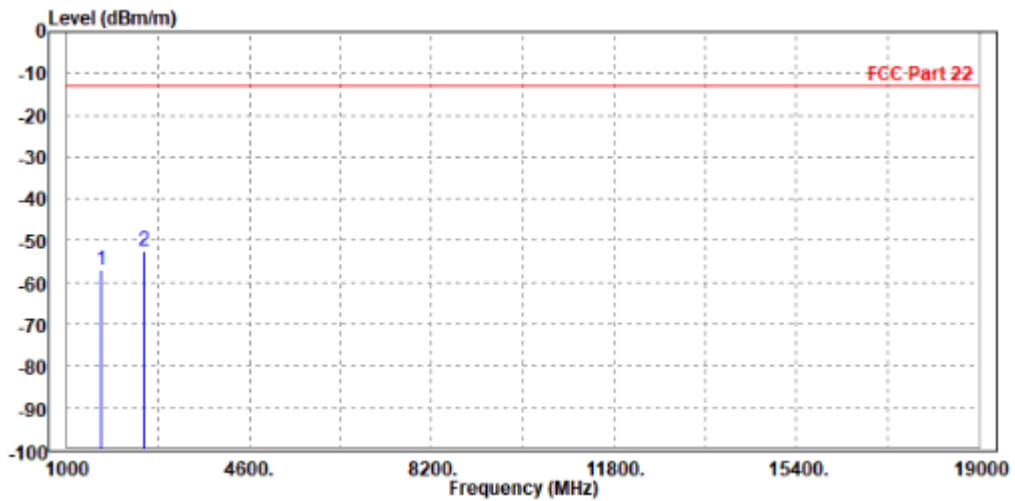



**BUREAU
VERITAS**

Test Report No.: W7L-P22080014RF01

CHANNEL BANDWIDTH: 10MHz / QPSK

CH20450

MODE	TX channel 20450	FREQUENCY RANGE	Above 1000MHz
ENVIRONMENTAL CONDITIONS	23deg. C, 70%RH	INPUT POWER	DC30V
TESTED BY	Jace Hu		
ANTENNA POLARITY & TEST DISTANCE: HORIZONTAL AT 3 M			

	Freq	Level	Read Level	Limit Line	Over Limit	Factor	Remark	Pol/Phase
	MHz	dBm/m	dBm	dBm/m	dB	dB/m		
1	1666.000	-41.55	-42.47	-13.00	-28.55	0.92	Peak	Horizontal
2 PP	2487.000	-25.64	-31.03	-13.00	-12.64	5.39	Peak	Horizontal

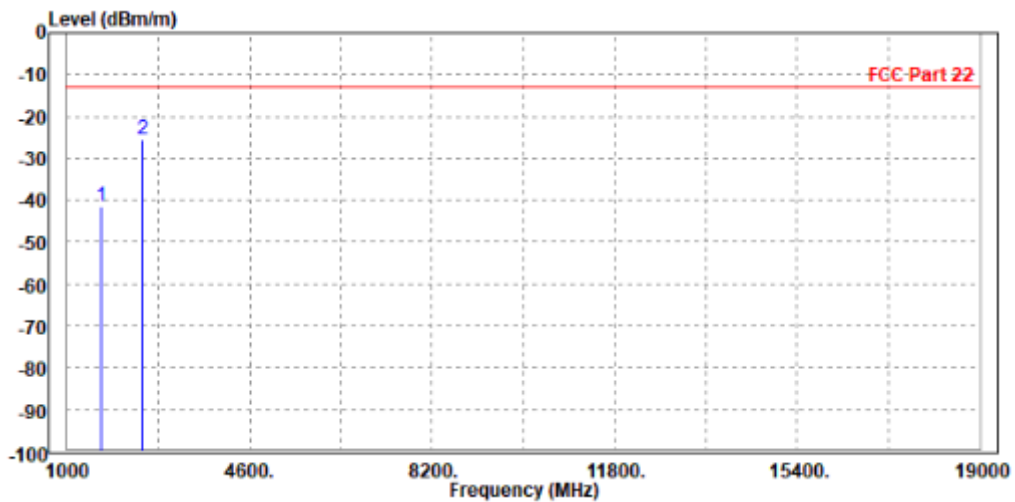



MODE	TX channel 20450	FREQUENCY RANGE	Above 1000MHz
ENVIRONMENTAL CONDITIONS	23deg. C, 70%RH	INPUT POWER	DC30V
TESTED BY	Jace Hu		
ANTENNA POLARITY & TEST DISTANCE: VERTICAL AT 3 M			

	Freq	Level	Read Level	Limit Line	Over Limit	Factor	Remark	Pol/Phase
	MHz	dBm/m	dBm	dBm/m	dB	dB/m		
1	1658.000	-45.15	-46.26	-13.00	-32.15	1.11	Peak	Vertical
2 PP	2494.000	-29.05	-33.97	-13.00	-16.05	4.92	Peak	Vertical

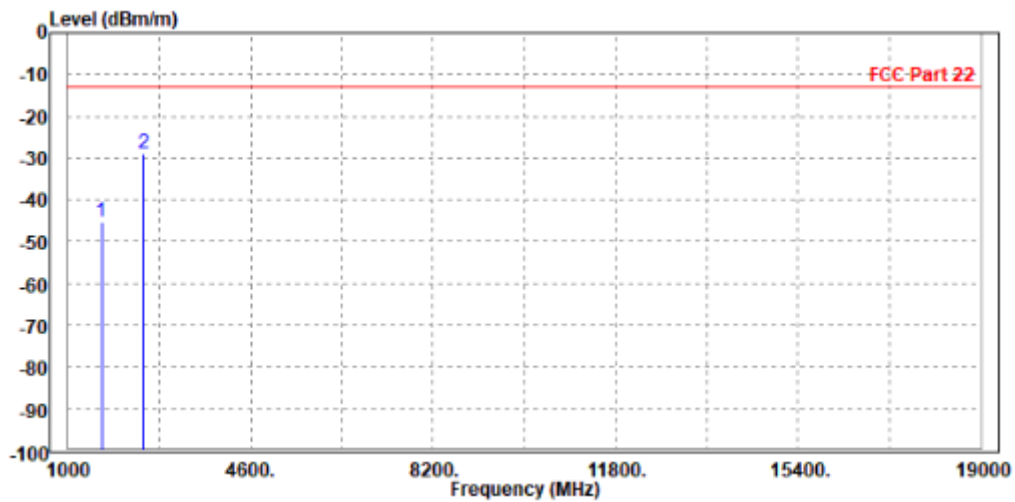



CH20525

MODE	TX channel 20525	FREQUENCY RANGE	Above 1000MHz
ENVIRONMENTAL CONDITIONS	23deg. C, 70%RH	INPUT POWER	DC30V
TESTED BY	Jace Hu		
ANTENNA POLARITY & TEST DISTANCE: HORIZONTAL AT 3 M			

	Freq	Level	Read Level	Limit Line	Over Limit	Factor	Remark	Pol/Phase
	MHz	dBm/m	dBm	dBm/m	dB	dB/m		
1	1673.000	-57.09	-58.07	-13.00	-44.09	0.98	Peak	Horizontal
2 PP	2512.000	-37.61	-43.08	-13.00	-24.61	5.47	Peak	Horizontal

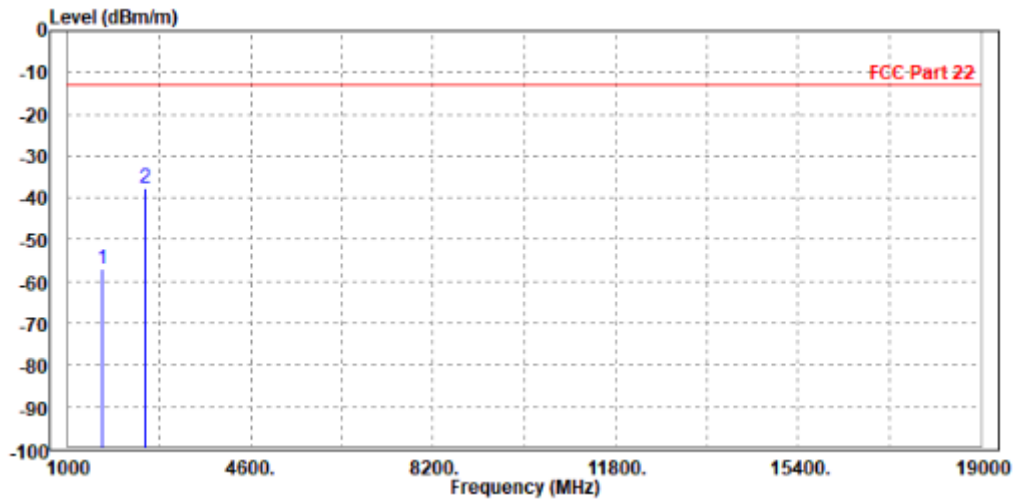



MODE	TX channel 20525	FREQUENCY RANGE	Above 1000MHz
ENVIRONMENTAL CONDITIONS	23deg. C, 70%RH	INPUT POWER	DC30V
TESTED BY	Jace Hu		
ANTENNA POLARITY & TEST DISTANCE: VERTICAL AT 3 M			

	Freq	Level	Read Level	Limit Line	Over Limit	Factor	Remark	Pol/Phase
	MHz	dBm/m	dBm	dBm/m	dB	dB/m		
1	1666.000	-53.92	-55.09	-13.00	-40.92	1.17	Peak	Vertical
2 PP	2509.500	-53.51	-58.48	-13.00	-40.51	4.97	Peak	Vertical

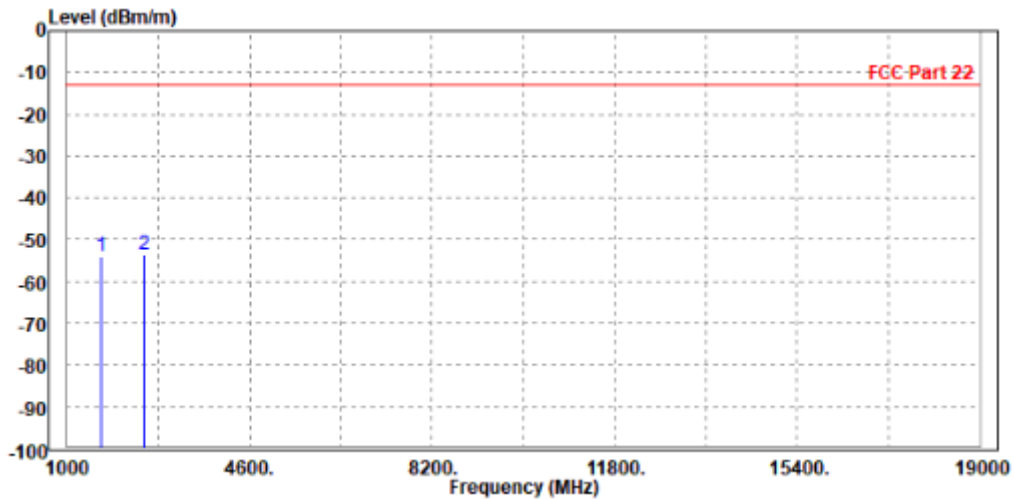



CH20600

MODE	TX channel 20600	FREQUENCY RANGE	Above 1000MHz
ENVIRONMENTAL CONDITIONS	23deg. C, 70%RH	INPUT POWER	DC30V
TESTED BY	Jace Hu		
ANTENNA POLARITY & TEST DISTANCE: HORIZONTAL AT 3 M			

	Freq	Level	Read Level	Limit Line	Over Limit	Factor	Remark	Pol/Phase
	MHz	dBm/m	dBm	dBm/m	dB	dB/m		
1	1688.000	-47.01	-48.11	-13.00	-34.01	1.10	Peak	Horizontal
2 PP	2530.000	-27.25	-32.76	-13.00	-14.25	5.51	Peak	Horizontal

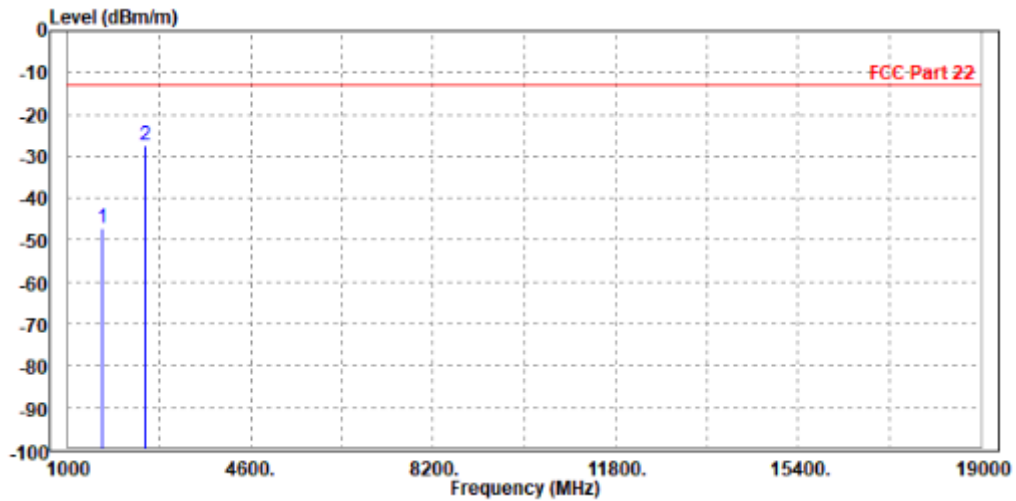



MODE	TX channel 20600	FREQUENCY RANGE	Above 1000MHz
ENVIRONMENTAL CONDITIONS	23deg. C, 70%RH	INPUT POWER	DC30V
TESTED BY	Jace Hu		
ANTENNA POLARITY & TEST DISTANCE: VERTICAL AT 3 M			

	Freq	Level	Read Level	Limit Line	Over Limit	Factor	Remark	Pol/Phase
	MHz	dBm/m	dBm	dBm/m	dB	dB/m		
1	1684.000	-50.88	-52.18	-13.00	-37.88	1.30	Peak	Vertical
2 PP	2532.000	-31.54	-36.58	-13.00	-18.54	5.04	Peak	Vertical

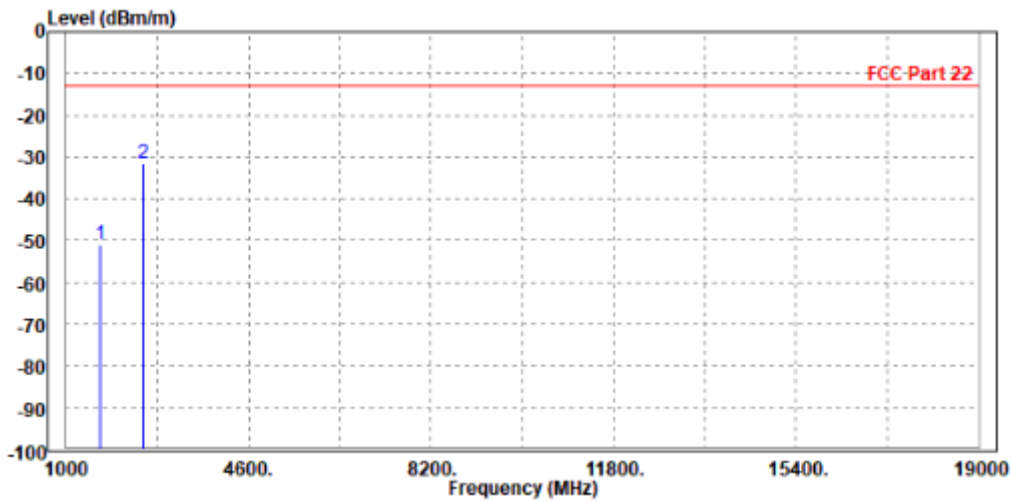

3.7 PEAK TO AVERAGE RATIO

3.7.1 LIMITS OF PEAK TO AVERAGE RATIO MEASUREMENT

In measuring transmissions in this band using an average power technique, the peak to-average ratio (PAR) of the transmission may not exceed 13 dB

3.7.2 TEST SETUP

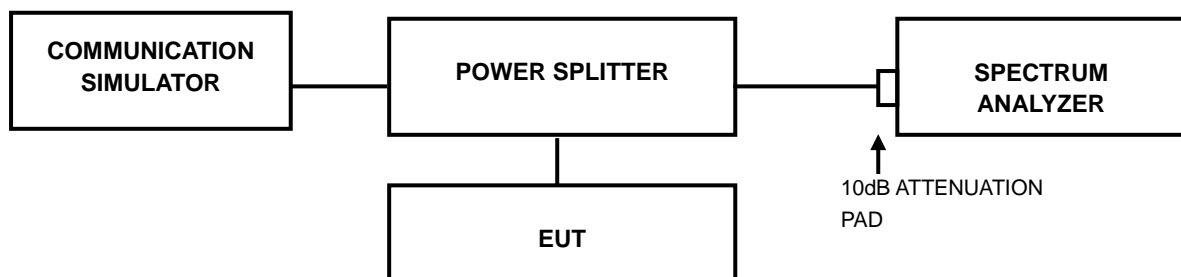

3.7.3 TEST PROCEDURES

1. Set resolution/measurement bandwidth \geq signal's occupied bandwidth;
2. Set the number of counts to a value that stabilizes the measured CCDF curve;
3. Record the maximum PAPR level associated with a probability of 0.1%.



BUREAU
VERITAS

Test Report No.: W7L-P22080014RF01

3.7.4 TEST RESULTS

Please Refer to Module report R2007A0435-R4.



BUREAU
VERITAS

Test Report No.: W7L-P22080014RF01

4 PHOTOGRAPHS OF THE TEST CONFIGURATION

Please refer to the attached file (Test Setup Photo).



**BUREAU
VERITAS**

Test Report No.: W7L-P22080014RF01

5 INFORMATION ON THE TESTING LABORATORIES

We, BV 7LAYERS COMMUNICATIONS TECHNOLOGY (SHENZHEN) CO. LTD., were founded in 2015 to provide our best service in EMC, Radio, Telecom and Safety consultation. Our laboratories are accredited and approved according to ISO/IEC 17025.

If you have any comments, please feel free to contact us at the following:

Shenzhen EMC/RF Lab:

Tel: +86-755-88696566

Fax: +86-755-88696577

Email: customerservice.sw@bureauveritas.com

Web Site: www.adt.com.tw

The address and road map of all our labs can be found in our web site also.



**BUREAU
VERITAS**

Test Report No.: W7L-P22080014RF01

6 MODIFICATIONS RECORDERS FOR ENGINEERING CHANGES TO THE EUT BY THE LAB

No any modifications are made to the EUT by the lab during the test.

---END---