

# FCC TEST REPORT (PART 24)



Applicant:	Particle Industries, Inc
Address:	325 9th Street, San Francisco, CA 94103, United States Of America

Manufacturer or Supplier:	Particle Industries, Inc
Address:	325 9th Street, San Francisco, CA 94103, United States Of America
Product:	TC-3
Brand Name:	FarmHQ
Model Name:	MON404-CODA
FCC ID:	2AEMI-CODA
Date of tests:	Aug. 15, 2022 ~ Sep. 26, 2022

The tests have been carried out according to the requirements of the following standard:

- FCC PART 24, Subpart E**  
  **FCC PART 2**  
 **ANSI/TIA/EIA-603-D**  
  **ANSI/TIA/EIA-603-E**  
  **ANSI C63.26-2015**

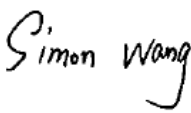
**CONCLUSION:** The submitted sample was found to COMPLY with the test requirement

Prepared by Simon Wang Engineer / Mobile Department	Approved by Luke Lu Manager / Mobile Department
	
Date: Sep. 26, 2022	Date: Sep. 26, 2022

This report is governed by, and incorporates by reference, the Conditions of Testing as posted at the date of issuance of this report at <http://www.bureauveritas.com/home/about-us/our-business/cps/about-us/terms-conditions/> and is intended for your exclusive use. Any copying or replication of this report to or for any other person or entity, or use of our name or trademark, is permitted only with our prior written permission. This report sets forth our findings solely with respect to the test samples identified herein. The results set forth in this report are not indicative or representative of the quality or characteristics of the lot from which a test sample was taken or any similar or identical product unless specifically and expressly noted. Our report includes all of the tests requested by you and the results thereof based upon the information that you provided to us. Measurement uncertainty is only provided upon request for accredited tests. Statements of conformity are based on simple acceptance criteria without taking measurement uncertainty into account, unless otherwise requested in writing. You have 60 days from date of issuance of this report to notify us of any material error or omission caused by our negligence or if you require measurement uncertainty; provided, however, that such notice shall be in writing and shall specifically address the issue you wish to raise. A failure to raise such issue within the prescribed time shall constitute your unqualified acceptance of the completeness of this report, the tests conducted and the correctness of the report contents.



## TABLE OF CONTENTS

<b>RELEASE CONTROL RECORD .....</b>	<b>4</b>
<b>1 SUMMARY OF TEST RESULTS .....</b>	<b>5</b>
1.1 MEASUREMENT UNCERTAINTY .....	5
1.2 TEST SITE AND INSTRUMENTS .....	7
<b>2 GENERAL INFORMATION .....</b>	<b>8</b>
2.1 GENERAL DESCRIPTION OF EUT .....	8
2.2 CONFIGURATION OF SYSTEM UNDER TEST .....	10
2.3 DESCRIPTION OF SUPPORT UNITS .....	11
2.4 TEST ITEM AND TEST CONFIGURATION.....	11
2.5 EUT OPERATING CONDITIONS .....	13
2.6 GENERAL DESCRIPTION OF APPLIED STANDARDS .....	13
<b>3 TEST TYPES AND RESULTS .....</b>	<b>14</b>
3.1 OUTPUT POWER MEASUREMENT .....	14
3.1.1 LIMITS OF OUTPUT POWER MEASUREMENT .....	14
3.1.2 TEST PROCEDURES.....	14
3.1.3 TEST SETUP .....	15
3.1.4 TEST RESULTS.....	15
3.2 FREQUENCY STABILITY MEASUREMENT .....	25
3.2.1 LIMITS OF FREQUENCY STABILITY MEASUREMENT .....	25
3.2.2 TEST PROCEDURE .....	25
3.2.3 TEST SETUP .....	25
3.2.4 TEST RESULTS.....	26
3.3 OCCUPIED BANDWIDTH MEASUREMENT .....	38
3.3.1 LIMITS OF OCCUPIED BANDWIDTH MEASUREMENT .....	38
3.3.2 TEST SETUP .....	38
3.3.3 TEST PROCEDURES.....	38
3.3.4 TEST RESULTS.....	39
3.4 BAND EDGE MEASUREMENTC .....	40
3.4.1 LIMITS OF BAND EDGE MEASUREMENT .....	40
3.4.2 TEST SETUP .....	40
3.4.3 TEST PROCEDURES.....	41
3.4.4 TEST RESULTS.....	42
3.5 CONDUCTED SPURIOUS EMISSIONS.....	43
3.5.1 LIMITS OF CONDUCTED SPURIOUS EMISSIONS MEASUREMENT .....	43
3.5.2 TEST PROCEDURE .....	43
3.5.3 TEST SETUP .....	43
3.5.4 TEST RESULTS.....	44
3.6 RADIATED EMISSION MEASUREMENT .....	45
3.6.1 LIMITS OF RADIATED EMISSION MEASUREMENT .....	45
3.6.2 TEST PROCEDURES.....	45



**BUREAU**  
**VERITAS**

**Test Report No.: W7L-P22080014RF02**

3.6.3 DEVIATION FROM TEST STANDARD .....	45
3.6.4 TEST SETUP .....	46
3.6.5 TEST RESULTS .....	48
3.7 PEAK TO AVERAGE RATIO .....	84
3.7.1 LIMITS OF PEAK TO AVERAGE RATIO MEASUREMENT .....	84
3.7.2 TEST SETUP .....	84
3.7.3 TEST PROCEDURES .....	84
3.7.4 TEST RESULTS .....	85
<b>4 INFORMATION ON THE TESTING LABORATORIES .....</b>	<b>86</b>
<b>5 MODIFICATIONS RECORDERS FOR ENGINEERING CHANGES TO THE EUT BY THE LAB.....</b>	<b>87</b>



**BUREAU**  
**VERITAS**

Test Report No.: W7L-P22080014RF02

## RELEASE CONTROL RECORD

ISSUE NO.	REASON FOR CHANGE	DATE ISSUED
W7L-P22080014RF02	Original release	Sep. 26, 2022



# 1 SUMMARY OF TEST RESULTS

The EUT has been tested according to the following specifications:

APPLIED STANDARD: FCC Part 24 & Part 2		
STANDARD SECTION	TEST TYPE	RESULT
§2.1046	Coducted Output Power	Compliance
§24.232(c)	Equivalent Isotropic Radiated Power	Compliance
§2.1055 §24.235	Frequency Stability	Compliance
§2.1049	Occupied Bandwidth	See Note
§24.232(d)	Peak to average ratio	See Note
§24.238(a)(b)	Band Edge Measurements	See Note
§2.1051 §24.238(a)(b)	Conducted Spurious Emissions	See Note
§2.1053 §24.238(a)(b)	Radiated Spurious Emissions	Compliance

**NOTE:** Refer to Module report R2007A0435-R5, FCC ID: XMR201707BG96.

## 1.1 MEASUREMENT UNCERTAINTY

Where relevant, the following measurement uncertainty levels have been estimated for tests performed on the EUT as specified in CISPR 16-4-2:

MEASUREMENT	UNCERTAINTY
Frequency Stability	± 76.97Hz
Radiated emissions (9KHz~30MHz)	±2.68dB
Radiated emissions & Radiated Power (30MHz~1GMHz)	±4.98dB
Radiated emissions & Radiated Power (1GMHz ~6GMHz)	±4.70dB
Radiated emissions (6GMHz ~18GMHz)	±4.60dB
Radiated emissions (18GMHz ~40GMHz)	±4.12dB
Conducted emissions	±4.01dB
Occupied Channel Bandwidth	±43.58KHz
Conducted Output power	±2.06dB



**BUREAU**  
**VERITAS**

**Test Report No.: W7L-P22080014RF02**

Band Edge Measurements	±4.70dB
Peak to average ratio	±0.76dB

This uncertainty represents an expanded uncertainty expressed at approximately the 95% confidence level using a coverage factor of k=2.



## 1.2 TEST SITE AND INSTRUMENTS

Equipment	Manufacturer	Model No.	Serial No.	Last Cal.	Next Cal.
MXE EMI Receiver	KEYSIGHT	N9038A-544	MY54450026	Feb. 18,22	Feb. 17,23
EXA Signal Analyzer	KEYSIGHT	N9010A-544	MY54510355	May.15,22	May.14,23
Loop Antenna	Schwarzbeck	FMZB 1519B	00173	Sep.05,21	Sep.04,22
Loop Antenna	Schwarzbeck	FMZB 1519B	00173	Sep.04,22	Sep.03,23
Bilog Antenna	ETS-LINDGRE N	3143B	00161965	Mar. 06,22	Mar. 05,23
Horn Antenna	ETS-LINDGRE N	3117	00168692	Mar. 06,22	Mar. 05,23
Horn Antenna (18GHz-40GHz)	N/A	QWH-SL-18-40-K- SG/QMS-00361	15433	Aug. 25, 21	Aug. 24, 22
Horn Antenna (18GHz-40GHz)	N/A	QWH-SL-18-40-K- SG/QMS-00361	15433	Aug. 24, 22	Aug. 23, 23
Radio Communication Analyzer	ANRITSU	MT8820C	6201465426	Feb. 15,22	Feb. 14,23
Signal Pre-Amplifier	EMSI	EMC 9135	980249	May.12,22	May.11,23
Signal Pre-Amplifier	EMSI	EMC 012645B	980257	May.12,22	May.11,23
Signal Pre-Amplifier	EMSI	EMC 184045B	980259	Feb. 21,22	Feb.20,23
3m Semi-anechoic Chamber	ETS-LINDGRE N	9m*6m*6m	Euroshieldpn- CT0001143-121 6	May. 19,20	May. 18,23
Test Software	E3	V 9.160323	N/A	N/A	N/A
Test Software	JS1120	3.1.36	N/A	N/A	N/A
10dB Attenuator	JFW/USA	50HF-010-SMA	1505	May. 07,22	May. 06,23
Power Meter	Anritsu	ML2495A	1506002	Feb. 22,22	Feb. 21,23
Power Sensor	Anritsu	MA2411B	1339352	May. 07,22	May. 06,23
Temperature Chamber	ESPEC	SH-242	93000855	May. 12,22	May. 11,23
MXG Analog Microwave Signal Generator	KEYSIGHT	N5183A	MY50143024	Feb. 18,22	Feb. 17,23
Base station R&S CMW500	Rohde&Schwa rz	CMW500	153085	May.12,22	May.11,23
DC Source	Agilent	U8002A	64827	May. 07,22	May. 06,23

- NOTE:** 1. The calibration interval of the above test instruments is 12 months or 36 months and the calibrations are traceable to CEPREI/CHINA, GRGT/CHINA and NIM/CHINA.
2. The test was performed in 3m Semi-anechoic Chamber and RF Oven Room.
3. The horn antenna is used only for the measurement of emission frequency above 1GHz if tested.
4. The FCC Site Registration No. is 525120; The Designation No. is CN1171.



## 2 GENERAL INFORMATION

### 2.1 GENERAL DESCRIPTION OF EUT

<b>PRODUCT</b>	TC-3	
<b>BRAND NAME</b>	FarmHQ	
<b>MODEL NAME</b>	MON404-CODA	
<b>NOMINAL VOLTAGE</b>	30Vdc (DC Source) 3.7Vdc (Li-ion, battery)	
<b>MODULATION TYPE</b>	LTE Band 2: QPSK, 16QAM	
<b>FREQUENCY RANGE</b>	LTE Band 2 Channel Bandwidth: 1.4MHz	1850.7MHz ~ 1909.3MHz
	LTE Band 2 Channel Bandwidth: 3MHz	1851.5MHz ~ 1908.5MHz
	LTE Band 2 Channel Bandwidth: 5MHz	1852.5MHz ~ 1907.5MHz
	LTE Band 2 Channel Bandwidth: 10MHz	1855.0MHz ~ 1905.0MHz
	LTE Band 2 Channel Bandwidth: 15MHz	1857.5MHz ~ 1902.5MHz
	LTE Band 2 Channel Bandwidth: 20MHz	1860.0MHz ~ 1900.0MHz
<b>MAX. EIRP POWER</b>	LTE Band 2 Channel Bandwidth: 1.4MHz	440.55mW
	LTE Band 2 Channel Bandwidth: 3MHz	443.61mW
	LTE Band 2 Channel Bandwidth: 5MHz	440.55mW
	LTE Band 2 Channel Bandwidth: 10MHz	439.54mW
	LTE Band 2 Channel Bandwidth: 15MHz	441.57mW
	LTE Band 2 Channel Bandwidth: 20MHz	445.66mW
<b>EMISSION DESIGNATOR</b>	LTE Band 2 Channel Bandwidth: 1.4MHz	QPSK: 1M11G7D
		16QAM: 948KW7D
	LTE Band 2 Channel Bandwidth: 3MHz	QPSK: 1M16G7D
		16QAM: 985KW7D
	LTE Band 2 Channel Bandwidth: 5MHz	QPSK: 1M17G7D
		16QAM: 1M01W7D
	LTE Band 2 Channel Bandwidth: 10MHz	QPSK: 1M19G7D
		16QAM: 1M19W7D





	<b>LTE Band 2 Channel Bandwidth: 15MHz</b>	QPSK: 1M22G7D
		16QAM: 1M90W7D
	<b>LTE Band 2 Channel Bandwidth: 20MHz</b>	QPSK: 1M25G7D
		16QAM: 1M15W7D
<b>ANTENNA TYPE</b>	Internal Antenna with 3.47dBi gain for LTE B2 Magnet Mount Antenna with 0.69dBi gain for LTE B2	
<b>HW VERSION</b>	v1.2.0	
<b>SW VERSION</b>	v3.3.0	
<b>I/O PORTS</b>	Refer to user's manual	
<b>CABLE SUPPLIED</b>	N/A	
<b>EXTREME TEMPERATURE</b>	-40-85 °C	
<b>EXTREME VOLTAGE</b>	Battery 3.6V - 4.2V	
	DC 8V- 48V	

**NOTE:**

- For a more detailed features description, please refer to the manufacturer's specifications or the user's manual.
- The EUT incorporates a SISO function. Physically, the EUT provides one completed transmitter and one receiver.

<b>MODULATION MODE</b>	<b>TX FUNCTION</b>
<b>LTE</b>	1TX/1RX

- For the test results, the EUT had been tested with all conditions. But only the worst case was shown in test report.

**List of Accessory:**

<b>ACCESSORIES</b>	<b>BRAND</b>	<b>MANUFACTURER</b>	<b>MODEL</b>	<b>SPECIFICATION</b>
Battery		Guang Dong Zhao Neng Technology Co.,Ltd	18650-4P	Capacity : 3.7Vdc, 11800mAh



## 2.2 CONFIGURATION OF SYSTEM UNDER TEST

### FOR RADIATION EMISSION

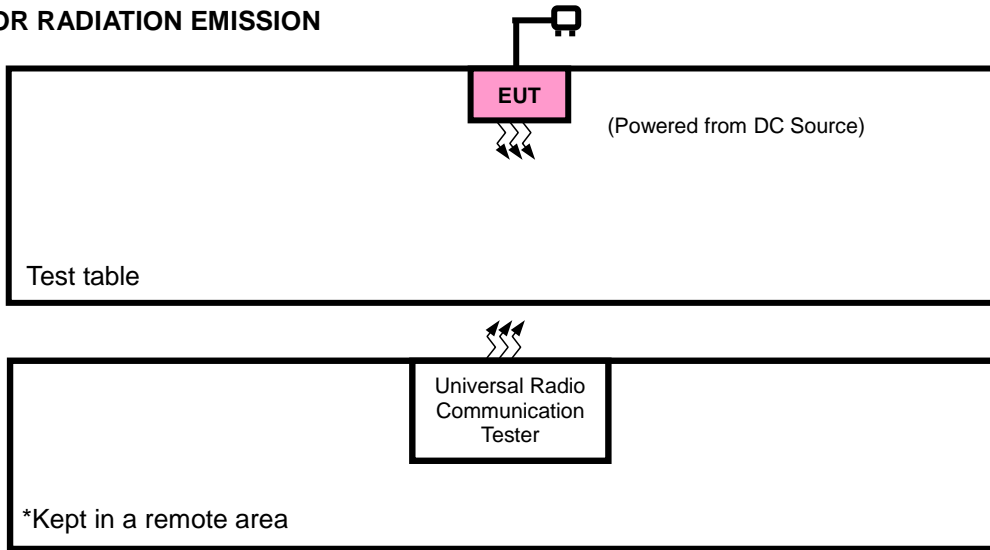



### 2.3 DESCRIPTION OF SUPPORT UNITS

The EUT has been tested as an independent unit together with other necessary accessories or support units. The following support units or accessories were used to form a representative test configuration during the tests.

NO.	PRODUCT	BRAND	MODEL NO.	SERIAL NO.	FCC ID
1	DC source	Agilent	U8002A	N/A	N/A
2	Power Cable	N/A	N/A	N/A	N/A

NO.	SIGNAL CABLE DESCRIPTION OF THE ABOVE SUPPORT UNITS
1	N/A

### 2.4 TEST ITEM AND TEST CONFIGURATION

Pre-Scan has been conducted to determine the worst-case mode from all possible combinations between available modulations, data rates, XYZ axis and antenna ports. The worst case in EIRP and radiated emission was found when positioned on X-plane for LTE. Following channel(s) was (were) selected for the final test as listed below, pre-scan A and B mode, worst case is A mode and only Frequency Stability embody two sets of data, other data embody mode A.

EUT CONFIGURE MODE	DESCRIPTION
A	EUT + DC Source with LTE link
B	EUT + Battery with LTE link



**LTE BAND 2 MODE**

EUT CONFIGURE MODE	TEST ITEM	AVAILABLE CHANNEL	TESTED CHANNEL	CHANNEL BANDWIDTH	MODULATION	MODE
A/B	EIRP	18607 to 19193	18607, 18900, 19193	1.4MHz	QPSK,16QAM	1 RB / 0 RB Offset
		18615 to 19185	18615, 18900, 19185	3MHz	QPSK,16QAM	1 RB / 0 RB Offset
		18625 to 19175	18625, 18900, 19175	5MHz	QPSK,16QAM	1 RB / 0 RB Offset
		18650 to 19150	18650, 18900, 19150	10MHz	QPSK,16QAM	1 RB / 0 RB Offset
		18675 to 19125	18675, 18900, 19125	15MHz	QPSK,16QAM	1 RB / 0 RB Offset
		18700 to 19100	18700, 18900, 19100	20MHz	QPSK,16QAM	1 RB / 0 RB Offset
A/B	FREQUENCY STABILITY	18607 to 19193	18607, 18900, 19193	1.4MHz	QPSK,16QAM	6 RB / 0 RB Offset
		18615 to 19185	18615, 18900, 19185	3MHz	QPSK,16QAM	6 RB / 0 RB Offset
		18625 to 19175	18625, 18900, 19175	5MHz	QPSK,16QAM	6 RB / 0 RB Offset
		18650 to 19150	18650, 18900, 19150	10MHz	QPSK,16QAM	6 RB / 0 RB Offset
		18675 to 19125	18675, 18900, 19125	15MHz	QPSK,16QAM	6 RB / 0 RB Offset
		18700 to 19100	18700, 18900, 19100	20MHz	QPSK,16QAM	6 RB / 0 RB Offset
A/B	RADIATED EMISSION	18607 to 19193	8900	1.4MHz	QPSK	1 RB / 0 RB Offset
		18615 to 19185	18900	3MHz	QPSK	1 RB / 0 RB Offset
		18625 to 19175	18900	5MHz	QPSK	1 RB / 0 RB Offset
		18650 to 19150	18900	10MHz	QPSK	1 RB / 0 RB Offset
		18675 to 19125	18900	15MHz	QPSK	1 RB / 0 RB Offset
		18700 to 19100	18700, 18900, 19100	20MHz	QPSK	1 RB / 0 RB Offset



**TEST CONDITION:**

TEST ITEM	ENVIRONMENTAL CONDITIONS	INPUT POWER	TESTED BY
EIRP	25deg. C, 57%RH	DC 30V By DC Source	Jace Hu
FREQUENCY STABILITY	23deg. C, 61%RH	DC 3.7V By Battery DC 30V By DC Source	James Fu
RADIATED EMISSION	23deg. C, 70%RH	DC 30V By DC Source	Jace Hu

**2.5 EUT OPERATING CONDITIONS**

The EUT makes a call to the communication simulator. The communication simulator station system controlled a EUT to export maximum output power under transmission mode and specific channel frequency

**2.6 GENERAL DESCRIPTION OF APPLIED STANDARDS**

The EUT is a RF product. According to the specifications of the manufacturer, it must comply with the requirements of the following standards:

**FCC 47 CFR Part 2**

**FCC 47 CFR Part 24**

**KDB 971168 D01 Power Meas License Digital Systems v03r01**

**ANSI/TIA/EIA-603-D**

**ANSI/TIA/EIA-603-E**

**ANSI C63.26-2015**

**NOTE:** All test items have been performed and recorded as per the above standards.

## 3 TEST TYPES AND RESULTS

### 3.1 OUTPUT POWER MEASUREMENT

#### 3.1.1 LIMITS OF OUTPUT POWER MEASUREMENT

Mobile and portable stations are limited to 2 watts EIRP.

#### 3.1.2 TEST PROCEDURES

##### EIRP MEASUREMENT:

Per KDB 971168 D01 Power Meas License Digital Systems v03r01 or subclause 5.2.5.5 of ANSI C63.26-2015, the relevant equation for determining the ERP or EIRP from the conducted RF output power measured using the guidance provided above is:

$$\text{ERP or EIRP} = P_{\text{Meas}} + G_{\text{T}} - L_{\text{C}}$$

Where:

ERP or EIRP = effective radiated power or equivalent isotropically radiated power, respectively

(expressed in the same units as  $P_{\text{Meas}}$ , typically dBW or dBm);

$P_{\text{Meas}}$  = measured transmitter output power or PSD, in dBm or dBW;

$G_{\text{T}}$  = gain of the transmitting antenna, in dBd (ERP) or dBi (EIRP);

$L_{\text{C}}$  = signal attenuation in the connecting cable between the transmitter and antenna, in dB.

##### CONDUCTED POWER MEASUREMENT:

The EUT was set up for the maximum power with WCDMA link data modulation and link up with simulator. Set the EUT to transmit under low, middle and high channel and record the power level shown on simulator.



### 3.1.3 TEST SETUP

**NOTE: PRE-SCAN BATTERY SUPPLY AND DC SOURCE,WORSE CASE IS DC SOURCE**

**EIRP / ERP Measurement:**

**CONDUCTED POWER MEASUREMENT:**

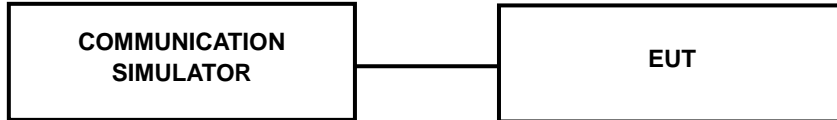

### 3.1.4 TEST RESULTS

**CONDUCTED OUTPUT POWER (dBm)**

**LTE BAND 2**

Band/BW	Modulation	RB Size	RB Offset	Low CH 18607	Mid CH 18900	High CH 19193
				Frequency 1850.7 MHz	Frequency 1880 MHz	Frequency 1909.3 MHz
2/ 1.4	QPSK	1	0	22.66	22.51	22.97
		1	5	22.71	22.45	22.97
		3	0	22.61	22.38	22.75
		3	3	22.54	22.32	22.81
		6	0	22.69	22.46	22.85
	16QAM	1	0	22.65	22.45	22.90
		1	5	22.71	22.45	22.96
		3	0	22.64	22.38	22.93
		3	3	22.53	22.39	22.79
		6	0	22.45	22.26	22.71



**BUREAU  
VERITAS**

**Test Report No.: W7L-P22080014RF02**

Band/BW	Modulation	RB Size	RB Offset	Low CH 18615	Mid CH 18900	High CH 19185
				Frequency 1851.5 MHz	Frequency 1880 MHz	Frequency 1908.5 MHz
2/3	QPSK	1	0	22.65	22.50	23.00
		1	5	22.72	22.43	22.97
		3	0	22.54	22.39	22.78
		3	3	22.55	22.35	22.86
		6	0	22.64	22.50	22.82
	16QAM	1	0	22.63	22.47	22.93
		1	5	22.65	22.51	22.93
		3	0	22.63	22.44	22.88
		3	3	22.50	22.39	22.82
		6	0	22.45	22.21	22.71

Band/BW	Modulation	RB Size	RB Offset	Low CH 18625	Mid CH 18900	High CH 19175
				Frequency 1852.5 MHz	Frequency 1880 MHz	Frequency 1907.5 MHz
2/5	QPSK	1	0	22.65	22.56	22.96
		1	5	22.67	22.46	22.97
		3	0	22.54	22.38	22.77
		3	3	22.51	22.39	22.85
		6	0	22.66	22.47	22.79
	16QAM	1	0	22.62	22.51	22.93
		1	5	22.68	22.48	22.94
		3	0	22.66	22.40	22.92
		3	3	22.55	22.37	22.79
		6	0	22.45	22.20	22.74





Band/BW	Modulation	RB Size	RB Offset	Low CH 18650	Mid CH 18900	High CH 19150
				Frequency 1855 MHz	Frequency 1880 MHz	Frequency 1905 MHz
2/ 10	QPSK	1	0	22.70	22.54	22.94
		1	5	22.70	22.48	22.93
		3	0	22.61	22.38	22.78
		3	3	22.51	22.33	22.85
		6	0	22.69	22.48	22.84
	16QAM	1	0	22.67	22.51	22.89
		1	5	22.69	22.48	22.96
		3	0	22.61	22.42	22.89
		3	3	22.54	22.38	22.82
		6	0	22.50	22.23	22.68

Band/BW	Modulation	RB Size	RB Offset	Low CH 18675	Mid CH 18900	High CH 19125
				Frequency 1857.5 MHz	Frequency 1880 MHz	Frequency 1902.5 MHz
2/ 15	QPSK	1	0	22.63	22.54	22.97
		1	5	22.72	22.43	22.98
		3	0	22.60	22.33	22.78
		3	3	22.53	22.32	22.85
		6	0	22.69	22.50	22.79
	16QAM	1	0	22.63	22.44	22.89
		1	5	22.70	22.47	22.96
		3	0	22.67	22.38	22.93
		3	3	22.49	22.40	22.79
		6	0	22.49	22.20	22.75



**BUREAU**  
**VERITAS**

**Test Report No.: W7L-P22080014RF02**

Band/BW	Modulation	RB Size	RB Offset	Low CH 18700	Mid CH 18900	High CH 19100
				Frequency 1860 MHz	Frequency 1880 MHz	Frequency 1900 MHz
2/ 20	QPSK	1	0	22.71	22.58	23.02
		1	5	22.74	22.51	22.99
		3	0	22.62	22.40	22.83
		3	3	22.59	22.40	22.87
		6	0	22.70	22.52	22.87
	16QAM	1	0	22.70	22.52	22.95
		1	5	22.73	22.53	22.98
		3	0	22.69	22.46	22.94
		3	3	22.57	22.44	22.84
		6	0	22.51	22.28	22.76



**EIRP POWER (dBm)**

Internal Antenna:

**LTE BAND 2**

**CHANNEL BANDWIDTH: 1.4MHz QPSK**

Channel	Frequency (MHz)	Conducted Power (dBm)	G <sub>T</sub> -L <sub>C</sub> (dB)	EIRP (dBm)	EIRP (mW)	Limit (W)
18607	1850.7	22.71	3.47	26.18	414.95	2
18900	1880.0	22.51	3.47	25.98	396.28	2
19193	1909.3	22.97	3.47	26.44	440.55	2

**CHANNEL BANDWIDTH: 1.4MHz 16QAM**

Channel	Frequency (MHz)	Conducted Power (dBm)	G <sub>T</sub> -L <sub>C</sub> (dB)	EIRP (dBm)	EIRP (mW)	Limit (W)
18607	1850.7	22.71	3.47	26.18	414.95	2
18900	1880.0	22.45	3.47	25.92	390.84	2
19193	1909.3	22.96	3.47	26.43	439.54	2

**CHANNEL BANDWIDTH: 3MHz QPSK**

Channel	Frequency (MHz)	Conducted Power (dBm)	G <sub>T</sub> -L <sub>C</sub> (dB)	EIRP (dBm)	EIRP (mW)	Limit (W)
18615	1851.5	22.72	3.47	26.19	415.91	2
18900	1880.0	22.5	3.47	25.97	395.37	2
19185	1908.5	23	3.47	26.47	443.61	2

**CHANNEL BANDWIDTH: 3MHz 16QAM**

Channel	Frequency (MHz)	Conducted Power (dBm)	G <sub>T</sub> -L <sub>C</sub> (dB)	EIRP (dBm)	EIRP (mW)	Limit (W)
18615	1851.5	22.65	3.47	26.12	409.26	2
18900	1880.0	22.51	3.47	25.98	396.28	2
19185	1908.5	22.93	3.47	26.4	436.52	2



**CHANNEL BANDWIDTH: 5MHz QPSK**

Channel	Frequency (MHz)	Conducted Power (dBm)	G <sub>T</sub> -L <sub>C</sub> (dB)	EIRP (dBm)	EIRP (mW)	Limit (W)
18625	1852.5	22.67	3.47	26.14	411.15	2
18900	1880.0	22.56	3.47	26.03	400.87	2
19175	1907.5	22.97	3.47	26.44	440.55	2

**CHANNEL BANDWIDTH: 5MHz 16QAM**

Channel	Frequency (MHz)	Conducted Power (dBm)	G <sub>T</sub> -L <sub>C</sub> (dB)	EIRP (dBm)	EIRP (mW)	Limit (W)
18625	1852.5	22.68	3.47	26.15	412.1	2
18900	1880.0	22.51	3.47	25.98	396.28	2
19175	1907.5	22.94	3.47	26.41	437.52	2

**CHANNEL BANDWIDTH: 10MHz QPSK**

Channel	Frequency (MHz)	Conducted Power (dBm)	G <sub>T</sub> -L <sub>C</sub> (dB)	EIRP (dBm)	EIRP (mW)	Limit (W)
18650	1855.0	22.7	3.47	26.17	414	2
18900	1880.0	22.54	3.47	26.01	399.02	2
19150	1905.0	22.94	3.47	26.41	437.52	2

**CHANNEL BANDWIDTH: 10MHz 16QAM**

Channel	Frequency (MHz)	Conducted Power (dBm)	G <sub>T</sub> -L <sub>C</sub> (dB)	EIRP (dBm)	EIRP (mW)	Limit (W)
18650	1855.0	22.69	3.47	26.16	413.05	2
18900	1880.0	22.51	3.47	25.98	396.28	2
19150	1905.0	22.96	3.47	26.43	439.54	2



**CHANNEL BANDWIDTH: 15MHz QPSK**

Channel	Frequency (MHz)	Conducted Power (dBm)	G <sub>T-Lc</sub> (dB)	EIRP (dBm)	EIRP (mW)	Limit (W)
18675	1857.5	22.72	3.47	26.19	415.91	2
18900	1880.0	22.54	3.47	26.01	399.02	2
19125	1902.5	22.98	3.47	26.45	441.57	2

**CHANNEL BANDWIDTH: 15MHz 16QAM**

Channel	Frequency (MHz)	Conducted Power (dBm)	G <sub>T-Lc</sub> (dB)	EIRP (dBm)	EIRP (mW)	Limit (W)
18675	1857.5	22.7	3.47	26.17	414	2
18900	1880.0	22.47	3.47	25.94	392.64	2
19125	1902.5	22.96	3.47	26.43	439.54	2

**CHANNEL BANDWIDTH: 20MHz QPSK**

Channel	Frequency (MHz)	Conducted Power (dBm)	G <sub>T-Lc</sub> (dB)	EIRP (dBm)	EIRP (mW)	Limit (W)
18700	1860	22.74	3.47	26.21	417.83	2
18900	1880	22.58	3.47	26.05	402.72	2
19100	1900	23.02	3.47	26.49	445.66	2

**CHANNEL BANDWIDTH: 20MHz 16QAM**

Channel	Frequency (MHz)	Conducted Power (dBm)	G <sub>T-Lc</sub> (dB)	EIRP (dBm)	EIRP (mW)	Limit (W)
18700	1860	22.73	3.47	26.2	416.87	2
18900	1880	22.53	3.47	26	398.11	2
19100	1900	22.98	3.47	26.45	441.57	2



**Magnet Mount Antenna:**

**CHANNEL BANDWIDTH: 1.4MHz QPSK**

Channel	Frequency (MHz)	Conducted Power (dBm)	G <sub>T-Lc</sub> (dB)	EIRP (dBm)	EIRP (mW)	Limit (W)
18607	1850.7	22.71	0.69	23.4	218.78	2
18900	1880.0	22.51	0.69	23.2	208.93	2
19193	1909.3	22.97	0.69	23.66	232.27	2

**CHANNEL BANDWIDTH: 1.4MHz 16QAM**

Channel	Frequency (MHz)	Conducted Power (dBm)	G <sub>T-Lc</sub> (dB)	EIRP (dBm)	EIRP (mW)	Limit (W)
18607	1850.7	22.71	0.69	23.4	218.78	2
18900	1880.0	22.45	0.69	23.14	206.06	2
19193	1909.3	22.96	0.69	23.65	231.74	2

**CHANNEL BANDWIDTH: 3MHz QPSK**

Channel	Frequency (MHz)	Conducted Power (dBm)	G <sub>T-Lc</sub> (dB)	EIRP (dBm)	EIRP (mW)	Limit (W)
18615	1851.5	22.72	0.69	23.41	219.28	2
18900	1880.0	22.5	0.69	23.19	208.45	2
19185	1908.5	23	0.69	23.69	233.88	2

**CHANNEL BANDWIDTH: 3MHz 16QAM**

Channel	Frequency (MHz)	Conducted Power (dBm)	G <sub>T-Lc</sub> (dB)	EIRP (dBm)	EIRP (mW)	Limit (W)
18615	1851.5	22.65	0.69	23.34	215.77	2
18900	1880.0	22.51	0.69	23.2	208.93	2
19185	1908.5	22.93	0.69	23.62	230.14	2



**CHANNEL BANDWIDTH: 5MHz QPSK**

Channel	Frequency (MHz)	Conducted Power (dBm)	G <sub>T</sub> -L <sub>C</sub> (dB)	EIRP (dBm)	EIRP (mW)	Limit (W)
18625	1852.5	22.67	0.69	23.36	216.77	2
18900	1880.0	22.56	0.69	23.25	211.35	2
19175	1907.5	22.97	0.69	23.66	232.27	2

**CHANNEL BANDWIDTH: 5MHz 16QAM**

Channel	Frequency (MHz)	Conducted Power (dBm)	G <sub>T</sub> -L <sub>C</sub> (dB)	EIRP (dBm)	EIRP (mW)	Limit (W)
18625	1852.5	22.68	0.69	23.37	217.27	2
18900	1880.0	22.51	0.69	23.2	208.93	2
19175	1907.5	22.94	0.69	23.63	230.67	2

**CHANNEL BANDWIDTH: 10MHz QPSK**

Channel	Frequency (MHz)	Conducted Power (dBm)	G <sub>T</sub> -L <sub>C</sub> (dB)	EIRP (dBm)	EIRP (mW)	Limit (W)
18650	1855.0	22.7	0.69	23.39	218.27	2
18900	1880.0	22.54	0.69	23.23	210.38	2
19150	1905.0	22.94	0.69	23.63	230.67	2

**CHANNEL BANDWIDTH: 10MHz 16QAM**

Channel	Frequency (MHz)	Conducted Power (dBm)	G <sub>T</sub> -L <sub>C</sub> (dB)	EIRP (dBm)	EIRP (mW)	Limit (W)
18650	1855.0	22.69	0.69	23.38	217.77	2
18900	1880.0	22.51	0.69	23.2	208.93	2
19150	1905.0	22.96	0.69	23.65	231.74	2



**CHANNEL BANDWIDTH: 15MHz QPSK**

Channel	Frequency (MHz)	Conducted Power (dBm)	G <sub>T-Lc</sub> (dB)	EIRP (dBm)	EIRP (mW)	Limit (W)
18675	1857.5	22.72	0.69	23.41	219.28	2
18900	1880.0	22.54	0.69	23.23	210.38	2
19125	1902.5	22.98	0.69	23.67	232.81	2

**CHANNEL BANDWIDTH: 15MHz 16QAM**

Channel	Frequency (MHz)	Conducted Power (dBm)	G <sub>T-Lc</sub> (dB)	EIRP (dBm)	EIRP (mW)	Limit (W)
18675	1857.5	22.7	0.69	23.39	218.27	2
18900	1880.0	22.47	0.69	23.16	207.01	2
19125	1902.5	22.96	0.69	23.65	231.74	2

**CHANNEL BANDWIDTH: 20MHz QPSK**

Channel	Frequency (MHz)	Conducted Power (dBm)	G <sub>T-Lc</sub> (dB)	EIRP (dBm)	EIRP (mW)	Limit (W)
18700	1860	22.74	0.69	23.43	220.29	2
18900	1880	22.58	0.69	23.27	212.32	2
19100	1900	23.02	0.69	23.71	234.96	2

**CHANNEL BANDWIDTH: 20MHz 16QAM**

Channel	Frequency (MHz)	Conducted Power (dBm)	G <sub>T-Lc</sub> (dB)	EIRP (dBm)	EIRP (mW)	Limit (W)
18700	1860	22.73	0.69	23.42	219.79	2
18900	1880	22.53	0.69	23.22	209.89	2
19100	1900	22.98	0.69	23.67	232.81	2





### 3.2 FREQUENCY STABILITY MEASUREMENT

#### 3.2.1 LIMITS OF FREQUENCY STABILITY MEASUREMENT

The frequency stability shall be sufficient to ensure that the fundamental emission stays within the authorized frequency block.

#### 3.2.2 TEST PROCEDURE

- Device is placed at the oven room. The oven room could control the temperatures and humidity. Power warm up is at least 15 min and power applied should perform before recording frequency error.
- Connect the external power supply to the DC input power supply or battery power supply. The test voltage range is from minimum to maximum working voltage. Each step shall be record the frequency error rate.
- The temperature range step is 10 degrees in this test items. All temperature levels shall be hold the  $\pm 0.5^{\circ}\text{C}$  during the measurement testing. The each temperature step shall be at least 0.5 hours, consider the EUT could be test under the stability condition.

**NOTE:** The frequency error was recorded frequency error from the communication simulator.

#### 3.2.3 TEST SETUP

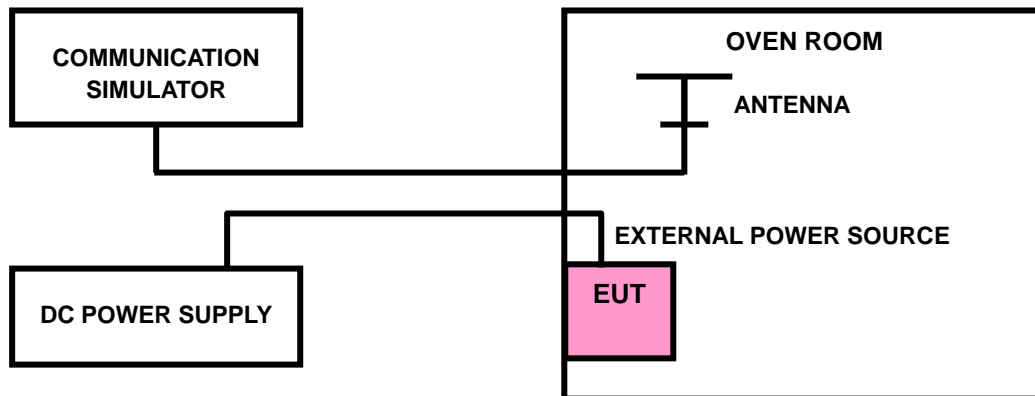



### 3.2.4 TEST RESULTS

Test EUT Configure mode A (battery) and EUT Configure mode B (DC SOURCE ), Details as below:

#### LTE BAND 2 ( BATTERY )

#### FREQUENCY ERROR VS. VOLTAGE

VOLTAGE (Volts)	1.4MHz		LIMIT (ppm)
	FREQUENCY ERROR (ppm)		
	Low Channel	High Channel	
$V_{nor(3.7V)}$	0.0025	0.0022	2.5
$V_{min(3.6V)}$	-0.0034	-0.0032	2.5
$V_{max(4.2V)}$	0.0024	0.0022	2.5

**NOTE:** The applicant defined the normal working voltage of the EUT is from  $V_{min}$  to  $V_{max}$ .

#### FREQUENCY ERROR vs. TEMPERATURE.

TEMP. (°C)	1.4MHz		LIMIT (ppm)
	FREQUENCY ERROR (ppm)		
	Low Channel	High Channel	
-40	-0.0040	-0.0015	2.5
-30	-0.0053	-0.0049	2.5
-20	-0.0052	-0.0046	2.5
-10	-0.0038	-0.0037	2.5
0	-0.0036	-0.0035	2.5
10	-0.0025	-0.0023	2.5
20	-0.0019	-0.0017	2.5
30	-0.0022	-0.0017	2.5
40	-0.0008	-0.0007	2.5
50	-0.0004	-0.0005	2.5
85	-0.0019	-0.0063	2.5



FREQUENCY ERROR VS. VOLTAGE

VOLTAGE (Volts)	3MHz		LIMIT (ppm)
	FREQUENCY ERROR (ppm)		
	Low Channel	High Channel	
$V_{nor(3.7V)}$	0.0025	0.0023	2.5
$V_{min(3.6V)}$	-0.0024	-0.0026	2.5
$V_{max(4.2V)}$	0.0019	0.0018	2.5

NOTE: The applicant defined the normal working voltage of the EUT is from  $V_{min}$  to  $V_{max}$ .

FREQUENCY ERROR vs. TEMPERATURE.

TEMP. (°C)	3MHz		LIMIT (ppm)
	FREQUENCY ERROR (ppm)		
	Low Channel	High Channel	
-40	-0.0025	-0.0060	2.5
-30	-0.0048	-0.0057	2.5
-20	-0.0043	-0.0047	2.5
-10	-0.0034	-0.0036	2.5
0	-0.0029	-0.0034	2.5
10	-0.0019	-0.0023	2.5
20	-0.0013	-0.0018	2.5
30	-0.0007	-0.0019	2.5
40	-0.0004	-0.0009	2.5
50	0.0006	-0.0004	2.5
85	0.0014	-0.0024	2.5



FREQUENCY ERROR VS. VOLTAGE

VOLTAGE (Volts)	5MHz		LIMIT (ppm)
	FREQUENCY ERROR (ppm)		
	Low Channel	High Channel	
$V_{nor(3.7V)}$	0.0023	0.0027	2.5
$V_{min(3.6V)}$	-0.0026	-0.0032	2.5
$V_{max(4.2V)}$	0.0024	0.0022	2.5

NOTE: The applicant defined the normal working voltage of the EUT is from  $V_{min}$  to  $V_{max}$ .

FREQUENCY ERROR vs. TEMPERATURE.

TEMP. (°C)	5MHz		LIMIT (ppm)
	FREQUENCY ERROR (ppm)		
	Low Channel	High Channel	
-40	-0.0066	-0.0028	2.5
-30	-0.0046	-0.0055	2.5
-20	-0.0046	-0.0045	2.5
-10	-0.0032	-0.0038	2.5
0	-0.0028	-0.0035	2.5
10	-0.0018	-0.0026	2.5
20	-0.0014	-0.0019	2.5
30	-0.0017	-0.0016	2.5
40	-0.0005	-0.0008	2.5
50	0.0006	-0.0004	2.5
85	0.0017	-0.0021	2.5



FREQUENCY ERROR VS. VOLTAGE

VOLTAGE (Volts)	10MHz		LIMIT (ppm)
	FREQUENCY ERROR (ppm)		
	Low Channel	High Channel	
$V_{nor(3.7V)}$	0.0026	0.0025	2.5
$V_{min(3.6V)}$	-0.0032	-0.0033	2.5
$V_{max(4.2V)}$	0.0028	0.0025	2.5

NOTE: The applicant defined the normal working voltage of the EUT is from  $V_{min}$  to  $V_{max}$ .

FREQUENCY ERROR vs. TEMPERATURE.

TEMP. (°C)	10MHz		LIMIT (ppm)
	FREQUENCY ERROR (ppm)		
	Low Channel	High Channel	
-40	-0.0017	-0.0020	2.5
-30	-0.0045	-0.0053	2.5
-20	-0.0043	-0.0049	2.5
-10	-0.0034	-0.0039	2.5
0	-0.0028	-0.0035	2.5
10	-0.0019	-0.0018	2.5
20	-0.0014	-0.0017	2.5
30	-0.0012	-0.0017	2.5
40	-0.0008	-0.0005	2.5
50	0.0006	-0.0004	2.5
85	0.0014	-0.0010	2.5



FREQUENCY ERROR VS. VOLTAGE

VOLTAGE (Volts)	15MHz		LIMIT (ppm)
	FREQUENCY ERROR (ppm)		
	Low Channel	High Channel	
$V_{nor(3.7V)}$	0.0025	0.00256	2.5
$V_{min(3.6V)}$	-0.0032	-0.0030	2.5
$V_{max(4.2V)}$	0.0027	0.0025	2.5

NOTE: The applicant defined the normal working voltage of the EUT is from  $V_{min}$  to  $V_{max}$ .

FREQUENCY ERROR vs. TEMPERATURE.

TEMP. (°C)	15MHz		LIMIT (ppm)
	FREQUENCY ERROR (ppm)		
	Low Channel	High Channel	
-40	-0.0041	-0.0020	2.5
-30	-0.0059	-0.0056	2.5
-20	-0.0053	-0.0049	2.5
-10	-0.0038	-0.0037	2.5
0	-0.0037	-0.0035	2.5
10	-0.0025	-0.0023	2.5
20	-0.0018	-0.0017	2.5
30	-0.0015	-0.0013	2.5
40	-0.0009	-0.0008	2.5
50	-0.0006	-0.0002	2.5
85	-0.0017	-0.0024	2.5



FREQUENCY ERROR VS. VOLTAGE

VOLTAGE (Volts)	20MHz		LIMIT (ppm)
	FREQUENCY ERROR (ppm)		
	Low Channel	High Channel	
$V_{nor(3.7V)}$	0.0028	0.0025	2.5
$V_{min(3.6V)}$	-0.0031	-0.0030	2.5
$V_{max(4.2V)}$	0.0027	0.0023	2.5

NOTE: The applicant defined the normal working voltage of the EUT is from  $V_{min}$  to  $V_{max}$ .

FREQUENCY ERROR vs. TEMPERATURE.

TEMP. (°C)	20MHz		LIMIT (ppm)
	FREQUENCY ERROR (ppm)		
	Low Channel	High Channel	
-40	-0.0049	-0.0030	2.5
-30	-0.0057	-0.0054	2.5
-20	-0.0052	-0.0046	2.5
-10	-0.0038	-0.0036	2.5
0	-0.0035	-0.0034	2.5
10	-0.0023	-0.0022	2.5
20	-0.0019	-0.0017	2.5
30	-0.0017	-0.0014	2.5
40	-0.0009	-0.0007	2.5
50	-0.0004	-0.0005	2.5
85	-0.0012	-0.0020	2.5



LTE BAND 2 ( DC SOURCE )

FREQUENCY ERROR VS. VOLTAGE

VOLTAGE (Volts)	1.4MHz		LIMIT (ppm)
	FREQUENCY ERROR (ppm)		
	Low Channel	High Channel	
V <sub>nor</sub> (30V)	0.0024	0.0021	2.5
V <sub>min</sub> (8V)	-0.0031	-0.0030	2.5
V <sub>max</sub> (48V)	0.0022	0.0023	2.5

NOTE: The applicant defined the normal working voltage of the EUT is from V<sub>min</sub> to V<sub>max</sub>.

FREQUENCY ERROR vs. TEMPERATURE.

TEMP. (°C)	1.4MHz		LIMIT (ppm)
	FREQUENCY ERROR (ppm)		
	Low Channel	High Channel	
-40	-0.0034	-0.0037	2.5
-30	-0.0050	-0.0043	2.5
-20	-0.0056	-0.0047	2.5
-10	-0.0045	-0.0043	2.5
0	-0.0041	-0.0039	2.5
10	-0.0038	-0.0036	2.5
20	-0.0037	-0.0034	2.5
30	-0.0033	-0.0030	2.5
40	-0.0029	-0.0027	2.5
50	-0.0025	-0.0023	2.5
85	-0.0024	-0.0055	2.5





FREQUENCY ERROR VS. VOLTAGE

VOLTAGE (Volts)	3MHz		LIMIT (ppm)
	FREQUENCY ERROR (ppm)		
	Low Channel	High Channel	
V <sub>nor</sub> (30V)	0.0026	0.0024	2.5
V <sub>min</sub> (8V)	-0.0025	-0.0027	2.5
V <sub>max</sub> (48V)	0.0020	0.0018	2.5

NOTE: The applicant defined the normal working voltage of the EUT is from V<sub>min</sub> to V<sub>max</sub>.

FREQUENCY ERROR vs. TEMPERATURE.

TEMP. (°C)	3MHz		LIMIT (ppm)
	FREQUENCY ERROR (ppm)		
	Low Channel	High Channel	
-40	-0.0036	-0.0019	2.5
-30	-0.0043	-0.0053	2.5
-20	-0.0045	-0.0043	2.5
-10	-0.0036	-0.0039	2.5
0	-0.0034	-0.0028	2.5
10	-0.0032	-0.0031	2.5
20	-0.0027	-0.0029	2.5
30	-0.0028	-0.0025	2.5
40	-0.0033	-0.0030	2.5
50	0.0024	-0.0027	2.5
85	0.0018	-0.0035	2.5



FREQUENCY ERROR VS. VOLTAGE

VOLTAGE (Volts)	5MHz		LIMIT (ppm)
	FREQUENCY ERROR (ppm)		
	Low Channel	High Channel	
V <sub>nor</sub> (30V)	0.0027	0.0028	2.5
V <sub>min</sub> (8V)	-0.0026	-0.0030	2.5
V <sub>max</sub> (48V)	0.0024	0.0026	2.5

NOTE: The applicant defined the normal working voltage of the EUT is from V<sub>min</sub> to V<sub>max</sub>.

FREQUENCY ERROR vs. TEMPERATURE.

TEMP. (°C)	5MHz		LIMIT (ppm)
	FREQUENCY ERROR (ppm)		
	Low Channel	High Channel	
-40	-0.0072	-0.0061	2.5
-30	-0.0047	-0.0050	2.5
-20	-0.0043	-0.0042	2.5
-10	-0.0031	-0.0036	2.5
0	-0.0029	-0.0034	2.5
10	-0.0016	-0.0023	2.5
20	-0.0017	-0.0014	2.5
30	-0.0027	-0.0023	2.5
40	-0.0012	-0.0023	2.5
50	0.0011	-0.0005	2.5
85	0.0007	-0.0014	2.5



FREQUENCY ERROR VS. VOLTAGE

VOLTAGE (Volts)	10MHz		LIMIT (ppm)
	FREQUENCY ERROR (ppm)		
	Low Channel	High Channel	
V <sub>nor</sub> (30V)	0.0029	0.0027	2.5
V <sub>min</sub> (8V)	-0.0033	-0.0036	2.5
V <sub>max</sub> (48V)	0.0024	0.0027	2.5

NOTE: The applicant defined the normal working voltage of the EUT is from V<sub>min</sub> to V<sub>max</sub>.

FREQUENCY ERROR vs. TEMPERATURE.

TEMP. (°C)	10MHz		LIMIT (ppm)
	FREQUENCY ERROR (ppm)		
	Low Channel	High Channel	
-40	-0.0045	-0.0028	2.5
-30	-0.0053	-0.0047	2.5
-20	-0.0049	-0.0045	2.5
-10	-0.0045	-0.0043	2.5
0	-0.0039	-0.0037	2.5
10	-0.0036	-0.0035	2.5
20	-0.0033	-0.0030	2.5
30	-0.0028	-0.0029	2.5
40	-0.0026	-0.0024	2.5
50	0.0023	-0.0020	2.5
85	0.0014	-0.0032	2.5



FREQUENCY ERROR VS. VOLTAGE

VOLTAGE (Volts)	15MHz		LIMIT (ppm)
	FREQUENCY ERROR (ppm)		
	Low Channel	High Channel	
V <sub>nor</sub> (30V)	0.0027	0.0023	2.5
V <sub>min</sub> (8V)	-0.0030	-0.0029	2.5
V <sub>max</sub> (48V)	0.0023	0.0024	2.5

NOTE: The applicant defined the normal working voltage of the EUT is from V<sub>min</sub> to V<sub>max</sub>.

FREQUENCY ERROR vs. TEMPERATURE.

TEMP. (°C)	15MHz		LIMIT (ppm)
	FREQUENCY ERROR (ppm)		
	Low Channel	High Channel	
-40	-0.0029	-0.0014	2.5
-30	-0.0056	-0.0057	2.5
-20	-0.0052	-0.0047	2.5
-10	-0.0043	-0.0041	2.5
0	-0.0039	-0.0038	2.5
10	-0.0036	-0.0035	2.5
20	-0.0032	-0.0030	2.5
30	-0.0028	-0.0027	2.5
40	-0.0026	-0.0023	2.5
50	-0.0025	-0.0024	2.5
85	-0.0011	-0.0013	2.5



FREQUENCY ERROR VS. VOLTAGE

VOLTAGE (Volts)	20MHz		LIMIT (ppm)
	FREQUENCY ERROR (ppm)		
	Low Channel	High Channel	
V <sub>nor</sub> (30V)	0.0028	0.0025	2.5
V <sub>min</sub> (8V)	-0.0031	-0.0030	2.5
V <sub>max</sub> (48V)	0.0027	0.0023	2.5

NOTE: The applicant defined the normal working voltage of the EUT is from V<sub>min</sub> to V<sub>max</sub>.

FREQUENCY ERROR vs. TEMPERATURE.

TEMP. (°C)	20MHz		LIMIT (ppm)
	FREQUENCY ERROR (ppm)		
	Low Channel	High Channel	
-40	-0.0025	-0.0036	2.5
-30	-0.0054	-0.0052	2.5
-20	-0.0055	-0.0056	2.5
-10	-0.0048	-0.0046	2.5
0	-0.0046	-0.0044	2.5
10	-0.0043	-0.0040	2.5
20	-0.0039	-0.0038	2.5
30	-0.0035	-0.0032	2.5
40	-0.0028	-0.0029	2.5
50	-0.0025	-0.0023	2.5
85	-0.0014	-0.0020	2.5



### 3.3 OCCUPIED BANDWIDTH MEASUREMENT

#### 3.3.1 LIMITS OF OCCUPIED BANDWIDTH MEASUREMENT

The width of a frequency band such that, below the lower and above the upper frequency limits, the mean powers emitted are each equal to a specified percentage 0.5 % of the total mean power of a given emission.

#### 3.3.2 TEST SETUP

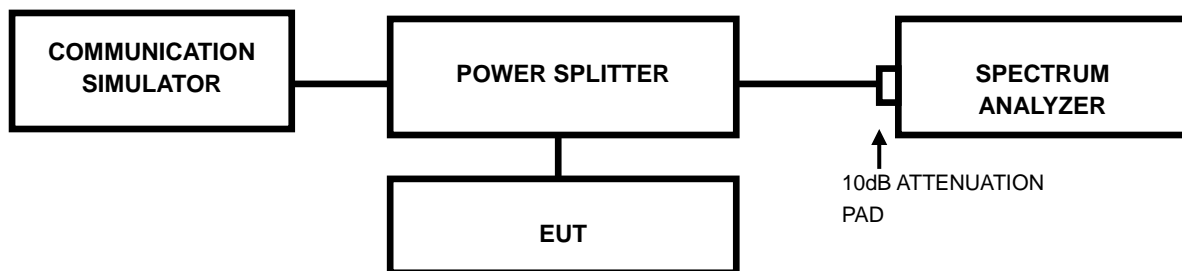

#### 3.3.3 TEST PROCEDURES

- The conducted occupied bandwidth used the power splitter via EUT RF power connector between simulation base station and spectrum analyzer.
- Use OBW measurement function of Spectrum analyzer to measure 99 % occupied bandwidth.



Test Report No.: W7L-P22080014RF02

### 3.3.4 TEST RESULTS

Please Refer to Module report R2007A0435-R5.



### 3.4 BAND EDGE MEASUREMENTC

#### 3.4.1 LIMITS OF BAND EDGE MEASUREMENT

Power of any emission outside of the authorized operating frequency ranges must be attenuated below the transmitting power (P) by a factor of at least  $43 + 10 \log(P)$  dB. In the 1 MHz bands immediately outside and adjacent to the frequency block a resolution bandwidth of at least one percent of the emission bandwidth of the fundamental emission of the transmitter may be employed.

#### 3.4.2 TEST SETUP

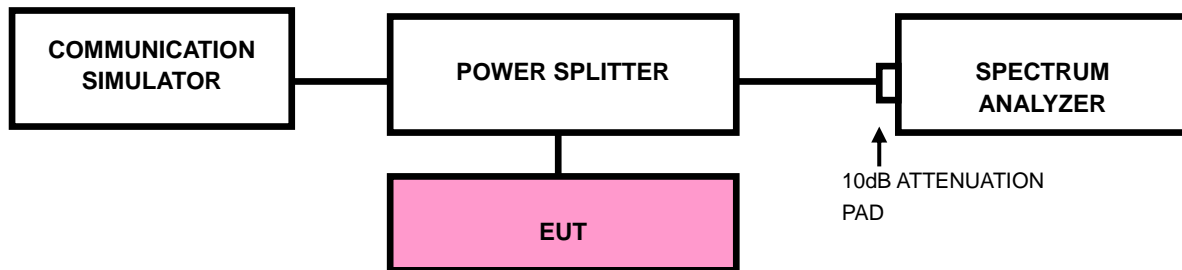





Test Report No.: W7L-P22080014RF02

### 3.4.3 TEST PROCEDURES

- a. All measurements were done at low and high operational frequency range.
- b. The center frequency of spectrum is the band edge frequency and span is 1~5 MHz. RBW of the spectrum is 10kHz and VBW of the spectrum is 30kHz (LTE bandwidth for (1.4M/3M/5M/10M/15M/20M)1RB/0RB&1RB/MAXRB).
- c. The center frequency of spectrum is the band edge frequency and span is 1~5 MHz. RBW of the spectrum is  $\geq 1\% \cdot \text{EBW}$  kHz and VBW of the spectrum is  $3 \cdot \text{RBW}$  kHz. (LTE bandwidth 1.4M/3M/5M/10M/15M/20MHz).
- d. Record the max trace plot into the test report.



**BUREAU  
VERITAS**

**Test Report No.: W7L-P22080014RF02**

### 3.4.4 TEST RESULTS

Please Refer to Module report R2007A0435-R5.



### 3.5 CONDUCTED SPURIOUS EMISSIONS

#### 3.5.1 LIMITS OF CONDUCTED SPURIOUS EMISSIONS MEASUREMENT

The power of any emission outside of the authorized operating frequency ranges must be attenuated below the transmitting power (P) by a factor of at least  $43 + 10 \log(P)$  dB. The emission limit equal to  $-13\text{dBm}$ .

#### 3.5.2 TEST PROCEDURE

- a. The EUT makes a phone call to the communication simulator. All measurements were done at low, middle and high operational frequency range.
- b. Measuring frequency range is from 30MHz up to a frequency including its 10<sup>th</sup> harmonic. 10dB attenuation pad is connected with spectrum. RBW=1MHz and VBW=3MHz is used for conducted emission measurement.

#### 3.5.3 TEST SETUP

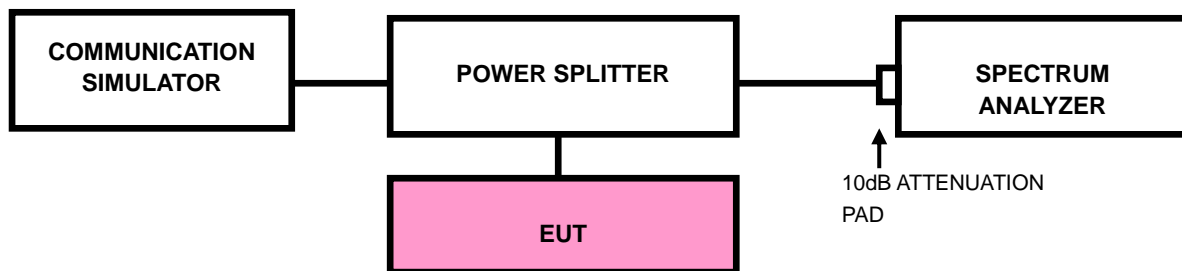



**BUREAU  
VERITAS**

**Test Report No.: W7L-P22080014RF02**

### 3.5.4 TEST RESULTS

NOTE : The 9K~30MHz amplitude of spurious emissions attenuated more than 20 dB below the permissible value is not required in the report.

Please Refer to Module report R2007A0435-R5.



### 3.6 RADIATED EMISSION MEASUREMENT

#### 3.6.1 LIMITS OF RADIATED EMISSION MEASUREMENT

The power of any emission outside of the authorized operating frequency ranges must be attenuated below the transmitting power (P) by a factor of at least  $43 + 10 \log(P)$  dB. The emission limit equal to  $-13\text{dBm}$ .

#### 3.6.2 TEST PROCEDURES

- a. Substitution method is used for E.I.R.P measurement. In the semi-anechoic chamber, EUT placed on the 0.8m height of Turn Table, rotated the table around 360 degrees to search the maximum radiation power and receiver antenna shall be rotated vertical and horizontal polarization and moved height from 1m to 4m to find the maximum polar radiated power. The "Read Value" is the spectrum reading the maximum power value.
- b. The substitution horn antenna is substituted for EUT at the same position and signals generator export the CW signal to the substitution antenna via a TX cable. Rotated the Turn Table and moved receiving antenna to find the maximum radiation power. Adjust output power level of S.G to get a Value of spectrum reading equal to "Read Value" of step a. Record the power level of S.G
- c.  $\text{EIRP} = \text{Output power level of S.G} - \text{TX cable loss} + \text{Antenna gain of substitution horn}$ .

**NOTE:** The resolution bandwidth and video bandwidth of test receiver/spectrum analyzer is 1MHz/3MHz.

#### 3.6.3 DEVIATION FROM TEST STANDARD

No deviation



### 3.6.4 TEST SETUP

#### < Frequency Range below 30MHz >

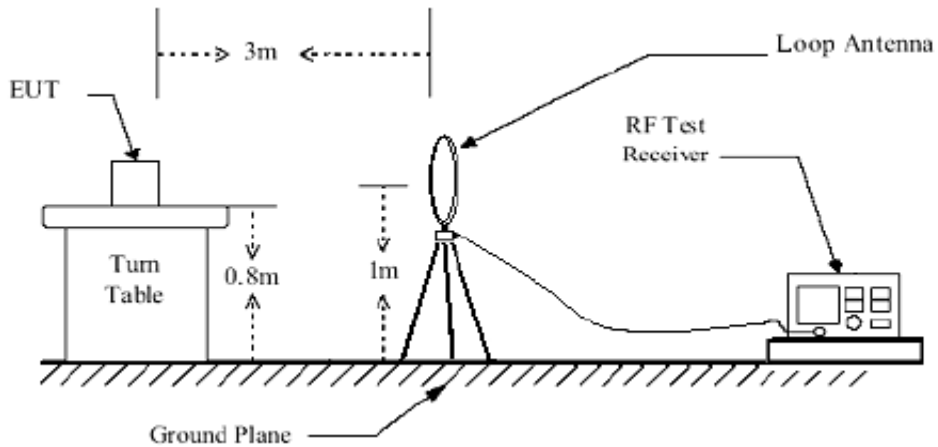

#### < Frequency Range 30MHz~1GHz >

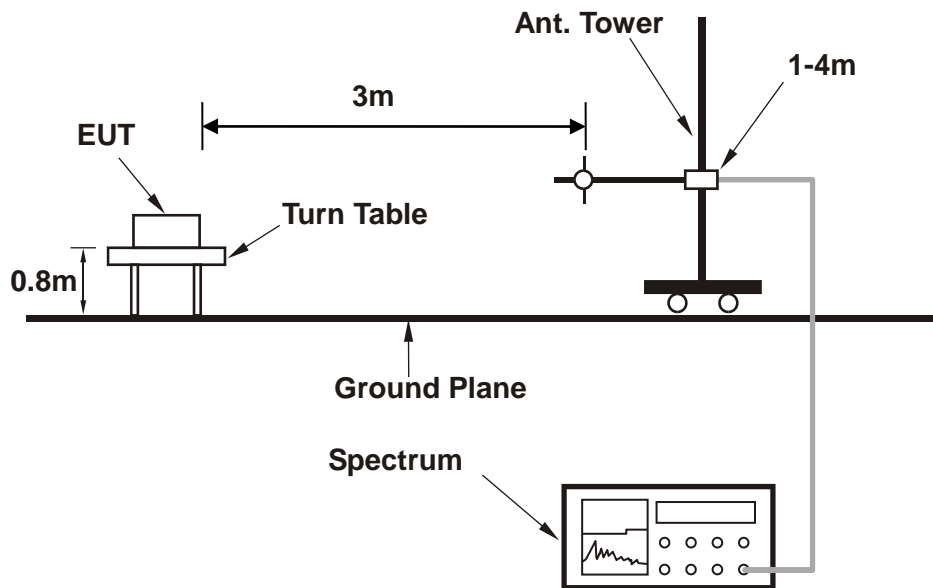



<Frequency Range above 1GHz>

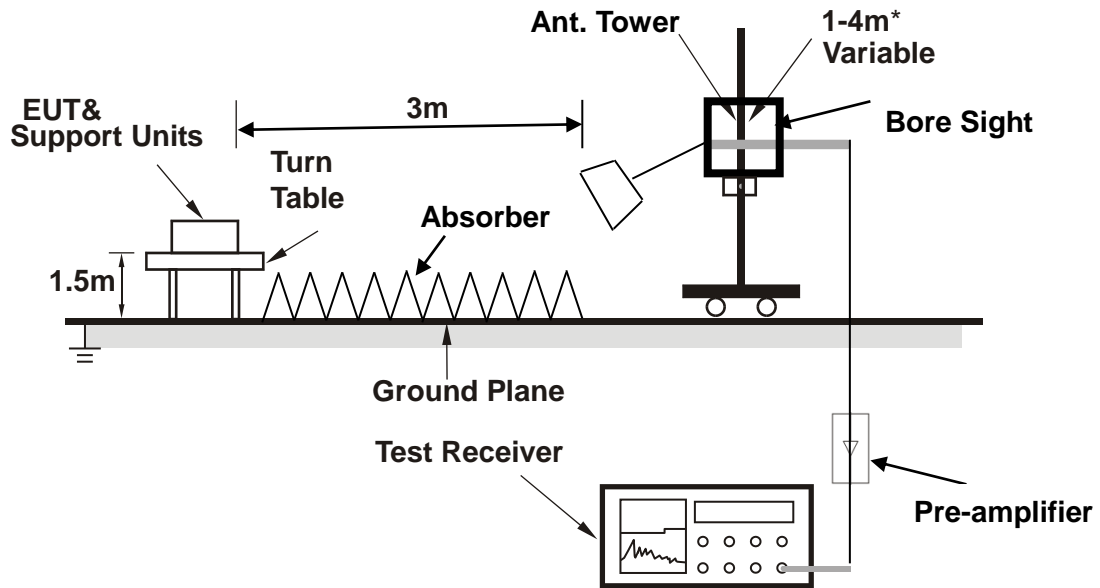

**Note:** Above 1G is a directional antenna

Depends on the EUT height and the antenna 3dB beamwidth both, refer to section 7.3 of CISPR 16-2-3.

For the actual test configuration, please refer to the attached file (Test Setup Photo).



**BUREAU  
VERITAS**

**Test Report No.: W7L-P22080014RF02**

### 3.6.5 TEST RESULTS

NOTE : 1.The 9K~30MHz amplitude of spurious emissions attenuated more than 20 dB below the permissible value is not required in the report.

2.Pre-scan battery supply and DC SOURCE,Worse case is DC SOURCE

#### BELOW 1GHz WORST-CASE DATA 1(With the antenna)

30 MHz – 1GHz data:

LTE band 2

CHANNEL BANDWIDTH: 1.4MHz / QPSK

<b>MODE</b>	TX channel 18900	<b>FREQUENCY RANGE</b>	Below 1000MHz
<b>ENVIRONMENTAL CONDITIONS</b>	23deg. C, 70%RH	<b>INPUT POWER</b>	DC30V
<b>TESTED BY</b>	Jace Hu		
<b>ANTENNA POLARITY &amp; TEST DISTANCE: HORIZONTAL AT 3 M</b>			

	Freq	Level	Read Level	Limit Line	Over Limit	Factor	Remark	Pol/Phase
	MHz	dBm/m	dBm	dBm/m	dB	dB/m		
1	54.250	-55.77	-38.05	-13.00	-42.77	-17.72	Peak	Horizontal
2	131.850	-61.46	-40.52	-13.00	-48.46	-20.94	Peak	Horizontal
3 PP	259.890	-51.55	-39.90	-13.00	-38.55	-11.65	Peak	Horizontal
4	310.330	-54.10	-41.89	-13.00	-41.10	-12.21	Peak	Horizontal
5	437.400	-56.34	-46.98	-13.00	-43.34	-9.36	Peak	Horizontal
6	482.020	-57.39	-48.82	-13.00	-44.39	-8.57	Peak	Horizontal

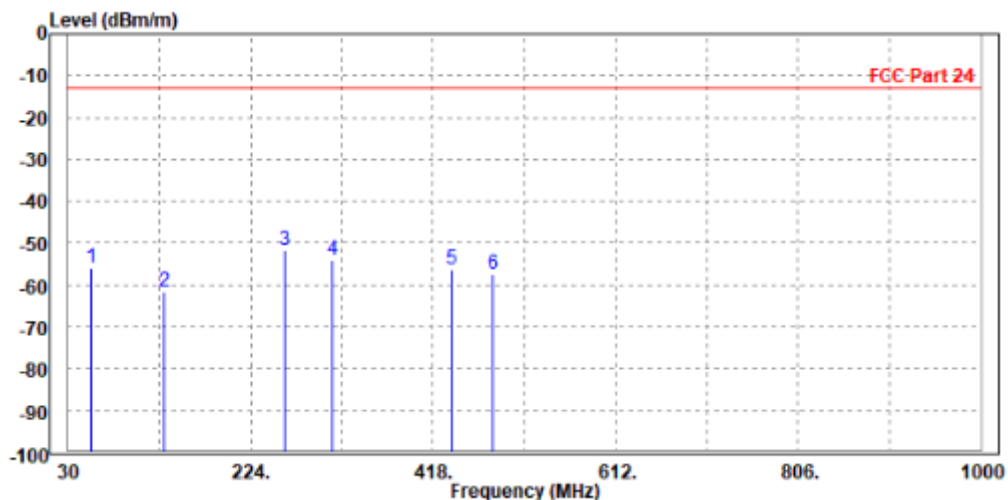





**BUREAU  
VERITAS**

**Test Report No.: W7L-P22080014RF02**

<b>MODE</b>	TX channel 18900	<b>FREQUENCY RANGE</b>	Below 1000MHz
<b>ENVIRONMENTAL CONDITIONS</b>	23deg. C, 70%RH	<b>INPUT POWER</b>	DC30V
<b>TESTED BY</b>	Jace Hu		
<b>ANTENNA POLARITY &amp; TEST DISTANCE: VERTICAL AT 3 M</b>			

	Freq	Level	Read Level	Limit Line	Over Limit	Factor	Remark	Pol/Phase
	MHz	dBm/m	dBm	dBm/m	dB	dB/m		
1	54.250	-58.73	-34.14	-13.00	-45.73	-24.59	Peak	Vertical
2 PP	132.820	-55.71	-41.83	-13.00	-42.71	-13.88	Peak	Vertical
3	236.610	-64.00	-49.22	-13.00	-51.00	-14.78	Peak	Vertical
4	369.500	-63.64	-54.09	-13.00	-50.64	-9.55	Peak	Vertical
5	434.490	-61.15	-52.47	-13.00	-48.15	-8.68	Peak	Vertical
6	487.840	-59.86	-51.67	-13.00	-46.86	-8.19	Peak	Vertical

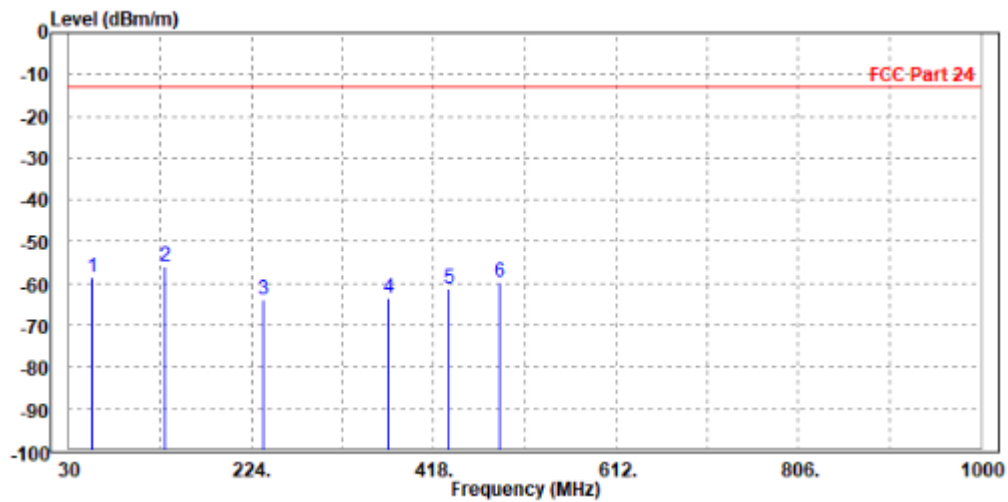



BUREAU VERITAS

Test Report No.: W7L-P22080014RF02

ABOVE 1GHz DATA

Note: For higher frequency, the emission is too low to be detected.

WORST-CASE DATA

LTE Band 2

CHANNEL BANDWIDTH: 1.4MHz / QPSK

CH18607

MODE	TX channel 18607	FREQUENCY RANGE	Above 1000MHz
ENVIRONMENTAL CONDITIONS	23deg. C, 70%RH	INPUT POWER	DC30V
TESTED BY	Jace Hu		
<b>ANTENNA POLARITY &amp; TEST DISTANCE: HORIZONTAL AT 3 M</b>			

	Freq	Level	Read Level	Limit Line	Over Limit	Factor	Remark	Pol/Phase
	MHz	dBm/m	dBm	dBm/m	dB	dB/m		
1	3698.000	-53.45	-61.28	-13.00	-40.45	7.83	Peak	Horizontal
2 PP	5552.100	-52.82	-63.39	-13.00	-39.82	10.57	Peak	Horizontal

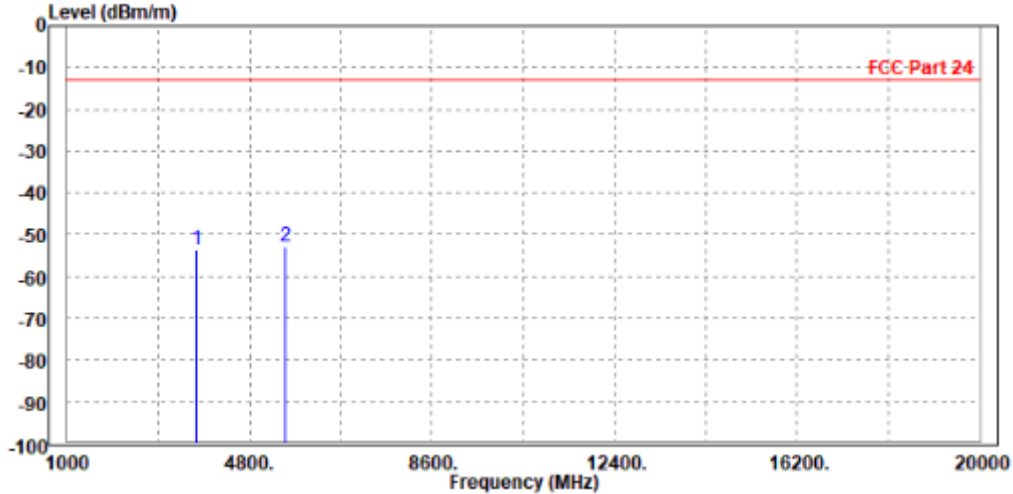



BUREAU VERITAS

Test Report No.: W7L-P22080014RF02

MODE	TX channel 18607	FREQUENCY RANGE	Above 1000MHz
ENVIRONMENTAL CONDITIONS	23deg. C, 70%RH	INPUT POWER	DC30V
TESTED BY	Jace Hu		
<b>ANTENNA POLARITY &amp; TEST DISTANCE: VERTICAL AT 3 M</b>			

	Freq	Level	Read Level	Limit Line	Over Limit	Factor	Remark	Pol/Phase
	MHz	dBm/m	dBm	dBm/m	dB	dB/m		
1	3698.000	-53.22	-60.83	-13.00	-40.22	7.61	Peak	Vertical
2 PP	5552.100	-52.22	-63.10	-13.00	-39.22	10.88	Peak	Vertical

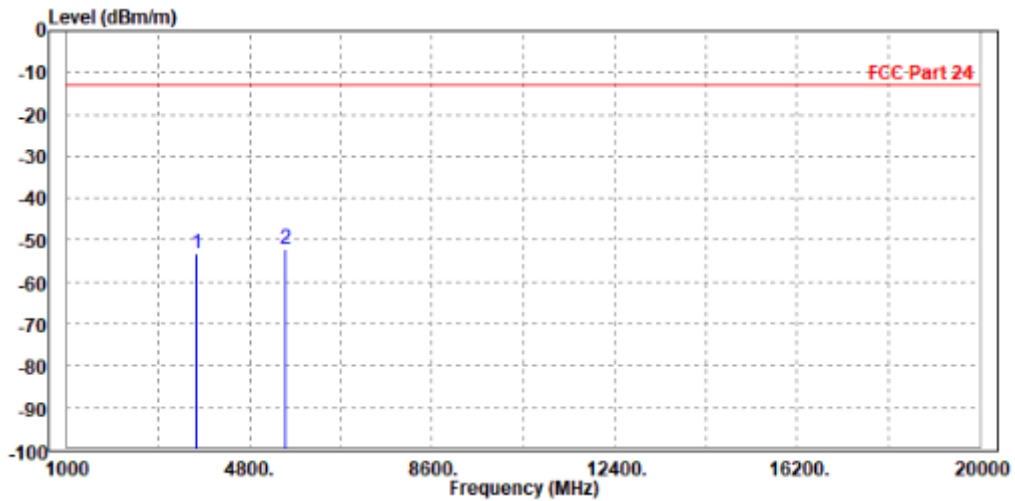



BUREAU VERITAS

Test Report No.: W7L-P22080014RF02

CH18900

MODE	TX channel 18900	FREQUENCY RANGE	Above 1000MHz
ENVIRONMENTAL CONDITIONS	23deg. C, 70%RH	INPUT POWER	DC30V
TESTED BY	Jace Hu		
<b>ANTENNA POLARITY &amp; TEST DISTANCE: HORIZONTAL AT 3 M</b>			

	Freq	Level	Read Level	Limit Line	Over Limit	Factor	Remark	Pol/Phase
	MHz	dBm/m	dBm	dBm/m	dB	dB/m		
1 PP	3755.000	-48.66	-56.64	-13.00	-35.66	7.98	Peak	Horizontal
2	5640.000	-51.19	-61.93	-13.00	-38.19	10.74	Peak	Horizontal

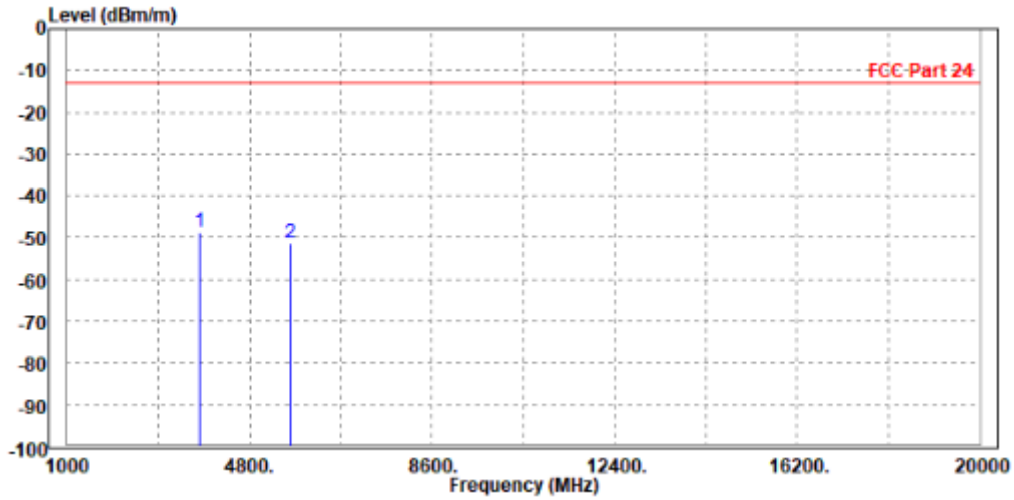



**BUREAU  
VERITAS**

**Test Report No.: W7L-P22080014RF02**

<b>MODE</b>	TX channel 18900	<b>FREQUENCY RANGE</b>	Above 1000MHz
<b>ENVIRONMENTAL CONDITIONS</b>	23deg. C, 70%RH	<b>INPUT POWER</b>	DC30V
<b>TESTED BY</b>	Jace Hu		
<b>ANTENNA POLARITY &amp; TEST DISTANCE: VERTICAL AT 3 M</b>			

	Freq	Level	Read Level	Limit Line	Over Limit	Factor	Remark	Pol/Phase
	MHz	dBm/m	dBm	dBm/m	dB	dB/m		
1	PP 3755.000	-45.82	-53.51	-13.00	-32.82	7.69	Peak	Vertical
2	5640.000	-51.81	-62.94	-13.00	-38.81	11.13	Peak	Vertical

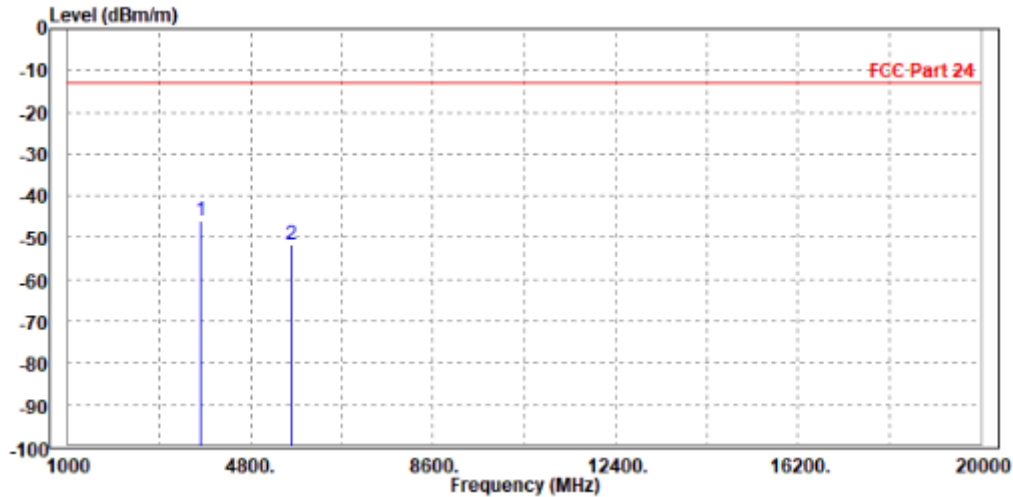



BUREAU VERITAS

Test Report No.: W7L-P22080014RF02

CH19193

MODE	TX channel 19193	FREQUENCY RANGE	Above 1000MHz
ENVIRONMENTAL CONDITIONS	23deg. C, 70%RH	INPUT POWER	DC30V
TESTED BY	Jace Hu		
<b>ANTENNA POLARITY &amp; TEST DISTANCE: HORIZONTAL AT 3 M</b>			

	Freq	Level	Read Level	Limit Line	Over Limit	Factor	Remark	Pol/Phase
	MHz	dBm/m	dBm	dBm/m	dB	dB/m		
1	3812.000	-52.38	-60.50	-13.00	-39.38	8.12	Peak	Horizontal
2 PP	5727.900	-50.55	-61.46	-13.00	-37.55	10.91	Peak	Horizontal

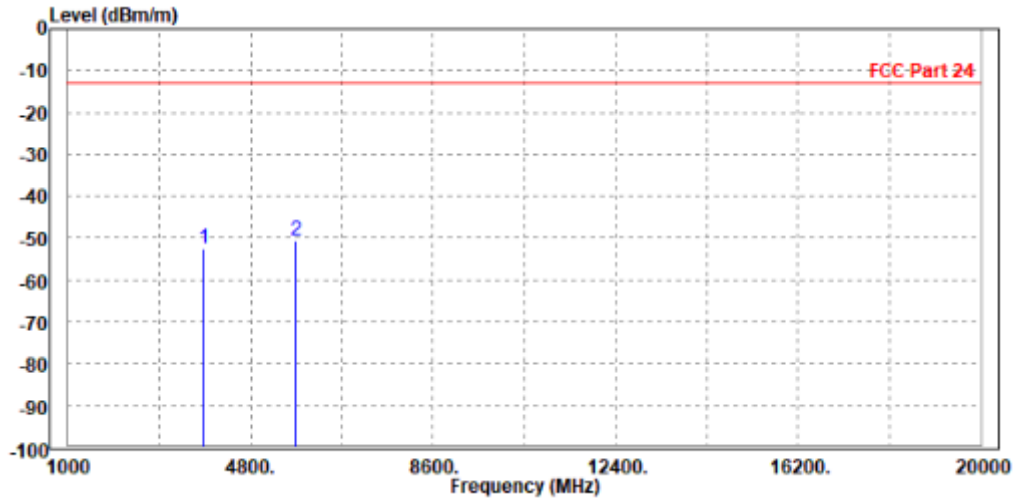



**BUREAU  
VERITAS**

Test Report No.: W7L-P22080014RF02

<b>MODE</b>	TX channel 19193	<b>FREQUENCY RANGE</b>	Above 1000MHz
<b>ENVIRONMENTAL CONDITIONS</b>	23deg. C, 70%RH	<b>INPUT POWER</b>	DC30V
<b>TESTED BY</b>	Jace Hu		
<b>ANTENNA POLARITY &amp; TEST DISTANCE: VERTICAL AT 3 M</b>			

	Freq	Level	Read Level	Limit Line	Over Limit	Factor	Remark	Pol/Phase
	MHz	dBm/m	dBm	dBm/m	dB	dB/m		
1	3812.000	-52.69	-60.46	-13.00	-39.69	7.77	Peak	Vertical
2 PP	5727.900	-50.51	-61.89	-13.00	-37.51	11.38	Peak	Vertical

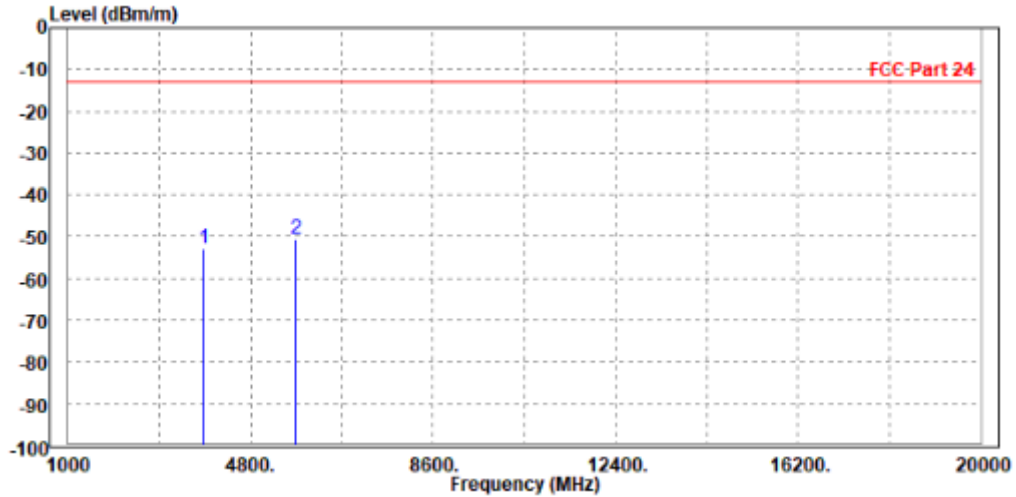



**BUREAU  
VERITAS**

Test Report No.: W7L-P22080014RF02

CHANNEL BANDWIDTH: 3MHz / QPSK

<b>MODE</b>	TX channel 18900	<b>FREQUENCY RANGE</b>	Above 1000MHz
<b>ENVIRONMENTAL CONDITIONS</b>	23deg. C, 70%RH	<b>INPUT POWER</b>	DC30V
<b>TESTED BY</b>	Jace Hu		
<b>ANTENNA POLARITY &amp; TEST DISTANCE: HORIZONTAL AT 3 M</b>			

	Freq	Level	Read Level	Limit Line	Over Limit	Factor	Remark	Pol/Phase
	MHz	dBm/m	dBm	dBm/m	dB	dB/m		
1	3755.000	-52.94	-60.92	-13.00	-39.94	7.98	Peak	Horizontal
2 PP	5640.000	-51.67	-62.41	-13.00	-38.67	10.74	Peak	Horizontal

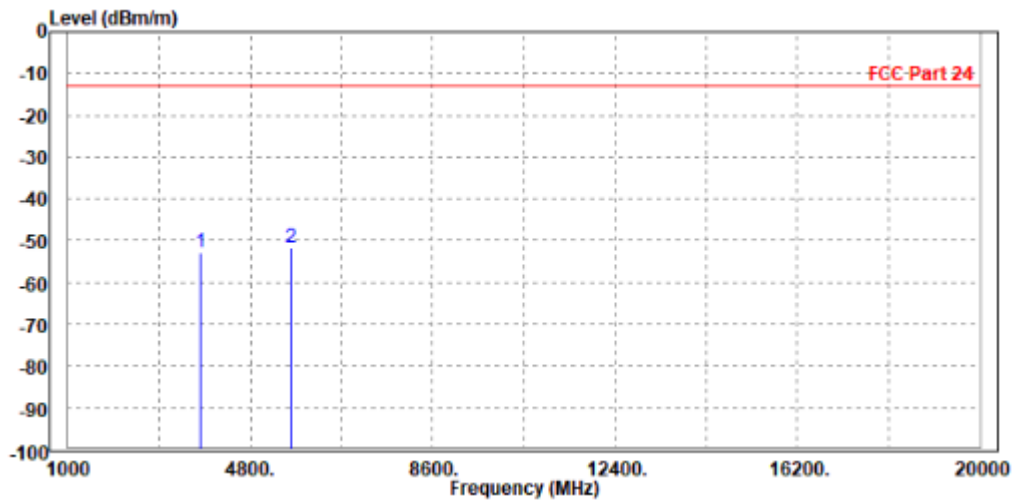





**BUREAU  
VERITAS**

Test Report No.: W7L-P22080014RF02

<b>MODE</b>	TX channel 18900	<b>FREQUENCY RANGE</b>	Above 1000MHz
<b>ENVIRONMENTAL CONDITIONS</b>	23deg. C, 70%RH	<b>INPUT POWER</b>	DC30V
<b>TESTED BY</b>	Jace Hu		
<b>ANTENNA POLARITY &amp; TEST DISTANCE: VERTICAL AT 3 M</b>			

	Freq	Level	Read Level	Limit Line	Over Limit	Factor	Remark	Pol/Phase
	MHz	dBm/m	dBm	dBm/m	dB	dB/m		
1	3755.000	-53.68	-61.37	-13.00	-40.68	7.69	Peak	Vertical
2 PP	5640.000	-51.70	-62.83	-13.00	-38.70	11.13	Peak	Vertical

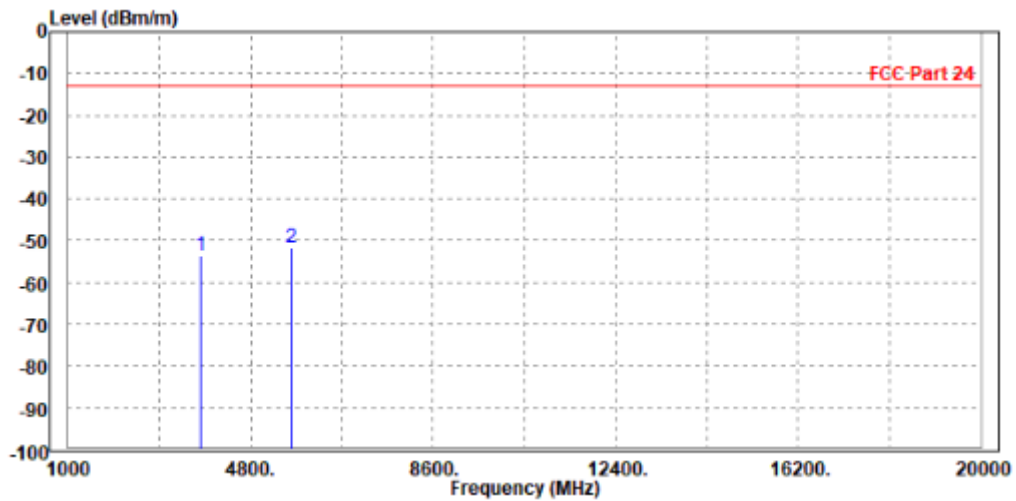



BUREAU VERITAS

Test Report No.: W7L-P22080014RF02

CHANNEL BANDWIDTH: 5MHz / QPSK

MODE	TX channel 18900	FREQUENCY RANGE	Above 1000MHz
ENVIRONMENTAL CONDITIONS	23deg. C, 70%RH	INPUT POWER	DC30V
TESTED BY	Jace Hu		
ANTENNA POLARITY & TEST DISTANCE: HORIZONTAL AT 3 M			

	Freq	Level	Read Level	Limit Line	Over Limit	Factor	Remark	Pol/Phase
	MHz	dBm/m	dBm	dBm/m	dB	dB/m		
1 PP	3755.000	-49.30	-57.28	-13.00	-36.30	7.98	Peak	Horizontal
2	5640.000	-51.24	-61.98	-13.00	-38.24	10.74	Peak	Horizontal

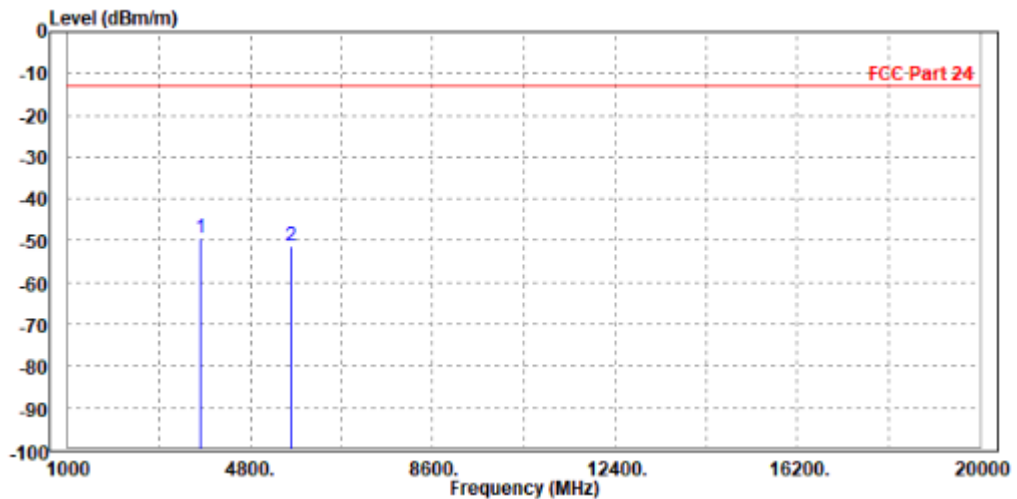



**BUREAU  
VERITAS**

Test Report No.: W7L-P22080014RF02

<b>MODE</b>	TX channel 18900	<b>FREQUENCY RANGE</b>	Above 1000MHz
<b>ENVIRONMENTAL CONDITIONS</b>	23deg. C, 70%RH	<b>INPUT POWER</b>	DC30V
<b>TESTED BY</b>	Jace Hu		
<b>ANTENNA POLARITY &amp; TEST DISTANCE: VERTICAL AT 3 M</b>			

	Freq	Level	Read Level	Limit Line	Over Limit	Factor	Remark	Pol/Phase
	MHz	dBm/m	dBm	dBm/m	dB	dB/m		
1	PP 3755.000	-46.54	-54.23	-13.00	-33.54	7.69	Peak	Vertical
2	5640.000	-51.15	-62.28	-13.00	-38.15	11.13	Peak	Vertical

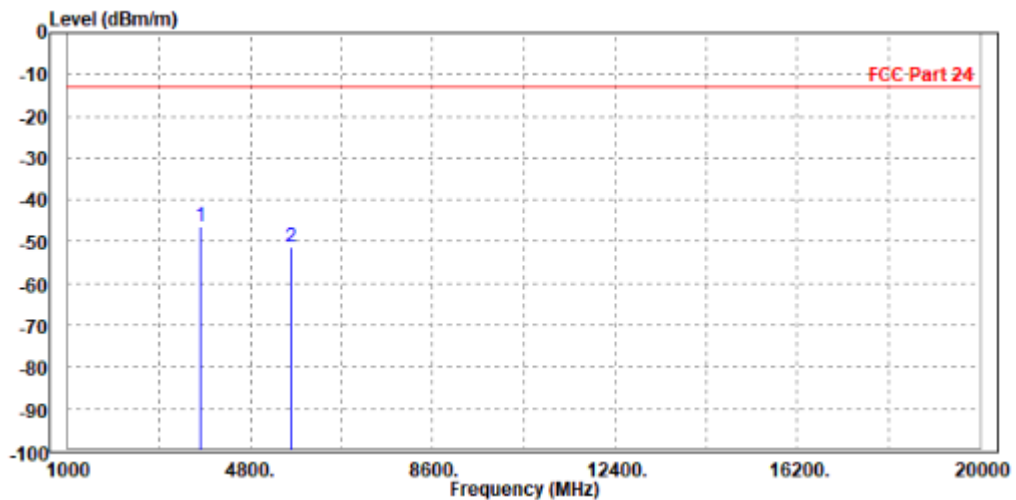



BUREAU VERITAS

Test Report No.: W7L-P22080014RF02

CHANNEL BANDWIDTH: 10MHz / QPSK

MODE	TX channel 18900	FREQUENCY RANGE	Above 1000MHz
ENVIRONMENTAL CONDITIONS	23deg. C, 70%RH	INPUT POWER	DC30V
TESTED BY	Jace Hu		
<b>ANTENNA POLARITY &amp; TEST DISTANCE: HORIZONTAL AT 3 M</b>			

	Freq	Level	Read Level	Limit Line	Over Limit	Factor	Remark	Pol/Phase
	MHz	dBm/m	dBm	dBm/m	dB	dB/m		
1	3755.000	-51.43	-59.41	-13.00	-38.43	7.98	Peak	Horizontal
2 PP	5640.000	-51.38	-62.12	-13.00	-38.38	10.74	Peak	Horizontal

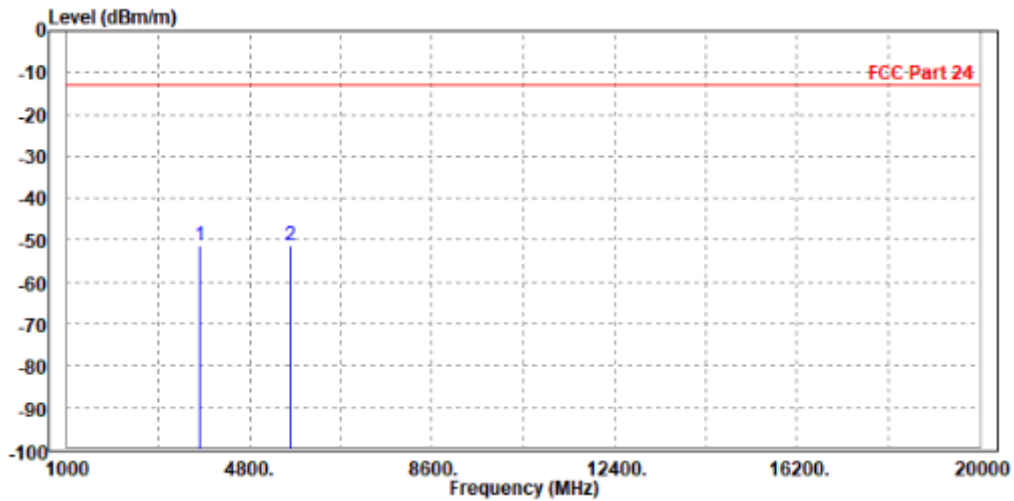



**BUREAU  
VERITAS**

Test Report No.: W7L-P22080014RF02

<b>MODE</b>	TX channel 18900	<b>FREQUENCY RANGE</b>	Above 1000MHz
<b>ENVIRONMENTAL CONDITIONS</b>	23deg. C, 70%RH	<b>INPUT POWER</b>	DC30V
<b>TESTED BY</b>	Jace Hu		
<b>ANTENNA POLARITY &amp; TEST DISTANCE: VERTICAL AT 3 M</b>			

	Freq	Level	Read Level	Limit Line	Over Limit	Factor	Remark	Pol/Phase
	MHz	dBm/m	dBm	dBm/m	dB	dB/m		
1	PP 3755.000	-45.97	-53.66	-13.00	-32.97	7.69	Peak	Vertical
2	5640.000	-50.92	-62.05	-13.00	-37.92	11.13	Peak	Vertical

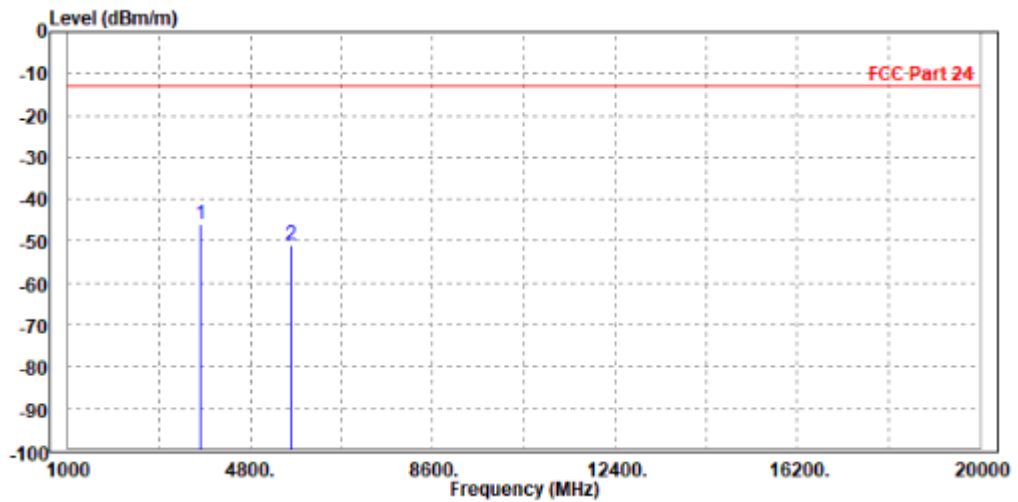



**BUREAU  
VERITAS**

Test Report No.: W7L-P22080014RF02

CHANNEL BANDWIDTH: 15MHz / QPSK

<b>MODE</b>	TX channel 18900	<b>FREQUENCY RANGE</b>	Above 1000MHz
<b>ENVIRONMENTAL CONDITIONS</b>	23deg. C, 70%RH	<b>INPUT POWER</b>	DC30V
<b>TESTED BY</b>	Jace Hu		
<b>ANTENNA POLARITY &amp; TEST DISTANCE: HORIZONTAL AT 3 M</b>			

	Freq	Level	Read Level	Limit Line	Over Limit	Factor	Remark	Pol/Phase
	MHz	dBm/m	dBm	dBm/m	dB	dB/m		
1 PP	3755.000	-48.31	-56.29	-13.00	-35.31	7.98	Peak	Horizontal
2	5640.000	-50.55	-61.29	-13.00	-37.55	10.74	Peak	Horizontal

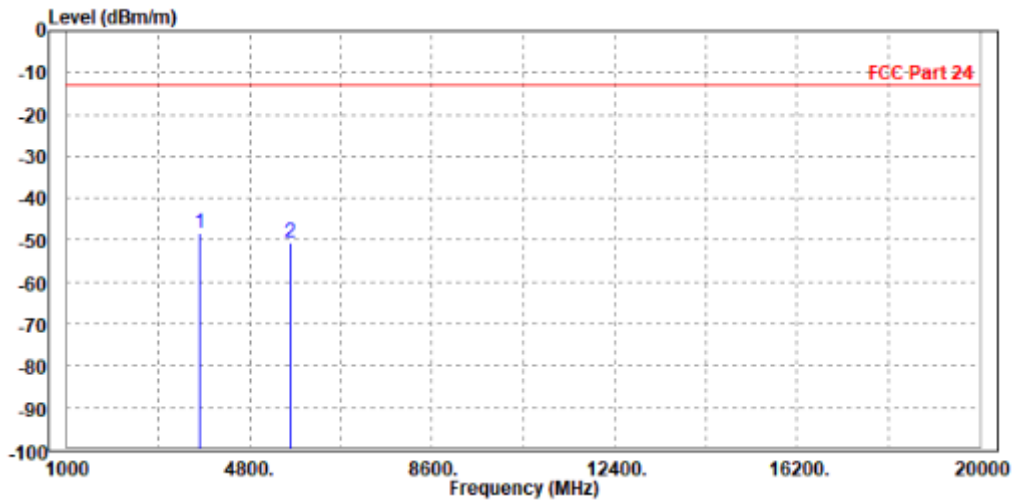



**BUREAU  
VERITAS**

Test Report No.: W7L-P22080014RF02

<b>MODE</b>	TX channel 18900	<b>FREQUENCY RANGE</b>	Above 1000MHz
<b>ENVIRONMENTAL CONDITIONS</b>	23deg. C, 70%RH	<b>INPUT POWER</b>	DC30V
<b>TESTED BY</b>	Jace Hu		
<b>ANTENNA POLARITY &amp; TEST DISTANCE: VERTICAL AT 3 M</b>			

	Freq	Level	Read Level	Limit Line	Over Limit	Factor	Remark	Pol/Phase
	MHz	dBm/m	dBm	dBm/m	dB	dB/m		
1	PP 3755.000	-47.58	-55.27	-13.00	-34.58	7.69	Peak	Vertical
2	5640.000	-49.76	-60.89	-13.00	-36.76	11.13	Peak	Vertical

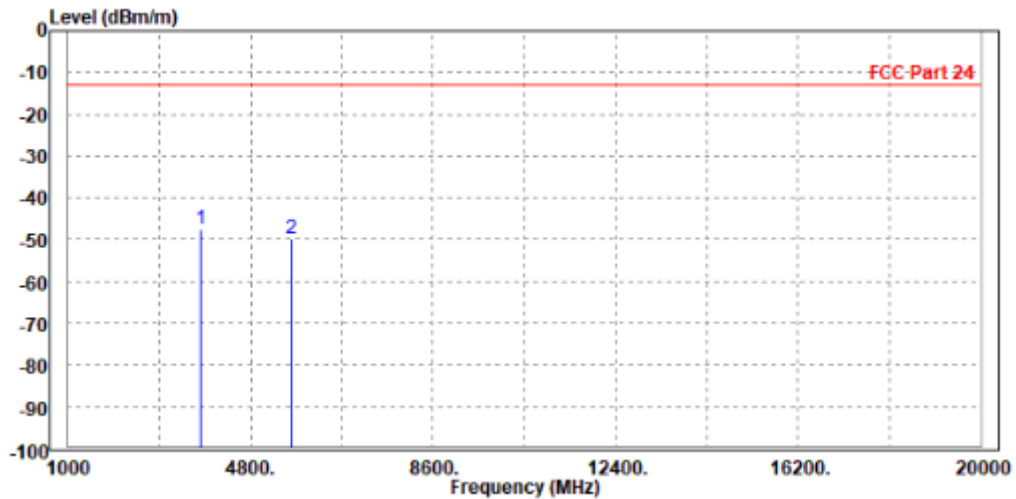



**BUREAU  
VERITAS**

Test Report No.: W7L-P22080014RF02

**CHANNEL BANDWIDTH: 20MHz / QPSK**

<b>MODE</b>	TX channel 18900	<b>FREQUENCY RANGE</b>	Above 1000MHz
<b>ENVIRONMENTAL CONDITIONS</b>	23deg. C, 70%RH	<b>INPUT POWER</b>	DC30V
<b>TESTED BY</b>	Jace Hu		
<b>ANTENNA POLARITY &amp; TEST DISTANCE: HORIZONTAL AT 3 M</b>			

	Freq	Level	Read Level	Limit Line	Over Limit	Factor	Remark	Pol/Phase
	MHz	dBm/m	dBm	dBm/m	dB	dB/m		
1	3755.000	-52.61	-60.59	-13.00	-39.61	7.98	Peak	Horizontal
2 PP	5640.000	-51.75	-62.49	-13.00	-38.75	10.74	Peak	Horizontal

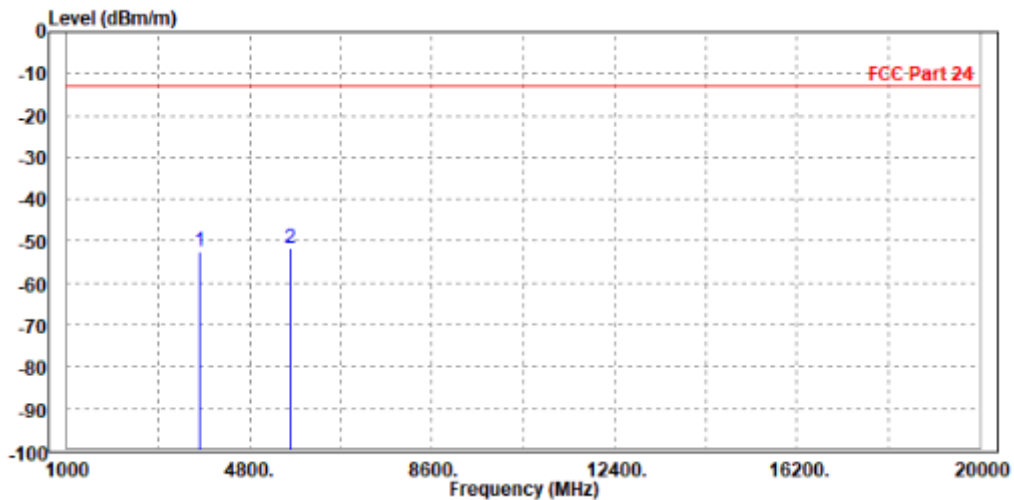





**BUREAU  
VERITAS**

Test Report No.: W7L-P22080014RF02

<b>MODE</b>	TX channel 18900	<b>FREQUENCY RANGE</b>	Above 1000MHz
<b>ENVIRONMENTAL CONDITIONS</b>	23deg. C, 70%RH	<b>INPUT POWER</b>	DC30V
<b>TESTED BY</b>	Jace Hu		
<b>ANTENNA POLARITY &amp; TEST DISTANCE: VERTICAL AT 3 M</b>			

	Freq	Level	Read Level	Limit Line	Over Limit	Factor	Remark	Pol/Phase
	MHz	dBm/m	dBm	dBm/m	dB	dB/m		
1	PP 3755.000	-48.23	-55.92	-13.00	-35.23	7.69	Peak	Vertical
2	5640.000	-50.98	-62.11	-13.00	-37.98	11.13	Peak	Vertical

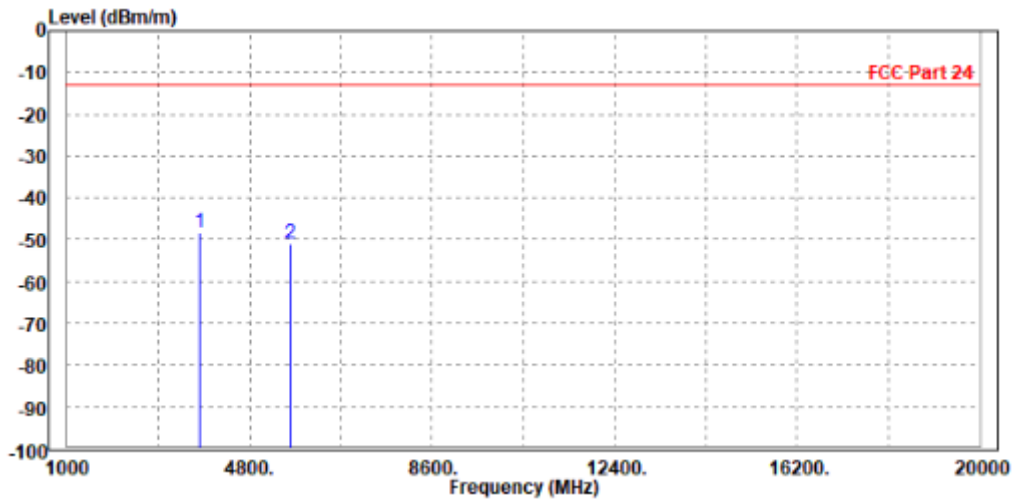



BUREAU VERITAS

Test Report No.: W7L-P22080014RF02

BELOW 1GHz WORST-CASE DATA 2(Without antenna)

30 MHz – 1GHz data:

LTE band 2

CHANNEL BANDWIDTH: 10MHz / QPSK

MODE	TX channel 18900	FREQUENCY RANGE	Below 1000MHz
ENVIRONMENTAL CONDITIONS	23deg. C, 70%RH	INPUT POWER	DC30V
TESTED BY	Jace Hu		
ANTENNA POLARITY & TEST DISTANCE: HORIZONTAL AT 3 M			

	Freq	Level	Read Level	Limit Line	Over Limit	Factor	Remark	Pol/Phase
	MHz	dBm/m	dBm	dBm/m	dB	dB/m		
1 PP	62.980	-50.97	-31.49	-13.00	-37.97	-19.48	Peak	Horizontal
2	138.640	-56.38	-36.81	-13.00	-43.38	-19.57	Peak	Horizontal
3	245.340	-52.43	-40.42	-13.00	-39.43	-12.01	Peak	Horizontal
4	343.310	-58.18	-46.77	-13.00	-45.18	-11.41	Peak	Horizontal
5	446.130	-52.51	-43.31	-13.00	-39.51	-9.20	Peak	Horizontal
6	491.720	-53.48	-45.09	-13.00	-40.48	-8.39	Peak	Horizontal

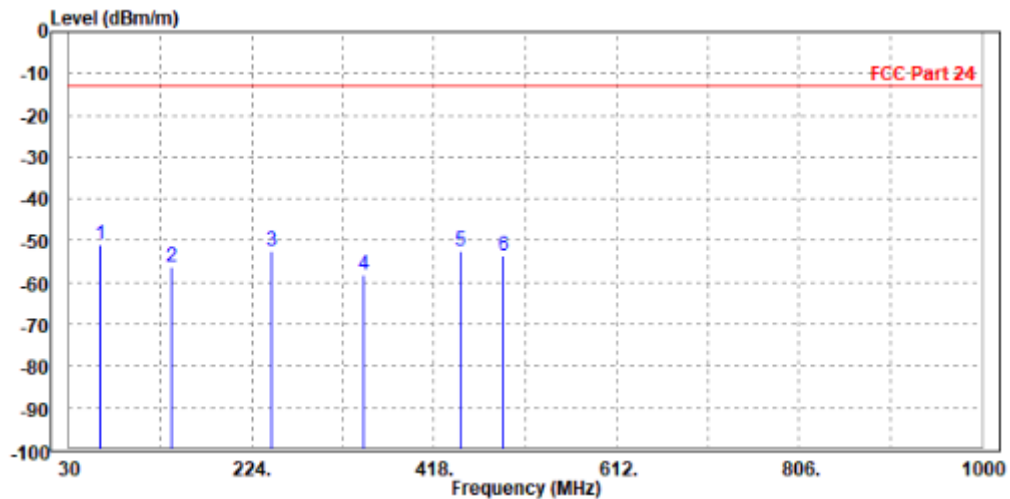



**BUREAU  
VERITAS**

**Test Report No.: W7L-P22080014RF02**

<b>MODE</b>	TX channel 18900	<b>FREQUENCY RANGE</b>	Below 1000MHz
<b>ENVIRONMENTAL CONDITIONS</b>	23deg. C, 70%RH	<b>INPUT POWER</b>	DC30V
<b>TESTED BY</b>	Jace Hu		
<b>ANTENNA POLARITY &amp; TEST DISTANCE: VERTICAL AT 3 M</b>			

	Freq	Level	Read Level	Limit Line	Over Limit	Factor	Remark	Pol/Phase
	MHz	dBm/m	dBm	dBm/m	dB	dB/m		
1	61.040	-51.07	-28.05	-13.00	-38.07	-23.02	Peak	Vertical
2	100.810	-64.90	-58.20	-13.00	-51.90	-6.70	Peak	Vertical
3	137.670	-59.24	-46.01	-13.00	-46.24	-13.23	Peak	Vertical
4	235.640	-59.59	-44.72	-13.00	-46.59	-14.87	Peak	Vertical
5	309.360	-62.60	-51.95	-13.00	-49.60	-10.65	Peak	Vertical
6	448.070	-56.45	-47.89	-13.00	-43.45	-8.56	Peak	Vertical

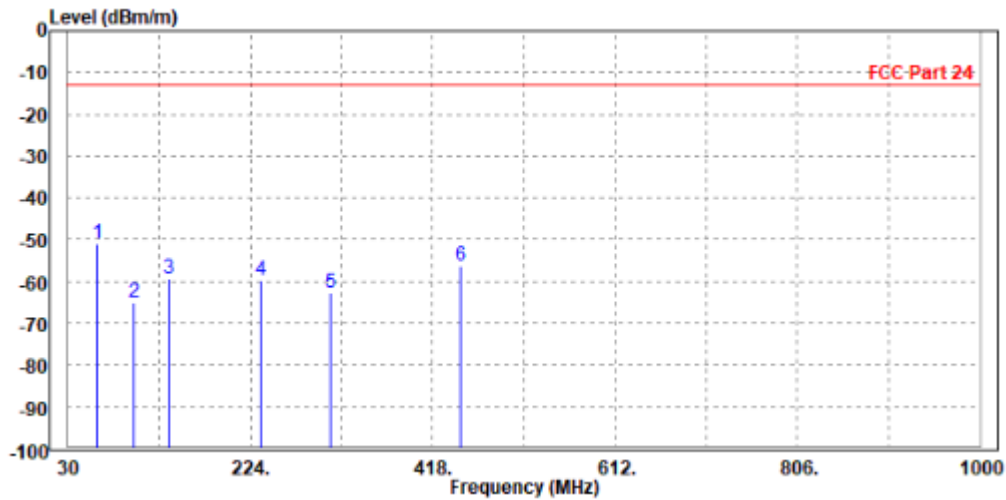



**BUREAU  
VERITAS**

**Test Report No.: W7L-P22080014RF02**

**ABOVE 1GHz DATA**

**Note:** For higher frequency, the emission is too low to be detected.

**WORST-CASE DATA**

**LTE Band 2**

**CHANNEL BANDWIDTH: 1.4MHz / QPSK**

<b>MODE</b>	TX channel 18900	<b>FREQUENCY RANGE</b>	Above 1000MHz
<b>ENVIRONMENTAL CONDITIONS</b>	23deg. C, 70%RH	<b>INPUT POWER</b>	DC30V
<b>TESTED BY</b>	Jace Hu		
<b>ANTENNA POLARITY &amp; TEST DISTANCE: HORIZONTAL AT 3 M</b>			

	Freq	Level	Read Level	Limit Line	Over Limit	Factor	Remark	Pol/Phase
	MHz	dBm/m	dBm	dBm/m	dB	dB/m		
1	3760.000	-51.89	-59.88	-13.00	-38.89	7.99	Peak	Horizontal
2 PP	5636.000	-51.17	-61.90	-13.00	-38.17	10.73	Peak	Horizontal

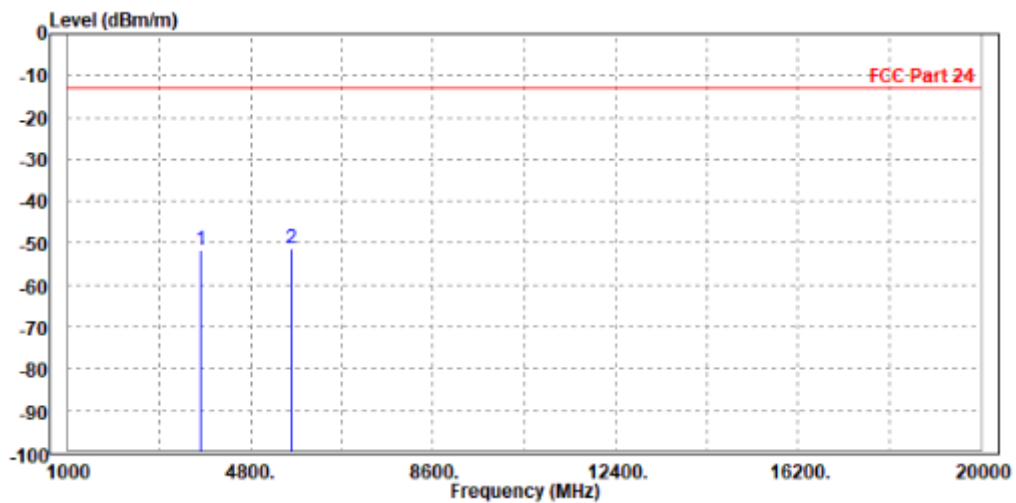



**BUREAU  
VERITAS**

Test Report No.: W7L-P22080014RF02

<b>MODE</b>	TX channel 18900	<b>FREQUENCY RANGE</b>	Above 1000MHz
<b>ENVIRONMENTAL CONDITIONS</b>	23deg. C, 70%RH	<b>INPUT POWER</b>	DC30V
<b>TESTED BY</b>	Jace Hu		
<b>ANTENNA POLARITY &amp; TEST DISTANCE: VERTICAL AT 3 M</b>			

	Freq	Level	Read Level	Limit Line	Over Limit	Factor	Remark	Pol/Phase
	MHz	dBm/m	dBm	dBm/m	dB	dB/m		
1	3755.000	-52.06	-59.75	-13.00	-39.06	7.69	Peak	Vertical
2 PP	5640.000	-50.91	-62.04	-13.00	-37.91	11.13	Peak	Vertical

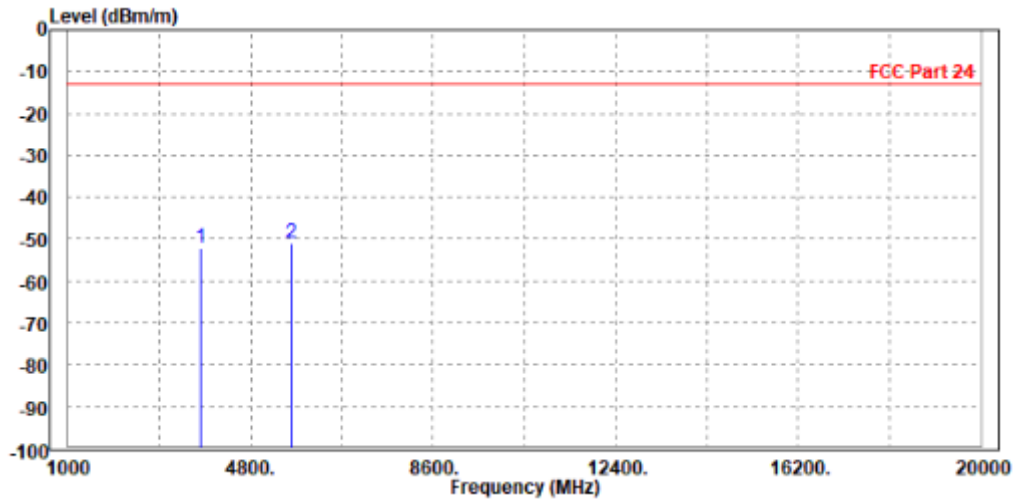



BUREAU VERITAS

Test Report No.: W7L-P22080014RF02

CHANNEL BANDWIDTH: 3MHz / QPSK

MODE	TX channel 18900	FREQUENCY RANGE	Above 1000MHz
ENVIRONMENTAL CONDITIONS	23deg. C, 70%RH	INPUT POWER	DC30V
TESTED BY	Jace Hu		
<b>ANTENNA POLARITY &amp; TEST DISTANCE: HORIZONTAL AT 3 M</b>			

	Freq	Level	Read Level	Limit Line	Over Limit	Factor	Remark	Pol/Phase
	MHz	dBm/m	dBm	dBm/m	dB	dB/m		
1 PP	3755.000	-46.67	-54.65	-13.00	-33.67	7.98	Peak	Horizontal
2	5640.000	-53.16	-63.90	-13.00	-40.16	10.74	Peak	Horizontal

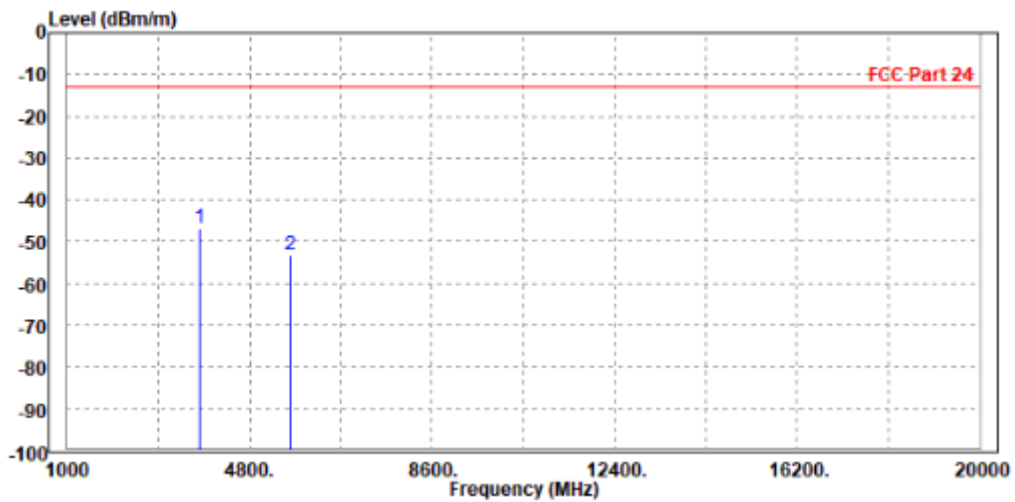



**BUREAU  
VERITAS**

**Test Report No.: W7L-P22080014RF02**

<b>MODE</b>	TX channel 18900	<b>FREQUENCY RANGE</b>	Above 1000MHz
<b>ENVIRONMENTAL CONDITIONS</b>	23deg. C, 70%RH	<b>INPUT POWER</b>	DC30V
<b>TESTED BY</b>	Jace Hu		
<b>ANTENNA POLARITY &amp; TEST DISTANCE: VERTICAL AT 3 M</b>			

	Freq	Level	Read Level	Limit Line	Over Limit	Factor	Remark	Pol/Phase
	MHz	dBm/m	dBm	dBm/m	dB	dB/m		
1	3760.000	-45.53	-53.23	-13.00	-32.53	7.70	Peak	Vertical
2 PP	5636.000	-44.97	-56.09	-13.00	-31.97	11.12	Peak	Vertical

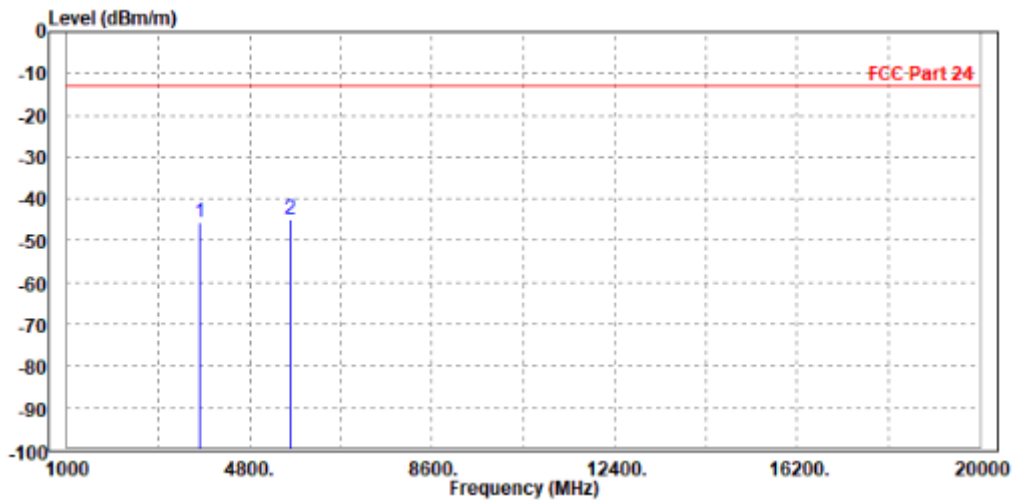



**BUREAU  
VERITAS**

Test Report No.: W7L-P22080014RF02

**CHANNEL BANDWIDTH: 5MHz / QPSK**

<b>MODE</b>	TX channel 18900	<b>FREQUENCY RANGE</b>	Above 1000MHz
<b>ENVIRONMENTAL CONDITIONS</b>	23deg. C, 70%RH	<b>INPUT POWER</b>	DC30V
<b>TESTED BY</b>	Jace Hu		
<b>ANTENNA POLARITY &amp; TEST DISTANCE: HORIZONTAL AT 3 M</b>			

	Freq	Level	Read Level	Limit	Over	Factor	Remark	Pol/Phase
	MHz	dBm/m	dBm	dBm/m	dB	dB/m		
1	PP 3760.000	-52.14	-60.13	-13.00	-39.14	7.99	Peak	Horizontal
2	5636.000	-52.52	-63.25	-13.00	-39.52	10.73	Peak	Horizontal

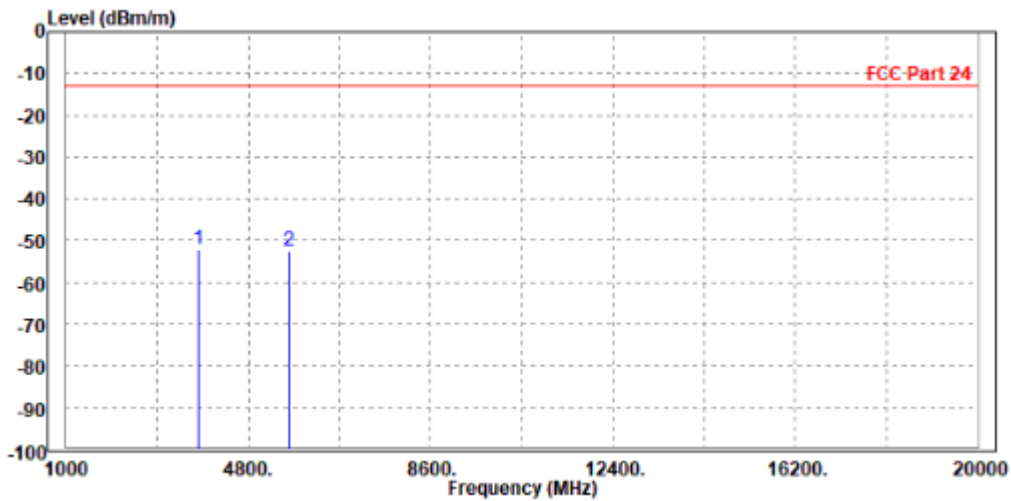





**BUREAU  
VERITAS**

**Test Report No.: W7L-P22080014RF02**

<b>MODE</b>	TX channel 18900	<b>FREQUENCY RANGE</b>	Above 1000MHz
<b>ENVIRONMENTAL CONDITIONS</b>	23deg. C, 70%RH	<b>INPUT POWER</b>	DC30V
<b>TESTED BY</b>	Jace Hu		
<b>ANTENNA POLARITY &amp; TEST DISTANCE: VERTICAL AT 3 M</b>			

	Freq	Level	Read Level	Limit Line	Over Limit	Factor	Remark	Pol/Phase
	MHz	dBm/m	dBm	dBm/m	dB	dB/m		
1	3755.000	-52.67	-60.36	-13.00	-39.67	7.69	Peak	Vertical
2 PP	5640.000	-52.57	-63.70	-13.00	-39.57	11.13	Peak	Vertical

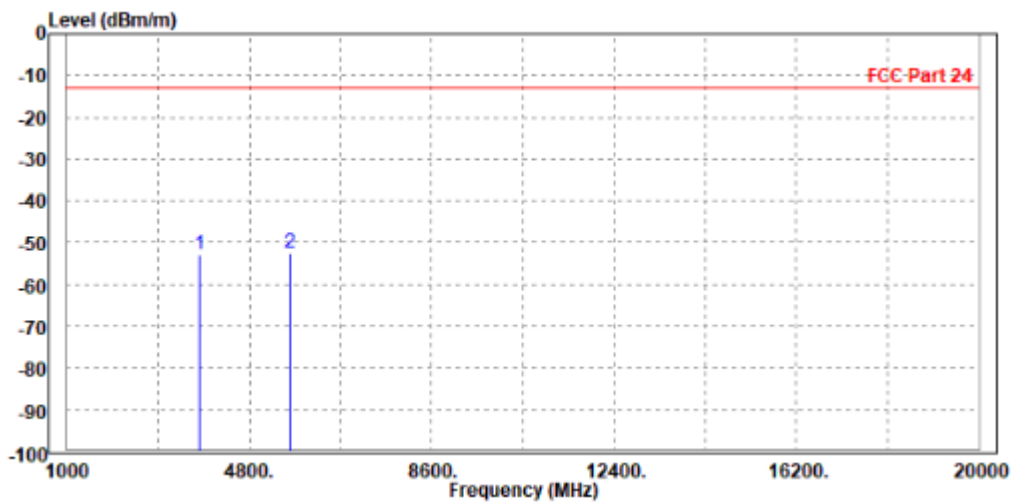



**BUREAU  
VERITAS**

Test Report No.: W7L-P22080014RF02

**CHANNEL BANDWIDTH: 10MHz / QPSK**

**CH18650**

<b>MODE</b>	TX channel 18650	<b>FREQUENCY RANGE</b>	Above 1000MHz
<b>ENVIRONMENTAL CONDITIONS</b>	23deg. C, 70%RH	<b>INPUT POWER</b>	DC30V
<b>TESTED BY</b>	Jace Hu		
<b>ANTENNA POLARITY &amp; TEST DISTANCE: HORIZONTAL AT 3 M</b>			

	Freq	Level	Read Level	Limit Line	Over Limit	Factor	Remark	Pol/Phase
	MHz	dBm/m	dBm	dBm/m	dB	dB/m		
1 PP	3717.000	-52.43	-60.31	-13.00	-39.43	7.88	Peak	Horizontal
2	5565.000	-52.60	-63.20	-13.00	-39.60	10.60	Peak	Horizontal

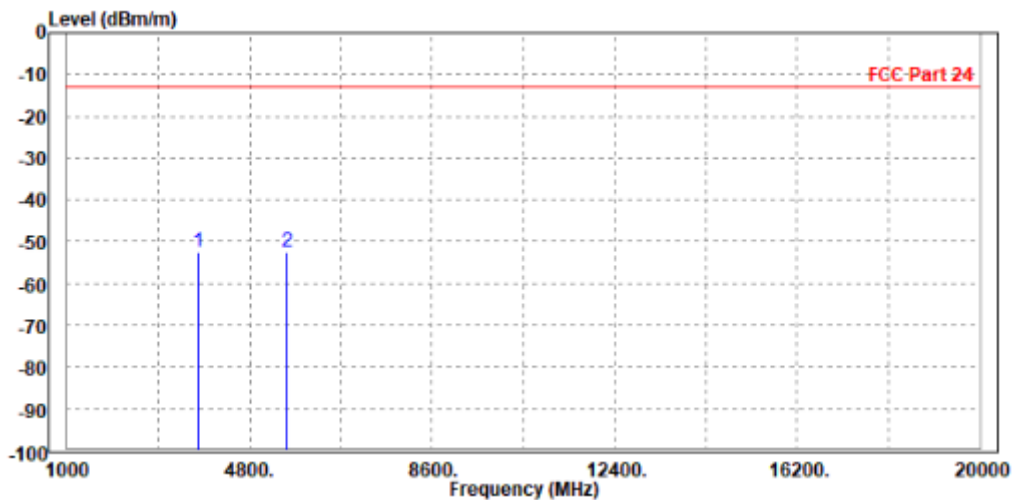



**BUREAU  
VERITAS**

Test Report No.: W7L-P22080014RF02

<b>MODE</b>	TX channel 18650	<b>FREQUENCY RANGE</b>	Above 1000MHz
<b>ENVIRONMENTAL CONDITIONS</b>	23deg. C, 70%RH	<b>INPUT POWER</b>	DC30V
<b>TESTED BY</b>	Jace Hu		
<b>ANTENNA POLARITY &amp; TEST DISTANCE: VERTICAL AT 3 M</b>			

	Freq	Level	Read Level	Limit Line	Over Limit	Factor	Remark	Pol/Phase
	MHz	dBm/m	dBm	dBm/m	dB	dB/m		
1	3710.000	-52.64	-60.26	-13.00	-39.64	7.62	Peak	Vertical
2 PP	5560.000	-51.88	-62.78	-13.00	-38.88	10.90	Peak	Vertical

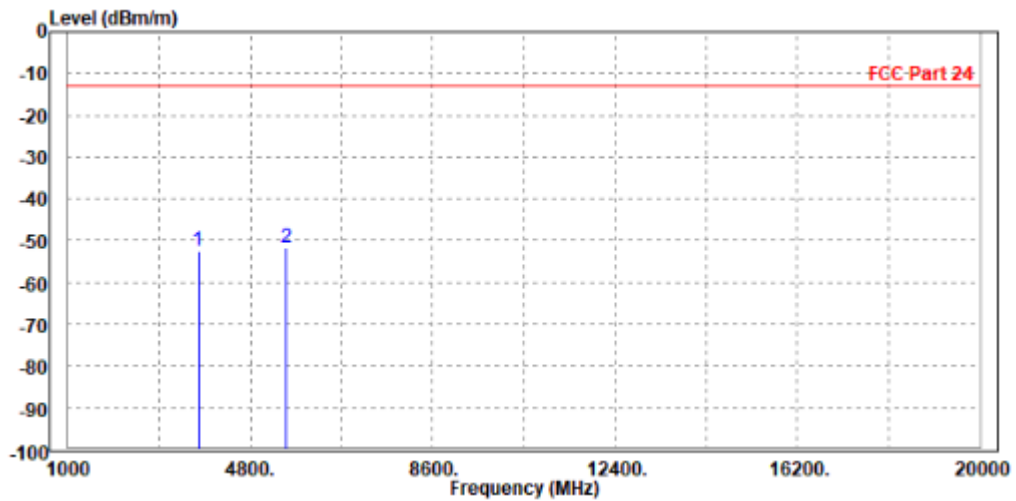



**BUREAU  
VERITAS**

Test Report No.: W7L-P22080014RF02

CH18900

<b>MODE</b>	TX channel 18900	<b>FREQUENCY RANGE</b>	Above 1000MHz
<b>ENVIRONMENTAL CONDITIONS</b>	23deg. C, 70%RH	<b>INPUT POWER</b>	DC30V
<b>TESTED BY</b>	Jace Hu		
<b>ANTENNA POLARITY &amp; TEST DISTANCE: HORIZONTAL AT 3 M</b>			

	Freq	Level	Read Level	Limit Line	Over Limit	Factor	Remark	Pol/Phase
	MHz	dBm/m	dBm	dBm/m	dB	dB/m		
1	3760.000	-47.41	-55.40	-13.00	-34.41	7.99	Peak	Horizontal
2 PP	5636.000	-40.45	-51.18	-13.00	-27.45	10.73	Peak	Horizontal

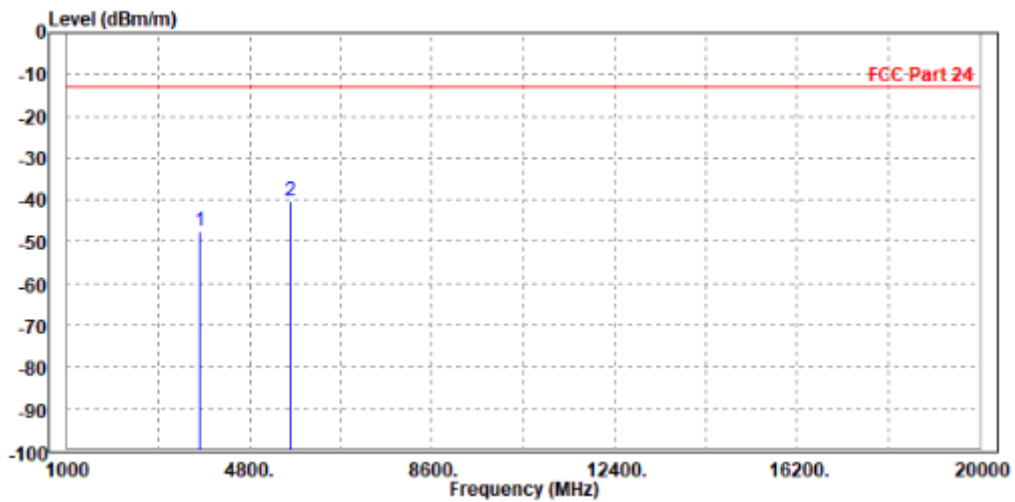



**BUREAU  
VERITAS**

**Test Report No.: W7L-P22080014RF02**

<b>MODE</b>	TX channel 18900	<b>FREQUENCY RANGE</b>	Above 1000MHz
<b>ENVIRONMENTAL CONDITIONS</b>	23deg. C, 70%RH	<b>INPUT POWER</b>	DC30V
<b>TESTED BY</b>	Jace Hu		
<b>ANTENNA POLARITY &amp; TEST DISTANCE: VERTICAL AT 3 M</b>			

	Freq	Level	Read Level	Limit Line	Over Limit	Factor	Remark	Pol/Phase
	MHz	dBm/m	dBm	dBm/m	dB	dB/m		
1	3755.000	-44.84	-52.53	-13.00	-31.84	7.69	Peak	Vertical
2 PP	5640.000	-43.99	-55.12	-13.00	-30.99	11.13	Peak	Vertical

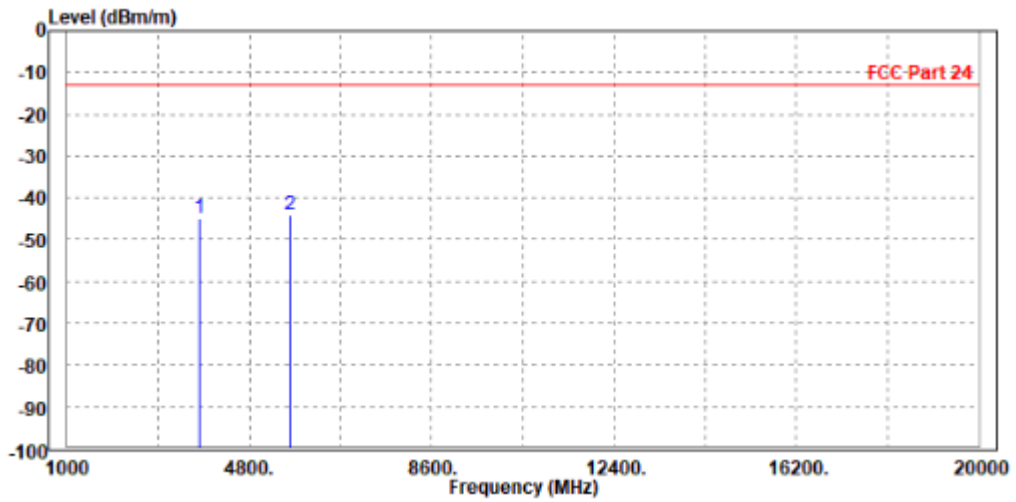



BUREAU  
VERITAS

Test Report No.: W7L-P22080014RF02

CH19150

MODE	TX channel 19150	FREQUENCY RANGE	Above 1000MHz
ENVIRONMENTAL CONDITIONS	23deg. C, 70%RH	INPUT POWER	DC30V
TESTED BY	Jace Hu		
ANTENNA POLARITY & TEST DISTANCE: HORIZONTAL AT 3 M			

	Freq	Level	Read Level	Limit Line	Over Limit	Factor	Remark	Pol/Phase
	MHz	dBm/m	dBm	dBm/m	dB	dB/m		
1	3810.000	-51.48	-59.60	-13.00	-38.48	8.12	Peak	Horizontal
2 PP	5712.000	-50.54	-61.42	-13.00	-37.54	10.88	Peak	Horizontal

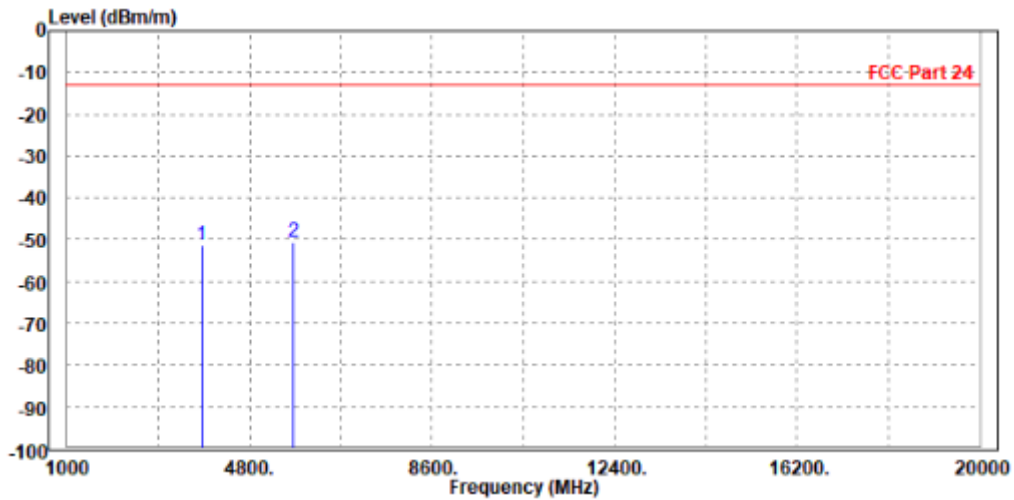



**BUREAU  
VERITAS**

Test Report No.: W7L-P22080014RF02

<b>MODE</b>	TX channel 19150	<b>FREQUENCY RANGE</b>	Above 1000MHz
<b>ENVIRONMENTAL CONDITIONS</b>	23deg. C, 70%RH	<b>INPUT POWER</b>	DC30V
<b>TESTED BY</b>	Jace Hu		
<b>ANTENNA POLARITY &amp; TEST DISTANCE: VERTICAL AT 3 M</b>			

	Freq	Level	Read Level	Limit Line	Over Limit	Factor	Remark	Pol/Phase
	MHz	dBm/m	dBm	dBm/m	dB	dB/m		
1	3812.000	-51.06	-58.83	-13.00	-38.06	7.77	Peak	Vertical
2 PP	5715.000	-49.61	-60.95	-13.00	-36.61	11.34	Peak	Vertical

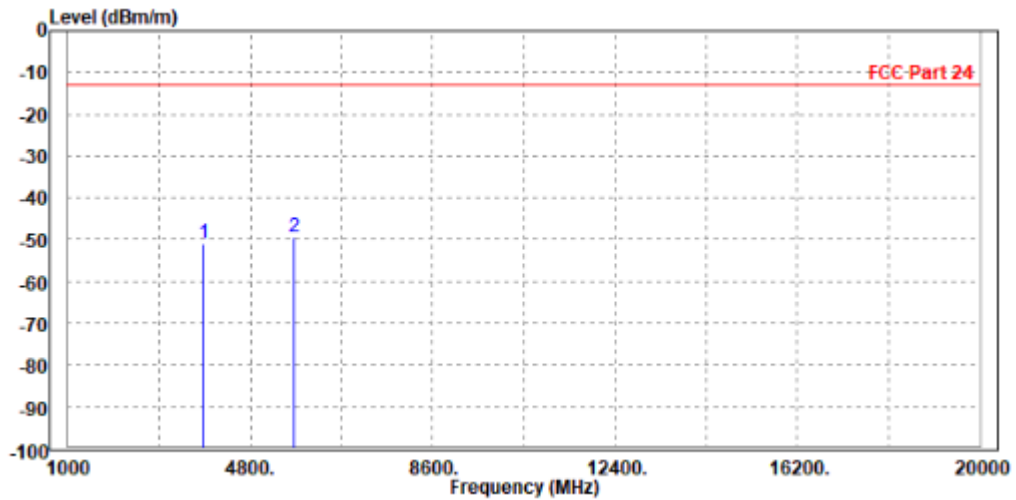



BUREAU VERITAS

Test Report No.: W7L-P22080014RF02

CHANNEL BANDWIDTH: 15MHz / QPSK

MODE	TX channel 18900	FREQUENCY RANGE	Above 1000MHz
ENVIRONMENTAL CONDITIONS	23deg. C, 70%RH	INPUT POWER	DC30V
TESTED BY	Jace Hu		
<b>ANTENNA POLARITY &amp; TEST DISTANCE: HORIZONTAL AT 3 M</b>			

	Freq	Level	Read Level	Limit Line	Over Limit	Factor	Remark	Pol/Phase
	MHz	dBm/m	dBm	dBm/m	dB	dB/m		
1	3755.000	-50.84	-58.82	-13.00	-37.84	7.98	Peak	Horizontal
2 PP	5640.000	-43.41	-54.15	-13.00	-30.41	10.74	Peak	Horizontal

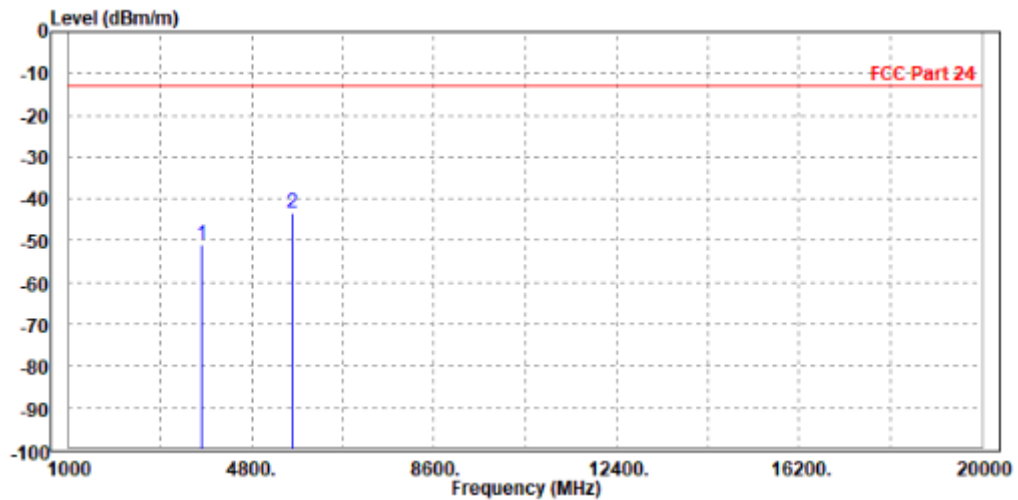





**BUREAU  
VERITAS**

**Test Report No.: W7L-P22080014RF02**

<b>MODE</b>	TX channel 18900	<b>FREQUENCY RANGE</b>	Above 1000MHz
<b>ENVIRONMENTAL CONDITIONS</b>	23deg. C, 70%RH	<b>INPUT POWER</b>	DC30V
<b>TESTED BY</b>	Jace Hu		
<b>ANTENNA POLARITY &amp; TEST DISTANCE: VERTICAL AT 3 M</b>			

	Freq	Level	Read Level	Limit Line	Over Limit	Factor	Remark	Pol/Phase
	MHz	dBm/m	dBm	dBm/m	dB	dB/m		
1	3760.000	-51.72	-59.42	-13.00	-38.72	7.70	Peak	Vertical
2 PP	5636.000	-51.59	-62.71	-13.00	-38.59	11.12	Peak	Vertical

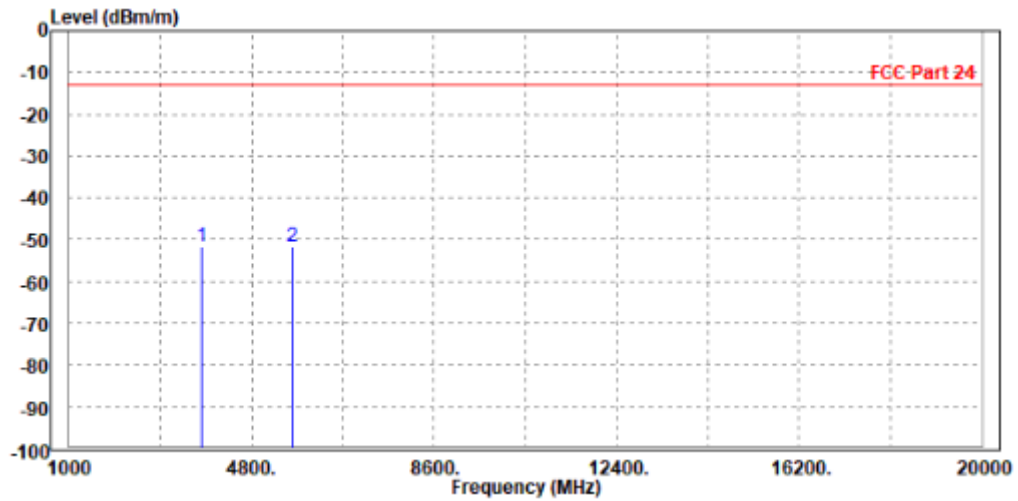



**BUREAU  
VERITAS**

Test Report No.: W7L-P22080014RF02

**CHANNEL BANDWIDTH: 20MHz / QPSK**

<b>MODE</b>	TX channel 18900	<b>FREQUENCY RANGE</b>	Above 1000MHz
<b>ENVIRONMENTAL CONDITIONS</b>	23deg. C, 70%RH	<b>INPUT POWER</b>	DC30V
<b>TESTED BY</b>	Jace Hu		
<b>ANTENNA POLARITY &amp; TEST DISTANCE: HORIZONTAL AT 3 M</b>			

	Freq	Level	Read Level	Limit Line	Over Limit	Factor	Remark	Pol/Phase
	MHz	dBm/m	dBm	dBm/m	dB	dB/m		
1	3760.000	-47.26	-55.25	-13.00	-34.26	7.99	Peak	Horizontal
2 PP	5636.000	-43.64	-54.37	-13.00	-30.64	10.73	Peak	Horizontal

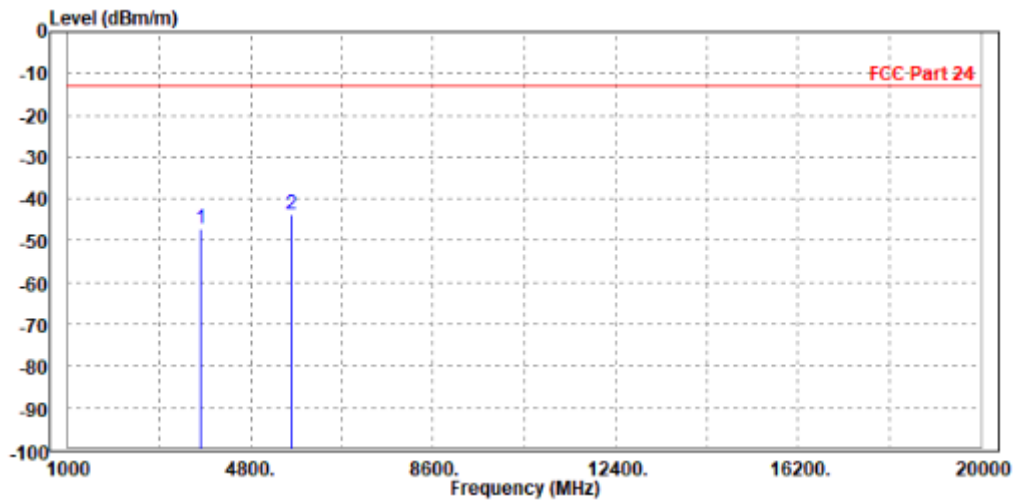



**BUREAU  
VERITAS**

Test Report No.: W7L-P22080014RF02

<b>MODE</b>	TX channel 18900	<b>FREQUENCY RANGE</b>	Above 1000MHz
<b>ENVIRONMENTAL CONDITIONS</b>	23deg. C, 70%RH	<b>INPUT POWER</b>	DC30V
<b>TESTED BY</b>	Jace Hu		
<b>ANTENNA POLARITY &amp; TEST DISTANCE: VERTICAL AT 3 M</b>			

	Freq	Level	Read Level	Limit Line	Over Limit	Factor	Remark	Pol/Phase
	MHz	dBm/m	dBm	dBm/m	dB	dB/m		
1	3755.000	-46.31	-54.00	-13.00	-33.31	7.69	Peak	Vertical
2 PP	5640.000	-42.84	-53.97	-13.00	-29.84	11.13	Peak	Vertical

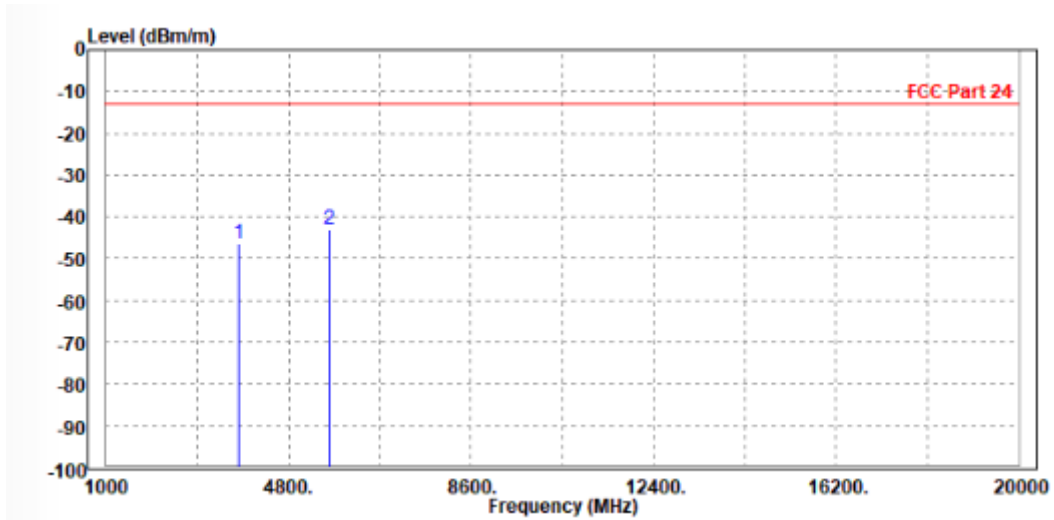



### 3.7 PEAK TO AVERAGE RATIO

#### 3.7.1 LIMITS OF PEAK TO AVERAGE RATIO MEASUREMENT

In measuring transmissions in this band using an average power technique, the peak to-average ratio (PAR) of the transmission may not exceed 13 dB

#### 3.7.2 TEST SETUP

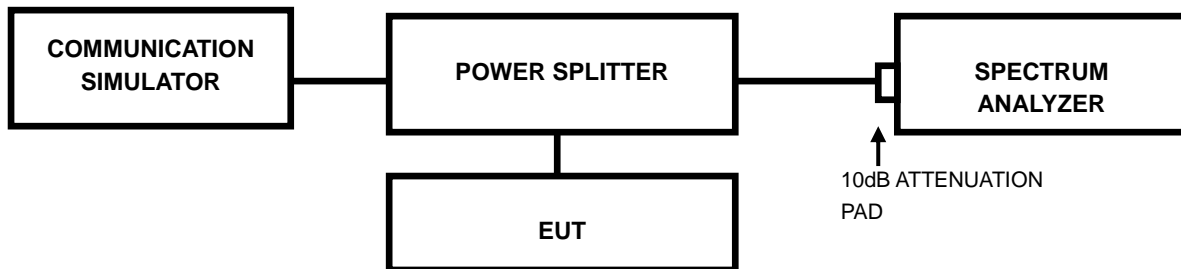

#### 3.7.3 TEST PROCEDURES

1. Set resolution/measurement bandwidth  $\geq$  signal's occupied bandwidth;
2. Set the number of counts to a value that stabilizes the measured CCDF curve;
3. Record the maximum PAPR level associated with a probability of 0.1%.



**BUREAU  
VERITAS**

**Test Report No.: W7L-P22080014RF02**

### 3.7.4 TEST RESULTS

Please Refer to Module report R2007A0435-R5.



**BUREAU  
VERITAS**

Test Report No.: W7L-P22080014RF02

## 4 INFORMATION ON THE TESTING LABORATORIES

We, BV 7LAYERS COMMUNICATIONS TECHNOLOGY (SHENZHEN) CO. LTD., were founded in 2015 to provide our best service in EMC, Radio, Telecom and Safety consultation. Our laboratories are accredited and approved according to ISO/IEC 17025.

If you have any comments, please feel free to contact us at the following:

**Shenzhen EMC/RF Lab:**

Tel: +86-755-88696566

Fax: +86-755-88696577

**Email:** [customerservice.sw@bureauveritas.com](mailto:customerservice.sw@bureauveritas.com)

**Web Site:** [www.adt.com.tw](http://www.adt.com.tw)

The address and road map of all our labs can be found in our web site also.



Test Report No.: W7L-P22080014RF02

## 5 MODIFICATIONS RECORDERS FOR ENGINEERING CHANGES TO THE EUT BY THE LAB

No any modifications are made to the EUT by the lab during the test.

---END---