

---

# SAR Test Report

---

Report No.: AGC00653161202FH01

**FCC ID** : 2AEM6TT-772

**APPLICATION PURPOSE** : Original Equipment

**PRODUCT DESIGNATION** : Tablet

**BRAND NAME** : TIGERS

**MODEL NAME** : TT-772

**CLIENT** : MOVEON TECHNOLOGY (HK) CO., LTD.

**DATE OF ISSUE** : Jan.07,2017

**STANDARD(S)** : IEEE Std. 1528:2013  
FCC 47CFR § 2.1093  
IEEE/ANSI C95.1:2005

**REPORT VERSION** : V1.0

Attestation of Global Compliance(Shenzhen) Co., Ltd.

**CAUTION:**

This report shall not be reproduced except in full without the written permission of the test laboratory and shall not be quoted out of context.



### Report Revise Record

Report Version	Revise Time	Issued Date	Valid Version	Notes
V1.0	/	Jan.07,2017	Valid	Original Report

## Test Report Certification

Applicant Name	MOVEON TECHNOLOGY (HK) CO., LTD.
Applicant Address	Room 3201, Building A, World Trading Plaza Block, Futian Rd., Futian Distric, Shenzhen, China
Manufacturer Name	MOVEON TECHNOLOGY LIMITED
Manufacturer Address	World Trade Plaza-A Block #3201-3202 Fuhong Road, Futian
Product Designation	Tablet
Brand Name	TIGERS
Model Name	TT-772
Different Description	N/A
EUT Voltage	DC3.7V by battery
Applicable Standard	IEEE Std. 1528:2013 FCC 47CFR § 2.1093 IEEE/ANSI C95.1:2005
Test Date	Dec.27,2016 to Jan. 05,2017
Performed Location	Attestation of Global Compliance(Shenzhen) Co., Ltd. 2 F, Building 2, No.1-No.4, Chaxi Sanwei Technical Industrial Park, Gushu, Xixiang Street, Bao'an District, Shenzhen, China
Report Template	AGCRT-US-3G3/SAR (2016-01-01)

*Judy Xie*

Tested By \_\_\_\_\_  
Judy Xie(Xie Fan) Jan. 05,2017

*Angela Li*

Checked By \_\_\_\_\_  
Angela Li(Li Jiao) Jan.07,2017

*Solger Zhang*

Authorized By \_\_\_\_\_  
Solger Zhang(Zhang Hongyi) Jan.07,2017  
Authorized Officer

## TABLE OF CONTENTS

<b>1. SUMMARY OF MAXIMUM SAR VALUE .....</b>	<b>5</b>
<b>2. GENERAL INFORMATION.....</b>	<b>6</b>
2.1. EUT DESCRIPTION.....	6
<b>3. SAR MEASUREMENT SYSTEM.....</b>	<b>8</b>
3.1. THE SATIMO SYSTEM USED FOR PERFORMING COMPLIANCE TESTS CONSISTS OF FOLLOWING ITEMS .....	8
3.2. COMOSAR E-FIELD PROBE .....	9
3.3. ROBOT.....	9
3.4. VIDEO POSITIONING SYSTEM .....	10
3.5. DEVICE HOLDER .....	10
3.6. SAM TWIN PHANTOM.....	11
<b>4. SAR MEASUREMENT PROCEDURE.....</b>	<b>12</b>
4.1. SPECIFIC ABSORPTION RATE (SAR).....	12
4.2. SAR MEASUREMENT PROCEDURE .....	13
4.3. RF EXPOSURE CONDITIONS .....	15
<b>5. TISSUE SIMULATING LIQUID.....</b>	<b>17</b>
5.1. THE COMPOSITION OF THE TISSUE SIMULATING LIQUID.....	17
5.2. TISSUE DIELECTRIC PARAMETERS FOR HEAD AND BODY PHANTOMS .....	17
5.3. TISSUE CALIBRATION RESULT .....	18
<b>6. SAR SYSTEM CHECK PROCEDURE .....</b>	<b>20</b>
6.1. SAR SYSTEM CHECK PROCEDURES .....	20
6.2. SAR SYSTEM CHECK.....	21
<b>7. EUT TEST POSITION.....</b>	<b>22</b>
7.2. CHEEK POSITION .....	23
7.3. TILT POSITION.....	23
7.4. BODY POSITION.....	24
<b>8. SAR EXPOSURE LIMITS .....</b>	<b>25</b>
<b>9. TEST EQUIPMENT LIST .....</b>	<b>26</b>
<b>10. MEASUREMENT UNCERTAINTY .....</b>	<b>27</b>
<b>11. CONDUCTED POWER MEASUREMENT.....</b>	<b>30</b>
<b>12. TEST RESULTS .....</b>	<b>38</b>
12.1. SAR TEST RESULTS SUMMARY.....	38
<b>APPENDIX A. SAR SYSTEM CHECK DATA .....</b>	<b>50</b>
<b>APPENDIX B. SAR MEASUREMENT DATA.....</b>	<b>62</b>
<b>APPENDIX C. TEST SETUP PHOTOGRAPHS &amp;EUT PHOTOGRAPHS.....</b>	<b>98</b>
<b>APPENDIX D. CALIBRATION DATA .....</b>	<b>98</b>

## 1. SUMMARY OF MAXIMUM SAR VALUE

The maximum results of Specific Absorption Rate (SAR) found during testing for EUT are as follows:

Frequency Band	Highest Reported 1g-SAR(W/Kg)		SAR Test Limit (W/Kg)
	Head	Body-worn	
GSM 850	0.130	0.781	1.6
PCS 1900	0.163	0.910	
UMTS Band II	0.094	0.489	
UMTS Band V	0.087	1.066	
WIFI 2.4G	0.020	0.121	
Simultaneous Reported SAR	1.187		
SAR Test Result	PASS		

This device is compliance with Specific Absorption Rate (SAR) for general population/uncontrolled exposure limits (1.6W/Kg) specified in IEEE Std. 1528:2013; FCC 47CFR § 2.1093; IEEE/ANSI C95.1:2005 and the following specific FCC Test Procedures:

- KDB 447498 D01 General RF Exposure Guidance v06
- KDB 648474 D04 Handset SAR v01r03
- KDB 865664 D01 SAR Measurement 100MHz to 6GHz v01r04
- KDB 941225 D01 3G SAR Procedures v03r01
- KDB 941225 D06 Hotspot Mode v02r01
- KDB 248227 D01 802 11 Wi-Fi SAR v02r02
- KDB 616217 D04 SAR for laptop and tablets v01r02

## 2. GENERAL INFORMATION

### 2.1. EUT Description

General Information	
Product Designation	Tablet
Test Model	TT-772
Hardware Version	ELINK-C706D_V2
Software Version	MT8312CW_C706_C7061H1C2W1.2015081612
Device Category	Portable
RF Exposure Environment	Uncontrolled
Antenna Type	Internal
GSM and GPRS	
Support Band	<input checked="" type="checkbox"/> GSM 850 <input checked="" type="checkbox"/> PCS 1900 <input checked="" type="checkbox"/> GSM 900 <input checked="" type="checkbox"/> DCS 1800
GPRS Type	Class B
GPRS Class	Class 12(1Tx+4Rx, 2Tx+3Rx, 3Tx+2Rx, 4Tx+1Rx)
TX Frequency Range	GSM 850 : 820-850MHz;; PCS 1900: 1850-1910MHz;
RX Frequency Range	GSM 850 : 869~894MHz; PCS 1900: 1930~1990MHz
Release Version	R99
Type of modulation	GMSK for GSM/GPRS
Antenna Gain	3.28dBi
Max. Average Power	GSM850: 31.73dBm ;PCS1900: 28.81dBm
WCDMA	
Support Band	<input checked="" type="checkbox"/> UMTS FDD Band II <input checked="" type="checkbox"/> UMTS FDD Band V <input checked="" type="checkbox"/> UMTS FDD Band I <input type="checkbox"/> UMTS FDD Band VIII
HS Type	HSPA(HSUPA/HSDPA)
TX Frequency Range	WCDMA FDD Band II: 1850-1910MHz;WCDMA FDD Band V: 820-850MHz
RX Frequency Range	WCDMA FDD Band II: 1930-1990MHz;WCDMA FDD Band V: 869-894MHz
Release Version	Rel-6
Type of modulation	HSDPA:QPSK/16QAM; HSUPA:BPSK; WCDMA:QPSK
Antenna Gain	3.28dBi
Max. Average Power	Band II: 21.76dBm; Band V: 21.59dBm

**EUT Description( Continue)**

<b>Bluetooth</b>	
Bluetooth Version	<input type="checkbox"/> V2.0 <input type="checkbox"/> V2.1 <input type="checkbox"/> V2.1+EDR <input checked="" type="checkbox"/> V3.0 <input type="checkbox"/> V3.0+HS <input checked="" type="checkbox"/> V4.0 <input type="checkbox"/> V4.1
Operation Frequency	2402~2480MHz
Type of modulation	<input checked="" type="checkbox"/> GFSK <input checked="" type="checkbox"/> II/4-DQPSK <input checked="" type="checkbox"/> 8-DPSK
Avg. Burst Power	2.883dBm
Antenna Gain	3.28dBi
<b>WIFI</b>	
WIFI Specification	<input type="checkbox"/> 802.11a <input checked="" type="checkbox"/> 802.11b <input checked="" type="checkbox"/> 802.11g <input checked="" type="checkbox"/> 802.11n(20) <input checked="" type="checkbox"/> 802.11n(40)
Operation Frequency	2412~2462MHz
Avg. Burst Power	11b:13.38dBm,11g:10.97dBm,11n(20):10.89dBm,11n(40):9.76dBm
Antenna Gain	3.28dBi
<b>Accessories</b>	
Battery	Brand name: N/A Model No. : 357090 Voltage and Capacitance: 3.7 V & 3400mAh
Adapter	Brand name: TIGERS Model No. : TT-772 Input: AC 100-240V, 50/60Hz, 500mA    Output: DC 5V, 2A
Earphone	Brand name: N/A Model No. : N/A

Note:1.CMU200 can measure the average power and Peak power at the same time  
2.The sample used for testing is end product.

Product	Type
	<input checked="" type="checkbox"/> Production unit <input type="checkbox"/> Identical Prototype

### 3. SAR MEASUREMENT SYSTEM

#### 3.1. The SATIMO system used for performing compliance tests consists of following items

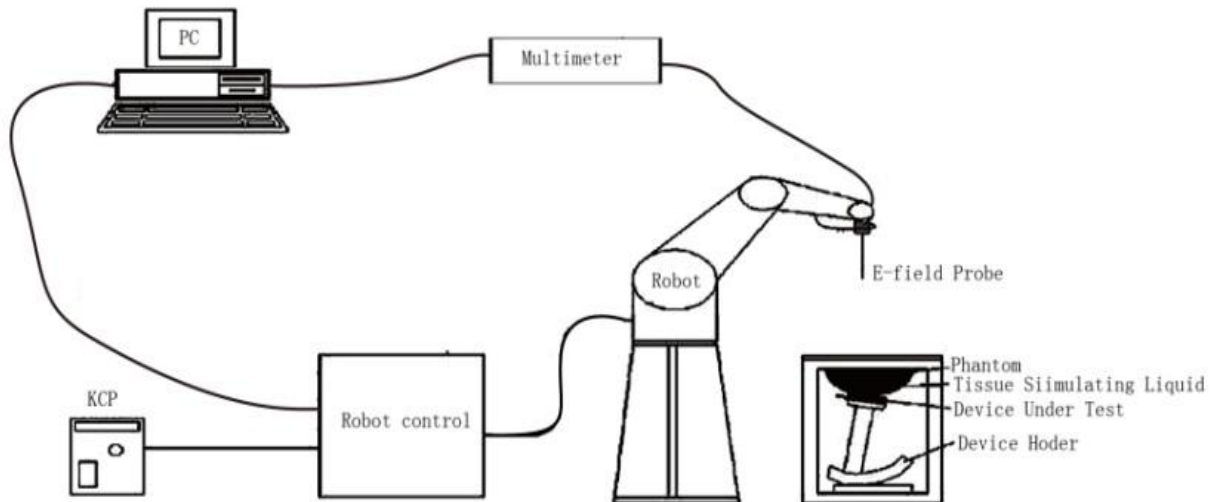

The COMOSAR system for performing compliance tests consists of the following items:

- The PC. It controls most of the bench devices and stores measurement data. A computer running WinXP and the Opensar software.
- The E-Field probe. The probe is a 3-axis system made of 3 distinct dipoles. Each dipole returns a voltage in function of the ambient electric field.
- The Keithley multimeter measures each probe dipole voltages.
- The SAM phantom simulates a human head. The measurement of the electric field is made inside the phantom.
- The liquids simulate the dielectric properties of the human head tissues.
- The network emulator controls the mobile phone under test.
- The validation dipoles are used to measure a reference SAR. They are used to periodically check the bench to make sure that there is no drift of the system characteristics over time.
- The phantom, the device holder and other accessories according to the targeted measurement.



### 3.2. COMOSAR E-Field Probe

The SAR measurement is conducted with the dosimetric probe manufactured by SATIMO. The probe is specially designed and calibrated for use in liquid with high permittivity. The dosimetric probe has special calibration in liquid at different frequency. SATIMO conducts the probe calibration in compliance with international and national standards (e.g. IEEE 1528 and relevant KDB files.) The calibration data are in Appendix D.

#### Isotropic E-Field Probe Specification

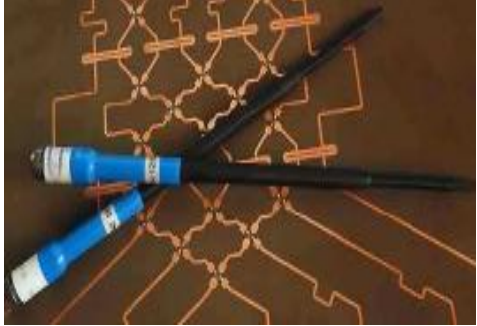
<b>Model</b>	SSE5	
<b>Manufacture</b>	MVG	
<b>Frequency</b>	0.7GHz-3GHz Linearity:±0.05dB(700MHz-3GHz)	
<b>Dynamic Range</b>	0.01W/Kg-100W/Kg Linearity:±0.05dB	
<b>Dimensions</b>	Overall length:330mm Length of individual dipoles:4.5mm Maximum external diameter:8mm Probe Tip external diameter:5mm Distance between dipoles/ probe extremity:2.7mm	
<b>Application</b>	High precision dosimetric measurements in any exposure scenario (e.g., very strong gradient fields). Only probe which enables compliance testing for frequencies up to 3 GHz with precision of better 30%.	

### 3.3. Robot

The COMOSAR system uses the KUKA robot from SATIMO SA (France).For the 6-axis controller COMOSAR system, the KUKA robot controller version from SATIMO is used.

The XL robot series have many features that are important for our application:

- High precision (repeatability 0.02 mm)
- High reliability (industrial design)
- Jerk-free straight movements
- Low ELF interference (the closed metallic construction shields against motor control fields)
- 6-axis controller



### 3.4. Video Positioning System

The video positioning system is used in OpenSAR to check the probe. Which is composed of a camera, LED, mirror and mechanical parts. The camera is piloted by the main computer with firewire link. During the process, the actual position of the probe tip with respect to the robot arm is measured, as well as the probe length and the horizontal probe offset. The software then corrects all movements, such that the robot coordinates are valid for the probe tip. The repeatability of this process is better than 0.1 mm. If a position has been taught with an aligned probe, the same position will be reached with another aligned probe within 0.1 mm, even if the other probe has different dimensions. During probe rotations, the probe tip will keep its actual position.

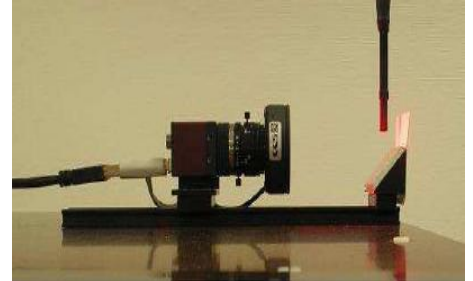

### 3.5. Device Holder

The COMOSAR device holder is designed to cope with different positions given in the standard. It has two scales for the device rotation (with respect to the body axis) and the device inclination (with respect to the line between the ear reference points). The rotation center for both scales is the ear reference point (EPR). Thus the device needs no repositioning when changing the angles. The COMOSAR device holder has been made out of low-loss POM material having the following dielectric parameters: relative permittivity  $\epsilon_r = 3$  and loss tangent  $\delta = 0.02$ . The amount of dielectric material has been reduced in the closest vicinity of the device, since measurements have suggested that the influence of the clamp on the test results could thus be lowered.

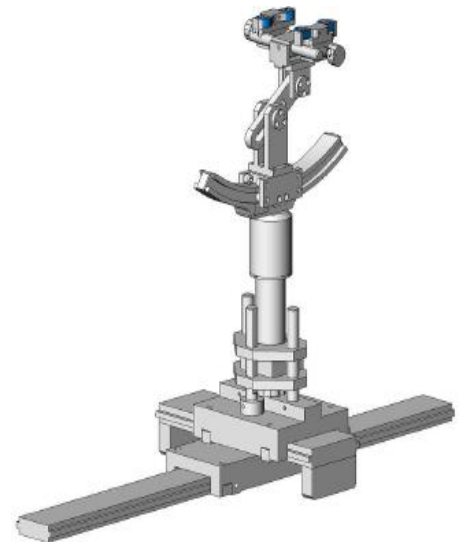

### 3.6. SAM Twin Phantom

The SAM twin phantom is a fiberglass shell phantom with 2mm shell thickness (except the ear region where shell thickness increases to 6mm). It has three measurement areas:

- Left head
- Right head
- Flat phantom



The bottom plate contains three pair of bolts for locking the device holder. The device holder positions are adjusted to the standard measurement positions in the three sections. A white cover is provided to tap the phantom during off-periods to prevent water evaporation and changes in the liquid parameters. On the phantom top, three reference markers are provided to identify the phantom position with respect to the robot.

### ELLI39 Phantom

The Flat phantom is a fiberglass shell phantom with 2mm $\pm$  0.2 mm shell thickness. It has only one measurement area for Flat phantom



## 4. SAR MEASUREMENT PROCEDURE

### 4.1. Specific Absorption Rate (SAR)

SAR is related to the rate at which energy is absorbed per unit mass in object exposed to a radio field. The SAR distribution in a biological body is complicated and is usually carried out by experimental techniques or numerical modeling. The standard recommends limits for two tiers of groups, occupational/controlled and occupational/uncontrolled, based on a person's awareness and ability to exercise control over his or her exposure. In general, occupational/controlled exposure limits are higher than the limits for general population/uncontrolled.

The SAR definition is the time derivative (rate) of the incremental energy (dW) absorbed by (dissipated in) an incremental mass (dm) contained in a volume element(dv) of given mass density ( $\rho$ ). The equation description is as below:

$$SAR = \frac{d}{dt} \left( \frac{dW}{dm} \right) = \frac{d}{dt} \left( \frac{dW}{\rho dV} \right)$$

SAR is expressed in units of Watts per kilogram (W/Kg)

SAR can be obtained using either of the following equations:

$$SAR = \frac{\sigma E^2}{\rho}$$

$$SAR = c_h \left. \frac{dT}{dt} \right|_{t=0}$$

Where

SAR	is the specific absorption rate in watts per kilogram;
E	is the r.m.s. value of the electric field strength in the tissue in volts per meter;
$\sigma$	is the conductivity of the tissue in siemens per metre;
$\rho$	is the density of the tissue in kilograms per cubic metre;
$c_h$	is the heat capacity of the tissue in joules per kilogram and Kelvin;

$\left. \frac{dT}{dt} \right|_{t=0}$  is the initial time derivative of temperature in the tissue in kelvins per second

## 4.2. SAR Measurement Procedure

### Step 1: Power Reference Measurement

The Power Reference Measurement and Power Drift Measurement are for monitoring the power drift of the device under test in the batch process. The minimum distance of probe sensors to surface is 2.7mm This distance cannot be smaller than the distance os sensor calibration points to probe tip as `defined in the probe properties,

### Step 2: Area Scan

The Area Scan is used as a fast scan in two dimensions to find the area of high field values, before doing a fine measurement around the hot spot. The sophisticated interpolation routines implemented in SATIMO software can find the maximum locations even in relatively coarse grids. When an Area Scan has measured all reachable points, it computes the field maximal found in the scanned area, within a range of the global maximum. The range (in db) is specified in the standards for compliance testing. For example, a 2db range is required in IEEE Standard 1528, whereby 3db is a requirement when compliance is assessed in accordance with the ARIB standard (Japan) If one Zoom Scan follows the Area Scan, then only the absolute maximum will be taken as reference. For cases where multiple maximum are detected, the number of Zoom Scan has to be increased accordingly.

Area Scan Parameters extracted from KDB 865664 D01 SAR Measurement 100MHz to 6GHz

	≤ 3 GHz	> 3 GHz
Maximum distance from closest measurement point (geometric center of probe sensors) to phantom surface	5 ± 1 mm	$\frac{1}{2} \cdot \delta \cdot \ln(2) \pm 0.5$ mm
Maximum probe angle from probe axis to phantom surface normal at the measurement location	30° ± 1°	20° ± 1°
Maximum area scan spatial resolution: $\Delta x_{Area}$ , $\Delta y_{Area}$	≤ 2 GHz: ≤ 15 mm 2 – 3 GHz: ≤ 12 mm	3 – 4 GHz: ≤ 12 mm 4 – 6 GHz: ≤ 10 mm
	When the x or y dimension of the test device, in the measurement plane orientation, is smaller than the above, the measurement resolution must be ≤ the corresponding x or y dimension of the test device with at least one measurement point on the test device.	

### Step 3: Zoom Scan

Zoom Scan are used to assess the peak spatial SAR value within a cubic average volume containing 1g abd 10g of simulated tissue. The Zoom Scan measures points(refer to table below) within a cube whose base faces are centered on the maxima found in a preceding area scan job within the same procedure. When the measurement is done, the Zoom Scan evaluates the averaged SAR for 1g and 10g and displays these values next to the job's label.

Zoom Scan Parameters extracted from KDB865664 d01 SAR Measurement 100MHz to 6GHz

Maximum zoom scan spatial resolution: $\Delta x_{Zoom}$ , $\Delta y_{Zoom}$		$\leq 2$ GHz: $\leq 8$ mm 2 – 3 GHz: $\leq 5$ mm*	3 – 4 GHz: $\leq 5$ mm* 4 – 6 GHz: $\leq 4$ mm*
Maximum zoom scan spatial resolution, normal to phantom surface	uniform grid: $\Delta z_{Zoom}(n)$	$\leq 5$ mm	3 – 4 GHz: $\leq 4$ mm 4 – 5 GHz: $\leq 3$ mm 5 – 6 GHz: $\leq 2$ mm
	graded grid	$\Delta z_{Zoom}(1)$ : between 1 <sup>st</sup> two points closest to phantom surface	$\leq 4$ mm
		$\Delta z_{Zoom}(n>1)$ : between subsequent points	$\leq 1.5 \cdot \Delta z_{Zoom}(n-1)$
Minimum zoom scan volume	x, y, z	$\geq 30$ mm	3 – 4 GHz: $\geq 28$ mm 4 – 5 GHz: $\geq 25$ mm 5 – 6 GHz: $\geq 22$ mm
<p>Note: <math>\delta</math> is the penetration depth of a plane-wave at normal incidence to the tissue medium; see draft standard IEEE P1528-2011 for details.</p> <p>* When zoom scan is required and the <i>reported</i> SAR from the <i>area scan based I-g SAR estimation</i> procedures of KDB 447498 is <math>\leq 1.4</math> W/kg, <math>\leq 8</math> mm, <math>\leq 7</math> mm and <math>\leq 5</math> mm zoom scan resolution may be applied, respectively, for 2 GHz to 3 GHz, 3 GHz to 4 GHz and 4 GHz to 6 GHz.</p>			

Step 4: Power Drift Measurement

The Power Drift Measurement measures the field at the same location as the most recent power reference measurement within the same procedure, and with the same settings. The Power Drift Measurement gives the field difference in dB from the reading conducted within the same settings. This allows a user to monitor the power drift of the device under test within a batch process. The measurement procedure is the same as Step 1.

### 4.3. RF Exposure Conditions

Test Configuration and setting:

The EUT is a model of GSM Portable Mobile Station (MS). It supports GSM/GPRS, WCDMA/HSPA, BT, WIFI, and support hot spot mode.

For WWAN SAR testing, the device was controlled by using a base station emulator. Communication between the device and the emulator were established by air link. The distance between the EUT and the antenna is larger than 50cm, and the output power radiated from the emulator antenna is at least 30db smaller than the output power of EUT.

For WLAN testing, the EUT is configured with the WLAN continuous TX tool through engineering command.

#### Antenna Location: ( front view )

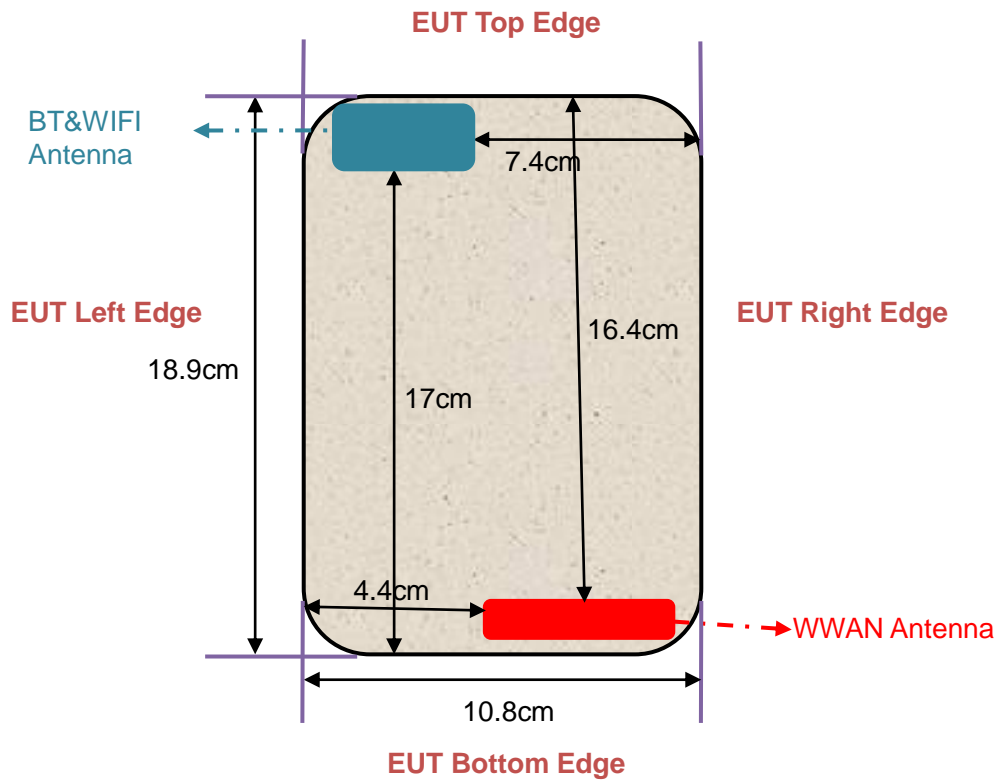

For WWAN mode:

Test Configurations	Antenna to edges/surface	SAR required	Note
Head			
Left Touch		Yes	--
Left Tilt		Yes	--
Right Touch		Yes	--
Right Tilt		Yes	--
Body			
Back	<25mm	Yes	--
Front	<25mm	Yes	--
Hotspot			
Back	<25mm	Yes	--
Front	<25mm	Yes	--
Edge 1 (Top)	164mm	No	SAR is not required for the distance between the antenna and the edge is >25mm as per KDB 941225 D06 Hotspot SAR
Edge 2 (Right)	3mm	Yes	--
Edge 3 (Bottom)	2mm	Yes	--
Edge 4 (Left)	44mm	No	SAR is not required for the distance between the antenna and the edge is >25mm as per KDB 941225 D06 Hotspot SAR

For WLAN mode:

Test Configurations	Antenna to edges/surface	SAR required	Note
Head			
Left Touch		Yes	--
Left Tilt		Yes	--
Right Touch		Yes	--
Right Tilt		Yes	--
Body			
Back	<25mm	Yes	--
Front	<25mm	Yes	--
Hotspot			
Back	<25mm	Yes	--
Front	<25mm	Yes	--
Edge 1 (Top)	4mm	Yes	--
Edge 2 (Right)	74mm	No	SAR is not required for the distance between the antenna and the edge is >25mm as per KDB 941225 D06 Hotspot SAR
Edge 3 (Bottom)	170mm	No	SAR is not required for the distance between the antenna and the edge is >25mm as per KDB 941225 D06 Hotspot SAR
Edge 4 (Left)	4mm	Yes	



## 5. TISSUE SIMULATING LIQUID

For SAR measurement of the field distribution inside the phantom, the phantom must be filled with homogeneous tissue simulating liquid to a depth of at least 15cm. For head SAR testing the liquid height from the ear reference point (ERP) of the phantom to the liquid top surface is larger than 15cm For body SAR testing, the liquid height from the center of the flat phantom to the liquid top surface is larger than 15cm. The nominal dielectric values of the tissue simulating liquids in the phantom and the tolerance of 5% are listed in 5.2

### 5.1. The composition of the tissue simulating liquid

Ingredient (% Weight) Frequency (MHz)	Water	Nacl	Sugar	HEC	Bactericide	DGBE	1,2 Propanediol	Triton X-100
835 Head	40.45	1.45	57	1	0.1	0.0	0.0	0.0
835 Body	54.00	1	0.0	0.0	0.0	15	0.0	30
1900 Head	54.9	0.18	0.0	0.0	0.0	44.92	0.0	0.0
1900 Body	70	1	0.0	0.0	0.0	9	0.0	20
2450 Head	71.88	0.16	0.0	0.0	0.0	7.99	0.0	19.97
2450 Body	70	1	0.0	0.0	0.0	9	0.0	20

### 5.2. Tissue Dielectric Parameters for Head and Body Phantoms

The head tissue dielectric parameters recommended by the IEEE 1528 have been incorporated in the following table. These head parameters are derived from planar layer models simulating the highest expected SAR for the dielectric properties and tissue thickness variations in a human head. Other head and body tissue parameters that have not been specified in IEEE 1528 are derived from the tissue dielectric parameters computed from the 4-Cole-Cole equations described in Reference [12] and extrapolated according to the head parameters specified in IEEE 1528.

Target Frequency (MHz)	head		body	
	$\epsilon_r$	$\sigma$ (S/m)	$\epsilon_r$	$\sigma$ (S/m)
300	45.3	0.87	58.2	0.92
450	43.5	0.87	56.7	0.94
<b>835</b>	<b>41.5</b>	<b>0.90</b>	<b>55.2</b>	<b>0.97</b>
900	41.5	0.97	55.0	1.05
915	41.5	1.01	55.0	1.06
1450	40.5	1.20	54.0	1.30
1610	40.3	1.29	53.8	1.40
<b>1800 – 2000</b>	<b>40.0</b>	<b>1.40</b>	<b>53.3</b>	<b>1.52</b>
<b>2450</b>	<b>39.2</b>	<b>1.80</b>	<b>52.7</b>	<b>1.95</b>
3000	38.5	2.40	52.0	2.73

( $\epsilon_r$  = relative permittivity,  $\sigma$  = conductivity and  $\rho = 1000$  kg/m<sup>3</sup>)

### 5.3. Tissue Calibration Result

The dielectric parameters of the liquids were verified prior to the SAR evaluation using SATIMO Dielectric Probe Kit and R&S Network Analyzer ZVL6.

Tissue Stimulant Measurement for 835MHz					
	Fr. (MHz)	Dielectric Parameters ( $\pm 5\%$ )		Tissue Temp [°C]	Test time
		$\epsilon_r$ 41.5 (39.425-43.575)	$\delta$ [s/m] 0.90(0.855-0.945)		
Head	824.2	41.88	0.87	20.9	Dec.27,2016
	826.4	41.62	0.88		
	835	41.56	0.89		
	836.6	41.31	0.91		
	846.6	41.11	0.92		
	848.8	41.02	0.93		
	Body	Fr. (MHz)	Dielectric Parameters ( $\pm 5\%$ )		
		$\epsilon_r$ 55.20(52.44-57-96)	$\delta$ [s/m]0.97(0.9215-1.0185)		
824.2		56.61	0.92	21.1	Dec.27,2016
826.4		56.03	0.92		
835		55.72	0.93		
836.6		55.12	0.95		
846.6		54.87	0.96		
848.8		54.43	0.97		

Tissue Stimulant Measurement for 1900MHz					
	Fr. (MHz)	Dielectric Parameters ( $\pm 5\%$ )		Tissue Temp [°C]	Test time
		$\epsilon_r$ 40.00(38.00-42.00)	$\delta$ [s/m]1.40(1.33-1.47)		
Head	1850.2	41.32	1.37	21.8	Dec.29,2016
	1852.4	41.16	1.37		
	1880	40.94	1.38		
	1900	40.38	1.39		
	1907.6	40.09	1.40		
	1909.8	39.88	1.40		
	Body	Fr. (MHz)	Dielectric Parameters ( $\pm 5\%$ )		
		$\epsilon_r$ 53.30(50.635-55.965)	$\delta$ [s/m]1.52(1.444-1.596)		
1850.2		54.85	1.46	21.5	Dec.29,2016
1852.4		54.49	1.47		
1880		54.12	1.48		
1900		53.74	1.49		
1907.6		53.52	1.49		
1909.8		53.33	1.50		

Tissue Stimulant Measurement for 2450MHz					
	Fr. (MHz)	Dielectric Parameters ( $\pm 5\%$ )		Tissue Temp [ $^{\circ}$ C]	Test time
		$\epsilon_r$ 39.2(37.24-41.16)	$\delta$ [s/m]1.80(1.71-1.89)		
Head	2412	40.33	1.78	21.8	Jan.05,2017
	2437	39.85	1.81		
	2450	39.03	1.82		
	2462	38.52	1.83		
	Fr. (MHz)	Dielectric Parameters ( $\pm 5\%$ )		Tissue Temp [ $^{\circ}$ C]	Test time
		$\epsilon_r$ 52.7(50.065-55.335)	$\delta$ [s/m]1.95(1.8525-2.0475)		
Body	2412	54.12	1.91	21.5	Jan.05,2017
	2437	53.63	1.94		
	2450	52.79	1.96		
	2462	51.99	1.98		

## 6. SAR SYSTEM CHECK PROCEDURE

### 6.1. SAR System Check Procedures

SAR system check is required to confirm measurement accuracy, according to the tissue dielectric media, probe calibration points and other system operating parameters required for measuring the SAR of a test device. The system verification must be performed for each frequency band and within the valid range of each probe calibration point required for testing the device. The same SAR probe(s) and tissue-equivalent media combinations used with each specific SAR system for system verification must be used for device testing. When multiple probe calibration points are required to cover substantially large transmission bands, independent system verifications are required for each probe calibration point. A system verification must be performed before each series of SAR measurements using the same probe calibration point and tissue-equivalent medium. Additional system verification should be considered according to the conditions of the tissue-equivalent medium and measured tissue dielectric parameters, typically every three to four days when the liquid parameters are remeasured or sooner when marginal liquid parameters are used at the beginning of a series of measurements.

Each SATIMO system is equipped with one or more system check kits. These units, together with the predefined measurement procedures within the SATIMO software, enable the user to conduct the system check and system validation. System kit includes a dipole, and dipole device holder.

The system check verifies that the system operates within its specifications. It's performed daily or before every SAR measurement. The system check uses normal SAR measurement in the flat section of the phantom with a matched dipole at a specified distance. The system check setup is shown as below.

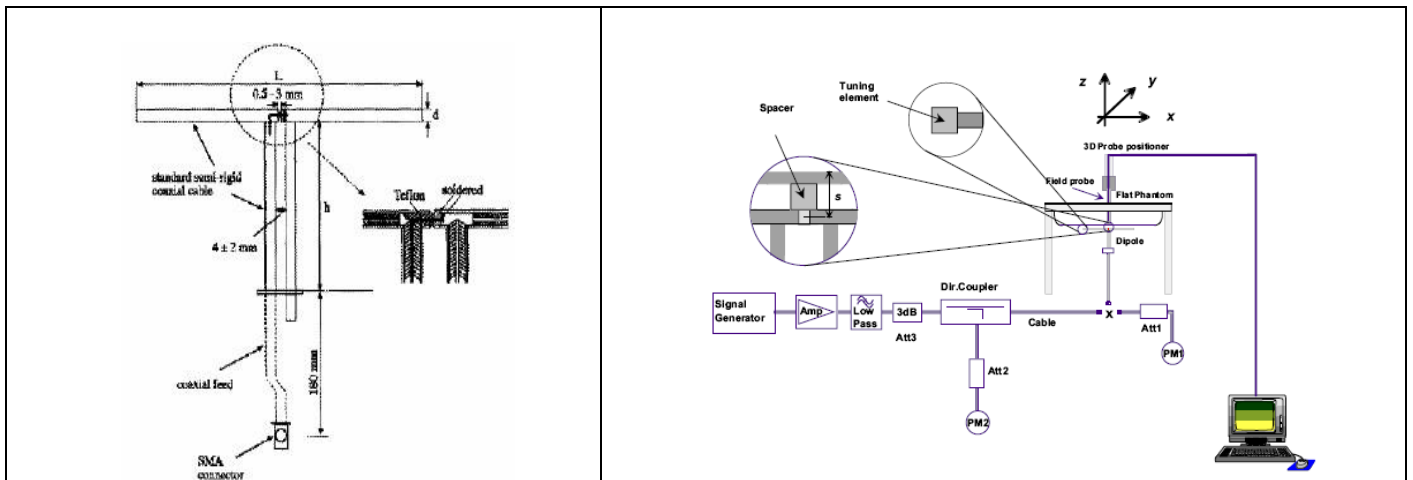

## 6.2. SAR System Check

### 6.2.1. Dipoles

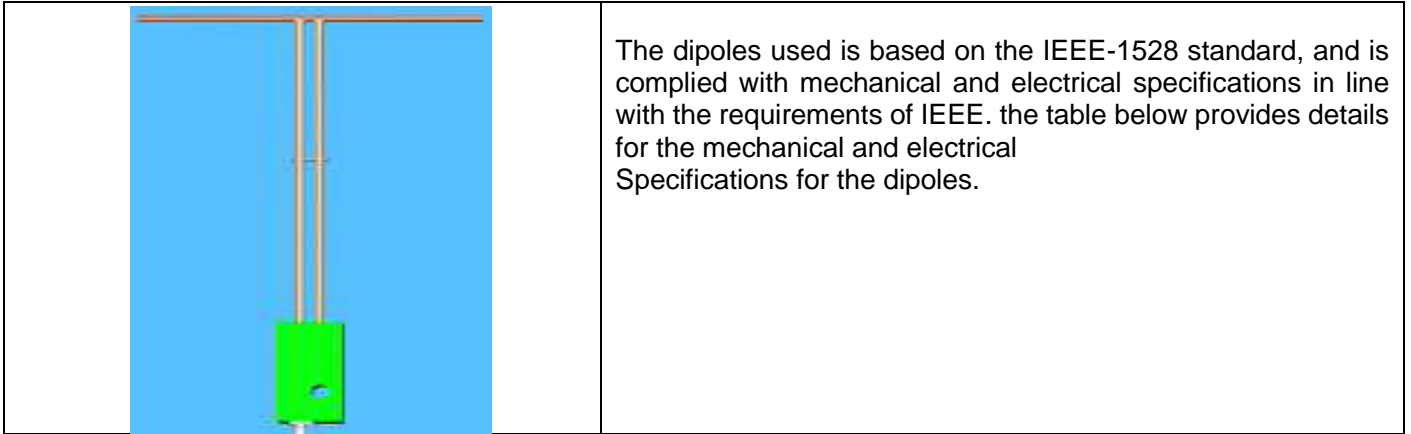

Frequency	L (mm)	h (mm)	d (mm)
835MHz	161.0	89.8	3.6
1900MHz	68	39.5	3.6
2450MHz	51.5	30.4	3.6

### 6.2.2. System Check Result

System Performance Check at 835MHz&1900MHz &2450MHz for Head									
Validation Kit: SN29/15 DIP 0G835-383&SN 29/15 DIP 1G900-389& SN 29/15DIP 2G450-393									
Frequency [MHz]	Target Value(W/Kg)		Reference Result ( $\pm 10\%$ )		Tested Value(W/Kg)		Tissue Temp. [°C]	Test time	
	1g	10g	1g	10g	1g	10g			
835	10.04	6.43	9.036-11.044	5.787 -7.073	10.371	6.744	20.9	Dec.27,2016	
1900	41.44	21.33	37.296-45.584	19.197-23.463	37.580	19.805	21.8	Dec.29,2016	
2450	54.53	24.30	49.077-59.983	21.87-26.730	49.167	23.198	21.8	Jan.05,2017	
System Performance Check at 835 MHz &1900MHz & 2450MHz for Body									
Frequency [MHz]	Target Value(W/Kg)		Reference Result ( $\pm 10\%$ )		Tested Value(W/Kg)		Tissue Temp. [°C]	Test time	
	1g	10g	1g	10g	1g	10g			
835	9.85	6.45	8.865-10.835	5.805-7.095	9.774	6.400	21.1	Dec.27,2016	
1900	39.38	20.86	35.442-43.318	18.774-22.946	42.071	19.833	21.5	Dec.29,2016	
2450	49.92	23.16	44.928-54.912	20.844-25.476	53.321	21.839	21.5	Jan.05,2017	

## 7. EUT TEST POSITION

This EUT was tested in **Right Cheek, Right Tilted, Left Cheek, Left Tilted, Body back, Body front and 4 edges.**

### 7.1. Define Two Imaginary Lines on the Handset

- (1) The vertical centerline passes through two points on the front side of the handset: the midpoint of the width  $w_t$  of the handset at the level of the acoustic output, and the midpoint of the width  $w_b$  of the handset.
- (2) The horizontal line is perpendicular to the vertical centerline and passes through the center of the acoustic output. The horizontal line is also tangential to the face of the handset at point A.
- (3) The two lines intersect at point A. Note that for many handsets, point A coincides with the center of the acoustic output; however, the acoustic output may be located elsewhere on the horizontal line. Also note that the vertical centerline is not necessarily to the front face of the handset, especially for clamshell handsets, handsets with flip covers, and other irregularly shaped handsets.

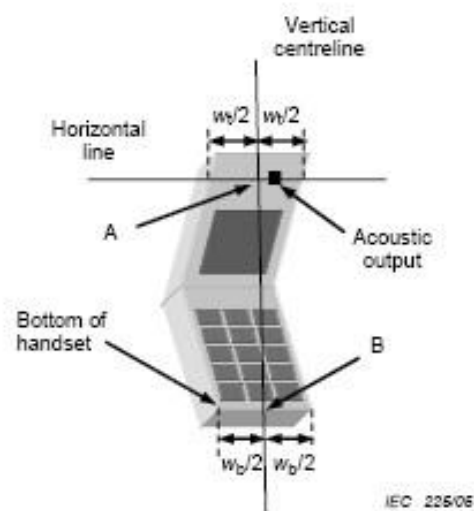
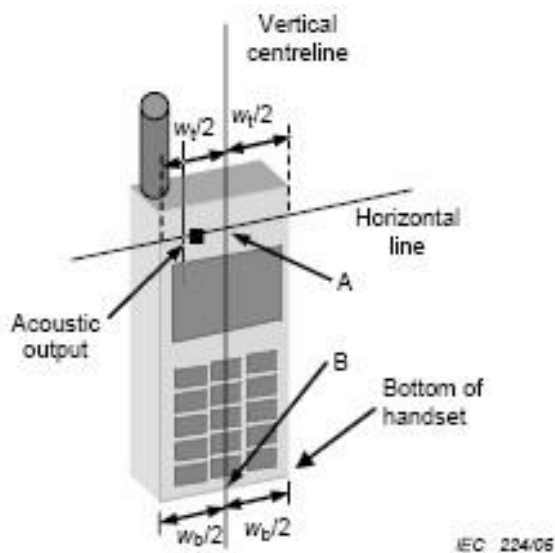

## 7.2. Cheek Position

- (1) To position the device with the vertical center line of the body of the device and the horizontal line crossing the center piece in a plane parallel to the sagittal plane of the phantom. While maintaining the device in this plane, align the vertical center line with the reference plane containing the ear and mouth reference point (M: Mouth, RE: Right Ear, and LE: Left Ear) and align the center of the ear piece with the line RE-LE.
- (2) To move the device towards the phantom with the ear piece aligned with the the line LE-RE until the phone touched the ear. While maintaining the device in the reference plane and maintaining the phone contact with ear, move the bottom of the phone until any point on the front side is in contact with the cheek of the phantom or until contact with the ear is lost



## 7.3. Tilt Position

- (1) To position the device in the "cheek" position described above.
- (2) While maintaining the device in the reference plane described above and pivoting against the ear, moves it outward away from the mouth by an angle of 15 degrees or until with the ear is lost.



#### 7.4.Body Position

- (1) To position the EUT parallel to the phantom surface.
- (2) To adjust the EUT parallel to the flat phantom.
- (3) To adjust the distance between the EUT surface and the flat phantom to **0mm**.

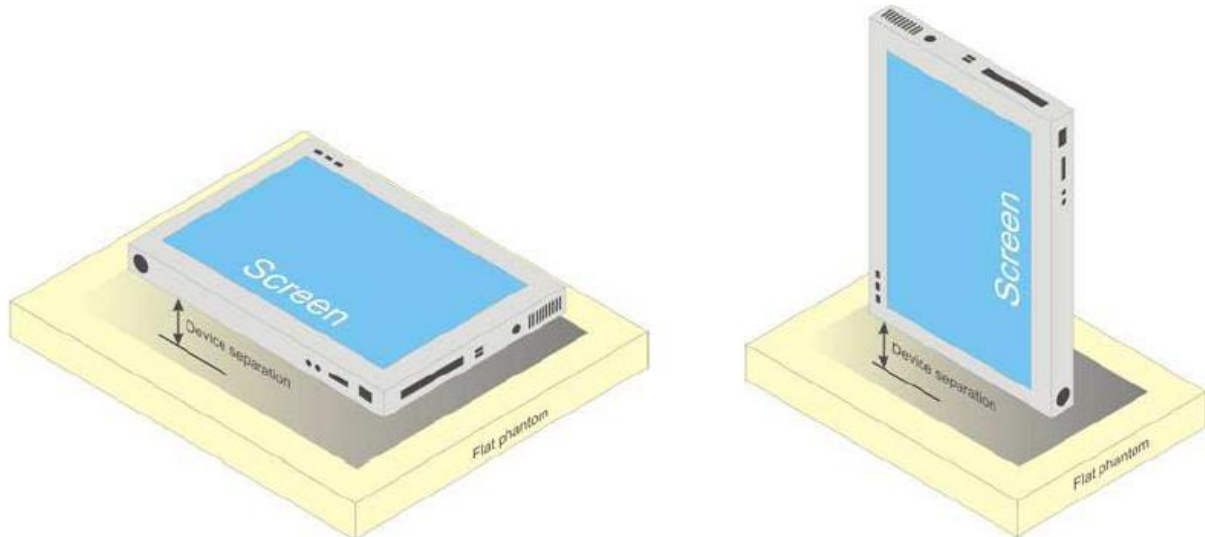



## 8. SAR EXPOSURE LIMITS

SAR assessments have been made in line with the requirements of IEEE-1528, and comply with ANSI/IEEE C95.1-2005 “Uncontrolled Environments” limits. These limits apply to a location which is deemed as “Uncontrolled Environment” which can be described as a situation where the general public may be exposed to an RF source with no prior knowledge or control over their exposure.

### Limits for General Population/Uncontrolled Exposure (W/kg)

Type Exposure	Uncontrolled Environment Limit (W/kg)
Spatial Peak SAR (1g cube tissue for brain or body)	1.60
Spatial Average SAR (Whole body)	0.08
Spatial Peak SAR (Limbs)	4.0

## 9. TEST EQUIPMENT LIST

Equipment description	Manufacturer/ Model	Identification No.	Current calibration date	Next calibration date
SAR Probe	MVG	SN 14/16 EP307	07/05/2016	07/04/2017
TISSUE Probe	SATIMO	SN 23/16 OCPG 75	07/05/2016	07/04/2017
Phantom	SATIMO	SN_4511_SAM90	Validated. No cal required.	Validated. No cal required.
Liquid	SATIMO	-	Validated. No cal required.	Validated. No cal required.
Comm Tester	Agilent-8960	GB46310822	03/11/2016	03/10/2017
Multimeter	Keithley 2000	1188656	03/10/2016	03/09/2017
Dipole	SATIMO SID835	SN29/15 DIP 0G835-383	07/05/2016	07/04/2019
Dipole	SATIMO SID1900	SN 29/15 DIP 1G900-389	07/05/2016	07/04/2019
Dipole	SATIMO SID2450	SN29/15 DIP 2G450-393	07/05/2016	07/04/2019
Signal Generator	Agilent-E4438C	US41461365	02/29/2016	02/28/2017
Vector Analyzer	Agilent / E4440A	US40420298	07/02/2016	07/01/2017
Network Analyzer	Rhode & Schwarz ZVL6	SN100132	03/01/2016	02/28/2017
Attenuator	Warison /WATT-6SR1211	N/A	N/A	N/A
Attenuator	Mini-circuits / VAT-10+	N/A	N/A	N/A
Amplifier	EM30180	SN060552	03/04/2016	03/03/2017
Directional Couple	Werlatone/ C5571-10	SN99463	07/02/2016	07/01/2017
Directional Couple	Werlatone/ C6026-10	SN99482	07/02/2016	07/01/2017
Power Sensor	NRP-Z21	1137.6000.02	10/10/2016	10/09/2017
Power Sensor	NRP-Z23	US38261498	03/01/2016	02/28/2017
Power Viewer	R&S	V2.3.1.0	N/A	N/A

Note: Per KDB 865664 Dipole SAR Validation, AGC Lab has adopted 3 years calibration intervals. On annual basis, every measurement dipole has been evaluated and is in compliance with the following criteria:

1. There is no physical damage on the dipole;
2. System validation with specific dipole is within 10% of calibrated value;
3. Return-loss is within 20% of calibrated measurement;
4. Impedance is within 5Ω of calibrated measurement.

## 10. MEASUREMENT UNCERTAINTY

<b>SATIMO Uncertainty-SN 14/16 EP307</b>									
Measurement uncertainty for DUT averaged over 1 gram / 10 gram.(Head)									
Uncertainty Component	Sec.	Tol (+- %)	Prob. Dist.	Div.	Ci (1g)	Ci (10g)	1g Ui (+-%)	10g Ui (+-%)	Vi
<b>Measurement System</b>									
Probe calibration	E.2.1	5.831	N	1	1	1	5.83	5.83	∞
Probe Modulation	E.2.5	3.0	R	$\sqrt{3}$	1	1	1.73	1.73	∞
Axial Isotropy	E.2.2	0.6	R	$\sqrt{3}$	1	1	0.36	0.35	∞
Hemispherical Isotropy	E.2.2	0.7	R	$\sqrt{3}$	1	1	0.40	0.40	∞
Boundary effect	E.2.3	1.0	R	$\sqrt{3}$	1	1	0.58	0.58	∞
Linearity	E.2.4	1.2	R	$\sqrt{3}$	1	1	0.69	0.69	∞
System detection limits	E.2.4	0.7	R	$\sqrt{3}$	1	1	0.40	0.40	∞
Readout Electronics	E.2.6	0.02	N	□ 1	1	1	0.02	0.02	∞
Response Time	E.2.7	3.0	R	$\sqrt{3}$	1	1	1.73	1.73	∞
Integration Time	E.2.8	2.0	R	$\sqrt{3}$	1	1	1.15	1.15	∞
RF Ambient Noise	E.6.1	3.0	R	$\sqrt{3}$	1	1	1.73	1.73	∞
RF Ambient Reflection	E.6.1	3.0	R	$\sqrt{3}$	1	1	1.73	1.73	∞
Probe Positioner	E.6.2	2.0	R	$\sqrt{3}$	1	1	1.15	1.15	∞
Probe Positioning	E.6.3	0.05	R	$\sqrt{3}$	1	1	0.03	0.03	∞
Post-processing	E.5	5.0	R	$\sqrt{3}$	1	1	2.89	2.89	∞
<b>Test sample Related</b>									
Device Positioning	E.4.2	3.6	N	1	1	1	3.60	3.60	∞
Device Holder	E.4.1	2.9	N	1	1	1	2.90	2.90	∞
Measurement SAR Drift	E.2.9	5	R	$\sqrt{3}$	1	1	2.89	2.89	∞
Power Scaling	E.6.5	0	R	$\sqrt{3}$	1	1	0.00	0.00	∞
<b>Phantom and set-up</b>									
Phantom Uncertainty	E.3.1	0.05	R	$\sqrt{3}$	1	1	0.03	0.03	∞
Uncertainty in SAR correction for deviations in permittivity and conductivity	E.3.2	1.9	N	1	1	0.84	1.90	1.60	∞
Liquid Conductivity(Meas.)	E.3.3	5	N	1	0.78	0.71	3.90	3.55	M
Liquid Permittivity(Meas.)	E.3.3	5	N	1	0.23	0.26	1.15	1.30	M
Liquid Conductivity-temperature uncertainty	E.3.4	5	R	$\sqrt{3}$	0.78	0.71	2.25	2.05	∞
Liquid Permittivity-temperature uncertainty	E.3.4	5	R	$\sqrt{3}$	0.23	0.26	0.66	0.75	∞
Combined Standard Uncertainty			RSS				10.20	9.919	∞
Expanded Uncertainty (95% Confidence interval)			k				20.40	19.838	

<b>SATIMO Uncertainty-SN 14/16 EP307</b>									
System validation uncertainty for Dipole averaged over 1 gram / 10 gram. ( Head)									
Uncertainty Component	Sec.	Tol (+-%)	Prob. Dist.	Div.	Ci (1g)	Ci (10g)	1g Ui (+-%)	10g Ui (+-%)	Vi
<b>Measurement System</b>									
Probe calibration	E.2.1	5.831	N	1	1	1	5.83	5.83	∞
Probe Modulation	E.2.5	3.0	R	$\sqrt{3}$	1	1	1.73	1.73	∞
Axial Isotropy	E.2.2	0.6	R	$\sqrt{3}$	1	1	1.44	1.44	∞
Hemispherical Isotropy	E.2.2	0.7	R	$\sqrt{3}$	1	1	0.40	0.40	∞
Boundary effect	E.2.3	1.0	R	$\sqrt{3}$	1	1	0.58	0.58	∞
Linearity	E.2.4	1.2	R	$\sqrt{3}$	1	1	0.69	0.69	∞
System detection limits	E.2.4	0.7	R	$\sqrt{3}$	1	1	0.40	0.40	∞
Readout Electronics	E.2.6	0.02	N	1	1	1	0.02	0.02	∞
Response Time	E.2.7	3.0	R	$\sqrt{3}$	1	1	1.73	1.73	∞
Integration Time	E.2.8	2.0	R	$\sqrt{3}$	1	1	1.15	1.15	∞
RF Ambient Noise	E.6.1	3.0	R	$\sqrt{3}$	1	1	1.73	1.73	∞
RF Ambient Reflection	E.6.1	3.0	R	$\sqrt{3}$	1	1	1.73	1.73	∞
Probe Positioner	E.6.1	2.0	R	$\sqrt{3}$	1	1	1.15	1.15	∞
Probe Positioning	E.6.2	0.05	R	$\sqrt{3}$	1	1	0.03	0.03	∞
Post-processing	E.6.3	5.0	R	$\sqrt{3}$	1	1	2.89	2.89	∞
<b>System validation source (dipole)</b>									
Deviation of exp. dipole	E6.4	5	R	1	1	1	5.00	5.00	∞
Dipole Axis to Liquid Dist.	8,E.6.6	4.7	R	$\sqrt{3}$	1	1	2.71	2.71	∞
Input power & SAR drift	8,6.6.4	1	R	$\sqrt{3}$	1	1	0.58	0.58	∞
<b>Phantom and set-up</b>									
Phantom Uncertainty	E.3.1	0.05	R	$\sqrt{3}$	1	1	0.03	0.03	∞
Uncertainty in SAR correction for deviations in permittivity and conductivity	E.3.2	1.9	N	1	1	0.84	1.90	1.60	∞
Liquid Conductivity(Meas.)	E.3.3	5	N	1	0.78	0.71	3.90	3.55	M
Liquid Permittivity(Meas.)	E.3.3	5	N	1	0.23	0.26	1.15	1.30	M
Liquid Conductivity-temperature uncertainty	E.3.4	5	R	$\sqrt{3}$	0.78	0.71	2.25	2.05	∞
Liquid Permittivity-temperature uncertainty	E.3.4	5	R	$\sqrt{3}$	0.23	0.26	0.66	0.75	∞
Combined Standard Uncertainty			RSS				10.34	10.069	∞
Expanded Uncertainty (95% Confidence interval)			k				20.69	20.137	

<b>SATIMO Uncertainty-SN 14/16 EP307</b>									
System Check uncertainty for Dipole averaged over 1 gram / 10 gram.( Head)									
Uncertainty Component	Sec.	Tol (+- %)	Prob. Dist.	Div.	Ci (1g)	Ci (10g)	1g Ui (+-%)	10g Ui (+-%)	Vi
<b>Measurement System</b>									
Modulation response	E.2.5	3.0	R	$\sqrt{3}$	0	0	0.00	0.00	$\infty$
Boundary effect	E.2.3	1.0	R	$\sqrt{3}$	0	0	0.00	0.00	$\infty$
System detection limits	E.2.4	0.7	R	$\sqrt{3}$	0	0	0.00	0.00	$\infty$
Readout Electronics	E.2.6	0.02	N	1	0	0	0.00	0.00	$\infty$
Response Time	E.2.7	3.0	R	$\sqrt{3}$	0	0	0.00	0.00	$\infty$
Integration Time	E.2.8	2.0	R	$\sqrt{3}$	0	0	0.00	0.00	$\infty$
RF Ambient Noise	E.6.1	3.0	R	$\sqrt{3}$	0	0	0.00	0.00	$\infty$
RF Ambient Reflection	E.6.1	3.0	R	$\sqrt{3}$	0	0	0.00	0.00	$\infty$
Probe Positioner	E.6.1	2.0	R	$\sqrt{3}$	1	1	1.15	1.15	$\infty$
Probe Positioning	E.6.2	0.05	R	$\sqrt{3}$	1	1	0.03	0.03	$\infty$
Post-processing	E.6.3	5.0	R	$\sqrt{3}$	0	0	0.00	0.00	$\infty$
<b>Field source</b>									
Deviation of exp. dipole	E6.4	5	R	1	1	1	5.00	5.00	$\infty$
Dipole Axis to Liquid Dist.	8,E.6.6	4.7	R	$\sqrt{3}$	1	1	2.71	2.71	$\infty$
Input power & SAR drift	8,6.6.4	1	R	$\sqrt{3}$	1	1	0.58	0.58	$\infty$
<b>Phantom and set-up</b>									
Phantom Uncertainty	E.3.1	0.05	R	$\sqrt{3}$	1	1	0.03	0.03	$\infty$
Uncertainty in SAR correction for deviations in permittivity and conductivity	E.3.2	1.9	N	1	1	0.84	1.90	1.60	$\infty$
Liquid Conductivity(Meas.)	E.3.3	5	N	1	0.78	0.71	3.90	3.55	M
Liquid Permittivity(Meas.)	E.3.3	5	N	1	0.23	0.26	1.15	1.30	M
Liquid Conductivity-temperature uncertainty	E.3.4	5	R	$\sqrt{3}$	0.78	0.71	2.25	2.05	$\infty$
Liquid Permittivity-temperature uncertainty	E.3.4	5	R	$\sqrt{3}$	0.23	0.26	0.66	0.75	$\infty$
Combined Standard Uncertainty			RSS				7.076	6.667	$\infty$
Expanded Uncertainty (95% Confidence interval)			k				14.152	13.334	

## 11. CONDUCTED POWER MEASUREMENT

### GSM BAND

Mode	Frequency(MHz)	Avg. Burst Power(dBm)	Duty cycle Factor(dBm)	Frame Power(dBm)
Maximum Power <1>				
GSM 850	824.2	<b>31.73</b>	-9	22.73
	836.6	31.22	-9	22.22
	848.8	31.67	-9	22.67
GPRS 850 (1 Slot)	824.2	31.12	-9	22.12
	836.6	31.17	-9	22.17
	848.8	31.24	-9	22.24
GPRS 850 (2 Slot)	824.2	28.71	-6	22.71
	836.6	28.45	-6	22.45
	848.8	28.15	-6	22.15
GPRS 850 (3 Slot)	824.2	26.96	-4.26	22.7
	836.6	26.42	-4.26	22.16
	848.8	27.19	-4.26	<b>22.93</b>
GPRS 850 (4 Slot)	824.2	25.86	-3	22.86
	836.6	25.73	-3	22.73
	848.8	25.85	-3	22.85
Maximum Power <2>				
GSM 850	824.2	30.85	-9	21.85
	836.6	30.56	-9	21.56
	848.8	30.67	-9	21.67
GPRS 850 (1 Slot)	824.2	30.55	-9	21.55
	836.6	30.51	-9	21.51
	848.8	30.49	-9	21.49
GPRS 850 (2 Slot)	824.2	28.22	-6	22.22
	836.6	28.13	-6	22.13
	848.8	28.03	-6	22.03
GPRS 850 (3 Slot)	824.2	26.53	-4.26	22.27
	836.6	26.41	-4.26	22.15
	848.8	27.03	-4.26	22.77
GPRS 850 (4 Slot)	824.2	25.43	-3	22.43
	836.6	25.32	-3	22.32
	848.8	25.32	-3	22.32

**GSM BAND CONTINUE**

Mode	Frequency(MHz)	Avg. Burst Power(dBm)	Duty cycle Factor(dBm)	Frame Power(dBm)
Maximum Power <1>				
PCS1900	1850.2	28.63	-9	19.63
	1880	<b>28.81</b>	-9	19.81
	1909.8	28.79	-9	19.79
GPRS1900 (1 Slot)	1850.2	28.29	-9	19.29
	1880	28.26	-9	19.26
	1909.8	28.44	-9	19.44
GPRS1900 (2 Slot)	1850.2	25.46	-6	19.46
	1880	25.53	-6	19.53
	1909.8	25.32	-6	19.32
GPRS1900 (3 Slot)	1850.2	23.77	-4.26	19.51
	1880	23.72	-4.26	19.46
	1909.8	23.42	-4.26	19.16
GPRS1900 (4 Slot)	1850.2	22.87	-3	<b>19.87</b>
	1880	22.52	-3	19.52
	1909.8	22.66	-3	19.66
Maximum Power <2>				
PCS1900	1850.2	27.26	-9	18.26
	1880	27.31	-9	18.31
	1909.8	27.13	-9	18.13
GPRS1900 (1 Slot)	1850.2	27.22	-9	18.22
	1880	27.18	-9	18.18
	1909.8	27.06	-9	18.06
GPRS1900 (2 Slot)	1850.2	25.03	-6	19.03
	1880	25.11	-6	19.11
	1909.8	25.13	-6	19.13
GPRS1900 (3 Slot)	1850.2	23.34	-4.26	19.08
	1880	23.16	-4.26	18.90
	1909.8	23.11	-4.26	18.85
GPRS1900 (4 Slot)	1850.2	22.53	-3	<b>19.53</b>
	1880	22.49	-3	19.49
	1909.8	22.5	-3	19.50

Note 1:

The Frame Power (Source-based time-averaged Power) is scaled the maximum burst average power based on time slots. The calculated methods are show as following:

Frame Power = Max burst power (1 Up Slot) – 9 dB

Frame Power = Max burst power (2 Up Slot) – 6 dB

Frame Power = Max burst power (3 Up Slot) – 4.26 dB

Frame Power = Max burst power (4 Up Slot) – 3 dB

Note 2:

SAR is not required for GPRS (1 Slot) Mode because its output power is less than of Voice Mode

**UMTS BAND**

**HSDPA Setup Configuration:**

- The EUT was connected to Base Station Agilent E5515C referred to the Setup Configuration.
- The RF path losses were compensated into the measurements.
- A call was established between EUT and Based Station with following setting:
  - (1) Set Gain Factors( $\beta_c$  and  $\beta_d$ ) parameters set according to each
  - (2) Set RMC 12.2Kbps+HSDPA mode.
  - (3) Set Cell Power=-86dBm
  - (4) Set HS-DSCH Configuration Type to FRC (H-set 1, QPSK)
  - (5) Select HSDPA Uplink Parameters
  - (6) Set Delta ACK, Delta NACK and Delta CQI=8
  - (7) Set Ack - Nack Repetition Factor to 3
  - (8) Set CQI Feedback Cycle (k) to 4ms
  - (9) Set CQI Repetition Factor to 2
  - (10) Power Ctrl Mode=All Up bits
- The transmitted maximum output power was recorded.

Table C.10.2.4:  $\beta$  values for transmitter characteristics tests with HS-DPCCH

Sub-test	$\beta_c$ (Note5)	$\beta_d$	$\beta_d$ (SF)	$\beta_c/\beta_d$	$\beta_{HS}$ (Note1, Note 2)	CM (dB) (Note 3)	MPR (dB) (Note 3)
1	2/15	15/15	64	2/15	4/15	0.0	0.0
2	12/15(Note 4)	15/15(Note 4)	64	12/15(Note 4)	24/15	1.0	0.0
3	15/15	8/15	64	15/8	30/15	1.5	0.5
4	15/15	4/15	64	15/4	30/15	1.5	0.5

Note 1:  $\Delta ACK, \Delta NACK$  and  $\Delta CQI = 30/15$  with  $\beta_{hs} = 30/15 * \beta_c$ .

Note 2: For the HS-DPCCH power mask requirement test in clause 5.2C, 5.7A, and the Error Vector Magnitude (EVM) with HS-DPCCH test in clause 5.13.1A, and HSDPA EVM with phase discontinuity in clause 5.13.1AA,  $\Delta ACK$  and  $\Delta NACK = 30/15$  with  $\beta_{hs} = 30/15 * \beta_c$ , and  $\Delta CQI = 24/15$  with  $\beta_{hs} = 24/15 * \beta_c$ .

Note 3: CM = 1 for  $\beta_c/\beta_d = 12/15$ ,  $\square_{hs}/\square_c = 24/15$ . For all other combinations of DPDCH, DPCCH and HS-DPCCH the MPR is based on the relative CM difference. This is applicable for only UEs that support HSDPA in release 6 and later releases.

Note 4: For substest 2 the  $\square_c/\square_d$  ratio of 12/15 for the TFC during the measurement period (TF1, TF0) is achieved by setting the signalled gain factors for the reference TFC (TF1, TF1) to  $\square_c = 11/15$  and  $\square_d = 15/15$ .



**HSUPA Setup Configuration:**

- The EUT was connected to Base Station Agilent E5515C referred to the Setup Configuration.
- The RF path losses were compensated into the measurements.
- A call was established between EUT and Base Station with following setting \* :
  - (1) Call Configs = 5.2B, 5.9B, 5.10B, and 5.13.2B with QPSK
  - (2) Set the Gain Factors ( $\beta_c$  and  $\beta_d$ ) and parameters (AG Index) were set according to each specific sub-test in the following table, C11.1.3, quoted from the TS 34.121
  - (3) Set Cell Power = -86 dBm
  - (4) Set Channel Type = 12.2k + HSPA
  - (5) Set UE Target Power
  - (6) Power Ctrl Mode= Alternating bits
  - (7) Set and observe the E-TFCI
  - (8) Confirm that E-TFCI is equal to the target E-TFCI of 75 for sub-test 1, and other subtest's E-TFCI
- The transmitted maximum output power was recorded.

Table C.11.1.3:  $\beta$  values for transmitter characteristics tests with HS-DPCCH and E-DCH

Sub-test	$\beta_c$	$\beta_d$	$\beta_d$ (SF)	$\beta_c/\beta_d$	$\beta_{HS}$ (Note 1)	$\beta_{ec}$	$\beta_{ed}$ (Note 4) (Note 5)	$\beta_{ed}$ (SF)	$\beta_{ed}$ (Code s)	CM (dB) (Note 2)	MPR (dB) (Note 2) (Note 6)	AG Index (Note 5)	E-TF CI
1	11/15 (Note 3)	15/15 (Note 3)	64	11/15 (Note 3)	22/15	209/225	1309/225	4	1	1.0	0.0	20	75
2	6/15	15/15	64	6/15	12/15	12/15	94/75	4	1	3.0	2.0	12	67
3	15/15	9/15	64	15/9	30/15	30/15	$\beta_{ed1}$ : 47/15 $\beta_{ed2}$ : 47/15	4 4	2	2.0	1.0	15	92
4	2/15	15/15	64	2/15	4/15	2/15	56/75	4	1	3.0	2.0	17	71
5	15/15	0	-	-	5/15	5/15	47/15	4	1	1.0	0.0	12	67

Note 1: For sub-test 1 to 4,  $\Delta ACK$ ,  $\Delta NACK$  and  $\Delta CQI = 30/15$  with  $\beta_{hs} = 30/15 * \beta_c$ . For sub-test 5,  $\Delta ACK$ ,  $\Delta NACK$  and  $\Delta CQI = 5/15$  with  $\beta_{hs} = 5/15 * \beta_c$ .

Note 2: CM = 1 for  $\beta_c/\beta_d = 12/15$ ,  $\square_{hs}/\square_c = 24/15$ . For all other combinations of DPDCH, DPCCH, HS DPCCH, E-DPDCH and E-DPCCH the MPR is based on the relative CM difference.

Note 3: For subtest 1 the  $\square_c/\square_d$  ratio of 11/15 for the TFC during the measurement period (TF1, TF0) is achieved by setting the signalled gain factors for the reference TFC (TF1, TF1) to  $\square_c = 10/15$  and  $\square_d = 15/15$ .

Note 4: In case of testing by UE using E-DPDCH Physical Layer category 1, Sub-test 3 is omitted according to TS25.306 Table 5.1g.

Note 5:  $\beta_{ed}$  cannot be set directly; it is set by Absolute Grant Value.

Note 6: For subtests 2, 3 and 4, UE may perform E-DPDCH power scaling at max power which could results in slightly smaller MPR values.

**UMTS BAND II**

<b>Mode</b>	<b>Frequency (MHz)</b>	<b>Avg. Burst Power (dBm)</b>
WCDMA 1900 RMC	1852.4	<b>21.76</b>
	1880	21.54
	1907.6	21.63
WCDMA 1900 AMR	1852.4	21.31
	1880	21.07
	1907.6	21.12
HSDPA Subtest 1	1852.4	20.31
	1880	20.05
	1907.6	20.22
HSDPA Subtest 2	1852.4	20.32
	1880	20.13
	1907.6	20.28
HSDPA Subtest 3	1852.4	20.07
	1880	19.94
	1907.6	20.55
HSDPA Subtest 4	1852.4	20.33
	1880	20.34
	1907.6	20.06
HSUPA Subtest 1	1852.4	20.26
	1880	20.14
	1907.6	20.18
HSUPA Subtest 2	1852.4	20.10
	1880	20.03
	1907.6	20.12
HSUPA Subtest 3	1852.4	20.40
	1880	20.23
	1907.6	20.12
HSUPA Subtest 4	1852.4	20.18
	1880	20.38
	1907.6	20.34
HSUPA Subtest 5	1852.4	20.08
	1880	20.09
	1907.6	20.38

**UMTS BAND V**

<b>Mode</b>	<b>Frequency (MHz)</b>	<b>Avg. Burst Power (dBm)</b>
WCDMA 850 RMC	826.4	21.34
	836.6	21.43
	846.6	<b>21.59</b>
WCDMA 850 AMR	826.4	21.55
	836.6	21.08
	846.6	21.29
HSDPA Subtest 1	826.4	20.52
	836.6	20.06
	846.6	20.02
HSDPA Subtest 2	826.4	20.24
	836.6	20.53
	846.6	20.43
HSDPA Subtest 3	826.4	20.02
	836.6	20.03
	846.6	20.47
HSDPA Subtest 4	826.4	20.54
	836.6	20.39
	846.6	20.12
HSUPA Subtest 1	826.4	20.51
	836.6	20.55
	846.6	20.24
HSUPA Subtest 2	826.4	20.34
	836.6	20.19
	846.6	20.5
HSUPA Subtest 3	826.4	20.75
	836.6	20.46
	846.6	20.11
HSUPA Subtest 4	826.4	20.04
	836.6	20.4
	846.6	20.21
HSUPA Subtest 5	826.4	20.31
	836.6	20.11
	846.6	20.31

According to 3GPP 25.101 sub-clause 6.2.2 , the maximum output power is allowed to be reduced by following the table.

Table 6.1aA: UE maximum output power with HS-DPCCH and E-DCH

UE Transmit Channel Configuration	CM(db)	MPR(db)
For all combinations of ,DPDCH,DPCCH HS-DPDCH,E-DPDCH and E-DPCCH	$0 \leq CM \leq 3.5$	$MAX(CM-1,0)$
Note: CM=1 for $\beta_d/\beta_{d'}=12/15$ , $\beta_{hs}/\beta_c=24/15$ .For all other combinations of DPDCH, DPCCH, HS-DPCCH, E-DPDCH and E-DPCCH the MPR is based on the relative CM difference.		

The device supports MPR to solve linearity issues (ACLR or SEM) due to the higher peak-to average ratios (PAR) of the HSUPA signal. This prevents saturating the full range of the TX DAC inside of device and provides a reduced power output to the RF transceiver chip according to the Cubic Metric (a function of the combinations of DPDCH, DPCCH, HS-DPCCH, E-DPDCH and E-DPCCH).

When E-DPDCH channels are present the beta gains on those channels are reduced firsts to try to get the power under the allowed limit. If the beta gains are lowered as far as possible, then a hard limiting is applied at the maximum allowed level.

The SW currently recalculates the cubic metric every time the beta gains on the E-DPDCH are reduced. The cubic metric will likely get lower each time this is done .However, there is no reported reduction of maximum output power in the HSUPA mode since the device also provides a compensation for the power back-off by increasing the gain of TX\_AGC in the transceiver (PA) device.

The end effect is that the DUT output power is identical to the case where there is no MPR in the device.

**WIFI**

Mode	Data Rate (Mbps)	Channel	Frequency(MHz)	Avg. Burst Power(dBm)
802.11b	1	01	2412	<b>13.38</b>
		06	2437	13.27
		11	2462	13.11
802.11g	6	01	2412	<b>10.97</b>
		06	2437	10.81
		11	2462	10.67
802.11n(20)	6.5	01	2412	<b>10.89</b>
		06	2437	10.75
		11	2462	10.34
802.11n(40)	13.5	03	2422	9.67
		06	2437	9.54
		09	2452	<b>9.76</b>

**Bluetooth\_V3.0**

Modulation	Channel	Frequency(MHz)	Peak.Power (dBm)
GFSK	0	2402	2.455
	39	2441	<b>2.883</b>
	78	2480	2.743
$\pi$ /4-DQPSK	0	2402	2.225
	39	2441	2.308
	78	2480	2.043
8-DPSK	0	2402	2.506
	39	2441	2.699
	78	2480	2.520

**Bluetooth\_V4.0**

Modulation	Channel	Frequency(MHz)	Peak Power (dBm)
GFSK	0	2402	-4.000
	19	2440	-4.465
	39	2480	-4.983

## 12. TEST RESULTS

### 12.1. SAR Test Results Summary

#### 12.1.1. Test position and configuration

Head SAR was performed with the device configured in the positions according to IEEE 1528-2013, Body-worn SAR was performed with the device 0mm from the phantom, and 4 Edges SAR was performed with the device 0mm from the phantom.

#### 12.1.2. Operation Mode

1. Per KDB 447498 D01 v06 ,for each exposure position, if the highest 1-g SAR is  $\leq 0.8$  W/kg, testing for low and high channel is optional.
2. Per KDB 865664 D01 v01r04,for each frequency band, if the measured SAR is  $\geq 0.8$ W/Kg, testing for repeated SAR measurement is required , that the highest measured SAR is only to be tested. When the SAR results are near the limit, the following procedures are required for each device to verify these types of SAR measurement related variation concerns by repeating the highest measured SAR configuration in each frequency band.
  - (1) When the original highest measured SAR is  $\geq 0.8$ W/Kg, repeat that measurement once.
  - (2) Perform a second repeated measurement only if the ratio of largest to smallest SAR for the original and first repeated measurements is  $>1.20$  or when the original or repeated measurement is  $\geq 1.45$  W/Kg.
  - (3) Perform a third repeated measurement only if the original, first and second repeated measurement is  $\geq 1.5$  W/Kg and ratio of largest to smallest SAR for the original, first and second measurement is  $\geq 1.20$ .
3. Body-worn exposure conditions are intended to voice call operations, therefore GSM voice call mode is selected to be test.
4. Per KDB 648474 D04 v01r03,when the reported SAR for a body-worn accessory measured without a headset connected to the handset is  $\leq 1.2$ W/Kg, SAR testing with a headset connected is not required.
5. Per KDB 248227 D01v02r02,for 2.4GHz 802.11g/n SAR testing is not required when the highest reported SAR for DSSS is adjusted by the ratio of OFDM to DSSS specified maximum output power and the adjusted SAR is  $\leq 1.2$ W/kg.
6. Per KDB 941225 D06 V02r01, When the same wireless mode transmission configurations for voice and data are required for SAR measurements, the more conservative configuration with a smaller separation distance should be tested for the overlapping SAR configurations.
7. Maximum Scaling SAR in order to calculate the Maximum SAR values to test under the standard Peak Power, Calculation method is as follows:  
Maximum Scaling SAR =tested SAR (Max.)  $\times$  [maximum turn-up power (mw)/ maximum measurement output power(mw) ]
8. Proximity sensor, just for avoiding the wrong operation in the phone screen when call, and has no influence on output power or SAR resu

### 12.1.3. Test Result

SAR MEASUREMENT									
Depth of Liquid (cm):>15					Relative Humidity (%): 51.9				
Product: Tablet									
Test Mode: GSM850 with GMSK modulation									
Position	Mode	Ch.	Fr. (MHz)	Power Drift (<±5%)	SAR (1g) (W/kg)	Max. Tune-up Power (dBm)	Meas. output Power (dBm)	Scaled SAR (W/Kg)	Limit (W/kg)
<b>SIM 1 Card</b>									
Left Cheek	voice	190	836.6	-0.36	<b>0.084</b>	31.5	31.22	<b>0.090</b>	1.6
Left Tilt	voice	190	836.6	0.85	0.056	31.5	31.22	0.060	1.6
Right Cheek	voice	190	836.6	1.03	0.080	31.5	31.22	0.085	1.6
Right Tilt	voice	190	836.6	-0.06	0.062	31.5	31.22	0.066	1.6
Body back	voice	190	836.6	0.95	<b>0.579</b>	31.5	31.22	<b>0.618</b>	1.6
Body front	voice	190	836.6	0.33	0.426	31.5	31.22	0.454	1.6
<b>SIM 2 Card</b>									
Left Cheek	GPRS-3 slot	190	836.6	-1.05	0.121	26.5	26.42	0.123	1.6
Left Tilt	GPRS-3 slot	190	836.6	-0.50	0.113	26.5	26.42	0.115	1.6
Right Cheek	GPRS-3 slot	190	836.6	-0.86	<b>0.128</b>	26.5	26.42	<b>0.130</b>	1.6
Right Tilt	GPRS-3 slot	190	836.6	1.55	0.093	26.5	26.42	0.095	1.6
Body back	GPRS-3 slot	190	836.6	0.96	<b>0.767</b>	26.5	26.42	<b>0.781</b>	1.6
Body front	GPRS-3 slot	190	836.6	-0.44	0.572	26.5	26.42	0.583	1.6
Edge 2(Right)	GPRS-3 slot	190	836.6	-0.71	0.230	26.5	26.42	0.234	1.6
Edge 3(Bottom)	GPRS-3 slot	190	836.6	1.03	0.330	26.5	26.42	0.336	1.6
<b>SIM 2 Card</b>									
Body back	GPRS-3 slot	190	836.6	0.65	0.734	26.5	26.41	0.749	1.6

Note:

- When the 1-g Reported SAR is  $\leq 0.8$  W/kg, testing for low and high channel is optional. Refer to KDB 447498.
- The test separation for body back and body front is 0mm of all above table.
- The test separation for 4 Edges is 0mm of all above table.

SAR MEASUREMENT									
Depth of Liquid (cm):>15					Relative Humidity (%): 52.6				
Product: Tablet									
Test Mode: PCS1900 with GMSK modulation									
Position	Mode	Ch.	Fr. (MHz)	Power Drift (<±5%)	SAR (1g) (W/kg)	Max. Tune-up Power (dBm)	Meas. output Power (dBm)	Scaled SAR (W/Kg)	Limit (W/kg)
<b>SIM 1 Card</b>									
Left Cheek	voice	661	1880.0	-0.85	0.049	29.00	28.81	0.051	1.6
Left Tilt	voice	661	1880.0	0.33	0.053	29.00	28.81	0.055	1.6
Right Cheek	voice	661	1880.0	1.06	<b>0.067</b>	29.00	28.81	<b>0.070</b>	1.6
Right Tilt	voice	661	1880.0	-0.45	0.035	29.00	28.81	0.037	1.6
Body back	voice	661	1880.0	1.08	<b>0.378</b>	29.00	28.81	<b>0.395</b>	1.6
Body front	voice	661	1880.0	0.33	0.237	29.00	28.81	0.248	1.6
<b>SIM 2 Card</b>									
Left Cheek	GPRS-4 slot	661	1880.0	-0.04	0.077	23.00	22.52	0.086	1.6
Left Tilt	GPRS-4 slot	661	1880.0	0.06	0.087	23.00	22.52	0.097	1.6
Right Cheek	GPRS-4 slot	661	1880.0	0.62	<b>0.146</b>	23.00	22.52	<b>0.163</b>	1.6
Right Tilt	GPRS-4 slot	661	1880.0	-0.33	0.057	23.00	22.52	0.064	1.6
Body back	GPRS-4 slot	512	1850.2	-0.96	0.768	23.00	22.87	0.791	1.6
Body back	GPRS-4 slot	661	1880.0	-0.34	<b>0.815</b>	23.00	22.52	<b>0.910</b>	1.6
Body back	GPRS-4 slot	810	1909.8	0.52	0.757	23.00	22.66	0.819	1.6
Body front	GPRS-4 slot	661	1880.0	0.33	0.594	23.00	22.52	0.663	1.6
Edge 2(Right)	GPRS-4 slot	661	1880.0	0.95	0.309	23.00	22.52	0.345	1.6
Edge 3(Bottom)	GPRS-4 slot	661	1880.0	-0.64	0.617	23.00	22.52	0.689	1.6
<b>SIM 2 Card</b>									
Body back	GPRS-4 slot	661	1880.0	0.85	0.797	23.00	22.49	0.896	1.6

Note:

- When the 1-g Reported SAR is  $\leq 0.8$  W/kg, testing for low and high channel is optional. Refer to KDB 447498.
- The test separation for body back and body front is 0mm of all above table.
- The test separation for 4 Edges is 0mm of all above table.



SAR MEASUREMENT									
Depth of Liquid (cm):>15					Relative Humidity (%):51.9				
Product: Tablet									
Test Mode: WCDMA Band V with QPSK modulation									
Position	Mode	Ch.	Fr. (MHz)	Power Drift (<math>\pm 5\%</math>)	SAR (1g) (W/kg)	Max. Tune-up Power (dBm)	Meas. output Power (dBm)	Scaled SAR (W/Kg)	Limit (W/kg)
Left Cheek	RMC 12.2kbps	4183	836.6	-0.86	0.043	21.6	21.43	0.045	1.6
Left Tilt	RMC 12.2kbps	4183	836.6	0.33	0.020	21.6	21.43	0.021	1.6
Right Cheek	RMC 12.2kbps	4183	836.6	-0.64	<b>0.084</b>	21.6	21.43	<b>0.087</b>	1.6
Right Tilt	RMC 12.2kbps	4183	836.6	-0.96	0.057	21.6	21.43	0.059	1.6
Body back	RMC 12.2kbps	4132	826.4	0.72	0.851	21.6	21.34	0.904	1.6
Body back	RMC 12.2kbps	4183	836.6	0.96	<b>1.025</b>	21.6	21.43	<b>1.066</b>	1.6
Body back	RMC 12.2kbps	4233	846.6	-0.44	0.843	21.6	21.59	0.845	1.6
Body front	RMC 12.2kbps	4183	836.6	-0.85	0.522	21.6	21.43	0.543	1.6
Edge 2(Right)	RMC 12.2kbps	4183	836.6	-1.05	0.124	21.6	21.43	0.129	1.6
Edge 3(Bottom)	RMC 12.2kbps	4183	836.6	0.69	0.106	21.6	21.43	0.110	1.6

Note:

- When the 1-g Reported SAR is  $\leq 0.8$  W/kg, testing for low and high channel is optional. Refer to KDB 447498.
- The test separation for body back and body front is 0mm of all above table.
- The test separation for 4 Edges is 0mm of all above table.

SAR MEASUREMENT									
Depth of Liquid (cm):>15					Relative Humidity (%):52.6				
Product: Tablet									
Test Mode: WCDMA Band II with QPSK modulation									
Position	Mode	Ch.	Fr. (MHz)	Power Drift (<±5%)	SAR (1g) (W/kg)	Max. Tune-up Power (dBm)	Meas. output Power (dBm)	Scaled SAR (W/Kg)	Limit (W/kg)
Left Cheek	RMC 12.2kbps	9400	1880	-0.53	0.038	22.00	21.54	0.042	1.6
Left Tilt	RMC 12.2kbps	9400	1880	0.12	0.046	22.00	21.54	0.051	1.6
Right Cheek	RMC 12.2kbps	9400	1880	0.96	<b>0.085</b>	22.00	21.54	<b>0.094</b>	1.6
Right Tilt	RMC 12.2kbps	9400	1880	-0.42	0.038	22.00	21.54	0.042	1.6
Body back	RMC 12.2kbps	9400	1880	-0.12	<b>0.440</b>	22.00	21.54	<b>0.489</b>	1.6
Body front	RMC 12.2kbps	9400	1880	-0.96	0.402	22.00	21.54	0.447	1.6
Edge 2(Right)	RMC 12.2kbps	9400	1880	-0.96	0.182	22.00	21.54	0.202	1.6
Edge 3(Bottom)	RMC 12.2kbps	9400	1880	0.53	0.339	22.00	21.54	0.377	1.6

Note:

- When the 1-g Reported SAR is  $\leq 0.8$  W/kg, testing for low and high channel is optional. Refer to KDB 447498.
- The test separation for body back and body front is 0mm of all above table.
- The test separation for 4 Edges is 0mm of all above table.

SAR MEASUREMENT									
Depth of Liquid (cm):>15					Relative Humidity (%):52.6				
Product: Tablet									
Test Mode:802.11b									
Position	Mode	Ch.	Fr. (MHz)	Power Drift (<±5%)	SAR (1g) (W/kg)	Max. Tune-up Power (dBm)	Meas. output Power (dBm)	Scaled SAR (W/Kg)	Limit (W/kg)
Left Cheek	DTS	6	2437	-0.96	0.015	13.5	13.27	0.016	1.6
Left Tilt	DTS	6	2437	1.05	0.014	13.5	13.27	0.015	1.6
Right Cheek	DTS	6	2437	-0.33	<b>0.019</b>	13.5	13.27	<b>0.020</b>	1.6
Right Tilt	DTS	6	2437	-0.46	0.019	13.5	13.27	0.020	1.6
Body back	DTS	6	2437	0.85	<b>0.115</b>	13.5	13.27	<b>0.121</b>	1.6
Body front	DTS	6	2437	-1.06	0.049	13.5	13.27	0.052	1.6
Edge 1 (Top)	DTS	6	2437	0.33	0.024	13.5	13.27	0.025	1.6
Edge 4(Left)	DTS	6	2437	-0.54	0.023	13.5	13.27	0.024	1.6

Note:

- According to KDB248227, SAR is not required for 802.11n HT20/HT40 channels when the maximum average output power is less than 1/4 dB higher than that measured on the corresponding 802.11a/b channels.
- All of above "DTS" means data transmitters.
- The test separation for body back and body front is 0mm of all above table.
- The test separation for 4 Edges is 0mm of all above table.

Repeated SAR										
Product: Tablet										
Test Mode: PCS1900 & WCDMA Band V with QPSK modulation										
Position	Mode	Ch.	Fr. (MHz)	Power Drift (<±5%)	Once SAR (1g) (W/kg)	Power Drift (<±5%)	Twice SAR (1g) (W/kg)	Power Drift (<±5%)	Third SAR (1g) (W/kg)	Limit (W/kg)
Body back	GPRS-2 slot	661	1880.0	0.63	0.800	-	-	-	-	1.6
Body back	RMC 12.2kbps	4183	836.6	0.95	0.851	-	-	-	-	1.6

**Simultaneous Multi-band Transmission Evaluation:**  
**Application Simultaneous Transmission information:**

NO	Simultaneous state	Portable Handset		
		Head	Body-worn	Hotspot
1	GSM(voice)+WLAN 2.4GHz (data)	Yes	Yes	-
2	WCDMA(voice)+WLAN 2.4GHz (data)	Yes	Yes	-
3	GSM(voice)+Bluetooth(data)	-	Yes	-
4	WCDMA(voice)+Bluetooth(data)	-	Yes	-
5	GSM (Data) + Bluetooth(data)	-	Yes	Yes
6	GSM (Data) + WLAN 2.4GHz (data)	Yes	Yes	Yes
7	WCDMA (Data) + Bluetooth(data)	--	Yes	Yes
8	WCDMA (Data) + WLAN 2.4GHz (data)	Yes	Yes	Yes

NOTE:

1. WIFI and BT share the same antenna, and cannot transmit simultaneously.
2. Simultaneous with every transmitter must be the same test position.
3. KDB 447498 D01, BT SAR is excluded as below table.
4. According to KDB 447498 D01 4.3.1, Standalone SAR test exclusion is as follow:  
For 100 MHz to 6 GHz and test separation distances  $\leq 50$  mm, the 1-g and 10-g SAR test exclusion thresholds are determined by the following:  

$$[(\text{max. power of channel, including tune-up tolerance, mW}) / (\text{min. test separation distance, mm})] \cdot [\sqrt{f(\text{GHz})}] \leq 3.0$$
for 1-g SAR, and  $\leq 7.5$  for 10-g extremity SAR<sup>30</sup>, where
  - f(GHz) is the RF channel transmit frequency in GHz
  - Power and distance are rounded to the nearest mW and mm before calculation<sup>31</sup>
  - The result is rounded to one decimal place for comparison
  - The values 3.0 and 7.5 are referred to as numeric thresholds in step b) below
The test exclusions are applicable only when the minimum test separation distance is  $\leq 50$  mm, and for transmission frequencies between 100 MHz and 6 GHz. When the minimum test separation distance is  $< 5$  mm, a distance of 5 mm according to 4.1 f) is applied to determine SAR test exclusion.
5. If the test separation distance is  $< 5$ mm, 5mm is used for excluded SAR calculation.
6. According to KDB 447498 D01 4.3.2, simultaneous transmission SAR test exclusion is as follow:
  - (1) Simultaneous transmission SAR test exclusion is determined for each operating configuration and exposure condition according to the reported standalone SAR of each applicable simultaneous transmitting antenna.
  - (2) Any transmitters and antennas should be considered when calculating simultaneous mode.
  - (3) For mobile phone and PC, it's the sum of all transmitters and antennas at the same mode with same position in each applicable exposure condition
  - (4) When the standalone SAR test exclusion of section 4.3.2 is applied to an antenna that transmits simultaneously with other antennas, the standalone SAR must be estimated according to the following to det
$$[(\text{max. power of channel, including tune-up tolerance, mW}) / (\text{min. test separation distance, mm})] \cdot [\sqrt{f(\text{GHz})} / x] \text{ W/kg}$$
for test separation distances  $\leq 50$  mm;  
where  $x = 7.5$  for 1-g SAR, and  $x = 18.75$  for 10-g SAR.

7. When the sum of SAR is larger than the limit, SAR test exclusion is determined by the SAR to peak location separation ratio. The simultaneous transmitting antennas in each operating mode and exposure condition combination must be considered one pair at a time to determine the SAR to peak location separation ratio to qualify for test exclusion. The ratio is determined by  $(SAR1 + SAR2)1.5/R_i$ , rounded to two decimal digits, and must be  $\leq 0.04$  for all antenna pairs in the configuration to qualify for 1-g SAR test exclusion.

Estimated SAR		Max Power including Tune-up Tolerance		Separation Distance (mm)	Estimated SAR (W/kg)
		dBm	mW		
<b>BT</b>	Head	3	1.995	0	0.083
	Body	3	1.995	0	0.083

**Sum of the SAR for GSM 850 & Wi-Fi & BT:**

RF Exposure Conditions	Test Position	Simultaneous Transmission Scenario			Σ1-g SAR (W/Kg)	SPLSR (Yes/No)
		GSM 850	Wi-Fi DTS Band	Bluetooth		
Head (voice)	Left Touch	0.090	0.016		0.106	No
	Left Tilt	0.060	0.015		0.075	No
	Right Touch	0.085	0.020		0.105	No
	Right Tilt	0.066	0.020		0.086	No
Body-worn (voice)	Rear	0.618	0.121		0.739	No
		0.618		0.083	0.701	No
	Front	0.454	0.052		0.506	No
		0.454		0.083	0.537	No
Head (Data)	Left Touch	0.123	0.016		0.139	No
	Left Tilt	0.115	0.015		0.130	No
	Right Touch	0.130	0.020		0.150	No
	Right Tilt	0.095	0.020		0.115	No
Body-worn (Data)	Rear	0.781		0.083	0.864	No
		0.781	0.121		0.902	No
	Front	0.583		0.083	0.666	No
		0.583	0.052		0.635	No

**Note:**

- According to KDB 447498 D01 General RF Exposure Guidance, when the simultaneous transmission SAR is less than 1.6 W/Kg, SPLSR assessment is not required.
- SPLSR mean is "The SAR to Peak Location Separation Ratio"

**Sum of the SAR for GSM 1900 & Wi-Fi & BT:**

RF Exposure Conditions	Test Position	Simultaneous Transmission Scenario			Σ1-g SAR (W/Kg)	SPLSR (Yes/No)
		GSM 1900	Wi-Fi DTS Band	Bluetooth		
Head (voice)	Left Touch	0.051	0.016		0.067	No
	Left Tilt	0.055	0.015		0.070	No
	Right Touch	0.070	0.020		0.090	No
	Right Tilt	0.037	0.020		0.057	No
Body-worn (voice)	Rear	0.395	0.121		0.516	No
		0.395		0.083	0.478	No
	Front	0.248	0.052		0.300	No
		0.248		0.083	0.331	No
Head (Data)	Left Touch	0.086	0.016		0.102	No
	Left Tilt	0.097	0.015		0.112	No
	Right Touch	0.163	0.020		0.183	No
	Right Tilt	0.064	0.020		0.084	No
Body-worn (Data)	Rear	0.910		0.083	0.993	No
		0.910	0.121		1.031	No
	Front	0.663		0.083	0.746	No
		0.663	0.052		0.715	No

**Note:**

- According to KDB 447498 D01 General RF Exposure Guidance, when the simultaneous transmission SAR is less than 1.6 W/Kg, SPLSR assessment is not required.
- SPLSR mean is "The SAR to Peak Location Separation Ratio"

**Sum of the SAR for WCDMA Band II&Wi-Fi & BT:**

RF Exposure Conditions	Test Position	Simultaneous Transmission Scenario			Σ1-g SAR (W/Kg)	SPLSR (Yes/No)
		WCDMA BandII	Wi-Fi DTS Band	Bluetooth		
Head	Left Touch	0.042	0.016		0.058	No
	Left Tilt	0.051	0.015		0.066	No
	Right Touch	0.094	0.020		0.114	No
	Right Tilt	0.042	0.020		0.062	No
Body-worn	Rear	0.489	0.121		0.610	No
	Front	0.447	0.052		0.499	No
	Rear	0.489		0.083	0.572	No
	Front	0.447		0.083	0.530	No

**Note:**

- According to KDB 447498 D01 General RF Exposure Guidance, when the simultaneous transmission SAR is less than 1.6 W/Kg, SPLSR assessment is not required.
- SPLSR mean is “The SAR to Peak Location Separation Ratio “



**Sum of the SAR for WCDMA Band V & Wi-Fi & BT:**

RF Exposure Conditions	Test Position	Simultaneous Transmission Scenario			Σ1-g SAR (W/Kg)	SPLSR (Yes/No)
		WCDMA Band V	Wi-Fi DTS Band	Bluetooth		
Head	Left Touch	0.045	0.016		0.061	No
	Left Tilt	0.021	0.015		0.036	No
	Right Touch	0.087	0.020		0.107	No
	Right Tilt	0.059	0.020		0.079	No
Body-worn	Rear	1.066	0.121		<b>1.187</b>	No
	Front	0.543	0.052		0.595	No
	Rear	1.066		0.083	1.149	No
	Front	0.543		0.083	0.626	No

**Note:**

- According to KDB 447498 D01 General RF Exposure Guidance, when the simultaneous transmission SAR is less than 1.6 W/Kg, SPLSR assessment is not required.
- SPLSR mean is “The SAR to Peak Location Separation Ratio “

## APPENDIX A. SAR SYSTEM CHECK DATA

Test Laboratory: AGC Lab

Date: Dec.27,2016

System Check Head 835 MHz

DUT: Dipole 835 MHz Type: SID 835

Communication System CW; Communication System Band: D835 (835.0 MHz); Duty Cycle: 1:1; Conv.F=5.67

Frequency: 835 MHz; Medium parameters used:  $f = 835$  MHz;  $\sigma=0.89$  mho/m;  $\epsilon_r = 41.56$ ;  $\rho= 1000$  kg/m<sup>3</sup> ;

Phantom section: Flat Section; Input Power=18dBm

Ambient temperature (°C):21.8, Liquid temperature (°C): 20.9

SATIMO Configuration

- Probe: SSE5; Calibrated: 07/05/2016 Serial No.: SN 14/16 EP307
- Sensor-Surface: 4mm (Mechanical Surface Detection)
- Phantom: SAM twin phantom
- Measurement SW: OpenSAR V4\_02\_35

Configuration/System Check 835MHz Head/Area Scan: Measurement grid: dx=8mm, dy=8mm

Configuration/System Check 835MHz Head/Zoom Scan: Measurement grid: dx=8mm,dy=8mm, dz=5mm

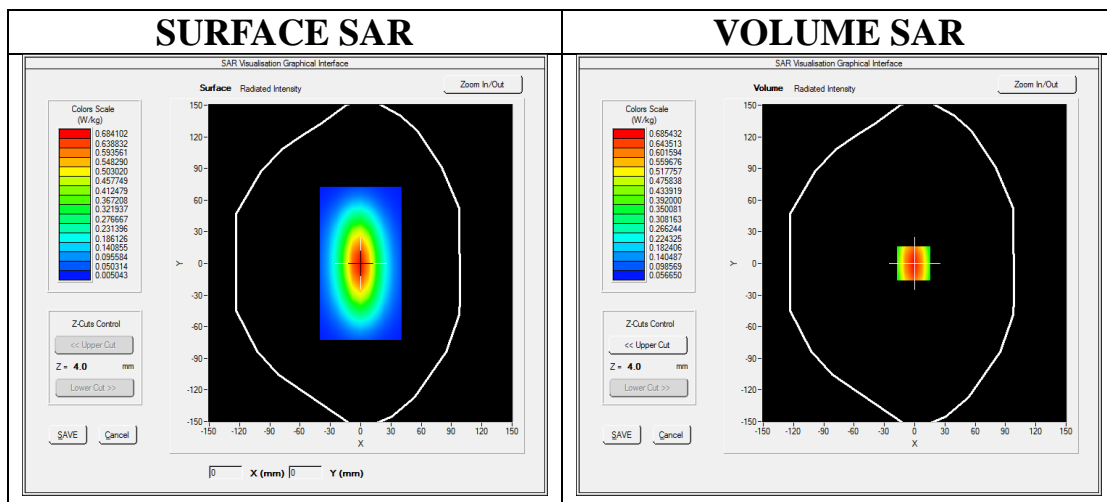

Maximum location: X=-1.00, Y=0.00

SAR Peak: 0.91 W/kg

SAR 10g (W/Kg)	0.425538
SAR 1g (W/Kg)	0.654385

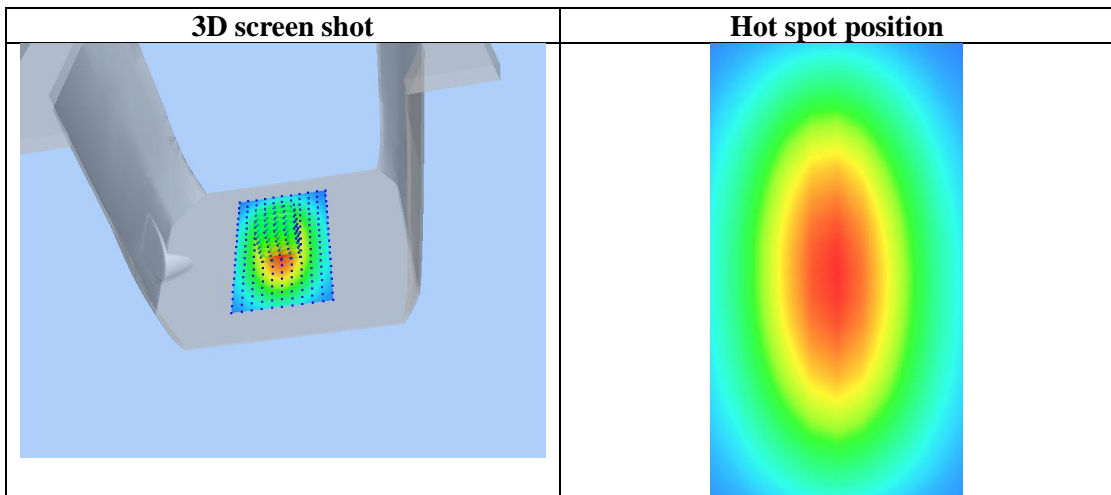
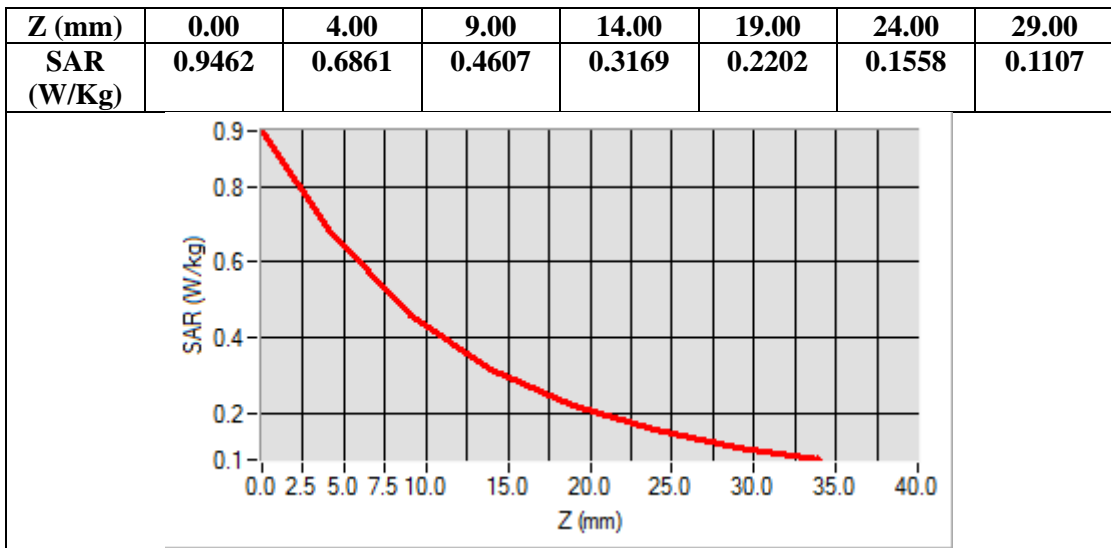

**Test Laboratory: AGC Lab**  
**System Check Body 835 MHz**  
**DUT: Dipole 835 MHz Type: SID 835**

**Date: Dec.27,2016**

Communication System CW; Communication System Band: D835 (835.0 MHz); Duty Cycle: 1:1; Conv.F=5.89  
Frequency: 835 MHz; Medium parameters used:  $f = 835$  MHz;  $\sigma=0.93$  mho/m;  $\epsilon_r = 55.72$ ;  $\rho= 1000$  kg/m<sup>3</sup> ;  
Phantom section: Flat Section; Input Power=18dBm  
Ambient temperature (°C):21.8, Liquid temperature (°C): 21.1

**SATIMO Configuration**

- Probe: SSE5; Calibrated: 07/05/2016 Serial No.: SN 14/16 EP307
- Sensor-Surface: 4mm (Mechanical Surface Detection)
- Phantom: SAM twin phantom
- Measurement SW: OpenSAR V4\_02\_35

**Configuration/System Check 835MHz Body/Area Scan: Measurement grid: dx=8mm, dy=8mm**

**Configuration/System Check 835MHz Body/Zoom Scan: Measurement grid: dx=8mm,dy=8mm, dz=5mm**

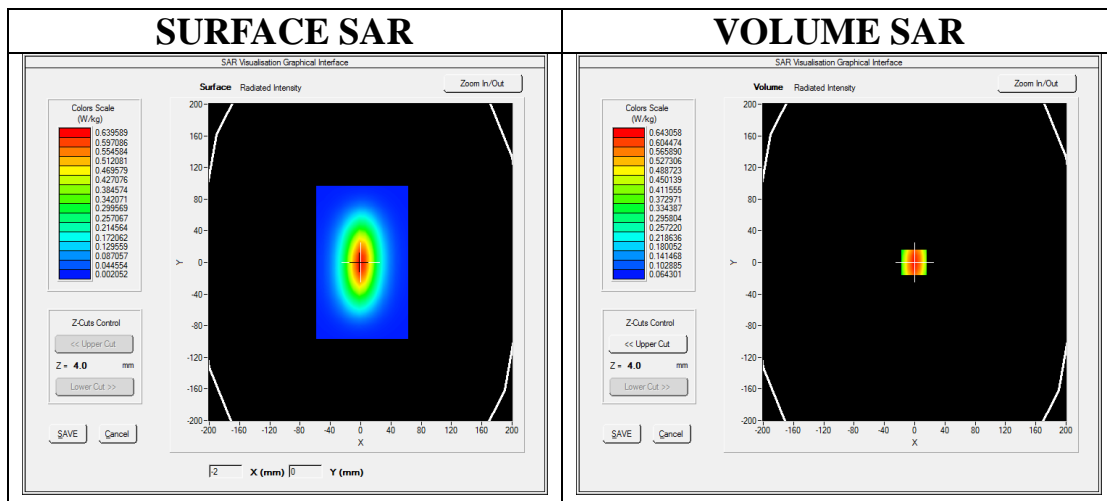

**Maximum location: X=-1.00, Y=0.00**  
**SAR Peak: 0.88 W/kg**

<b>SAR 10g (W/Kg)</b>	0.403842
<b>SAR 1g (W/Kg)</b>	0.616711

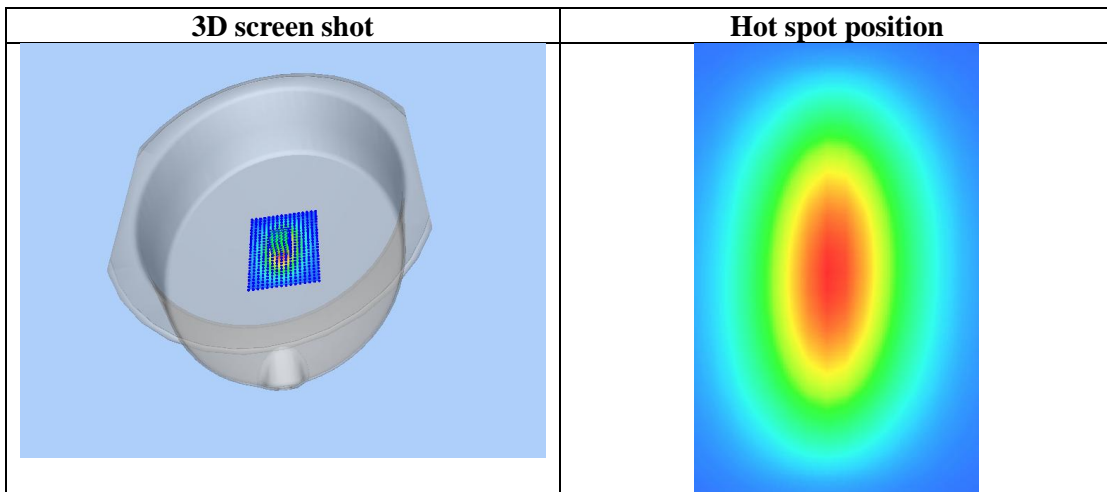
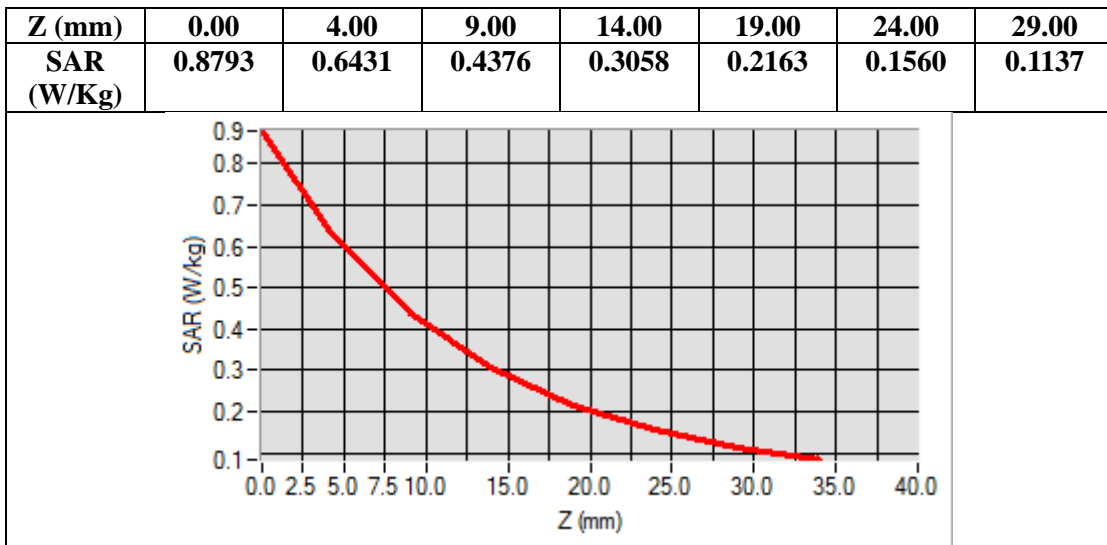

**Test Laboratory: AGC Lab**  
**System Check Head 1900MHz**

**Date: Dec.29,2016**

**DUT: Dipole 1900 MHz; Type: SID 1900**

Communication System: CW; Communication System Band: D1900 (1900.0 MHz); Duty Cycle:1:1; Conv.F=5.14  
Frequency: 1900 MHz; Medium parameters used:  $f = 1900$  MHz;  $\sigma=1.39$  mho/m;  $\epsilon_r=40.38$ ;  $\rho= 1000$  kg/m<sup>3</sup> ;  
Phantom section: Flat Section; Input Power=18dBm  
Ambient temperature (°C):22.5, Liquid temperature (°C): 21.8

SATIMO Configuration:

- Probe: SSE5; Calibrated: 07/05/2016 Serial No.: SN 14/16 EP307
- Sensor-Surface: 4mm (Mechanical Surface Detection)
- Phantom: SAM twin phantom
- Measurement SW: OpenSAR V4\_02\_35

**Configuration/System Check 1900MHz Head/Area Scan:** Measurement grid: dx=8mm, dy=8mm

**Configuration/System Check 1900MHz Head/Zoom Scan:** Measurement grid: dx=8mm,dy=8mm, dz=5mm

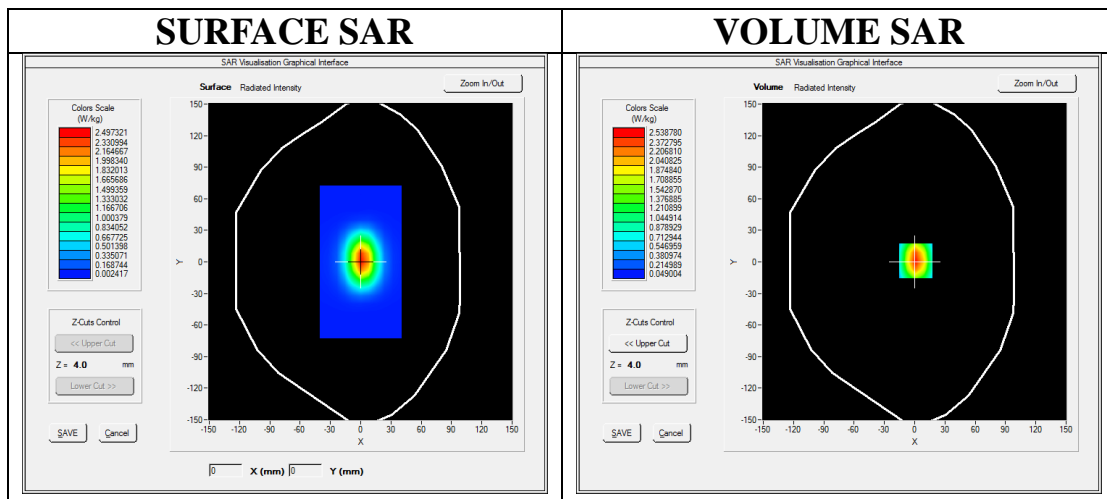

**Maximum location: X=1.00, Y=1.00**

**SAR Peak: 3.89 W/kg**

<b>SAR 10g (W/Kg)</b>	1.249638
<b>SAR 1g (W/Kg)</b>	2.371125

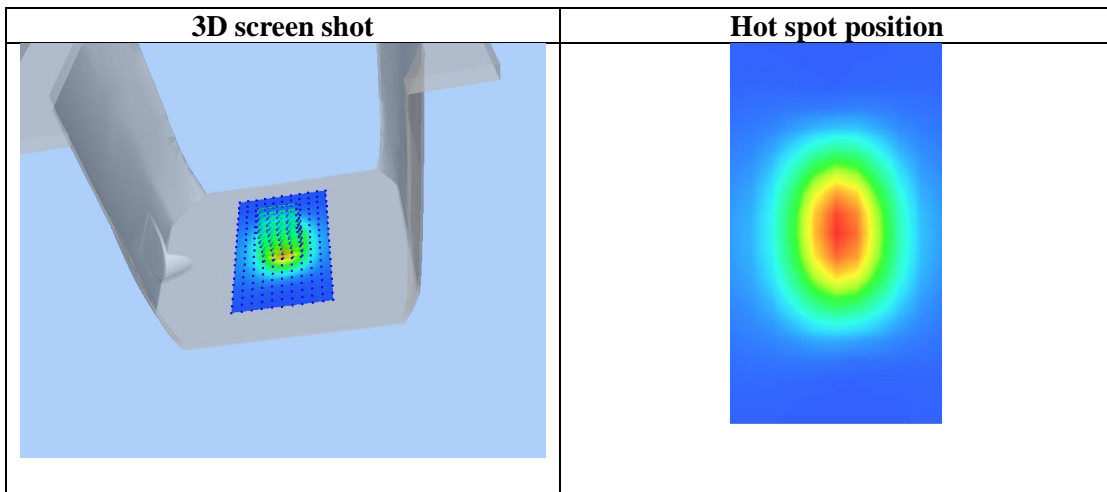
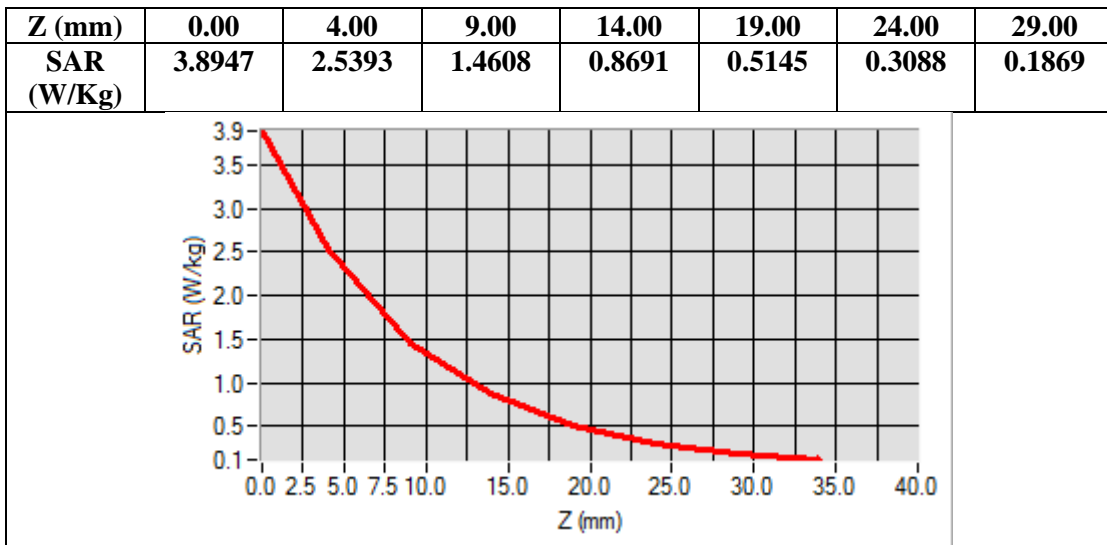

**Test Laboratory: AGC Lab**  
**System Check Body 1900MHz**  
**DUT: Dipole 1900 MHz; Type: SID 1900**

**Date: Dec.29,2016**

Communication System: CW; Communication System Band: D1900 (1900.0 MHz); Duty Cycle:1:1; Conv.F=5.34  
Frequency: 1900 MHz; Medium parameters used:  $f = 1900$  MHz;  $\sigma=1.49$  mho/m;  $\epsilon_r =53.74$ ;  $\rho= 1000$  kg/m<sup>3</sup> ;  
Phantom section: Flat Section; Input Power=18dBm  
Ambient temperature (°C):22.5, Liquid temperature (°C): 21.5

SATIMO Configuration:

- Probe: SSE5; Calibrated: 07/05/2016 Serial No.: SN 14/16 EP307
- Sensor-Surface: 4mm (Mechanical Surface Detection)
- Phantom: SAM twin phantom
- Measurement SW: OpenSAR V4\_02\_35

**Configuration/System Check 1900MHz Body/Area Scan: Measurement grid: dx=8mm, dy=8mm**

**Configuration/System Check 1900MHz Body/Zoom Scan: Measurement grid: dx=8mm,dy=8mm, dz=5mm**

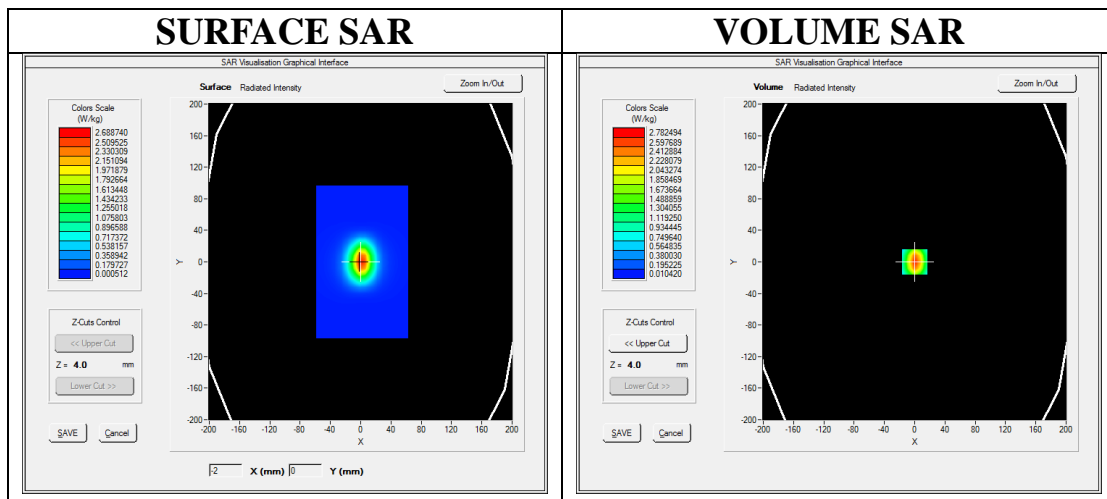

**Maximum location: X=0.00, Y=0.00**

**SAR Peak: 5.05 W/kg**

<b>SAR 10g (W/Kg)</b>	1.251394
<b>SAR 1g (W/Kg)</b>	2.654516



<b>Z (mm)</b>	<b>0.00</b>	<b>4.00</b>	<b>9.00</b>	<b>14.00</b>	<b>19.00</b>	<b>24.00</b>	<b>29.00</b>
<b>SAR (W/Kg)</b>	<b>5.1106</b>	<b>2.7825</b>	<b>1.1715</b>	<b>0.5119</b>	<b>0.2262</b>	<b>0.1015</b>	<b>0.0464</b>

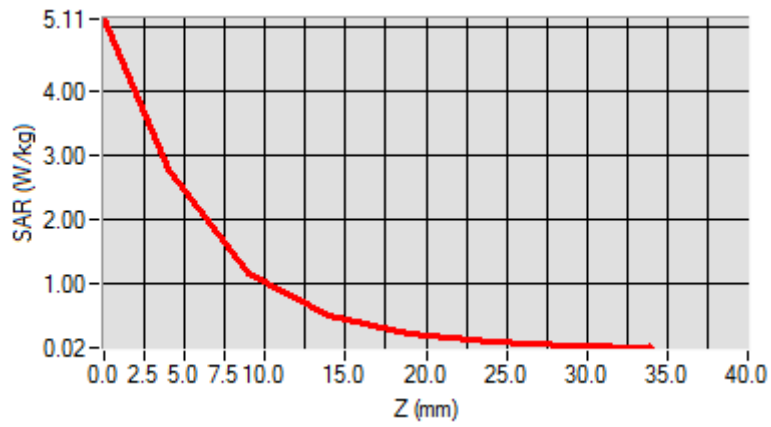

3D screen shot	Hot spot position

**Test Laboratory: AGC Lab**  
**System Check Head 2450 MHz**

**Date: Jan.05,2017**

**DUT: Dipole 2450 MHz Type: SID 2450**

Communication System CW; Communication System Band: D2450 (2450.0 MHz); Duty Cycle: 1:1; Conv.F=5.07  
Frequency: 2450 MHz; Medium parameters used:  $f = 2450$  MHz;  $\sigma=1.82$  mho/m;  $\epsilon_r =39.03$ ;  $\rho= 1000$  kg/m<sup>3</sup> ;  
Phantom section: Flat Section; Input Power=18dBm  
Ambient temperature (°C):22.3, Liquid temperature (°C): 21.8

**SATIMO Configuration**

- Probe: SSE5; Calibrated: 07/05/2016 Serial No.: SN 14/16 EP307
- Sensor-Surface: 4mm (Mechanical Surface Detection)
- Phantom: SAM twin phantom
- Measurement SW: OpenSAR V4\_02\_35

**Configuration/System Check 2450MHz Head/Area Scan: Measurement grid: dx=8mm, dy=8mm**

**Configuration/System Check 2450MHz Head/Zoom Scan: Measurement grid: dx=5mm,dy=5mm, dz=5mm**

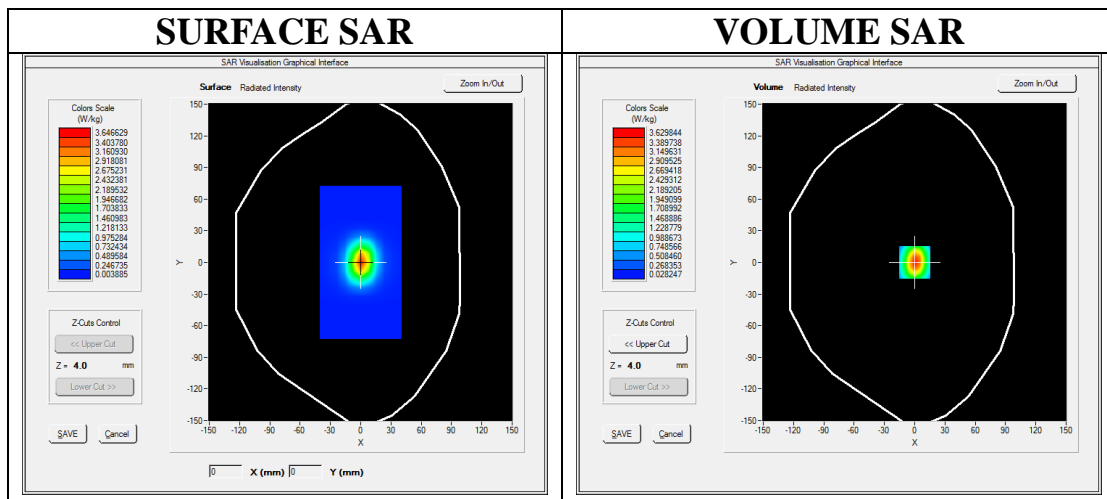

**Maximum location: X=0.00, Y=0.00**  
**SAR Peak: 5.90 W/kg**

<b>SAR 10g (W/Kg)</b>	1.463712
<b>SAR 1g (W/Kg)</b>	3.102247

Z (mm)	0.00	4.00	9.00	14.00	19.00	24.00	29.00
SAR (W/Kg)	5.9537	3.6298	1.8706	0.9669	0.5114	0.2719	0.1476

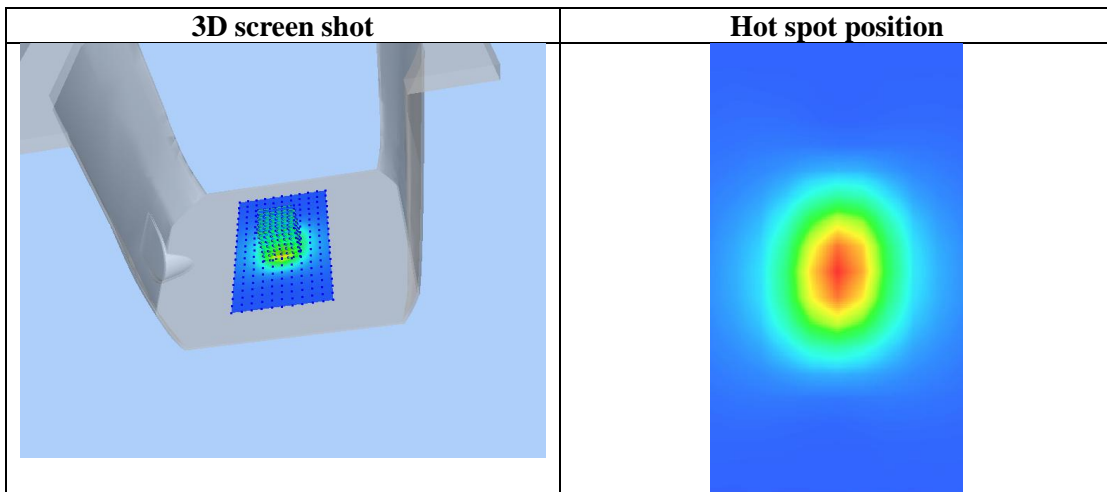
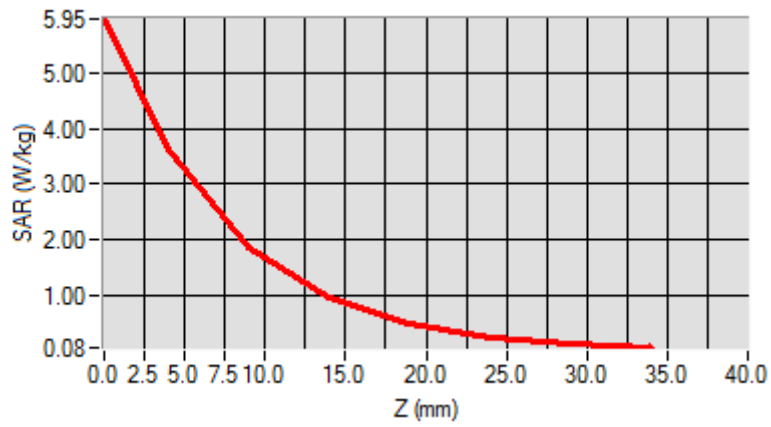

**Test Laboratory: AGC Lab**  
**System Check Body 2450 MHz**

**Date: Jan.05,2017**

**DUT: Dipole 2450 MHz Type: SID 2450**

Communication System CW; Communication System Band: D2450 (2450.0 MHz); Duty Cycle: 1:1; Conv.F=5.19  
Frequency: 2450 MHz; Medium parameters used:  $f = 2450$  MHz;  $\sigma=1.96$  mho/m;  $\epsilon_r =52.79$ ;  $\rho= 1000$  kg/m<sup>3</sup> ;  
Phantom section: Flat Section; Input Power=18dBm  
Ambient temperature (°C):22.3, Liquid temperature (°C): 21.5

**SATIMO Configuration**

- Probe: SSE5; Calibrated: 07/05/2016 Serial No.: SN 14/16 EP307
- Sensor-Surface: 4mm (Mechanical Surface Detection)
- Phantom: SAM twin phantom
- Measurement SW: OpenSAR V4\_02\_35

**Configuration/System Check 2450MHz Body/Area Scan: Measurement grid: dx=8mm, dy=8mm**

**Configuration/System Check 2450MHz Body/Zoom Scan: Measurement grid: dx=5mm,dy=5mm, dz=5mm**

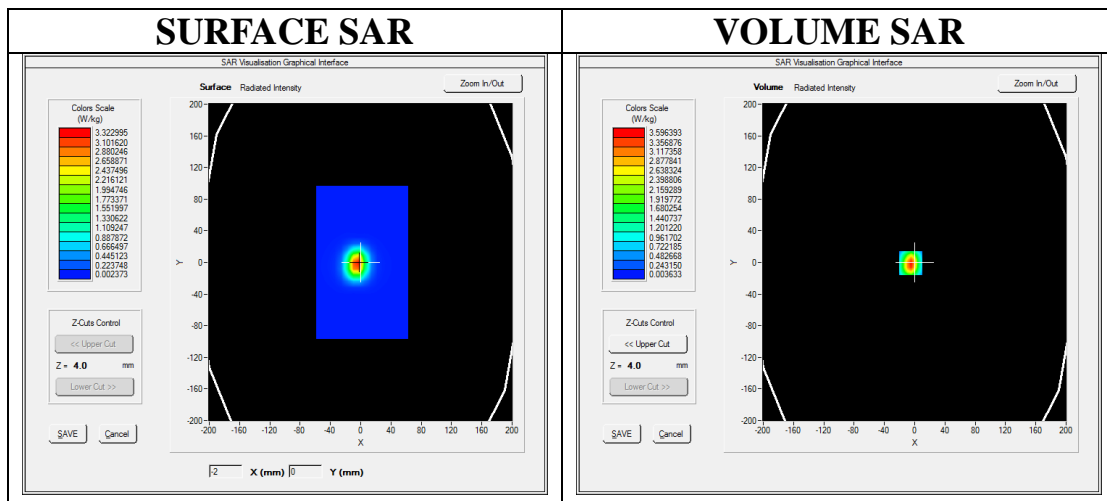

**Maximum location: X=-5.00, Y=-1.00**  
**SAR Peak: 7.34 W/kg**

<b>SAR 10g (W/Kg)</b>	<b>1.377959</b>
<b>SAR 1g (W/Kg)</b>	<b>3.364346</b>

Z (mm)	0.00	4.00	9.00	14.00	19.00	24.00	29.00
SAR (W/Kg)	7.5022	3.5964	1.1202	0.3597	0.1204	0.0412	0.0160

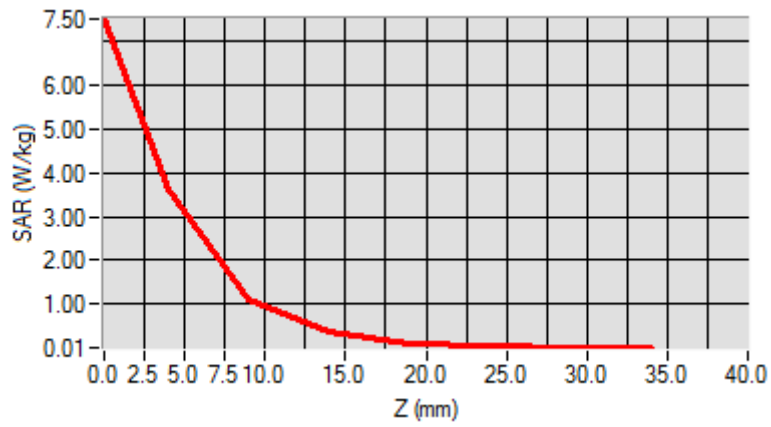

3D screen shot	Hot spot position

## APPENDIX B. SAR MEASUREMENT DATA

Test Laboratory: AGC Lab  
GSM 850 Mid-Touch-Left <SIM 1>  
DUT: Tablet; Type: TT-772

Date: Dec.27,2016

Communication System: Generic GSM; Communication System Band: GSM 850; Duty Cycle: 1:8.3; Conv.F=5.67;  
Frequency: 836.6 MHz; Medium parameters used:  $f = 835$  MHz;  $\sigma=0.91$  mho/m;  $\epsilon_r=41.31$ ;  $\rho= 1000$  kg/m<sup>3</sup>;  
Phantom section: Left Section  
Ambient temperature (°C): 21.8, Liquid temperature (°C): 20.9

SATIMO Configuration:

- Probe: SSE5; Calibrated: 07/05/2016 Serial No.: SN 14/16 EP307
- Sensor-Surface: 4mm (Mechanical Surface Detection)
- Phantom: SAM twin phantom
- Measurement SW: OpenSAR V4\_02\_35

Configuration/GSM 850 Mid-Touch-Left/Area Scan: Measurement grid: dx=8mm, dy=8mm  
Configuration/GSM 850 Mid-Touch-Left/Zoom Scan : Measurement grid: dx=8mm,dy=8mm, dz=5mm

Area Scan	sam_direct_droit2_surf8mm.txt
ZoomScan	5x5x7,dx=8mm dy=8mm dz=5mm,Complete
Phantom	Left head
Device Position	Cheek
Band	GSM 850
Channels	Middle
Signal	TDMA (Crest factor: 8.0)

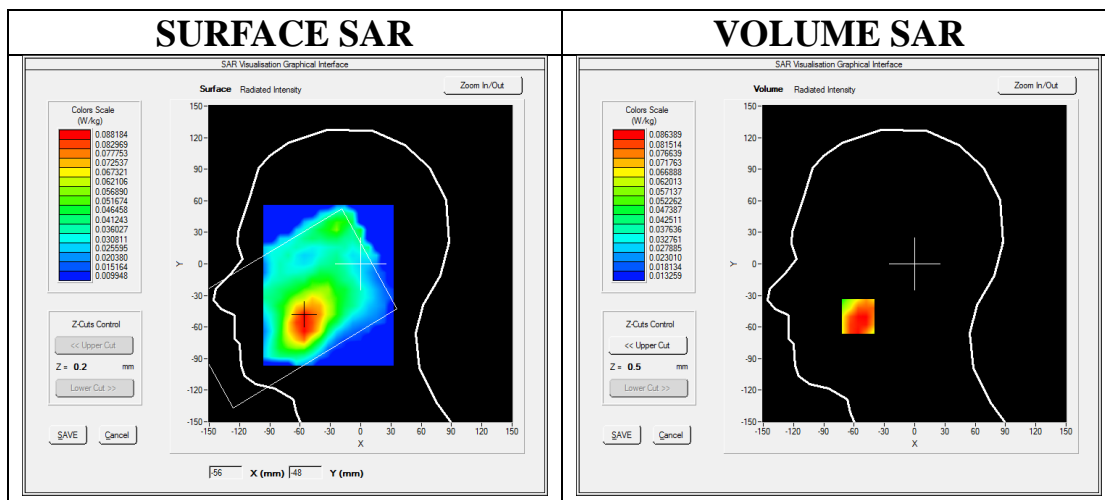

**Maximum location: X=-56.00, Y=-50.00**

**SAR Peak: 0.11 W/kg**

<b>SAR 10g (W/Kg)</b>	0.065594
<b>SAR 1g (W/Kg)</b>	0.084457

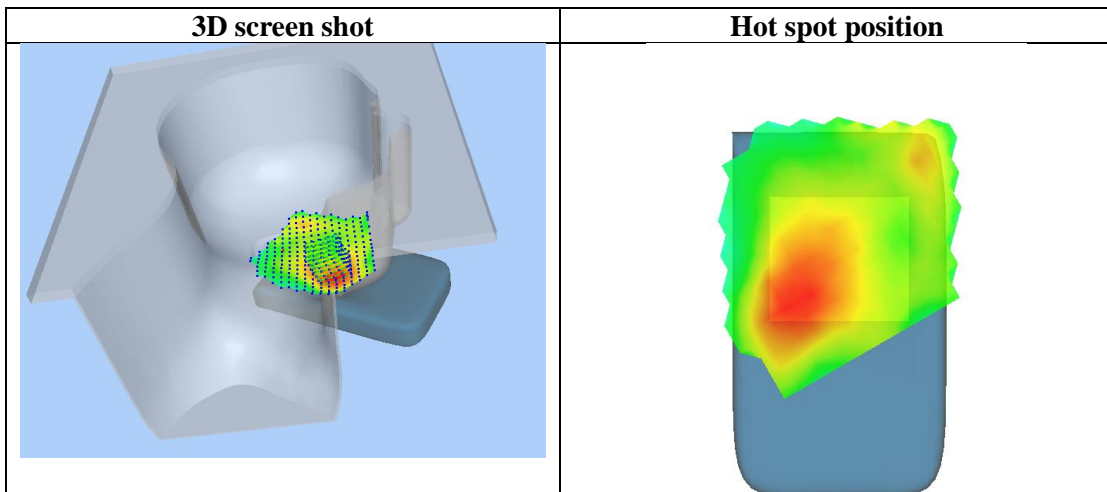
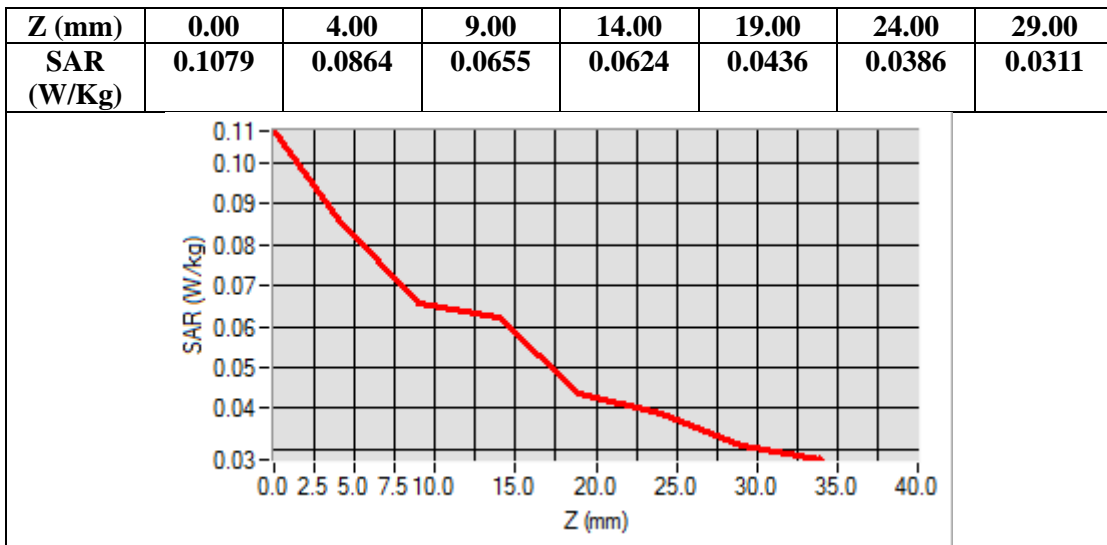

Test Laboratory: AGC Lab  
GSM 850 Mid- Body- Back (MS)<SIM 1>  
DUT: Tablet; Type: TT-772

Date: Dec.27,2016

Communication System: Generic GSM; Communication System Band: GSM 850; Duty Cycle: 1:8.3; Conv.F=5.89;  
Frequency: 836.6 MHz; Medium parameters used:  $f = 835$  MHz;  $\sigma = 0.95$  mho/m;  $\epsilon = 55.12$ ;  $\rho = 1000$  kg/m<sup>3</sup> ;  
Phantom section: Flat Section  
Ambient temperature (°C): 21.8, Liquid temperature (°C): 21.1

SATIMO Configuration:

- Probe: SSE5; Calibrated: 07/05/2016 Serial No.: SN 14/16 EP307
- Sensor-Surface: 4mm (Mechanical Surface Detection)
- Phantom: SAM twin phantom
- Measurement SW: OpenSAR V4\_02\_35

Configuration/GSM 850 Mid-Body-Back/Area Scan: Measurement grid: dx=8mm, dy=8mm  
Configuration/GSM 850 Mid-Body-Back/Zoom Scan: Measurement grid: dx=8mm,dy=8mm, dz=5mm;

Area Scan	surf_sam_plan.txt
ZoomScan	5x5x7,dx=8mm dy=8mm dz=5mm,Complete
Phantom	Validation plane
Device Position	Body Back
Band	GSM 850
Channels	Middle
Signal	TDMA (Crest factor: 8.0)

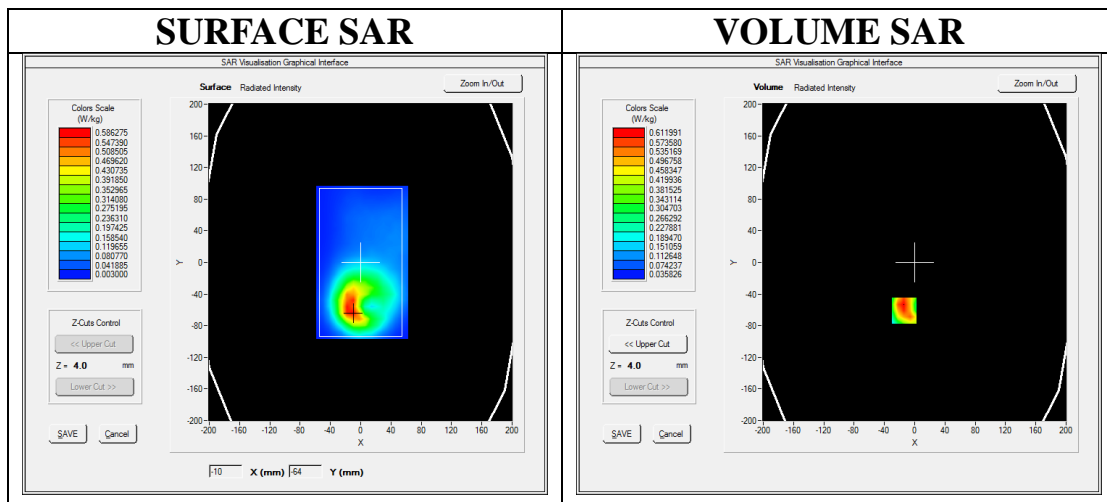

Maximum location: X=-14.00, Y=-61.00

SAR Peak: 0.88 W/kg

SAR 10g (W/Kg)	0.346505
SAR 1g (W/Kg)	0.579129



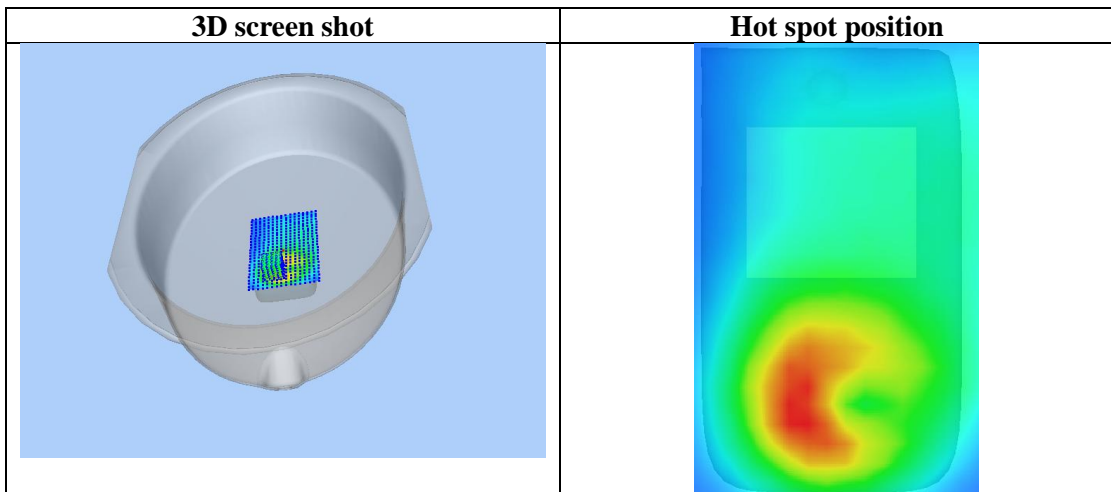
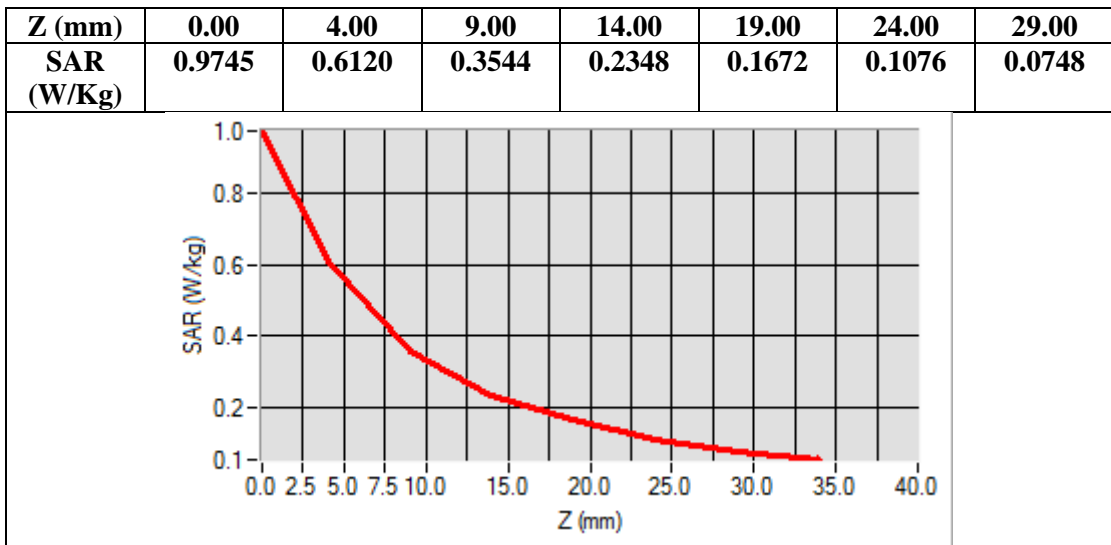

Test Laboratory: AGC Lab  
GPRS 850 Mid- Touch-Right (3up)  
DUT: Tablet; Type: TT-772

Date: Dec.27,2016

Communication System: GPRS-3 Slot; Communication System Band: GSM 850; Duty Cycle: 1:2.7; Conv.F=5.67  
Frequency: 836.6 MHz; Medium parameters used:  $f = 835$  MHz;  $\sigma=0.91$  mho/m;  $\epsilon_r=41.31$ ;  $\rho= 1000$  kg/m<sup>3</sup>;  
Phantom section: Right Section  
Ambient temperature (°C): 21.8, Liquid temperature (°C): 20.9

SATIMO Configuration:

- Probe: SSE5; Calibrated: 07/05/2016 Serial No.: SN 14/16 EP307
- Sensor-Surface: 4mm (Mechanical Surface Detection)
- Phantom: SAM twin phantom
- Measurement SW: OpenSAR V4\_02\_35

Configuration/GPRS 850 Mid-Touch-Right/Area Scan: Measurement grid: dx=8mm, dy=8mm  
Configuration/GPRS 850 Mid-Touch-Right/Zoom Scan: Measurement grid: dx=8mm,dy=8mm, dz=5mm;

Area Scan	sam_direct_droit2_surf8mm.txt
Zoom Scan	5x5x7,dx=8mm dy=8mm dz=5mm,Complete
Phantom	Right head
Device Position	Cheek
Band	GSM 850
Channels	Middle
Signal	TDMA (Crest factor: 2.7)

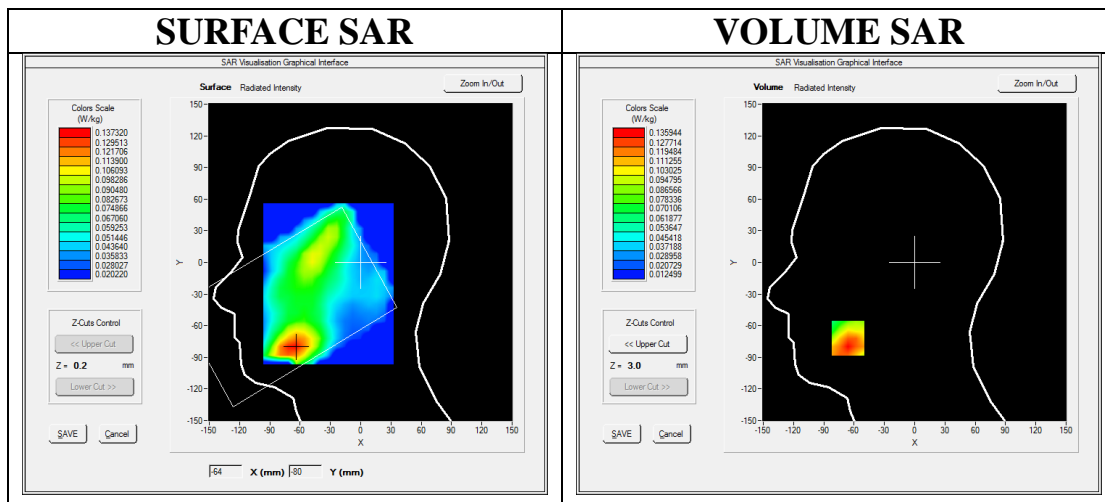

Maximum location: X=-66.00, Y=-72.00

SAR Peak: 0.18 W/kg

SAR 10g (W/Kg)	0.087852
SAR 1g (W/Kg)	0.128243

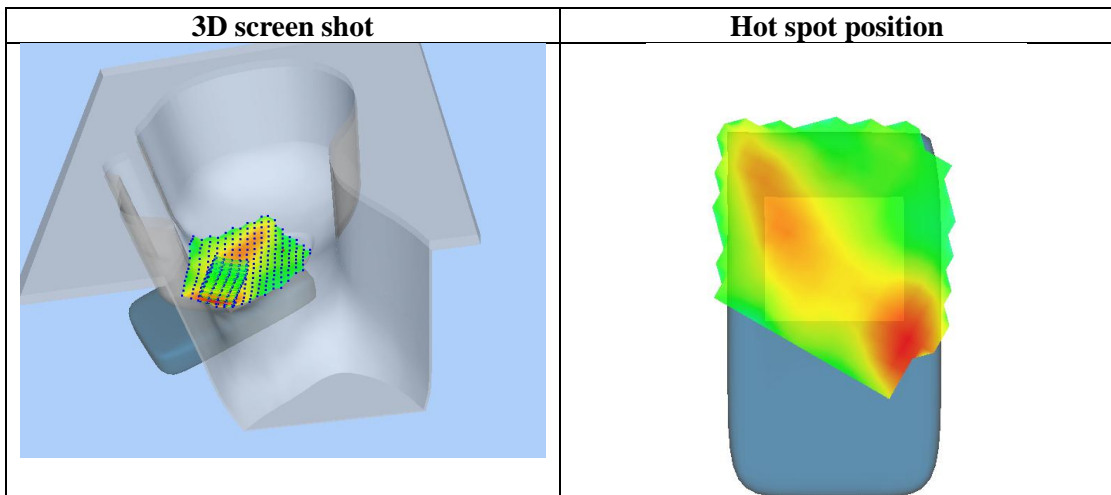
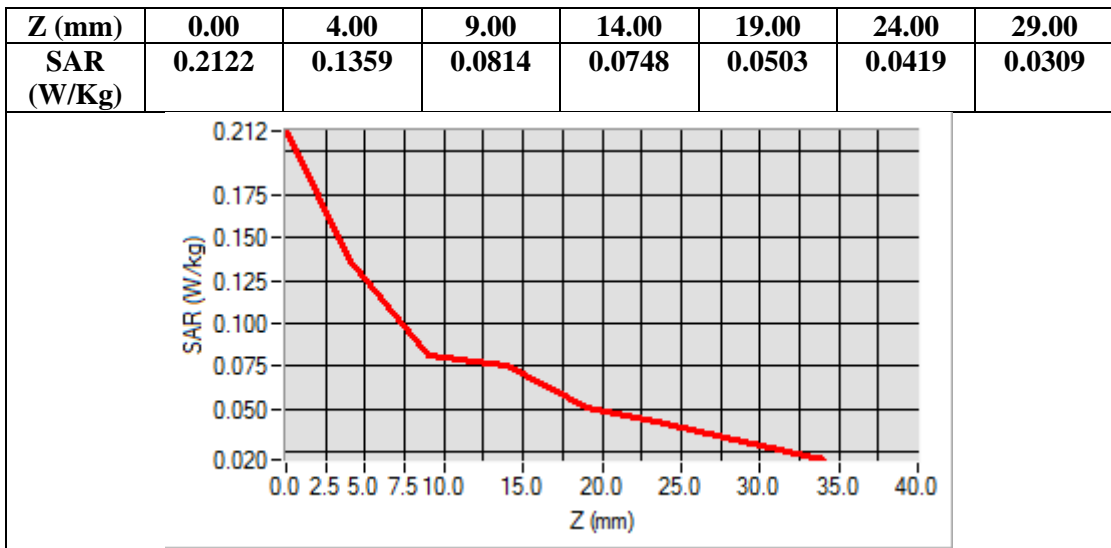

Test Laboratory: AGC Lab  
GPRS 850 Mid- Body- Back (3up)  
DUT: Tablet; Type: TT-772

Date: Dec.27,2016

Communication System: GPRS-3 Slot; Communication System Band: GSM 850; Duty Cycle: 1:2.7; Conv.F=5.89;  
Frequency: 836.6 MHz; Medium parameters used:  $f = 835$  MHz;  $\sigma = 0.95$  mho/m;  $\epsilon_r = 55.12$ ;  $\rho = 1000$  kg/m<sup>3</sup> ;  
Phantom section: Flat Section  
Ambient temperature (°C): 21.8, Liquid temperature (°C): 21.1

SATIMO Configuration:

- Probe: SSE5; Calibrated: 07/05/2016 Serial No.: SN 14/16 EP307
- Sensor-Surface: 4mm (Mechanical Surface Detection)
- Phantom: SAM twin phantom
- Measurement SW: OpenSAR V4\_02\_35

Configuration/GPRS 850 Mid-Body-Back/Area Scan: Measurement grid: dx=8mm, dy=8mm

Configuration/GPRS 850 Mid-Body-Back/Zoom Scan: Measurement grid: dx=8mm,dy=8mm, dz=5mm;

Area Scan	surf_sam_plan.txt
Zoom Scan	5x5x7,dx=8mm dy=8mm dz=5mm,Complete
Phantom	Validation plane
Device Position	Body Back
Band	GSM 850
Channels	Middle
Signal	TDMA (Crest factor: 2.7)

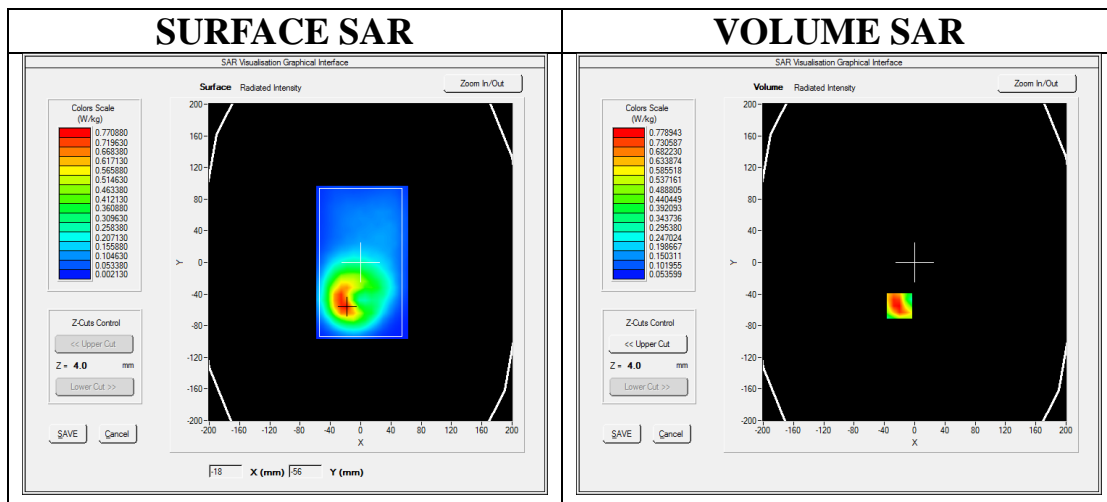

Maximum location: X=-20.00, Y=-55.00

SAR Peak: 1.18 W/kg

SAR 10g (W/Kg)	0.473154
SAR 1g (W/Kg)	0.767056

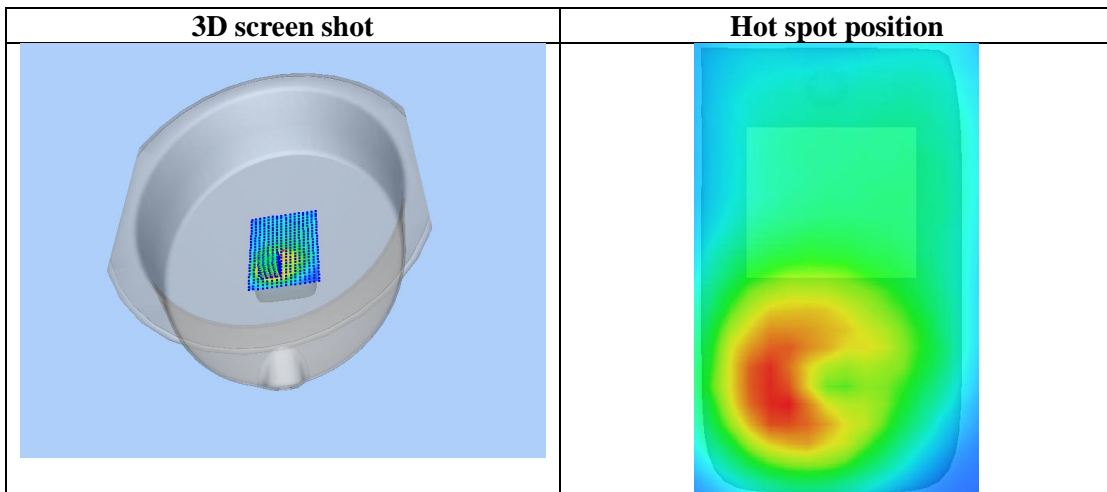
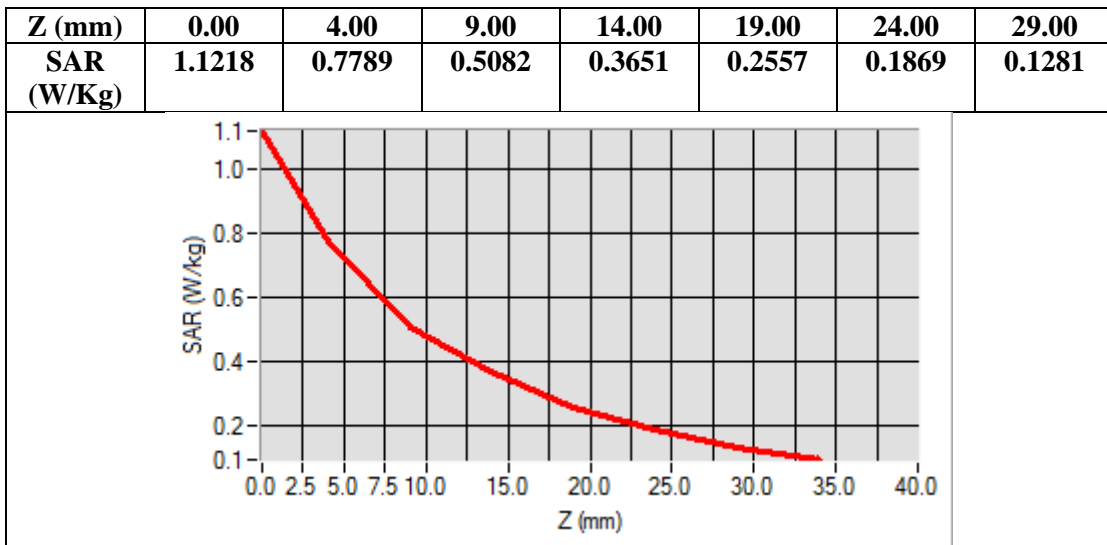

Test Laboratory: AGC Lab  
GPRS 850 Mid- Body- Back (3up)-SIM2  
DUT: Tablet; Type: TT-772

Date: Dec.27,2016

Communication System: GPRS-3 Slot; Communication System Band: GSM 850; Duty Cycle: 1:2.7; Conv.F=5.89;  
Frequency: 836.6 MHz; Medium parameters used:  $f = 835$  MHz;  $\sigma = 0.95$  mho/m;  $\epsilon_r = 55.12$ ;  $\rho = 1000$  kg/m<sup>3</sup> ;  
Phantom section: Flat Section  
Ambient temperature (°C): 21.8, Liquid temperature (°C): 21.1

SATIMO Configuration:

- Probe: SSE5; Calibrated: 07/05/2016 Serial No.: SN 14/16 EP307
- Sensor-Surface: 4mm (Mechanical Surface Detection)
- Phantom: SAM twin phantom
- Measurement SW: OpenSAR V4\_02\_35

Configuration/GPRS 850 Mid-Body-Back/Area Scan: Measurement grid: dx=8mm, dy=8mm

Configuration/GPRS 850 Mid-Body-Back/Zoom Scan: Measurement grid: dx=8mm,dy=8mm, dz=5mm;

Area Scan	surf_sam_plan.txt
Zoom Scan	5x5x7,dx=8mm dy=8mm dz=5mm,Complete
Phantom	Validation plane
Device Position	Body Back
Band	GSM 850
Channels	Middle
Signal	TDMA (Crest factor: 2.7)

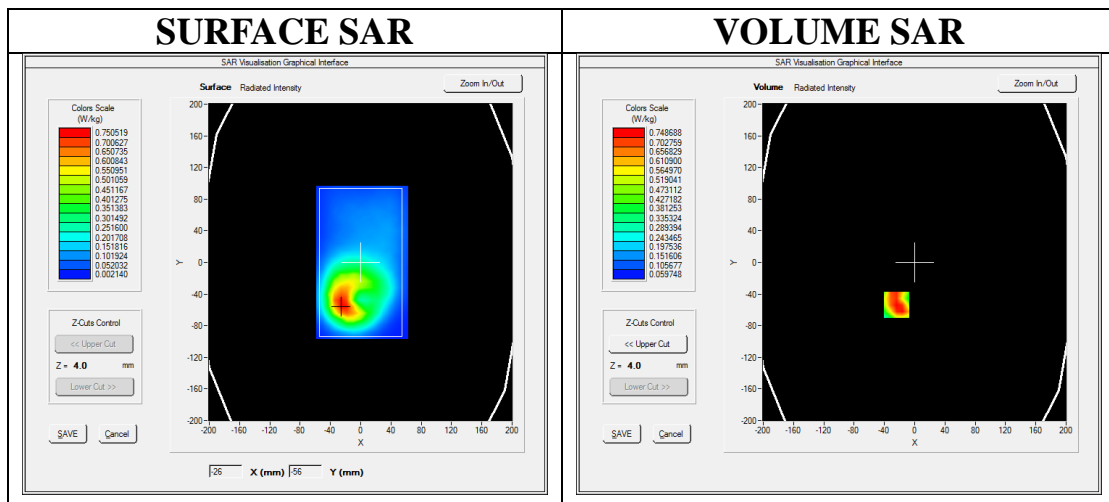

Maximum location: X=-24.00, Y=-54.00

SAR Peak: 1.07 W/kg

SAR 10g (W/Kg)	0.467368
SAR 1g (W/Kg)	0.733593

<b>Z (mm)</b>	<b>0.00</b>	<b>4.00</b>	<b>9.00</b>	<b>14.00</b>	<b>19.00</b>	<b>24.00</b>	<b>29.00</b>
<b>SAR (W/Kg)</b>	<b>1.0039</b>	<b>0.7487</b>	<b>0.5211</b>	<b>0.3934</b>	<b>0.2651</b>	<b>0.1956</b>	<b>0.1296</b>

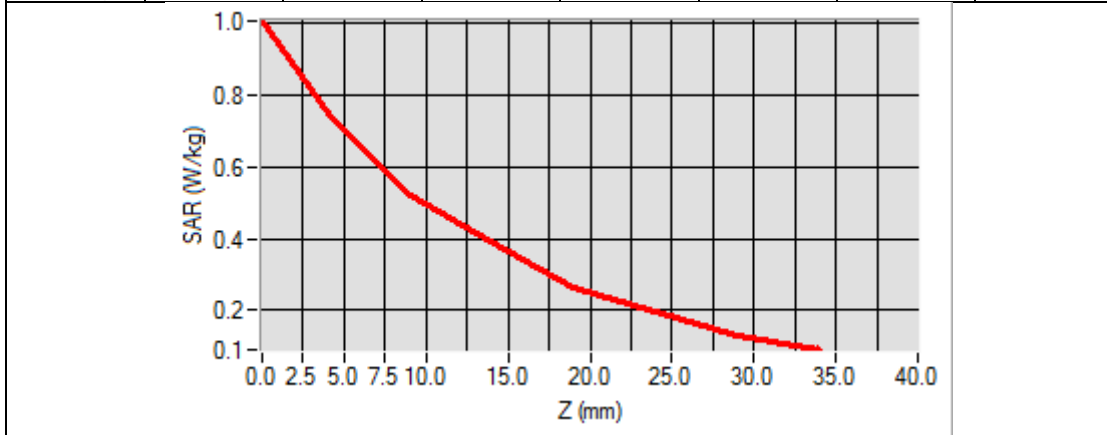

3D screen shot	Hot spot position
<p>A 3D perspective view of a white, shallow bowl. A blue grid is overlaid on the bottom surface of the bowl, indicating the location of the simulation or measurement area.</p>	<p>A vertical cross-sectional heatmap of the bowl. The color scale ranges from blue (low SAR) to red (high SAR). A prominent red/orange hot spot is visible at the bottom center of the bowl, corresponding to the location of the grid in the 3D model.</p>

Test Laboratory: AGC Lab  
PCS 1900 Mid-Touch-Right <SIM 1>  
DUT: Tablet; Type: TT-772

Date: Dec.29,2016

Communication System: Generic GSM; Communication System Band: PCS 1900; Duty Cycle: 1:8.3; Conv.F=5.14;  
Frequency: 1880 MHz; Medium parameters used:  $f = 1900$  MHz;  $\sigma = 1.38$  mho/m;  $\epsilon_r = 40.94$ ;  $\rho = 1000$  kg/m<sup>3</sup> ;  
Phantom section: Right Section  
Ambient temperature (°C): 22.5, Liquid temperature (°C): 21.8

SATIMO Configuration:

- Probe: SSE5; Calibrated: 07/05/2016 Serial No.: SN 14/16 EP307
- Sensor-Surface: 4mm (Mechanical Surface Detection)
- Phantom: SAM twin phantom
- Measurement SW: OpenSAR V4\_02\_35

Configuration/PCS1900 Mid-Touch-Right/Area Scan: Measurement grid: dx=8mm, dy=8mm

Configuration/PCS1900 Mid-Touch-Right/Zoom Scan: Measurement grid: dx=8mm, dy=8mm, dz=5mm;

Area Scan	sam_direct_droit2_surf8mm.txt
ZoomScan	5x5x7,dx=8mm dy=8mm dz=5mm,Complete
Phantom	Right head
Device Position	Cheek
Band	PCS 1900
Channels	Middle
Signal	TDMA (Crest factor: 8.0)

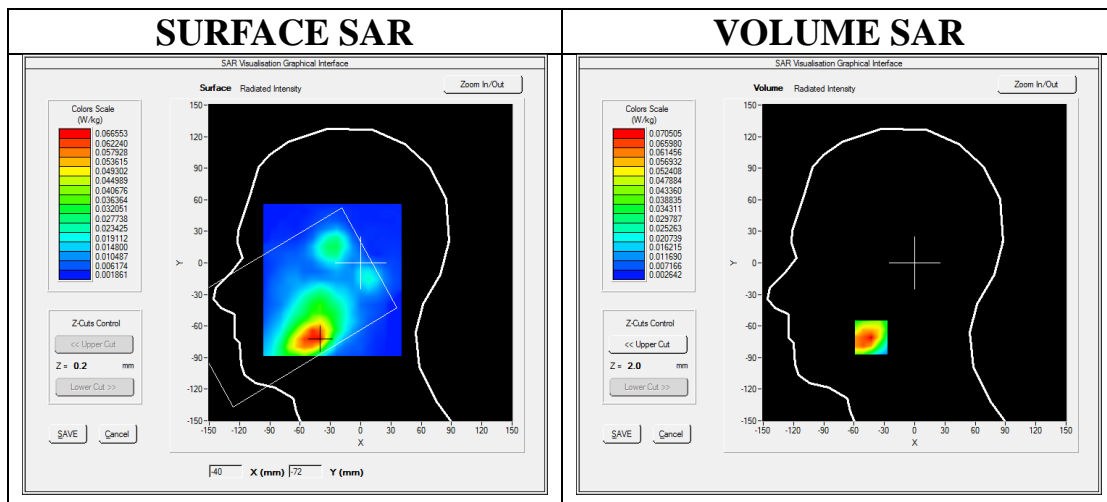

Maximum location: X=-42.00, Y=-71.00

SAR Peak: 0.11 W/kg

SAR 10g (W/Kg)	0.039429
SAR 1g (W/Kg)	0.067230



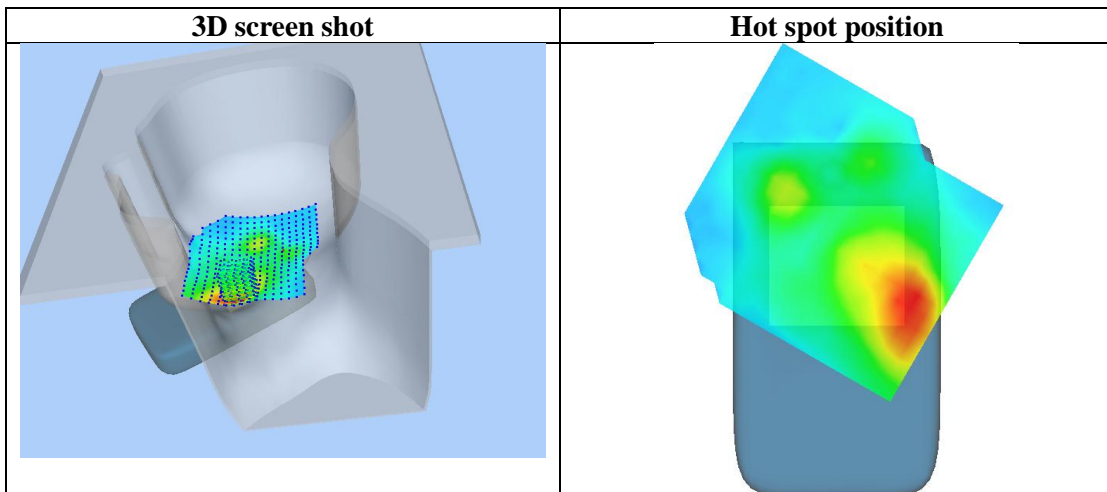
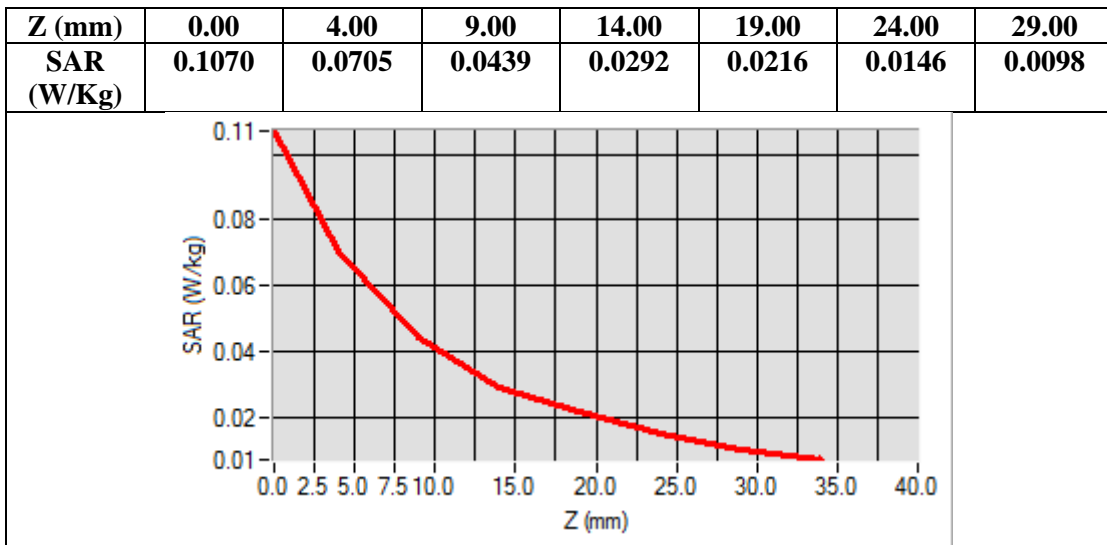

Test Laboratory: AGC Lab  
PCS 1900 Mid-Body-Back (MS)<SIM 1>  
DUT: Tablet; Type: TT-772

Date: Dec.29,2016

Communication System: Generic GSM; Communication System Band: PCS 1900; Duty Cycle: 1:8.3; Conv.F=5.34;  
Frequency: 1880 MHz; Medium parameters used:  $f = 1900$  MHz;  $\sigma = 1.48$  mho/m;  $\epsilon_r = 54.12$ ;  $\rho = 1000$  kg/m<sup>3</sup> ;  
Phantom section: Flat Section  
Ambient temperature (°C): 22.5, Liquid temperature (°C): 21.5

SATIMO Configuration:

- Probe: SSE5; Calibrated: 07/05/2016 Serial No.: SN 14/16 EP307
- Sensor-Surface: 4mm (Mechanical Surface Detection)
- Phantom: SAM twin phantom
- Measurement SW: OpenSAR V4\_02\_35

Configuration/PCS1900 Mid-Body-Back/Area Scan: Measurement grid: dx=8mm, dy=8mm  
Configuration/PCS1900 Mid-Body-Back/Zoom Scan: Measurement grid: dx=8mm,dy=8mm, dz=5mm;

Area Scan	surf_sam_plan.txt
ZoomScan	5x5x7,dx=8mm dy=8mm dz=5mm,Complete
Phantom	Validation plane
Device Position	Body Back
Band	PCS 1900
Channels	Middle
Signal	TDMA (Crest factor: 8.0)

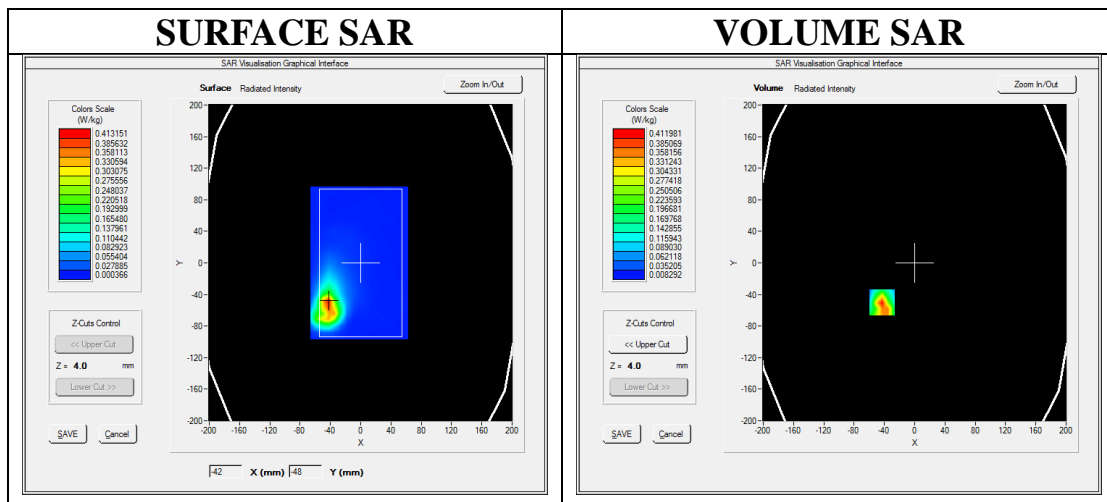

Maximum location: X=-43.00, Y=-50.00

SAR Peak: 0.66 W/kg

SAR 10g (W/Kg)	0.192486
SAR 1g (W/Kg)	0.377608

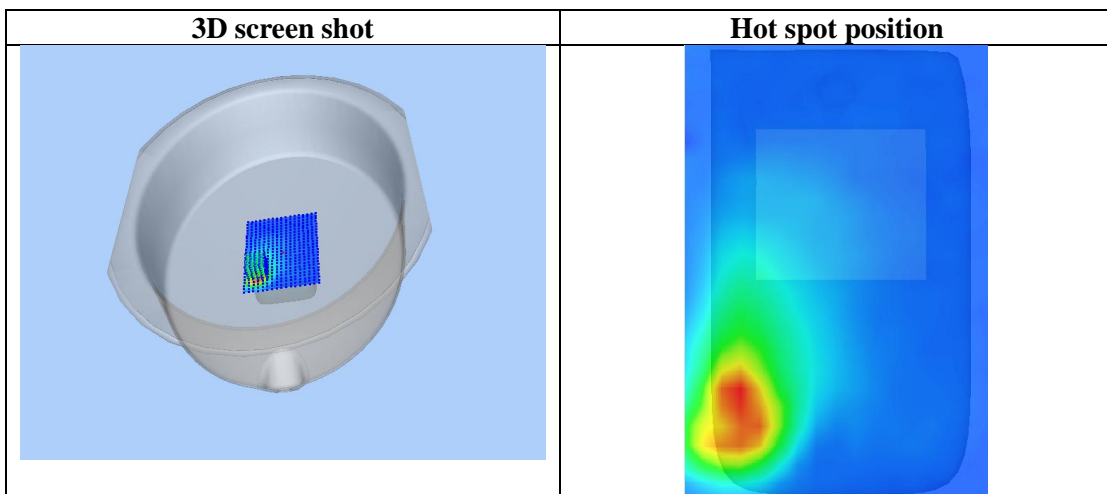
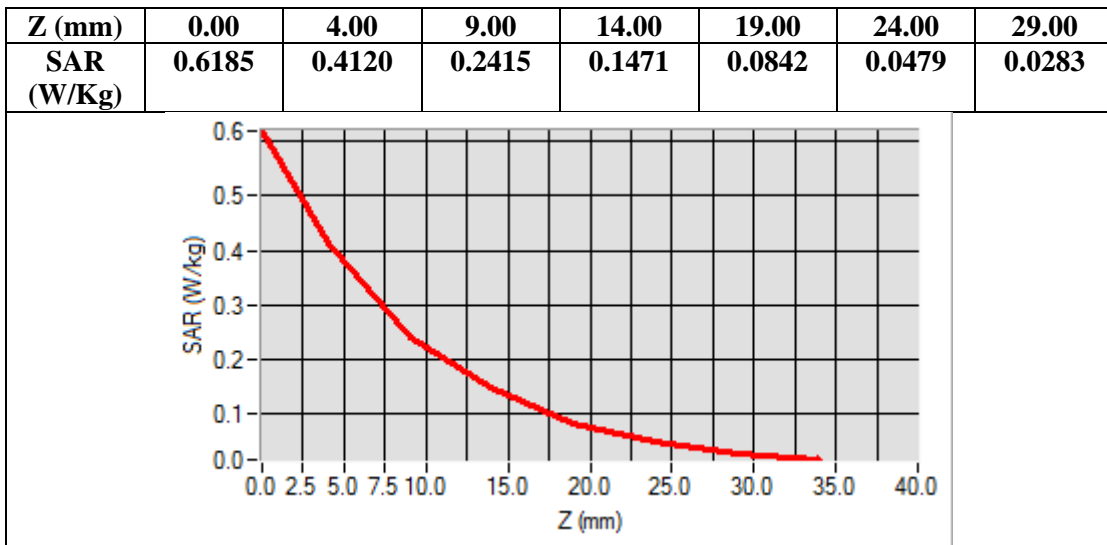

Test Laboratory: AGC Lab  
GPRS1900 Mid-Touch-Right (4up)  
DUT: Tablet; Type: TT-772

Date: Dec.29,2016

Communication System: GPRS-4Slot; Communication System Band: PCS 1900; Duty Cycle: 1:2.1; Conv.F=5.14;  
Frequency: 1880 MHz; Medium parameters used:  $f = 1900$  MHz;  $\sigma = 1.38$  mho/m;  $\epsilon_r = 40.94$ ;  $\rho = 1000$  kg/m<sup>3</sup> ;  
Phantom section: Right Section  
Ambient temperature (°C): 22.5, Liquid temperature (°C): 21.8

SATIMO Configuration:

- Probe: SSE5; Calibrated: 07/05/2016 Serial No.: SN 14/16 EP307
- Sensor-Surface: 4mm (Mechanical Surface Detection)
- Phantom: SAM twin phantom
- Measurement SW: OpenSAR V4\_02\_35

Configuration/GPRS1900 Mid-Touch-Right/Area Scan: Measurement grid: dx=8mm, dy=8mm

Configuration/GPRS1900 Mid-Touch-Right/Zoom Scan: Measurement grid: dx=8mm,dy=8mm, dz=5mm;

Area Scan	sam_direct_droit2_surf8mm.txt
Zoom Scan	5x5x7,dx=8mm dy=8mm dz=5mm,Complete
Phantom	Right head
Device Position	Cheek
Band	PCS 1900
Channels	Middle
Signal	TDMA (Crest factor: 2.0)

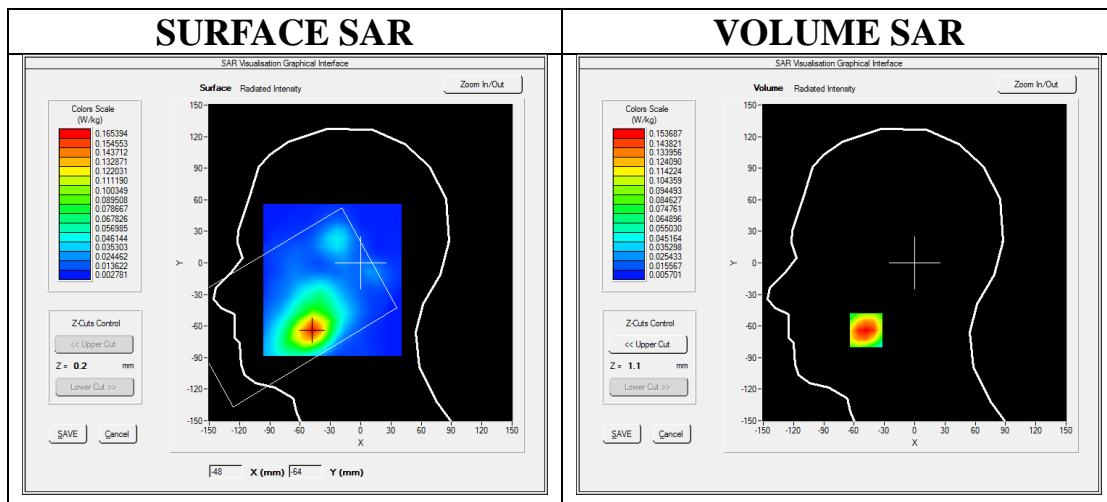

Maximum location: X=-48.00, Y=-64.00

SAR Peak: 0.23 W/kg

SAR 10g (W/Kg)	0.087904
SAR 1g (W/Kg)	0.146430

Z (mm)	0.00	4.00	9.00	14.00	19.00	24.00	29.00
SAR (W/Kg)	0.2095	0.1537	0.1024	0.0667	0.0445	0.0305	0.0214

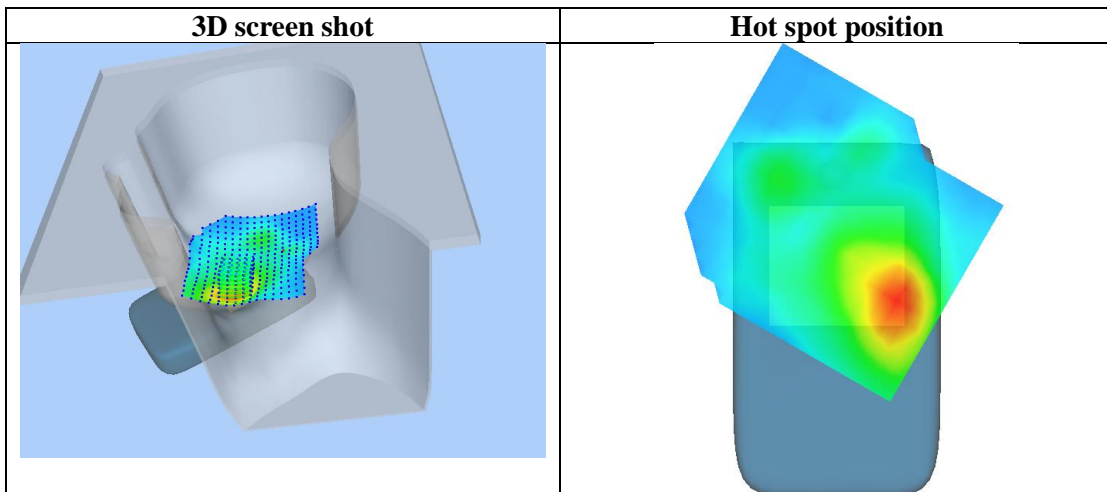
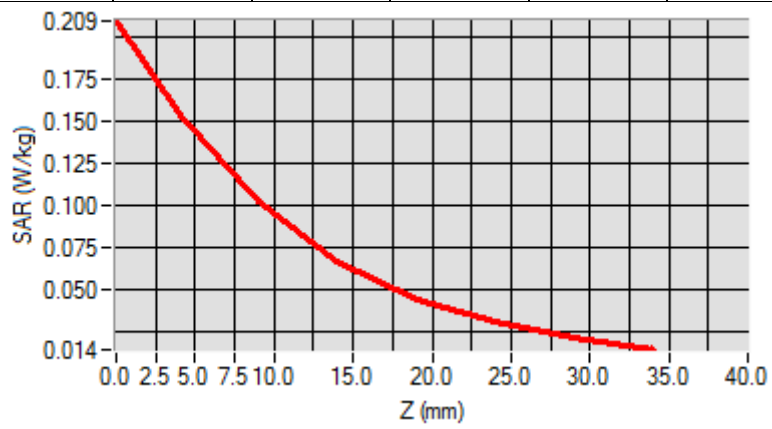

Test Laboratory: AGC Lab  
GPRS 1900 Mid-Body-Back (4up)  
DUT: Tablet; Type: TT-772

Date: Dec.29,2016

Communication System: GPRS-4Slot; Communication System Band: PCS 1900; Duty Cycle: 1:2.1; Conv.F=5.34;  
Frequency: 1880 MHz; Medium parameters used:  $f = 1900$  MHz;  $\sigma = 1.48$  mho/m;  $\epsilon_r = 54.12$ ;  $\rho = 1000$  kg/m<sup>3</sup> ;  
Phantom section: Flat Section  
Ambient temperature (°C): 22.5, Liquid temperature (°C): 21.5

SATIMO Configuration:

- Probe: SSE5; Calibrated: 07/05/2016 Serial No.: SN 14/16 EP307
- Sensor-Surface: 4mm (Mechanical Surface Detection)
- Phantom: SAM twin phantom
- Measurement SW: OpenSAR V4\_02\_35

Configuration/GPRS1900 Mid-Body-Back/Area Scan: Measurement grid: dx=8mm, dy=8mm

Configuration/GPRS1900 Mid-Body-Back/Zoom Scan: Measurement grid: dx=8mm,dy=8mm, dz=5mm;

Area Scan	surf_sam_plan.txt
Zoom Scan	5x5x7,dx=8mm dy=8mm dz=5mm,Complete
Phantom	Validation plane
Device Position	Body Back
Band	PCS 1900
Channels	Middle
Signal	TDMA (Crest factor: 2.0)

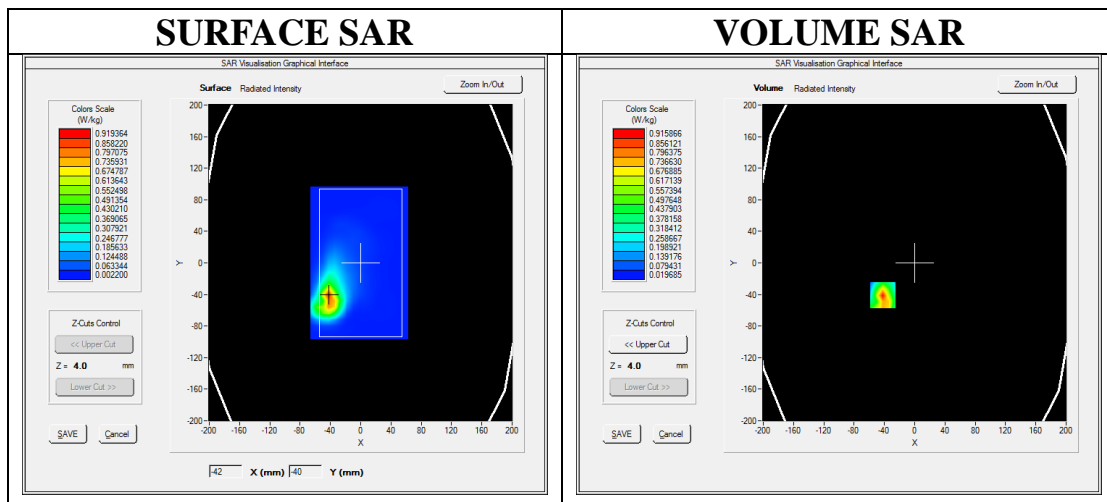

Maximum location: X=-42.00, Y=-41.00

SAR Peak: 1.40 W/kg

SAR 10g (W/Kg)	0.420934
SAR 1g (W/Kg)	0.815385

Z (mm)	0.00	4.00	9.00	14.00	19.00	24.00	29.00
SAR (W/Kg)	1.4042	0.9159	0.5286	0.3109	0.1849	0.1061	0.0607

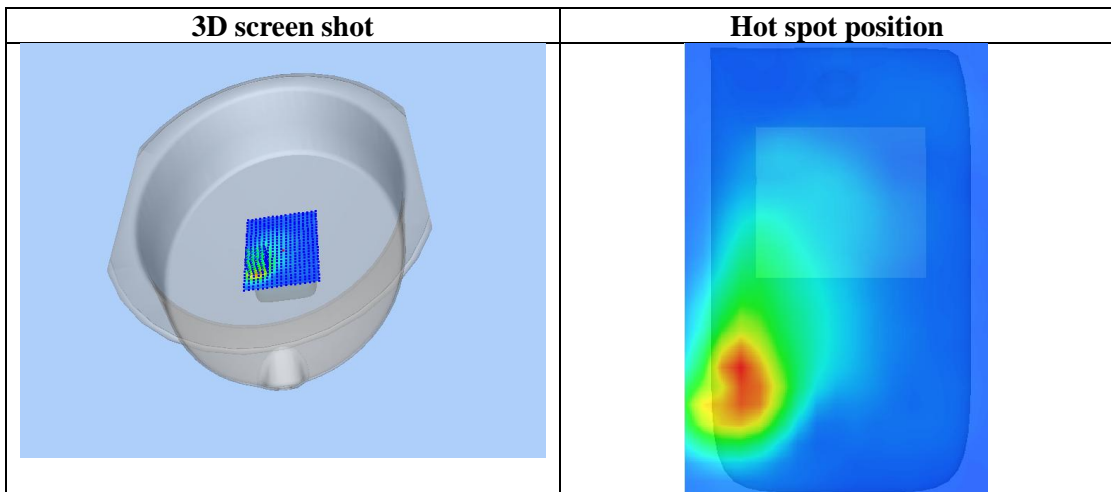
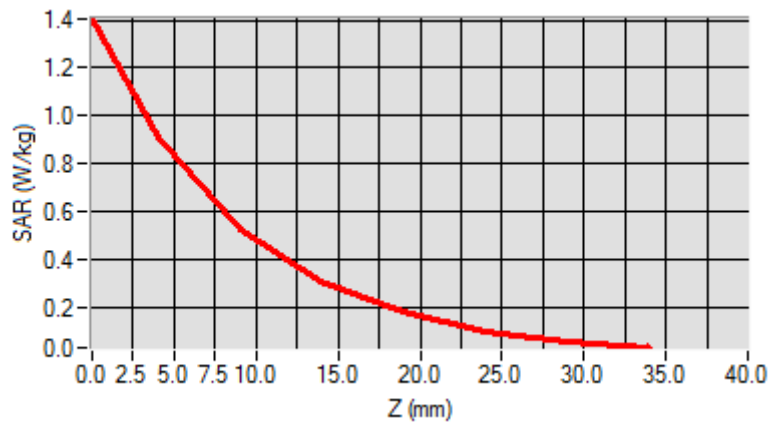

Test Laboratory: AGC Lab  
GPRS 1900 Mid-Body-Back (4up)-SIM2  
DUT: Tablet; Type: TT-772

Date: Dec.29,2016

Communication System: GPRS-4Slot; Communication System Band: PCS 1900; Duty Cycle: 1:2.1; Conv.F=5.34;  
Frequency: 1880 MHz; Medium parameters used:  $f = 1900$  MHz;  $\sigma = 1.48$  mho/m;  $\epsilon_r = 54.12$ ;  $\rho = 1000$  kg/m<sup>3</sup> ;  
Phantom section: Flat Section  
Ambient temperature (°C): 22.5, Liquid temperature (°C): 21.5

SATIMO Configuration:

- Probe: SSE5; Calibrated: 07/05/2016 Serial No.: SN 14/16 EP307
- Sensor-Surface: 4mm (Mechanical Surface Detection)
- Phantom: SAM twin phantom
- Measurement SW: OpenSAR V4\_02\_35

Configuration/GPRS1900 Mid-Body-Back/Area Scan: Measurement grid: dx=8mm, dy=8mm  
Configuration/GPRS1900 Mid-Body-Back/Zoom Scan: Measurement grid: dx=8mm, dy=8mm, dz=5mm;

Area Scan	surf_sam_plan.txt
Zoom Scan	5x5x7,dx=8mm dy=8mm dz=5mm,Complete
Phantom	Validation plane
Device Position	Body Back
Band	PCS 1900
Channels	Middle
Signal	TDMA (Crest factor: 2.0)

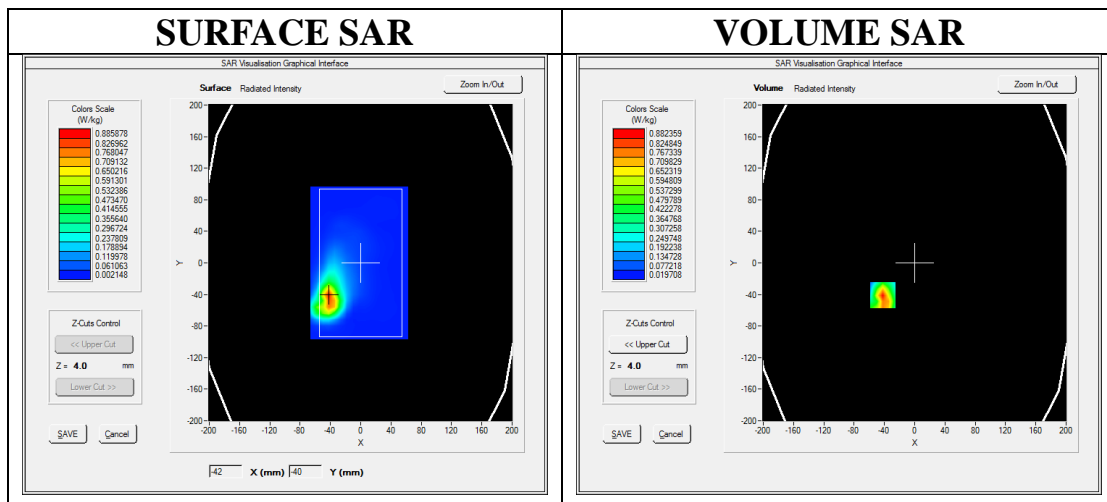

Maximum location: X=-42.00, Y=-41.00  
SAR Peak: 1.31 W/kg

SAR 10g (W/Kg)	0.420251
SAR 1g (W/Kg)	0.797105



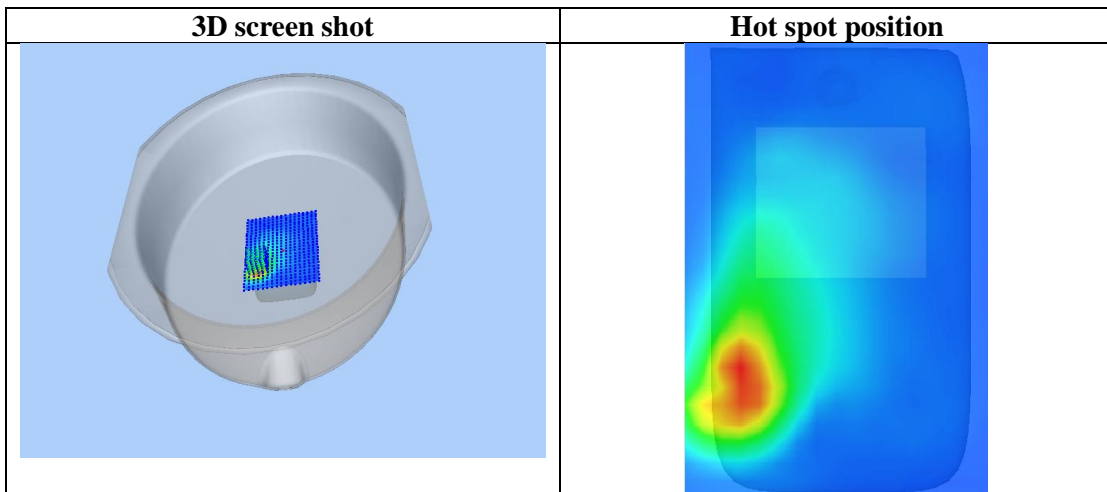
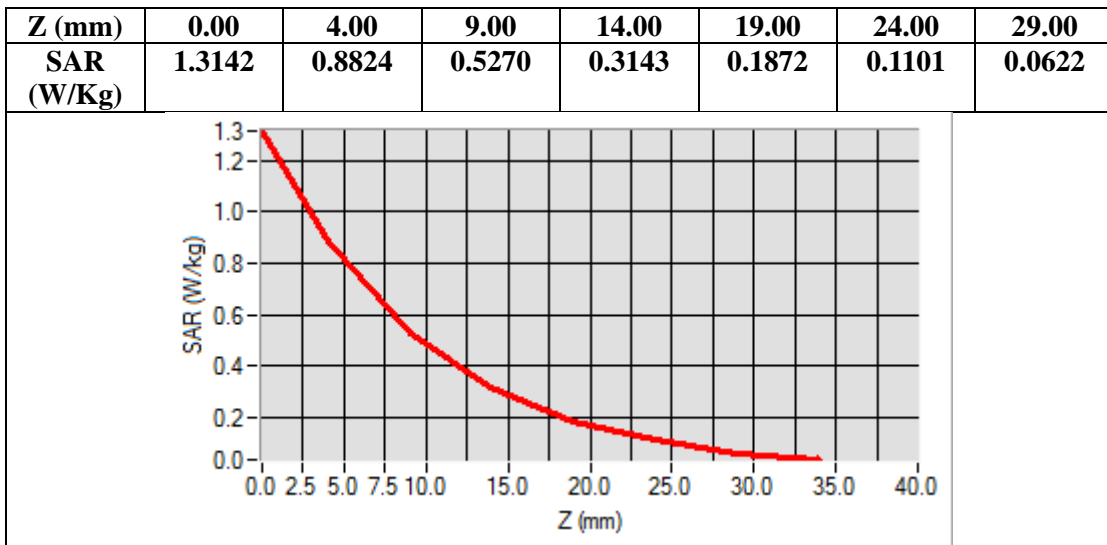

Test Laboratory: AGC Lab

Date: Dec.27,2016

WCDMA Band V Mid-Touch-Right (RMC)

DUT: Tablet; Type: TT-772

Communication System: UMTS; Communication System Band: BAND V UTRA/FDD ; Duty Cycle:1: 1; Conv.F=5.67;  
Frequency: 836.6 MHz; Medium parameters used:  $f = 835\text{MHz}$ ;  $\sigma = 0.91\text{ mho/m}$ ;  $\epsilon_r = 41.31$ ;  $\rho = 1000\text{ kg/m}^3$  ;  
Phantom section: Right Section  
Ambient temperature ( $^{\circ}\text{C}$ ): 21.8, Liquid temperature ( $^{\circ}\text{C}$ ): 20.9

SATIMO Configuration:

- Probe: SSE5; Calibrated: 07/05/2016 Serial No.: SN 14/16 EP307
- Sensor-Surface: 4mm (Mechanical Surface Detection)
- Phantom: SAM twin phantom
- Measurement SW: OpenSAR V4\_02\_35

Configuration/ WCDMA Band V Mid-Touch-Right/Area Scan: Measurement grid:  $dx=8\text{mm}$ ,  $dy=8\text{mm}$

Configuration/ WCDMA Band V Mid-Touch-Right/Zoom Scan: Measurement grid:  $dx=8\text{mm}$ ,  $dy=8\text{mm}$ ,  $dz=5\text{mm}$ ;

<b>Area Scan</b>	sam_direct_droit2_surf8mm.txt
<b>ZoomScan</b>	5x5x7,dx=8mm dy=8mm dz=5mm,Complete
<b>Phantom</b>	Right head
<b>Device Position</b>	Cheek
<b>Band</b>	WCDMA Band V
<b>Channels</b>	Middle
<b>Signal</b>	CDMA (Crest factor: 1.0)

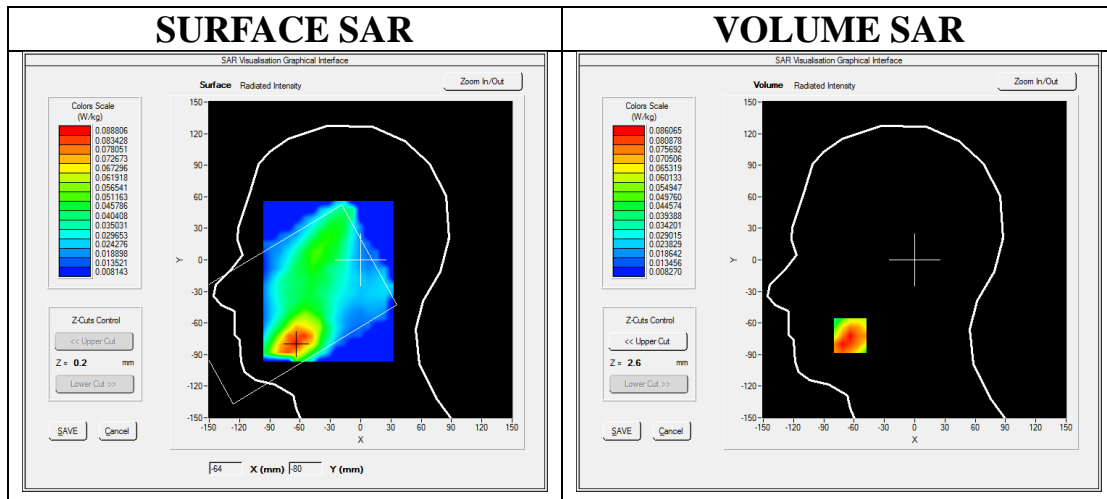

Maximum location:  $X=-64.00$ ,  $Y=-72.00$

SAR Peak: 0.12 W/kg

<b>SAR 10g (W/Kg)</b>	0.057729
<b>SAR 1g (W/Kg)</b>	0.083935

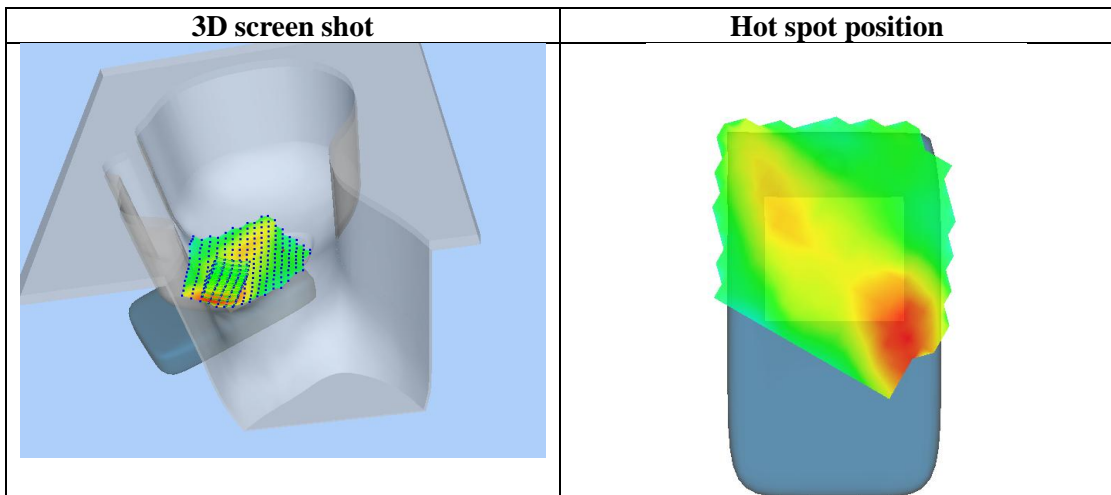
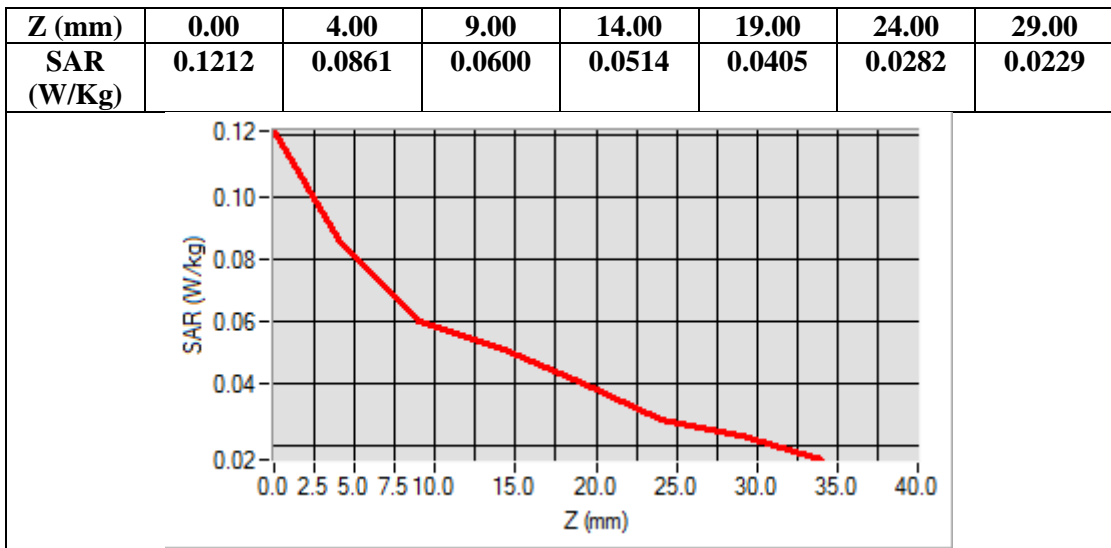

Test Laboratory: AGC Lab

Date: Dec.27,2016

WCDMA Band V Mid-Body-Towards Grounds (RMC)

DUT: Tablet; Type: TT-772

Communication System: UMTS; Communication System Band: BAND V UTRA/FDD; Duty Cycle:1: 1; Conv.F=5.89; Frequency: 836.6 MHz; Medium parameters used:  $f = 835\text{MHz}$ ;  $\sigma = 0.95\text{ mho/m}$ ;  $\epsilon_r = 55.12$ ;  $\rho = 1000\text{ kg/m}^3$ ; Phantom section: Flat Section  
Ambient temperature ( $^{\circ}\text{C}$ ): 21.8, Liquid temperature ( $^{\circ}\text{C}$ ): 21.1

SATIMO Configuration:

- Probe: SSE5; Calibrated: 07/05/2016 Serial No.: SN 14/16 EP307
- Sensor-Surface: 4mm (Mechanical Surface Detection)
- Phantom: SAM twin phantom
- Measurement SW: OpenSAR V4\_02\_35

Configuration/ WCDMA Band V Mid-Body-Back/Area Scan: Measurement grid:  $dx=8\text{mm}$ ,  $dy=8\text{mm}$

Configuration/ WCDMA Band V Mid-Body-Back/Zoom Scan: Measurement grid:  $dx=8\text{mm}$ ,  $dy=8\text{mm}$ ,  $dz=5\text{mm}$ ;

Area Scan	surf_sam_plan.txt
ZoomScan	5x5x7,dx=8mm dy=8mm dz=5mm,Complete
Phantom	Validation plane
Device Position	Body Back
Band	WCDMA Band V
Channels	Middle
Signal	CDMA (Crest factor: 1.0)

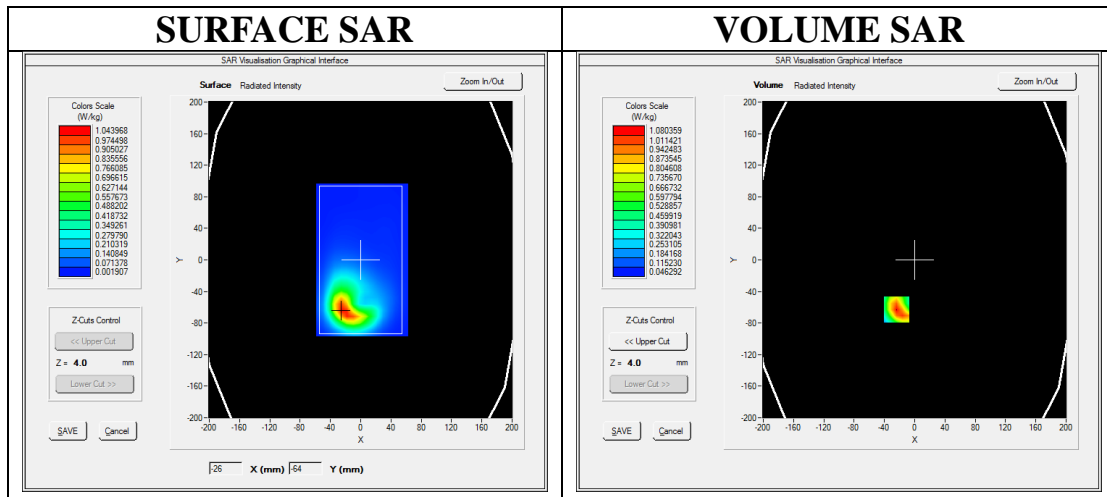

Maximum location: X=-24.00, Y=-63.00

SAR Peak: 1.64 W/kg

SAR 10g (W/Kg)	0.577017
SAR 1g (W/Kg)	1.024526

<b>Z (mm)</b>	<b>0.00</b>	<b>4.00</b>	<b>9.00</b>	<b>14.00</b>	<b>19.00</b>	<b>24.00</b>	<b>29.00</b>
<b>SAR (W/Kg)</b>	<b>1.6343</b>	<b>1.0804</b>	<b>0.6437</b>	<b>0.4056</b>	<b>0.2607</b>	<b>0.1720</b>	<b>0.1148</b>

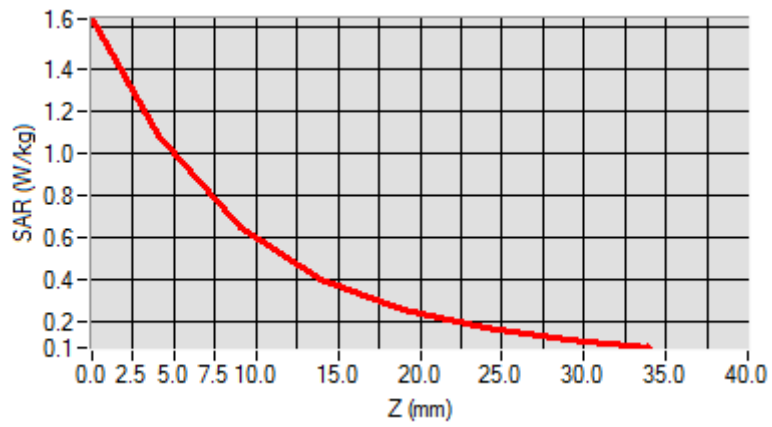

3D screen shot	Hot spot position
<p>A 3D perspective view of a white, shallow bowl. A blue grid of points is overlaid on the bottom surface of the bowl, representing the simulation domain.</p>	<p>A vertical cross-section heatmap of the bowl. The color scale ranges from blue (low SAR) to red (high SAR). A prominent red hot spot is located in the center of the bowl's base, with a yellow and green gradient extending outwards.</p>

Test Laboratory: AGC Lab  
WCDMA Band II Mid-Touch-Right (RMC)  
DUT: Tablet; Type: TT-772

Date: Dec.29,2016

Communication System: UMTS; Communication System Band: Band II UTRA/FDD ;Duty Cycle:1:1; Conv.F=5.14;  
Frequency: 1880 MHz; Medium parameters used:  $f = 1900$  MHz;  $\sigma = 1.38$  mho/m;  $\epsilon_r = 40.94$ ;  $\rho = 1000$  kg/m<sup>3</sup> ;  
Phantom section: Right Section  
Ambient temperature (°C): 22.5, Liquid temperature (°C): 21.8

SATIMO Configuration:

- Probe: SSE5; Calibrated: 07/05/2016 Serial No.: SN 14/16 EP307
- Sensor-Surface: 4mm (Mechanical Surface Detection)
- Phantom: SAM twin phantom
- Measurement SW: OpenSAR V4\_02\_35

Configuration/WCDMA band II Mid-Touch-Right/Area Scan: Measurement grid: dx=8mm, dy=8mm

Configuration/WCDMA band II Mid-Touch-Right/Zoom Scan: Measurement grid: dx=8mm,dy=8mm, dz=5mm;

<b>Area Scan</b>	sam_direct_droit2_surf8mm.txt
<b>ZoomScan</b>	5x5x7,dx=8mm dy=8mm dz=5mm,Complete
<b>Phantom</b>	Right head
<b>Device Position</b>	Cheek
<b>Band</b>	WCDMA band II
<b>Channels</b>	Middle
<b>Signal</b>	CDMA (Crest factor: 1.0)

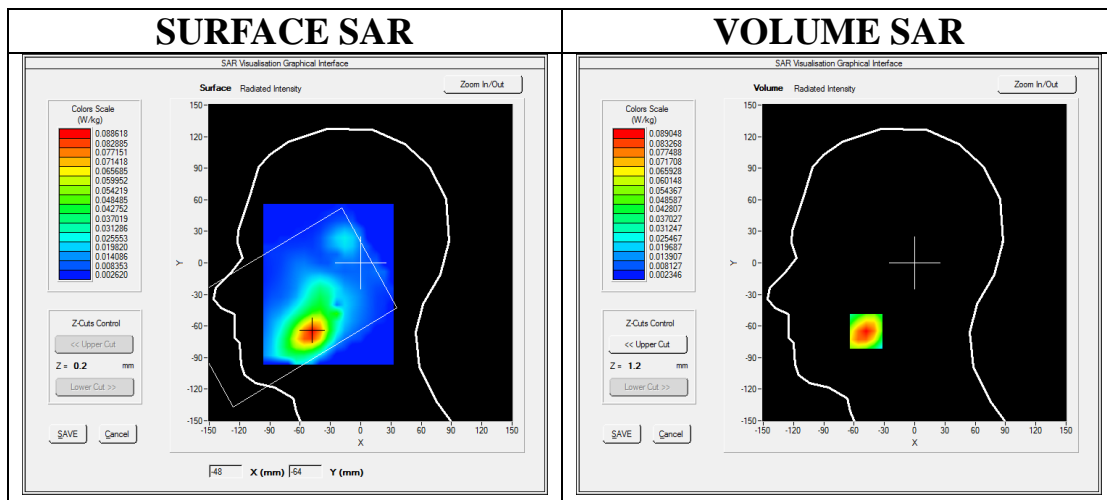

**Maximum location: X=-48.00, Y=-65.00**

**SAR Peak: 0.15 W/kg**

<b>SAR 10g (W/Kg)</b>	0.042316
<b>SAR 1g (W/Kg)</b>	0.085202

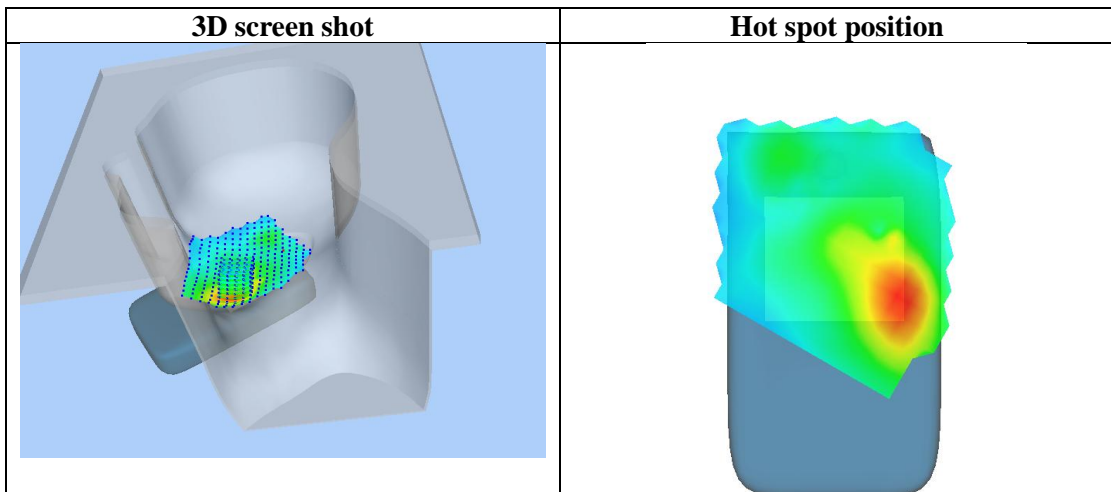
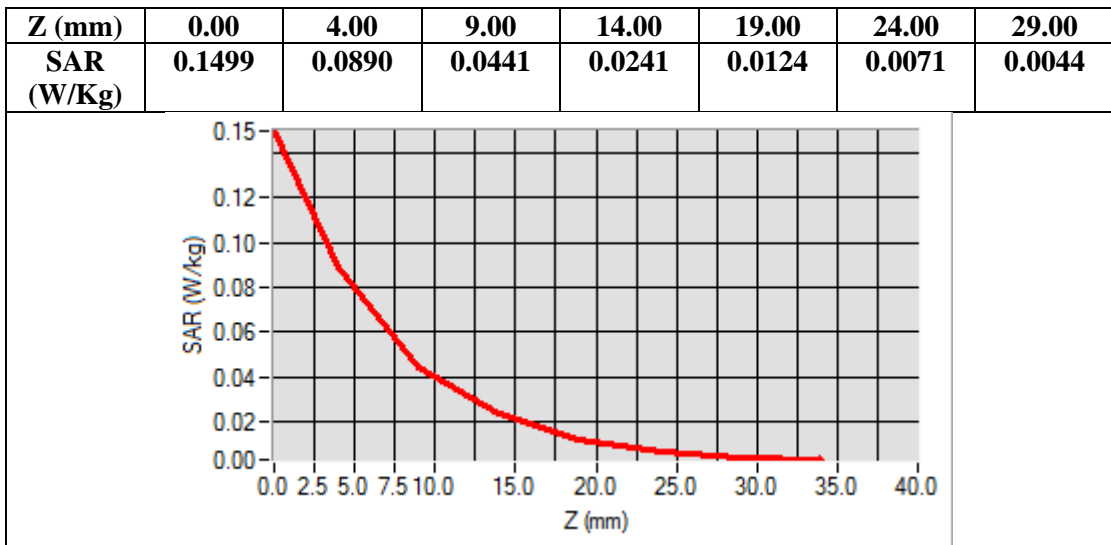

**Test Laboratory: AGC Lab**  
**WCDMA Band II Mid-Body-Towards Grounds (RMC 12.2kbps)**  
**DUT: Tablet; Type: TT-772**

**Date: Dec.29,2016**

Communication System: UMTS; Communication System Band: Band II UTRA/FDD ;Duty Cycle:1:1; Conv.F=5.34;  
Frequency: 1880 MHz; Medium parameters used:  $f = 1900$  MHz;  $\sigma=1.48$  mho/m;  $\epsilon_r=54.12$ ;  $\rho= 1000$  kg/m<sup>3</sup> ;  
Phantom section: Flat Section  
Ambient temperature (°C): 22.5, Liquid temperature (°C): 21.5

SATIMO Configuration:

- Probe: SSE5; Calibrated: 07/05/2016 Serial No.: SN 14/16 EP307
- Sensor-Surface: 4mm (Mechanical Surface Detection)
- Phantom: SAM twin phantom
- Measurement SW: OpenSAR V4\_02\_35

**Configuration/ WCDMA band II Mid-Body-back/Area Scan:** Measurement grid: dx=8mm, dy=8mm

**Configuration/ WCDMA band II Mid-Body-back/Zoom Scan:** Measurement grid: dx=8mm,dy=8mm, dz=5mm;

<b>Area Scan</b>	surf_sam_plan.txt
<b>ZoomScan</b>	5x5x7,dx=8mm dy=8mm dz=5mm,Complete
<b>Phantom</b>	Validation plane
<b>Device Position</b>	Body Back
<b>Band</b>	WCDMA band II
<b>Channels</b>	Middle
<b>Signal</b>	CDMA (Crest factor: 1.0)

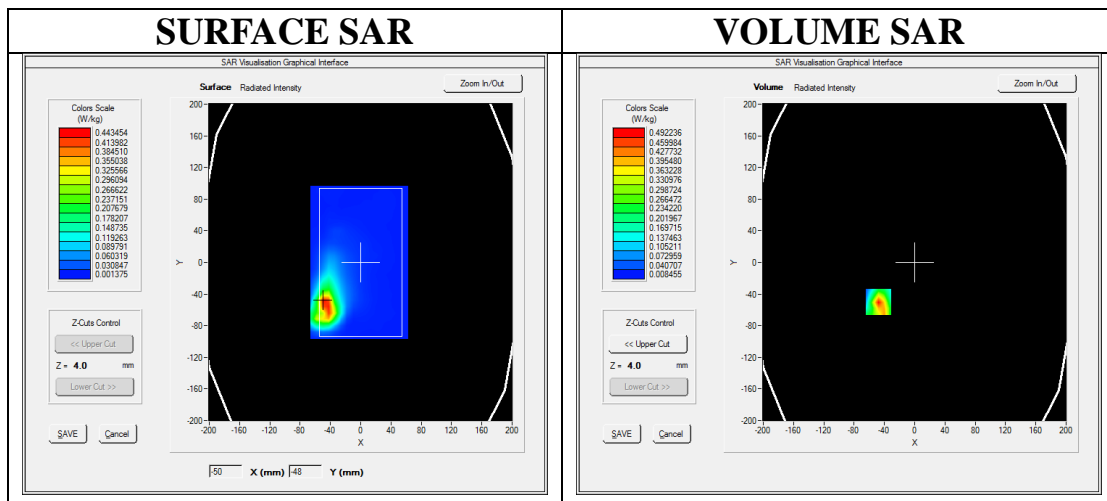

**Maximum location: X=-48.00, Y=-50.00**

**SAR Peak: 0.73 W/kg**

<b>SAR 10g (W/Kg)</b>	0.224636
<b>SAR 1g (W/Kg)</b>	0.440079



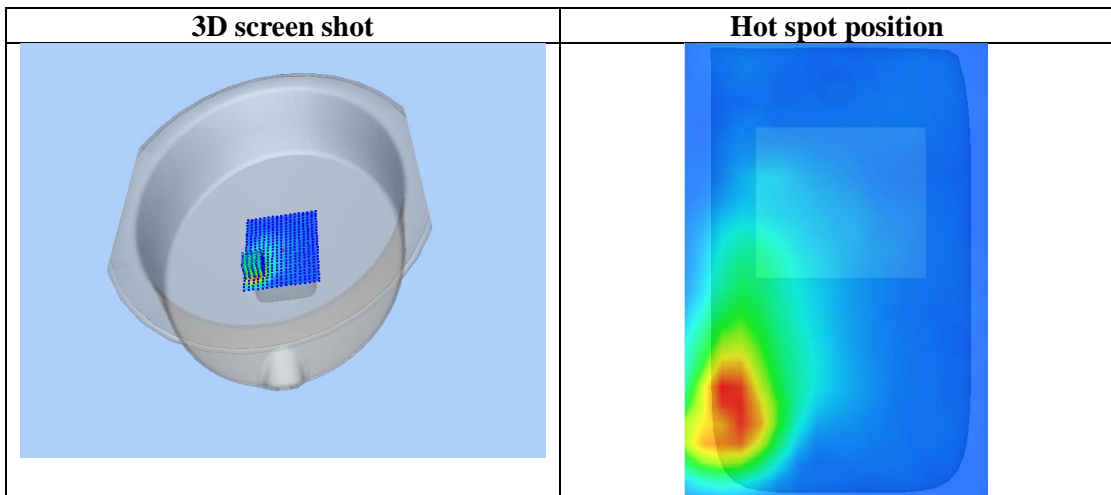
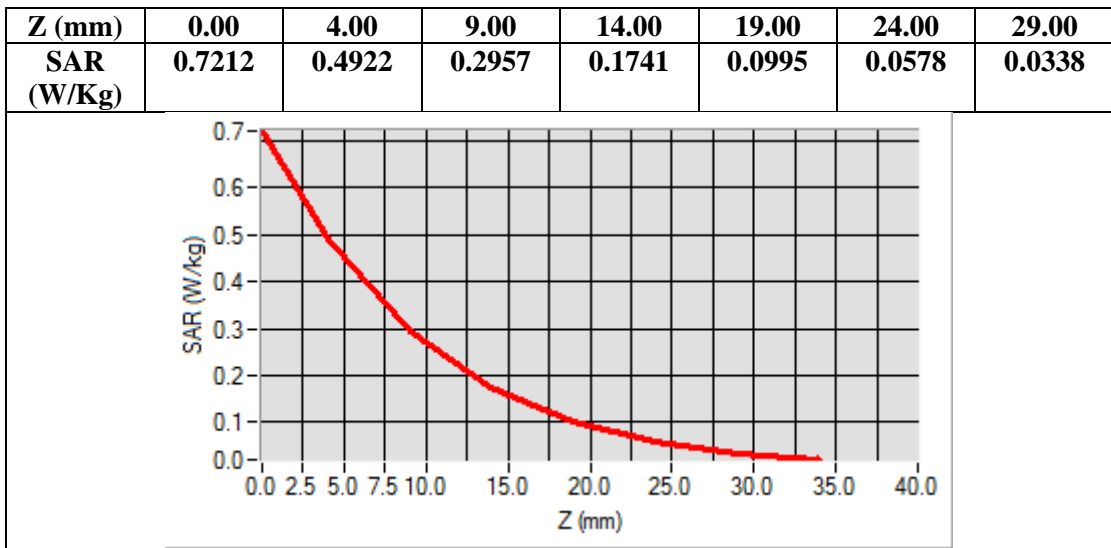

**WIFI MODE**

Test Laboratory: AGC Lab  
802.11b Mid- Touch-Right  
DUT: Tablet; Type: TT-772

Date: Jan.05,2017

Communication System: Wi-Fi; Communication System Band: 802.11b; Duty Cycle: 1:1; Conv.F=5.07;  
Frequency: 2437 MHz; Medium parameters used:  $f = 2450$  MHz;  $\sigma = 1.81$  mho/m;  $\epsilon_r = 39.85$ ;  $\rho = 1000$  kg/m<sup>3</sup> ;  
Phantom section: Right Section  
Ambient temperature (°C):22.3, Liquid temperature (°C): 21.8

SATIMO Configuration:

- Probe: SSE5; Calibrated: 07/05/2016 Serial No.: SN 14/16 EP307
- Sensor-Surface: 4mm (Mechanical Surface Detection)
- Phantom: SAM twin phantom
- Measurement SW: OpenSAR V4\_02\_35

Configuration/802.11b Mid- Touch-Right /Area Scan: Measurement grid: dx=8mm, dy=8mm  
Configuration/802.11b Mid- Touch-Right /Zoom Scan: Measurement grid: dx=5mm,dy=5mm, dz=5mm;

<b>Area Scan</b>	sam_direct_droit2_surf8mm.txt
<b>ZoomScan</b>	7x7x7,dx=5mm dy=5mm dz=5mm
<b>Phantom</b>	Right head
<b>Device Position</b>	Cheek
<b>Band</b>	2450MHz
<b>Channels</b>	Middle
<b>Signal</b>	Crest factor: 1.0

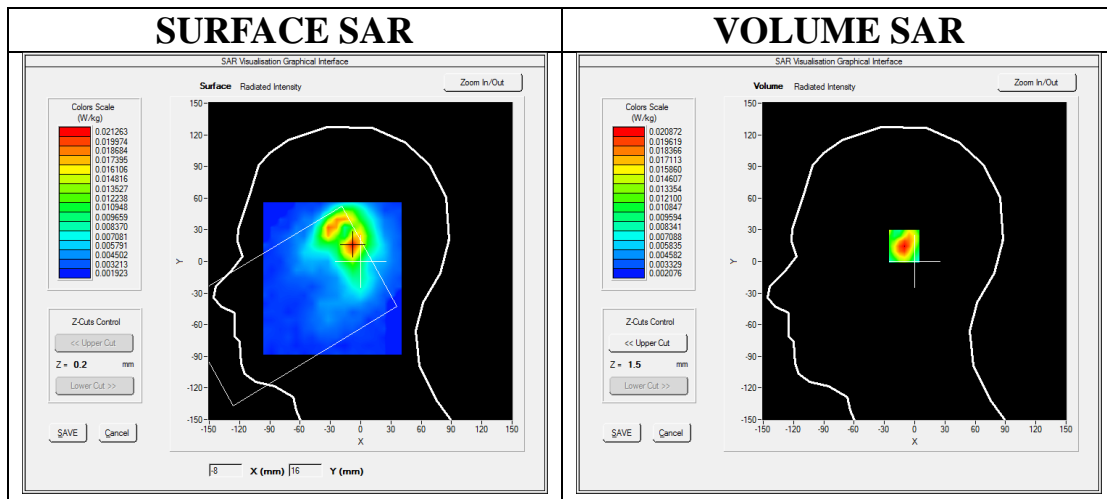

**Maximum location: X=-8.00, Y=15.00**

**SAR Peak: 0.03 W/kg**

<b>SAR 10g (W/Kg)</b>	0.010380
<b>SAR 1g (W/Kg)</b>	0.019455

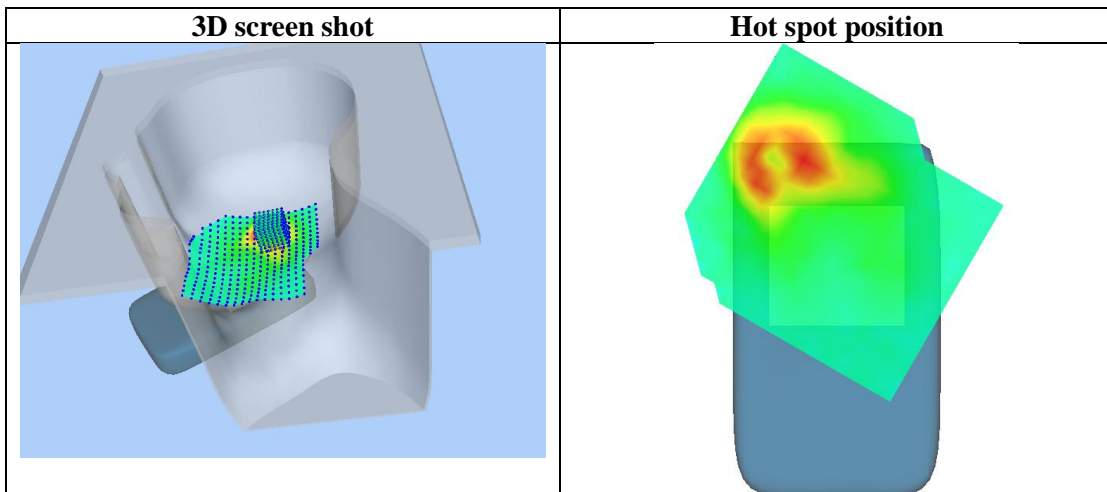
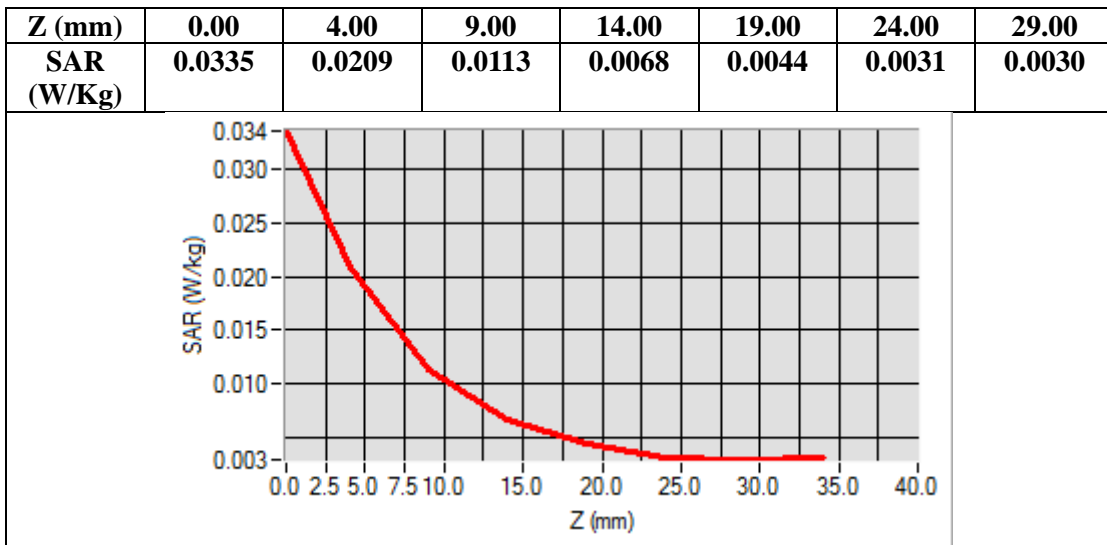

**Test Laboratory: AGC Lab**  
**802.11b Mid-Body-Worn- Back (DTS)**  
**DUT: Tablet; Type: TT-772**

**Date: Jan.05,2017**

Communication System: Wi-Fi; Communication System Band: 802.11b; Duty Cycle: 1:1; Conv.F=5.19;  
Frequency: 2437 MHz; Medium parameters used:  $f = 2450$  MHz;  $\sigma = 1.94$  mho/m;  $\epsilon_r = 53.63$ ;  $\rho = 1000$  kg/m<sup>3</sup> ;  
Phantom section: Flat Section  
Ambient temperature (°C):22.3, Liquid temperature (°C): 21.5

**SATIMO Configuration:**

- Probe: SSE5; Calibrated: 07/05/2016 Serial No.: SN 14/16 EP307
- Sensor-Surface: 4mm (Mechanical Surface Detection)
- Phantom: SAM twin phantom
- Measurement SW: OpenSAR V4\_02\_35

**Configuration/802.11b Mid- Body- Back /Area Scan:** Measurement grid: dx=8mm, dy=8mm  
**Configuration/802.11b Mid- Body- Back /Zoom Scan:** Measurement grid: dx=5mm,dy=5mm, dz=5mm;

<b>Area Scan</b>	surf_sam_plan.txt
<b>ZoomScan</b>	7x7x7,dx=5mm dy=5mm dz=5mm
<b>Phantom</b>	Validation plane
<b>Device Position</b>	Body Back
<b>Band</b>	2450MHz
<b>Channels</b>	Middle
<b>Signal</b>	Crest factor: 1.0

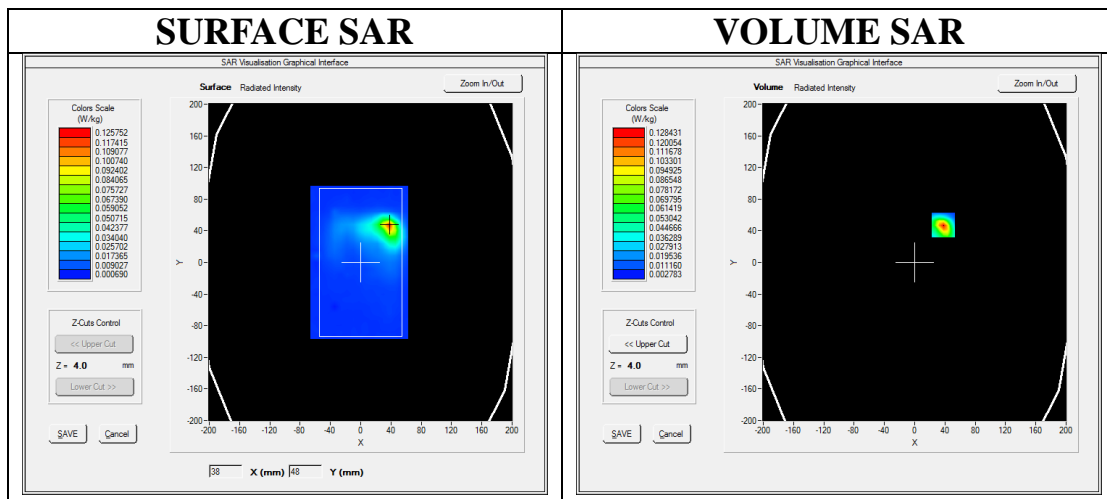

**Maximum location: X=38.00, Y=47.00**

**SAR Peak: 0.28 W/kg**

<b>SAR 10g (W/Kg)</b>	0.041701
<b>SAR 1g (W/Kg)</b>	0.115437

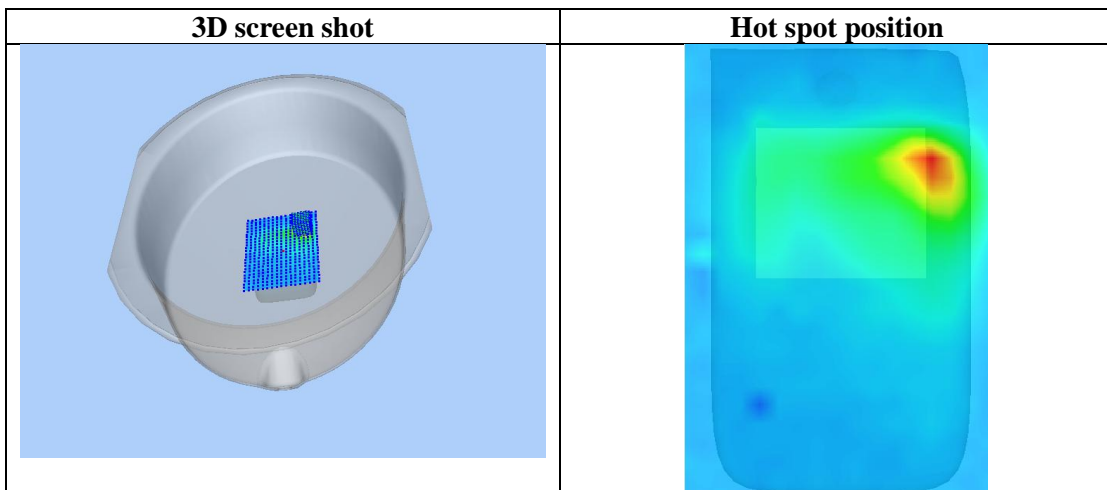
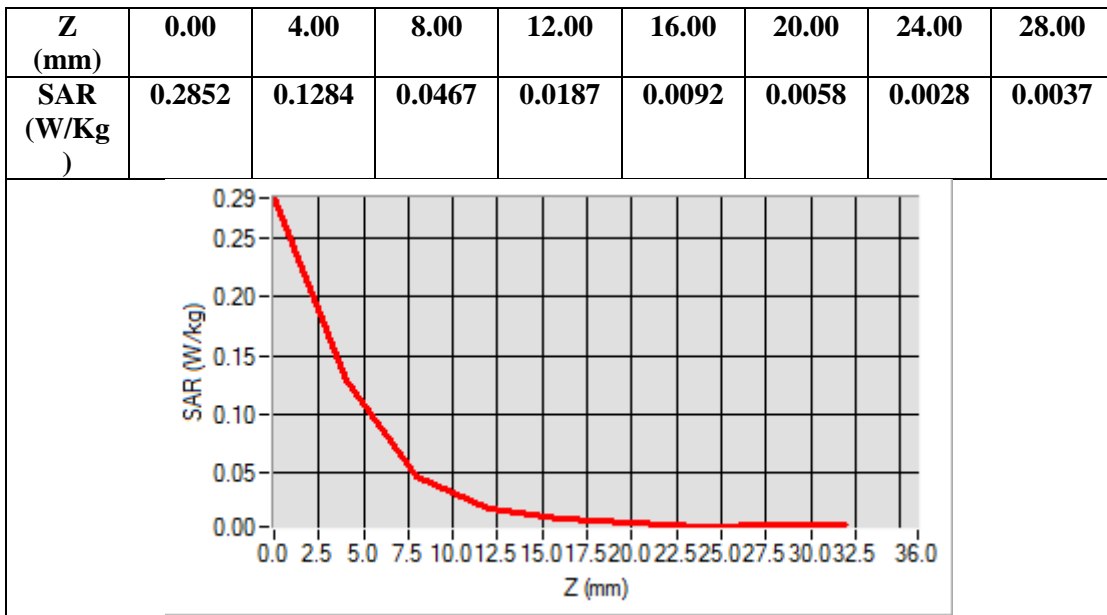

Repeated

Test Laboratory: AGC Lab  
GPRS 1900 Mid-Body-Back (4up)  
DUT: Tablet; Type: TT-772

Date: Dec.29,2016

Communication System: GPRS-4Slot; Communication System Band: PCS 1900; Duty Cycle: 1:2.1; Conv.F=5.34;  
Frequency: 1880 MHz; Medium parameters used:  $f = 1900$  MHz;  $\sigma = 1.48$  mho/m;  $\epsilon_r = 54.12$ ;  $\rho = 1000$  kg/m<sup>3</sup> ;  
Phantom section: Flat Section  
Ambient temperature (°C): 22.5, Liquid temperature (°C): 21.5

SATIMO Configuration:

- Probe: SSE5; Calibrated: 07/05/2016 Serial No.: SN 14/16 EP307
- Sensor-Surface: 4mm (Mechanical Surface Detection)
- Phantom: SAM twin phantom
- Measurement SW: OpenSAR V4\_02\_35

Configuration/GPRS1900 Mid-Body-Back/Area Scan: Measurement grid: dx=8mm, dy=8mm

Configuration/GPRS1900 Mid-Body-Back/Zoom Scan: Measurement grid: dx=8mm,dy=8mm, dz=5mm;

Area Scan	surf_sam_plan.txt
Zoom Scan	5x5x7,dx=8mm dy=8mm dz=5mm,Complete
Phantom	Validation plane
Device Position	Body Back
Band	PCS 1900
Channels	Middle
Signal	TDMA (Crest factor: 2.0)

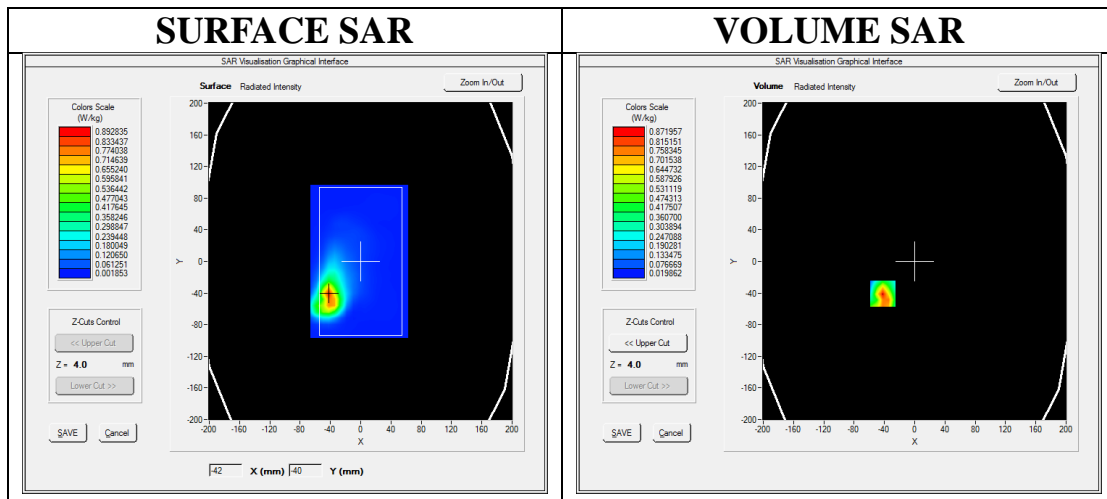

Maximum location: X=-42.00, Y=-41.00

SAR Peak: 1.32 W/kg

SAR 10g (W/Kg)	0.432123
SAR 1g (W/Kg)	0.800302

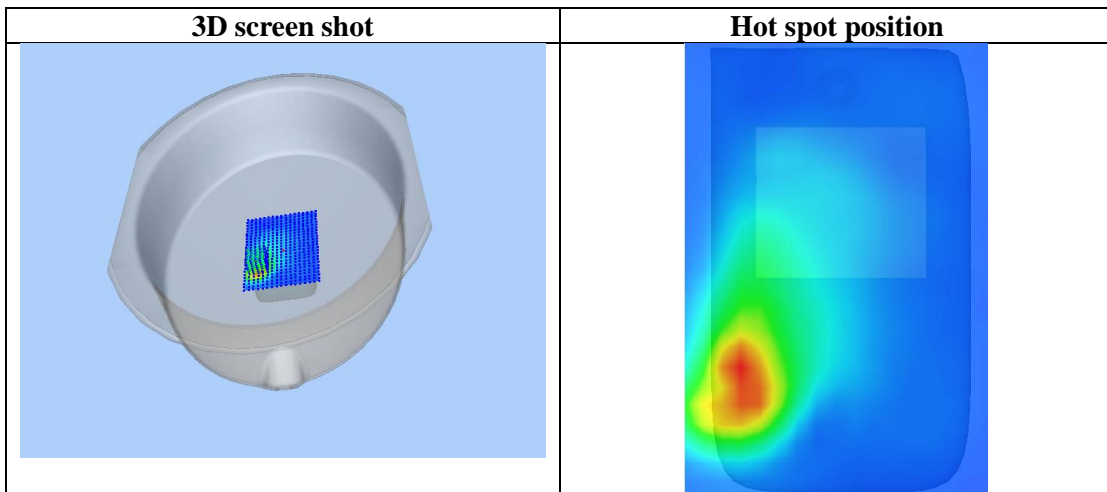
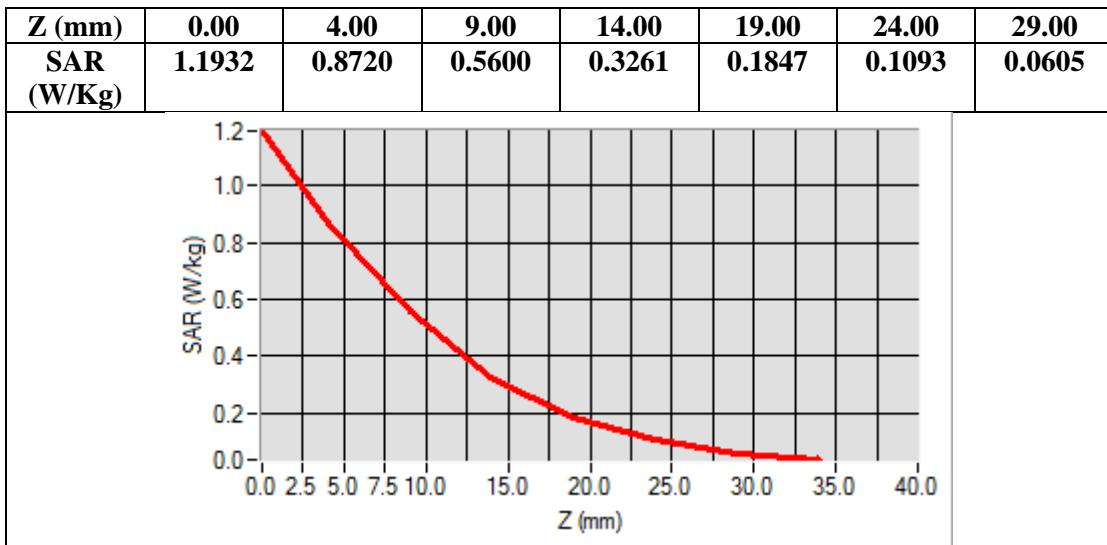

Test Laboratory: AGC Lab

Date: Dec.27,2016

WCDMA Band V Mid-Body-Towards Grounds (RMC)

DUT: Tablet; Type: TT-772

Communication System: UMTS; Communication System Band: BAND V UTRA/FDD; Duty Cycle:1: 1; Conv.F=5.89; Frequency: 836.6 MHz; Medium parameters used:  $f = 835\text{MHz}$ ;  $\sigma = 0.95\text{ mho/m}$ ;  $\epsilon_r = 55.12$ ;  $\rho = 1000\text{ kg/m}^3$ ; Phantom section: Flat Section  
Ambient temperature ( $^{\circ}\text{C}$ ): 21.8, Liquid temperature ( $^{\circ}\text{C}$ ): 21.1

SATIMO Configuration:

- Probe: SSE5; Calibrated: 07/05/2016 Serial No.: SN 14/16 EP307
- Sensor-Surface: 4mm (Mechanical Surface Detection)
- Phantom: SAM twin phantom
- Measurement SW: OpenSAR V4\_02\_35

Configuration/ WCDMA Band V Mid-Body-Back/Area Scan: Measurement grid:  $dx=8\text{mm}$ ,  $dy=8\text{mm}$

Configuration/ WCDMA Band V Mid-Body-Back/Zoom Scan: Measurement grid:  $dx=8\text{mm}$ ,  $dy=8\text{mm}$ ,  $dz=5\text{mm}$ ;

Area Scan	surf_sam_plan.txt
ZoomScan	5x5x7,dx=8mm dy=8mm dz=5mm,Complete
Phantom	Validation plane
Device Position	Body Back
Band	WCDMA Band V
Channels	Middle
Signal	CDMA (Crest factor: 1.0)

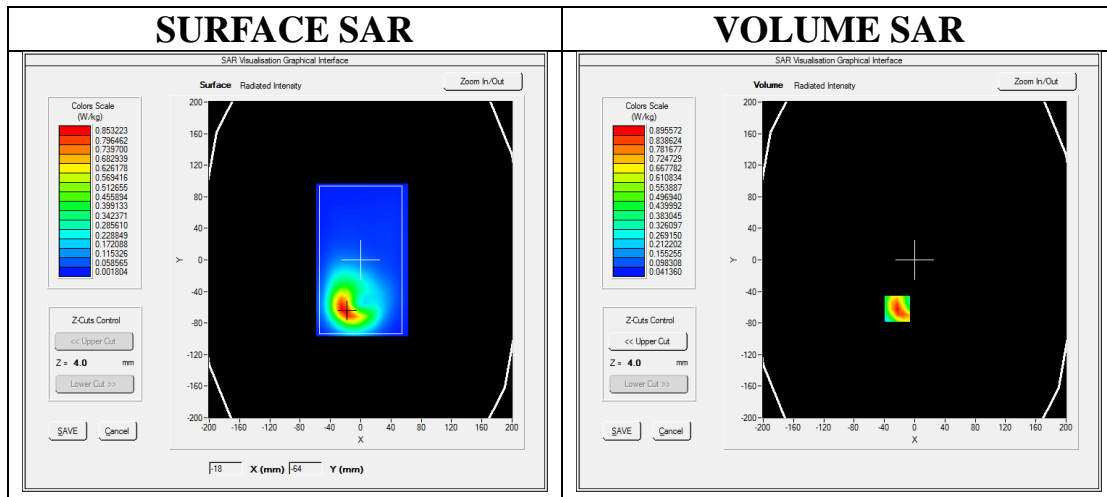

Maximum location: X=-23.00, Y=-62.00

SAR Peak: 1.35 W/kg

SAR 10g (W/Kg)	0.483089
SAR 1g (W/Kg)	0.850778



Z (mm)	0.00	4.00	9.00	14.00	19.00	24.00	29.00
SAR (W/Kg)	1.3448	0.8956	0.5387	0.3402	0.2206	0.1467	0.0990

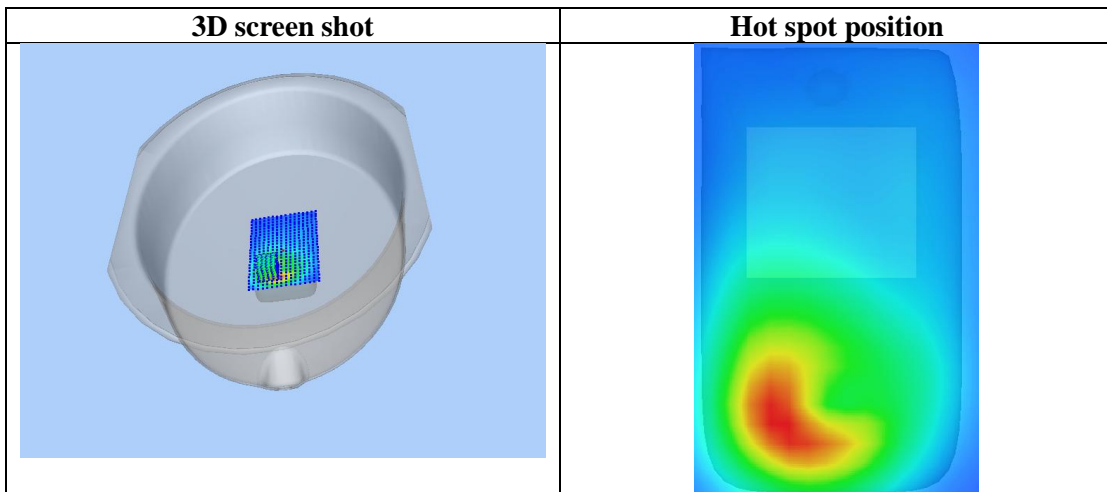
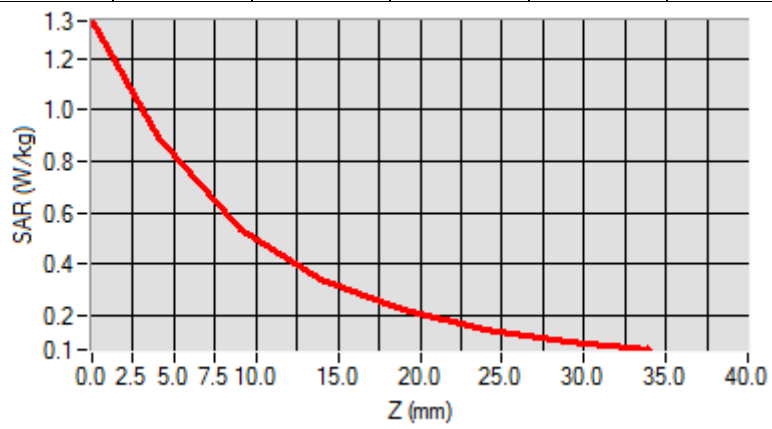

## **APPENDIX C. TEST SETUP PHOTOGRAPHS & EUT PHOTOGRAPHS**

Refer to Attached files.

## **APPENDIX D. CALIBRATION DATA**

Refer to Attached files.