

# Emissions Test Report

**EUT Name:** Wi-Fi Router  
**Model No.:** B010001 (USA), B010002 (IC)  
CFR 47 Part 15.407 2016 and RSS 247: 2017

*Prepared for:*

Clifford Clarke  
eero inc  
500 Howard Street, Suite 900  
San Francisco, CA 94105  
Tel: (415) 738-7972  
Fax:

*Prepared by:*

TUV Rheinland of North America, Inc.  
1279 Quarry Lane  
Pleasanton, CA 94566  
Tel: (925) 249-9123  
Fax: (925) 249-9124  
<http://www.tuv.com/>

*Report/Issue Date:* May 11, 2017  
*Job #* 0000146430  
*Report Number:* 31761402.001



# Statement of Compliance

*Manufacturer:* eero inc  
500 Howard Street, Suite 900  
San Francisco, CA 94105  
(415) 738-7972

*Requester / Applicant:* Clifford Clarke

*Name of Equipment:* Wi-Fi Router  
*Model No.* B010001 (USA), B010002 (IC)  
*Type of Equipment:* Intentional Radiator  
*Application of Regulations:* CFR 47 Part 15.407 2016 and RSS 247: 2017  
*Test Dates:* 05 Apr, 2017 to 04 May 2017

## *Guidance Documents:*

Emissions: ANSI C63.10-2013, KDB 789033 D02 General UNII Test Procedures New Rules v01, KDB 662911 D01 Multiple Transmitter Output v02r01

## *Test Methods:*

Emissions: ANSI C63.10-2013, KDB 789033 D02 General UNII Test Procedures New Rules v01, KDB 662911 D01 Multiple Transmitter Output v02r01

The electromagnetic compatibility test and documented data described in this report has been performed and recorded by TUV Rheinland, in accordance with the standards and procedures listed herein. As the responsible authorized agent of the EMC laboratory, I hereby declare that the equipment described above has been shown to be compliant with the EMC requirements of the stated regulations and standards based on these results. If any special accessories and/or modifications were required for compliance, they are listed in the Executive Summary of this report.

This report must not be used to claim product endorsement by A2LA or any agency of the U.S. Government. This report contains data that are not covered by A2LA accreditation. This report shall not be reproduced except in full, without the written authorization of TUV Rheinland of North America.

Kerwinn Corpuz

Test Engineer

Date May 11, 2017

David Spencer

A2LA Signatory

Date May 11, 2017



**Testing Cert #3331.02**



**US1131**



**2932M**

Table of Contents

<b>1</b>	<b>Executive Summary</b>	<b>7</b>
1.1	Scope	7
1.2	Purpose	7
1.3	Summary of Test Results	8
1.4	Special Accessories	8
1.5	Equipment Modifications	8
<b>2</b>	<b>Laboratory Information</b>	<b>9</b>
2.1	Accreditations & Endorsements	9
2.1.1	US Federal Communications Commission	9
2.1.2	NIST/ A2LA	9
2.1.3	Canada – Industry Canada	9
2.1.4	Japan – VCCI	9
2.1.5	Acceptance by Mutual Recognition Arrangement	10
2.2	Test Facilities	10
2.2.1	Emission Test Facility	10
2.2.2	Immunity Test Facility	10
2.3	Measurement Uncertainty	10
2.3.1	Sample Calculation – radiated & conducted emissions	11
2.3.2	Measurement Uncertainty	11
1.1.1	Measurement Uncertainty Immunity	12
2.4	Calibration Traceability	12
<b>3</b>	<b>Product Information</b>	<b>13</b>
3.1	Product Description	13
3.2	Equipment Configuration	13
3.3	Operating Mode	13
3.4	Unique Antenna Connector	14
3.4.1	Results	14
<b>4</b>	<b>Emissions</b>	<b>15</b>
4.1	Output Power Requirements	15
4.1.1	Test Method	15
4.1.2	Results	16
4.2	Occupied Bandwidth	26
4.2.1	Test Method	26
4.2.2	Results	26
4.3	Peak Power Spectral Density	32
4.3.1	Test Method	32
4.3.2	Results	33
4.4	Undesirable Emission Limits	42
4.4.1	Test Method	42
4.4.2	Results	42

## Table of Contents

<b>4.5</b>	<b>Transmitter Spurious Emissions</b>	<b>71</b>
4.5.1	Test Methodology	71
4.5.2	Transmitter Spurious Emission Limit	72
4.5.3	Test Results	73
<b>4.6</b>	<b>AC Conducted Emissions</b>	<b>99</b>
4.6.1	Test Methodology	99
4.6.2	Test Results	99
<b>4.7</b>	<b>Frequency Stability</b>	<b>104</b>
4.7.1	Test Methodology	104
4.7.2	Manufacturer Declaration	104
4.7.3	Limit	105
4.7.4	Test results:	105
<b>4.8</b>	<b>Voltage Variation</b>	<b>107</b>
4.8.1	Test Methodology	107
4.8.2	Test results	107
<b>4.9</b>	<b>Maximum Permissible Exposure</b>	<b>109</b>
4.9.1	Test Methodology	109
4.9.2	RF Exposure Limit	109
4.9.3	EUT Operating Condition	110
4.9.4	Classification	110
4.9.5	Test Results	110
4.9.6	Sample Calculation	110
<b>5</b>	<b>Test Equipment List</b>	<b>111</b>
<b>5.1</b>	<b>Equipment List</b>	<b>111</b>
<b>6</b>	<b>EMC Test Plan</b>	<b>112</b>
<b>6.1</b>	<b>Introduction</b>	<b>112</b>
<b>6.2</b>	<b>Customer</b>	<b>112</b>
<b>6.3</b>	<b>Equipment Under Test (EUT)</b>	<b>113</b>
<b>6.4</b>	<b>Test Specifications</b>	<b>117</b>

Index of Tables

<b>Table 1:</b> Summary of Test Results .....	8
<b>Table 2:</b> RF Output Power at the Antenna Port – Test Results – Non Beamforming .....	16
<b>Table 3:</b> RF Output Power at the Antenna Port – Test Results – Non Beamforming Continued .....	17
<b>Table 4:</b> RF Output Power at the Antenna Port – Test Results – Non Beamforming Continued .....	18
<b>Table 5:</b> RF Output Power at the Antenna Port – Test Results – Beamforming.....	19
<b>Table 6:</b> RF Output Power at the Antenna Port – Test Results – Beamforming Continued.....	20
<b>Table 7:</b> Occupied Bandwidth – Test Results.....	27
<b>Table 8:</b> Occupied Bandwidth – Test Results Continued.....	28
<b>Table 9:</b> Peak Power Spectral Density – Test Results – Non Beamforming .....	33
<b>Table 10:</b> Peak Power Spectral Density – Test Results – Non Beamforming Continued .....	34
<b>Table 11:</b> Peak Power Spectral Density – Test Results – Beamforming .....	35
<b>Table 12:</b> Peak Power Spectral Density – Test Results – Beamforming Continued .....	36
<b>Table 13:</b> Emissions at the Band-Edge – Test Results.....	43
<b>Table 14:</b> Emissions at the Band-Edge – Test Results Continued.....	44
<b>Table 15:</b> Transmit Spurious Emission at Band-Edge Requirements.....	74
<b>Table 16:</b> AC Conducted Emissions – Test Results.....	99
<b>Table 17:</b> Frequency Stability – Test Results .....	105
<b>Table 18:</b> Voltage Variation – Test Results.....	107
<b>Table 19:</b> Customer Information .....	112
<b>Table 20:</b> Technical Contact Information.....	112
<b>Table 21:</b> EUT Specifications .....	113
<b>Table 22:</b> Antenna Information .....	114
<b>Table 23:</b> EUT Channel Power Specifications .....	115
<b>Table 24:</b> Interface Specifications .....	116
<b>Table 25:</b> Supported Equipment.....	116
<b>Table 26:</b> Description of Sample used for Testing.....	116
<b>Table 27:</b> Description of Test Configuration used for Radiated Measurement.....	116
<b>Table 28:</b> Test Specifications.....	117

# 1 Executive Summary

## 1.1 Scope

This report is intended to document the status of conformance with the requirements of the CFR 47 Part 15.407 2016 and RSS 247: 2017 based on the results of testing performed on 05 Apr, 2017 to 04 May 2017 on the Wi-Fi Router Model B010001 (USA), B010002 (IC) manufactured by eero inc. This report only applies to the specific samples tested under the stated test conditions. It is the responsibility of the manufacturer to assure that additional production units of this model are manufactured with identical or EMI equivalent electrical and mechanical components. This report is further intended to document changes and modifications to the EUT throughout its life cycle. All documentation will be included as a supplement.

## 1.2 Purpose

Testing was performed to evaluate the EMC performance of the EUT in accordance with the applicable requirements, procedures, and criteria defined in the application of regulations and application of standards listed in this report. The 5745 MHz to 5825 MHz frequency band is covered in this document.

### 1.3 Summary of Test Results

**Table 1:** Summary of Test Results

Test	Test Method ANSI C63.10	Test Parameters (Measured)	Result
Spurious Emission in Transmitted Mode	CFR47 15.209, CFR47 15.407 (b), 2.1053, 2.1057, RSS-GEN Sect.8.9, RSS 247 Sect. 6.2.4.2	Class B	Complied
Restricted Bands of Operation	CFR47 15.205, RSS GEN Sect.8.10	Class B	Complied
AC Power Conducted Emission	CFR47 15.207, RSS-GEN Sect.8.8	Class B	Complied
Occupied Bandwidth	CFR47 15.407 (e), 2.1049, RSS GEN Sect.6.6	See plots	Complied
Maximum Output Power	CFR47 15.407 (a), 2.1046, RSS 247 Sect. 6.2.4.1 [see note 2]	29.24 dBm (11a mode) 29.22 dBm (HT 20) 23.51 dBm (HT 40) 24.36 dBm (VHT 40) 22.15 dBm (VHT80)	Complied
Peak Power Spectral Density	CFR47 15.407 (a), RSS 247 Sect. 6.2.4.1	< 30 dBm/500kHz	Complied
Conducted Emission – Antenna Port	CFR47 15.407 (b), 2.1051, 2.1057, RSS 247 Sect.6.2.4.2	30 MHz - 40 GHz < 27 dBm/MHz	Complied
Frequency Stability	CFR47 15.407 (g), 2.1055, RSS GEN Sect. 6.11	±20 ppm	Complied
RF Exposure	CFR47 15.407 (f), 2.1091, RSS-102 Issue 5	General Population	Complied

Note: 1. This test report covers 5725 MHz to 5850 MHz band.  
 2. Measurements are conducted for 2x2 MIMO total power non-beamforming.

### 1.4 Special Accessories

No special accessories were necessary in order to achieve compliance.

### 1.5 Equipment Modifications

None



## 2 Laboratory Information

### 2.1 Accreditations & Endorsements

#### 2.1.1 US Federal Communications Commission



TUV Rheinland of North America at 1279 Quarry Ln, Pleasanton, CA 94566 is recognized by the commission for performing testing services for the general public on a fee basis. These laboratory test facilities have been fully described in reports submitted to and accepted by the FCC (US1131). The laboratory scope of accreditation includes: Title 47 CFR Parts 15, 18, and 90. The accreditation is updated every 3 years.

#### 2.1.2 NIST / A2LA



TUV Rheinland of North America is accredited by the National Voluntary Laboratory Accreditation Program, which is administered under the auspices of the National Institute of Standards and Technology. The laboratory has been assessed and accredited in accordance with ISO Guide 17025:1999 and ISO 9002 (Lab Code Testing Cert #3331.02). The scope of laboratory accreditation includes emission and immunity testing. The accreditation is updated annually.

#### 2.1.3 Canada – Industry Canada



TUV Rheinland of North America at the 1279 Quarry Ln, Pleasanton, CA 94566 address is accredited by Industry Canada for performing testing services for the general public on a fee basis. This laboratory test facilities have been fully described in reports submitted to and accepted by Industry Canada (File Number 2932M). This reference number is the indication to the Industry Canada Certification Officers that the site meets the requirements of RSS 212, Issue 1 (Provisional). The accreditation is updated every 3 years.

#### 2.1.4 Japan – VCCI



The Voluntary Control Council for Interference by Information Technology Equipment (VCCI) is a group that consists of Information Technology Equipment (ITE) manufacturers and EMC test laboratories. The purpose of the Council is to take voluntary control measures against electromagnetic interference from Information Technology Equipment, and thereby contribute to the development of a socially beneficial and responsible state of affairs in the realm of Information Technology Equipment in Japan. TUV Rheinland of North America at 1279 Quarry Ln, Pleasanton, CA 94566 has been assessed and approved in accordance with the Regulations for Voluntary Control Measures.

VCCI Registration No. for Pleasanton: A-0261

### 2.1.5 Acceptance by Mutual Recognition Arrangement



The United States has an established agreement with specific countries under the Asia Pacific Laboratory Accreditation Corporation (APLAC) Mutual Recognition Arrangement. Under this agreement, all TUV Rheinland at 1279 Quarry Ln, Pleasanton, CA 94566 test results and test reports within the scope of the laboratory NIST / A2LA accreditation will be accepted by each member

country.

## 2.2 Test Facilities

All of the test facilities are located at 1279 Quarry Lane, Pleasanton, California 94566, USA. The 2305 Mission College, Santa Clara, 95054, USA location is considered a Pleasanton annex.

### 2.2.1 Emission Test Facility

The Semi-Anechoic chamber and AC Line Conducted measurement facility used to collect the radiated and conducted data has been constructed in accordance with ANSI C63.7:1992. The site has been measured in accordance with and verified to comply with the theoretical normalized site attenuation requirements of ANSI C63.4-2014, at a test distance of 3 and 5 meters. The site is listed with the FCC and accredited by A2LA (Lab Code Testing Cert #3331.02). The 3/5-meter semi-anechoic chamber used to collect the radiated data has been verified to comply with the theoretical normalized site attenuation requirements of ANSI C63.4-2014, at a test distance of 3 meter and 5 meters. A report detailing this site can be obtained from TUV Rheinland of North America.

### 2.2.2 Immunity Test Facility

ESD, EFT, Surge, PQF: These tests are performed in an environmentally controlled room with a 3.7 m x 4.8 m x 3.175 mm thick aluminum floor connected to PE ground.

For ESD testing, tabletop equipment is placed on an insulated mat with a surface resistivity of  $10^9$  Ohms/square on a 1.6 m x 0.8 m x 0.8 m high non-conductive table with a 3.175 mm aluminum top (Horizontal Coupling Plane). The HCP is connected to the main ground plane via a low impedance ground strap through two 470-k $\Omega$  resistors. The Vertical Coupling Plane consists of an aluminum plate 50 cm x 50 cm x 3.175 mm thick. The VCP is connected to the main ground plane via a low impedance ground strap through two 470-k $\Omega$  resistors.

For EFT, Surge, PQF, the HCP and VCP are removed.

RF Field Immunity testing is performed in a 7.3m x 4.3m x 4.1m anechoic chamber.

RF Conducted and Magnetic Field Immunity testing is performed on a 4.8m x 3.7m x 3.175mm thick aluminum ground plane.

All test areas allow a minimum distance of 1 meter from the EUT to walls or conducting objects.

## 2.3 Measurement Uncertainty

Two types of measurement uncertainty are expressed in this report, per *ISO Guide To The Expression Of Uncertainty In Measurement*, 1<sup>st</sup> Edition, 1995.

The *Combined Standard Uncertainty* is the standard uncertainty of the result of a measurement when that result is obtained from the values of a number of other quantities; it is equal to the positive square root of the sum of the variances or co-variances of these other quantities, weighted according to how the measurement result varies with changes in these quantities. The term *standard uncertainty* is the result of a measurement expressed as a standard deviation.

### 2.3.1 Sample Calculation – radiated & conducted emissions

The field strength is calculated by subtracting the Amplifier Gain and adding the Cable Loss and Antenna Correction Factor to the measured reading. The basic equation is as follows:

$$\text{Field Strength (dB}\mu\text{V/m)} = \text{RAW} - \text{AMP} + \text{CBL} + \text{ACF}$$

Where: RAW = Measured level before correction (dBμV)

AMP = Amplifier Gain (dB)

CBL = Cable Loss (dB)

ACF = Antenna Correction Factor (dB/m)

$$\mu\text{V/m} = 10^{\frac{\text{dB}\mu\text{V/m}}{20}}$$

#### Sample radiated emissions calculation @ 30 MHz

Measurement +Antenna Factor–Amplifier Gain+Cable loss=Radiated Emissions (dBuV/m)

$$25 \text{ dBuV/m} + 17.5 \text{ dB} - 20 \text{ dB} + 1.0 \text{ dB} = 23.5 \text{ dBuV/m}$$

### 2.3.2 Measurement Uncertainty

Per CISPR 16-4-2	U <sub>lab</sub>	U <sub>cispr</sub>
<b>Radiated Disturbance @ 10 meters</b>		
30 – 1,000 MHz	2.25 dB	4.51 dB
<b>Radiated Disturbance @ 3 meters</b>		
30 – 1,000 MHz	2.26 dB	4.52 dB
1 – 6 GHz	2.12 dB	4.25 dB
6 – 18 GHz	2.47 dB	4.93 dB
<b>Conducted Disturbance @ Mains Terminals</b>		
150 kHz – 30 MHz	1.09 dB	2.18 dB
<b>Disturbance Power</b>		
30 MHz – 300 MHz	3.92 dB	4.3 dB

### Voltech PM6000A

The estimated combined standard uncertainty for harmonic current and flicker measurements is $\pm 5.0\%$ .	Per CISPR 16-4-2 Methods
--	--------------------------

#### 1.1.1 Measurement Uncertainty Immunity

The estimated combined standard uncertainty for ESD immunity measurements is $\pm 8.2\%$ .	Per IEC 61000-4-2
The estimated combined standard uncertainty for radiated immunity measurements is $\pm 4.10$ dB.	Per IEC 61000-4-3
The estimated combined standard uncertainty for conducted immunity measurements with CDN is $\pm 3.66$ dB	Per IEC 61000-4-6
The estimated combined standard uncertainty for power frequency magnetic field immunity is $\pm 2.9\%$ .	Per IEC 61000-4-8

### Thermo KeyTek EMC Pro

The estimated combined standard uncertainty for EFT fast transient immunity measurements is $\pm 2.6\%$ .
The estimated combined standard uncertainty for surge immunity measurements is $\pm 2.6\%$ .
The estimated combined standard uncertainty for voltage variation and interruption measurements is $\pm 1.74\%$ .

The expanded uncertainty at a level of 95% confidence is obtained by multiplying the combined standard uncertainty by a coverage factor of 2. Compliance criteria are not based on measurement uncertainty.

## 2.4 Calibration Traceability

All measurement instrumentation is traceable to the National Institute of Standards and Technology (NIST). Measurement method complies with ANSI/NCSL Z540-1-1994 and ISO Standard 17025:2005. Equipment calibration records are kept on file at the test facility.

---

## 3 Product Information

### 3.1 Product Description

The Model B010001 (USA), B010002 (IC), Wi-Fi Router, is a Wi-Fi router for the home capable of operating in the 2.4 GHz and 5 GHz frequency bands over 20 MHz, 40 MHz and 80 MHz channels.

### 3.2 Equipment Configuration

A description of the equipment configuration is given in the Test Plan Section. The EUT was tested as called for in the test standard and was configured and operated in a manner consistent with its intended use. The EUT was connected to rated power and allowed to reach intended operating conditions. The placement of the EUT system components was guided by the test standard and selected to represent typical installation conditions.

In the case of an EUT that can operate in more than one configuration, preliminary testing was performed to determine the configuration that produced maximum radiation.

The final configuration was selected to produce the worst case radiation for emissions testing and to place the EUT in the most susceptible state for immunity testing.

### 3.3 Operating Mode

A description of the operation mode is given in the Test Plan Section. In the case of an EUT that can operate in more than one state, preliminary testing was performed to determine the operating mode that produced maximum radiation.

The final operating mode was selected to produce the worst case radiation for emissions testing and to place the EUT in the most susceptible state for immunity testing.

---

### **3.4 Unique Antenna Connector**

An intentional radiator shall be designed to ensure that no antenna other than that furnished by the responsible party shall be used with the device. The use of a permanently attached antenna or of an antenna that uses a unique coupling to the intentional radiator shall be considered sufficient to comply with the provisions of this Section. The manufacturer may design the unit so that a broken antenna can be replaced by the user, but the use of a standard antenna jack or electrical connector is prohibited. This requirement does not apply to carrier current devices or to devices operated under the provisions of CFR47 Parts 15.211, 15.213, 15.217, 15.219, or 15.221.

#### **3.4.1 Results**

The Wi-Fi Router has five FPCB antennas. The 5.725 – 5.850 GHz band uses Flex Printed Circuit Board (FPCB) dipole antennas, Antenna 5 and Antenna 6, and has maximum gain + 3.84 dBi.

Refer to Table 22 for additional antenna information.

There are no additional antenna available.

## 4 Emissions

Testing was performed in accordance with CFR 47 Part 15.407: 2016 and RSS 247: 2017. These test methods are listed under the laboratory's A2LA Scope of Accreditation. This test measures the levels emanating from the EUT, thus evaluating the potential for the EUT to cause radio frequency interference to other electronic devices. Procedures described in section 8 of the standard were used.

### 4.1 Output Power Requirements

*The maximum output power requirement is the maximum equivalent isotropic radiated power delivering at the transmitting antenna under specified conditions of measurements in the presence of modulation.*

*The maximum output power and harmonics shall not exceed CFR47 Part 15.407 (a):2016 and RSS 247 Sect.6.2.4.1: 2017.*

*The maximum transmitted power is*

*Band 5725-5850 MHz: 1 W.*

#### 4.1.1 Test Method

The ANSI C63.10-2013 Section 12.3.2.2 conducted method was used to measure the channel power output. The preliminary investigation was performed at different data rate/ chain to determine the highest power output for each mode. The worst findings were conducted on 3 channels in each operating range per CFR47 Part 15.407(a) and RSS 247 Sect.6.2.4.1; 5725 MHz to 5850 MHz. The worst mode results indicated below.

Test Setup:

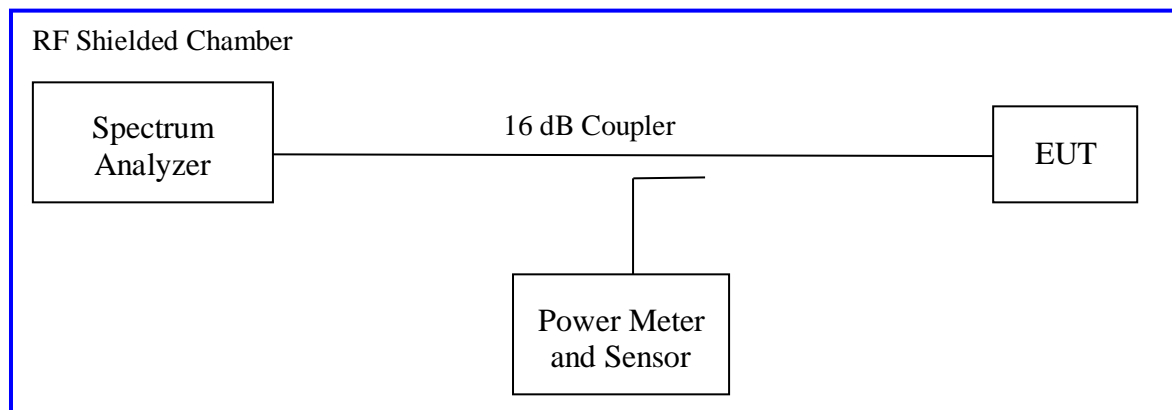

*Method SA-1 of "KDB 789033 D02 – Guidelines for Compliance Testing of Unlicensed National Information Infrastructure (U-NII) Devices" applies since the EUT continuously transmit; where duty cycle is greater than 98%. Sample detector was used.*

Each chain was measured individually and applied the measure-and-sum approach per KDB662911.

The total directional gain (6.58 dBi) was calculated by summing Antenna 5 (3.84 dBi) and Antenna 6 (3.29 dBi).

### 4.1.2 Results

As originally tested, the EUT was found to be compliant to the requirements of the test standard(s).

**Table 2: RF Output Power at the Antenna Port – Test Results – Non Beamforming**

<b>Test Conditions:</b> Conducted Measurement, Normal Temperature					
<b>Antenna Type:</b> FPCB			<b>Power Setting:</b> See test plan		
<b>Max. Directional Gain:</b> Antenna 5 = + 3.84 dBi; Antenna 6 = + 3.29 dBi					
<b>Signal State:</b> Modulated at 100%.					
<b>Ambient Temp.:</b> 21° C			<b>Relative Humidity:</b> 39%		
<b>802.11a</b>					
<b>Operating Channel (MHz)</b>	<b>Limit [dBm]</b>	<b>Ch0 [dBm]</b>	<b>Ch1 [dBm]</b>	<b>Total Power [dBm]</b>	<b>Margin [dB]</b>
5745.00	30.00	19.28	20.07	22.69	-7.31
5765.00	30.00	24.04	24.56	27.31	-2.69
5785.00	30.00	26.04	26.42	29.42	-0.76
5805.00	30.00	24.78	25.11	27.96	-2.04
5825.00	30.00	21.25	21.25	23.90	-6.10
<b>Note:</b> 1. The highest output power was observed at 802.11a, 6.0 Mbps, 1 Data Stream. 2. The sum of Ch0 and Ch1 = Total Power. 3. Plots for all the measurements stated above were taken, to reduce complexity and bulkiness of the report Highlighted Plots are placed in the report.					



**Table 3: RF Output Power at the Antenna Port – Test Results – Non Beamforming Continued**

<b>Test Conditions:</b> Conducted Measurement, Normal Temperature					
<b>Antenna Type:</b> FPCB			<b>Power Setting:</b> See test plan		
<b>Max. Directional Gain:</b> Antenna 5 = + 3.84 dBi; Antenna 6 = + 3.29 dBi					
<b>Signal State:</b> Modulated at 100%.					
<b>Ambient Temp.:</b> 21° C			<b>Relative Humidity:</b> 39%		
<b>802.11n</b>					
<b>Operating Channel (MHz)</b>	<b>Limit [dBm]</b>	<b>Ch0 [dBm]</b>	<b>Ch1 [dBm]</b>	<b>Total Power [dBm]</b>	<b>Margin [dB]</b>
5745.00	30.00	19.78	20.71	23.27	-6.73
5765.00	30.00	24.00	24.55	27.29	-2.71
5785.00	30.00	26.00	26.41	29.22	-0.78
5805.00	30.00	24.67	25.08	27.89	-2.11
5825.00	30.00	20.45	21.15	23.82	-6.18
<b>Note:</b> 1. The highest output power was observed at HT20 MCS0, 1 Data Streams. 2. The sum of Ch0 and Ch1 = Total Power. 3. Plots for all the measurements stated above were taken, to reduce complexity and bulkiness of the report Highlighted Plots are placed in the report.					

**Table 4: RF Output Power at the Antenna Port – Test Results – Non Beamforming Continued**

<b>Test Conditions:</b> Conducted Measurement, Normal Temperature					
<b>Antenna Type:</b> FPCB			<b>Power Setting:</b> See test plan		
<b>Max. Directional Gain:</b> Antenna 5 = + 3.84 dBi; Antenna 6 = + 3.29 dBi					
<b>Signal State:</b> Modulated at 100%.					
<b>Ambient Temp.:</b> 21° C			<b>Relative Humidity:</b> 39%		
<b>802.11n</b>					
Operating Channel (MHz)	Limit [dBm]	Ch0 [dBm]	Ch1 [dBm]	Total Power [dBm]	Margin [dB]
5755.00	30.00	18.71	19.49	22.12	-7.88
5795.00	30.00	20.16	20.82	23.51	-6.49
<b>Note:</b> 1. The highest output power was observed at HT40 MCS0, 1 Data Streams. 2. The sum of Ch0 and Ch1 = Total Power. 3. Plots for all the measurements stated above were taken, to reduce complexity and bulkiness of the report Highlighted Plots are placed in the report.					
<b>802.11ac</b>					
Operating Channel (MHz)	Limit [dBm]	Ch0 [dBm]	Ch1 [dBm]	Total Power [dBm]	Margin [dB]
5755.00	30.00	18.87	19.55	22.23	-7.77
5795.00	30.00	21.04	21.64	24.36	-5.64
<b>Note:</b> 1. The highest output power was observed at VHT40 MCS0, 1 Data Streams. 2. The sum of Ch0 and Ch1 = Total Power. 3. Plots for all the measurements stated above were taken, to reduce complexity and bulkiness of the report Highlighted Plots are placed in the report.					
<b>802.11ac</b>					
Operating Channel (MHz)	Limit [dBm]	Ch0 [dBm]	Ch1 [dBm]	Total Power [dBm]	Margin [dB]
5775.00	30.00	18.69	19.56	22.15	-7.85
<b>Note:</b> 1. The highest output power was observed at VHT80 MCS0, 1 Data Streams. 2. The sum of Ch0 and Ch1 = Total Power. 3. Plots for all the measurements stated above were taken, to reduce complexity and bulkiness of the report Highlighted Plots are placed in the report.					

**Table 5: RF Output Power at the Antenna Port – Test Results – Beamforming**

<b>Test Conditions:</b> Conducted Measurement, Normal Temperature					
<b>Antenna Type:</b> FPCB			<b>Power Setting:</b> See test plan		
<b>Total Directional Gain:</b> + 6.58 dBi					
<b>Signal State:</b> Modulated at 100%.					
<b>Ambient Temp.:</b> 21° C			<b>Relative Humidity:</b> 39%		
<b>802.11a</b>					
Operating Channel (MHz)	Limit [dBm]	Ch0 [dBm]	Ch1 [dBm]	Total Power [dBm]	Margin [dB]
5745.00	29.42	19.28	20.07	22.69	-6.73
5765.00	29.42	24.04	24.56	27.31	-2.11
5785.00	29.42	26.04	26.42	29.42	-0.18
5805.00	29.42	24.78	25.11	27.96	-1.46
5825.00	29.42	21.25	21.25	23.90	-5.52
<b>Note:</b> 1. The highest output power was observed at 802.11a, 6.0 Mbps, 2 Data Streams. 2. The sum of Ch0 and Ch1 = Total Power. 3. Plots for all the measurements stated above were taken, to reduce complexity and bulkiness of the report Highlighted Plots are placed in the report.					
<b>802.11n</b>					
Operating Channel (MHz)	Limit [dBm]	Ch0 [dBm]	Ch1 [dBm]	Total Power [dBm]	Margin [dB]
5745.00	29.42	19.78	20.71	23.27	-6.19
5765.00	29.42	24.00	24.55	27.29	-2.13
5785.00	29.42	26.00	26.41	29.22	-0.20
5805.00	29.42	24.67	25.08	27.89	-1.53
5825.00	29.42	20.45	21.15	23.82	-5.60
<b>Note:</b> 1. The highest output power was observed at HT20 MCS0, 2 Data Streams. 2. The sum of Ch0 and Ch1 = Total Power. 3. Plots for all the measurements stated above were taken, to reduce complexity and bulkiness of the report Highlighted Plots are placed in the report.					

**Table 6: RF Output Power at the Antenna Port – Test Results – Beamforming Continued**

<b>Test Conditions:</b> Conducted Measurement, Normal Temperature					
<b>Antenna Type:</b> FPCB			<b>Power Setting:</b> See test plan		
<b>Total Directional Gain:</b> + 6.58 dBi					
<b>Signal State:</b> Modulated at 100%.					
<b>Ambient Temp.:</b> 21° C			<b>Relative Humidity:</b> 39%		
<b>802.11n</b>					
Operating Channel (MHz)	Limit [dBm]	Ch0 [dBm]	Ch1 [dBm]	Total Power [dBm]	Margin [dB]
5755.00	29.42	18.71	19.49	22.12	-7.30
5795.00	29.42	20.16	20.82	23.51	-5.91
<b>Note:</b> 1. The highest output power was observed at HT40 MCS0, 2 Data Streams. 2. The sum of Ch0 and Ch1 = Total Power. 3. Plots for all the measurements stated above were taken, to reduce complexity and bulkiness of the report Highlighted Plots are placed in the report.					
<b>802.11ac</b>					
Operating Channel (MHz)	Limit [dBm]	Ch0 [dBm]	Ch1 [dBm]	Total Power [dBm]	Margin [dB]
5755.00	29.42	18.87	19.55	22.23	-7.19
5795.00	29.42	21.04	21.64	24.36	-5.06
<b>Note:</b> 1. The highest output power was observed at VHT40 MCS0, 2 Data Streams. 2. The sum of Ch0 and Ch1 = Total Power. 3. Plots for all the measurements stated above were taken, to reduce complexity and bulkiness of the report Highlighted Plots are placed in the report.					
<b>802.11ac</b>					
Operating Channel (MHz)	Limit [dBm]	Ch0 [dBm]	Ch1 [dBm]	Total Power [dBm]	Margin [dB]
5775.00	29.42	18.69	19.56	22.15	-7.27
<b>Note:</b> 1. The highest output power was observed at VHT80 MCS0, 2 Data Streams. 2. The sum of Ch0 and Ch1 = Total Power. 3. Plots for all the measurements stated above were taken, to reduce complexity and bulkiness of the report Highlighted Plots are placed in the report.					

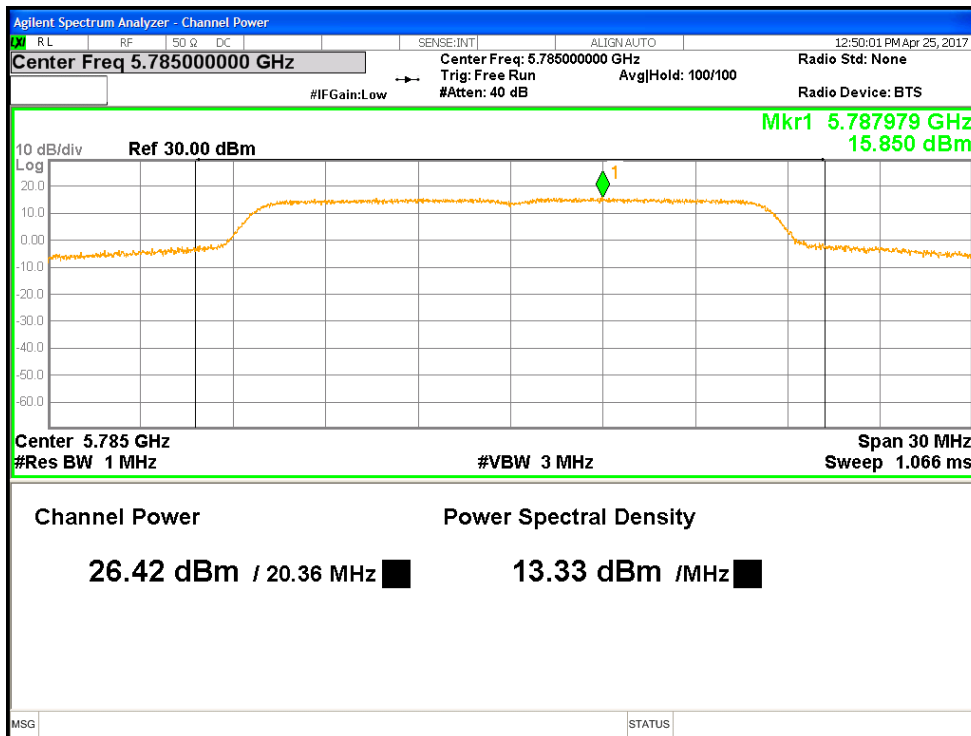

Figure 1: Non-Beamforming Max Transmitted Power, 5785 MHz at 11a, Chain 1

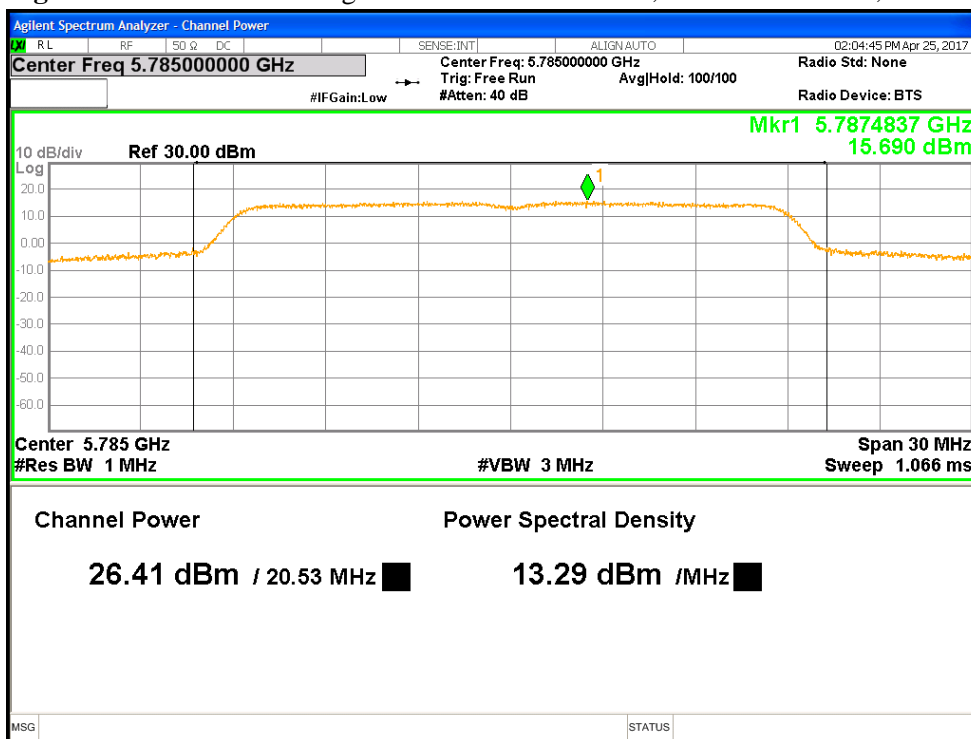

Figure 2: Non-Beamforming Max Transmitted Power, 5785 MHz at HT20, Chain 1

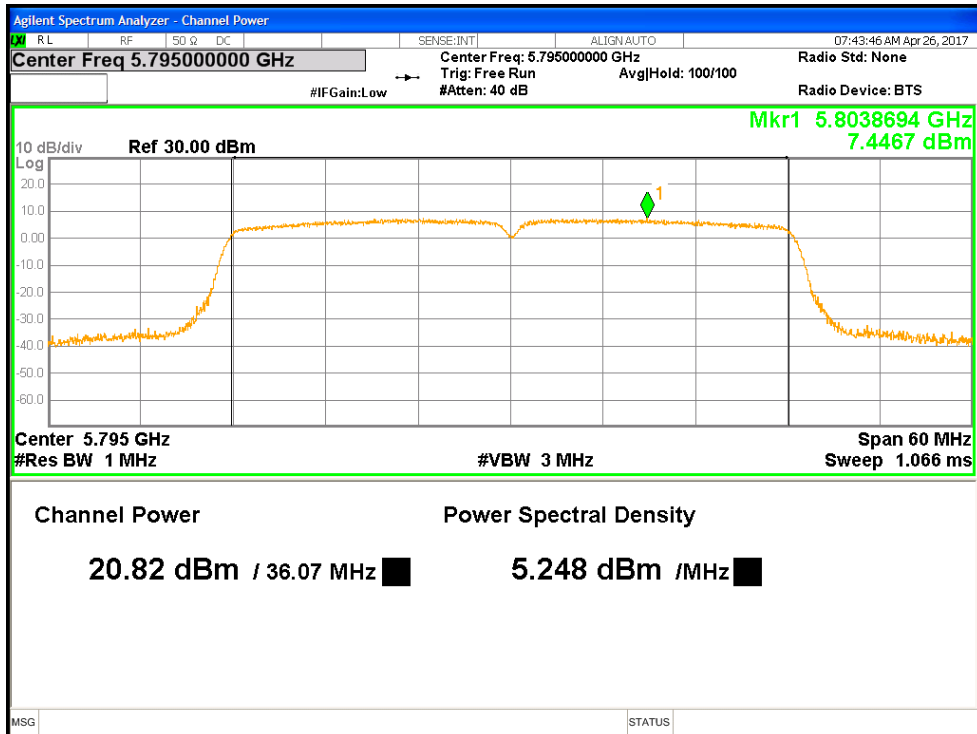

Figure 3: Non Beamforming Max Transmitted Power, 5795 MHz at HT40, Chain 1

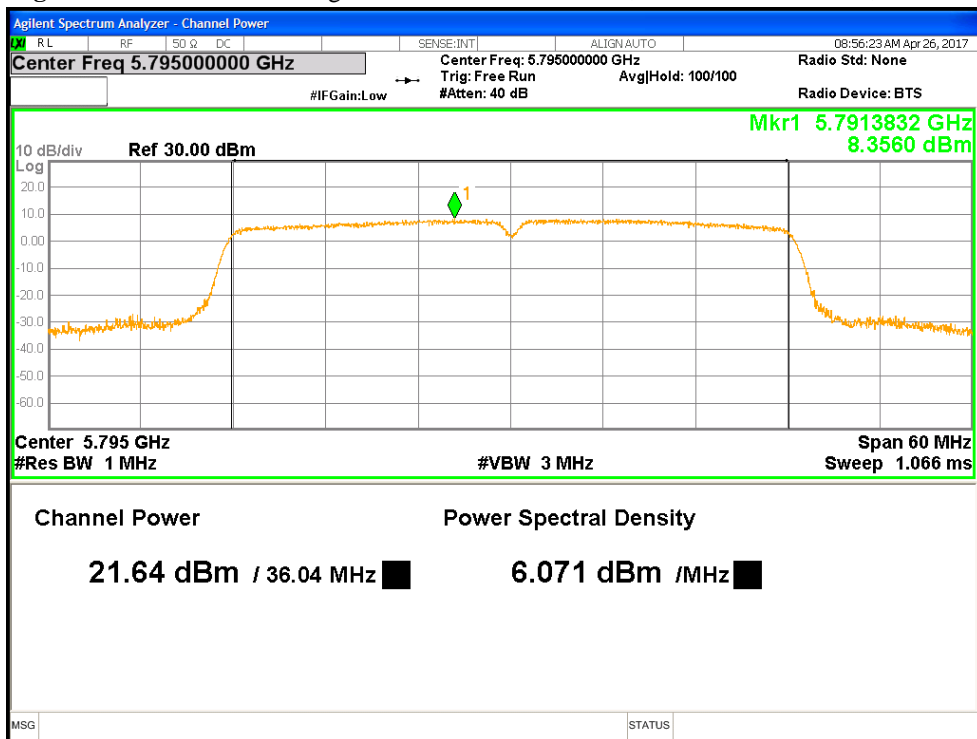

Figure 4: Non Beamforming Max Transmitted Power, 5795 MHz at VHT40, Chain 1

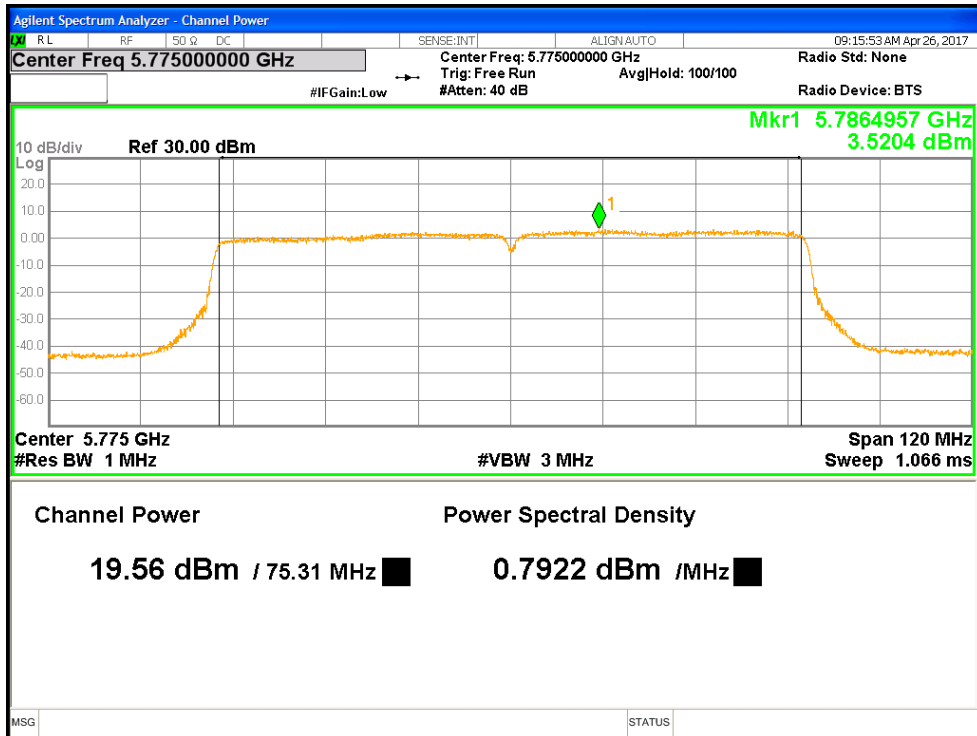

Figure 5: Non Beamforming Max Transmitted Power, 5755 MHz at VHT80, Chain 1

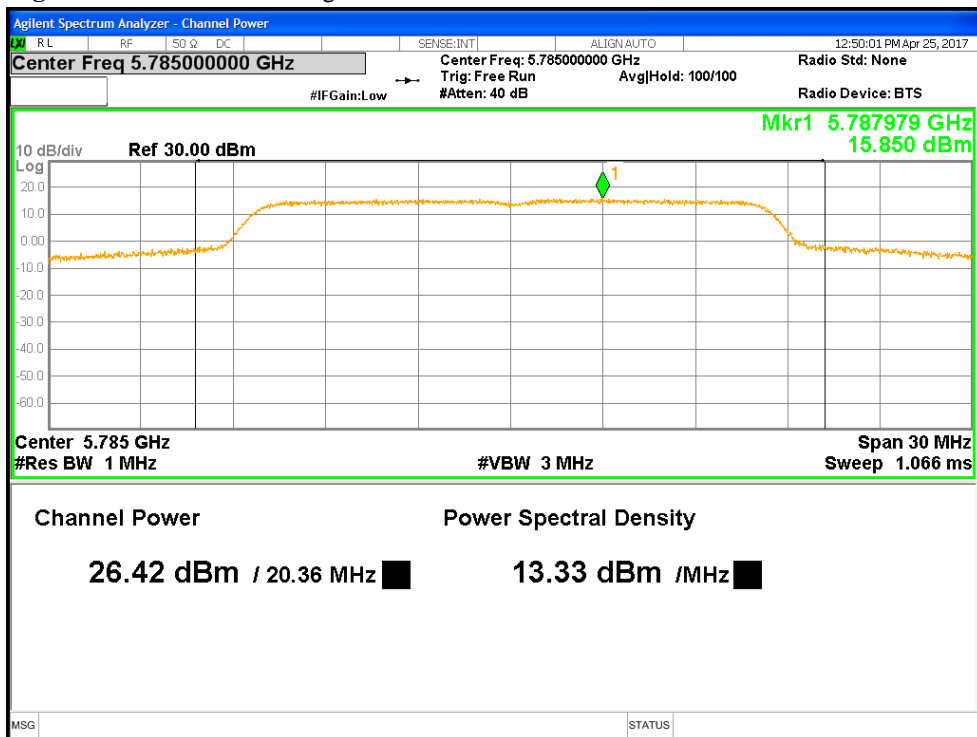

Figure 6: Beamforming Max Transmitted Power, 5785 MHz at 11a, Chain 1

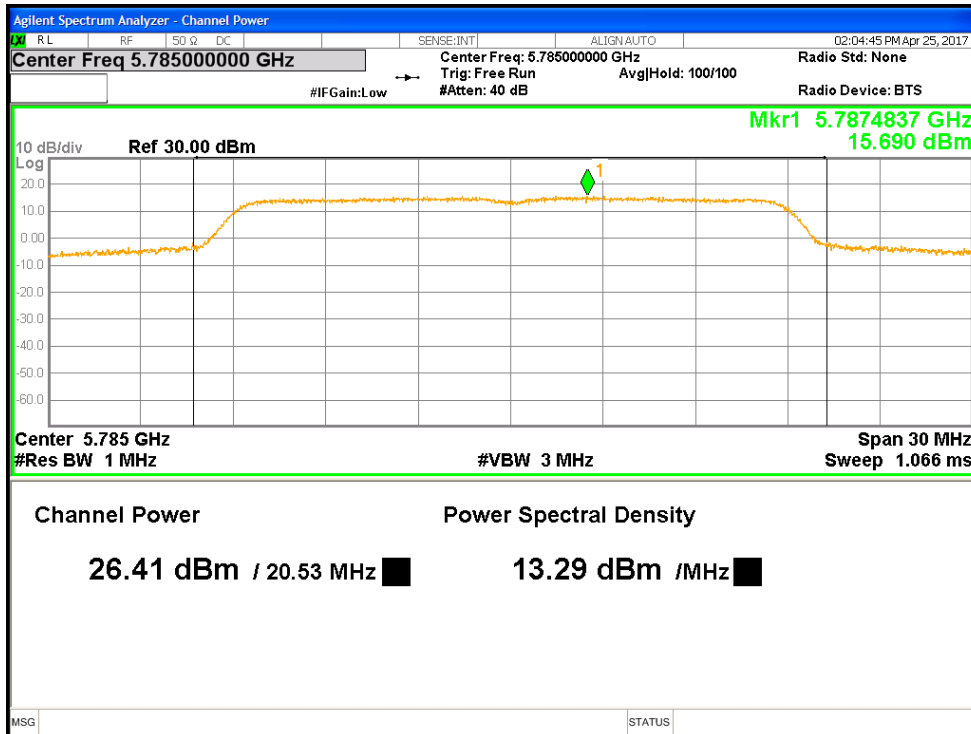

Figure 7: Beamforming Max Transmitted Power, 5785 MHz at HT20, Chain 1

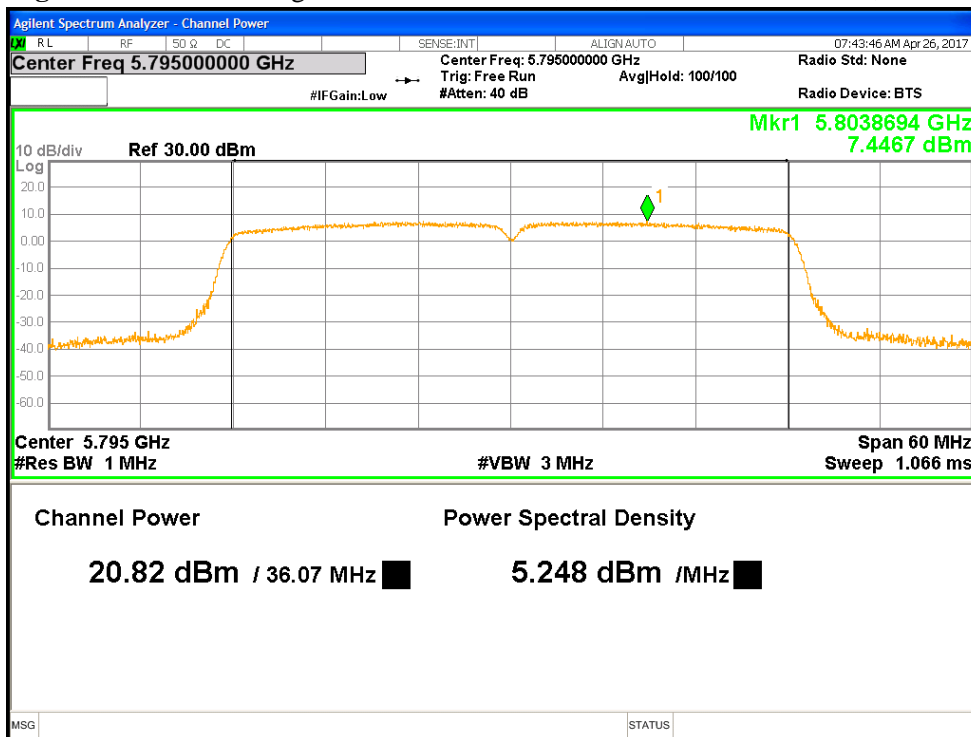

Figure 8: Beamforming Max Transmitted Power, 5795 MHz at HT40, Chain 1



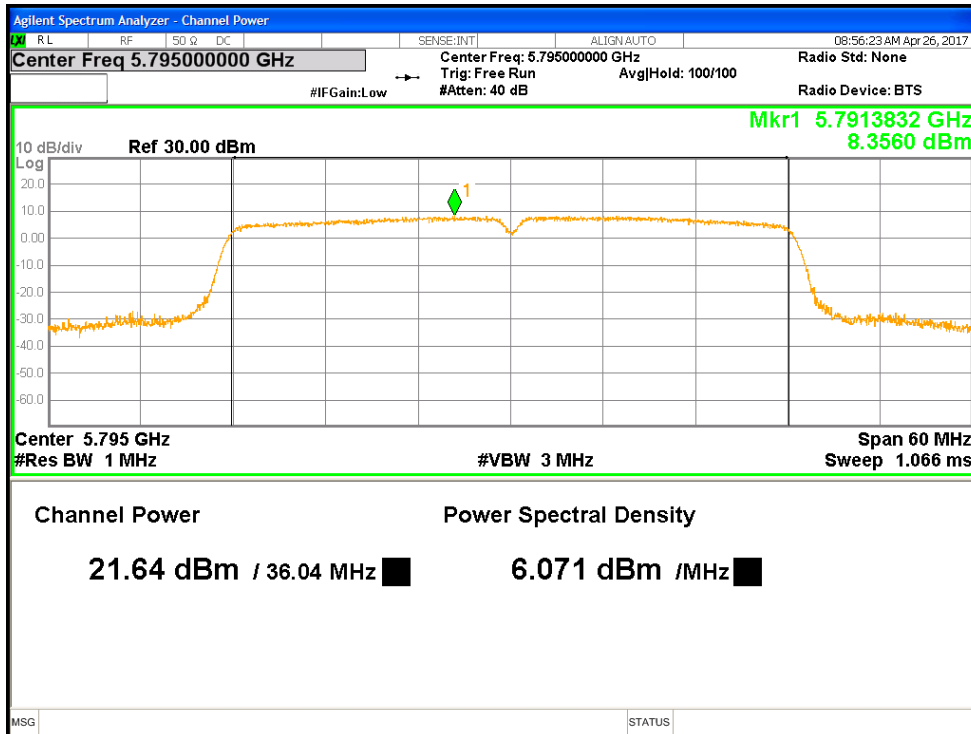

Figure 9: Beamforming Max Transmitted Power, 5795 MHz at VHT40, Chain 1

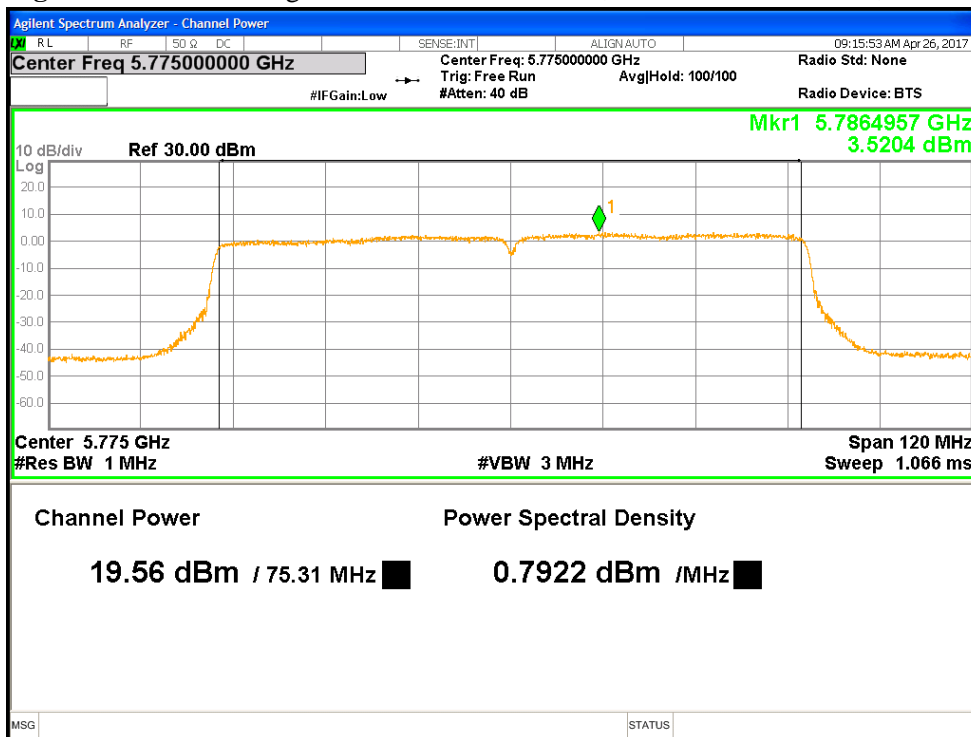

Figure 10: Beamforming Max Transmitted Power, 5775 MHz at VHT80, Chain 1

## 4.2 Occupied Bandwidth

The occupied bandwidth is measured at an amplitude level reduced from the reference level by a specified ratio. The reference level is the level of the highest amplitude signal observed from the transmitter at the fundamental frequency.

The 99% bandwidth is the bandwidth in which 99% of the transmitted power occupied.

The 6 or 26 dB bandwidth is defined the bandwidth of 6 or 26 dB from highest transmitted level of the fundamental frequency.

Within the 5.725 – 5.850 GHz band, the minimum 6 dB bandwidth of U-NII devices shall be at least 500 kHz per CFR47 Part 15.407(e).

### 4.2.1 Test Method

The conducted method was used to measure the occupied bandwidth. The measurement was performed with modulation per CFR47 15.407(e) 2016 and RSS Gen Sect. 4.4.1:2010. The preliminary investigation was performed to find the narrowest 26 dB bandwidth for each operational mode at different data rates. This worst finding was performed on 3 channels in each operating frequency range; 5725 to 5850 MHz band, a 6 dB bandwidth was used. The worst results indicated below.

Test Setup:

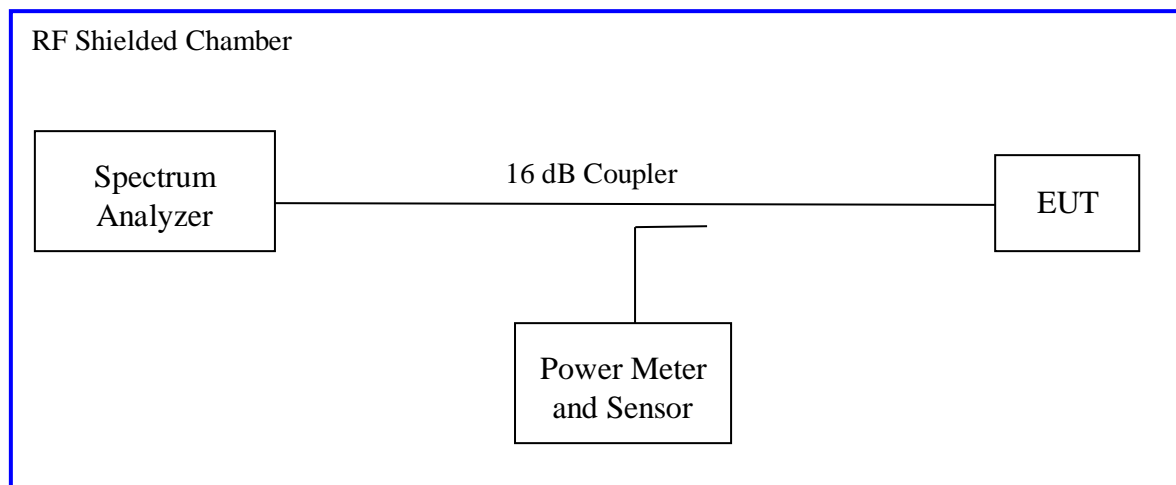

### 4.2.2 Results

These occupied bandwidth measurements were taken for references only.

**Table 7: Occupied Bandwidth – Test Results**

<b>Test Conditions:</b> Conducted Measurement, Normal Temperature and Voltage only				
<b>Antenna Type:</b> FPCB		<b>Power Setting:</b> See test plan		
<b>Max. Directional Gain:</b> Antenna 5 = + 3.84 dBi; Antenna 6 = + 3.29 dBi				
<b>Total Directional Gain:</b> + 6.58 dBi				
<b>Signal State:</b> Modulated at 100%.				
<b>Ambient Temp.:</b> 21° C		<b>Relative Humidity:</b> 39%		
<b>Bandwidth (MHz) for 802.11a</b>				
Freq. (MHz)	6dB Bandwidth (MHz)		99% Bandwidth (MHz)	
	Ch0	Ch1	Ch0	Ch1
5745	16.52	16.37	16.367	16.376
5785	16.46	15.92	16.541	20.600
5825	16.35	16.48	16.377	16.363
<b>Note:</b> 1. The bandwidth was measured at 6.0 Mbps. 2. Plots for all the measurements stated above were taken, to reduce complexity and bulkiness of the report Highlighted Plots are placed in the report.				
<b>Bandwidth (MHz) for 802.11n</b>				
Freq. (MHz)	6dB Bandwidth (MHz)		99% Bandwidth (MHz)	
	Ch0	Ch1	Ch0	Ch1
5745	17.59	17.58	17.587	17.566
5785	17.57	17.55	17.711	21.062
5825	17.54	17.64	17.583	17.584
<b>Note:</b> 1. The bandwidth was measured at HT20 MCS0, 1 Data Streams 2. Plots for all the measurements stated above were taken, to reduce complexity and bulkiness of the report Highlighted Plots are placed in the report.				

**Table 8: Occupied Bandwidth – Test Results Continued**

<b>Test Conditions:</b> Conducted Measurement, Normal Temperature and Voltage only				
<b>Antenna Type:</b> FPCB		<b>Power Setting:</b> See test plan		
<b>Max. Directional Gain:</b> Antenna 5 = + 3.84 dBi; Antenna 6 = + 3.29 dBi				
<b>Total Directional Gain:</b> + 6.58 dBi				
<b>Signal State:</b> Modulated at 100%.				
<b>Ambient Temp.:</b> 21° C		<b>Relative Humidity:</b> 39%		
<b>Bandwidth (MHz) for 802.11n</b>				
Freq. (MHz)	6dB Bandwidth (MHz)		99% Bandwidth (MHz)	
	Ch0	Ch1	Ch0	Ch1
5755	36.27	35.03	35.976	35.944
5795	35.02	34.97	35.903	35.861
<b>Note:</b> 1. The bandwidth was measured at HT40 MCS0, 1 Data Streams 2. Plots for all the measurements stated above were taken, to reduce complexity and bulkiness of the report Highlighted Plots are placed in the report.				
<b>Bandwidth (MHz) for 802.11ac</b>				
Freq. (MHz)	6dB Bandwidth (MHz)		99% Bandwidth (MHz)	
	Ch0	Ch1	Ch0	Ch1
5755	33.83	33.84	35.960	35.924
5795	34.42	35.07	35.895	35.845
<b>Note:</b> 1. The bandwidth was measured at VHT40 MCS0, 1 Data Streams 2. Plots for all the measurements stated above were taken, to reduce complexity and bulkiness of the report Highlighted Plots are placed in the report.				
<b>Bandwidth (MHz) for 802.11ac</b>				
Freq. (MHz)	6dB Bandwidth (MHz)		99% Bandwidth (MHz)	
	Ch0	Ch1	Ch0	Ch1
5775	74.17	75.26	75.529	75.381
<b>Note:</b> 1. The bandwidth was measured at VHT80 MCS0, 1 Data Streams 2. Plots for all the measurements stated above were taken, to reduce complexity and bulkiness of the report Highlighted Plots are placed in the report.				

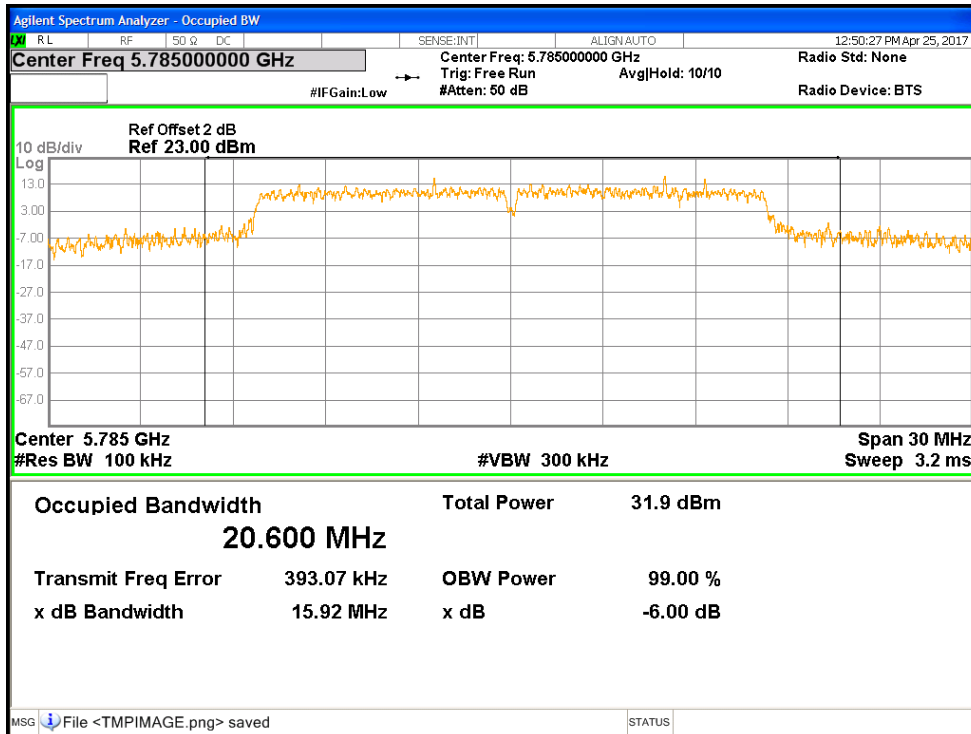

Figure 11: 6dB & 99% Occupied Bandwidth, 5785 MHz at 802.11a 6Mbps, Chain 1

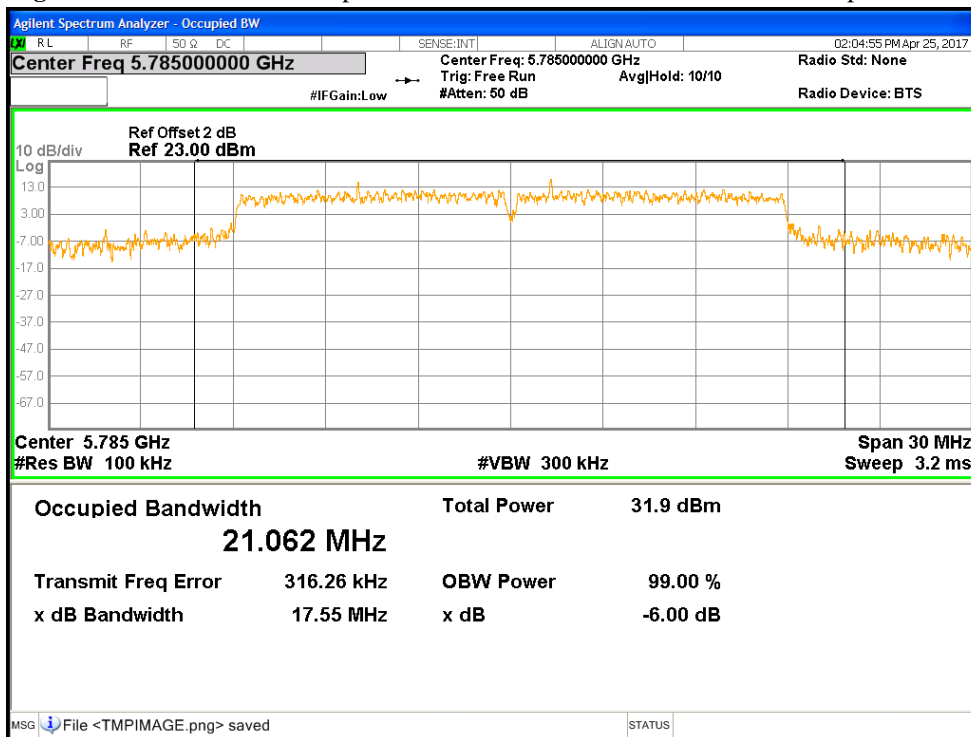

Figure 12: 6dB & 99% Occupied Bandwidth, 5785 MHz at HT20 MCS0, Chain 1

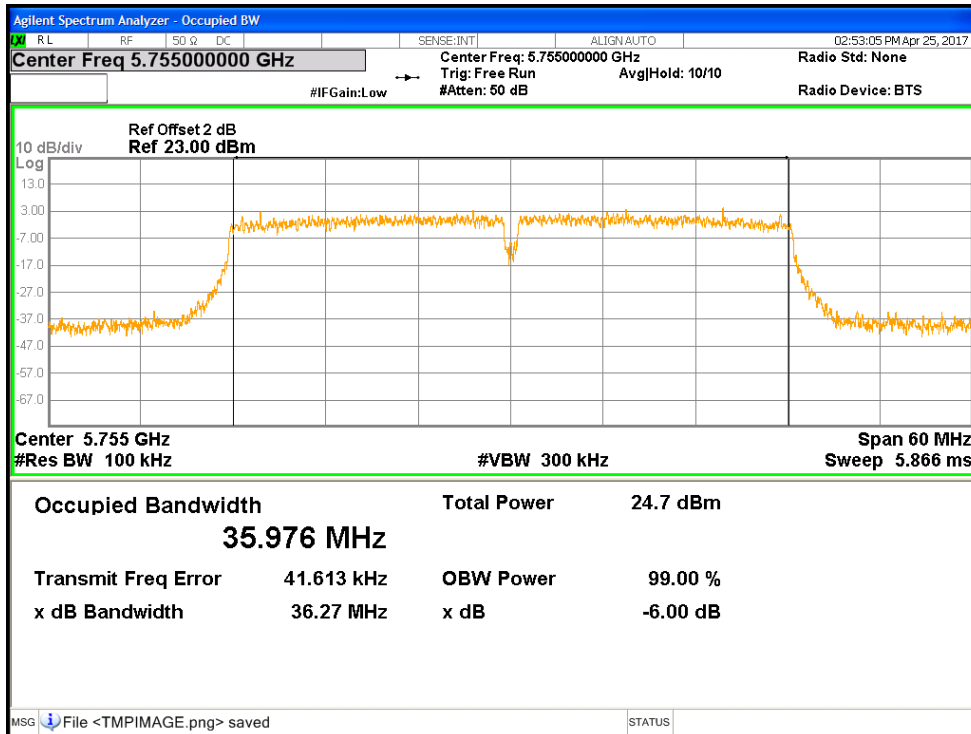

Figure 13: 6dB & 99% Occupied Bandwidth, 5755 MHz at HT40 MCS0, Chain 0

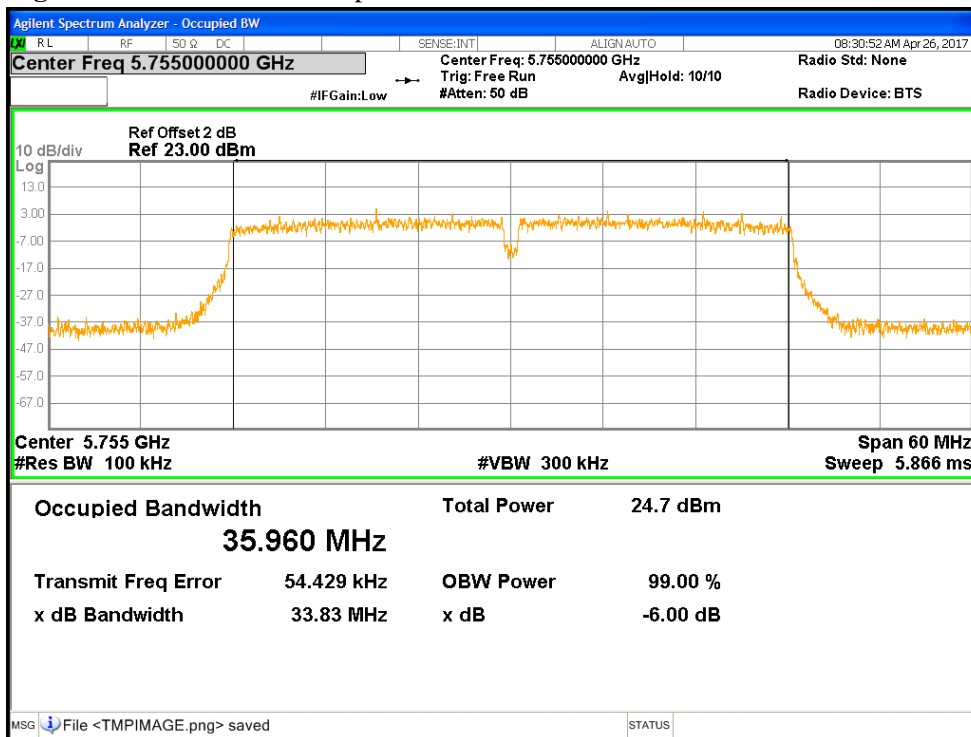

Figure 14: 6dB & 99% Occupied Bandwidth, 5755 MHz at VHT40 MCS0, Chain 0

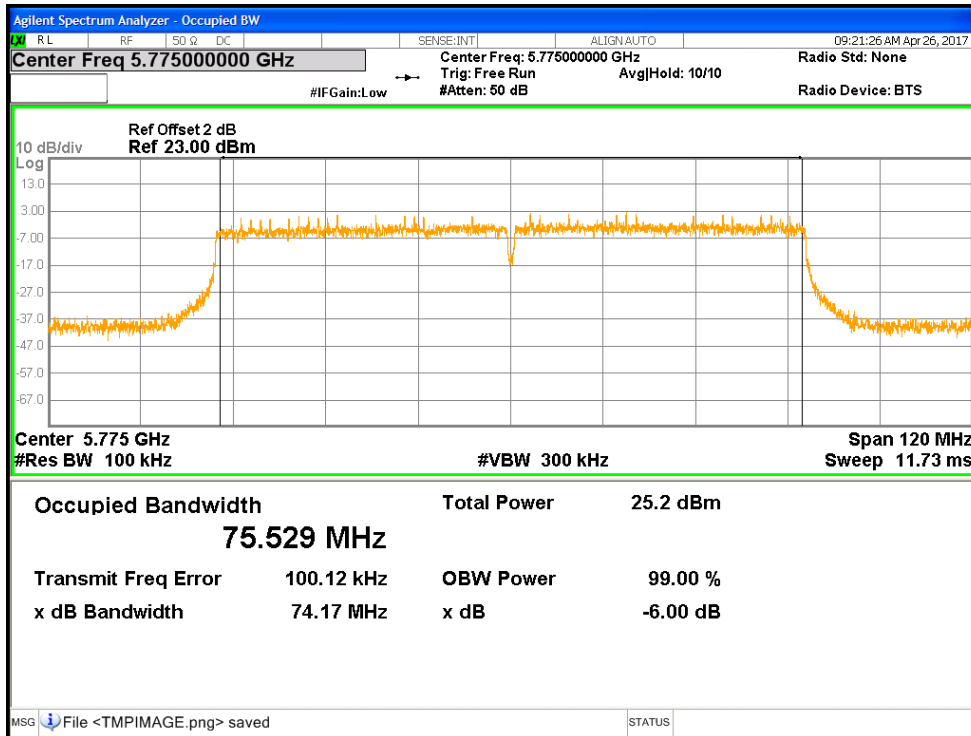

Figure 15: 6dB & 99% Occupied Bandwidth, 5775 MHz at VHT80 MCS0, Chain 0

### 4.3 Peak Power Spectral Density

According to the CFR47 Part 15.407 (a) and RSS 247 Sect.6.2.4.1, in the 5.725 – 5.85 GHz band, the maximum power spectral density shall not exceed 30 dBm in any 500kHz band, during any time interval of continuous transmission.

#### 4.3.1 Test Method

The conducted method was used to measure the channel power output per ANSI C63.10-2013 Section 6.11.2. The measurement was performed with modulation per CFR47 Part 15.407 (a) and RSS 247 Sect.6.2.4.1. The pre-evaluation was performed to find the worst modes. The worst findings were conducted on 3 channels in each operating frequency range of 5725 MHz to 5850 MHz. The worst sample result indicated below.

Test Setup:

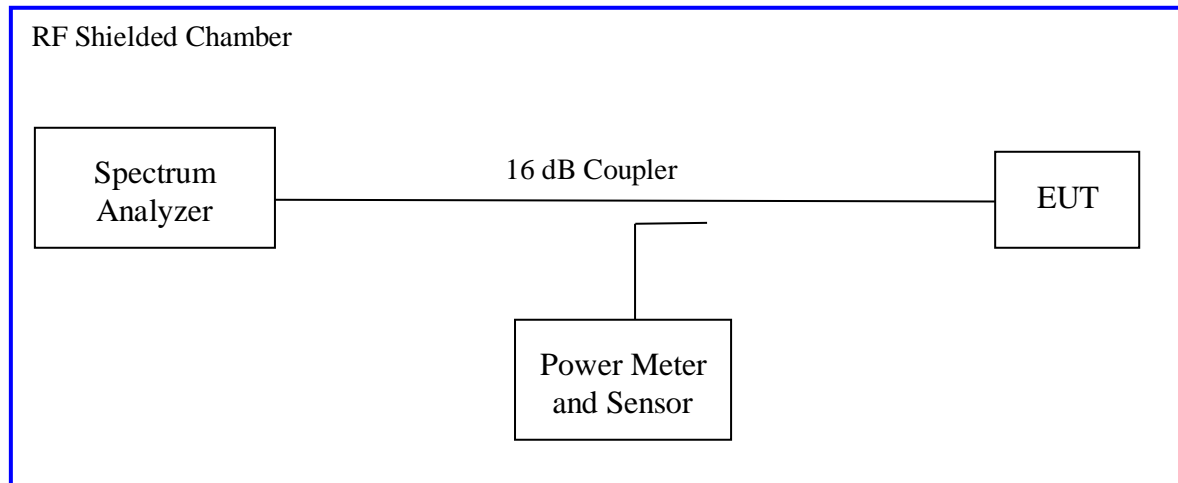



### 4.3.2 Results

As originally tested, the EUT was found to be compliant to the requirements of the test standard(s).

**Table 9: Peak Power Spectral Density – Test Results – Non Beamforming**

<b>Test Conditions:</b> Conducted Measurement, Normal Temperature and Voltage only					
<b>Antenna Type:</b> FPCB			<b>Power Setting:</b> See test plan		
<b>Max. Directional Gain:</b> Antenna 5 = + 3.84 dBi; Antenna 6 = + 3.29 dBi					
<b>Signal State:</b> Modulated at 100%.					
<b>Ambient Temp.:</b> 21° C			<b>Relative Humidity:</b> 39%		
<b>Peak Power Spectral Density</b>					
<b>802.11a</b>					
Freq. (MHz)	Ch0 [dBm/MHz]	Ch1 [dBm/MHz]	Total PSD [dBm/MHz]	Limit [dBm/MHz]	Margin [dB]
5745	8.888	9.657	12.291	30.000	-17.709
5765	13.712	14.027	16.881	30.000	-13.119
5785	15.420	15.905	18.676	30.000	-11.324
5805	14.312	14.621	17.478	30.000	-12.522
5825	9.958	10.864	13.433	30.000	-16.567
<b>Note:</b> 1. The highest peak power spectral density was observed at <b>11a 6Mbps</b> per data stream. 2. The sum of Ch0 and Ch1 = Total PSD. 3. Limited numbers of plots are placed in the report.					
<b>802.11n</b>					
Freq. (MHz)	Ch0 [dBm/MHz]	Ch1 [dBm/MHz]	Total PSD [dBm/MHz]	Limit [dBm/MHz]	Margin [dB]
5745	9.090	9.706	12.414	30.000	-17.586
5765	13.262	13.826	16.559	30.000	-13.441
5785	15.174	15.594	18.397	30.000	-11.603
5805	14.039	14.162	17.111	30.000	-12.889
5825	9.488	10.330	12.929	30.000	-17.071
<b>Note:</b> 1. The highest peak power spectral density was observed at <b>HT20 MCS0</b> per data stream. 2. The sum of Ch0 and Ch1 = Total PSD. 3. Limited numbers of plots are placed in the report.					

**Table 10: Peak Power Spectral Density – Test Results – Non Beamforming Continued**

<b>Test Conditions:</b> Conducted Measurement, Normal Temperature and Voltage only					
<b>Antenna Type:</b> FPCB			<b>Power Setting:</b> See test plan		
<b>Max. Directional Gain:</b> Antenna 5 = + 3.84 dBi; Antenna 6 = + 3.29 dBi					
<b>Signal State:</b> Modulated at 100%.					
<b>Ambient Temp.:</b> 21° C			<b>Relative Humidity:</b> 39%		
<b>Peak Power Spectral Density</b>					
<b>802.11n</b>					
Freq. (MHz)	Ch0 [dBm/MHz]	Ch1 [dBm/MHz]	Total PSD [dBm/MHz]	Limit [dBm/MHz]	Margin [dB]
5755	5.384	6.390	8.912	30.000	-21.088
5795	6.772	7.416	10.110	30.000	-19.890
<b>Note:</b> 1. The highest peak power spectral density was observed at <b>HT40 MCS0</b> per data stream. 2. The sum of Ch0 and Ch1 = Total PSD. 3. Limited numbers of plots are placed in the report.					
<b>802.11ac</b>					
Freq. (MHz)	Ch0 [dBm/MHz]	Ch1 [dBm/MHz]	Total PSD [dBm/MHz]	Limit [dBm/MHz]	Margin [dB]
5755	5.477	6.184	8.848	30.000	-21.152
5795	7.588	8.451	11.041	30.000	-18.959
<b>Note:</b> 1. The highest peak power spectral density was observed at <b>VHT40 MCS0</b> per data stream. 2. The sum of Ch0 and Ch1 = Total PSD. 3. Limited numbers of plots are placed in the report.					
<b>802.11ac</b>					
Freq. (MHz)	Ch0 [dBm/MHz]	Ch1 [dBm/MHz]	Total PSD [dBm/MHz]	Limit [dBm/MHz]	Margin [dB]
5775	2.255	2.818	5.551	30.000	-24.449
<b>Note:</b> 1. The highest peak power spectral density was observed at <b>VHT80 MCS0</b> per data stream. 2. The sum of Ch0 and Ch1 = Total PSD. 3. Limited numbers of plots are placed in the report.					

**Table 11: Peak Power Spectral Density – Test Results – Beamforming**

<b>Test Conditions:</b> Conducted Measurement, Normal Temperature and Voltage only					
<b>Antenna Type:</b> FPCB			<b>Power Setting:</b> See test plan		
<b>Total Directional Gain:</b> + 6.58 dBi					
<b>Signal State:</b> Modulated at 100%.					
<b>Ambient Temp.:</b> 21° C			<b>Relative Humidity:</b> 39%		
<b>Peak Power Spectral Density</b>					
<b>802.11a</b>					
<b>Freq. (MHz)</b>	<b>Ch0 [dBm/MHz]</b>	<b>Ch1 [dBm/MHz]</b>	<b>Total PSD [dBm/MHz]</b>	<b>Limit [dBm/MHz]</b>	<b>Margin [dB]</b>
5745	8.888	9.657	12.291	29.420	-17.129
5765	13.712	14.027	16.881	29.420	-12.539
5785	15.420	15.905	18.676	29.420	-10.744
5805	14.312	14.621	17.478	29.420	-11.942
5825	9.958	10.864	13.433	29.420	-15.987
<b>Note:</b> 1. The highest peak power spectral density was observed at <b>6Mbps</b> 2 data streams. 2. The sum of Ch0 and Ch1 = Total PSD. 3. Limited numbers of plots are placed in the report.					
<b>802.11n</b>					
<b>Freq. (MHz)</b>	<b>Ch0 [dBm/MHz]</b>	<b>Ch1 [dBm/MHz]</b>	<b>Total PSD [dBm/MHz]</b>	<b>Limit [dBm/MHz]</b>	<b>Margin [dB]</b>
5745	9.090	9.706	12.414	29.420	-17.006
5765	13.262	13.826	16.559	29.420	-12.861
5785	15.174	15.594	18.397	29.420	-11.023
5805	14.039	14.162	17.111	29.420	-12.309
5825	9.488	10.330	12.929	29.420	-16.491
<b>Note:</b> 1. The highest peak power spectral density was observed at <b>HT20 MCS0</b> 2 data streams. 2. The sum of Ch0 and Ch1 = Total PSD. 3. Limited numbers of plots are placed in the report.					

**Table 12: Peak Power Spectral Density – Test Results – Beamforming Continued**

<b>Test Conditions:</b> Conducted Measurement, Normal Temperature and Voltage only					
<b>Antenna Type:</b> FPCB			<b>Power Setting:</b> See test plan		
<b>Total Directional Gain:</b> + 6.58 dBi					
<b>Signal State:</b> Modulated at 100%.					
<b>Ambient Temp.:</b> 21° C			<b>Relative Humidity:</b> 39%		
<b>Peak Power Spectral Density</b>					
<b>802.11n</b>					
Freq. (MHz)	Ch0 [dBm/MHz]	Ch1 [dBm/MHz]	Total PSD [dBm/MHz]	Limit [dBm/MHz]	Margin [dB]
5755	5.384	6.390	8.912	29.420	-20.508
5795	6.772	7.416	10.110	29.420	-19.310
<b>Note:</b> 1. The highest peak power spectral density was observed at <b>HT40 MCS0</b> 2 data streams. 2. The sum of Ch0 and Ch1 = Total PSD. 3. Limited numbers of plots are placed in the report.					
<b>802.11ac</b>					
Freq. (MHz)	Ch0 [dBm/MHz]	Ch1 [dBm/MHz]	Total PSD [dBm/MHz]	Limit [dBm/MHz]	Margin [dB]
5755	5.477	6.184	8.848	29.420	-20.572
5795	7.588	8.451	11.041	29.420	-18.379
<b>Note:</b> 1. The highest peak power spectral density was observed at <b>VHT40 MCS0</b> 2 data streams. 2. The sum of Ch0 and Ch1 = Total PSD. 3. Limited numbers of plots are placed in the report.					
<b>802.11ac</b>					
Freq. (MHz)	Ch0 [dBm/MHz]	Ch1 [dBm/MHz]	Total PSD [dBm/MHz]	Limit [dBm/MHz]	Margin [dB]
5775	2.255	2.818	5.551	29.420	-23.869
<b>Note:</b> 1. The highest peak power spectral density was observed at <b>VHT80 MCS0</b> 2 data streams. 2. The sum of Ch0 and Ch1 = Total PSD. 3. Limited numbers of plots are placed in the report.					

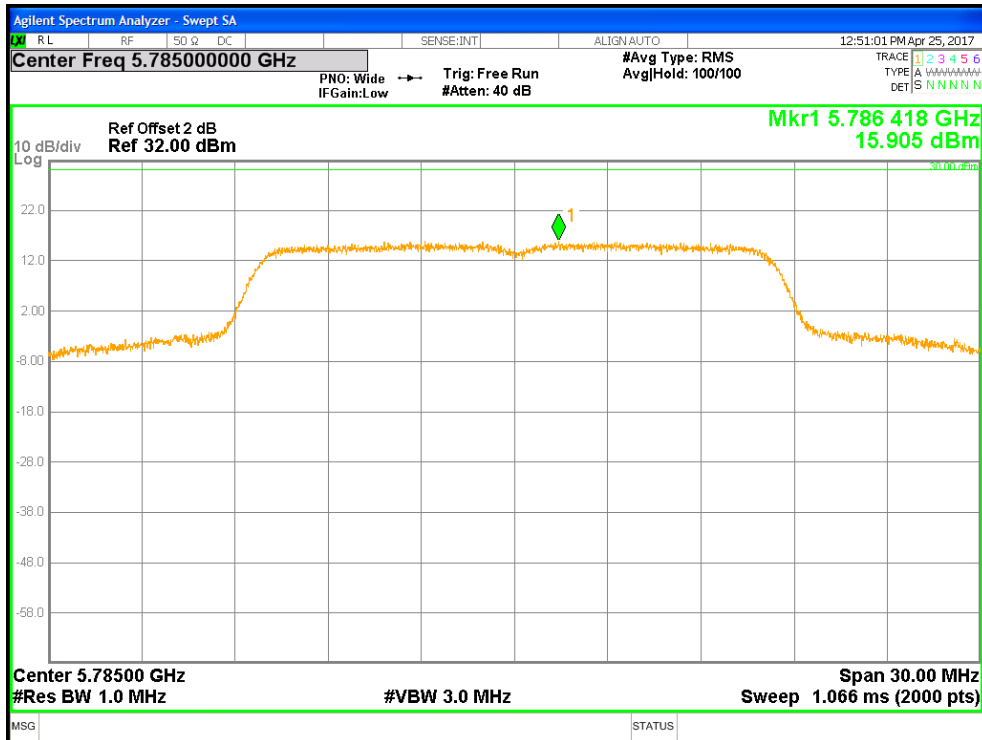

Figure 16: Non Beamforming Power Spectral Density, 5785 MHz at 802.11a, Chain 1

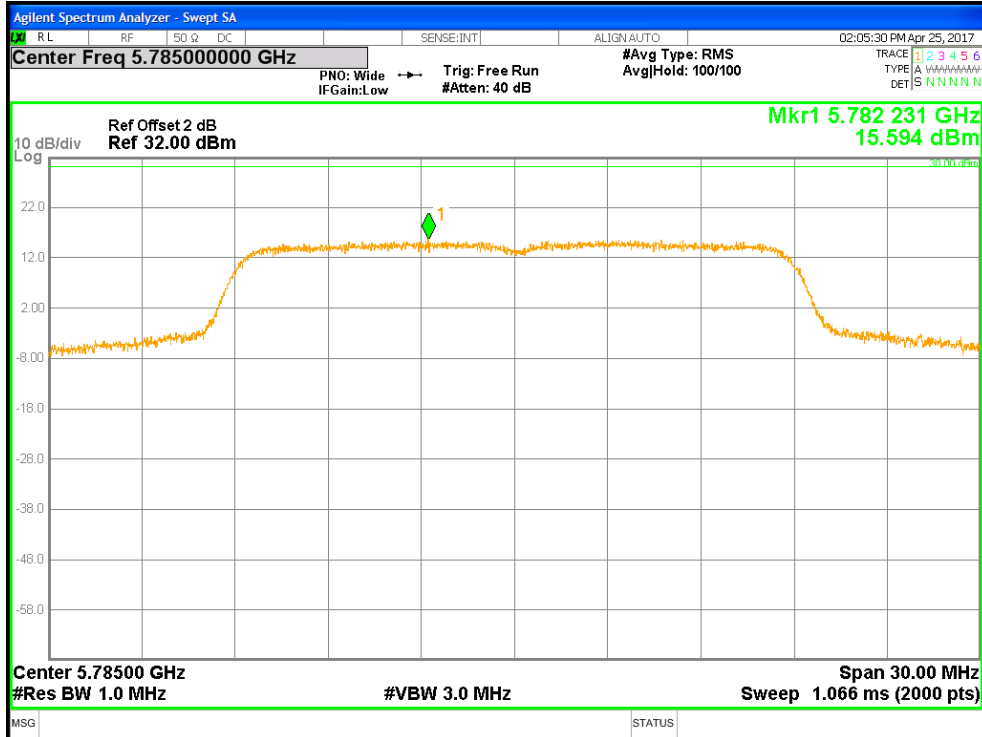

Figure 17: Non Beamforming Power Spectral Density, 5785 MHz at HT20, Chain 1

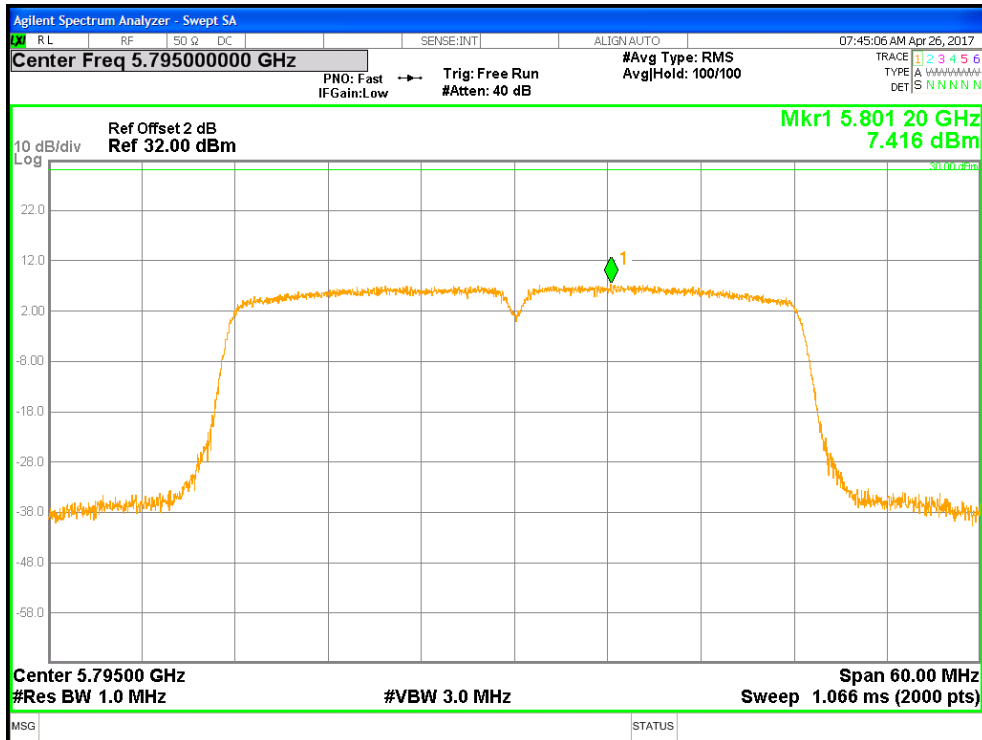

Figure 18: Non Beamforming Power Spectral Density, 5795 MHz at HT40, Chain 1

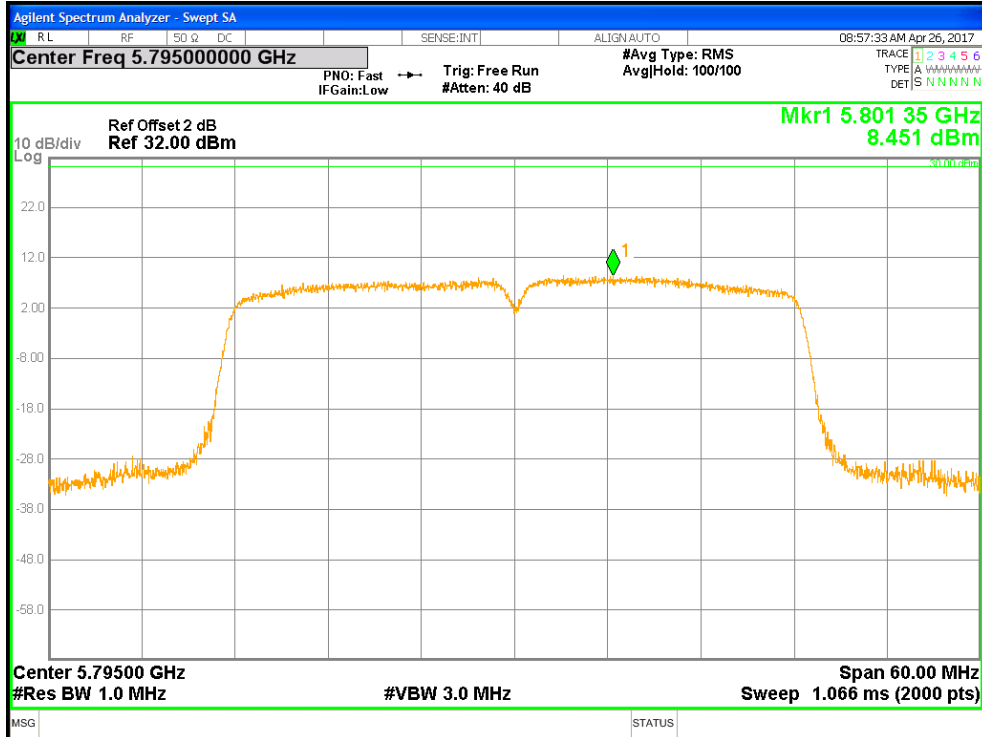

Figure 19: Non Beamforming Power Spectral Density, 5795 MHz at VHT40, Chain 1

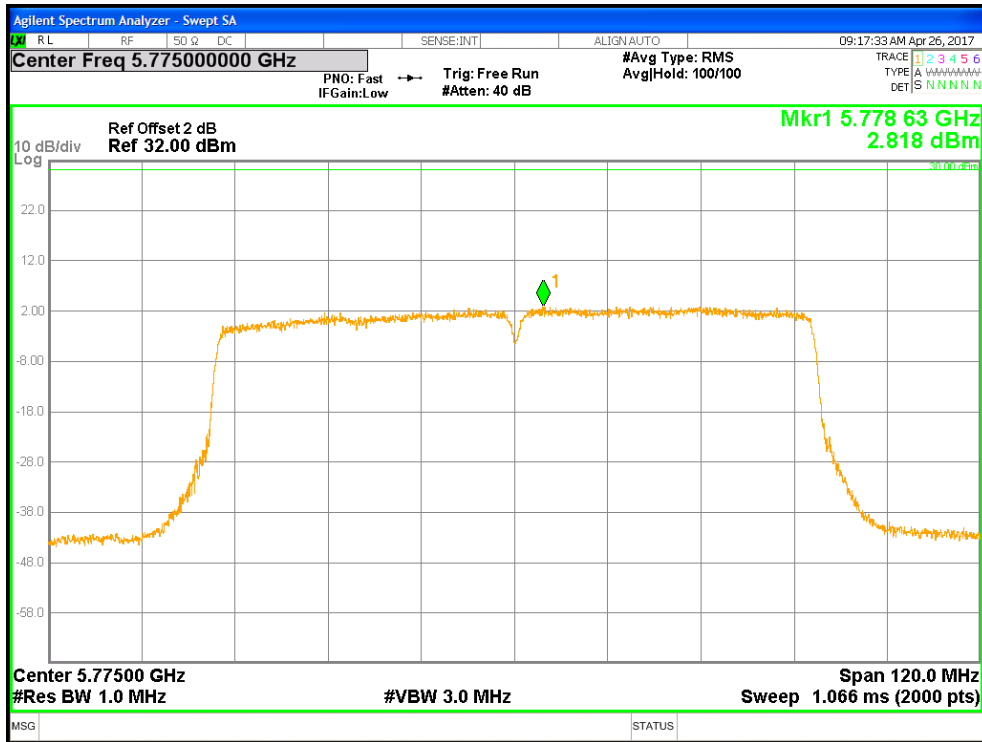

Figure 20: Non Beamforming Power Spectral Density, 5775 MHz at VHT80, Chain 1

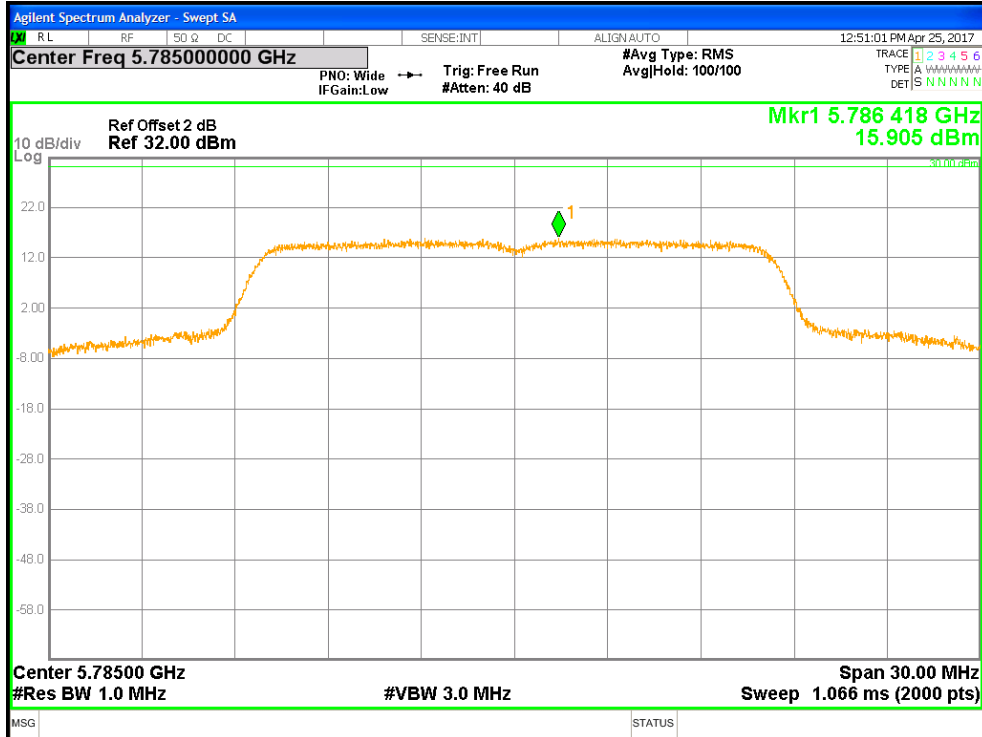

Figure 21: Beamforming Power Spectral Density, 5785 MHz at 802.11a, Chain 1

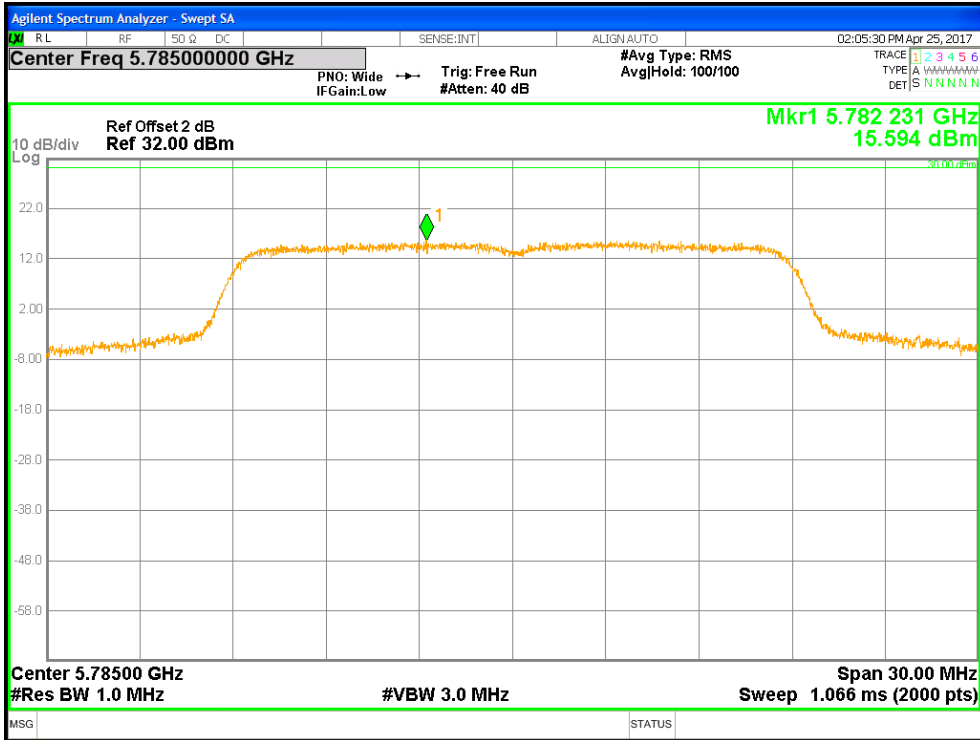

Figure 22: Beamforming Power Spectral Density, 5785 MHz at HT20, Chain 1

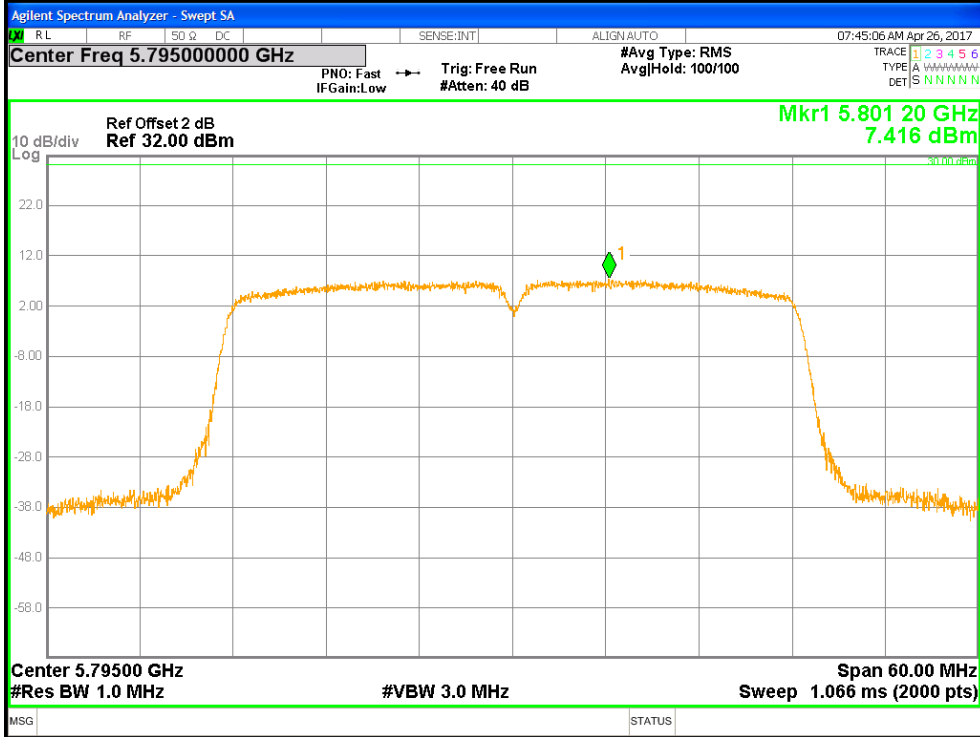

Figure 23: Beamforming Power Spectral Density, 5795 MHz at HT40, Chain 1



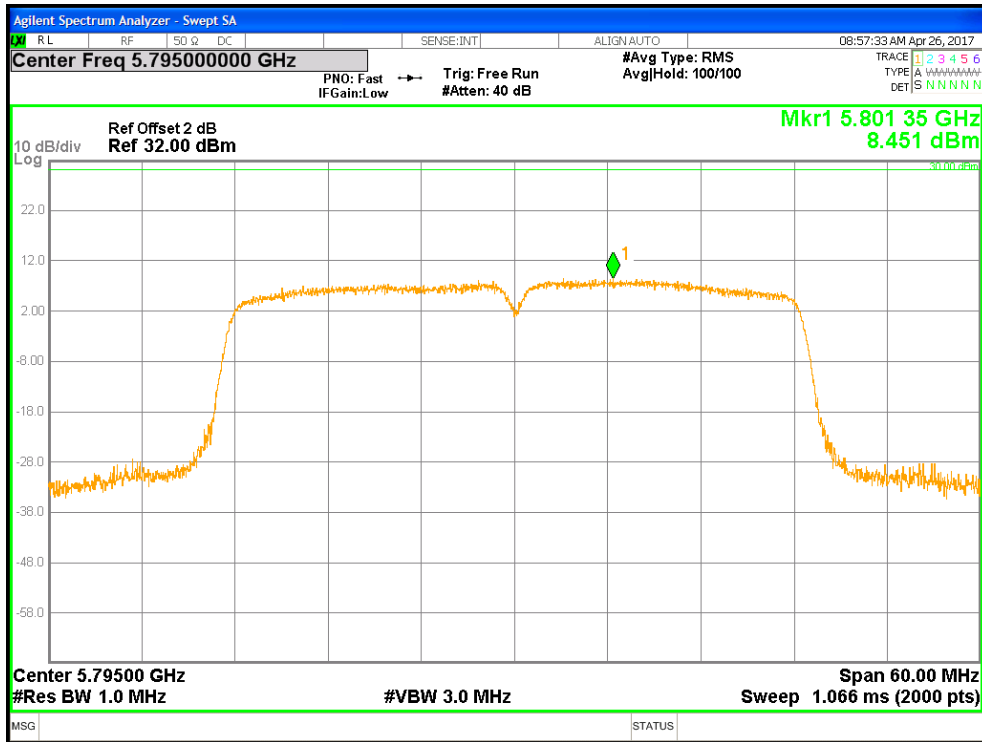

Figure 24: Beamforming Power Spectral Density, 5795 MHz at VHT40, Chain 1

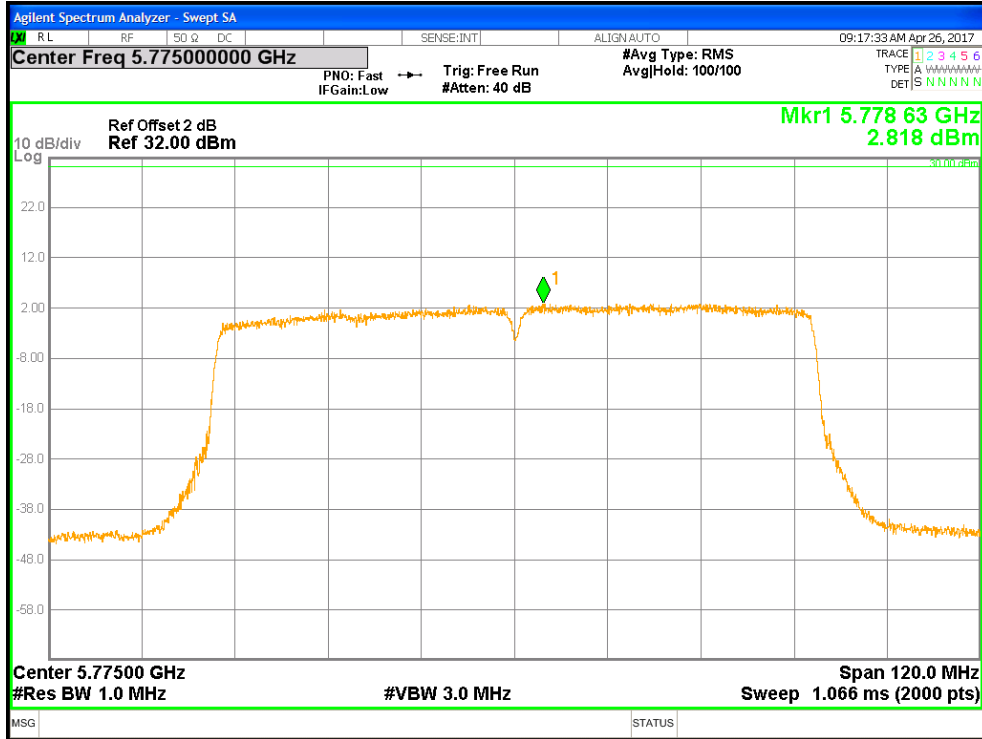

Figure 25: Beamforming Power Spectral Density, 5775 MHz at VHT80, Chain 1

#### 4.4 Undesirable Emission Limits

CFR47 15.407 (b) and RSS 247 Sect.6.2.4.2: The maximum emissions outside of the frequency bands of operation shall be attenuated in accordance with the following limits:

For transmitters operating in the 5.725-5.85 GHz band: All emissions shall be limited to a level of:

- a) 27 dBm/MHz at frequencies from the band edges decreasing linearly to 15.6 dBm/MHz at 5 MHz above or below the band edges;
- b) 15.6 dBm/MHz at 5 MHz above or below the band edges decreasing linearly to 10 dBm/MHz at 25 MHz above or below the band edges;
- c) 10 dBm/MHz at 25 MHz above or below the band edges decreasing linearly to -27 dBm/MHz at 75 MHz above or below the band edges; and
- d) -27 dBm/MHz at frequencies more than 75 MHz above or below the band edges.

##### 4.4.1 Test Method

The conducted method was used to measure the undesirable emission requirement. The measurement was performed with modulation. This test was conducted on 3 channels of Sample in each mode on Sample. The worst sample result indicated below.

Final Scan: 802.11a, 802.11n (HT20 and HT40), 802.11ac (VHT20, VHT40 and VHT80)

Test Setup:

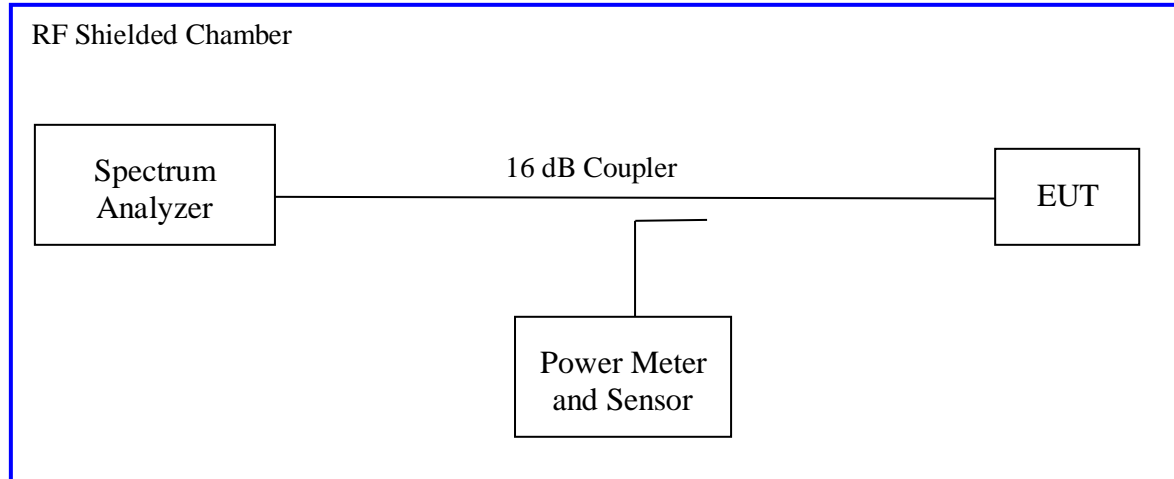

Measurement Procedure AVG2 of KDB 662911

##### 4.4.2 Results

As originally tested, the EUT was found to be compliant to the requirements of the test standard(s).

**Table 13:** Emissions at the Band-Edge – Test Results

<b>Test Conditions:</b> Conducted Measurement, Normal Temperature and Voltage only						
<b>Antenna Type:</b> FPCB			<b>Power Setting:</b> See test plan			
<b>Max. Directional Gain:</b> Antenna 5 = + 3.84 dBi; Antenna 6 = + 3.29 dBi						
<b>Total Directional Gain:</b> + 6.58 dBi						
<b>Signal State:</b> Modulated at 100%.						
<b>Ambient Temp.:</b> 20° C			<b>Relative Humidity:</b> 44%			
<b>Non-Restricted Frequency Band Emission</b>						
Freq. (MHz)	Mode	Chain	Measured (dBm)	Limit (dBm)	Plots	Comment
37218.0	802.11a 6Mbps	0	-31.19	-27.00	Fig. 26, 27	TX at 5745 MHz; TP 19.5
5724.87	802.11a 6Mbps	1	-28.11	-27.00	Fig. 28, 29	TX at 5745 MHz; TP 19.5
5724.38	802.11a 6Mbps	0	-31.17	-27.00	Fig. 30	TX at 5765 MHz; TP 24
5722.49	802.11a 6Mbps	1	-27.72	-27.00	Fig. 31	TX at 5765 MHz; TP 24
39217.9	802.11a 6Mbps	0	-28.85	-27.00	Fig. 32, 33	TX at 5785 MHz; TP 26
38735.6	802.11a 6Mbps	1	-27.88	-27.00	Fig. 34, 35	TX at 5785 MHz; TP 26
5850.36	802.11a 6Mbps	0	-31.38	-27.00	Fig. 36	TX at 5805 MHz; TP 25
5851.02	802.11a 6Mbps	1	-28.53	-27.00	Fig. 37	TX at 5805 MHz; TP 25
36603.8	802.11a 6Mbps	0	-28.85	-27.00	Fig. 38, 39	TX at 5825 MHz; TP 21.5
38726.3	802.11a 6Mbps	1	-28.01	-27.00	Fig. 40, 41	TX at 5825 MHz; TP 21.5
36687.7	HT20-MCS0	0	-31.14	-27.00	Fig. 42, 43	TX at 5745 MHz; TP 20
5724.61	HT20-MCS0	1	-28.30	-27.00	Fig. 44, 45	TX at 5745 MHz; TP 20
5724.71	HT20-MCS0	0	-31.08	-27.00	Fig. 46	TX at 5765 MHz; TP 24
5723.57	HT20-MCS0	1	-27.99	-27.00	Fig. 47	TX at 5765 MHz; TP 24
36302.7	HT20-MCS0	0	-28.99	-27.00	Fig. 48, 49	TX at 5785 MHz; TP 26
Note: All out of band emissions are lower than the 27dBr level.						

**Table 14:** Emissions at the Band-Edge – Test Results Continued

<b>Test Conditions:</b> Conducted Measurement, Normal Temperature and Voltage only						
<b>Antenna Type:</b> FPCB			<b>Power Setting:</b> See test plan			
<b>Max. Directional Gain:</b> Antenna 5 = + 3.84 dBi; Antenna 6 = + 3.29 dBi						
<b>Total Directional Gain:</b> + 6.58 dBi						
<b>Signal State:</b> Modulated at 100%.						
<b>Ambient Temp.:</b> 20° C			<b>Relative Humidity:</b> 44%			
<b>Non-Restricted Frequency Band Emission</b>						
Freq. (MHz)	Mode	Chain	Measured (dBm)	Limit (dBm)	Plots	Comment
39693.6	HT20-MCS0	1	-28.78	-27.00	Fig. 50, 51	TX at 5785 MHz; TP 26
5851.80	HT20-MCS0	0	-29.64	-27.00	Fig. 52	TX at 5805 MHz; TP 25
5853.45	HT20-MCS0	1	-28.25	-27.00	Fig. 53	TX at 5805 MHz; TP 25
36741.0	HT20-MCS0	0	-31.31	-27.00	Fig. 54, 55	TX at 5825 MHz; TP 21.5
37042.1	HT20-MCS0	1	-30.56	-27.00	Fig. 56, 57	TX at 5825 MHz; TP 21.5
36749.0	HT40 MCS0	0	-28.64	-27.00	Fig. 58, 59	TX at 5755 MHz; TP 19
5723.86	HT40 MCS0	1	-28.00	-27.00	Fig. 60, 61	TX at 5755 MHz; TP 19
36731.7	HT40 MCS0	0	-28.94	-27.00	Fig. 62, 63	TX at 5795 MHz; TP 20
36755.7	HT40 MCS0	1	-28.47	-27.00	Fig. 64, 65	TX at 5795 MHz; TP 20
39929.4	VHT40-MCS0	0	-29.52	-27.00	Fig. 66, 67	TX at 5755 MHz; TP 19
5724.49	VHT40-MCS0	1	-27.80	-27.00	Fig. 68, 69	TX at 5755 MHz; TP 19
37187.4	VHT40-MCS0	0	-29.16	-27.00	Fig. 70, 71	TX at 5795 MHz; TP 21
5850.00	VHT40-MCS0	1	-28.46	-27.00	Fig. 72, 73	TX at 5795 MHz; TP 21
37293.9	VHT80 MCS0	0	-28.76	-27.00	Fig. 74, 75	TX at 5775 MHz; TP 19.5
39292.5	VHT80 MCS0	1	-28.77	-27.00	Fig. 76, 77	TX at 5775 MHz; TP 19.5
Note: All out of band emissions are lower than the 27dBr level.						

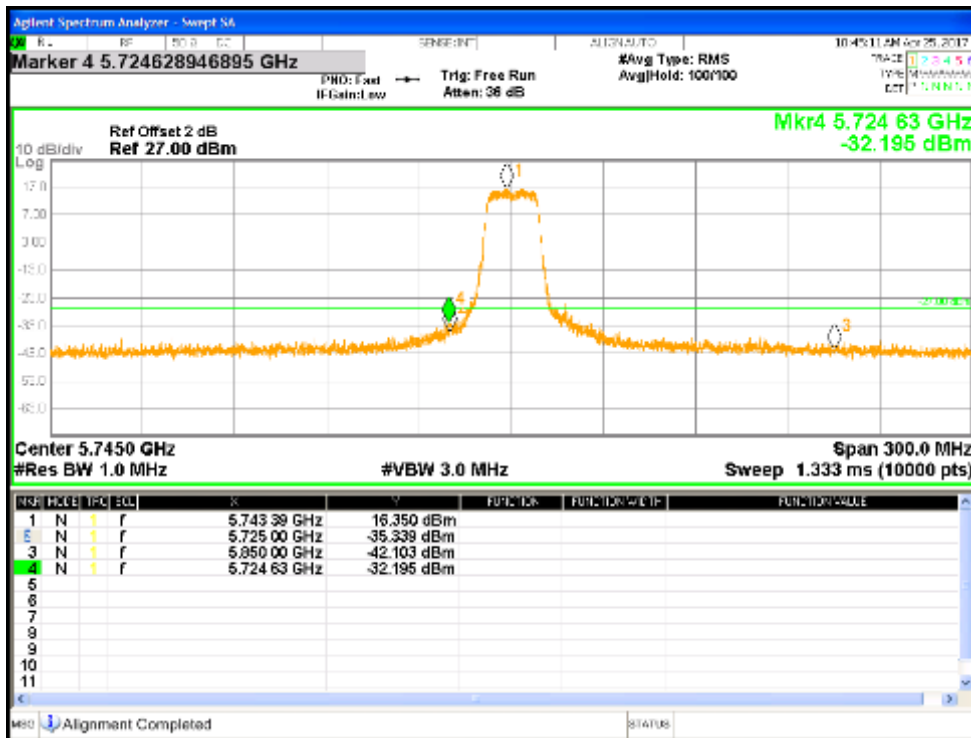

Figure 26: Measured Below Edge for 802.11a-6Mbps at 5745 MHz, Chain 0

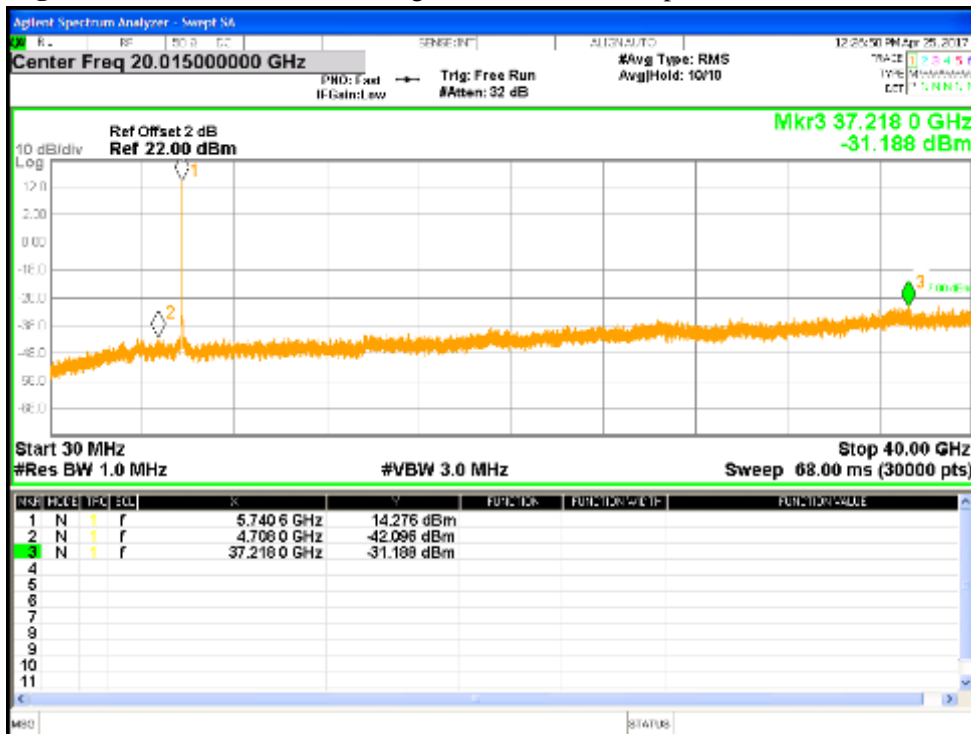

Figure 27: Undesirable Emission for 802.11a-6Mbps at 5745 MHz, Chain 0

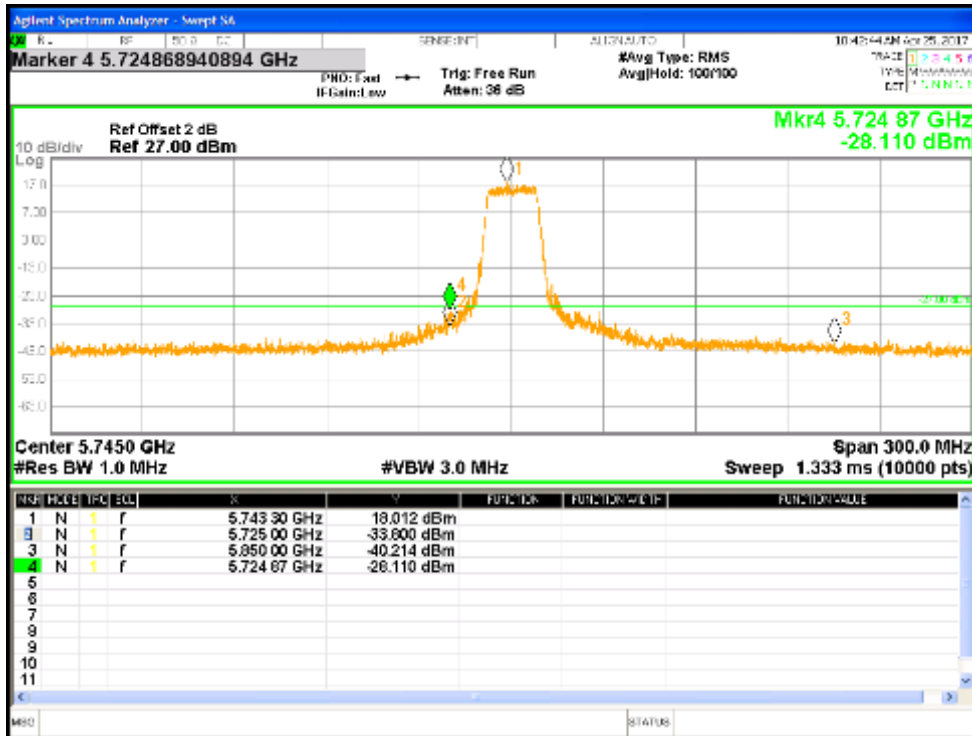

Figure 28: Measured Below Edge for 802.11a-6Mbps at 5745 MHz, Chain 1

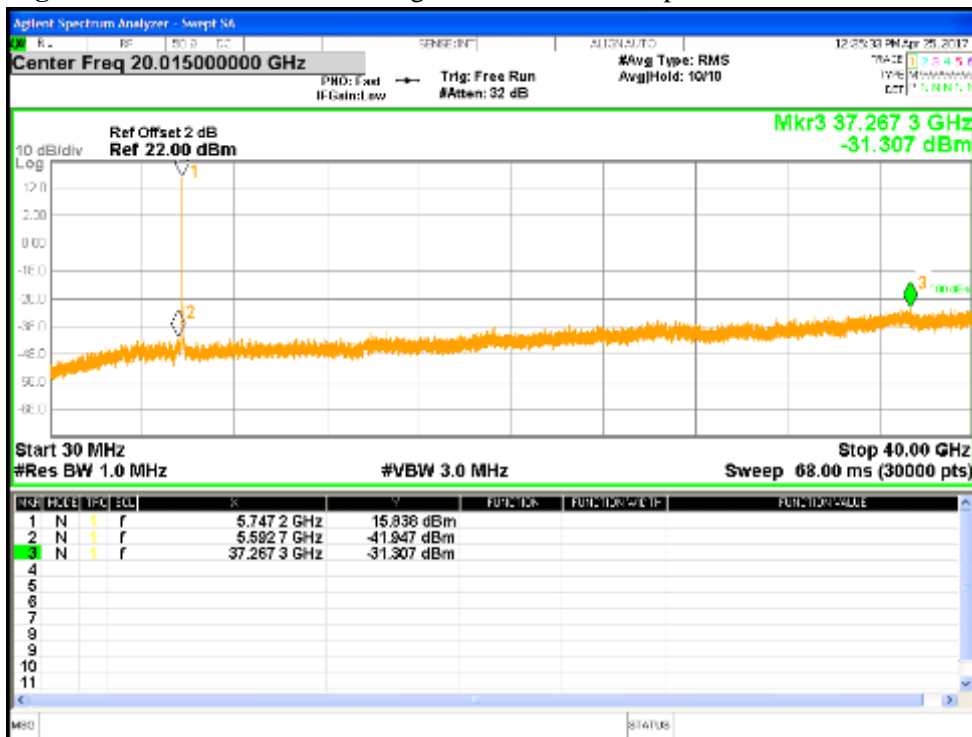

Figure 29: Undesirable Emission for 802.11a-6Mbps at 5745 MHz, Chain 1

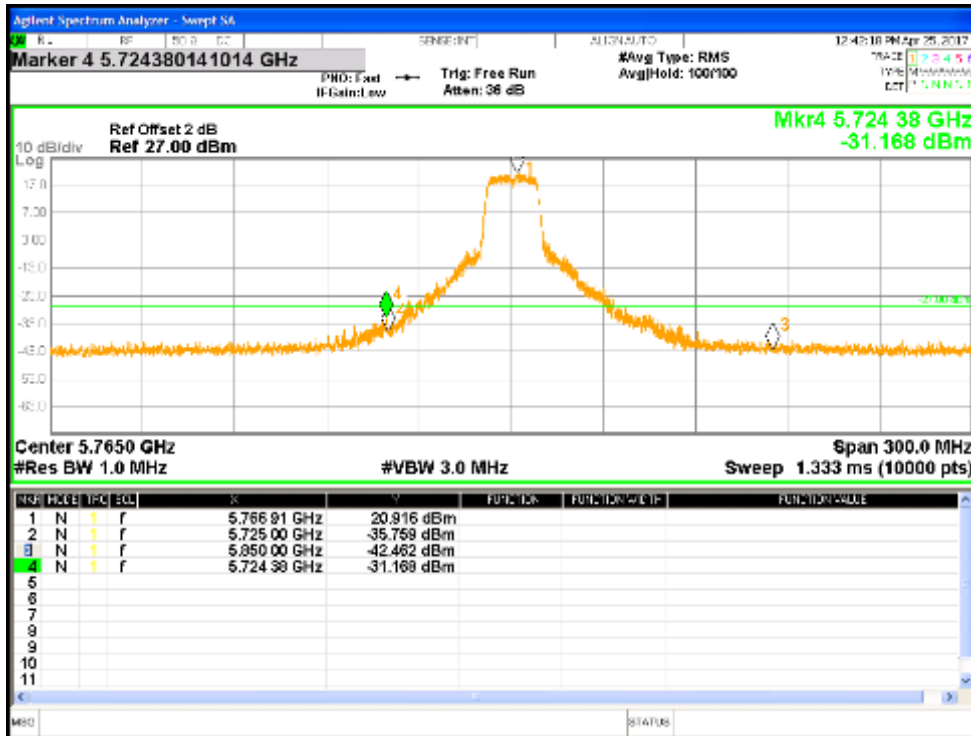

Figure 30: Measured Below Edge for 802.11a-6Mbps at 5765 MHz, Chain 0

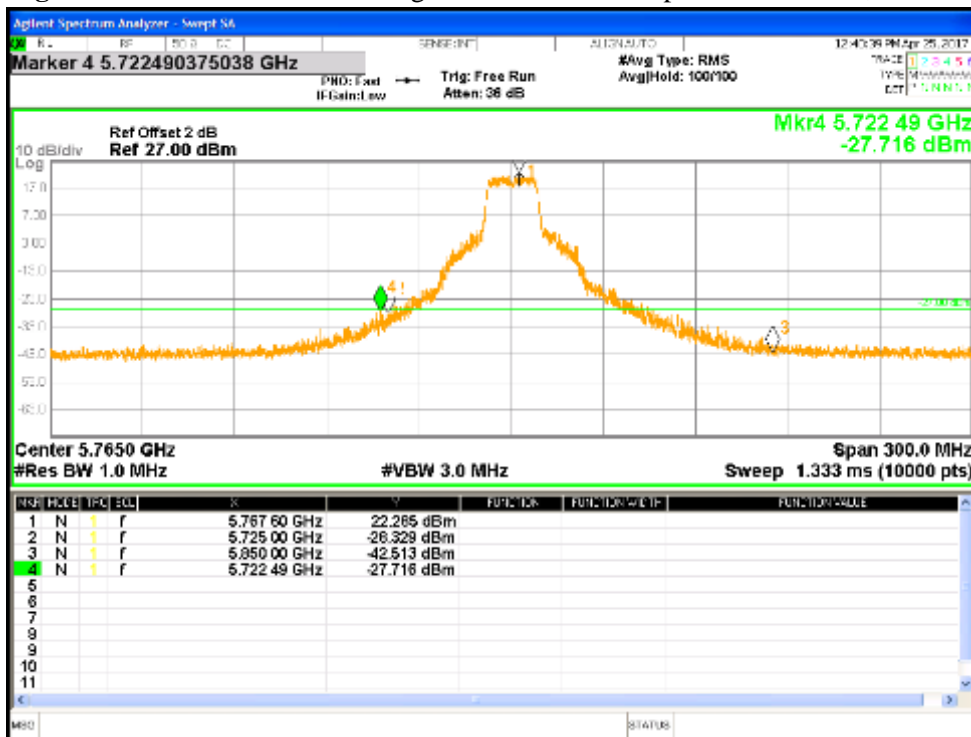

Figure 31: Measured Below Edge for 802.11a-6Mbps at 5765 MHz, Chain 1

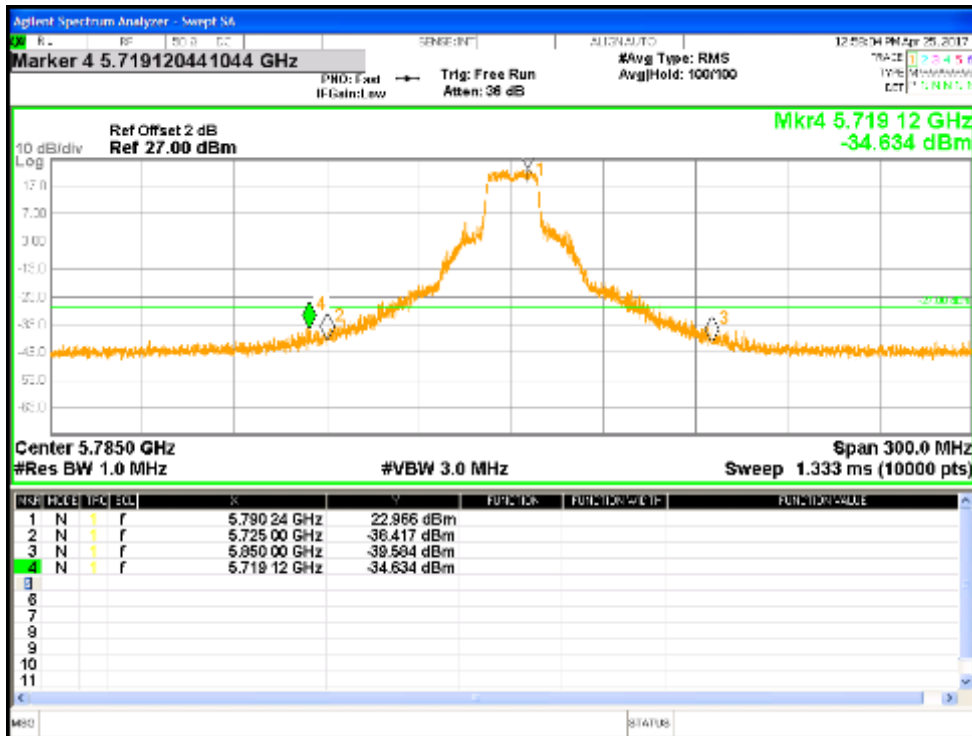

Figure 32: Measured Below Edge for 802.11a-6Mbps at 5785 MHz, Chain 0

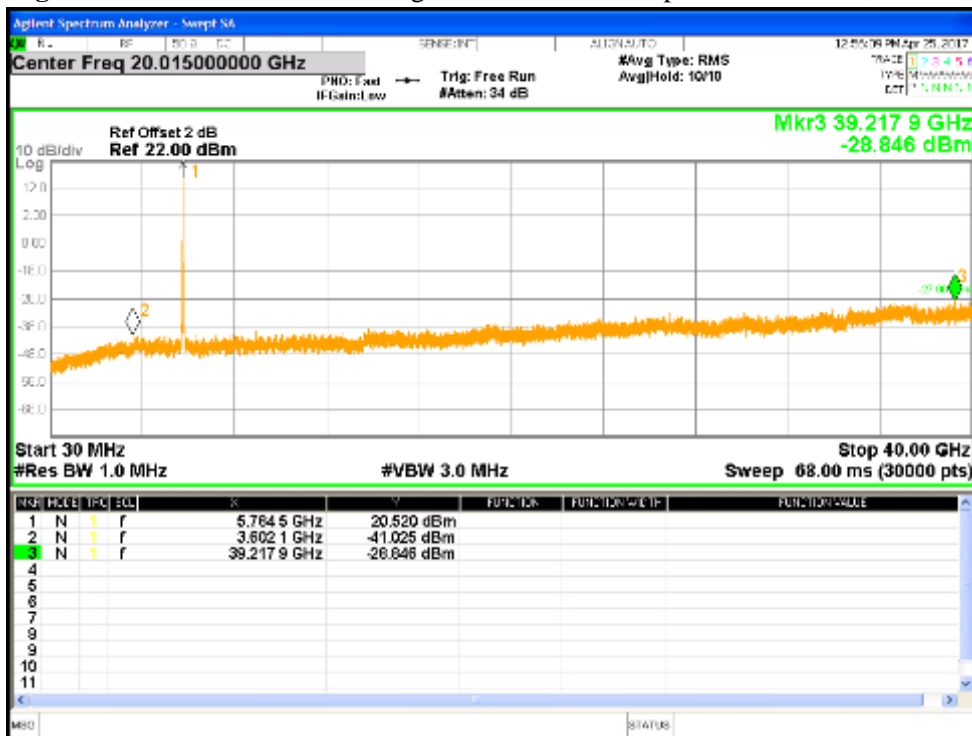

Figure 33: Undesirable Emission for 802.11a-6Mbps at 5785 MHz, Chain 0



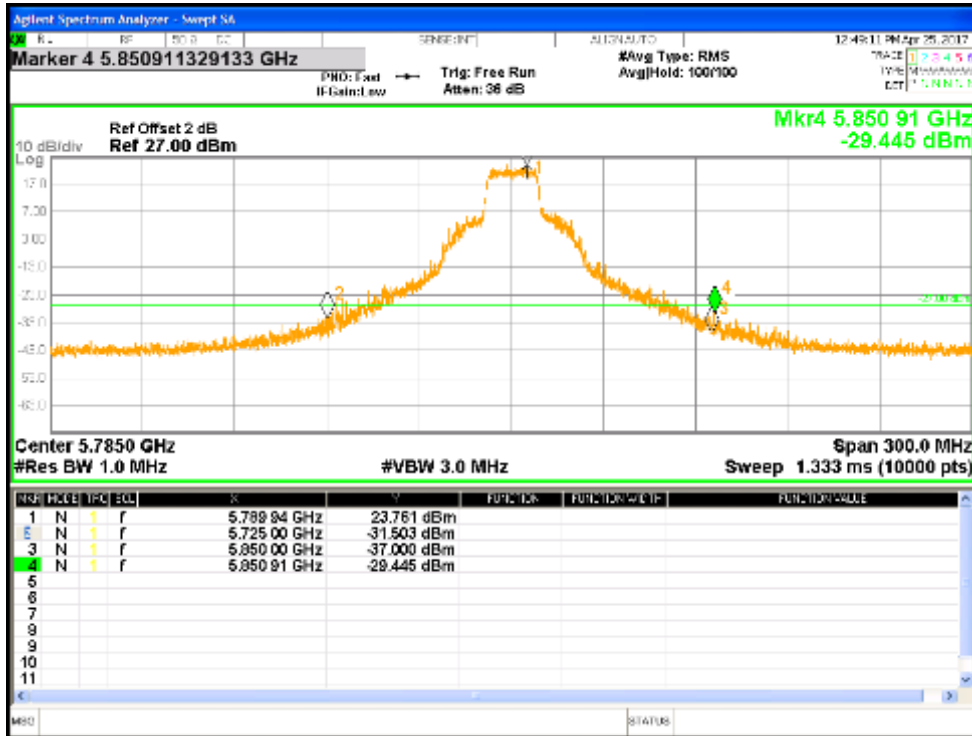

Figure 34: Measured Above Edge for 802.11a-6Mbps at 5785 MHz, Chain 1

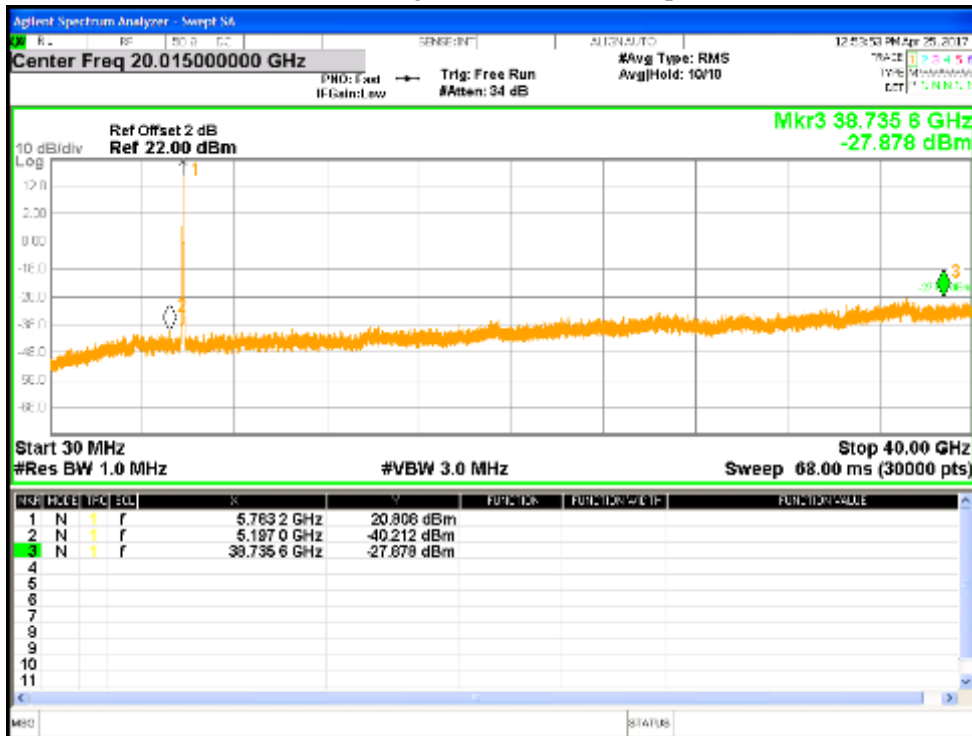

Figure 35: Undesirable Emission for 802.11a-6Mbps at 5785 MHz, Chain 1

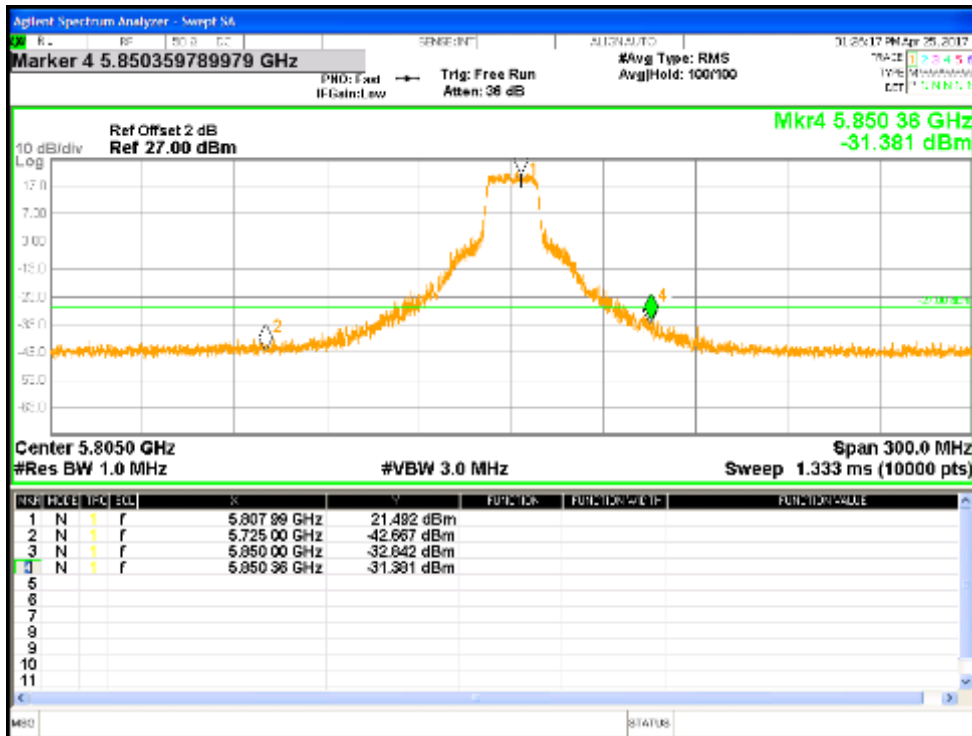

Figure 36: Measured Above Edge for 802.11a-6Mbps at 5805 MHz, Chain 0

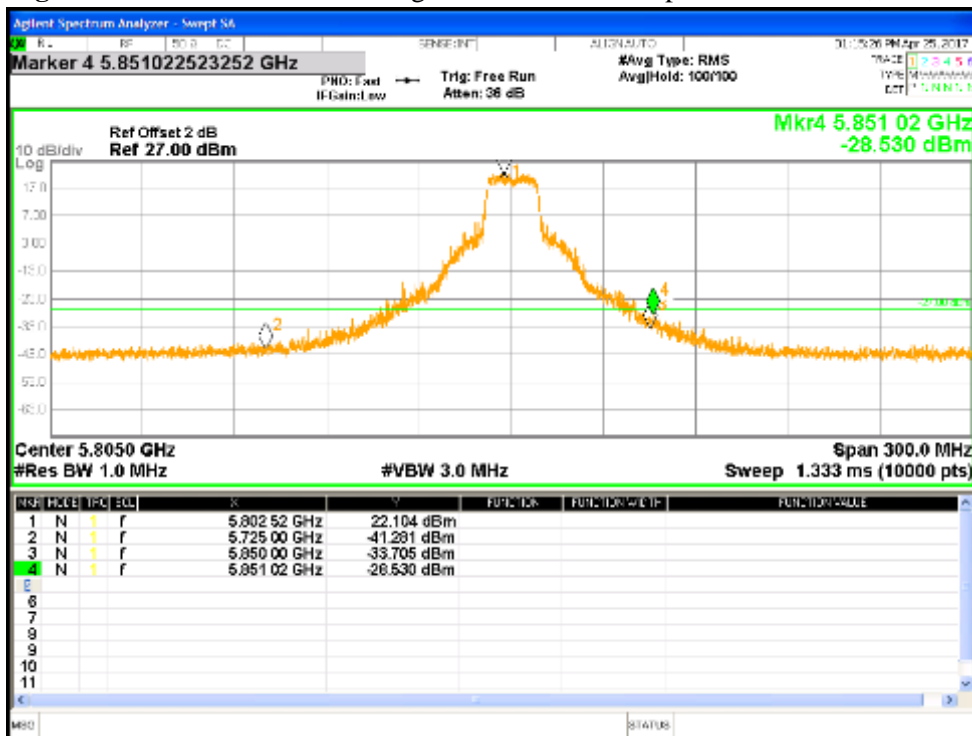

Figure 37: Measured Above Edge for 802.11a-6Mbps at 5805 MHz, Chain 1

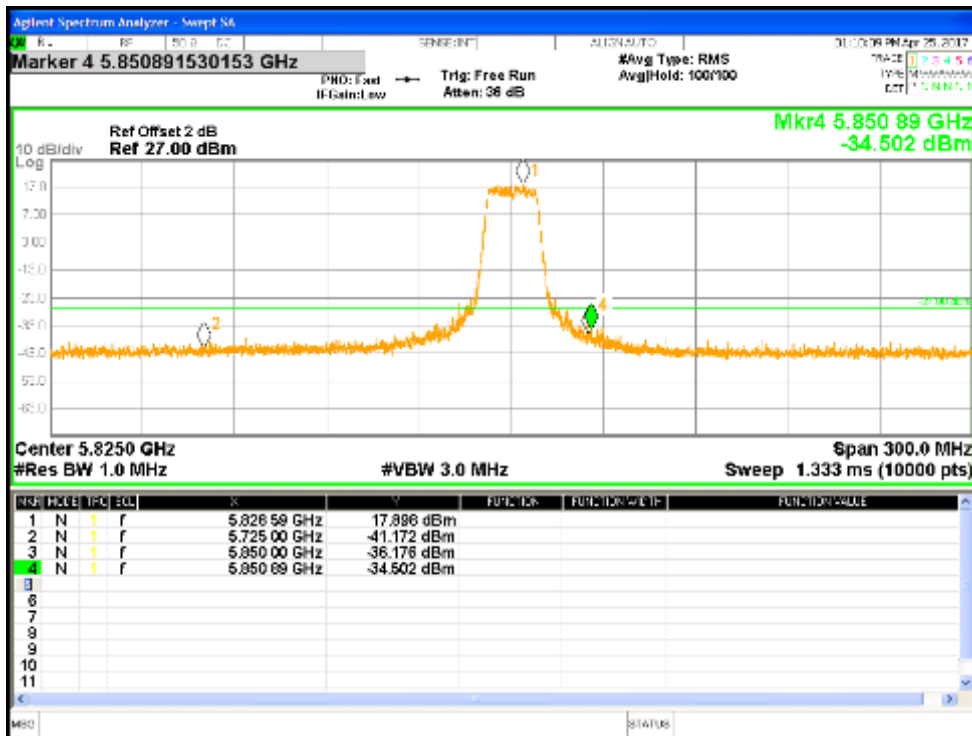

Figure 38: Measured Above Edge for 802.11a-6Mbps at 5825 MHz, Chain 0

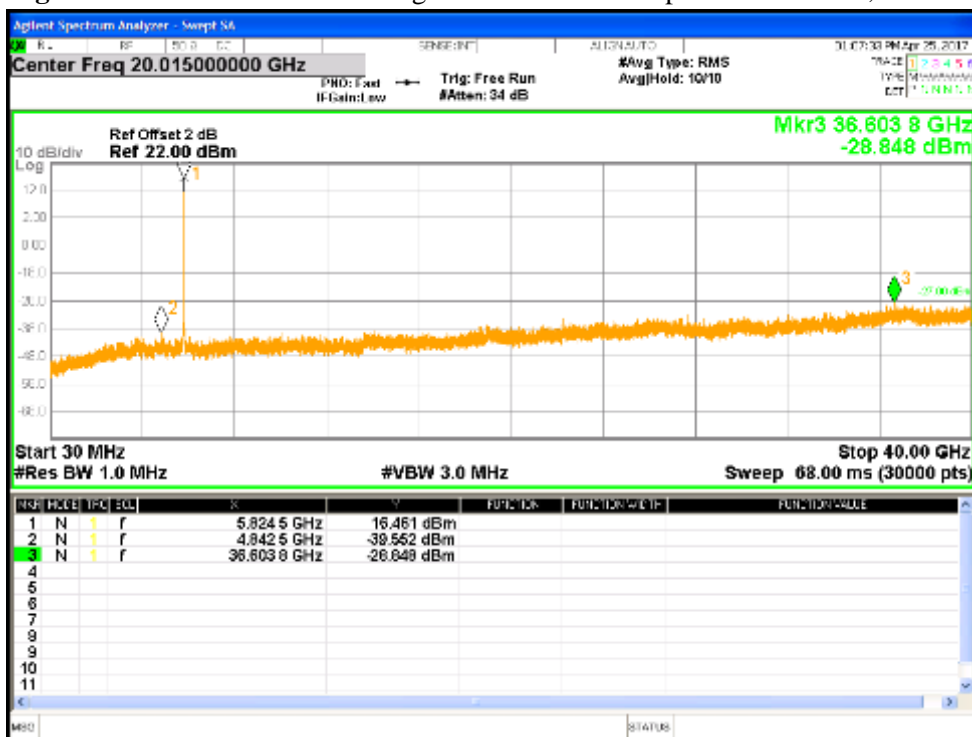

Figure 39: Undesirable Emission for 802.11a-6Mbps at 5825 MHz, Chain 0

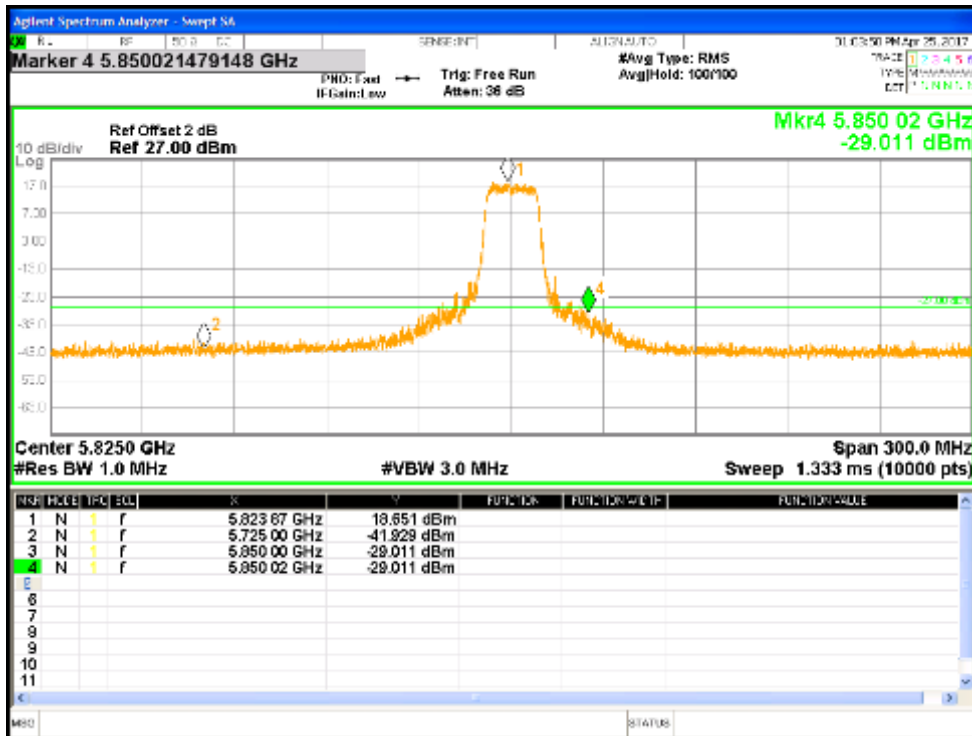

Figure 40: Measured Above Edge for 802.11a-6Mbps at 5825 MHz, Chain 1

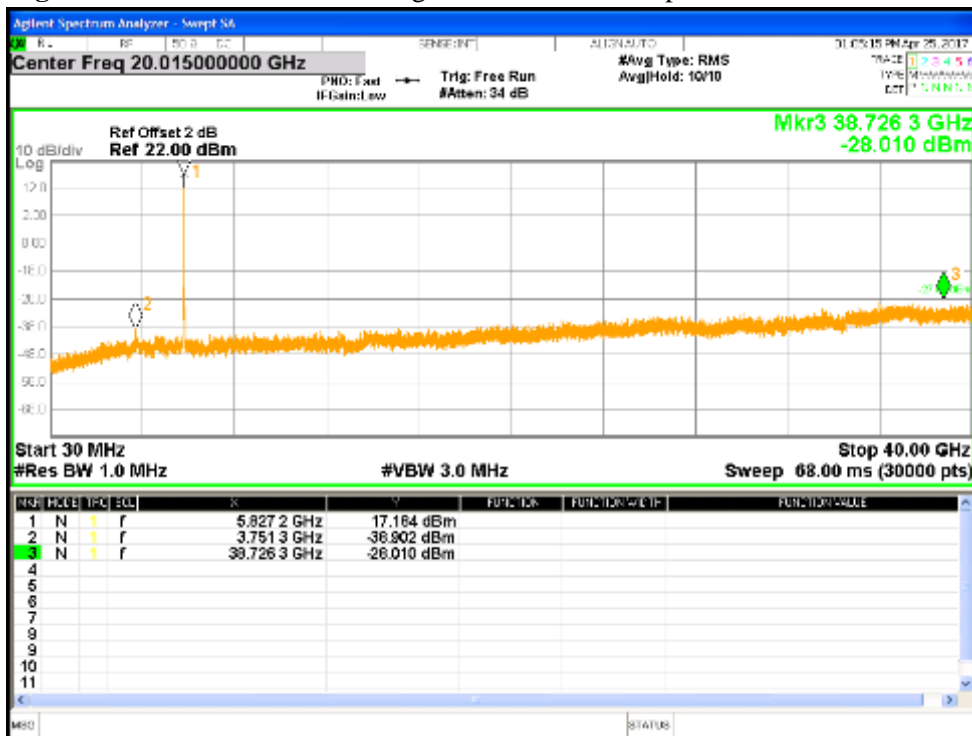

Figure 41: Undesirable Emission for 802.11a-6Mbps at 5825 MHz, Chain 1

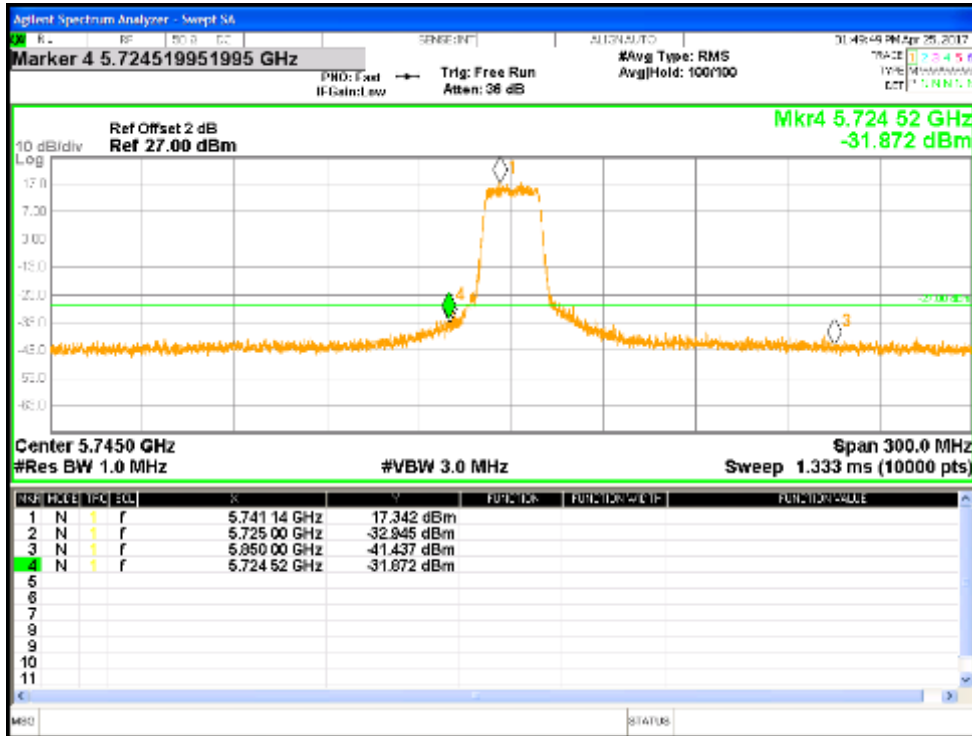

Figure 42: Measured Below Edge for HT20-MCS0 at 5745 MHz, Chain 0

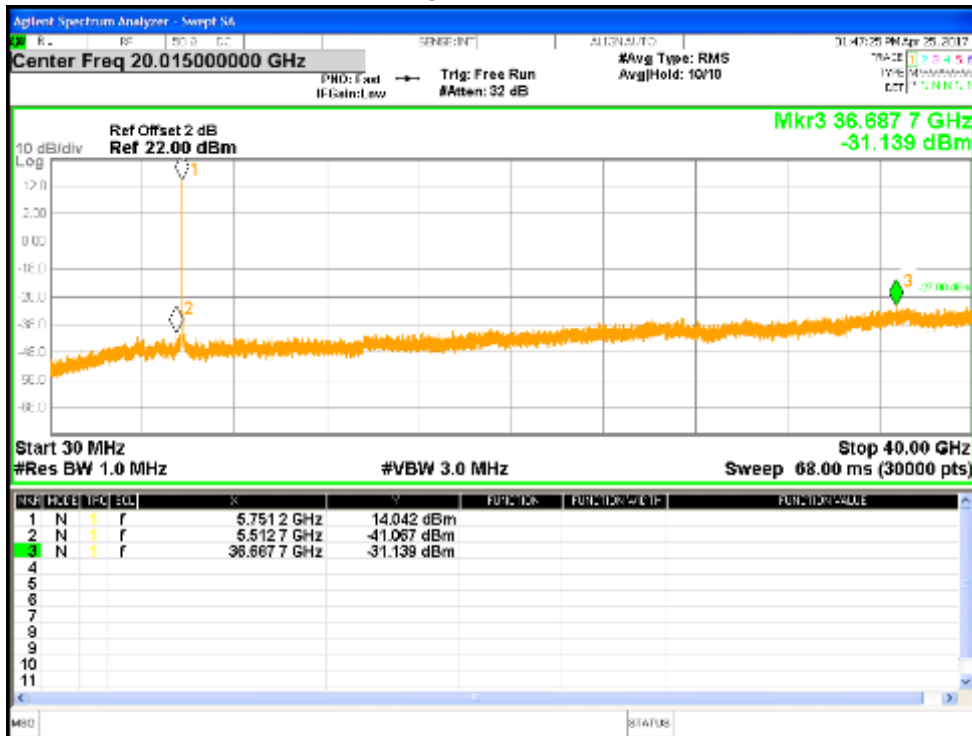

Figure 43: Undesirable Emission for HT20-MCS0 at 5745 MHz, Chain 0

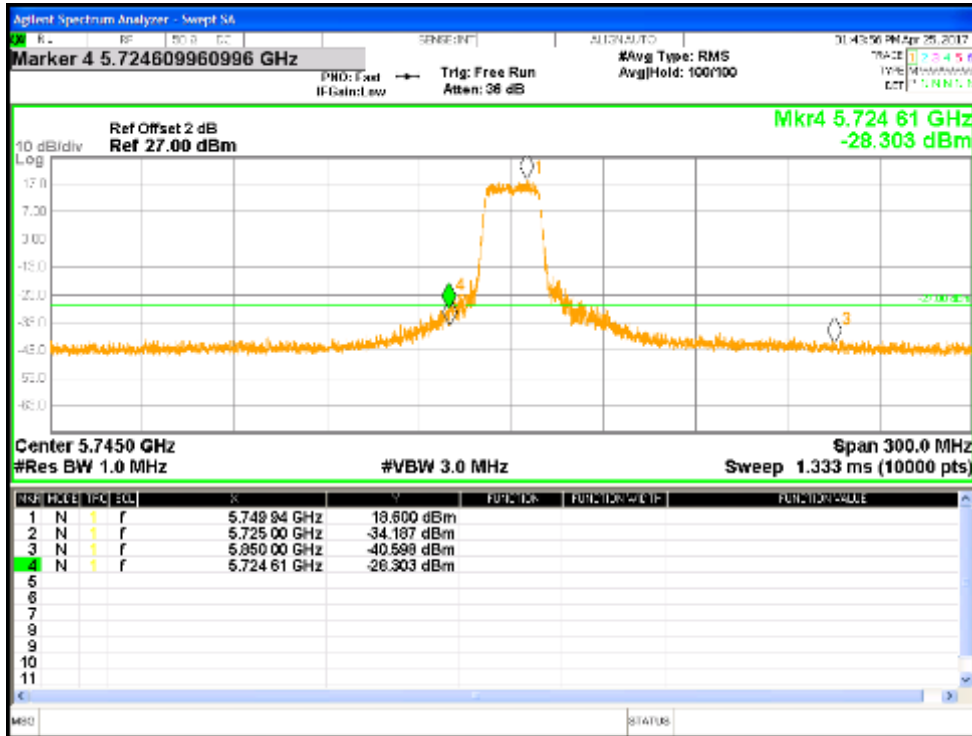

Figure 44: Measured Below Edge for HT20-MCS0 at 5745 MHz, Chain 1

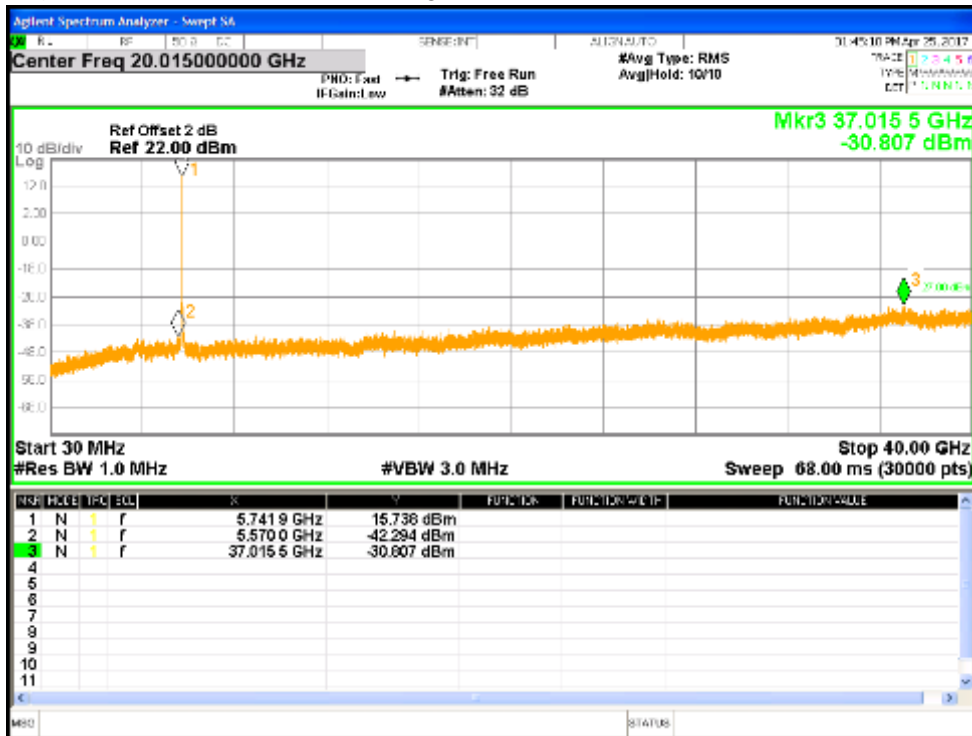

Figure 45: Undesirable Emission for HT20-MCS0 at 5745 MHz, Chain 1

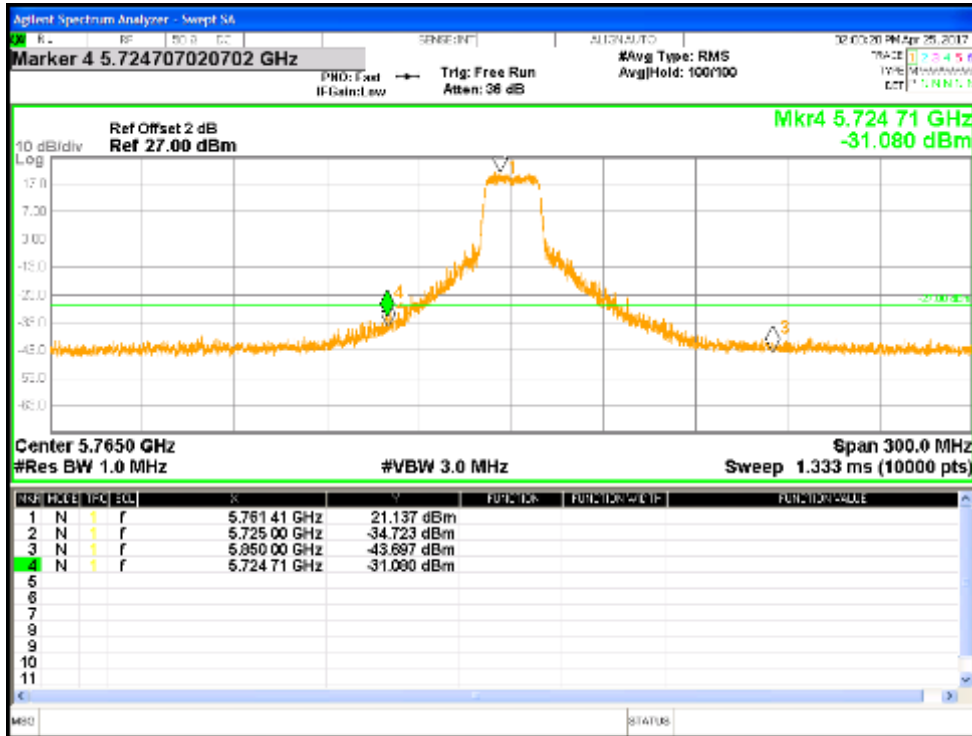

Figure 46: Measured Below Edge for HT20-MCS0 at 5765 MHz, Chain 0

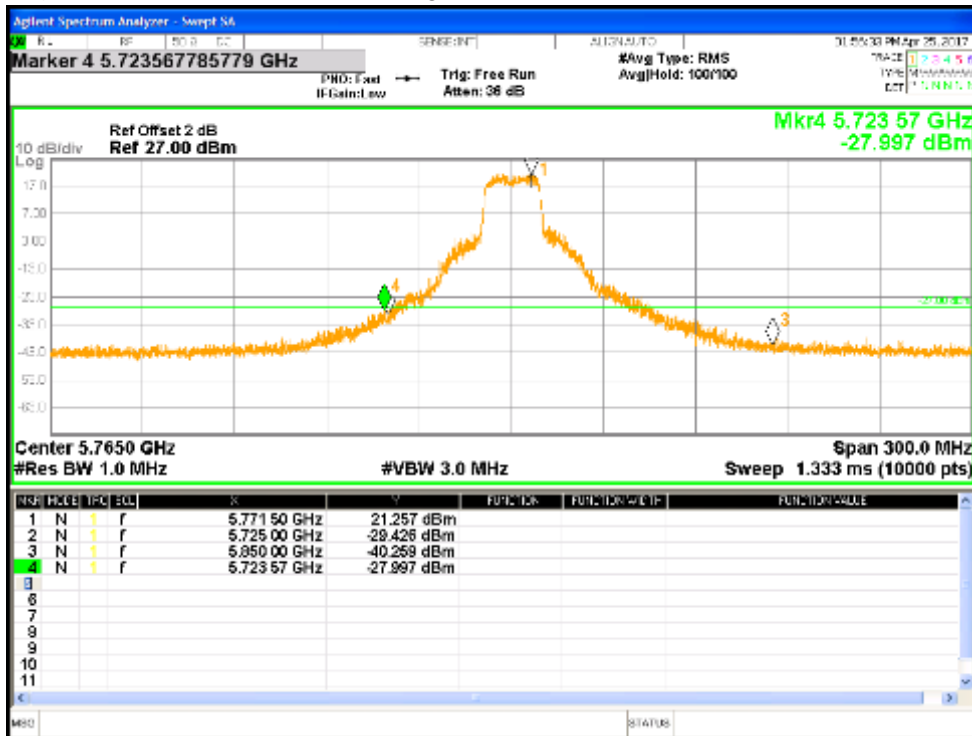

Figure 47: Measured Below Edge for HT20-MCS0 at 5765 MHz, Chain 1

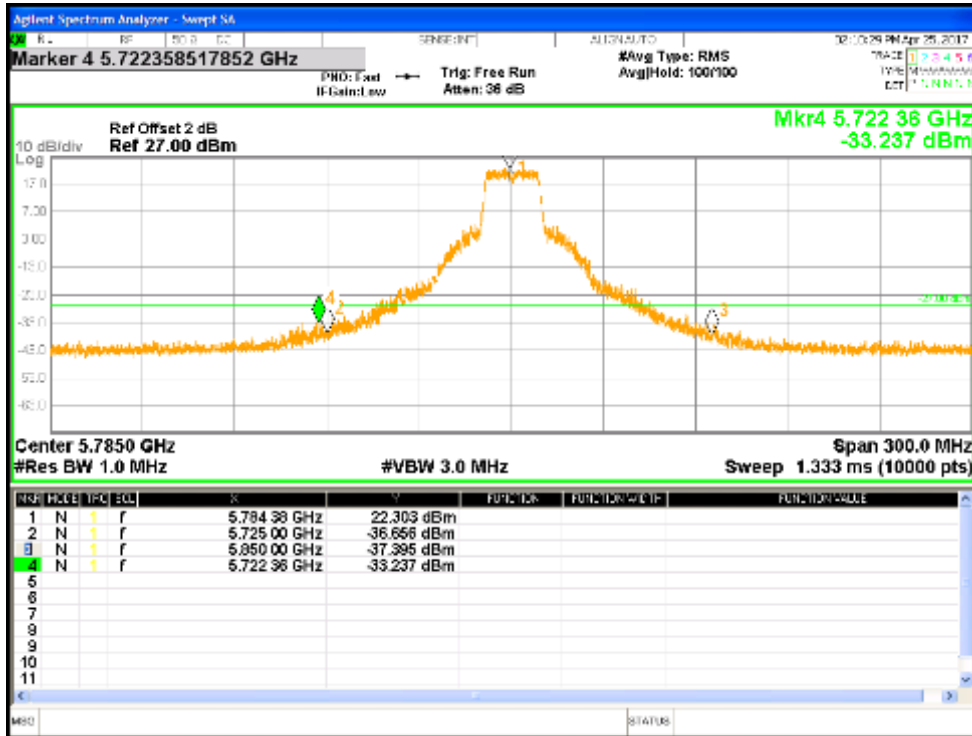

Figure 48: Measured Above Edge for HT20-MCS0 at 5785 MHz, Chain 0

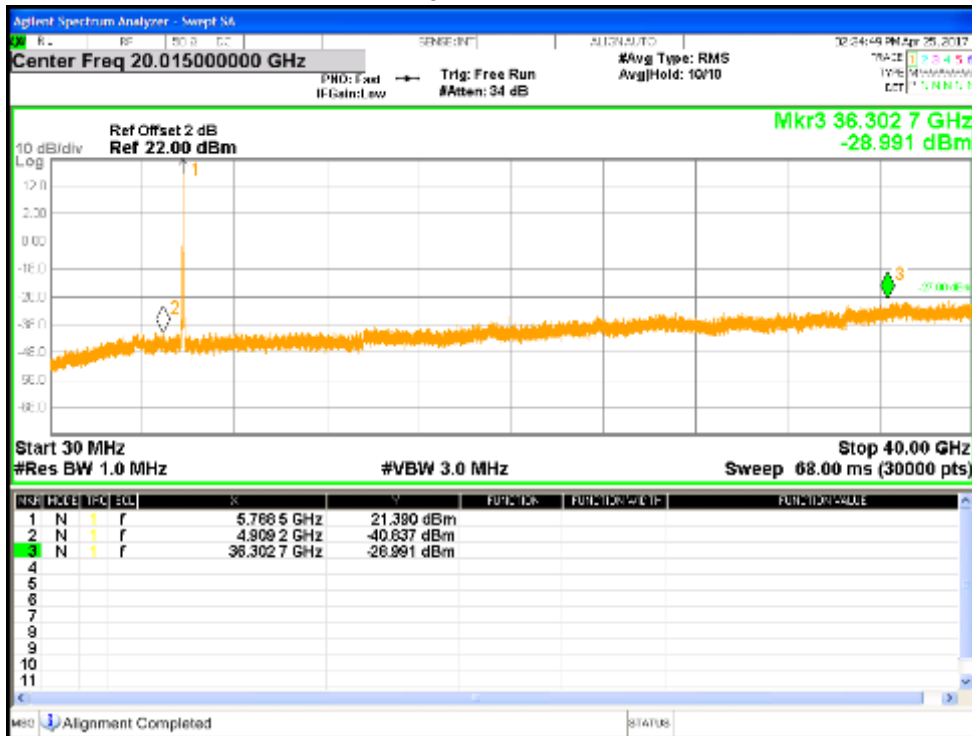

Figure 49: Undesirable Emission for HT20-MCS0 at 5785 MHz, Chain 0



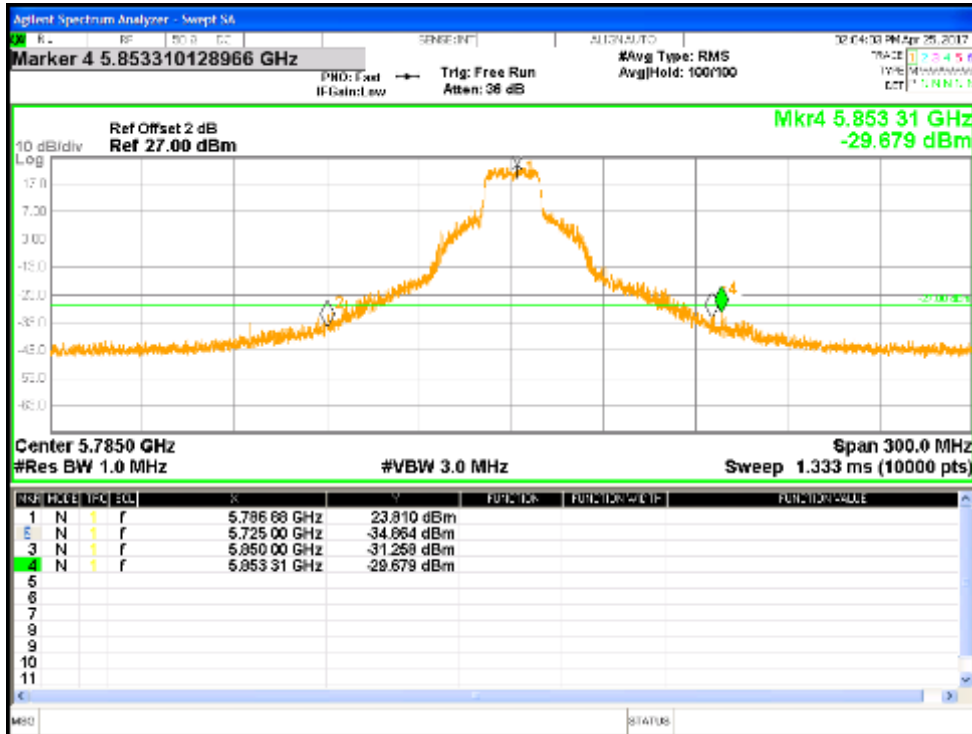

Figure 50: Measured Above Edge for HT20-MCS0 at 5785 MHz, Chain 1

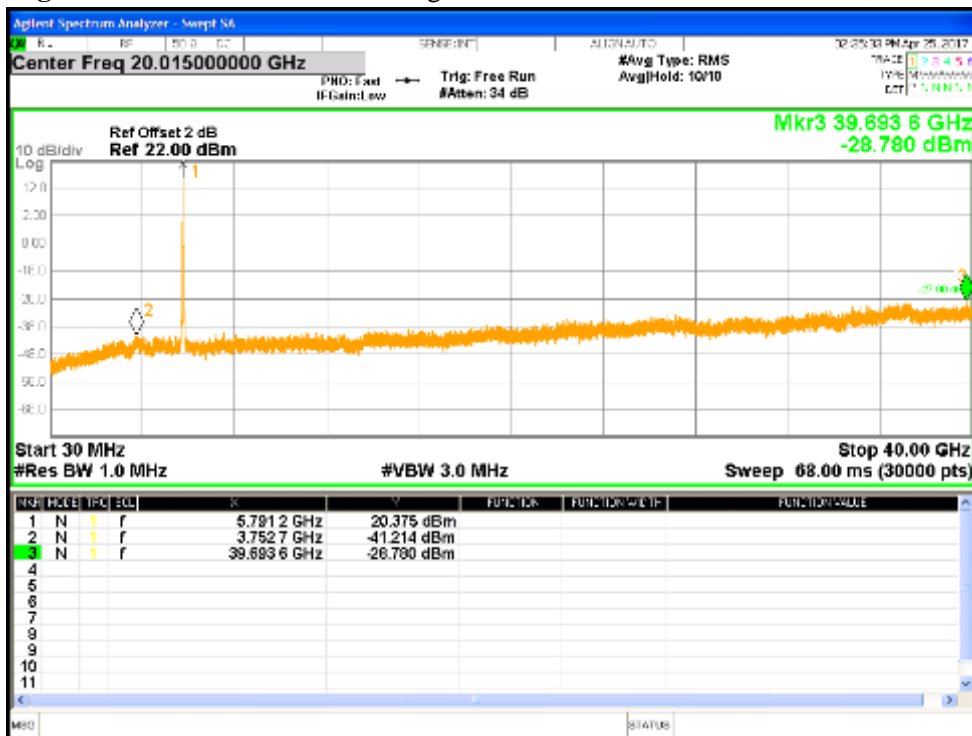

Figure 51: Undesirable Emission for HT20-MCS0 at 5785 MHz, Chain 1

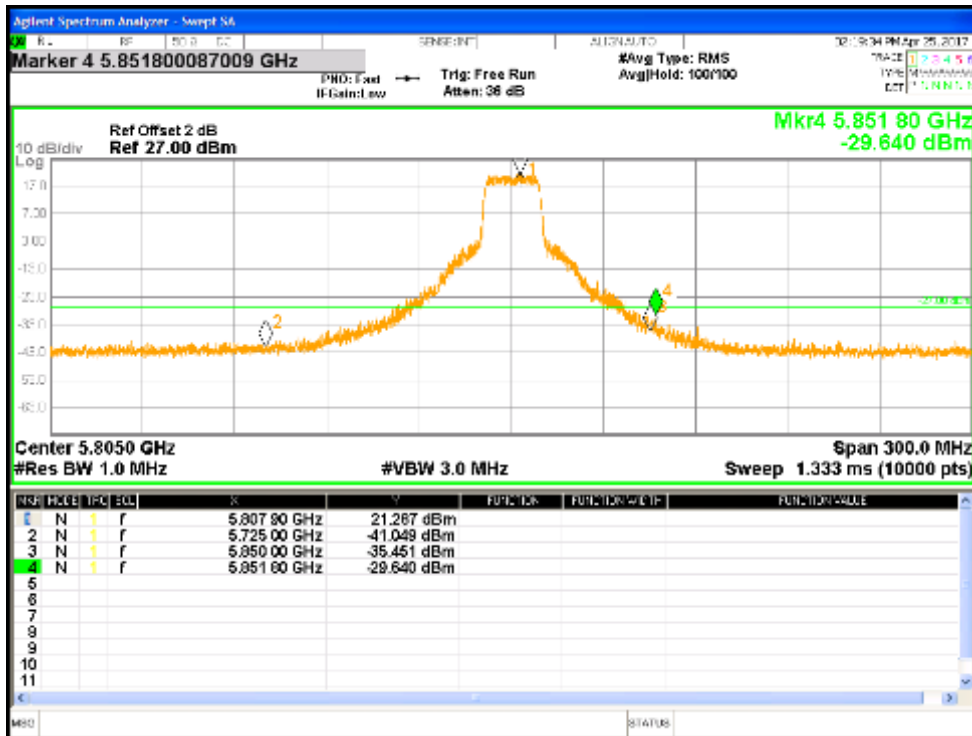

Figure 52: Measured Above Edge for HT20-MCS0 at 5805 MHz, Chain 0

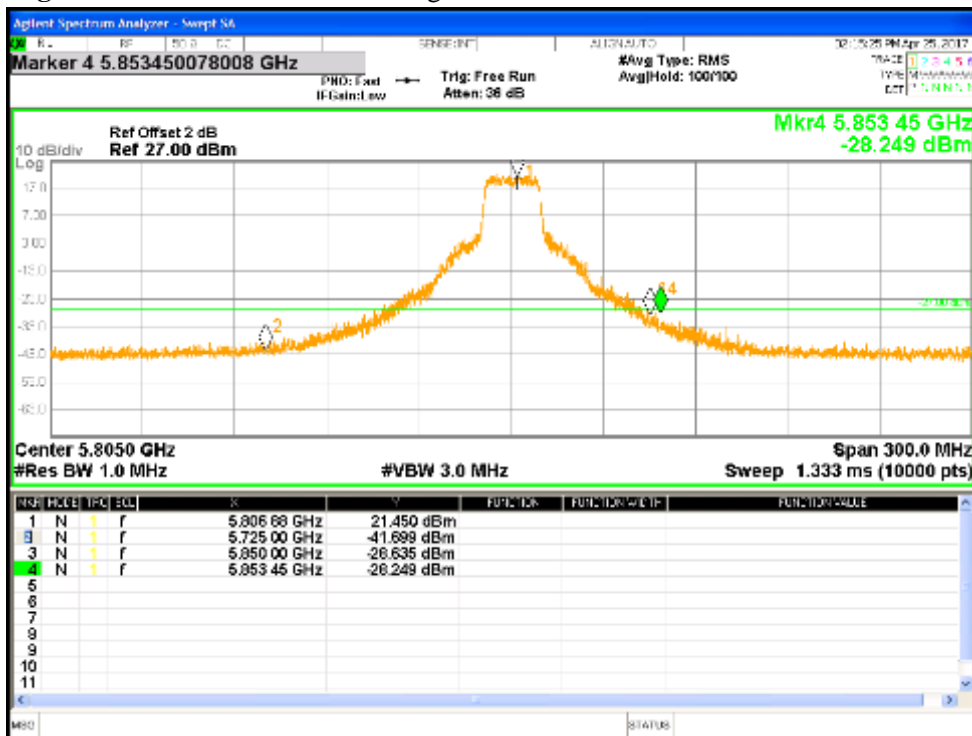

Figure 53: Measured Above Edge for HT20-MCS0 at 5805 MHz, Chain 1

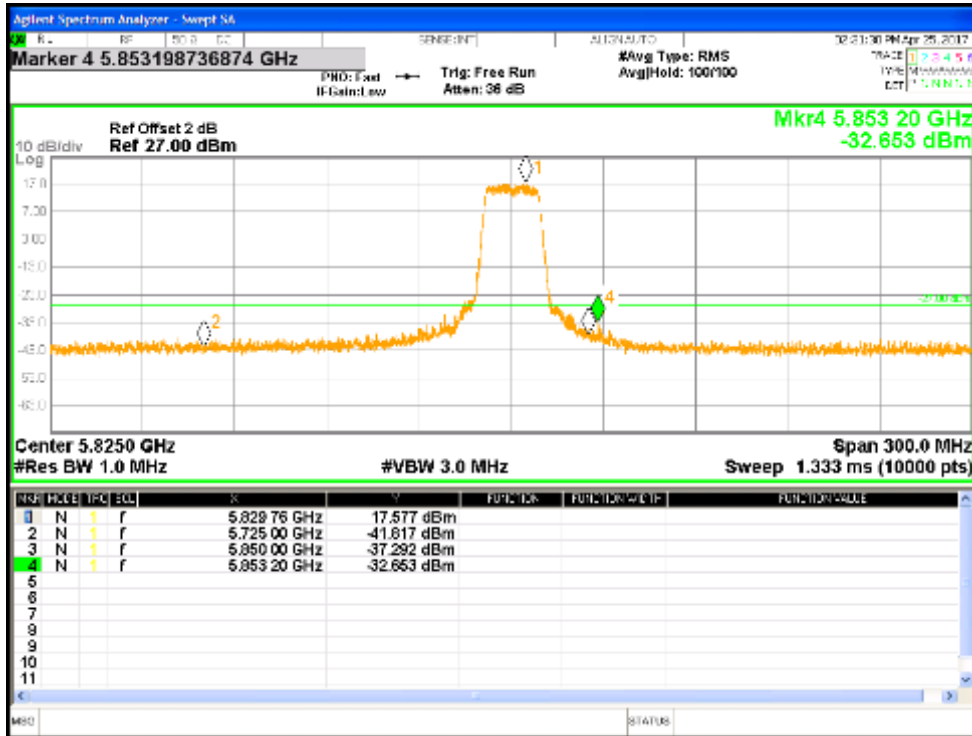

Figure 54: Measured Above Edge for HT20-MCS0 at 5825 MHz, Chain 0

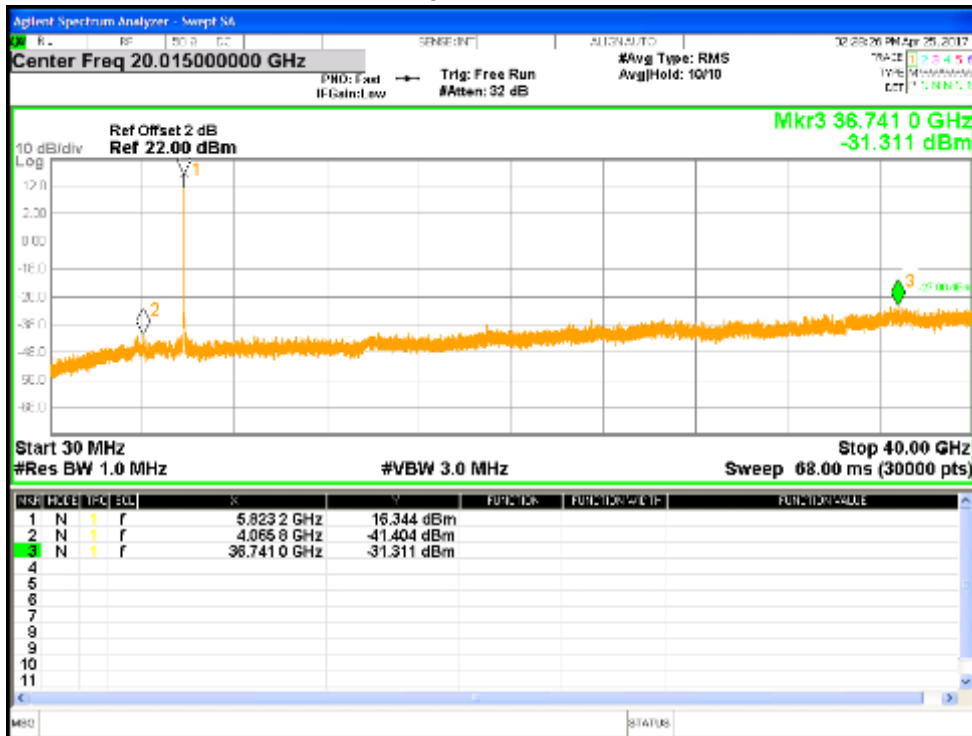

Figure 55: Undesirable Emission for HT20-MCS0 at 5825 MHz, Chain 0

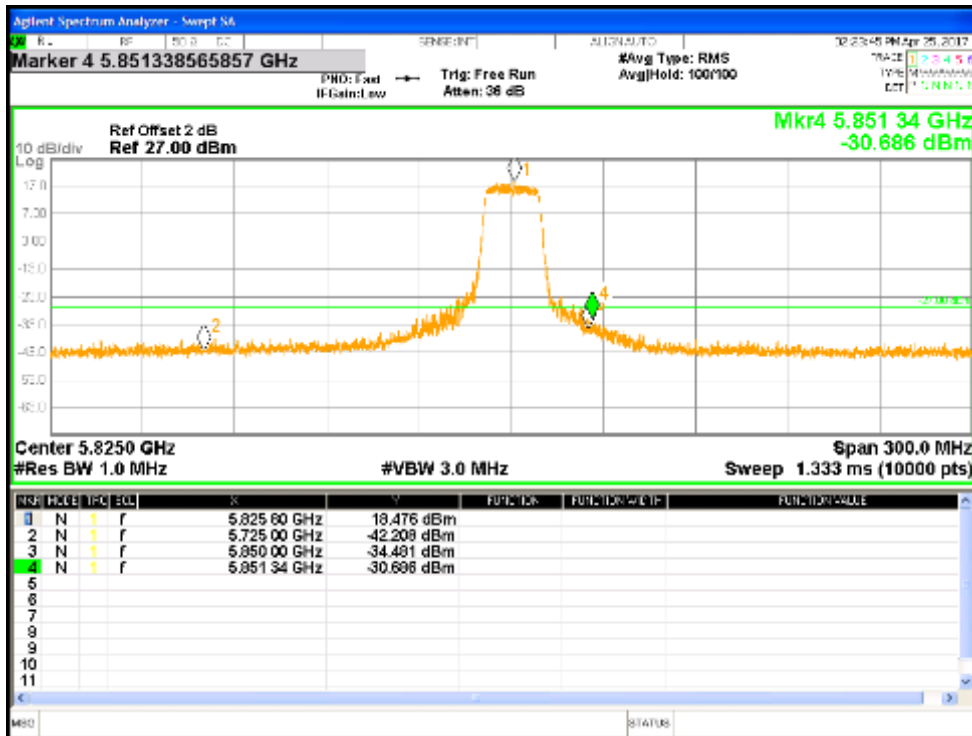

Figure 56: Measured Above Edge for HT20-MCS0 at 5825 MHz, Chain 1

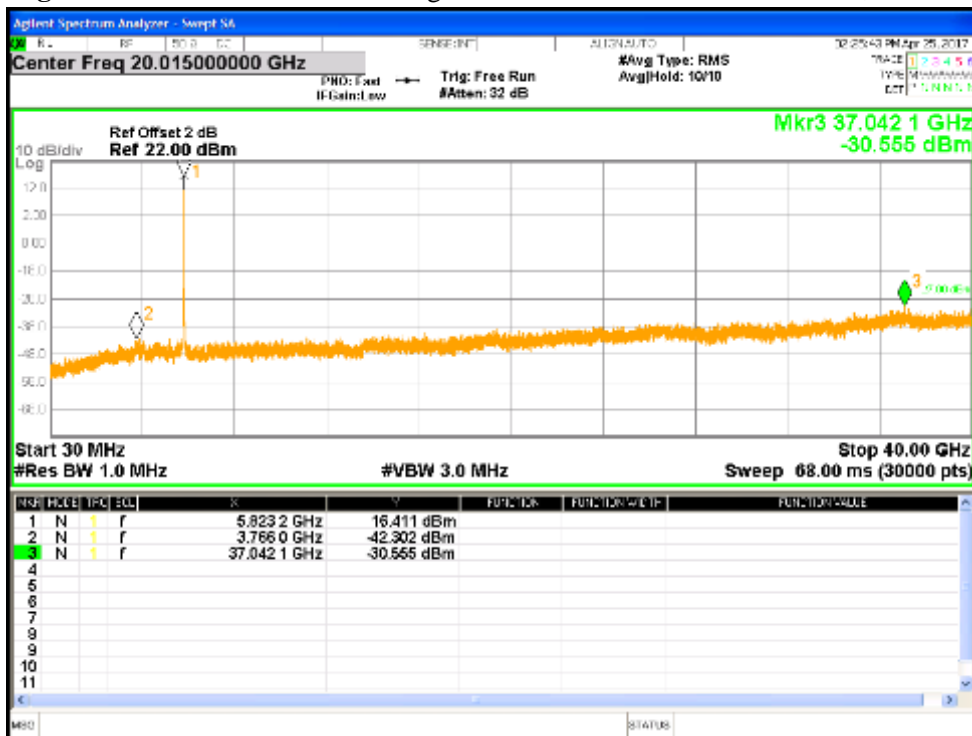

Figure 57: Undesirable Emission for HT20-MCS0 at 5825 MHz, Chain 1

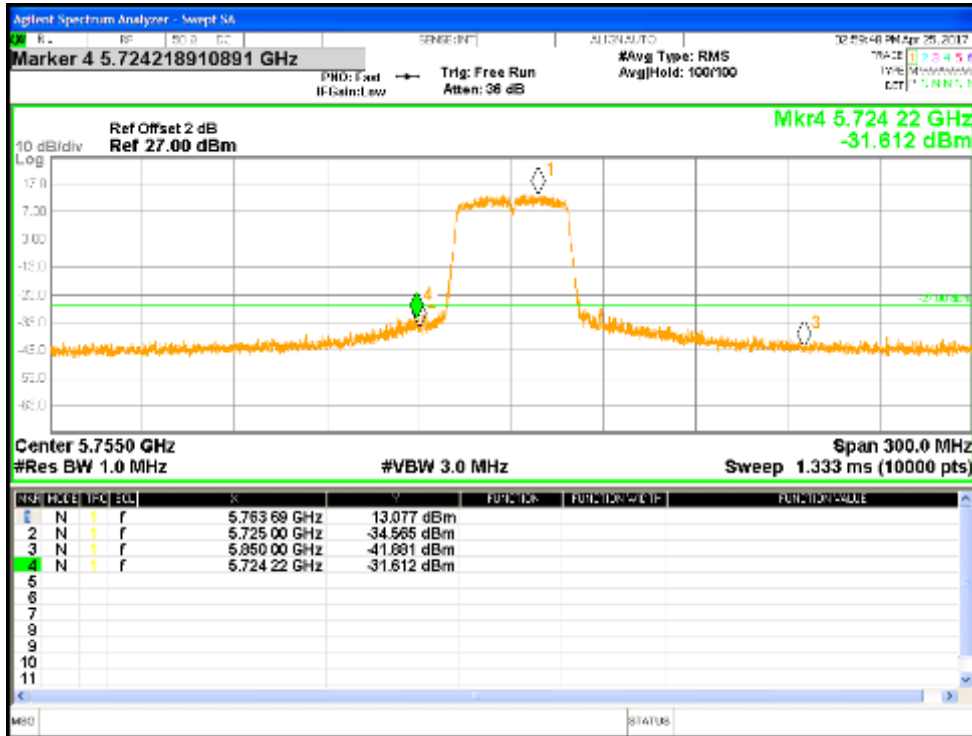

Figure 58: Measured Below Edge for HT40-MCS0 at 5755 MHz, Chain 0

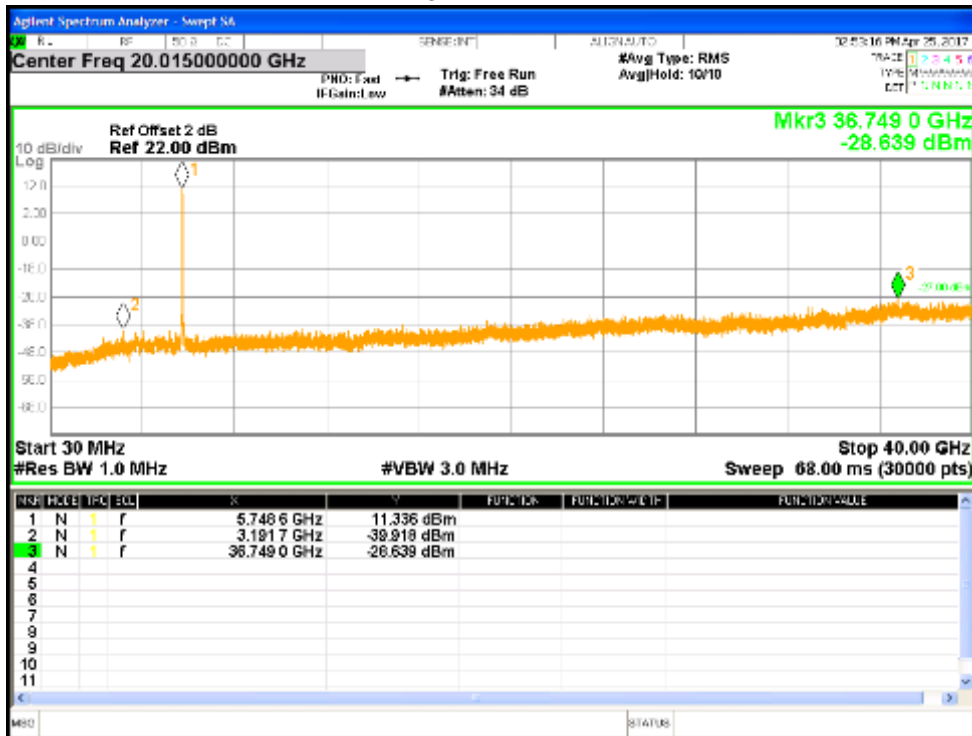

Figure 59: Undesirable Emission for HT40-MCS0 at 5755 MHz, Chain 0

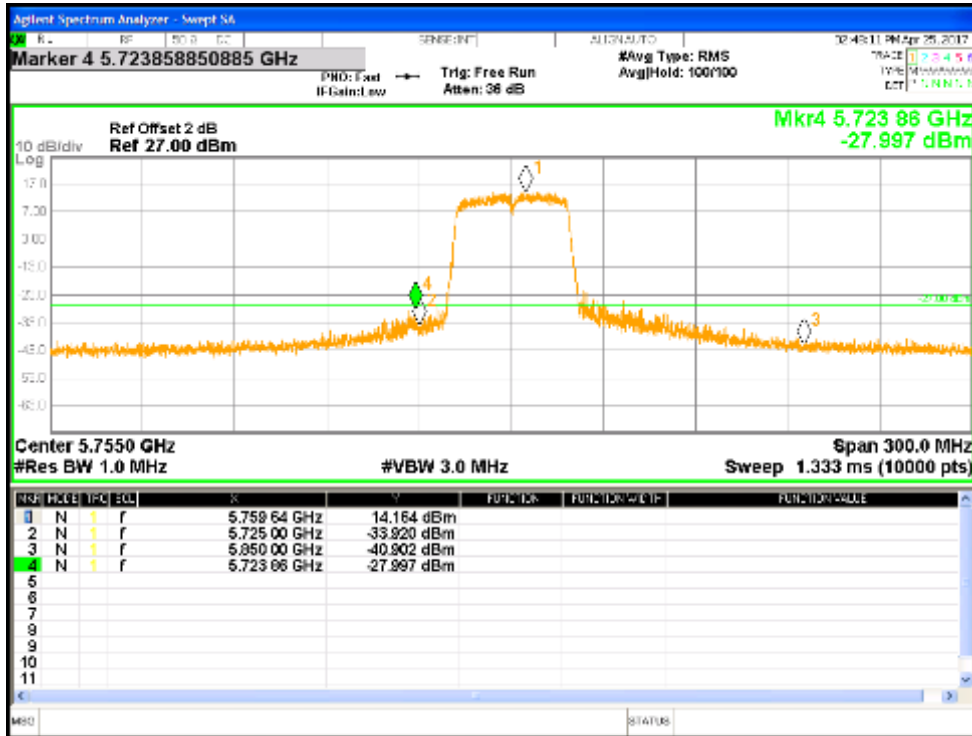

Figure 60: Measured Below Edge for HT40-MCS0 at 5755 MHz, Chain 1

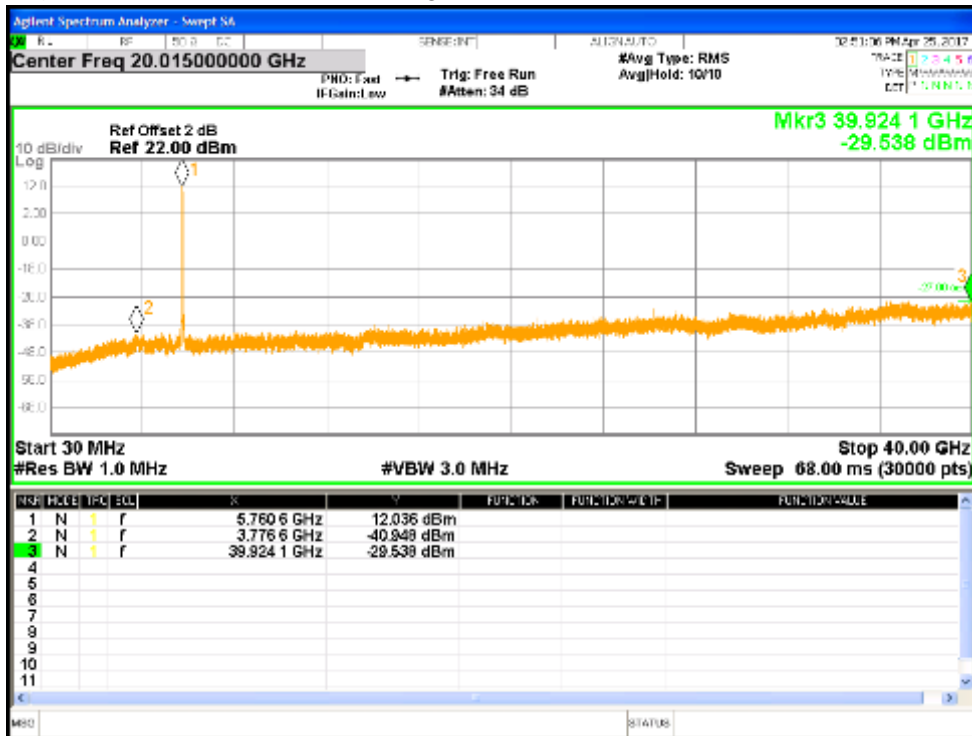

Figure 61: Undesirable Emission for HT40-MCS0 at 5755 MHz, Chain 1

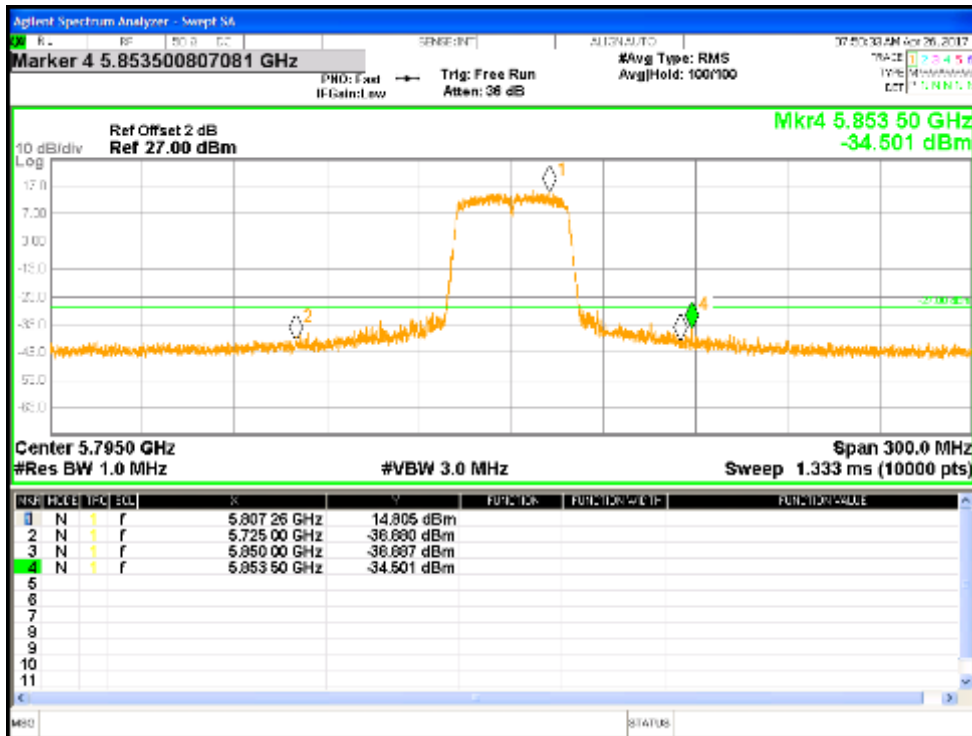

Figure 62: Measured Above Edge for HT40-MCS0 at 5795 MHz, Chain 0

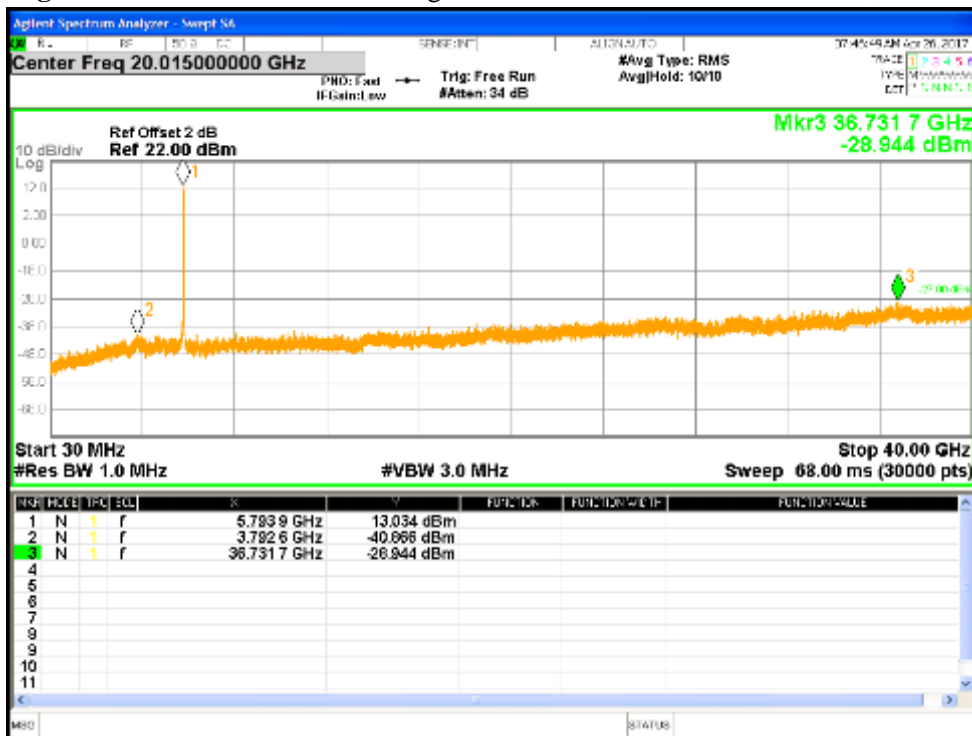

Figure 63: Undesirable Emission for HT40-MCS0 at 5795 MHz, Chain 0

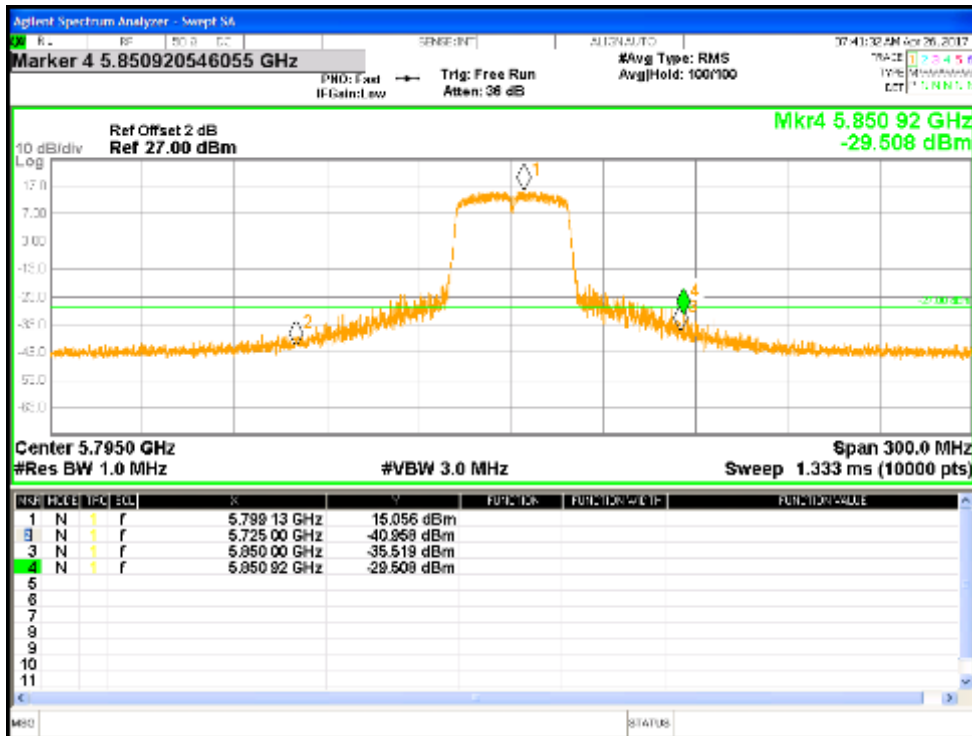

Figure 64: Measured Above Edge for HT40-MCS0 at 5795 MHz, Chain 1

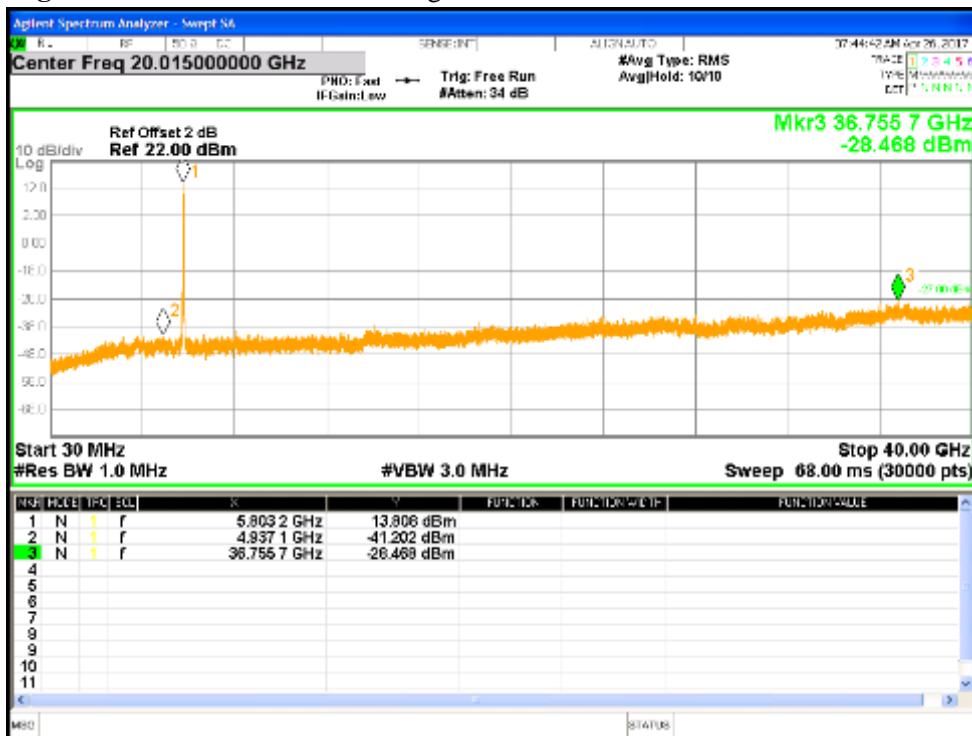

Figure 65: Undesirable Emission for HT40-MCS0 at 5795 MHz, Chain 1



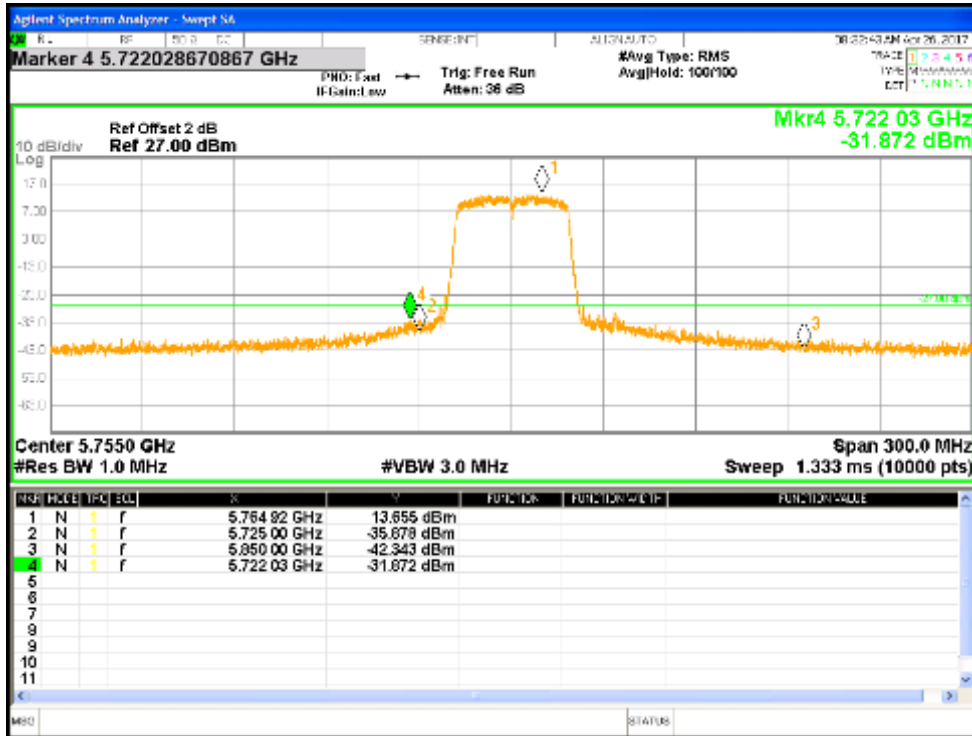

Figure 66: Measured Below Edge for VHT40-MCS0 at 5755 MHz, Chain 0

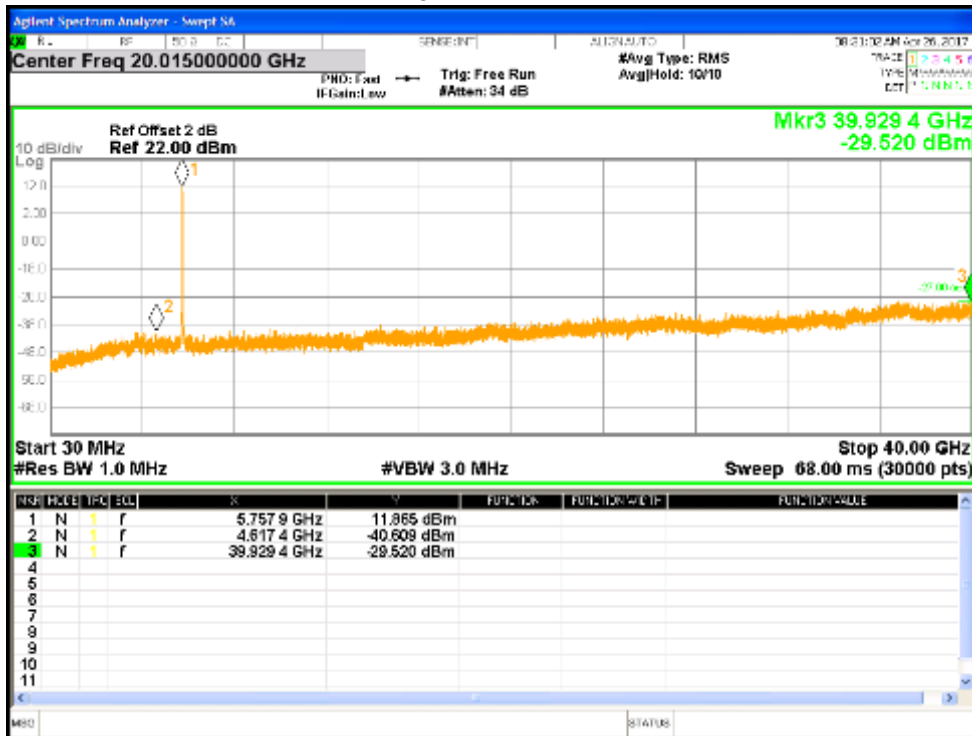

Figure 67: Undesirable Emission for VHT40-MCS0 at 5755 MHz, Chain 0

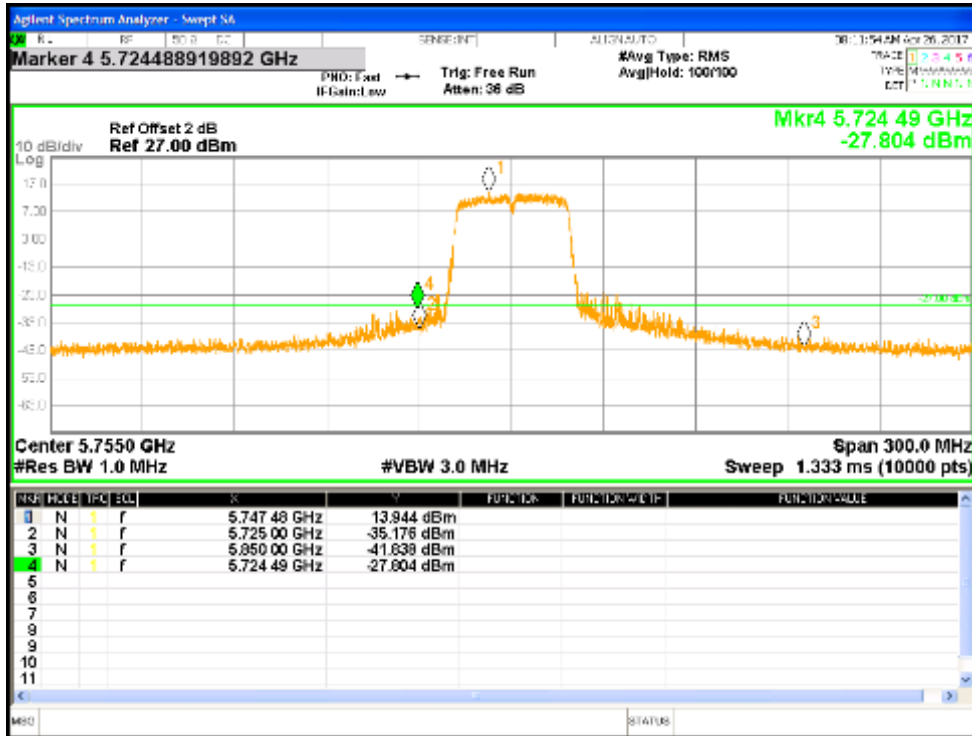

Figure 68: Measured Below Edge for VHT40-MCS0 at 5755 MHz, Chain 1

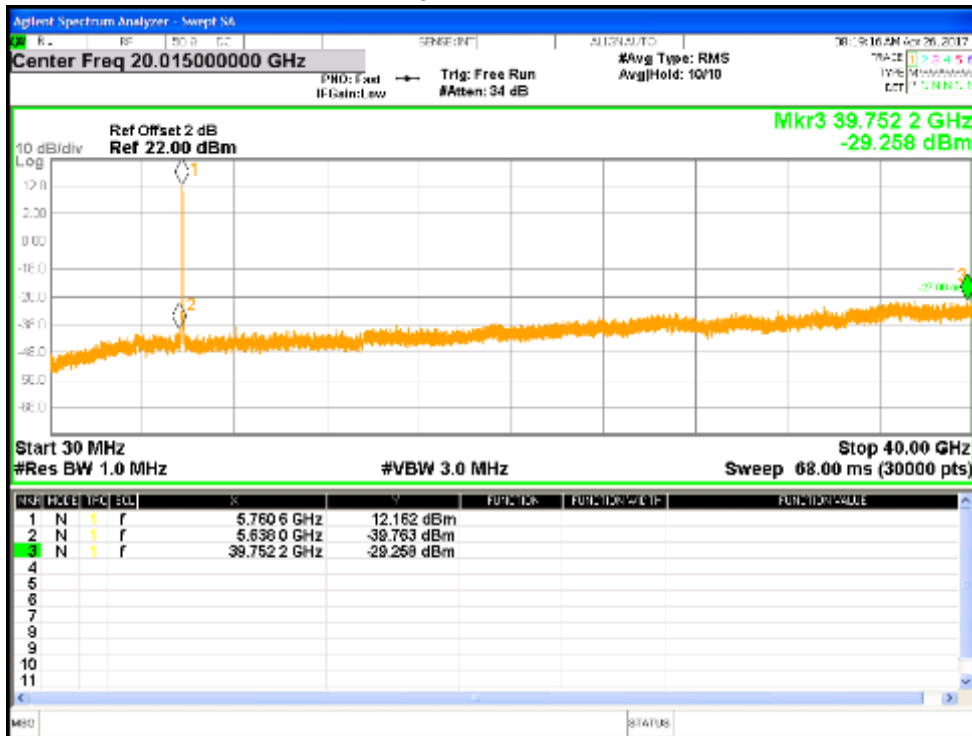

Figure 69: Undesirable Emission for VHT40-MCS0 at 5755 MHz, Chain 1

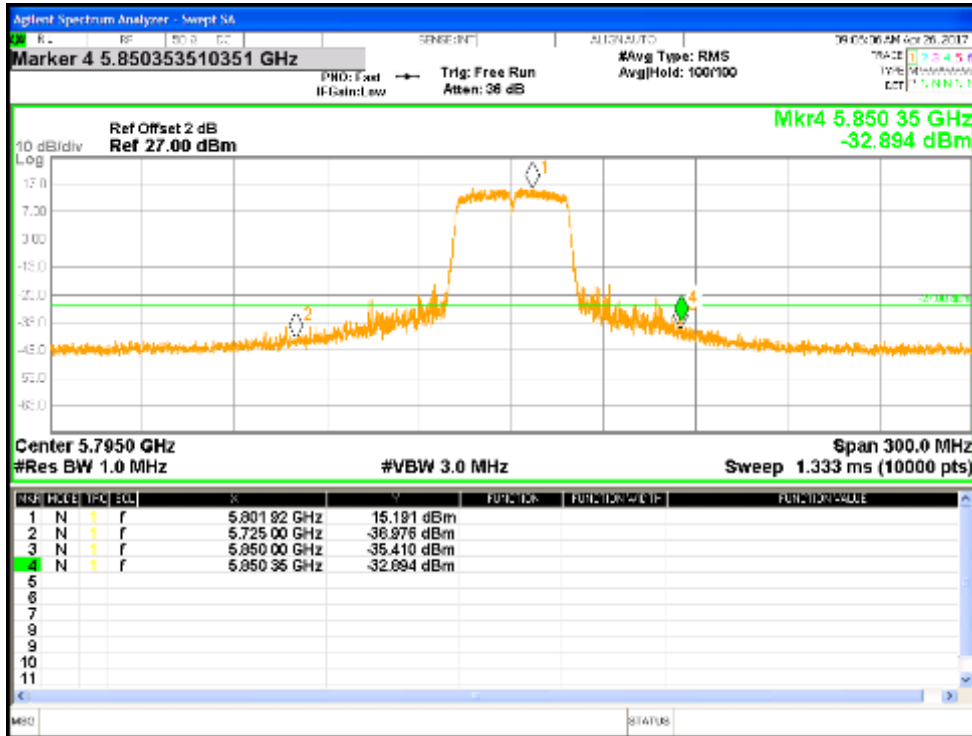

Figure 70: Measured Above Edge for VHT40-MCS0 at 5795 MHz, Chain 0

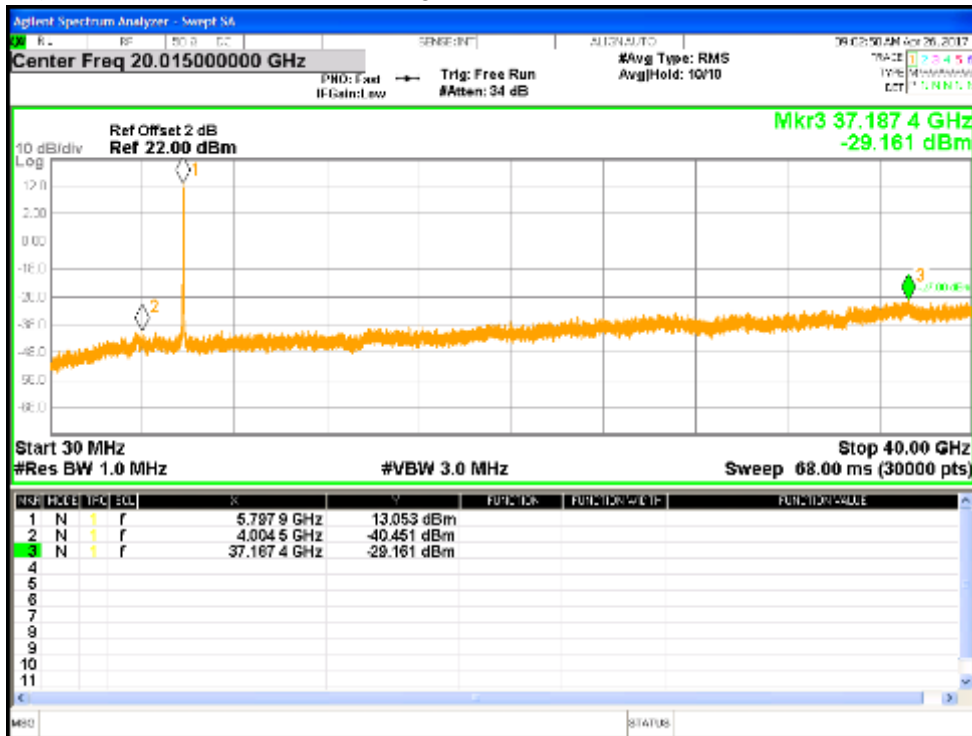

Figure 71: Undesirable Emission for VHT40-MCS0 at 5795 MHz, Chain 0

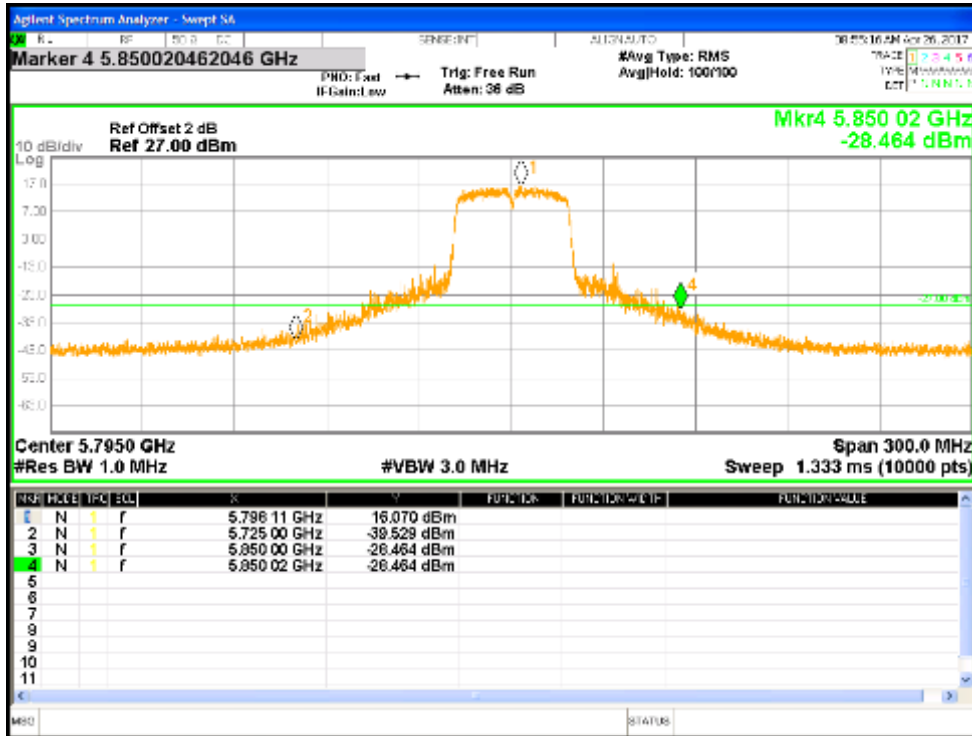

Figure 72: Measured Above Edge for VHT40-MCS0 at 5795 MHz, Chain 1

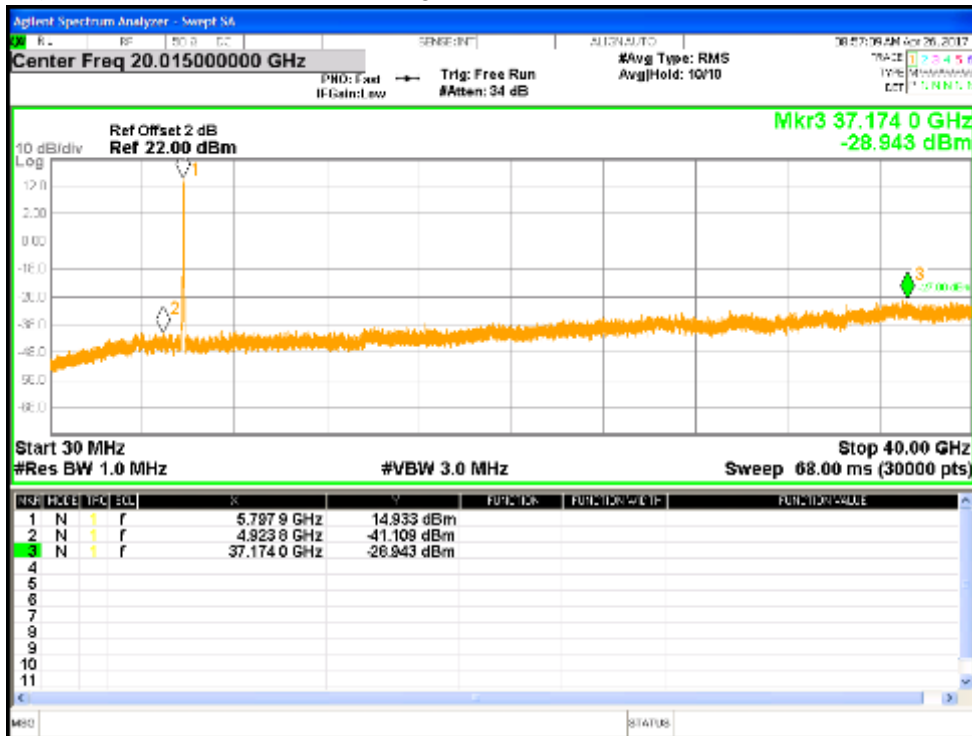

Figure 73: Undesirable Emission for VHT40-MCS0 at 5795 MHz, Chain 1

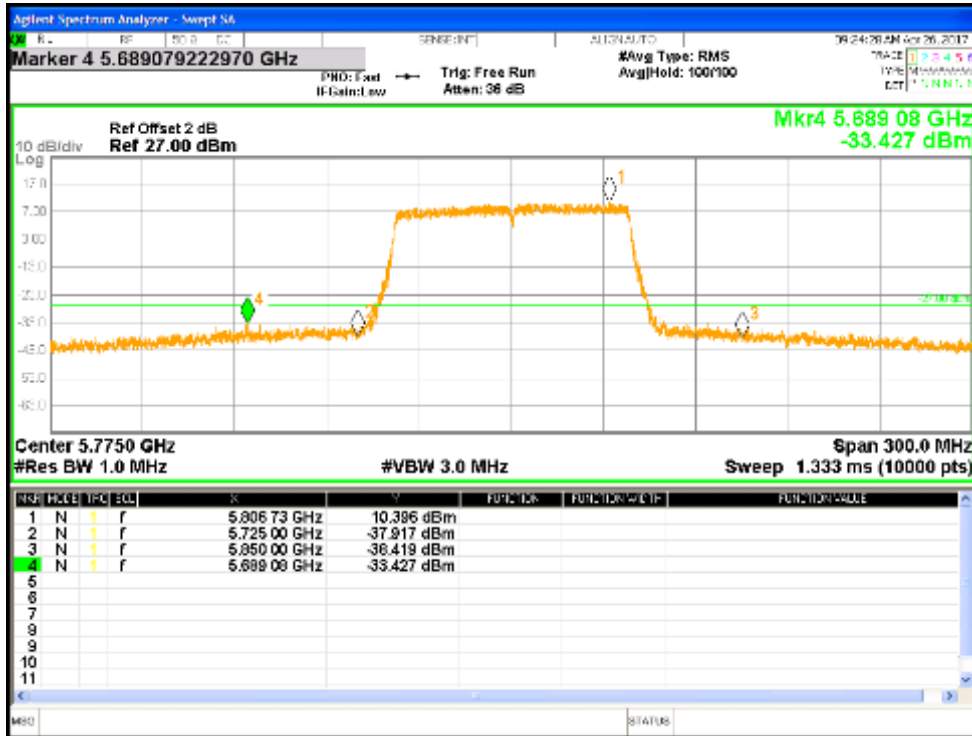

Figure 74: Measured Below Edge for VHT80-MCS0 at 5775 MHz, Chain 0

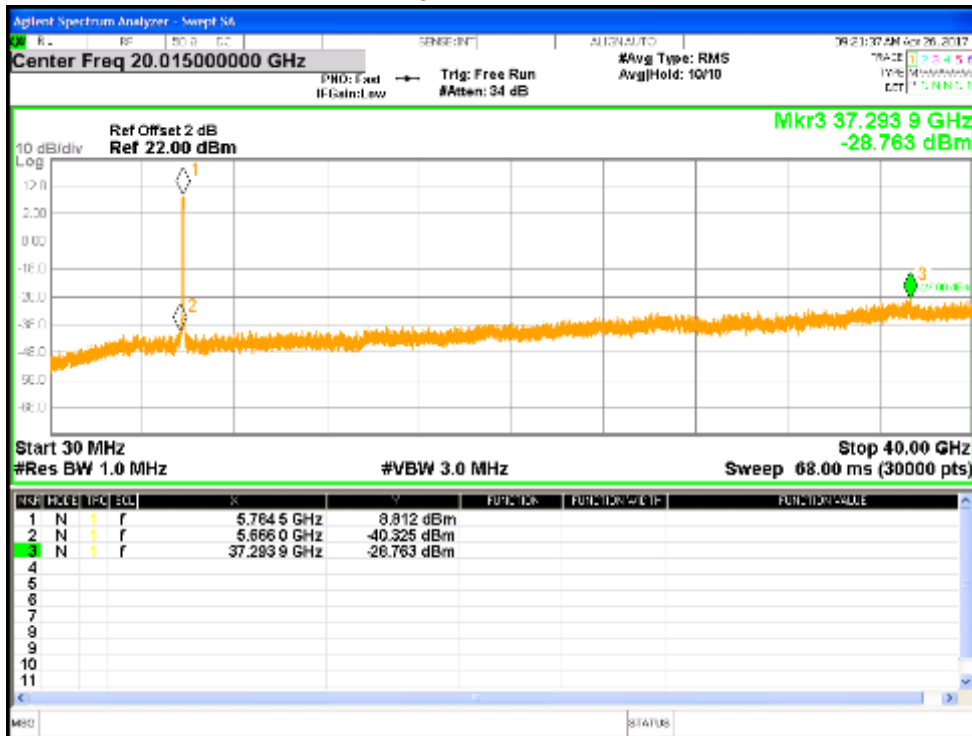

Figure 75: Undesirable Emission for VHT80-MCS0 at 5775 MHz, Chain 0

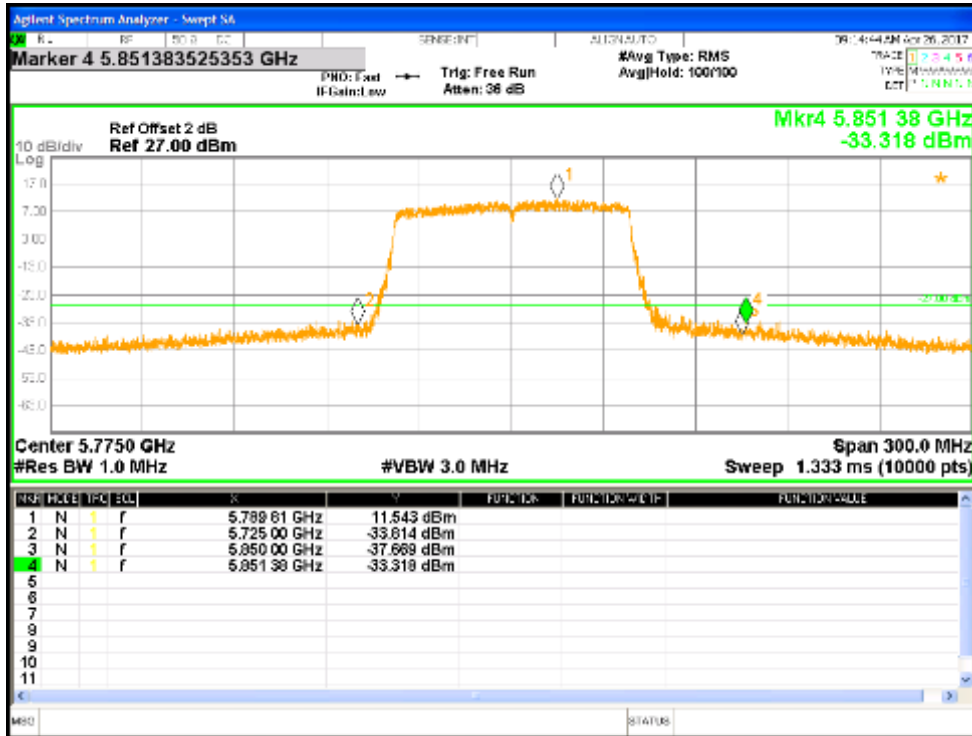

Figure 76: Measured Above Edge for VHT80-MCS0 at 5775 MHz, Chain 1

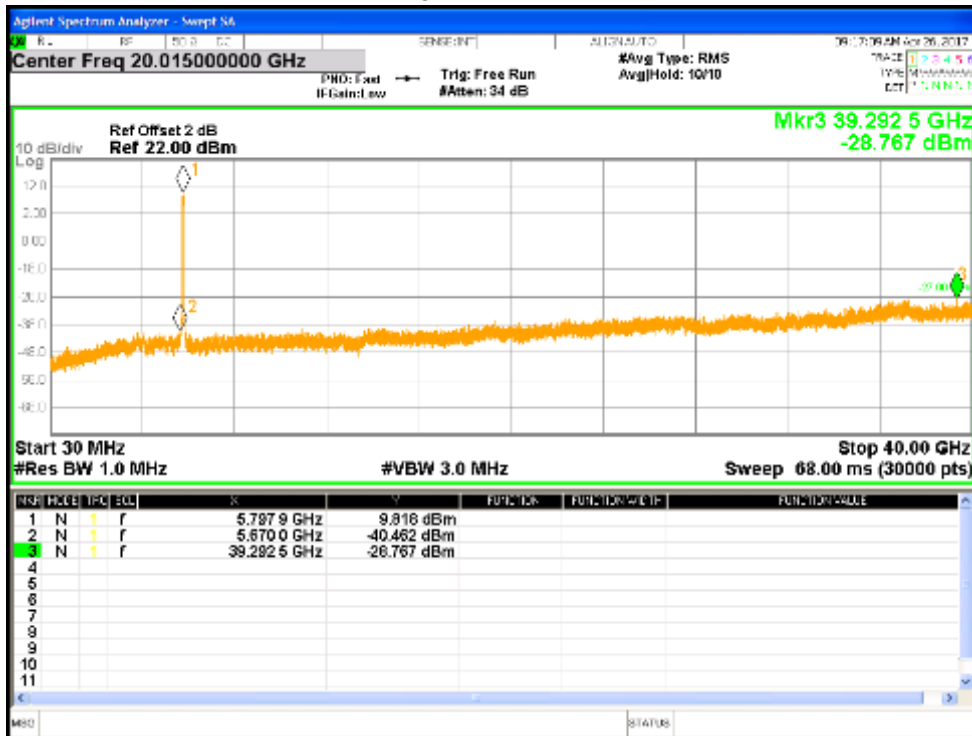

Figure 77: Undesirable Emission for VHT80-MCS0 at 5775 MHz, Chain 1

---

## 4.5 Transmitter Spurious Emissions

*Transmitter spurious emissions are emissions outside the frequency range of the equipment when the equipment is in transmit mode; per requirement of CFR47 15.205, 15.209, 15.407(b), RSS 247 Sect. 6.2.4.2*

### 4.5.1 Test Methodology

#### 4.5.1.1 Preliminary Test

A test program that controls instrumentation and data logging was used to automate the preliminary RF emission test procedure. The frequency range of interest was divided into sub-ranges to yield a frequency resolution of approximately 120 kHz and provide a reading at each frequency for no more than 12° of turntable rotation. For each frequency sub-range the turntable was rotated 360° while peak emission data was recorded and plotted over the frequency range of interest in horizontal and vertical antenna polarization's.

Preliminary emission profile testing was performed inside the anechoic chamber. The EUT was placed on a 1.0m x 1.5m non-conductive table 80cm (<1 GHz) and 150cm (>1 GHz) above the floor. The EUT was positioned as shown in the setup photographs. The receiving antenna was placed at a distance of 3m at a fixed height of 1m. Measurement equipment was located outside of the chamber. A video camera was placed inside the chamber to view the EUT.

Pres-scans were performed to determine the worst data rate / chains for 802.11a, 802.11n (HT20 and HT40), 802.11ac (VHT20, VHT40 and VHT80).

#### 4.5.1.2 Final Test

For each frequency measured, the peak emission was maximized by manipulating the receiving antenna from 1 to 4 meters above the ground plane and placing it at the position that produced the maximum signal strength reading. The turntable was then rotated through 360° while observing the peak signal and placing the EUT at the position that produced maximum radiation. The six highest emissions relative to the limit were measured unless such emissions were more than 20 dB below the limit. If less than six emissions are within 20 dB of the limit, than the noise level of the receiver is measured at frequencies where emissions are expected. Multiples of all oscillator and microprocessor frequencies were also checked.

Final testing was performed on an NSA compliant test site. The EUT was placed on a 1.0m x 1.5m non-conductive table 80cm (<1 GHz) and 150cm (>1 GHz) above the ground plane. The placement of EUT and cables were the same as for preliminary testing and is shown in the setup photographs.

Final results are:

1. 802.11a at 6Mbps with 2 Chains (covering HT20 & VHT20)
2. HT40 at MCS0 with 2 Chains (covering VHT40)
3. VHT80 at MCS0 with 2 Chains

#### 4.5.1.3 Deviations

None.

**Test Setup:**

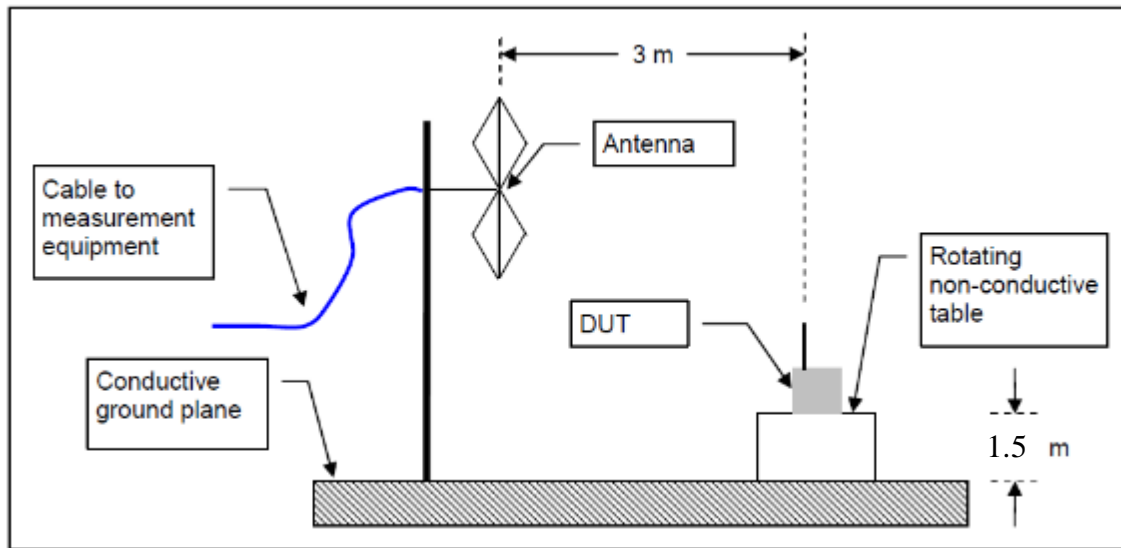

**4.5.2 Transmitter Spurious Emission Limit**

The spurious emissions of the transmitter shall not exceed the values in CFR47 Part 15.205, 15.209: 2016 and RSS 247 Sect. 6.2.4.2 2017.

Frequency (MHz)	Field strength (microvolts/meter)	Measurement distance (meters)
0.009-0.490	2400/F (kHz)	300
0.490-1.705	24000/F (kHz)	30
1.705-30.0	30	30
30-88	100 **	3
88-216	150 **	3
216-960	200 **	3
Above 960	500	3

In the 5725 MHz – 5850 MHz band, all emissions shall be limited to a level of:

- a) 27 dBm/MHz at frequencies from the band edges decreasing linearly to 15.6 dBm/MHz at 5 MHz above or below the band edges;
- b) 15.6 dBm/MHz at 5 MHz above or below the band edges decreasing linearly to 10 dBm/MHz at 25 MHz above or below the band edges;
- c) 10 dBm/MHz at 25 MHz above or below the band edges decreasing linearly to -27 dBm/MHz at 75 MHz above or below the band edges; and
- d) -27 dBm/MHz at frequencies more than 75 MHz above or below the band edges.



---

### 4.5.3 Test Results

The final measurement data was taken under the worst case operating modes, configurations, and/or cable positions. It also reflects the results including any modifications and/or special accessories listed in Sections 1.4 and test plan.

As originally tested, the EUT was found to be compliant to the requirements of the test standard(s).

**Table 15: Transmit Spurious Emission at Band-Edge Requirements**

<b>Test Conditions:</b> Radiated Measurement, Normal Temperature and Voltage only								
<b>Antenna Type:</b> FPCB				<b>Power Setting:</b> See test plan				
<b>Max. Directional Gain:</b> Antenna 5 = + 3.84 dBi; Antenna 6 = + 3.29 dBi								
<b>Total Directional Gain:</b> + 6.58 dBi								
<b>Signal State:</b> Modulated at 100%.								
<b>Ambient Temp.:</b> 20 °C				<b>Relative Humidity:</b> 45%				
<b>Band-Edge Results</b>								
Freq. (MHz)	Level (dBuV/m)	Pol. (H/V)	Limit (dBuV/m)	Margin (dB)	Det.	Table Deg.	Tower (cm)	Note
5636.87	66.18	V	68.23	-2.05	Pk	192	127	PLOT 78: 11a-6Mbps-5745MHz-TX27.5-Ch0 & Ch1
5936.47	66.17	H	68.23	-2.06	Pk	210	113	PLOT 79: 11a-6Mbps-5745MHz-TX27.5-Ch0 & Ch1
5930.16	65.84	V	68.23	-2.39	Pk	197	108	PLOT 80: 11a-6Mbps-5825MHz-TX27.5-Ch0 & Ch1
5941.38	65.75	H	68.23	-2.48	Pk	215	117	PLOT 81: 11a-6Mbps-5825MHz-TX27.5-Ch0 & Ch1
5930.86	65.94	V	68.23	-2.29	Pk	199	126	PLOT 82: HT20-MCS0-5745MHz-TX27.5-Ch0 & Ch1
5939.98	65.61	H	68.23	-2.62	Pk	205	111	PLOT 83: HT20-MCS0-5745MHz-TX27.5-Ch0 & Ch1
5936.47	65.34	V	68.23	-2.89	Pk	191	124	PLOT 84: HT20-MCS0-5825MHz-TX27.5-Ch0 & Ch1
5938.58	65.93	H	68.23	-2.30	Pk	210	141	PLOT 85: HT20-MCS0-5825MHz-TX27.5-Ch0 & Ch1
5641.58	67.89	V	68.23	-0.34	Pk	196	128	PLOT 86: HT40-MCS0-5755MHz-TX26-Ch0 & Ch1
5651.40	67.90	H	68.23	-0.33	Pk	214	129	PLOT 87: HT40-MCS0-5755MHz-TX26-Ch0 & Ch1
5927.35	66.37	V	68.23	-1.86	Pk	196	116	PLOT 88: HT40-MCS0-5795MHz-TX26-Ch0 & Ch1
5930.16	66.11	H	68.23	-2.12	Pk	214	124	PLOT 89: HT40-MCS0-5795MHz-TX26-Ch0 & Ch1
5638.08	67.40	V	68.23	-0.83	Pk	194	131	PLOT 90: VHT40-MCS0-5755MHz-TX26-Ch0 & Ch1
5646.49	66.55	H	68.23	-1.68	Pk	214	149	PLOT 91: VHT40-MCS0-5755MHz-TX26-Ch0 & Ch1
5929.46	67.40	V	68.23	-0.83	Pk	195	116	PLOT 92: VHT40-MCS0-5795MHz-TX26-Ch0 & Ch1
5930.86	67.42	H	68.23	-0.81	Pk	214	129	PLOT 93: VHT40-MCS0-5795MHz-TX26-Ch0 & Ch1
5647.19	66.95	V	68.23	-1.28	Pk	191	135	PLOT 94: VHT80-MCS0-5775MHz-TX20.5-Ch0 & Ch1
5650.00	67.19	H	68.23	-1.04	Pk	214	123	PLOT 95: VHT80-MCS0-5775MHz-TX20.5-Ch0 & Ch1
<b>Note:</b> Band-edge frequencies for UNII Band 3 are not a restricted band.								

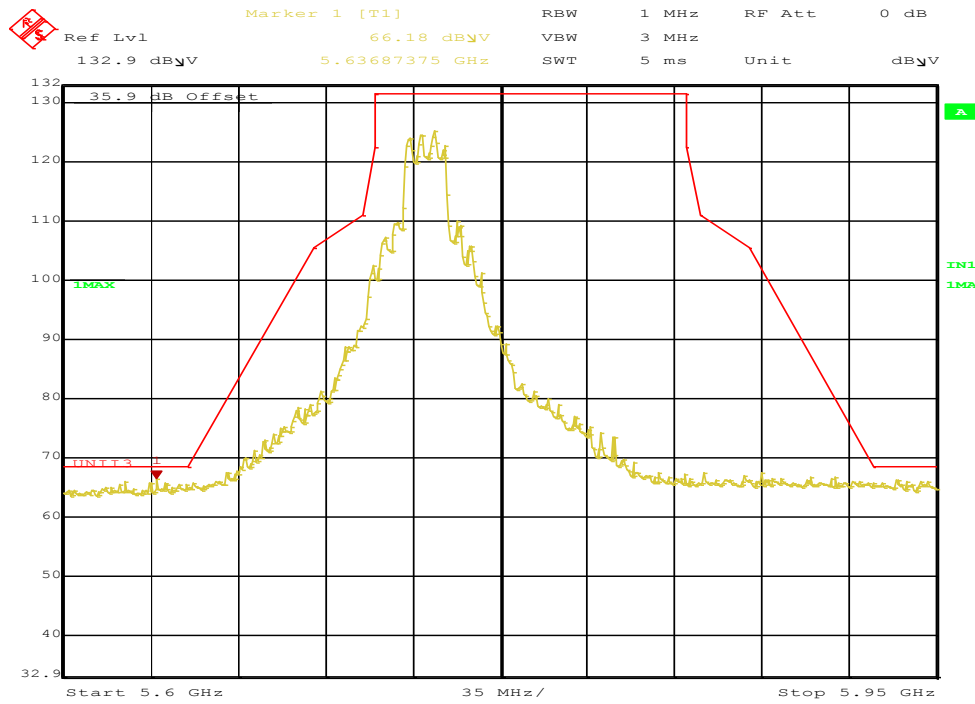

8 Date: 5.APR.2017 15:42:17

**Figure 78: Radiated Emission Below Edge for 11a 5745 MHz – Vert. (Pk)**

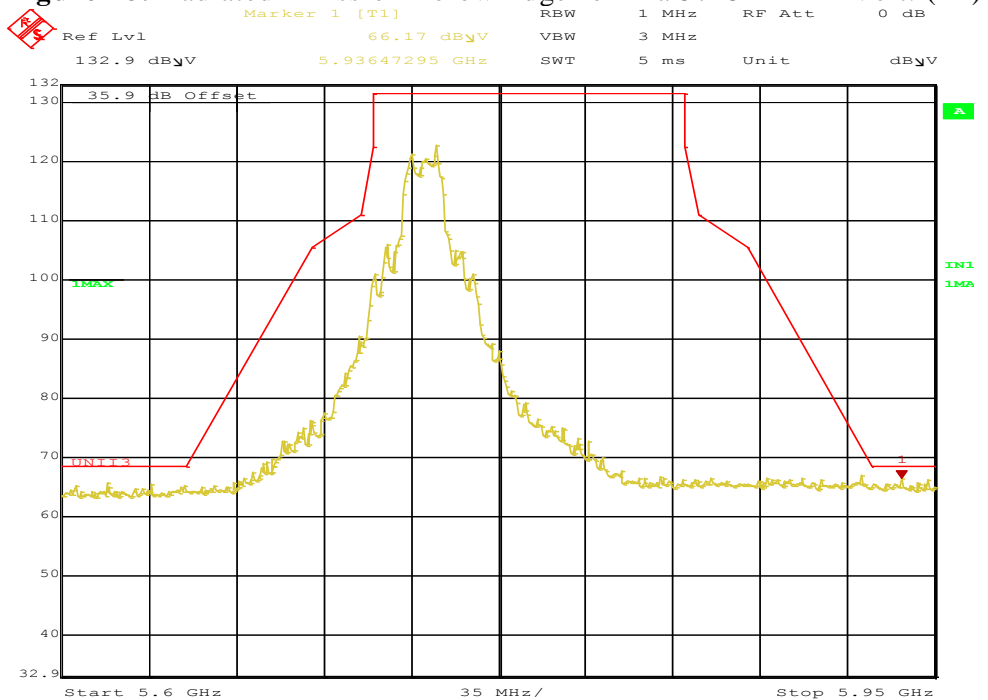

Date: 5.APR.2017 15:46:04

**Figure 79: Radiated Emission Below Edge for 11a 5745 MHz – Horz. (Pk)**

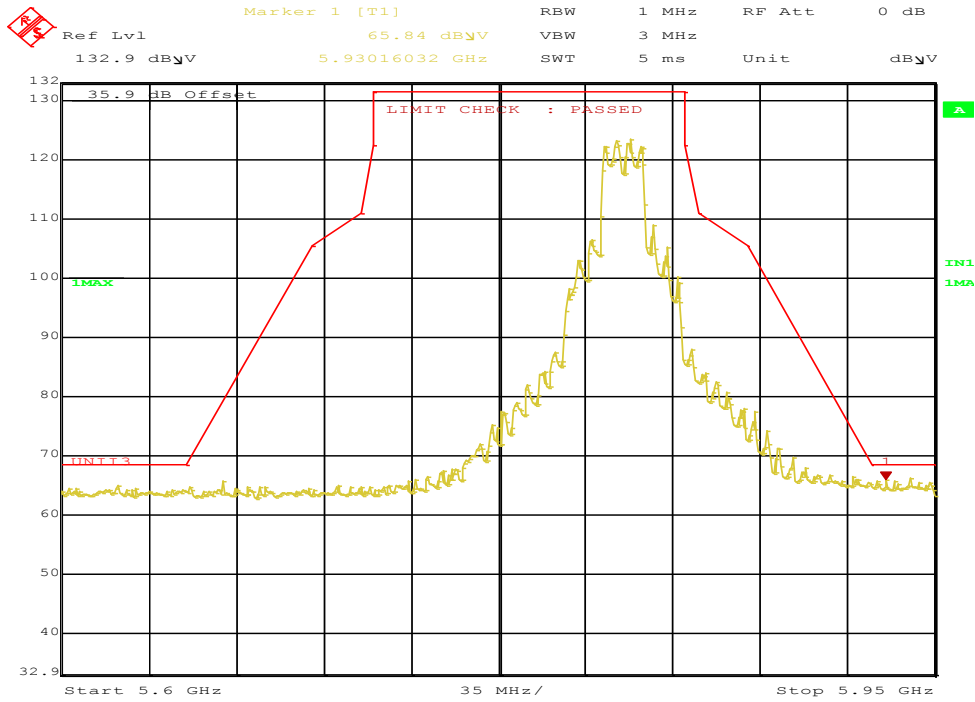

Date: 5.APR.2017 16:21:02

**Figure 80: Radiated Emission Above Edge for 11a 5825 MHz – Vert. (Pk)**

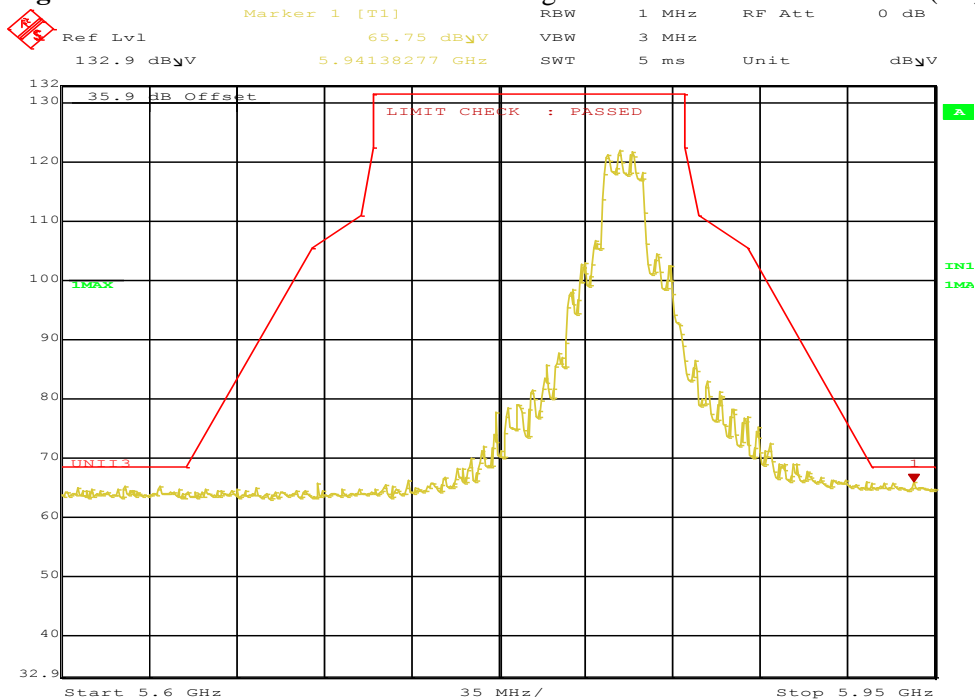

Date: 5.APR.2017 16:18:57

**Figure 81: Radiated Emission Above Edge for 11a 5825 MHz – Horz. (Pk)**

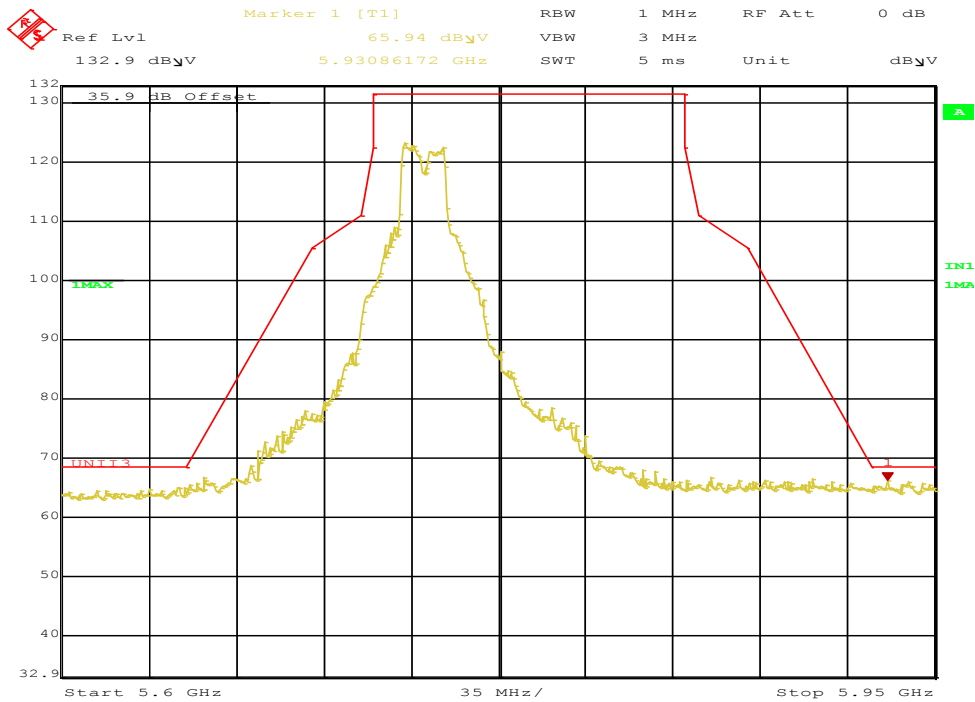

Date: 5.APR.2017 15:50:43

**Figure 82: Radiated Emission Below Edge for HT20 5745 MHz – Vert. (Pk)**

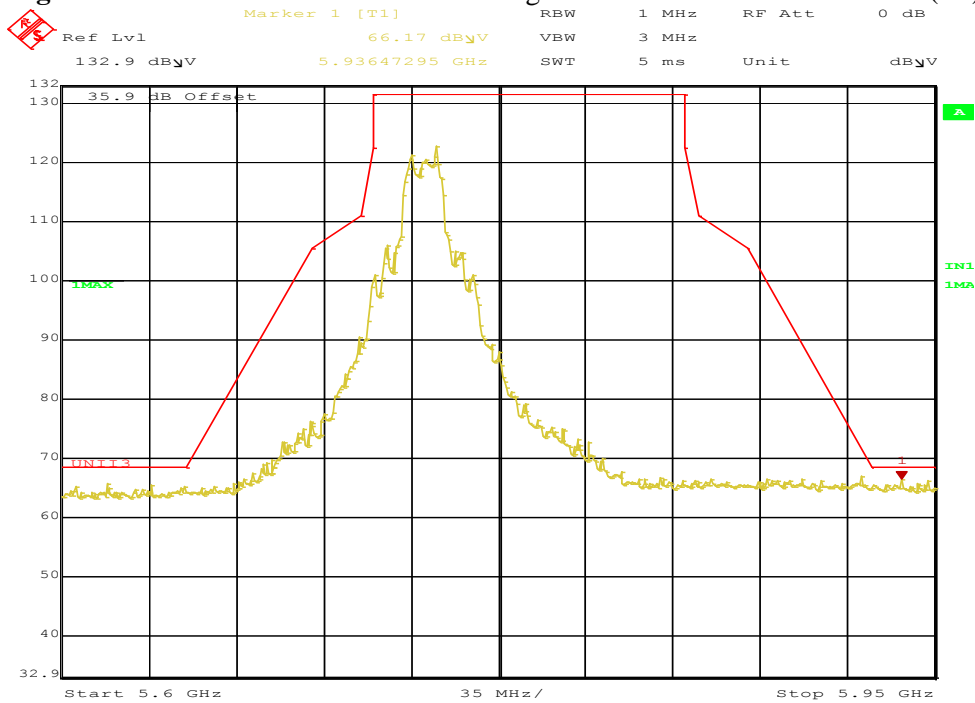

Date: 5.APR.2017 15:46:04

**Figure 83: Radiated Emission Below Edge for HT20 5745 MHz – Horz. (Pk)**

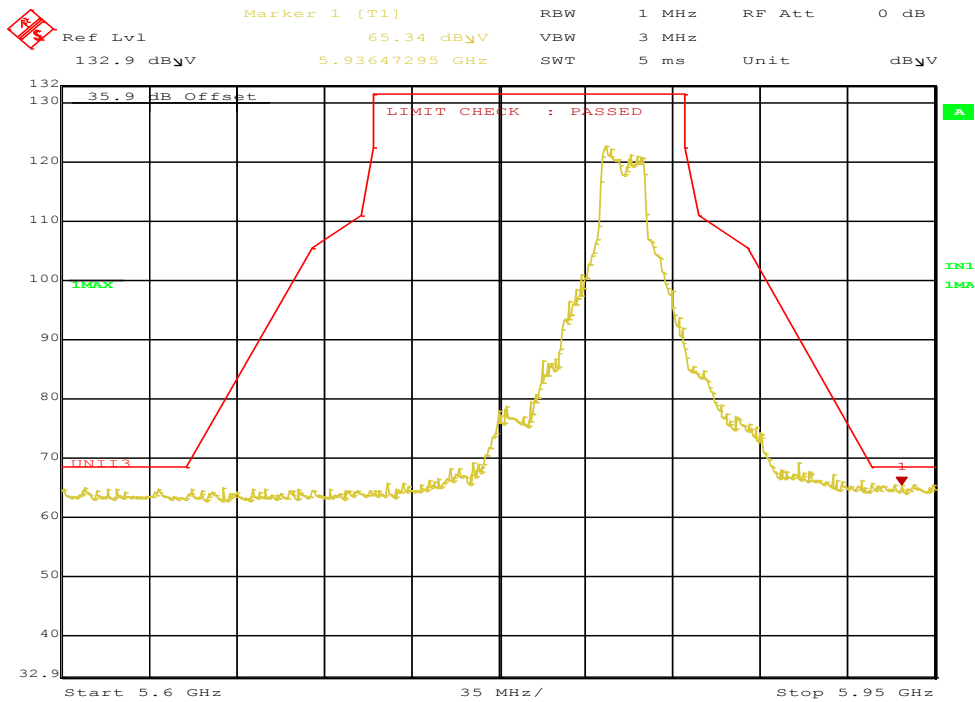

Date: 5.APR.2017 16:25:51

**Figure 84: Radiated Emission Above Edge for HT20 5825 MHz – Vert. (Pk)**

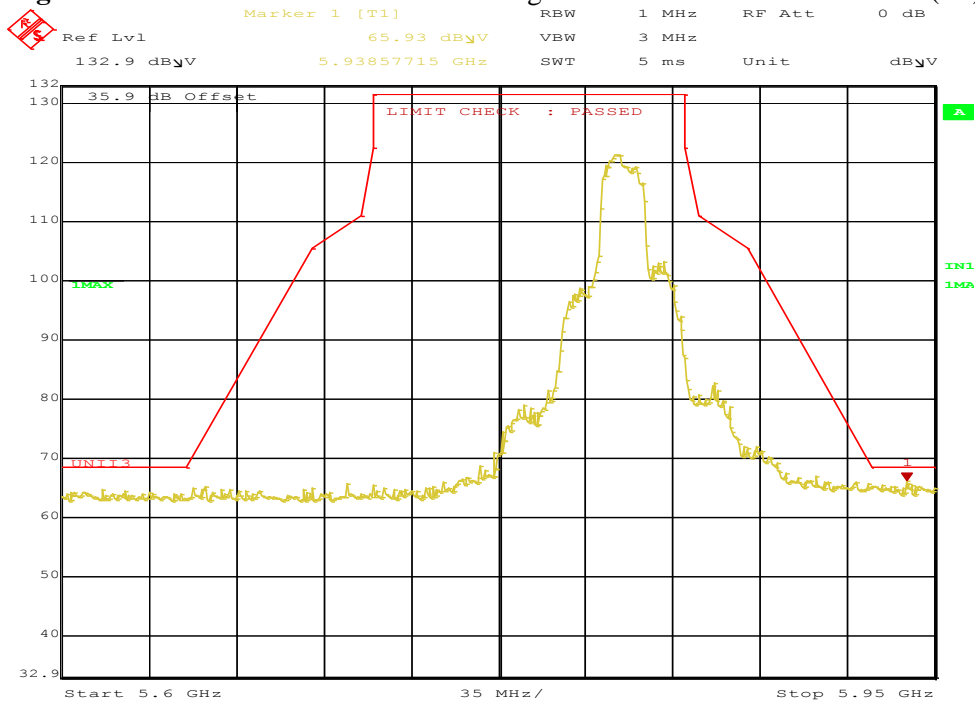

Date: 5.APR.2017 16:23:45

**Figure 85: Radiated Emission Above Edge for HT20 5825 MHz – Horz. (Pk)**

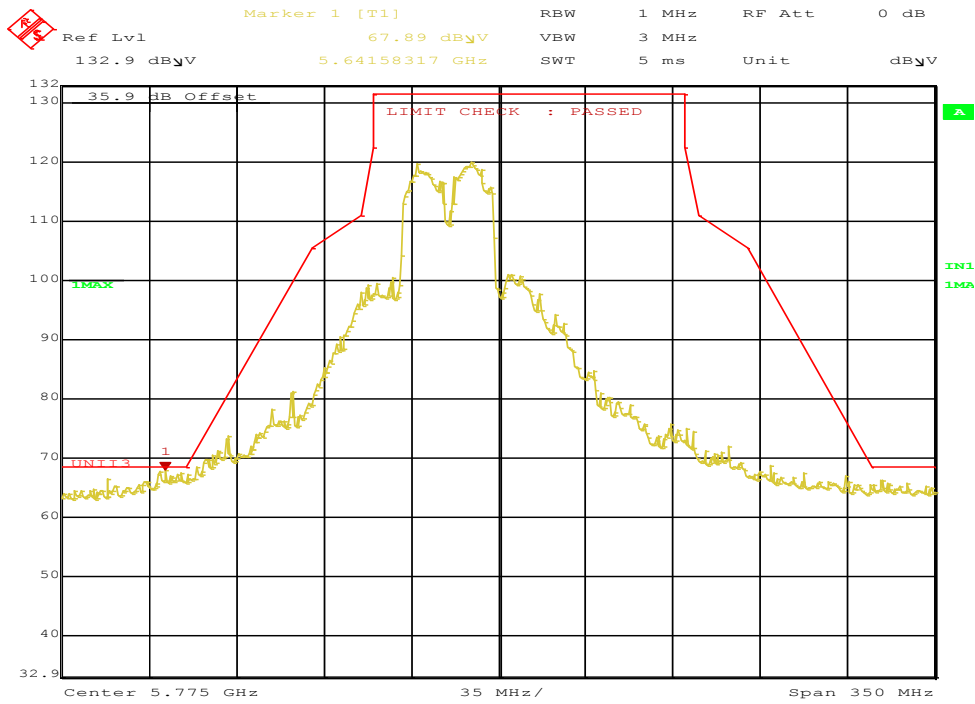

Date: 5.APR.2017 15:57:23

**Figure 86: Radiated Emission Below Edge for HT40 5755 MHz – Vert. (Pk)**

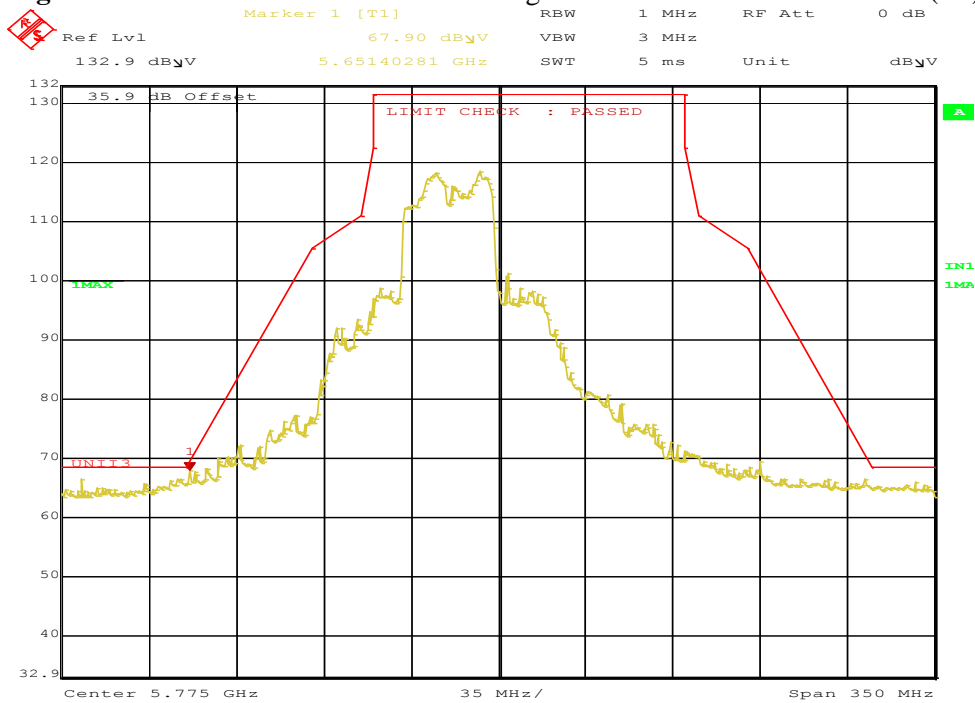

Date: 5.APR.2017 16:00:25

**Figure 87: Radiated Emission Below Edge for HT40 5755 MHz – Horz. (Pk)**

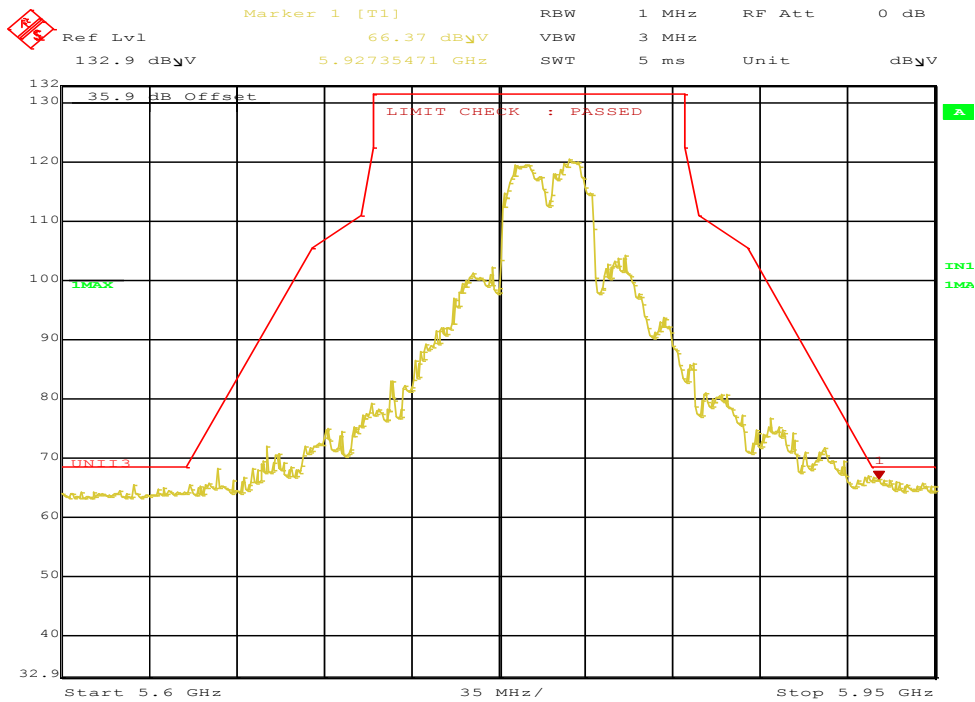

Date: 5.APR.2017 16:31:37

**Figure 88: Radiated Emission Above Edge for HT40 5795 MHz – Vert. (Pk)**

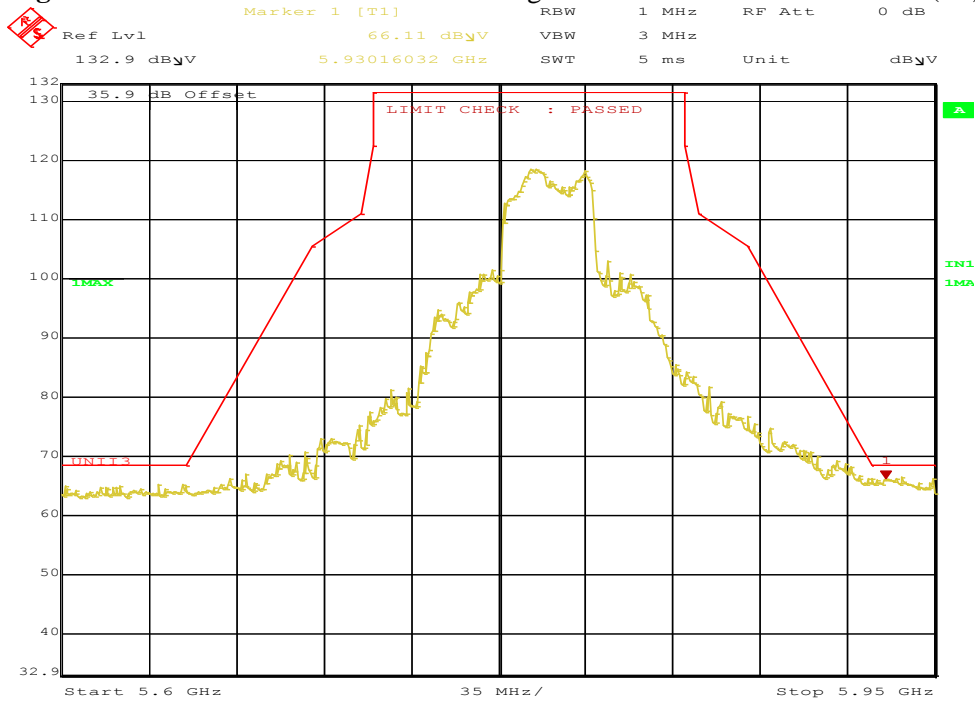

Date: 5.APR.2017 16:29:38

**Figure 89: Radiated Emission Above Edge for HT40 5795 MHz – Horz. (Pk)**



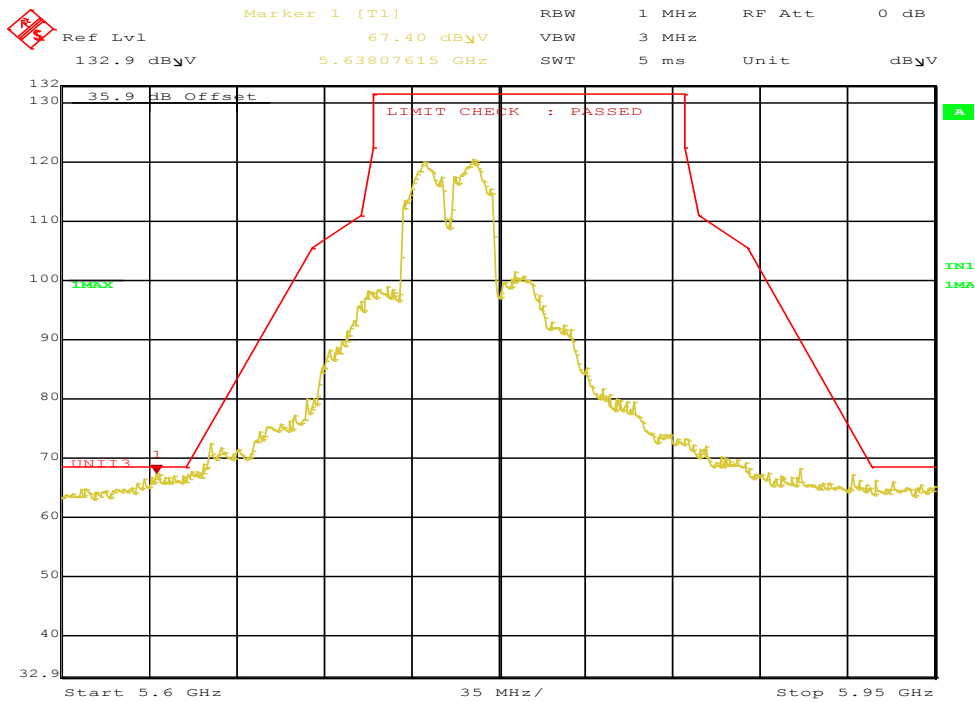

Date: 5.APR.2017 16:04:50

**Figure 90: Radiated Emission Below Edge for VHT40 5755 MHz – Vert. (Pk)**

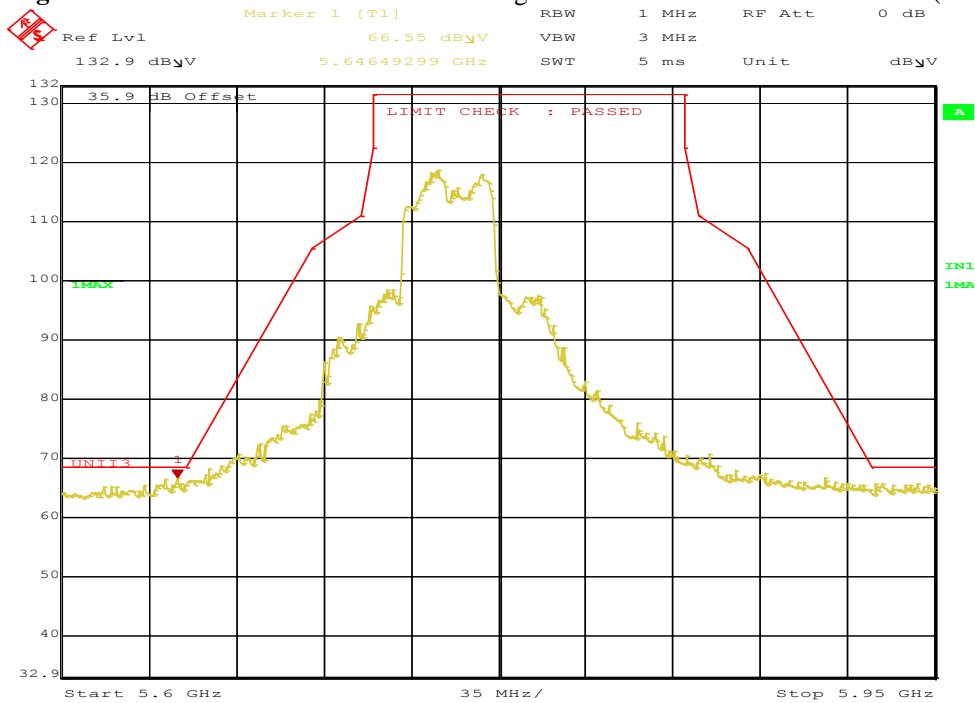

Date: 5.APR.2017 16:07:07

**Figure 91: Radiated Emission Below Edge for VHT40 5755 MHz – Horz. (Pk)**

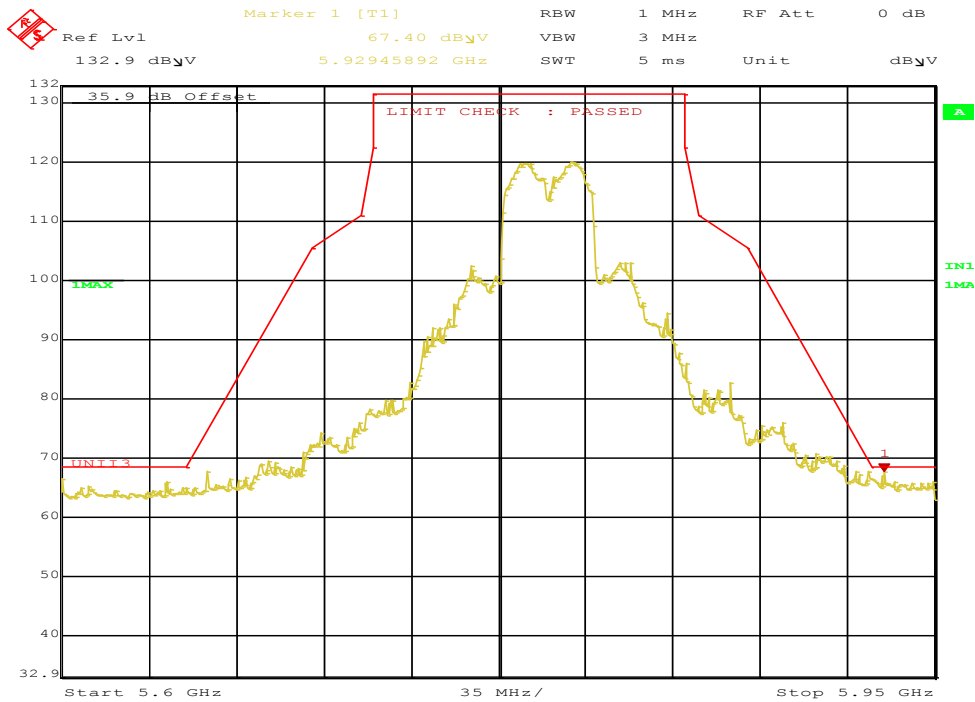

Date: 5.APR.2017 16:37:37

**Figure 92: Radiated Emission Above Edge for VHT40 5795 MHz – Vert. (Pk)**

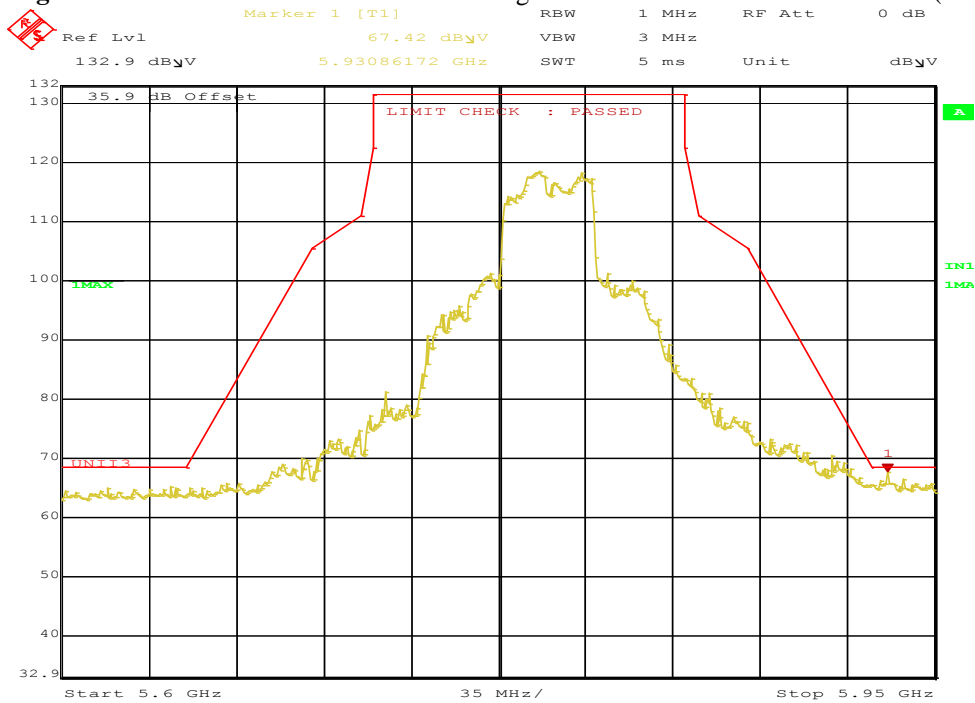

Date: 5.APR.2017 16:34:04

**Figure 93: Radiated Emission Above Edge for VHT40 5795 MHz – Horz. (Pk)**

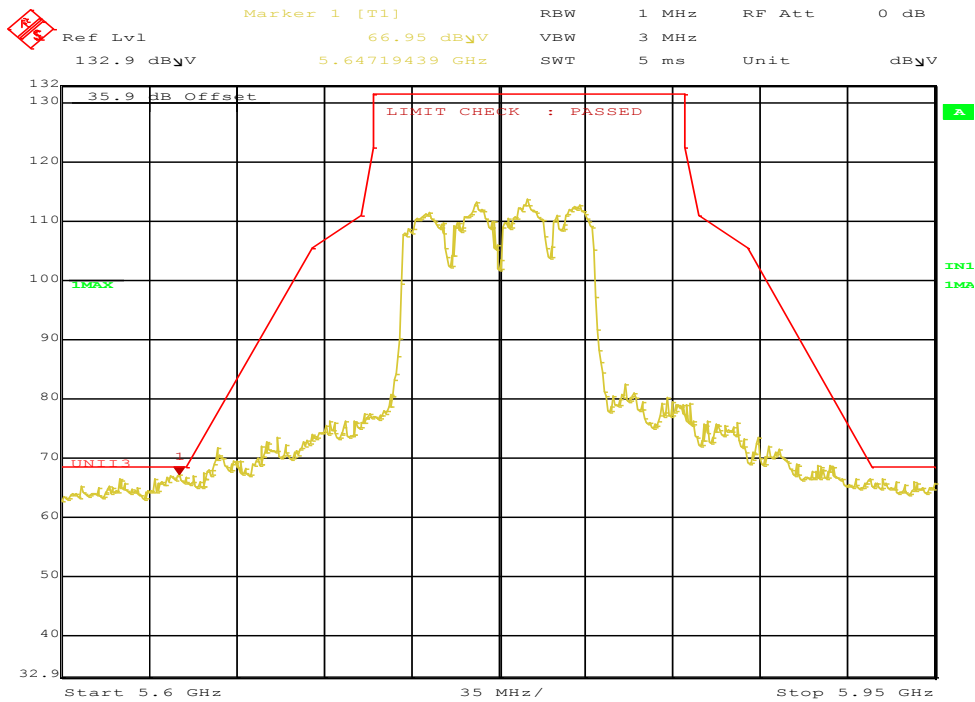

Date: 5.APR.2017 16:11:39

**Figure 94:** Radiated Emission Below Edge for VHT80 5775 MHz – Vert. (Pk)

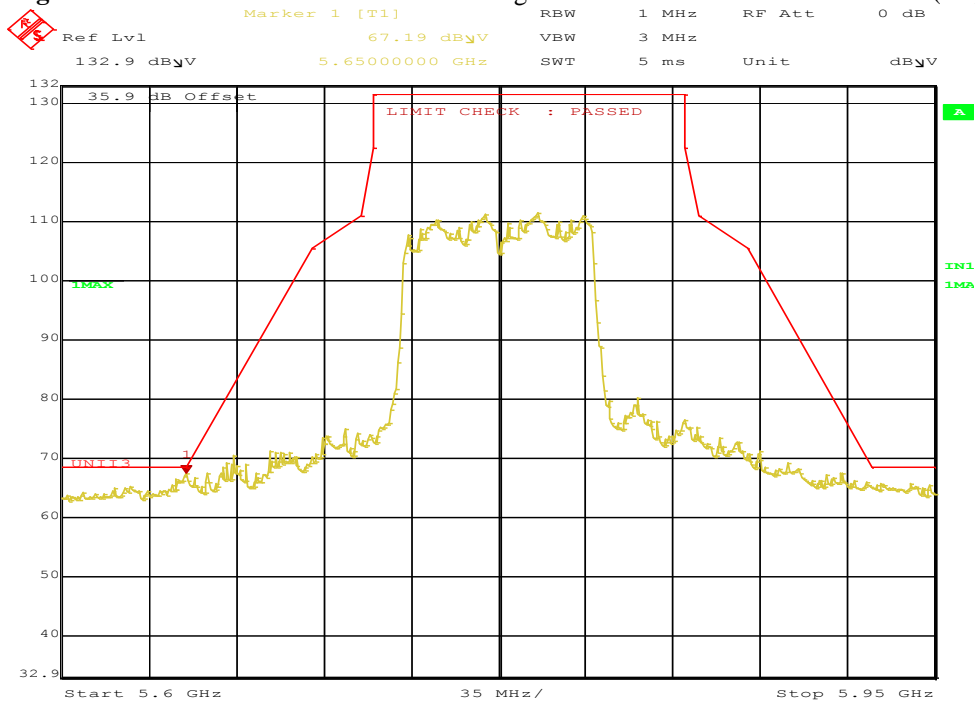

Date: 5.APR.2017 16:13:17

**Figure 95:** Radiated Emission Below Edge for VHT80 5775 MHz – Horz. (Pk)

<b>SOP 1 Radiated Emissions</b>		Tracking # 31761402.001 Page 1 of 15	
<b>EUT Name</b>	Wi-Fi Router	<b>Date</b>	Apr 11, 2017
<b>EUT Model</b>	B010001 (USA), B010002 (IC)	<b>Temp / Hum in</b>	22° C / 37%rh
<b>EUT Serial</b>	SPE28JY	<b>Temp / Hum out</b>	N/A
<b>EUT Config.</b>	802.11a at 6Mbps / chain 0 & 1	<b>Line AC / Freq</b>	120 Vac / 60 Hz
<b>Standard</b>	CFR47 Part 15 Subpart E, RSS-247, RSS-GEN	<b>RBW / VBW</b>	120 kHz/ 300 kHz
<b>Dist/Ant Used</b>	3m / JB3	<b>Performed by</b>	Kerwinn Corpuz

30 MHz – 1 GHz Transmit at 5785 MHz

Frequency	Raw	Cable Loss	AF	Level	Detector	Polarity	Height	Azimuth	Limit	Margin
MHz	dBuV/m	dB	dB	dBuV/m		H/V	cm	deg	dBuV/m	dB
32.64	44.65	2.59	-13.13	34.11	QP	V	109	190	40.00	-5.89
47.63	54.00	2.72	-22.75	33.97	QP	V	105	102	40.00	-6.03
84.96	56.08	2.97	-24.90	34.15	QP	V	112	118	40.00	-5.85
144.59	43.67	3.30	-19.41	27.56	QP	V	102	10	43.50	-15.94
172.39	47.76	3.43	-20.37	30.82	QP	V	105	134	43.50	-12.68
395.48	40.10	4.23	-16.00	28.33	QP	V	105	66	46.00	-17.67

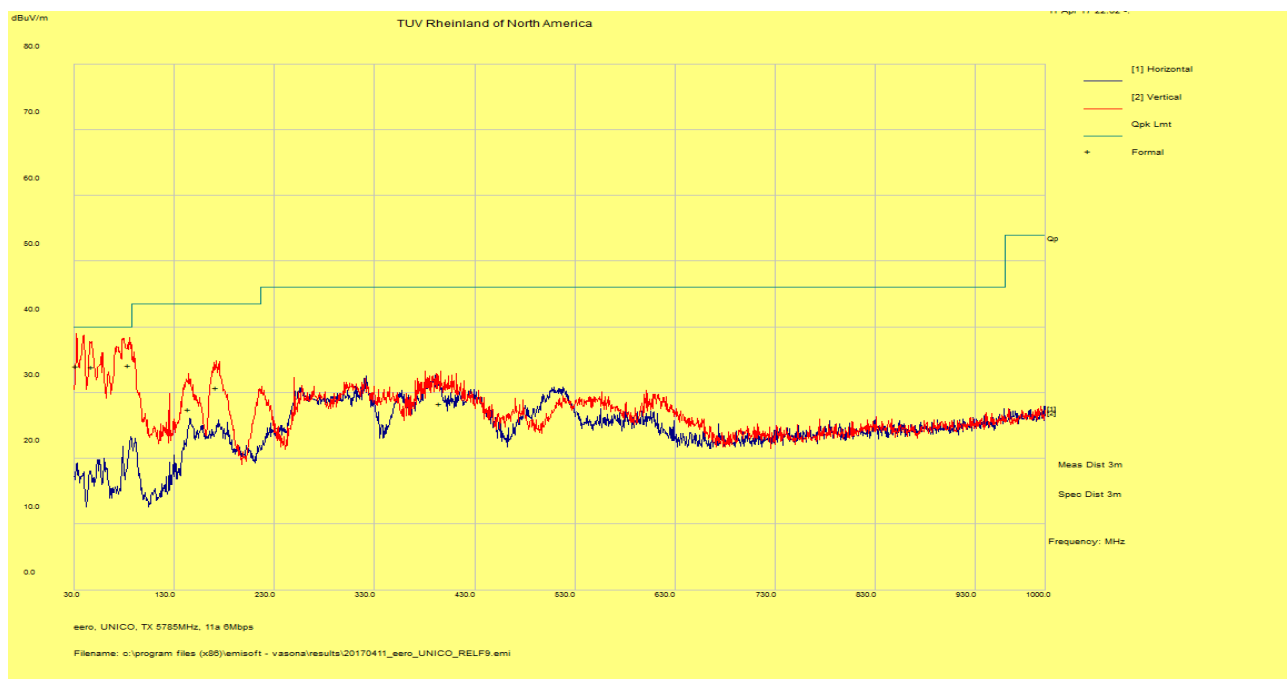

Spec Margin = E-Field QP - Limit, E-Field QP = FIM QP+ Total CF ± Uncertainty

Total CF= AF+ Cable Loss AF= Antenna factor + Preamp

Note: 1. Worst case was observed on Mid channel of 802.11a, 6Mbps mode.

2. Modes covered are HT20 and VHT20.

3. No significant emission was observed below 30MHz.

4. To reduce complexity and bulkiness of the report Worst case Plots are placed in the report.

<b>SOP 1 Radiated Emissions</b>		Tracking # 31761402.001 Page 2 of 15	
<b>EUT Name</b>	Wi-Fi Router	<b>Date</b>	Apr 12, 2017
<b>EUT Model</b>	B010001 (USA), B010002 (IC)	<b>Temp / Hum in</b>	22° C / 40%rh
<b>EUT Serial</b>	SPE28JY	<b>Temp / Hum out</b>	N/A
<b>EUT Config.</b>	802.11a at 6Mbps / chain 0 & 1	<b>Line AC / Freq</b>	120 Vac / 60 Hz
<b>Standard</b>	CFR47 Part 15 Subpart E, RSS-247, RSS-GEN	<b>RBW / VBW</b>	1 MHz/ 3 MHz
<b>Dist/Ant Used</b>	3m – EMCO3115 / 1m – AHA-840	<b>Performed by</b>	Colton Aliff

1 – 18 GHz Transmit at 5745 MHz (Low Channel)

Frequency	Raw	Cable Loss	AF	Level	Detector	Polarity	Height	Azimuth	Limit	Margin
MHz	dBuV/m	dB	dB	dBuV/m		H/V	cm	deg	dBuV/m	dB
17239.73	43.69	3.59	-8.30	38.98	Average	V	137	361	54.00	-15.02
11485.72	49.51	2.79	-12.07	40.23	Average	V	105	182	54.00	-13.78
17962.34	39.87	3.76	-3.05	40.59	Average	H	155	228	54.00	-13.41

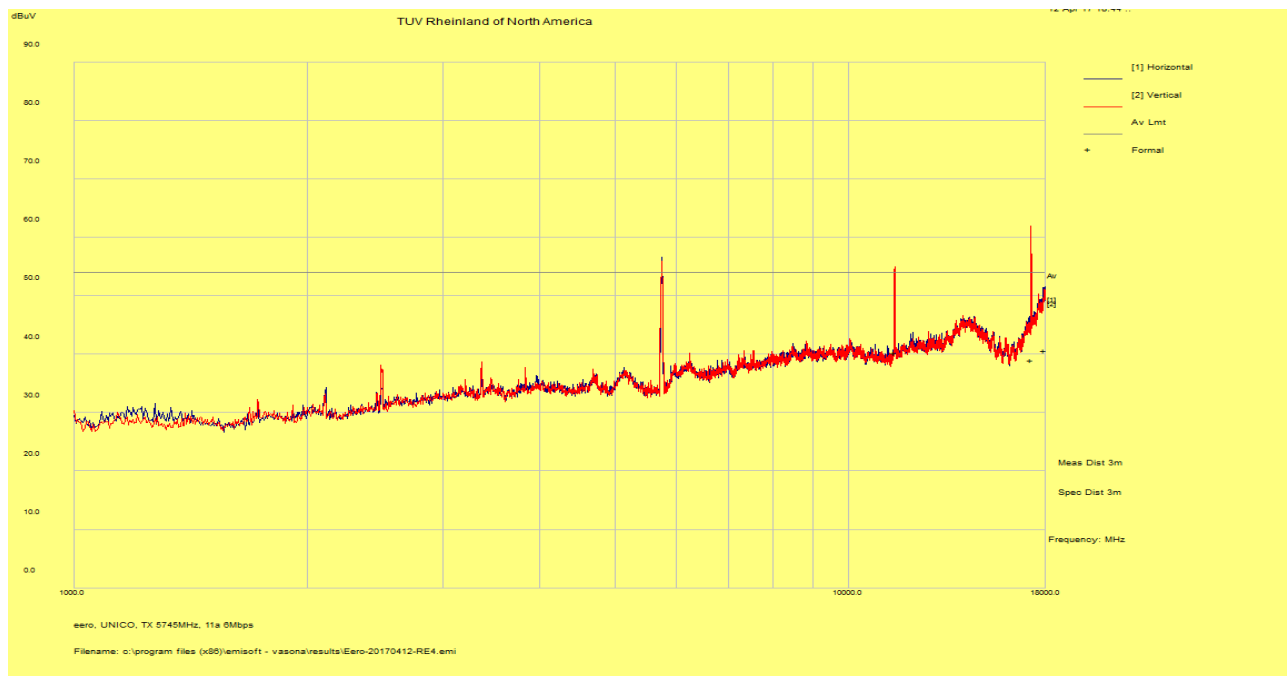

Spec Margin = E-Field AVG - Limit, E-Field AVG = FIM AVG+ Total CF ± Uncertainty  
 Total CF= AF+ Cable Loss AF= Antenna factor + Preamp

- Note:
1. Worst case was observed on 802.11a, 6Mbps mode.
  2. Modes covered are HT20 and VHT20.
  3. To reduce complexity and bulkiness of the report Worst case Plots are placed in the report.
  4. Emission above the limit is the fundamental.

<b>SOP 1 Radiated Emissions</b>		Tracking # 31761402.001 Page 3 of 15	
<b>EUT Name</b>	Wi-Fi Router	<b>Date</b>	Apr 13, 2017
<b>EUT Model</b>	B010001 (USA), B010002 (IC)	<b>Temp / Hum in</b>	22° C / 42%rh
<b>EUT Serial</b>	SPE28JY	<b>Temp / Hum out</b>	N/A
<b>EUT Config.</b>	802.11a at 6Mbps / chain 0 & 1	<b>Line AC / Freq</b>	120 Vac / 60 Hz
<b>Standard</b>	CFR47 Part 15 Subpart E, RSS-247, RSS-GEN	<b>RBW / VBW</b>	1 MHz/ 3 MHz
<b>Dist/Ant Used</b>	3m – EMCO3115 / 1m – AHA-840	<b>Performed by</b>	Colton Aliff

18 – 40 GHz Transmit at 5745 MHz (Low Channel)

Frequency	Raw	Cable Loss	AF	Level	Detector	Polarity	Height	Azimuth	Limit	Margin
MHz	dBuV/m	dB	dB	dBuV/m		H/V	cm	deg	dBuV/m	dB
39801.15	48.10	10.84	-13.54	45.40	Average	V	175	353	54.00	-8.60

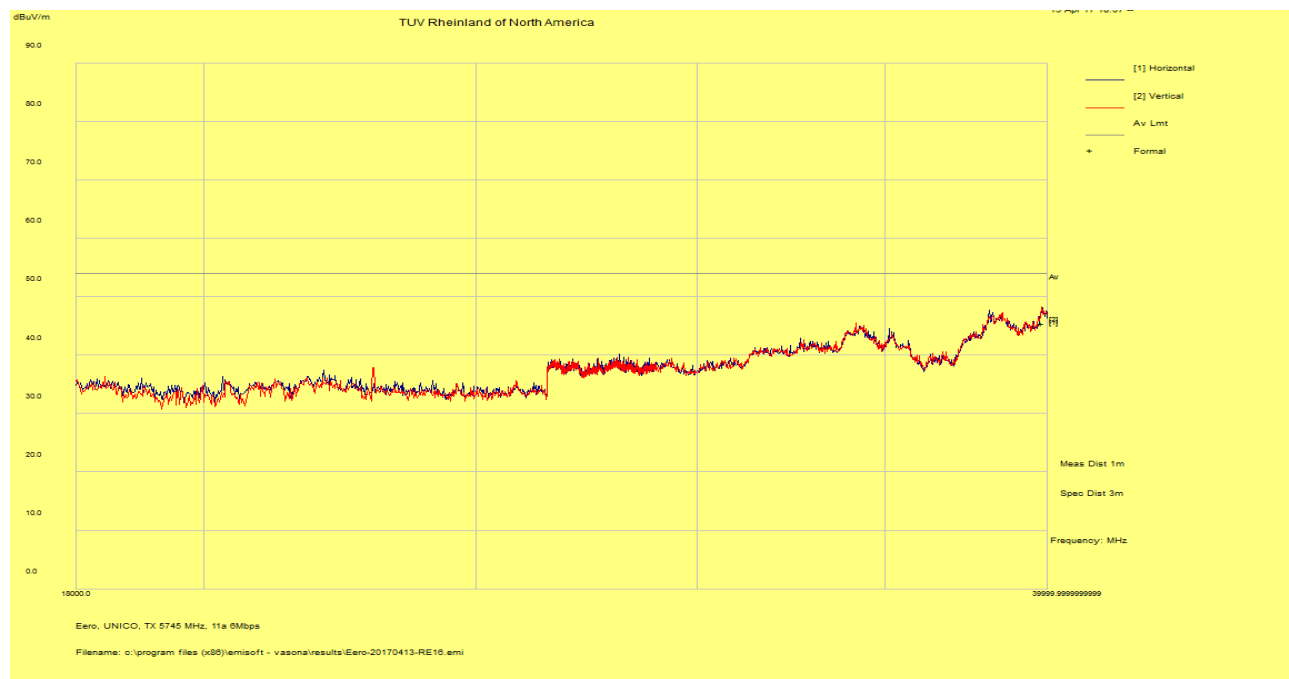

Spec Margin = E-Field AVG - Limit, E-Field AVG = FIM AVG+ Total CF ± Uncertainty

Total CF= AF+ Cable Loss AF= Antenna factor + Preamp

Note: 1. Worst case was observed on 802.11a, 6Mbps mode.

2. Modes covered are HT20 and VHT20.

3. To reduce complexity and bulkiness of the report Worst case Plots are placed in the report.

<b>SOP 1 Radiated Emissions</b>		Tracking # 31761402.001 Page 4 of 15	
<b>EUT Name</b>	Wi-Fi Router	<b>Date</b>	Apr 12, 2017
<b>EUT Model</b>	B010001 (USA), B010002 (IC)	<b>Temp / Hum in</b>	22° C / 40%rh
<b>EUT Serial</b>	SPE28JY	<b>Temp / Hum out</b>	N/A
<b>EUT Config.</b>	802.11a at 6Mbps / chain 0 & 1	<b>Line AC / Freq</b>	120 Vac / 60 Hz
<b>Standard</b>	CFR47 Part 15 Subpart E, RSS-247, RSS-GEN	<b>RBW / VBW</b>	1 MHz/ 3 MHz
<b>Dist/Ant Used</b>	3m – EMCO3115 / 1m – AHA-840	<b>Performed by</b>	Colton Aliff

1 – 18 GHz Transmit at 5785 MHz (Mid Channel)

Frequency	Raw	Cable Loss	AF	Level	Detector	Polarity	Height	Azimuth	Limit	Margin
MHz	dBuV/m	dB	dB	dBuV/m		H/V	cm	deg	dBuV/m	dB
11569.98	49.92	2.77	-11.94	40.75	Average	V	136	10	54.00	-13.25
17361.91	40.73	3.59	-7.71	36.61	Average	V	218	54	54.00	-17.39
17916.03	39.93	3.72	-3.28	40.37	Average	H	219	282	54.00	-13.63

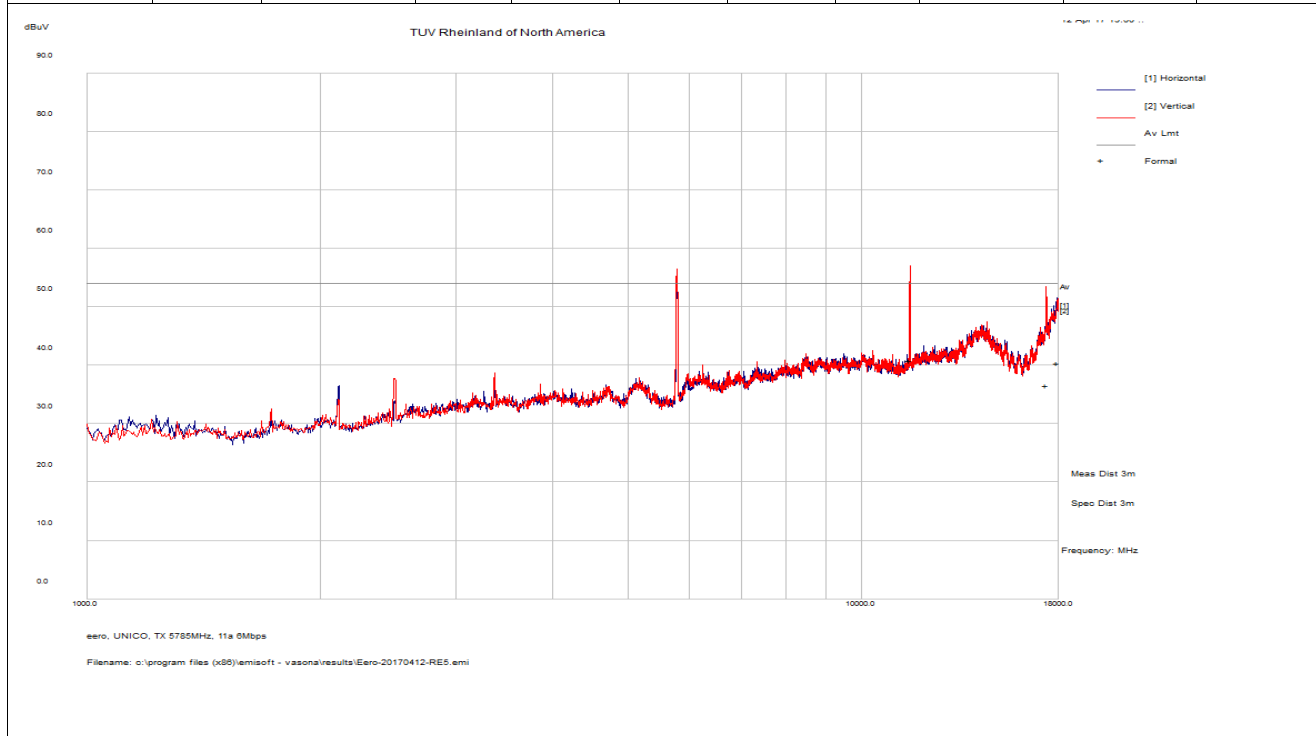

Spec Margin = E-Field AVG - Limit, E-Field AVG = FIM AVG+ Total CF ± Uncertainty  
 Total CF= AF+ Cable Loss AF= Antenna factor + Preamp

- Note:
1. Worst case was observed on 802.11a, 6Mbps mode.
  2. Modes covered are HT20 and VHT20.
  3. To reduce complexity and bulkiness of the report Worst case Plots are placed in the report.
  4. Emission above the limit is the fundamental.

**SOP 1 Radiated Emissions**

Tracking # 31761402.001 Page 5 of 15

<b>EUT Name</b>	Wi-Fi Router	<b>Date</b>	Apr 13, 2017
<b>EUT Model</b>	B010001 (USA), B010002 (IC)	<b>Temp / Hum in</b>	22° C / 42%rh
<b>EUT Serial</b>	SPE28JY	<b>Temp / Hum out</b>	N/A
<b>EUT Config.</b>	802.11a at 6Mbps / chain 0 & 1	<b>Line AC / Freq</b>	120 Vac / 60 Hz
<b>Standard</b>	CFR47 Part 15 Subpart E, RSS-247, RSS-GEN	<b>RBW / VBW</b>	1 MHz/ 3 MHz
<b>Dist/Ant Used</b>	3m – EMCO3115 / 1m – AHA-840	<b>Performed by</b>	Colton Aliff

18 – 40 GHz Transmit at 5785 MHz (Mid Channel)

Frequency	Raw	Cable Loss	AF	Level	Detector	Polarity	Height	Azimuth	Limit	Margin
MHz	dBuV/m	dB	dB	dBuV/m		H/V	cm	deg	dBuV/m	dB
39866.71	48.39	10.88	-13.53	45.74	Average	H	189	284	54.00	-8.26

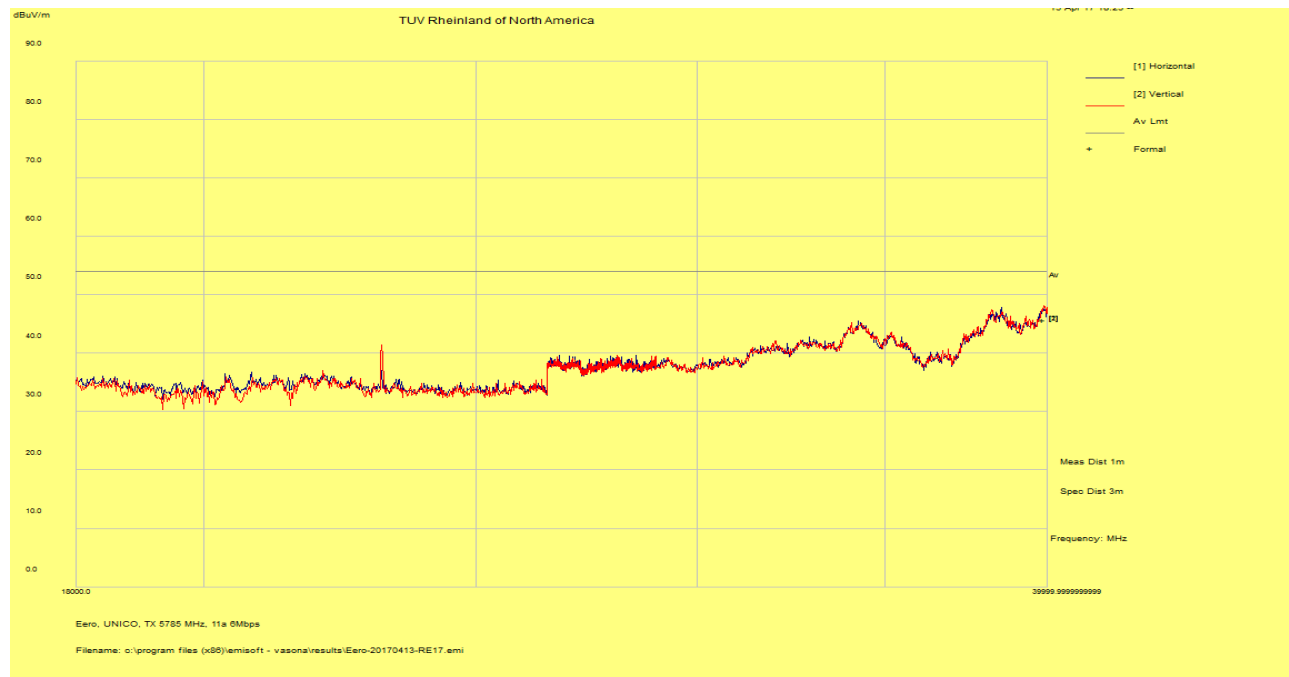

Spec Margin = E-Field AVG - Limit, E-Field AVG = FIM AVG+ Total CF ± Uncertainty

Total CF= AF+ Cable Loss AF= Antenna factor + Preamp

Note: 1. Worst case was observed on 802.11a, 6Mbps mode.

2. Modes covered are HT20 and VHT20.

3. To reduce complexity and bulkiness of the report Worst case Plots are placed in the report.



<b>SOP 1 Radiated Emissions</b>		Tracking # 31761402.001 Page 6 of 15	
<b>EUT Name</b>	Wi-Fi Router	<b>Date</b>	Apr 12, 2017
<b>EUT Model</b>	B010001 (USA), B010002 (IC)	<b>Temp / Hum in</b>	22° C / 40%rh
<b>EUT Serial</b>	SPE28JY	<b>Temp / Hum out</b>	N/A
<b>EUT Config.</b>	802.11a at 6Mbps / chain 0 & 1	<b>Line AC / Freq</b>	120 Vac / 60 Hz
<b>Standard</b>	CFR47 Part 15 Subpart E, RSS-247, RSS-GEN	<b>RBW / VBW</b>	1 MHz/ 3 MHz
<b>Dist/Ant Used</b>	3m – EMCO3115 / 1m – AHA-840	<b>Performed by</b>	Colton Aliff

1 – 18 GHz Transmit at 5825 MHz (High Channel)

Frequency	Raw	Cable Loss	AF	Level	Detector	Polarity	Height	Azimuth	Limit	Margin
MHz	dBuV/m	dB	dB	dBuV/m		H/V	cm	deg	dBuV/m	dB
17957.45	40.19	3.76	-3.07	40.89	Average	H	152	116	54.00	-13.12
17470.35	43.25	3.59	-7.10	39.74	Average	V	221	72	54.00	-14.26

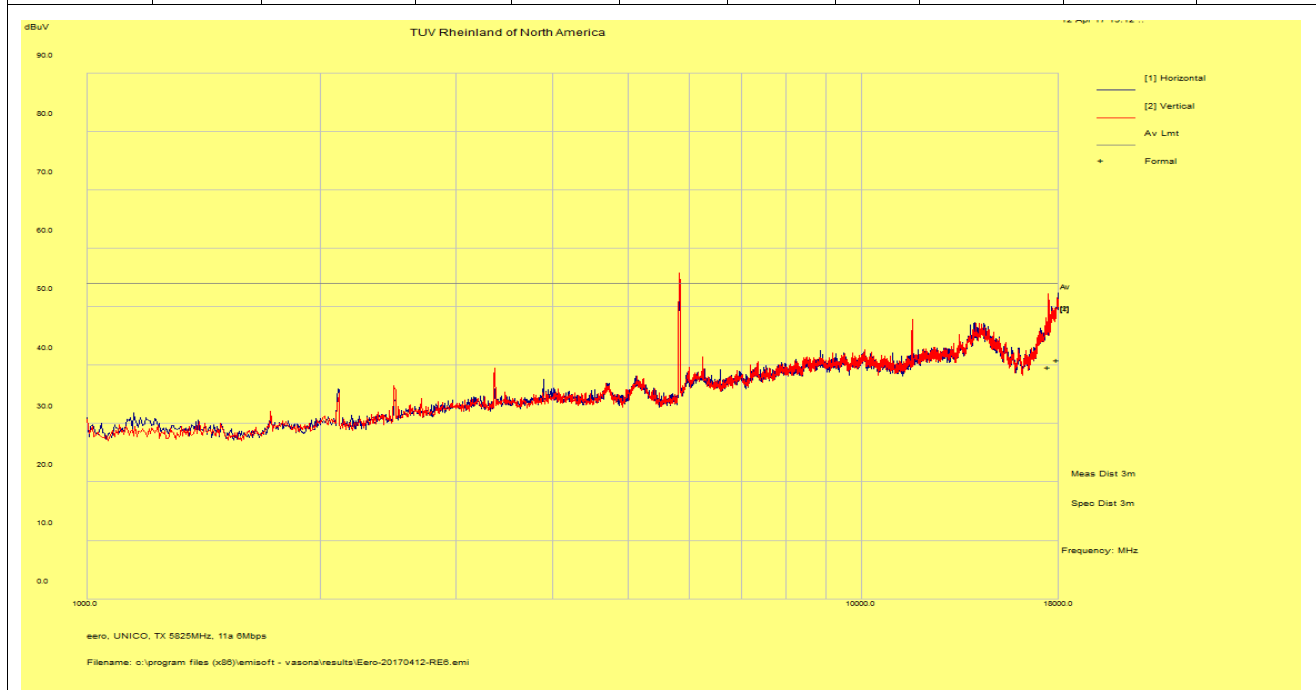

Spec Margin = E-Field AVG - Limit, E-Field AVG = FIM AVG+ Total CF ± Uncertainty

Total CF= AF+ Cable Loss AF= Antenna factor + Preamp

Note: 1. Worst case was observed on 802.11a, 6Mbps mode.

2. Modes covered are HT20 and VHT20.

3. To reduce complexity and bulkiness of the report Worst case Plots are placed in the report.

4. Emission above the limit is the fundamental.

**SOP 1 Radiated Emissions**

Tracking # 31761402.001 Page 7 of 15

<b>EUT Name</b>	Wi-Fi Router	<b>Date</b>	Apr 13, 2017
<b>EUT Model</b>	B010001 (USA), B010002 (IC)	<b>Temp / Hum in</b>	22° C / 42%rh
<b>EUT Serial</b>	SPE28JY	<b>Temp / Hum out</b>	N/A
<b>EUT Config.</b>	802.11a at 6Mbps / chain 0 & 1	<b>Line AC / Freq</b>	120 Vac / 60 Hz
<b>Standard</b>	CFR47 Part 15 Subpart E, RSS-247, RSS-GEN	<b>RBW / VBW</b>	1 MHz/ 3 MHz
<b>Dist/Ant Used</b>	3m – EMCO3115 / 1m – AHA-840	<b>Performed by</b>	Colton Aliff

18 – 40 GHz Transmit at 5825 MHz (High Channel)

Frequency	Raw	Cable Loss	AF	Level	Detector	Polarity	Height	Azimuth	Limit	Margin
MHz	dBuV/m	dB	dB	dBuV/m		H/V	cm	deg	dBuV/m	dB
39843.46	48.27	10.87	-13.54	45.60	Average	H	213	356	54.00	-8.40

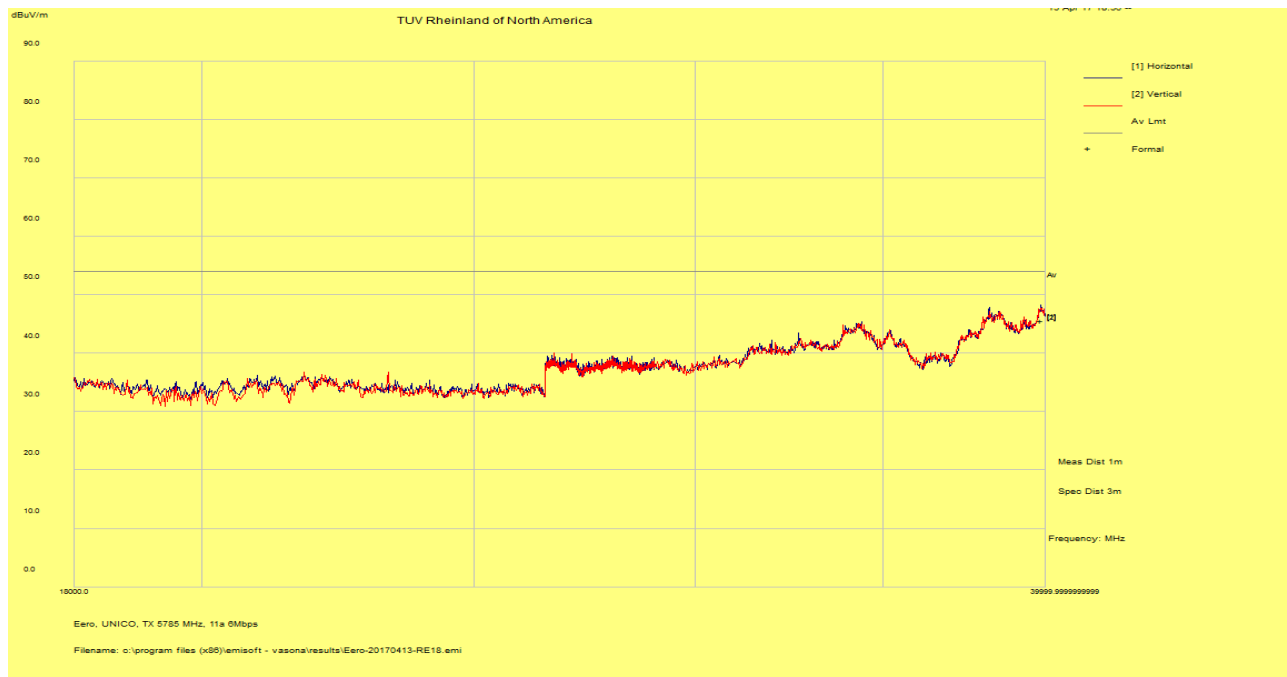

Spec Margin = E-Field AVG - Limit, E-Field AVG = FIM AVG+ Total CF ± Uncertainty

Total CF= AF+ Cable Loss AF= Antenna factor + Preamp

Note: 1. Worst case was observed on 802.11a, 6Mbps mode.

2. Modes covered are HT20 and VHT20.

3. To reduce complexity and bulkiness of the report Worst case Plots are placed in the report.

<b>SOP 1 Radiated Emissions</b>		Tracking # 31761402.001 Page 8 of 15	
<b>EUT Name</b>	Wi-Fi Router	<b>Date</b>	Apr 11, 2017
<b>EUT Model</b>	B010001 (USA), B010002 (IC)	<b>Temp / Hum in</b>	22° C / 37%rh
<b>EUT Serial</b>	SPE28JY	<b>Temp / Hum out</b>	N/A
<b>EUT Config.</b>	802.11n at HT40 MCS0 / chain 0 & 1	<b>Line AC / Freq</b>	120 Vac / 60 Hz
<b>Standard</b>	CFR47 Part 15 Subpart E, RSS-247, RSS-GEN	<b>RBW / VBW</b>	120 kHz/ 300 kHz
<b>Dist/Ant Used</b>	3m / JB3	<b>Performed by</b>	Kerwinn Corpuz

30 MHz – 1 GHz Transmit at 5755 MHz

Frequency	Raw	Cable Loss	AF	Level	Detector	Polarity	Height	Azimuth	Limit	Margin
MHz	dBuV/m	dB	dB	dBuV/m		H/V	cm	deg	dBuV/m	dB
39.19	49.53	2.64	-17.47	34.70	QP	V	125	134	40.00	-5.30
47.22	53.26	2.71	-22.54	33.43	QP	V	147	300	40.00	-6.57
80.68	55.70	2.95	-24.57	34.08	QP	V	117	94	40.00	-5.92
145.31	45.68	3.30	-19.45	29.53	QP	V	117	208	43.50	-13.97
175.03	48.78	3.44	-20.63	31.59	QP	V	107	124	43.50	-11.91
399.59	37.15	4.25	-15.92	25.49	QP	V	132	188	46.00	-20.52

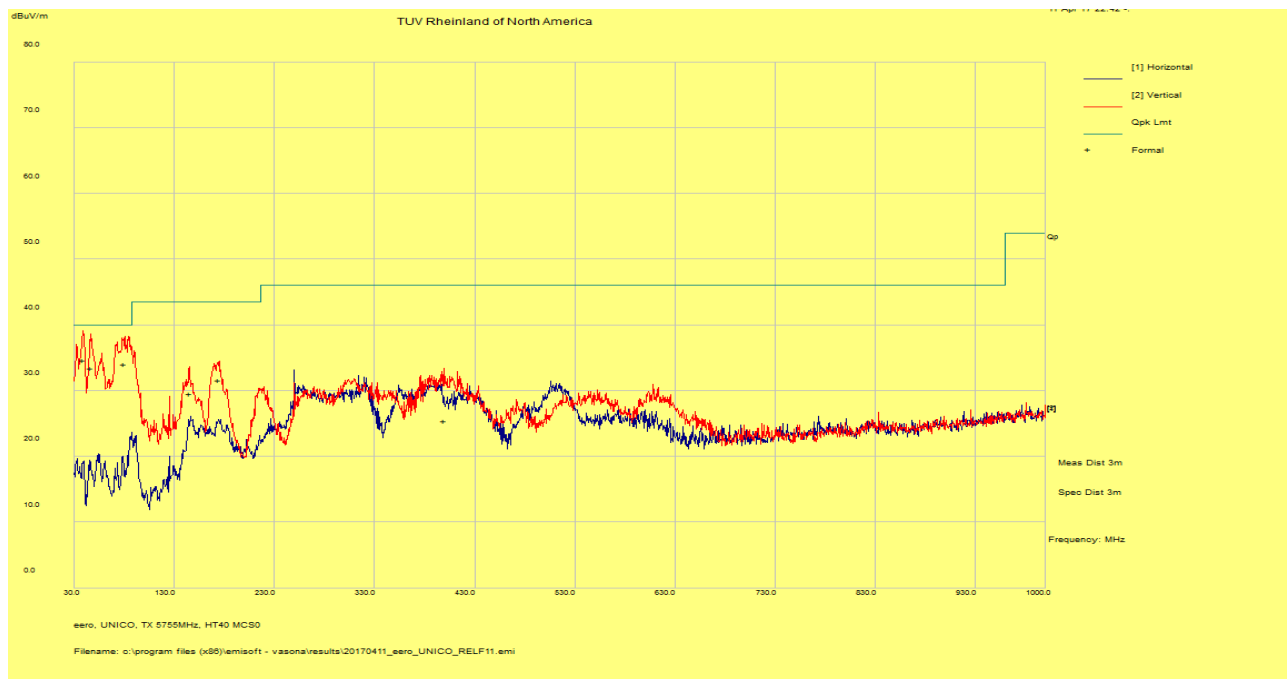

Spec Margin = E-Field QP - Limit, E-Field QP = FIM QP+ Total CF ± Uncertainty

Total CF= AF+ Cable Loss AF= Antenna factor + Preamp

Note: 1. Worst case was observed on low channel of HT40 MCS0 mode.

2. Mode covered is VHT40.

3. No significant emission was observed below 30MHz.

4. To reduce complexity and bulkiness of the report Worst case Plots are placed in the report.

**SOP 1 Radiated Emissions**

Tracking # 31761402.001 Page 9 of 15

<b>EUT Name</b>	Wi-Fi Router	<b>Date</b>	Apr 12, 2017
<b>EUT Model</b>	B010001 (USA), B010002 (IC)	<b>Temp / Hum in</b>	22° C / 40%rh
<b>EUT Serial</b>	SPE28JY	<b>Temp / Hum out</b>	N/A
<b>EUT Config.</b>	802.11n at HT40 MCS0 / chain 0 & 1	<b>Line AC / Freq</b>	120 Vac / 60 Hz
<b>Standard</b>	CFR47 Part 15 Subpart E, RSS-247, RSS-GEN	<b>RBW / VBW</b>	1 MHz/ 3 MHz
<b>Dist/Ant Used</b>	3m – EMCO3115 / 1m – AHA-840	<b>Performed by</b>	Colton Aliff

1 – 18 GHz Transmit at 5755 MHz (Low Channel)

Frequency	Raw	Cable Loss	AF	Level	Detector	Polarity	Height	Azimuth	Limit	Margin
MHz	dBuV/m	dB	dB	dBuV/m		H/V	cm	deg	dBuV/m	dB
17260.03	40.91	3.59	-8.21	36.29	Average	V	113	14	54.00	-17.71
11501.60	51.71	2.80	-12.04	42.46	Average	V	108	357	54.00	-11.54
17941.03	40.00	3.75	-3.15	40.60	Average	H	127	361	54.00	-13.40

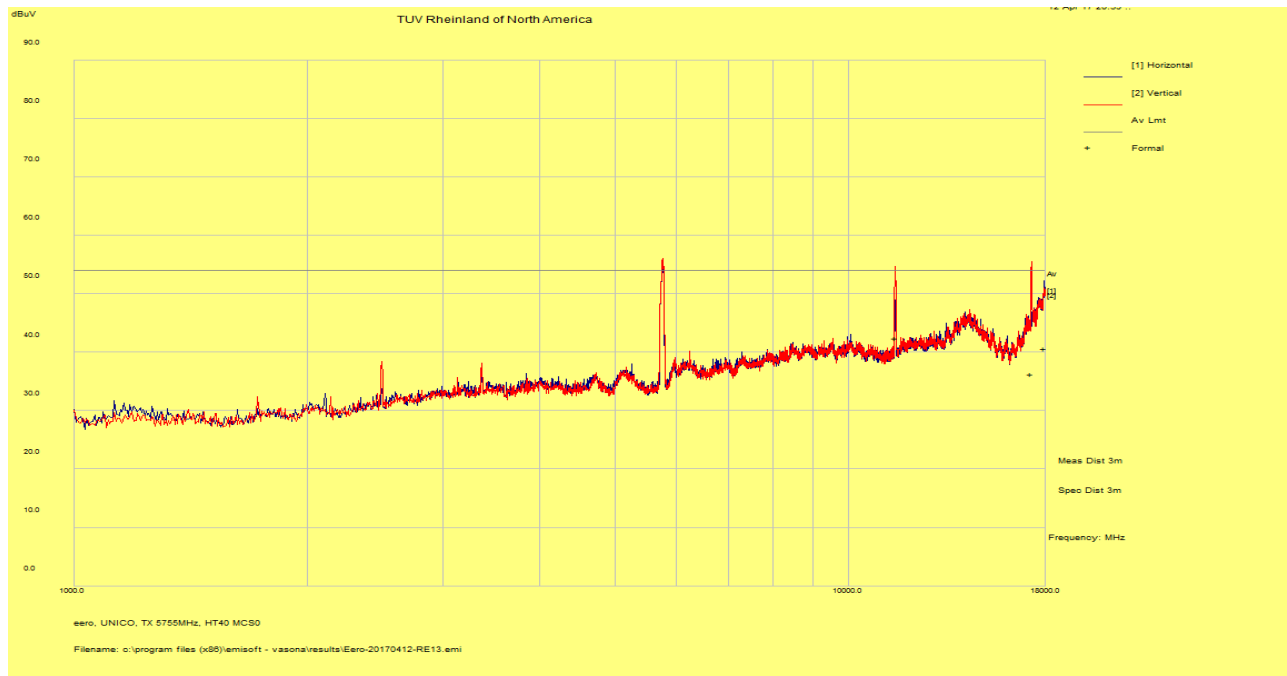

Spec Margin = E-Field AVG - Limit, E-Field AVG = FIM AVG+ Total CF ± Uncertainty  
 Total CF= AF+ Cable Loss AF= Antenna factor + Preamp

- Note:
1. Worst case was observed on HT40 MCS0 mode.
  2. Mode covered is VHT40.
  3. To reduce complexity and bulkiness of the report Worst case Plots are placed in the report.
  4. Emission above the limit is the fundamental.

**SOP 1 Radiated Emissions**

Tracking # 31761402.001 Page 10 of 15

<b>EUT Name</b>	Wi-Fi Router	<b>Date</b>	Apr 13, 2017
<b>EUT Model</b>	B010001 (USA), B010002 (IC)	<b>Temp / Hum in</b>	22° C / 42%rh
<b>EUT Serial</b>	SPE28JY	<b>Temp / Hum out</b>	N/A
<b>EUT Config.</b>	802.11n at HT40 MCS0 / chain 0 & 1	<b>Line AC / Freq</b>	120 Vac / 60 Hz
<b>Standard</b>	CFR47 Part 15 Subpart E, RSS-247, RSS-GEN	<b>RBW / VBW</b>	1 MHz/ 3 MHz
<b>Dist/Ant Used</b>	3m – EMCO3115 / 1m – AHA-840	<b>Performed by</b>	Colton Aliff

18 – 40 GHz Transmit at 5755 MHz (Low Channel)

Frequency	Raw	Cable Loss	AF	Level	Detector	Polarity	Height	Azimuth	Limit	Margin
MHz	dBuV/m	dB	dB	dBuV/m		H/V	cm	deg	dBuV/m	dB
38127.71	44.65	10.21	-12.02	42.84	Average	H	121	130	54.00	-11.16

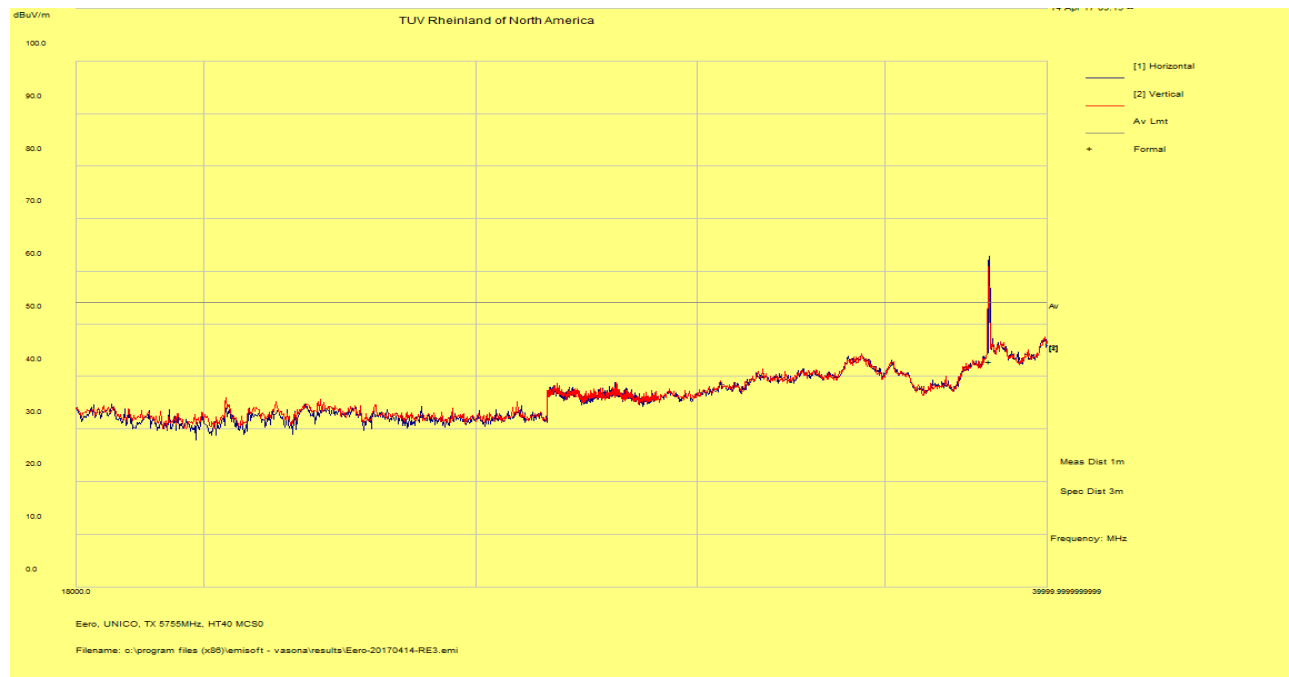

Spec Margin = E-Field AVG - Limit, E-Field AVG = FIM AVG+ Total CF ± Uncertainty

Total CF= AF+ Cable Loss AF= Antenna factor + Preamp

Note: 1. Worst case was observed on HT40 MCS0 mode.

2. Mode covered is VHT40.

3. To reduce complexity and bulkiness of the report Worst case Plots are placed in the report.

**SOP 1 Radiated Emissions**

Tracking # 31761402.001 Page 11 of 15

<b>EUT Name</b>	Wi-Fi Router	<b>Date</b>	Apr 12, 2017
<b>EUT Model</b>	B010001 (USA), B010002 (IC)	<b>Temp / Hum in</b>	22° C / 40%rh
<b>EUT Serial</b>	SPE28JY	<b>Temp / Hum out</b>	N/A
<b>EUT Config.</b>	802.11n at HT40 MCS0 / chain 0 & 1	<b>Line AC / Freq</b>	120 Vac / 60 Hz
<b>Standard</b>	CFR47 Part 15 Subpart E, RSS-247, RSS-GEN	<b>RBW / VBW</b>	1 MHz/ 3 MHz
<b>Dist/Ant Used</b>	3m – EMCO3115 / 1m – AHA-840	<b>Performed by</b>	Colton Aliff

1 – 18 GHz Transmit at 5795 MHz (High Channel)

Frequency	Raw	Cable Loss	AF	Level	Detector	Polarity	Height	Azimuth	Limit	Margin
MHz	dBuV/m	dB	dB	dBuV/m		H/V	cm	deg	dBuV/m	dB
11578.81	43.41	2.78	-11.92	34.27	Average	V	250	30	54.00	-19.73
17978.78	39.75	3.77	-2.97	40.54	Average	H	151	46	54.00	-13.46

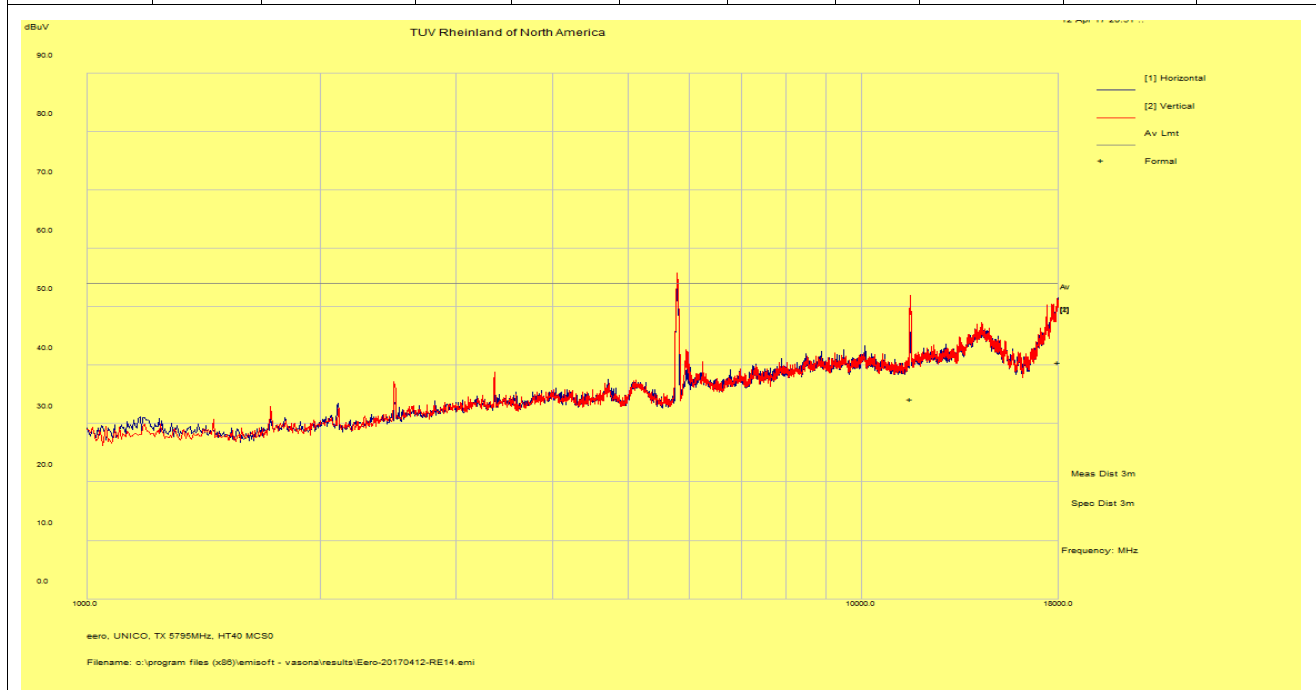

Spec Margin = E-Field AVG - Limit, E-Field AVG = FIM AVG+ Total CF ± Uncertainty

Total CF= AF+ Cable Loss AF= Antenna factor + Preamp

Note: 1. Worst case was observed on HT40 MCS0 mode.

2. Mode covered is VHT40.

3. To reduce complexity and bulkiness of the report Worst case Plots are placed in the report.

4. Emission above the limit is the fundamental.

<b>SOP 1 Radiated Emissions</b>		Tracking # 31761402.001 Page 12 of 15	
<b>EUT Name</b>	Wi-Fi Router	<b>Date</b>	Apr 13, 2017
<b>EUT Model</b>	B010001 (USA), B010002 (IC)	<b>Temp / Hum in</b>	22° C / 42%rh
<b>EUT Serial</b>	SPE28JY	<b>Temp / Hum out</b>	N/A
<b>EUT Config.</b>	802.11n at HT40 MCS0 / chain 0 & 1	<b>Line AC / Freq</b>	120 Vac / 60 Hz
<b>Standard</b>	CFR47 Part 15 Subpart E, RSS-247, RSS-GEN	<b>RBW / VBW</b>	1 MHz/ 3 MHz
<b>Dist/Ant Used</b>	3m – EMCO3115 / 1m – AHA-840	<b>Performed by</b>	Colton Aliff

18 – 40 GHz Transmit at 5795 MHz (High Channel)

Frequency	Raw	Cable Loss	AF	Level	Detector	Polarity	Height	Azimuth	Limit	Margin
MHz	dBuV/m	dB	dB	dBuV/m		H/V	cm	deg	dBuV/m	dB
38058.20	43.69	10.16	-12.05	41.8	Average	H	133	246	54.00	-12.20

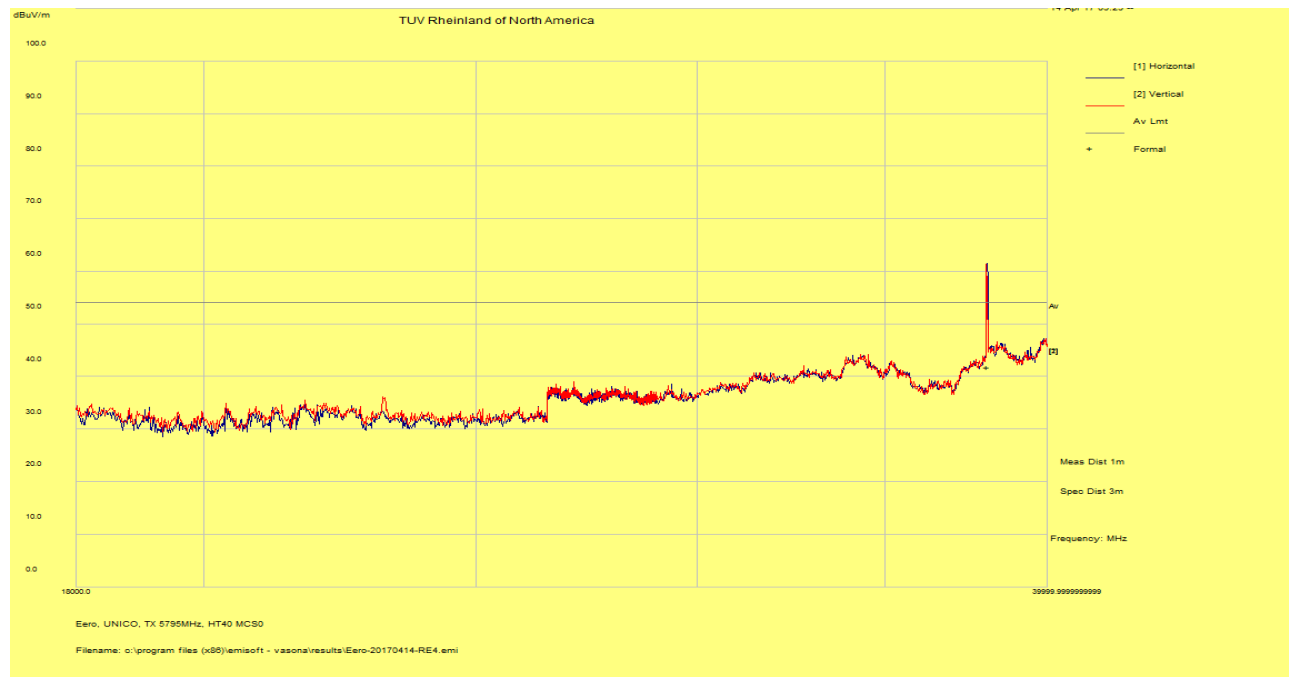

Spec Margin = E-Field AVG - Limit, E-Field AVG = FIM AVG+ Total CF ± Uncertainty

Total CF= AF+ Cable Loss AF= Antenna factor + Preamp

Note: 1. Worst case was observed on HT40 MCS0 mode.

2. Mode covered is VHT40.

3. To reduce complexity and bulkiness of the report Worst case Plots are placed in the report.

**SOP 1 Radiated Emissions**

Tracking # 31761402.001 Page 13 of 15

<b>EUT Name</b>	Wi-Fi Router	<b>Date</b>	Apr 11, 2017
<b>EUT Model</b>	B010001 (USA), B010002 (IC)	<b>Temp / Hum in</b>	22° C / 37%rh
<b>EUT Serial</b>	SPE28JY	<b>Temp / Hum out</b>	N/A
<b>EUT Config.</b>	802.11ac at VHT80 MCS0 / chain 0 & 1	<b>Line AC / Freq</b>	120 Vac / 60 Hz
<b>Standard</b>	CFR47 Part 15 Subpart E, RSS-247, RSS-GEN	<b>RBW / VBW</b>	120 kHz/ 300 kHz
<b>Dist/Ant Used</b>	3m / JB3	<b>Performed by</b>	Kerwinn Corpuz

30 MHz – 1 GHz Transmit at 5775 MHz

Frequency	Raw	Cable Loss	AF	Level	Detector	Polarity	Height	Azimuth	Limit	Margin
MHz	dBuV/m	dB	dB	dBuV/m		H/V	cm	deg	dBuV/m	dB
249.99	48.17	3.74	-20.07	31.84	QP	H	129	238	46.00	-14.16
38.09	47.73	2.64	-16.70	33.66	QP	V	115	220	40.00	-6.34
46.61	53.33	2.71	-22.24	33.81	QP	V	108	-8	40.00	-6.20
78.29	56.56	2.93	-24.34	35.15	QP	V	108	85	40.00	-4.85
144.35	44.77	3.29	-19.39	28.68	QP	V	111	164	43.50	-14.82
174.25	47.64	3.43	-20.55	30.52	QP	V	114	128	43.50	-12.98

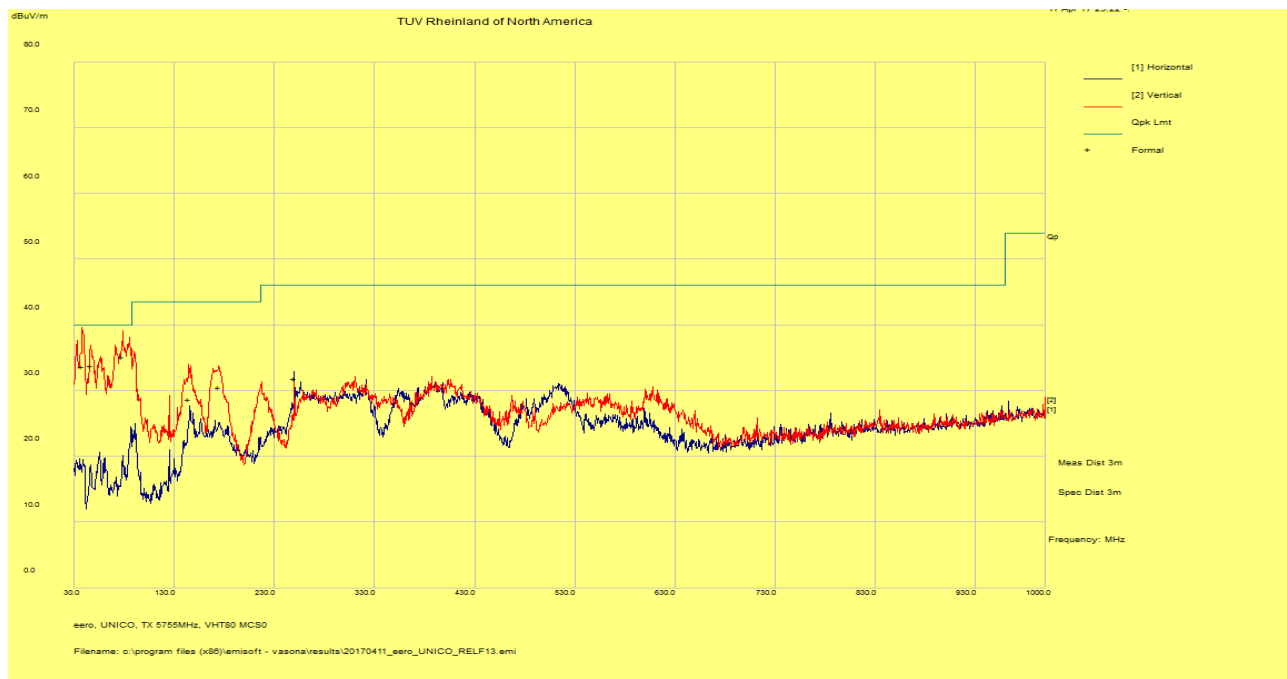

Spec Margin = E-Field QP - Limit, E-Field QP = FIM QP+ Total CF ± Uncertainty

Total CF= AF+ Cable Loss AF= Antenna factor + Preamp

Note: 1. Worst case was observed on VHT80 MCS0 mode.

2. No significant emission was observed below 30MHz.

3. To reduce complexity and bulkiness of the report Worst case Plots are placed in the report.



**SOP 1 Radiated Emissions**

Tracking # 31761402.001 Page 14 of 15

<b>EUT Name</b>	Wi-Fi Router	<b>Date</b>	Apr 12, 2017
<b>EUT Model</b>	B010001 (USA), B010002 (IC)	<b>Temp / Hum in</b>	22° C / 40%rh
<b>EUT Serial</b>	SPE28JY	<b>Temp / Hum out</b>	N/A
<b>EUT Config.</b>	802.11ac at VHT80 MCS0 / chain 0 & 1	<b>Line AC / Freq</b>	120 Vac / 60 Hz
<b>Standard</b>	CFR47 Part 15 Subpart E, RSS-247, RSS-GEN	<b>RBW / VBW</b>	1 MHz/ 3 MHz
<b>Dist/Ant Used</b>	3m – EMCO3115 / 1m – AHA-840	<b>Performed by</b>	Colton Aliff

1 – 18 GHz Transmit at 5775 MHz (Center Channel)

Frequency	Raw	Cable Loss	AF	Level	Detector	Polarity	Height	Azimuth	Limit	Margin
MHz	dBuV/m	dB	dB	dBuV/m		H/V	cm	deg	dBuV/m	dB
17978	39.72	3.77	-2.97	40.52	Average	H	127	148	54.00	-13.48
14436.28	39.98	3.28	-8.52	34.73	Average	H	190	112	54.00	-19.27

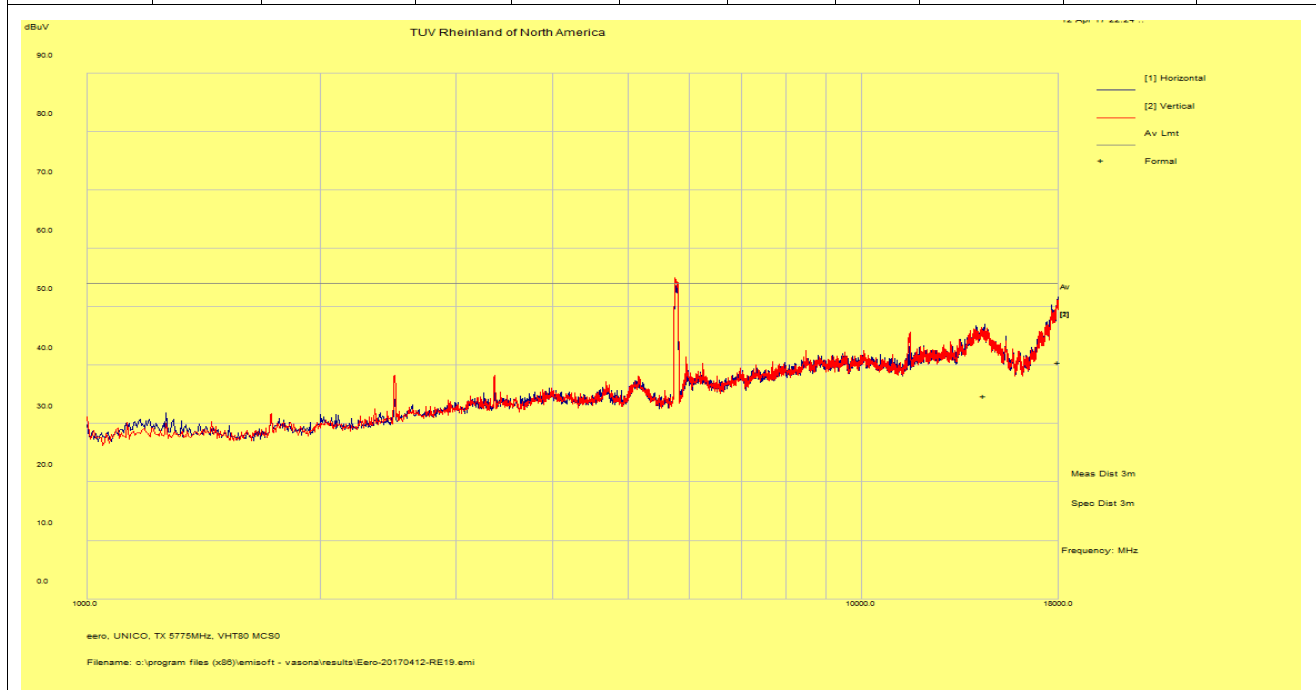

Spec Margin = E-Field AVG - Limit, E-Field AVG = FIM AVG+ Total CF ± Uncertainty

Total CF= AF+ Cable Loss AF= Antenna factor + Preamp

- Note: 1. Worst case was observed on VHT80 MCS0 mode.  
 2. To reduce complexity and bulkiness of the report Worst case Plots are placed in the report.  
 3. Emission above the limit is the fundamental.

<b>SOP 1 Radiated Emissions</b>		Tracking # 31761402.001 Page 15 of 15	
<b>EUT Name</b>	Wi-Fi Router	<b>Date</b>	Apr 13, 2017
<b>EUT Model</b>	B010001 (USA), B010002 (IC)	<b>Temp / Hum in</b>	22° C / 42%rh
<b>EUT Serial</b>	SPE28JY	<b>Temp / Hum out</b>	N/A
<b>EUT Config.</b>	802.11ac at VHT80 MCS0 / chain 0 & 1	<b>Line AC / Freq</b>	120 Vac / 60 Hz
<b>Standard</b>	CFR47 Part 15 Subpart E, RSS-247, RSS-GEN	<b>RBW / VBW</b>	1 MHz/ 3 MHz
<b>Dist/Ant Used</b>	3m – EMCO3115 / 1m – AHA-840	<b>Performed by</b>	Colton Aliff

18 – 40 GHz Transmit at 5775 MHz (Center Channel)

Frequency	Raw	Cable Loss	AF	Level	Detector	Polarity	Height	Azimuth	Limit	Margin
MHz	dBuV/m	dB	dB	dBuV/m		H/V	cm	deg	dBuV/m	dB
39911.82	50.38	10.91	-13.52	47.77	Peak	V	200	0	54.00	-6.23

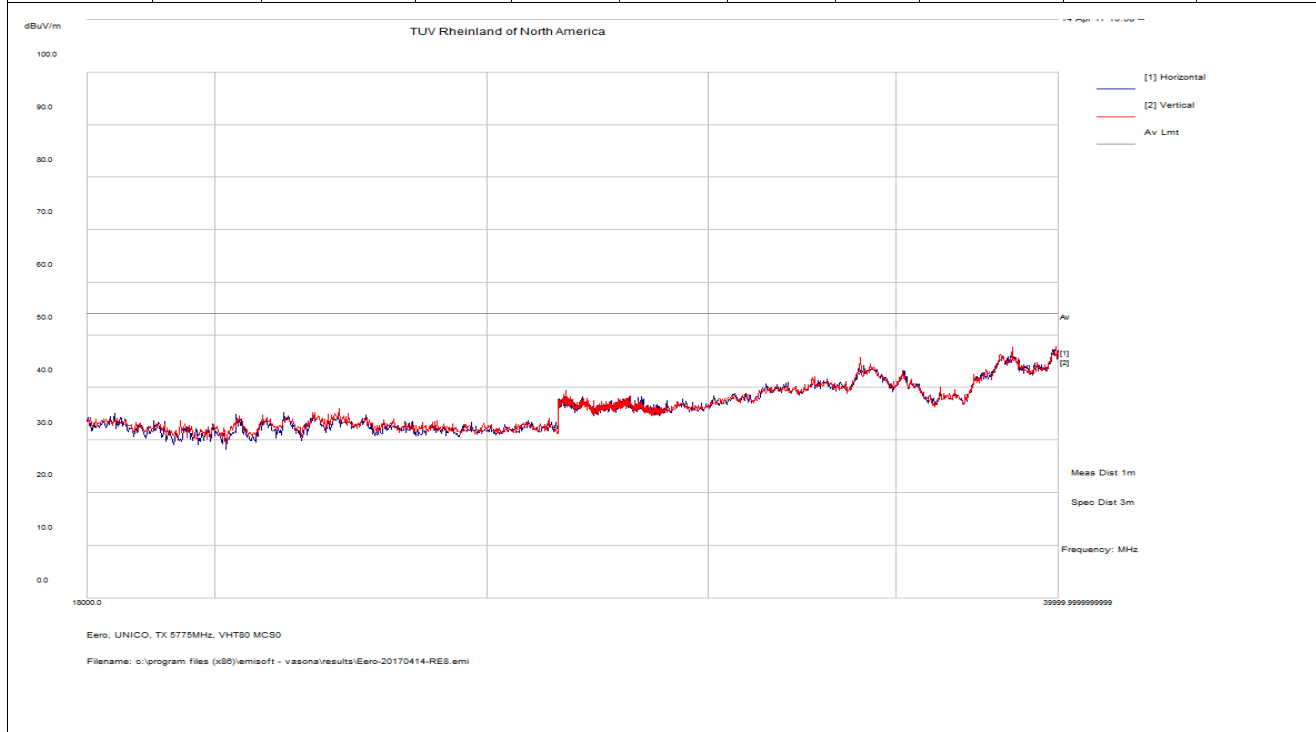

Spec Margin = E-Field AVG - Limit, E-Field AVG = FIM AVG+ Total CF ± Uncertainty  
 Total CF= AF+ Cable Loss AF= Antenna factor + Preamp  
 Note: 1. Worst case was observed on VHT80 MCS0 mode.  
 2. To reduce complexity and bulkiness of the report Worst case Plots are placed in the report.

## 4.6 AC Conducted Emissions

Testing was performed in accordance with ANSI C63.4: 2014. These test methods are listed under the laboratory's A2LA Scope of Accreditation.

This test measures the levels emanating from the EUT's AC input port, thus evaluating the potential for the EUT to cause radio frequency interference to other electronic devices.

The AC conducted emissions of equipment under test shall not exceed the values in CFR47 Part 15.207: 2016 and RSS GEN: 2014.

### 4.6.1 Test Methodology

A test program that controls instrumentation and data logging was used to automate the AC Power Line Conducted emission test procedure. The frequency range of interest was divided into sub-ranges such as to yield a frequency resolution of 9 kHz. Each phase and neutral of the AC power line were measured with respect to ground. Measurements were performed using a set of 50µH / 50Ω LISNs.

Testing is performed in Lab 5. The setup photographs clearly identify which site was used. The vertical ground plane used in the semi-anechoic chamber is a 2m x 2m solid aluminum frame and panel, and it is bonded to the horizontal ground plane.

In the case of tabletop equipment, the EUT is placed on a 1.0m x 1.5m non-conductive table 80cm above the ground plane and 40cm from a vertical ground reference plane. The rear of the EUT was positioned flush with the backside of the table and directly over the LISNs. The power and I/O cables were routed over the edge of the table and bundled approximately 40cm from the ground plane. Support equipment was powered from a separate LISN.

#### 4.6.1.1 Deviations

There were no deviations from this test methodology.

### 4.6.2 Test Results

As originally tested, the EUT was found to be compliant to the requirements of the test standard(s).

**Table 16:** AC Conducted Emissions – Test Results

<b>Test Conditions:</b> Conducted Measurement at Normal Conditions only		
<b>Antenna Type:</b> FPCB	<b>Power Level:</b> See Test Plan	
<b>AC Power:</b> 120 Vac/60 Hz	<b>Configuration:</b> Tabletop	
<b>Ambient Temperature:</b> 22° C	<b>Relative Humidity:</b> 41% RH	
<b>Configuration</b>	<b>Frequency Range</b>	<b>Test Result</b>
Line 1 (Hot)	0.15 to 30 MHz	Pass
Line 2 (Neutral)	0.15 to 30 MHz	Pass

SOP 2 Conducted Emissions						Tracking # 31761402.001 Page 1 of 4			
<b>EUT Name</b>		Wi-Fi Router				<b>Date</b>		Apr 14, 2017	
<b>EUT Model</b>		B010001 (USA), B010002 (IC)				<b>Temp / Hum in</b>		22° C / 41% rh	
<b>EUT Serial</b>		SPE28JY				<b>Temp / Hum out</b>		N/A	
<b>EUT Config.</b>		TX mode / chain 0 & 1				<b>Line AC / Freq</b>		120Vac / 60Hz	
<b>Standard</b>		CFR47 Part 15.207 and RSS Gen				<b>RBW / VBW</b>		9 kHz / 30 kHz	
<b>Lab/LISN</b>		Lab #5 /Com-Power, Line 1				<b>Performed by</b>		Colton Aliff	
Frequency	Raw	Limiters	Ins. Loss	Level	Detector	Line	Limit	Margin	Result
MHz	dBuV	dB	dB	dBuV		Line	dBuV	dB	
1.253	32.05	9.87	0.03	41.95	QP	Live	56.00	-14.05	Pass
1.253	20.67	9.87	0.03	30.57	Ave	Live	46.00	-15.43	Pass
1.631	29.53	9.88	0.03	39.44	QP	Live	56.00	-16.56	Pass
1.631	18.83	9.88	0.03	28.74	Ave	Live	46.00	-17.26	Pass
2.947	32.48	9.90	0.03	42.41	QP	Live	56.00	-13.59	Pass
2.947	22.90	9.90	0.03	32.83	Ave	Live	46.00	-13.17	Pass
3.238	32.02	9.90	0.03	41.95	QP	Live	56.00	-14.05	Pass
3.238	22.40	9.90	0.03	32.33	Ave	Live	46.00	-13.67	Pass
3.627	29.83	9.91	0.03	39.77	QP	Live	56.00	-16.23	Pass
3.627	19.69	9.91	0.03	29.63	Ave	Live	46.00	-16.37	Pass
6.839	32.07	9.94	0.03	42.04	QP	Live	60.00	-17.96	Pass
6.839	22.42	9.94	0.03	32.39	Ave	Live	50.00	-17.61	Pass
Spec Margin = QP./Ave. - Limit, ± Uncertainty									
Combined Standard Uncertainty $u_c(y) = \pm 1.2$ dB Expanded Uncertainty $U = k u_c(y)$ $k = 2$ for 95% confidence									
Notes: The EUT was set horizontally on the table top and transmitted at 5180 MHz in 802.11a at 6Mbps									

**SOP 2** Conducted Emissions

Tracking # 31761402.001 Page 2 of 4

<b>EUT Name</b>	Wi-Fi Router	<b>Date</b>	Apr 14, 2017
<b>EUT Model</b>	B010001 (USA), B010002 (IC)	<b>Temp / Hum in</b>	22° C / 41% rh
<b>EUT Serial</b>	SPE28JY	<b>Temp / Hum out</b>	N/A
<b>EUT Config.</b>	TX mode / chain 0 & 1	<b>Line AC</b>	120Vac / 60Hz
<b>Standard</b>	CFR47 Part 15.207 and RSS Gen	<b>RBW / VBW</b>	9 kHz / 30 kHz
<b>Lab/LISN</b>	Lab #5 /Com-Power, Line 1	<b>Performed by</b>	Colton Aliff

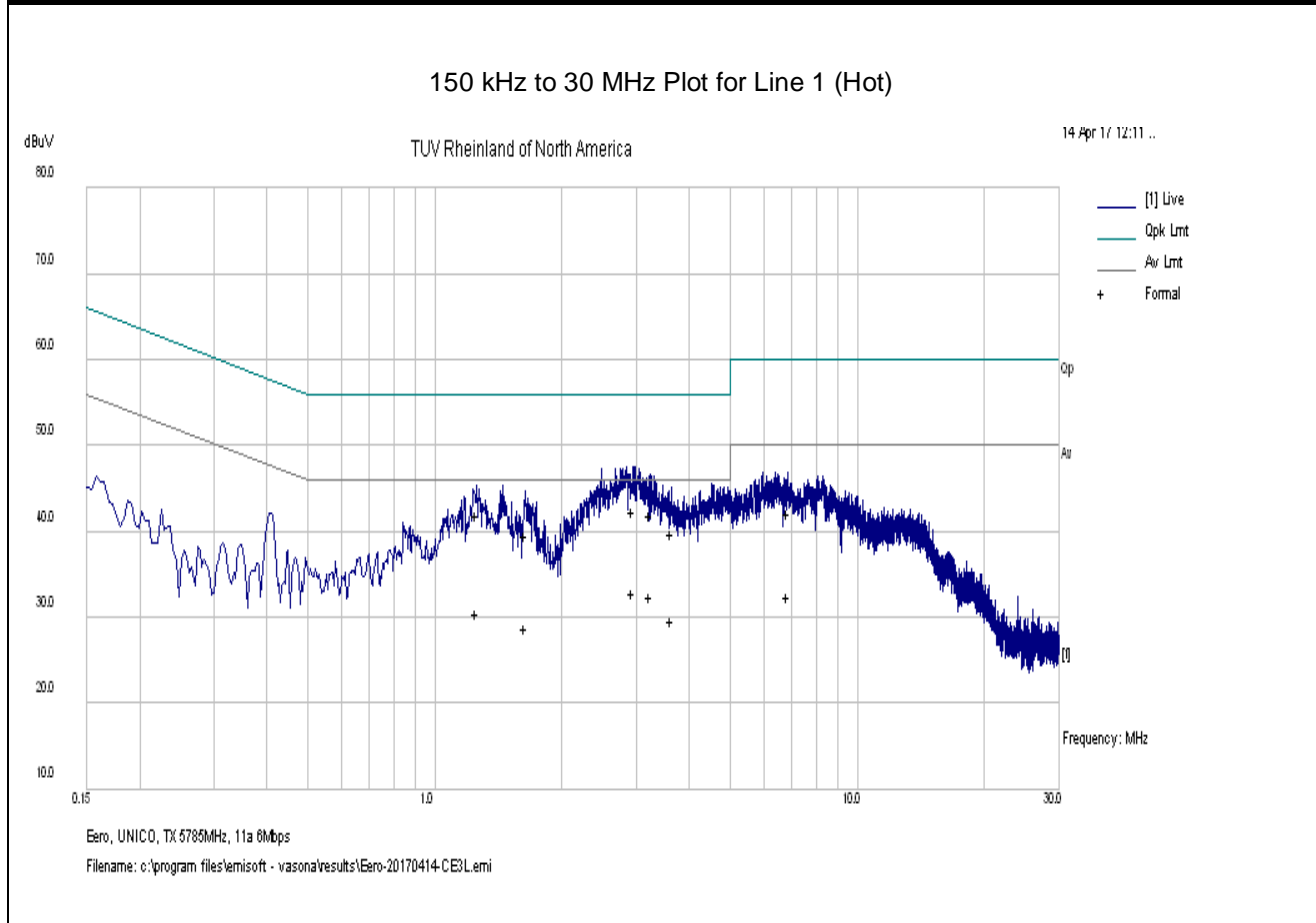

Note: Met FCC Class B limit.

SOP 2 Conducted Emissions						Tracking # 31761402.001 Page 3 of 4			
<b>EUT Name</b>		Wi-Fi Router				<b>Date</b>		Apr 14, 2017	
<b>EUT Model</b>		B010001 (USA), B010002 (IC)				<b>Temp / Hum in</b>		22° C / 41% rh	
<b>EUT Serial</b>		SPE28JY				<b>Temp / Hum out</b>		N/A	
<b>EUT Config.</b>		TX mode / chain 0 & 1				<b>Line AC / Freq</b>		120Vac / 60Hz	
<b>Standard</b>		CFR47 Part 15.207 and RSS Gen				<b>RBW / VBW</b>		9 kHz / 30 kHz	
<b>Lab/LISN</b>		Lab #5 /Com-Power, Line 2				<b>Performed by</b>		Colton Aliff	
Frequency	Raw	Limiters	Ins. Loss	Level	Detector	Line	Limit	Margin	Result
MHz	dBuV	dB	dB	dBuV		Line	dBuV	dB	
1.496	29.11	9.88	0.03	39.01	QP	Neutral	56.00	-16.99	Pass
1.496	19.58	9.88	0.03	29.49	Ave	Neutral	46.00	-16.51	Pass
1.664	30.05	9.88	0.03	39.96	QP	Neutral	56.00	-16.04	Pass
1.664	21.08	9.88	0.03	30.98	Ave	Neutral	46.00	-15.02	Pass
2.371	31.21	9.89	0.03	41.12	QP	Neutral	56.00	-14.88	Pass
2.371	21.38	9.89	0.03	31.30	Ave	Neutral	46.00	-14.70	Pass
2.801	33.43	9.90	0.03	43.36	QP	Neutral	56.00	-12.64	Pass
2.801	22.16	9.90	0.03	32.08	Ave	Neutral	46.00	-13.92	Pass
3.242	32.19	9.90	0.03	42.12	QP	Neutral	56.00	-13.88	Pass
3.242	21.37	9.90	0.03	31.30	Ave	Neutral	46.00	-14.70	Pass
4.827	31.00	9.92	0.03	40.95	QP	Neutral	56.00	-15.05	Pass
4.827	20.12	9.92	0.03	30.07	Ave	Neutral	46.00	-15.93	Pass
Spec Margin = QP./Ave. - Limit, ± Uncertainty									
Combined Standard Uncertainty $u_c(y) = \pm 1.2$ dB Expanded Uncertainty $U = k u_c(y)$ $k = 2$ for 95% confidence									
Notes: The EUT was set horizontally on the table top and transmitted at 5180 MHz in 802.11a at 6Mbps									

**SOP 2** Conducted Emissions

Tracking # 31761402.001 Page 4 of 4

<b>EUT Name</b>	Wi-Fi Router	<b>Date</b>	Apr 14, 2017
<b>EUT Model</b>	B010001 (USA), B010002 (IC)	<b>Temp / Hum in</b>	22° C / 41% rh
<b>EUT Serial</b>	SPE28JY	<b>Temp / Hum out</b>	N/A
<b>EUT Config.</b>	TX mode / chain 0 & 1	<b>Line AC</b>	120Vac / 60Hz
<b>Standard</b>	CFR47 Part 15.207 and RSS Gen	<b>RBW / VBW</b>	9 kHz / 30 kHz
<b>Lab/LISN</b>	Lab #5 /Com-Power, Line 2	<b>Performed by</b>	Colton Aliff

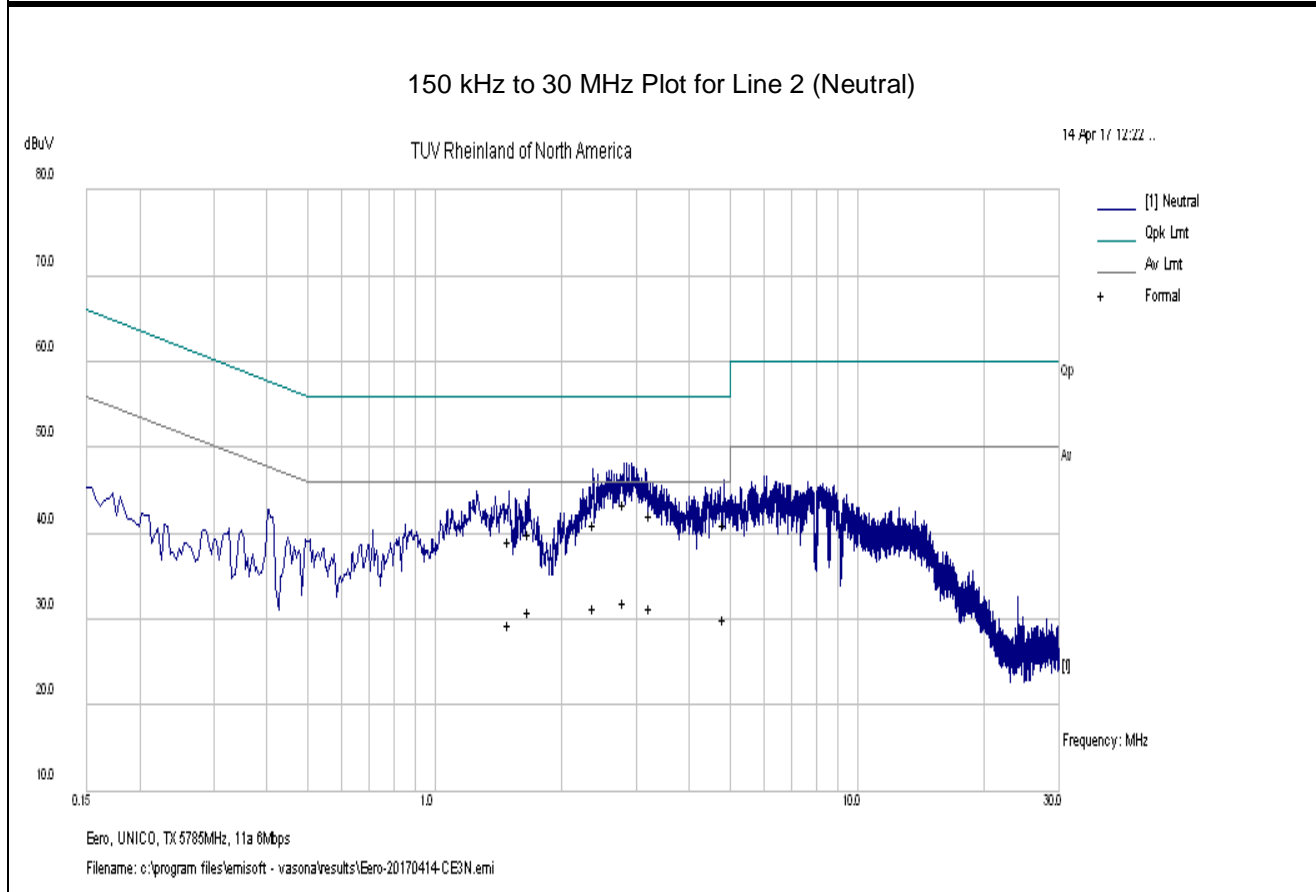

Note: Met FCC Class B Limit.

---

## **4.7 Frequency Stability**

In accordance with 47 CFR Part 15.407(g) the frequency stability of U-NII devices must be such that an emission is maintained within the band of operation under all conditions of normal operation as specified in the user's manual. The Manufacturer calls out operating temperature ranges of +0° to +35° C

### **4.7.1 Test Methodology**

The manufacturer of the equipment is responsible for ensuring that the frequency stability is such that emissions are always maintained within the band of operation under all conditions. This test performs according to ANSI C63.10-2013 Section 6.8

### **4.7.2 Manufacturer Declaration**

The frequency stability of the reference oscillator sets the frequency stability of the RF transceiver signals. Therefore all of the RF signal should have  $\pm 20$  ppm stability.

This stability accounts for room temp tolerance of the crystal oscillator circuit, frequency variation across temperature, and crystal ageing.

Worst case:

5.180 GHz-  $\pm 20$  ppm/104 kHz

$\pm 20$  ppm at 5.18 GHz translates to a maximum frequency shift of  $\pm 104$  kHz. As the edge of the channels are at least one MHz from either of the band edges,  $\pm 103$  kHz is more than sufficient to guarantee that the intentional emission will remain in the band over the entire operating range of the radio.



### 4.7.3 Limit

CFR47 Part 407(g) - Manufacturers of U-NII devices are responsible for ensuring frequency stability such that an emission is maintained within the band of operation under all conditions of normal operation as specified in the user's manual.

### 4.7.4 Test results:

As originally tested, the EUT was found to be compliant to the requirements of the test standard(s) since the maximum frequency drift was 9.92 ppm.

The frequency stability was evaluated at 5.180 GHz since the radio chip operates in all 5 GHz bands.

**Table 17:** Frequency Stability – Test Results

Temperature	Time	PPM
0° C	Start	8.41
	2 Min.	9.92
	5 Min	9.42
	10 min	9.06
10° C	Start	9.06
	2 Min.	8.70
	5 Min	7.62
	10 min	7.62
20° C	Start	7.25
	2 Min.	6.17
	5 Min	5.80
	10 min	5.08
30° C	Start	0.73
	2 Min.	0.38
	5 Min	0.38
	10 min	2.18
40° C	Start	1.81
	2 Min.	0.01
	5 Min	-0.35
	10 min	-0.45
50° C	Start	-1.19
	2 Min.	0.63
	5 Min	0.26
	10 min	0.26

**Note:** All frequency drifts were less than  $\pm 20$  ppm. The worst frequency drift was 9.92 ppm

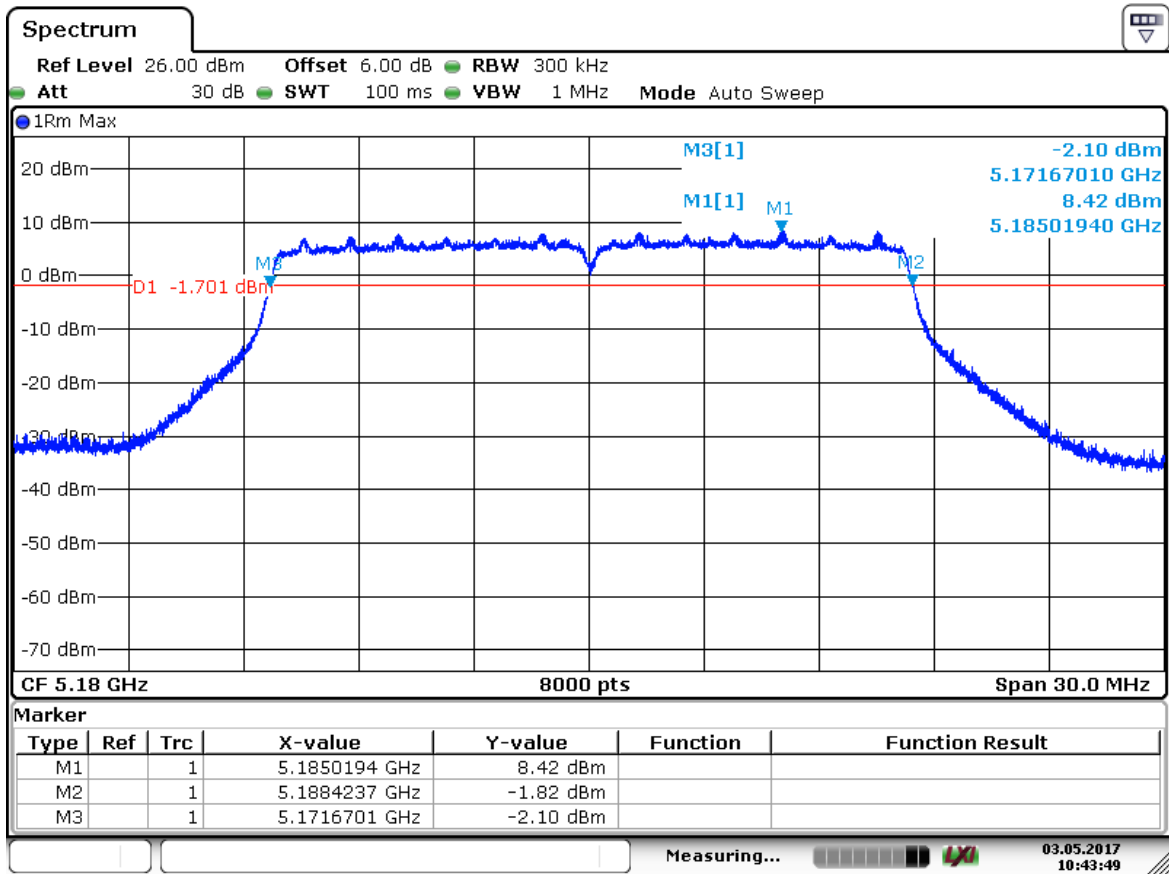

Date: 3 MAY 2017 10:43:49

**Figure 96:** Frequency Stability – Worst Case

## 4.8 Voltage Variation

In accordance with 47 CFR Part 15.31 (e) intentional radiators, measurements of the variation of the input power or the radiated signal level of the fundamental frequency component of the emission, as appropriate, shall be performed with the supply voltage varied between 85% and 115% of the nominal rated supply voltage. For battery operated equipment, the equipment tests shall be performed using a new battery.

### 4.8.1 Test Methodology

The ac supply voltage was varied between 85% and 115% of the nominal rated supply voltage. The fundamental frequency was observed during the variation. The access point was powered 120 Vac / 60 Hz by programmable power supply. The voltage was varied from 102 Vac to 138 Vac mean while the fundamental frequencies were observed and record for the maximum drift in ppm; part per millions.

### 4.8.2 Test results

As originally tested, the EUT was found to be compliant to the requirements of the test standard(s). The fundamental frequencies drifted less than  $\pm 20$  ppm.

The frequency stability was evaluated at 5.180 GHz since the radio chip operates in all 5 GHz bands.

**Table 18:** Voltage Variation – Test Results

Frequency MHz	Nominal (120Vac) MHz	Lo Voltage (102Vac) MHz	Hi Voltage (138Vac) MHz	Max Drift ppm
5180	4.31	4.31	-2.87	4.31

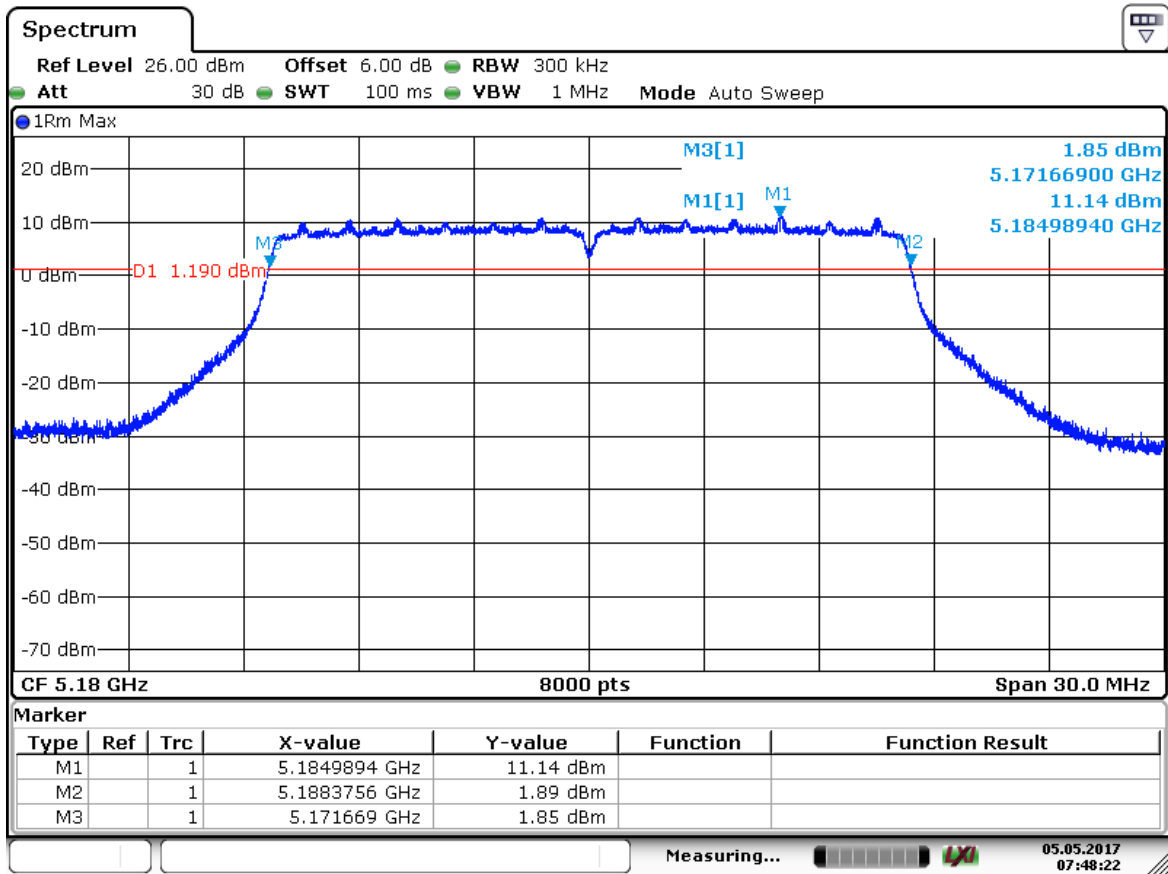

Date: 5 MAY 2017 07:48:22

**Figure 97:** Voltage Variation – Worst Case

## 4.9 Maximum Permissible Exposure

### 4.9.1 Test Methodology

In this document, we try to prove the safety of radiation harmfulness to the human body for our product. The limit for Maximum Permissible Exposure (MPE) specified in FCC 1.1310 is followed. The Gain of the antenna used in this calculation is declared by the manufacturer, and the maximum total power input to the antenna is measured. Through the Friis transmission formula and the maximum gain of the antenna, we can calculate the distance, away from the product, where the limit of MPE is reached.

Although the Friis transmission formula is a far field assumption, the calculated result of that is an over-prediction for near field power density. We will take that as the worst case to specify the safety range.

### 4.9.2 RF Exposure Limit

According to FCC 1.1310 table 1: The criteria listed in the following table shall be used to evaluate the environmental impact of human exposure to radio-frequency (RF) radiation as specified in 1.1307(b)

#### LIMITS FOR MAXIMUM PERMISSIBLE EXPOSURE (MPE)

Frequency Range (MHz)	Electric Field Strength (V/m)	Magnetic Field Strength (A/m)	Power Density (mW/cm <sup>2</sup> )	Average Time (minutes)
<b>(A)Limits For Occupational / Control Exposures</b>				
0.3–3.0	614	1.63	*(100)	6
3.0–30	1842/f	4.89/f	*(900/f <sup>2</sup> )	6
30–300	...	...	1.0	6
300 - 1500	...	...	f/300	6
1500 - 100,000	...	...	5	6
<b>(B)Limits For General Population / Uncontrolled Exposure</b>				
0.3–1.34	614	1.63	*(100)	30
1.34-30	824/f	2.19/f	*(180/ f <sup>2</sup> )	30
30–300	27.5	0.037	0.2	30
300 - 1500	...	...	f/1500	30
1500 - 100,000	...	...	1.0	30

F = Frequency in MHz

\* = Plane-wave equivalent power density

### 4.9.3 EUT Operating Condition

The software provided by Manufacturer enabled the EUT to transmit data at lowest, middle and highest channel individually.

### 4.9.4 Classification

The antenna of the product, under normal use condition, is at least 20cm away from the body of the user. Warning statement to the user for keeping at least 20cm or more separation distance with the antenna should be included in user's manual. So, this device is classified as a **Mobile Device**.

See below calculation for 5.8 GHz, worse case, RF Exposure at a distance of 20cm.

### 4.9.5 Test Results

#### 4.9.5.1 Antenna Gain

The 5.8 GHz transmitting beam forming antenna gain is +6.58 dBi or 4.55 (numeric).

#### 4.9.5.2 Output Power into Antenna & RF Exposure value at distance 20cm:

Calculations for this report are based on highest power measurement.

Limit for MPE (from FCC part 1.1310 table1) is 1.0 mW/cm<sup>2</sup>

The highest measured total power is +29.24 dBm or 839.46 mW (summed 2 chains)

Using the Friss transmission formula, the EIRP is Pout\*G, and R is 20cm.

$P_d = (839.46 * 4.55) / (1600\pi) = 0.7599 \text{ mW/cm}^2$ , which is 0.2401 mW/cm<sup>2</sup> below to the limit.

As originally tested, the EUT was found to be compliant to the requirements of the test standard(s).

### 4.9.6 Sample Calculation

The Friss transmission formula:  $P_d = (P_{out} * G) / (4 * \pi * R^2)$

Where;

Pd = power density in mW/cm<sup>2</sup>

Pout = output power to antenna in mW

G = gain of antenna in linear scale

$\pi \approx 3.1416$

R = distance between observation point and center of the radiator

in cm

Ref. : David K. Cheng, *Field and Wave Electromagnetics*, Second Edition, Page 640, Eq. (11-133).

## 5 Test Equipment List

### 5.1 Equipment List

Equipment	Manufacturer	Model #	Serial/Inst #	Last Cal mm/dd/yyyy	Next Cal mm/dd/yyyy
Bilog Antenna	Sunol Sciences	JB3	A102606	06/15/2016	06/15/2018
Horn Antenna	Sunol Sciences	3115	9710-5301	10/08/2015	10/08/2017
Antenna (18-40 GHz)	Com-Power	AHA-840	105005	07/08/2015	07/08/2017
Loop Antenna	EMCO	6502	9110-2683	06/13/2016	06/13/2017
Spectrum Analyzer	Rohde & Schwarz	FSL6	100169	01/13/2017	01/13/2018
Spectrum Analyzer	Agilent	N9038A	MY552260210	01/16/2017	01/16/2018
Spectrum Analyzer	Agilent	N9030A	MY52350885	05/17/2016	05/17/2017
Spectrum Analyzer	Rohde Schwarz	ESIB40	832427/002	01/16/2017	01/16/2018
Spectrum Analyzer	Rohde Schwarz	FSV40	1321.3008K40	08/30/2016	08/30/2017
Amplifier	Sonoma Instruments	310	165516	01/19/2017	01/19/2018
Amplifier	Miteq	TTA1800-30-HG	2020728	11/12/2016	11/12/2017
Amplifier	Rohde & Schwarz	TS-PR26	100011	11/04/2017	11/04/2018
Amplifier	Rohde & Schwarz	TS-PR40	100012	08/02/2017	08/02/2017
Power Meter	Agilent	E4418B	MY45103902	01/11/2017	01/11/2018
Power Sensor	Hewlett Packard	8482A	1925A04647	01/01/2017	01/01/2018
Thermometer	Fluke	52II	88650033	11/04/2016	11/04/2017
Thermo Chamber	Espec	BTZ-133	0613436	NCR	NCR
Multimeter	Fluke	177	92780312	01/11/2017	01/11/2018
DC Power Supply	Agilent	E3634A	MY400004331	01/12/2017	01/12/2018
Notch Filter	Micro-Tronics	BRM50702	037	07/18/2016	07/18/2017
Signal Generator	Anritsu	MG3694A	42803	01/13/2017	01/13/2018
Signal Generator	Rohde & Schwarz	SMF100A	1167.0000K02	09/06/2016	09/06/2017
Signal Generator	Rohde & Schwarz	SMBV100A	1407.6004K02	09/06/2016	09/06/2017
Power Sensors	Rohde & Schwarz	OSP120	1520.9010.02	09/06/2016	09/06/2017

\* Calibration of equipment past due for re-calibration will be performed expeditiously. If any equipment is found to be out of tolerance at that time, affected customers will be notified accordingly.

## 6 EMC Test Plan

### 6.1 Introduction

This section provides a description of the Equipment Under Test (EUT), configurations, operating conditions, and performance acceptance criteria. It is an overview of information provided by the manufacturer so that the test laboratory may perform the requested testing.

### 6.2 Customer

**Table 19:** Customer Information

<b>Company Name</b>	eero inc
<b>Address</b>	500 Howard Street, Suite 900
<b>City, State, Zip</b>	San Francisco, CA 94105
<b>Country</b>	USA
<b>Phone</b>	(415) 738-7972
<b>Fax</b>	

**Table 20:** Technical Contact Information

<b>Name</b>	Clifford Clarke
<b>E-mail</b>	cliff@eero.com
<b>Phone</b>	(415) 738-7972
<b>Fax</b>	



### 6.3 Equipment Under Test (EUT)

**Table 21:** EUT Specifications

<b>EUT Specifications</b>	
Dimensions	W: 4.75in (121mm) x D: 4.75in (121mm) x H: 0.85-1.26in (22-33mm)
AC Input	100-240V AC, 50 – 60 Hz
Environment	Indoor
Operating Temperature Range:	0 to 35 degrees C
Multiple Feeds:	<input type="checkbox"/> Yes and how many <input checked="" type="checkbox"/> No
Product Marketing Name (PMN)	B010001 (USA), B010002 (IC)
Hardware Version Identification Number (HVIN)	B010001 (USA), B010002 (IC)
Firmware Version Identification Number (FVIN)	3.0.0
802.11-radio modules	
Operating Mode	802.11a, 802.11n (HT20, HT40), 802.11ac (VHT20, VHT40, VHT80)
Transmitter Frequency Band	5.725 GHz – 5.850 GHz, U-NII-3 band
Max. Rated Power Output	See Channel Planning Table.
Power Setting @ Operating Channel	See Channel Planning Table.
Antenna Type	Qty 7 – 2 custom antennas at 5.725-5.85GHz. See Table 22 for details
Antenna Gain	Antenna 5 = +3.84 dBi, Antenna 6 = +3.29 dBi
Modulation Type	<input type="checkbox"/> AM <input type="checkbox"/> FM <input checked="" type="checkbox"/> DTS <input checked="" type="checkbox"/> OFDM <input type="checkbox"/> Other describe: 16QAM and 64 QAM
Data Rate	802.11a: 2 Spatial Streams: 6, 9, 12, 18, 24, 36, 48, 54 Mbps 802.11n/ac HT20/VHT20: 2 Spatial Streams: 13, 26, 39, 52, 78, 104, 117, 130 /156 Mbps (LGI) 802.11n/ac HT40/VHT40: 2 Spatial Streams: 27, 54, 81, 108, 162, 216, 243, 270 / 324, 370 Mbps (LGI) 802.11ac VHT 80: 2 Spatial Streams: 58.5, 117, 175.5, 234, 351, 468, 526.5, 585, 702, 780 Mbps (LGI)
TX/RX Chain (s)	MIMO (2x2)

<b>EUT Specifications</b>	
Directional Gain Type	<input type="checkbox"/> Correlated <input checked="" type="checkbox"/> Beam-Forming <input type="checkbox"/> Other describe:
Type of Equipment	<input checked="" type="checkbox"/> Table Top <input checked="" type="checkbox"/> Wall-mount <input type="checkbox"/> Floor standing cabinet <input type="checkbox"/> Other:
<b>Note:</b> All 2 chains will be on / transmitted at all time.	

**Table 22:** Antenna Information

Number	Antenna Type	Description	Max Gain (dBi)
Antenna 1	Flex PCB	5 GHz Wi-Fi U-NII-1 Band, Chain 0	3.01
Antenna 1	Flex PCB	5 GHz Wi-Fi U-NII-2A Band, Chain 0	2.52
Antenna 2	Flex PCB	Bluetooth LE and Thread (Zigbee)	3.09
Antenna 3	Flex PCB	5 GHz Wi-Fi U-NII-1 Band, Chain 1	4.58
Antenna 3	Flex PCB	5 GHz Wi-Fi U-NII-2A Band, Chain 1	4.37
Antenna 4	Flex PCB	2.4 GHz Wi-Fi Chain 0	3.84
Antenna 5	Flex PCB	5 GHz Wi-Fi U-NII-2C Band, Chain 0	4.46
Antenna 5	Flex PCB	5 GHz Wi-Fi U-NII-3 Band, Chain 0	3.84
Antenna 6	Flex PCB	5 GHz Wi-Fi U-NII-2C Band, Chain 1	3.34
Antenna 6	Flex PCB	5 GHz Wi-Fi U-NII-3 Band, Chain 1	3.29
Antenna 7	Flex PCB	2.4 GHz Wi-Fi Chain 1	5.43

**Table 23: EUT Channel Power Specifications**

**Total Power for Non-Beamforming Mode**

No.	Frequency (MHz)	Target Power Value dBm					
		802.11a	802.11n HT20	802.11n HT40	802.11ac VHT40	802.11ac VHT80	
149	5745	22.69**	23.27***				
151	5755			22.12*	22.23*		
153	5765	27.31*****	27.29*****				
155	5775					22.15**	
157	5785	29.24*****	29.22*****				
159	5795			23.51***	24.36****		
161	5805	27.96*****	27.89*****				
165	5825	23.90*****	23.82*****				

**Note:** 1. The adjusted power target values are updated at the evaluated frequencies.  
 2. TP setting: \* = 19, \*\* = 19.5, \*\*\* = 20, \*\*\*\* = 21, \*\*\*\*\* = 21.5, \*\*\*\*\* = 24, \*\*\*\*\* = 25, \*\*\*\*\* = 26.

**Total Power for Beamforming Mode**

No.	Frequency (MHz)	Target Power Value dBm					
		802.11a	802.11n HT20	802.11n HT40	802.11ac VHT40	802.11ac VHT80	
149	5745	22.69**	23.27***				
151	5755			22.12*	22.23*		
153	5765	27.31*****	27.29*****				
155	5775					22.15**	
157	5785	29.24*****	29.22*****				
159	5795			23.51***	24.36****		
161	5805	27.96*****	27.89*****				
165	5825	23.90*****	23.82*****				

**Note:** 1. The adjusted power target values are updated at the evaluated frequencies.  
 2. TP setting: \* = 19, \*\* = 19.5, \*\*\* = 20, \*\*\*\* = 21, \*\*\*\*\* = 21.5, \*\*\*\*\* = 24, \*\*\*\*\* = 25, \*\*\*\*\* = 26.

**Table 24:** Interface Specifications

Interface Type	Cabled with what type of cable?	Is the cable shielded?	Maximum potential length of the cable?	Metallic (M), Coax (C), Fiber (F), or Not Applicable?
Ethernet	RJ45	<input checked="" type="checkbox"/> No	<input checked="" type="checkbox"/> Metric: 2 m	<input type="checkbox"/> N/A

**Table 25:** Supported Equipment

Equipment	Manufacturer	Model	Serial	Used for
Laptop	Dell	Latitude	35521341769	Setup EUT operating channel
<b>Note:</b> None.				

**Table 26:** Description of Sample used for Testing

Device	Serial	RF Connection	CFR47 Part 15.407
Wi-Fi Router	SPE28JY	FPCBAntenna	TX Emission, AC Conducted Emission
		Direct Connection	Peak Transmit Power, Peak Power Spectral Density, Occupied Bandwidth Band-Edge Out-of-Band Emission
<b>Note:</b> Chicony PSU S/N: F719-0354-25CT-KJ8T, FoxLink PSU S/N: XF70113M120094			

**Table 27:** Description of Test Configuration used for Radiated Measurement.

Device	Antenna	Mode	Setup Photo (X-Axis)	Setup Photo (Y-Axis)	Setup Photo (Z-Axis)
Wi-Fi Router	FPCB	Transmit	EUT laid flat	N/A	N/A
<b>Note:</b> N/A.					

---

## 6.4 Test Specifications

Testing requirements

**Table 28:** Test Specifications

<b>Emissions and Immunity</b>	
<b>Standard</b>	<b>Requirement</b>
CFR 47 Part 15.407: 2016	All
RSS 247 Issue 2, 2017	All

**END OF REPORT**