

3.4.8 Data Traffic Channel Loading and Noise Floor Plots

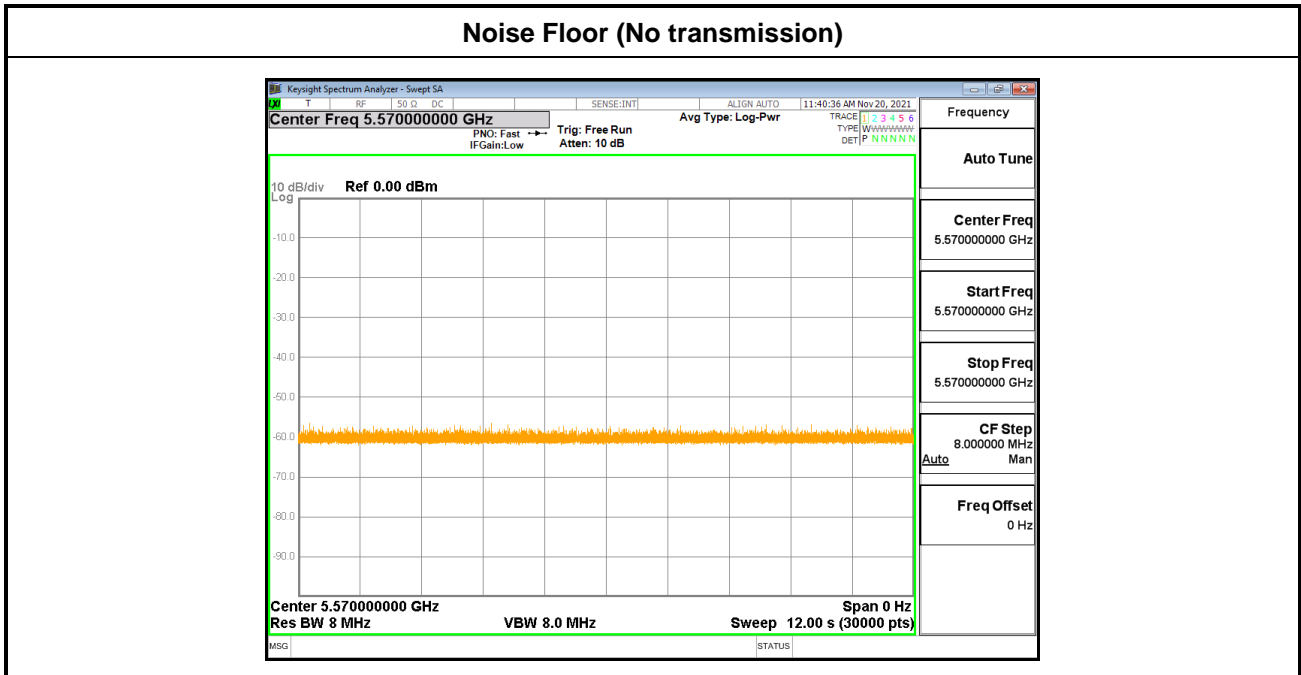

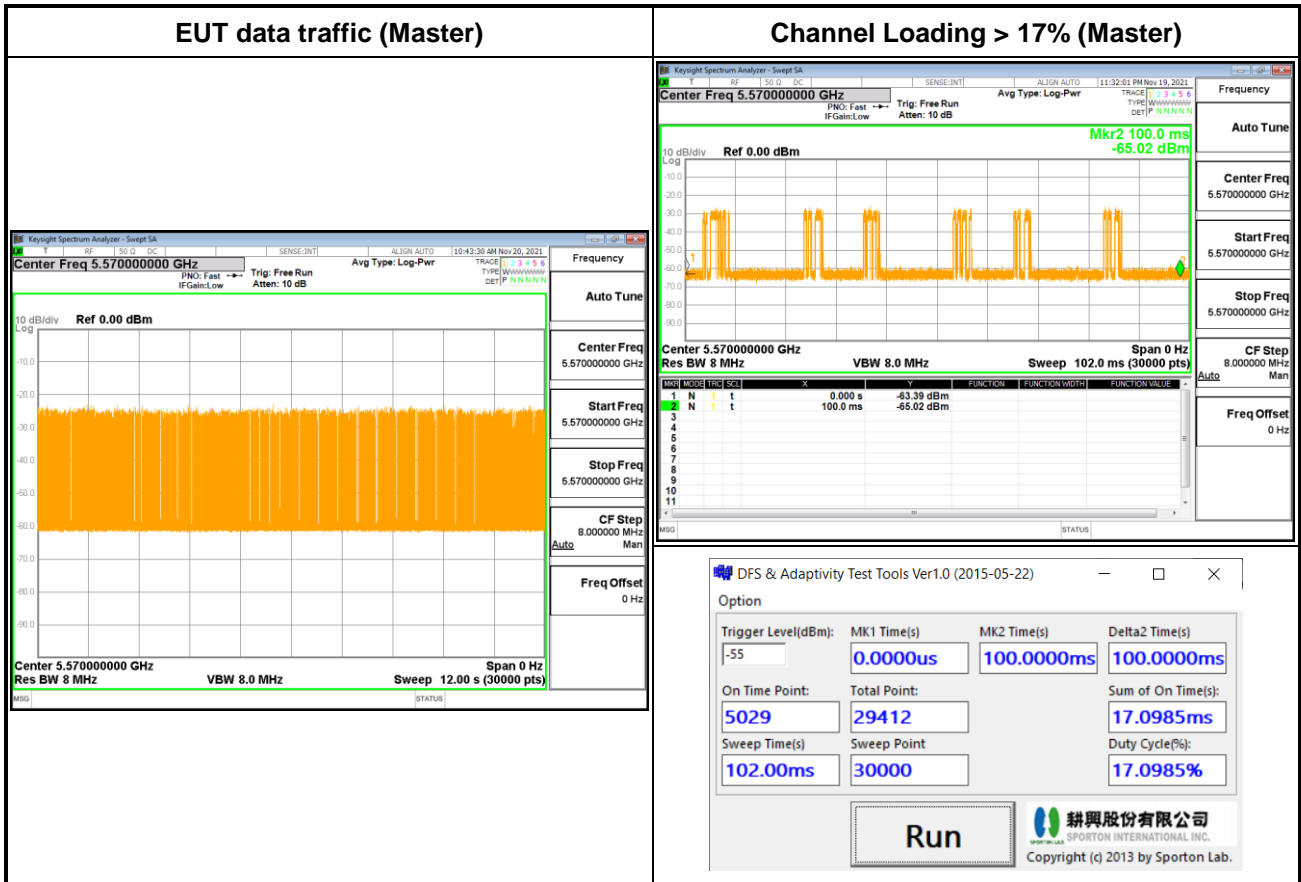

3.5 Statistical Performance Check

3.5.1 Limit of Statistical Performance Check

Short Pulse Radar Test

Once the performance requirements check is complete, statistical data will be gathered, to determine the ability of the device to detect the radar test waveforms (Short Pulse Radar Types 1-4) found in **Table 5**. The device can utilize a test mode to demonstrate when detection occurs to prevent the need to reset the device between trials. The percentage of successful detection is calculated by:

$$\frac{\text{TotalWaveformDetections}}{\text{TotalWaveformTrials}} \times 100 = \text{Percentage of Successful Detection Radar Waveform } N = P_d N$$

In addition an aggregate minimum percentage of successful detection across all Short Pulse Radar Types 1-4 is required and is calculated as follows:

$$\frac{P_d 1 + P_d 2 + P_d 3 + P_d 4}{4}$$

The minimum number of trails, minimum percentage of successful detection and the aggregate minimum percentage of successful detection are found in **Table 5**.

Table 5 – Short Pulse Radar Test Waveforms

Radar Type	Pulse Width (µsec)	PRI (µsec)	Number of Pulses	Minimum Percentage of Successful Detection	Minimum Number of Trials
1	1	1428	18	60%	30
2	1-5	150-230	23-29	60%	30
3	6-10	200-500	16-18	60%	30
4	11-20	200-500	12-16	60%	30
Aggregate (Radar Types 1-4)				80%	120



A minimum of 30 unique waveforms are required for each of the Short Pulse Radar Types 1 through 4. For Short Pulse Radar Type 0, the same waveform is used a minimum of 30 times. If more than 30 waveforms are used for Short Pulse Radar Types 1 through 4, then each additional waveform must also be unique and not repeated from the previous waveforms.

The table below is an example demonstrating how to calculate the detection rate of each radar type and the aggregated detection rate.

Radar Type	Number of Trials	Number of Successful Detections	Minimum Percentage of Successful Detection
1	30	27	90%
2	30	18	60%
3	30	27	90%
4	30	30	100%
Aggregate $(90\% + 60\% + 90\% + 100\%)/4 = 85\%$			



Long Pulse Radar Test

Statistical data will be gathered to determine the ability of the device to detect the Long Pulse Radar Type 5 found in **Table 6**. The device can utilize a test mode to demonstrate when detection occurs to prevent the need to reset the device between trials.

Table 6 – Long Pulse Radar Test Waveform

Radar Type	Pulse Width (μsec)	Chirp Width (MHz)	PRI (μsec)	Number of Pulses per Burst	Number of Bursts	Minimum Percentage of Successful Detection	Minimum Number of Trials
5	50-100	5-20	1000-2000	1-3	8-20	80%	30

The parameters for this waveform are randomly chosen. Thirty unique waveforms are required for the Long Pulse Radar Type waveforms. If more than 30 waveforms are used for the Long Pulse Radar Type waveforms, then each additional waveform must also be unique and not repeated from the previous waveforms.

Three subsets of trials will be performed with a minimum of ten trials per subset.

The subset of trials differs in where the Long Pulse Type 5 Signal is tuned in frequency:

- a) The Channel center frequency (subset case 1).
- b) Tuned frequencies such that 90% of the Long Pulse Type 5 frequency modulation is within the low edge of the UUT Occupied Bandwidth (subset case 2).
- c) Tuned frequencies such that 90% of the Long Pulse Type 5 frequency modulation is within the high edge of the UUT Occupied Bandwidth (subset case 3).

For subset case 1: the center frequency of the signal generator will remain fixed at the center of the UUT Channel.

For subset case 2: to retain 90% frequency overlap between the radar signal and the UUT Occupied Bandwidth, the center frequency of the signal generator will vary for each of the ten trials in subset case 2.

The center frequency of the signal generator for each trial is calculated by: $FL + (0.4 * Chirp\ Width\ [in\ MHz])$

For subset case 3: to retain 90% frequency overlap between the radar signal and the UUT Occupied Bandwidth, the center frequency of the signal generator will vary for each of the ten trials in subset case 3.

The center frequency of the signal generator for each trial is calculated by: $FH - (0.4 * Chirp\ Width\ [in\ MHz])$

Note: The FH and FL are Occupied Bandwidth low edge and high edge, where

$$FH = Fc + (OBW / 2) \text{ and } FL = Fc - (OBW / 2)$$

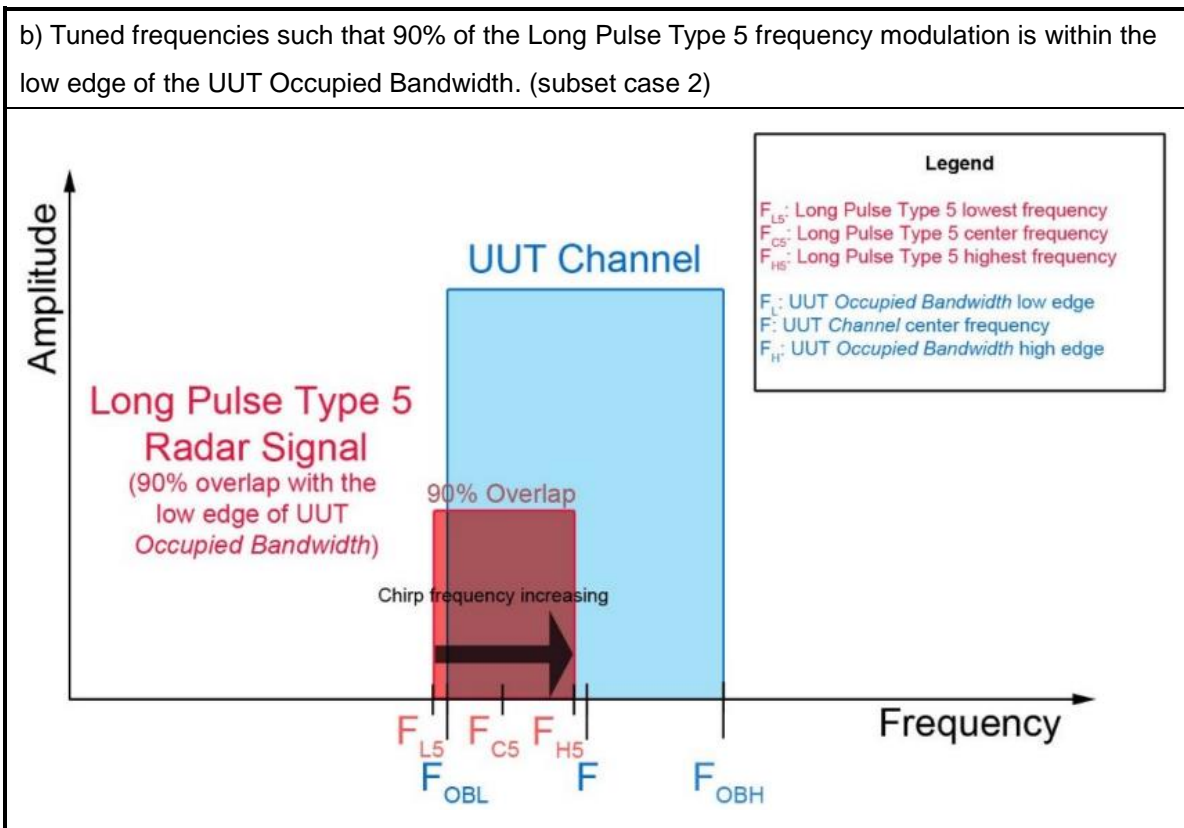
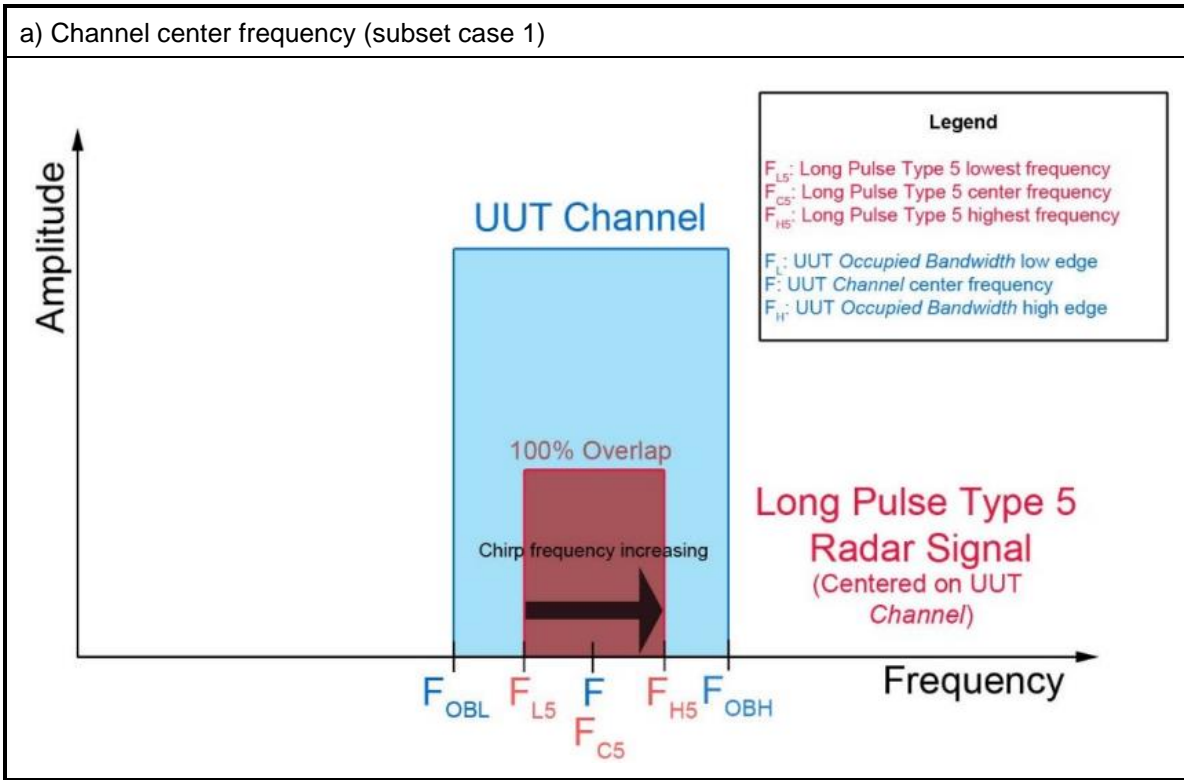

c) Tuned frequencies such that 90% of the Long Pulse Type 5 frequency modulation is within the high edge of the UUT Occupied Bandwidth. (subset case 3)

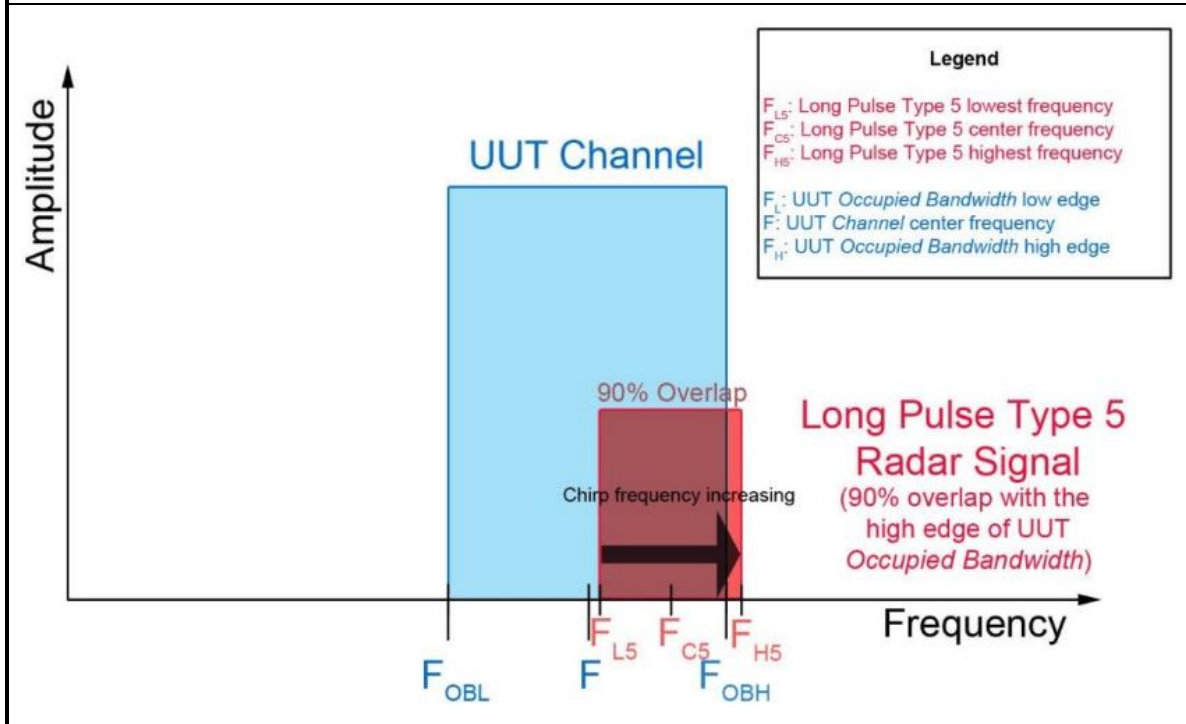

The percentage of successful detection is calculated by:

$$\frac{\text{TotalWaveformDetections}}{\text{TotalWaveformTrials}} \times 100$$



Frequency Hopping Radar Test

Statistical data will be gathered to determine the ability of the device to detect the Frequency Hopping radar test signal (radar type 6) found in **Table 7**. The device can utilize a test mode to demonstrate when detection occurs to prevent the need to reset the device between trial runs. The probability of successful detection is calculated by:

$$\frac{TotalWaveformDetections}{TotalWaveformTrials} \times 100$$

Table 7 – Frequency Hopping Radar Test Waveform

Radars Type	Pulse Width (µsec)	PRI (µsec)	Pulses per Hop	Hopping Rate (kHz)	Hopping Sequence Length (msec)	Minimum Percentage of Successful Detection	Minimum Number of Trials
6	1	333	9	0.333	300	70%	30

For the Frequency Hopping Radar Type, the same *Burst* parameters are used for each waveform. The hopping sequence is different for each waveform and a 100-length segment is selected from the hopping sequence defined by the following algorithm:

The first frequency in a hopping sequence is selected randomly from the group of 475 integer frequencies from 5250 – 5724 MHz. Next, the frequency that was just chosen is removed from the group and a frequency is randomly selected from the remaining 474 frequencies in the group. This process continues until all 475 frequencies are chosen for the set. For selection of a random frequency, the frequencies remaining within the group are always treated as equally likely.

3.5.2 Test Procedures

- (1) One frequency will be chosen from the Operating Channels of the EUT within the 5250-5350 MHz or 5470-5725 MHz bands.
- (2) In case the EUT is a Master Device, a U-NII device operating as a Client Device will be used and it is assumed that the Client will associate with the EUT (Master). If the Master Device has antenna gain, the main beam of the antenna will be directed toward the radar emitter. Vertical polarization is used for testing.
- (3) The TCP protocol unicast data stream was generated by the iperf software command line with at least 17% activity ratio over any 100ms period.
- (4) At time T_0 the Radar Waveform generator sends a Burst of pulses for each of the Radar Types 1-6 at DFS Detection Threshold levels on the Operating Channel. An additional 1 dB is added to the radar test signal to ensure it is at or above the DFS Detection Threshold, accounting for equipment variations/errors.
- (5) Observe the transmissions of the EUT at the end of the Burst on the Operating Channel for duration greater than 10 seconds for Short Pulse Radar Types 1-4 and 6 to ensure detection occurs.
- (6) Observe the transmissions of the EUT at the end of the Burst on the Operating Channel for duration greater than 22 seconds for Long Pulse Radar Type 5 to ensure detection occurs.

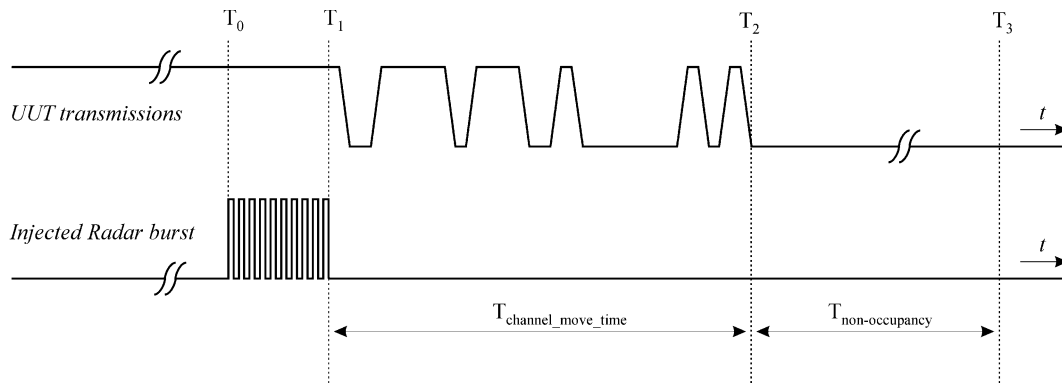

3.5.3 Test Setup

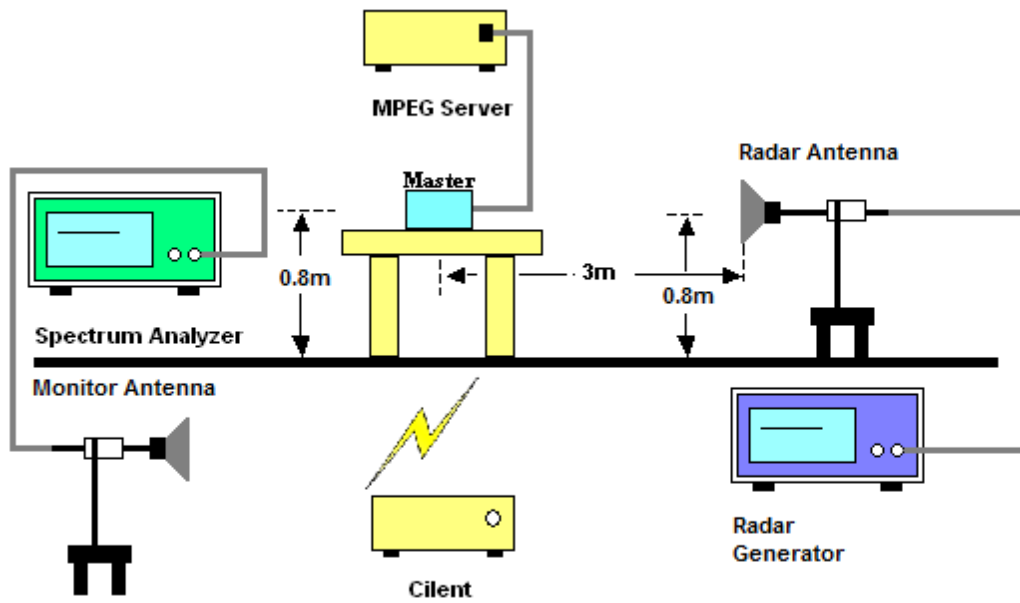

3.5.4 Test Deviation

There is no deviation with the original standard.



3.5.5 Result of Statistical Performance Check

<20MHz / 5300MHz>

(Detection = Y, No Detection = N)						
Trial Number	Type 1	Type 2	Type 3	Type 4	Type 5	Type 6
1	Y	Y	Y	Y	Y	Y
2	Y	Y	Y	Y	Y	Y
3	Y	Y	Y	Y	Y	Y
4	Y	Y	Y	Y	Y	Y
5	Y	Y	Y	Y	Y	Y
6	Y	Y	Y	Y	Y	Y
7	Y	Y	Y	Y	Y	Y
8	Y	Y	Y	Y	Y	Y
9	Y	Y	Y	Y	Y	Y
10	Y	Y	Y	Y	Y	Y
11	Y	Y	Y	Y	Y	Y
12	N	Y	Y	Y	Y	Y
13	Y	Y	Y	Y	Y	Y
14	Y	Y	Y	Y	Y	Y
15	Y	Y	Y	Y	Y	Y
16	Y	Y	Y	Y	Y	Y
17	Y	Y	Y	Y	Y	Y
18	Y	Y	Y	Y	Y	Y
19	Y	Y	Y	Y	Y	Y
20	Y	Y	Y	Y	Y	Y
21	Y	Y	Y	Y	Y	Y
22	Y	Y	Y	Y	Y	Y
23	Y	Y	Y	Y	Y	Y
24	Y	Y	Y	Y	Y	Y
25	Y	Y	Y	Y	Y	Y
26	Y	Y	Y	Y	Y	Y
27	Y	Y	Y	Y	Y	Y
28	Y	Y	Y	Y	Y	Y
29	Y	Y	Y	Y	Y	Y
30	Y	Y	Y	Y	Y	Y
Trial of Detection	29/30	30/30	30/30	30/30	30/30	30/30
Probability (%)	96.67%	100%	100%	100%	100%	100%
Limit (%)	>= 60%	>= 60%	>= 60%	>= 60%	>= 80%	>= 70%
Average Probability of Radar Type 1~4 (%)	99.17% (>=80%)					



<40MHz /5310MHz>

(Detection = Y, No Detection = N)						
Trial Number	Type 1	Type 2	Type 3	Type 4	Type 5	Type 6
1	Y	Y	Y	Y	Y	Y
2	Y	Y	Y	Y	Y	Y
3	Y	Y	Y	Y	Y	Y
4	Y	Y	Y	Y	Y	Y
5	Y	Y	Y	Y	Y	Y
6	Y	Y	Y	Y	Y	Y
7	Y	Y	Y	Y	Y	Y
8	Y	Y	Y	Y	Y	Y
9	Y	Y	Y	Y	Y	Y
10	Y	Y	Y	Y	Y	Y
11	Y	Y	Y	Y	Y	Y
12	N	Y	Y	Y	Y	Y
13	Y	Y	Y	Y	Y	Y
14	Y	Y	Y	Y	Y	Y
15	Y	Y	Y	Y	Y	Y
16	Y	Y	Y	Y	Y	Y
17	Y	Y	Y	Y	Y	Y
18	Y	Y	Y	Y	Y	Y
19	Y	Y	Y	Y	Y	Y
20	Y	Y	Y	Y	Y	Y
21	Y	Y	Y	Y	Y	Y
22	Y	Y	Y	Y	Y	Y
23	Y	Y	Y	Y	Y	Y
24	Y	Y	Y	Y	Y	Y
25	Y	Y	Y	Y	Y	Y
26	Y	Y	Y	Y	Y	Y
27	Y	Y	Y	Y	Y	Y
28	Y	Y	Y	Y	Y	Y
29	Y	Y	Y	Y	Y	Y
30	Y	Y	Y	Y	Y	Y
Trial of Detection	29/30	30/30	30/30	30/30	30/30	30/30
Probability (%)	96.67%	100%	100%	100%	100%	100%
Limit (%)	>= 60%	>= 60%	>= 60%	>= 60%	>= 80%	>= 70%
Average Probability of Radar Type 1~4 (%)			99.17% (>=80%)			



<80MHz / 5290MHz>

(Detection = Y, No Detection = N)						
Trial Number	Type 1	Type 2	Type 3	Type 4	Type 5	Type 6
1	Y	Y	Y	Y	Y	Y
2	Y	Y	Y	Y	Y	Y
3	Y	Y	Y	Y	Y	Y
4	Y	Y	Y	Y	Y	Y
5	Y	Y	Y	Y	Y	Y
6	Y	Y	Y	Y	Y	Y
7	Y	Y	Y	Y	Y	Y
8	Y	Y	Y	Y	Y	Y
9	Y	Y	Y	Y	Y	Y
10	Y	Y	Y	Y	Y	Y
11	Y	Y	Y	Y	Y	Y
12	N	Y	Y	Y	Y	Y
13	Y	Y	Y	Y	Y	Y
14	Y	Y	Y	Y	Y	Y
15	Y	Y	Y	Y	Y	Y
16	Y	Y	Y	Y	Y	Y
17	Y	Y	Y	Y	Y	Y
18	Y	Y	Y	Y	Y	Y
19	Y	Y	Y	Y	Y	Y
20	Y	Y	Y	Y	Y	Y
21	Y	Y	Y	Y	Y	Y
22	Y	Y	Y	Y	Y	Y
23	Y	Y	Y	Y	Y	Y
24	Y	Y	Y	Y	Y	Y
25	Y	Y	Y	Y	Y	Y
26	Y	Y	Y	Y	Y	Y
27	Y	Y	Y	Y	Y	Y
28	Y	Y	Y	Y	Y	Y
29	Y	Y	Y	Y	Y	Y
30	Y	Y	Y	Y	Y	Y
Trial of Detection	29/30	30/30	30/30	30/30	30/30	30/30
Probability (%)	96.67%	100%	100%	100%	100%	100%
Limit (%)	>= 60%	>= 60%	>= 60%	>= 60%	>= 80%	>= 70%
Average Probability of Radar Type 1~4 (%)			99.17% (>=80%)			



<80MHz / 5290MHz>(radar injected on 5290MHz)

(Detection = Y, No Detection = N)						
Trial Number	Type 1	Type 2	Type 3	Type 4	Type 5	Type 6
1	Y	Y	Y	Y	Y	Y
2	Y	Y	Y	Y	Y	Y
3	Y	Y	Y	Y	Y	Y
4	Y	Y	Y	Y	Y	Y
5	Y	Y	Y	Y	Y	Y
6	Y	Y	Y	Y	Y	Y
7	Y	Y	Y	Y	Y	Y
8	Y	Y	Y	Y	Y	Y
9	Y	Y	Y	Y	Y	Y
10	Y	Y	Y	Y	Y	Y
11	Y	Y	Y	Y	Y	Y
12	N	Y	Y	Y	Y	Y
13	Y	Y	Y	Y	Y	Y
14	Y	Y	Y	Y	Y	Y
15	Y	Y	Y	Y	Y	Y
16	Y	Y	Y	Y	Y	Y
17	Y	Y	Y	Y	Y	Y
18	Y	Y	Y	Y	Y	Y
19	Y	Y	Y	Y	Y	Y
20	Y	Y	Y	Y	Y	Y
21	Y	Y	Y	Y	Y	Y
22	Y	Y	Y	Y	Y	Y
23	Y	Y	Y	Y	Y	Y
24	Y	Y	Y	Y	Y	Y
25	Y	Y	Y	Y	Y	Y
26	Y	Y	Y	Y	Y	Y
27	Y	Y	Y	Y	Y	Y
28	Y	Y	Y	Y	Y	Y
29	Y	Y	Y	Y	Y	Y
30	Y	Y	Y	Y	Y	Y
Trial of Detection	29/30	30/30	30/30	30/30	30/30	30/30
Probability (%)	96.67%	100%	100%	100%	100%	100%
Limit (%)	>= 60%	>= 60%	>= 60%	>= 60%	>= 80%	>= 70%
Average Probability of Radar Type 1~4 (%)	99.17% (>=80%)					



<20MHz / 5500MHz>

(Detection = Y, No Detection = N)						
Trial Number	Type 1	Type 2	Type 3	Type 4	Type 5	Type 6
1	Y	Y	Y	Y	Y	Y
2	Y	Y	Y	Y	Y	Y
3	Y	Y	Y	Y	Y	Y
4	Y	Y	Y	Y	Y	Y
5	Y	Y	Y	Y	Y	Y
6	Y	Y	Y	Y	Y	Y
7	Y	Y	Y	Y	Y	Y
8	Y	Y	Y	Y	Y	Y
9	Y	Y	Y	Y	Y	Y
10	Y	Y	Y	Y	Y	Y
11	Y	Y	Y	Y	Y	Y
12	N	Y	Y	Y	Y	Y
13	Y	Y	Y	Y	Y	Y
14	Y	Y	Y	Y	Y	Y
15	Y	Y	Y	Y	Y	Y
16	Y	Y	Y	Y	Y	Y
17	Y	Y	Y	Y	Y	Y
18	Y	Y	Y	Y	Y	Y
19	Y	Y	Y	Y	Y	Y
20	Y	Y	Y	Y	Y	Y
21	Y	Y	Y	Y	Y	Y
22	Y	Y	Y	Y	Y	Y
23	Y	Y	Y	Y	Y	Y
24	Y	Y	Y	Y	Y	Y
25	Y	Y	Y	Y	Y	Y
26	Y	Y	Y	Y	Y	Y
27	Y	Y	Y	Y	Y	Y
28	Y	Y	Y	Y	Y	Y
29	Y	Y	Y	Y	Y	Y
30	Y	Y	Y	Y	Y	Y
Trial of Detection	29/30	30/30	30/30	30/30	30/30	30/30
Probability (%)	96.67%	100%	100%	100%	100%	100%
Limit (%)	>= 60%	>= 60%	>= 60%	>= 60%	>= 80%	>= 70%
Average Probability of Radar Type 1~4 (%)	99.17% (>=80%)					



<40MHz / 5510MHz>

(Detection = Y, No Detection = N)						
Trial Number	Type 1	Type 2	Type 3	Type 4	Type 5	Type 6
1	Y	Y	Y	Y	Y	Y
2	Y	Y	Y	Y	Y	Y
3	Y	Y	Y	Y	Y	Y
4	Y	Y	Y	Y	Y	Y
5	Y	Y	Y	Y	Y	Y
6	Y	Y	Y	Y	Y	Y
7	Y	Y	Y	Y	Y	Y
8	Y	Y	Y	Y	Y	Y
9	Y	Y	Y	Y	Y	Y
10	Y	Y	Y	Y	Y	Y
11	Y	Y	Y	Y	Y	Y
12	N	Y	Y	Y	Y	Y
13	Y	Y	Y	Y	Y	Y
14	Y	Y	Y	Y	Y	Y
15	Y	Y	Y	Y	Y	Y
16	Y	Y	Y	Y	Y	Y
17	Y	Y	Y	Y	Y	Y
18	Y	Y	Y	Y	Y	Y
19	Y	Y	Y	Y	Y	Y
20	Y	Y	Y	Y	Y	Y
21	Y	Y	Y	Y	Y	Y
22	Y	Y	Y	Y	Y	Y
23	Y	Y	Y	Y	Y	Y
24	Y	Y	Y	Y	Y	Y
25	Y	Y	Y	Y	Y	Y
26	Y	Y	Y	Y	Y	Y
27	Y	Y	Y	Y	Y	Y
28	Y	Y	Y	Y	Y	Y
29	Y	Y	Y	Y	Y	Y
30	Y	Y	Y	Y	Y	Y
Trial of Detection	29/30	30/30	30/30	30/30	30/30	29/30
Probability (%)	96.67%	100%	100%	100%	100%	100%
Limit (%)	>= 60%	>= 60%	>= 60%	>= 60%	>= 80%	>= 70%
Average Probability of Radar Type 1~4 (%)				99.17% (>=80%)		



<80MHz / 5530MHz>

(Detection = Y, No Detection = N)						
Trial Number	Type 1	Type 2	Type 3	Type 4	Type 5	Type 6
1	Y	Y	Y	Y	Y	Y
2	Y	Y	Y	Y	Y	Y
3	Y	Y	Y	Y	Y	Y
4	Y	Y	Y	Y	Y	Y
5	Y	Y	Y	Y	Y	Y
6	Y	Y	Y	Y	Y	Y
7	Y	Y	Y	Y	Y	Y
8	Y	Y	Y	Y	Y	Y
9	Y	Y	Y	Y	Y	Y
10	Y	Y	Y	Y	Y	Y
11	Y	Y	Y	Y	Y	Y
12	N	Y	Y	Y	Y	Y
13	Y	Y	Y	Y	Y	Y
14	Y	Y	Y	Y	Y	Y
15	Y	Y	Y	Y	Y	Y
16	Y	Y	Y	Y	Y	Y
17	Y	Y	Y	Y	Y	Y
18	Y	Y	Y	Y	Y	Y
19	Y	Y	Y	Y	Y	Y
20	Y	Y	Y	Y	Y	Y
21	Y	Y	Y	Y	Y	Y
22	Y	Y	Y	Y	Y	Y
23	Y	Y	Y	Y	Y	Y
24	Y	Y	Y	Y	Y	Y
25	Y	Y	Y	Y	Y	Y
26	Y	Y	Y	Y	Y	Y
27	Y	Y	Y	Y	Y	Y
28	Y	Y	Y	Y	Y	Y
29	Y	Y	Y	Y	Y	Y
30	Y	Y	Y	Y	Y	Y
Trial of Detection	29/30	30/30	30/30	30/30	30/30	30/30
Probability (%)	96.67%	100%	100%	100%	100%	100%
Limit (%)	>= 60%	>= 60%	>= 60%	>= 60%	>= 80%	>= 70%
Average Probability of Radar Type 1~4 (%)			99.17% (>=80%)			



<160MHz/ 5570MHz>

(Detection = Y, No Detection = N)						
Trial Number	Type 1	Type 2	Type 3	Type 4	Type 5	Type 6
1	Y	Y	Y	Y	Y	Y
2	Y	Y	Y	Y	Y	Y
3	Y	Y	Y	Y	Y	Y
4	Y	Y	Y	Y	Y	Y
5	Y	Y	Y	Y	Y	Y
6	Y	Y	Y	Y	Y	Y
7	Y	Y	Y	Y	Y	Y
8	Y	Y	Y	Y	Y	Y
9	Y	Y	Y	Y	Y	Y
10	Y	Y	Y	Y	Y	Y
11	Y	Y	Y	Y	Y	Y
12	N	Y	Y	Y	Y	Y
13	Y	Y	Y	Y	Y	Y
14	Y	Y	Y	Y	Y	Y
15	Y	Y	Y	Y	Y	Y
16	Y	Y	Y	Y	Y	Y
17	Y	Y	Y	Y	Y	Y
18	Y	Y	Y	Y	Y	Y
19	Y	Y	Y	Y	Y	Y
20	Y	Y	Y	Y	Y	Y
21	Y	Y	Y	Y	Y	Y
22	Y	Y	Y	Y	Y	Y
23	Y	Y	Y	Y	Y	Y
24	Y	Y	Y	Y	Y	Y
25	Y	Y	Y	Y	Y	Y
26	Y	Y	Y	Y	Y	Y
27	Y	Y	Y	Y	Y	Y
28	Y	Y	Y	Y	Y	Y
29	Y	Y	Y	Y	Y	Y
30	Y	Y	Y	Y	Y	Y
Trial of Detection	29/30	30/30	30/30	30/30	30/30	30/30
Probability (%)	96.67%	100%	100%	100%	100%	100%
Limit (%)	>= 60%	>= 60%	>= 60%	>= 60%	>= 80%	>= 70%
Average Probability of Radar Type 1~4 (%)	99.17% (>=80%)					



4 List of Measuring Equipment

Instrument	Brand Name	Model No.	Serial No.	Characteristics	Calibration Date	Test Date	Due Date	Remark
RF Vector Generator	Keysight	N5182B	MY573009 63	9KHz~6GHz	Mar. 01, 2021	Aug. 10, 2021~ Nov. 20, 2021	Feb. 28, 2022	DFS (DFS01-CA)
Horn Antenna	ETS-Lindgren	3117	00227739	1GHz ~18GHz	May 24, 2021	Aug. 10, 2021~ Nov. 20, 2021	May 23, 2022	DFS (DFS01-CA)
Horn Antenna	SCHWARZBE CK	BBHA 9120D	2113	1GHz ~18GHz	Jul. 08, 2021	Aug. 10, 2021~ Nov. 20, 2021	Jul. 07, 2022	DFS (DFS01-CA)
Spectrum Analyzer	Keysight	N9010A	MY542004 85	10Hz~44GHz	Mar. 05, 2021	Aug. 10, 2021~ Nov. 20, 2021	Mar. 04, 2022	DFS (DFS01-CA)



Appendix A. DFS Radar Parameters

DFS Radar Parameters
FCC Radar Type 1
Channel 60 Bandwidth 20MHz

Trial #	Pulse Repetition Frequency Number (1 to 23)	Pulse Repetition Frequency (Pulses Per Second)	Pulse Repetition Interval (Microseconds)	Detection (Yes / No)
1	22	1066.10	938	Yes
2	10	1432.66	698	Yes
3	6	1618.12	618	Yes
4	2	1858.74	538	Yes
5	19	1138.95	878	Yes
6	12	326.16	3066	Yes
7	7	1567.40	638	Yes
8	21	1089.32	918	Yes
9	17	1193.32	838	Yes
10	18	1165.50	858	Yes
11	15	1253.13	798	Yes
12	11	1392.76	718	No
13	4	1730.10	578	Yes
14	5	1672.24	598	Yes
15	3	1792.11	558	Yes
16		394.32	2536	Yes
17		1035.20	966	Yes
18		1209.19	827	Yes
19		399.84	2501	Yes
20		385.36	2595	Yes
21		897.67	1114	Yes
22		768.05	1302	Yes
23		328.41	3045	Yes
24		615.76	1624	Yes
25		347.46	2878	Yes
26		973.71	1027	Yes
27		402.41	2485	Yes
28		625.00	1600	Yes
29		853.24	1172	Yes
30		849.62	1177	Yes

DFS Radar Parameters
FCC Radar Type 2
Channel 60 Bandwidth 20MHz

Trial #	Number Pulses per Burst	Pulse Width (Microseconds)	Pulse Repetition Interval (Microseconds)	Detection (Yes / No)
1	26	3.20	179	Yes
2	23	1.10	207	Yes
3	24	2.10	230	Yes
4	29	4.80	200	Yes
5	28	3.90	214	Yes
6	26	2.90	222	Yes
7	26	3.20	204	Yes
8	25	2.50	192	Yes
9	26	3.10	164	Yes
10	23	1.20	156	Yes
11	27	3.90	210	Yes
12	29	4.60	201	Yes
13	26	3.20	162	Yes
14	25	2.20	197	Yes
15	29	4.50	163	Yes
16	26	3.00	203	Yes
17	29	5.00	168	Yes
18	25	2.40	217	Yes
19	26	2.90	191	Yes
20	25	2.30	166	Yes
21	27	3.70	150	Yes
22	25	2.20	176	Yes
23	29	4.90	195	Yes
24	26	2.90	202	Yes
25	25	2.50	178	Yes
26	23	1.10	206	Yes
27	27	3.80	155	Yes
28	29	4.70	157	Yes
29	25	2.40	224	Yes
30	28	4.20	159	Yes

DFS Radar Parameters
FCC Radar Type 3
Channel 60 Bandwidth 20MHz

Trial #	Number Pulses per Burst	Pulse Width (Microseconds)	Pulse Repetition Interval (Microseconds)	Detection (Yes / No)
1	17	8.20	355	Yes
2	16	6.10	487	Yes
3	16	7.10	344	Yes
4	18	9.80	288	Yes
5	18	8.90	230	Yes
6	17	7.90	432	Yes
7	17	8.20	207	Yes
8	17	7.50	443	Yes
9	17	8.10	439	Yes
10	16	6.20	223	Yes
11	18	8.90	208	Yes
12	18	9.60	463	Yes
13	17	8.20	441	Yes
14	16	7.20	323	Yes
15	18	9.50	297	Yes
16	17	8.00	412	Yes
17	18	10.00	324	Yes
18	17	7.40	271	Yes
19	17	7.90	349	Yes
20	16	7.30	409	Yes
21	18	8.70	373	Yes
22	16	7.20	254	Yes
23	18	9.90	274	Yes
24	17	7.90	278	Yes
25	17	7.50	317	Yes
26	16	6.10	260	Yes
27	18	8.80	211	Yes
28	18	9.70	272	Yes
29	17	7.40	264	Yes
30	18	9.20	284	Yes

DFS Radar Parameters
FCC Radar Type 4
Channel 60 Bandwidth 20MHz

Trial #	Number Pulses per Burst	Pulse Width (Microseconds)	Pulse Repetition Interval (Microseconds)	Detection (Yes / No)
1	14	16.00	355	Yes
2	12	11.30	487	Yes
3	13	13.50	344	Yes
4	16	19.40	288	Yes
5	15	17.50	230	Yes
6	14	15.30	432	Yes
7	14	15.90	207	Yes
8	13	14.30	443	Yes
9	14	15.80	439	Yes
10	12	11.50	223	Yes
11	15	17.40	208	Yes
12	16	19.00	463	Yes
13	14	16.00	441	Yes
14	13	13.80	323	Yes
15	16	18.90	297	Yes
16	14	15.50	412	Yes
17	16	19.90	324	Yes
18	13	14.10	271	Yes
19	14	15.20	349	Yes
20	13	13.80	409	Yes
21	15	17.10	373	Yes
22	13	13.80	254	Yes
23	16	19.80	274	Yes
24	14	15.30	278	Yes
25	13	14.50	317	Yes
26	12	11.30	260	Yes
27	15	17.30	211	Yes
28	16	19.20	272	Yes
29	13	14.20	264	Yes
30	15	18.20	284	Yes

DFS Radar Parameters
FCC Radar Type 5
Channel 60 Bandwidth 20MHz

Trial Number:			1			Detection (Yes/No)
Number of Bursts in Trial:			15			
Chirp Center Frequency:			5300			
Burst	Number of Pulses	Pulse Width (Microseconds)	Chirp Width (MHz)	Pulse 1-to-2 Spacing (µsec)	Pulse 2-to-3 Spacing (µsec)	Starting Location Within Interval (µsec)
1	2	77.8	13	1477	-	636185
2	1	51.9	13	-	-	32674
3	1	63.8	13	-	-	226294
4	3	96.6	13	1786	1843	417976
5	3	85.9	13	1215	1729	611152
6	2	73.7	13	1549	-	8789
7	2	77.2	13	1819	-	201917
8	2	68.4	13	1114	-	395530
9	2	76.7	13	1155	-	588564
10	1	53.2	13	-	-	783794
11	3	85.7	13	1695	1394	177933
12	3	94.3	13	1426	1935	370624
13	2	77.6	13	1671	-	564893
14	1	65.7	13	-	-	759583
15	3	93.5	13	1130	1468	154262
16						
17						
18						
19						
20						

Trial Number:			2			Detection (Yes/No)
Number of Bursts in Trial:			8			
Chirp Center Frequency:			5300			
Burst	Number of Pulses	Pulse Width (Microseconds)	Chirp Width (MHz)	Pulse 1-to-2 Spacing (µsec)	Pulse 2-to-3 Spacing (µsec)	Starting Location Within Interval (µsec)
1	2	75	5	1527	-	653020
2	3	99.4	5	1262	1257	1015643
3	2	67.4	5	1403	-	1379398
4	2	73.6	5	1041	-	245489
5	1	65.9	5	-	-	609113
6	3	83.8	5	1292	1419	970852
7	1	65.5	5	-	-	1335913
8	3	98.6	5	1796	1728	200406
9						
10						
11						
12						
13						
14						
15						
16						
17						
18						
19						
20						

DFS Radar Parameters
FCC Radar Type 5
Channel 60 Bandwidth 20MHz

Trial Number:			3			Detection (Yes/No) Yes
Number of Bursts in Trial:			11			
Chirp Center Frequency:			5300			
Burst	Number of Pulses	Pulse Width (Microseconds)	Chirp Width (MHz)	Pulse 1-to-2 Spacing (μ sec)	Pulse 2-to-3 Spacing (μ sec)	Starting Location Within Interval (μ sec)
1	2	73.8	9	1538	-	409565
2	2	69.5	9	1649	-	673692
3	1	51.9	9	-	-	938562
4	3	84.6	9	1032	1271	113209
5	3	95.4	9	1903	1388	376726
6	2	68	9	1351	-	641212
7	3	89.6	9	1514	1573	903714
8	2	81.9	9	1689	-	80863
9	3	88.3	9	1330	1838	344067
10	1	53.7	9	-	-	609331
11	3	91.3	9	1106	1001	871542
12						
13						
14						
15						
16						
17						
18						
19						
20						

Trial Number:			4			Detection (Yes/No) Yes
Number of Bursts in Trial:			20			
Chirp Center Frequency:			5300			
Burst	Number of Pulses	Pulse Width (Microseconds)	Chirp Width (MHz)	Pulse 1-to-2 Spacing (μ sec)	Pulse 2-to-3 Spacing (μ sec)	Starting Location Within Interval (μ sec)
1	2	68.1	19	1355	-	26541
2	1	58.7	19	-	-	171821
3	2	75.3	19	1640	-	316229
4	1	56.4	19	-	-	461864
5	3	99.7	19	1708	1159	8677
6	1	57.7	19	-	-	153995
7	1	59.5	19	-	-	299238
8	2	80	19	1369	-	443177
9	2	82	19	1197	-	587671
10	2	82.8	19	1005	-	135674
11	3	88	19	1928	1101	279928
12	3	93.2	19	1907	1223	424279
13	2	70.4	19	1360	-	570132
14	3	95.3	19	1955	1775	117439
15	2	81.9	19	1545	-	262502
16	3	98.5	19	1169	1062	406573
17	1	65	19	-	-	553328
18	3	85.4	19	1637	1425	99799
19	3	91.6	19	1445	1325	244095
20	2	67.3	19	1218	-	390012

DFS Radar Parameters
FCC Radar Type 5
Channel 60 Bandwidth 20MHz

Trial Number:			5			Detection (Yes/No)
Number of Bursts in Trial:			17			
Chirp Center Frequency:			5300			Yes
Burst	Number of Pulses	Pulse Width (Microseconds)	Chirp Width (MHz)	Pulse 1-to-2 Spacing (µsec)	Pulse 2-to-3 Spacing (µsec)	Starting Location Within Interval (µsec)
1	2	67.9	16	1133	-	629614
2	1	62.3	16	-	-	96856
3	1	53.3	16	-	-	267719
4	3	90	16	1153	1346	436784
5	2	77.1	16	1646	-	608289
6	3	83.9	16	1232	1459	75610
7	3	89.1	16	1384	1939	245638
8	2	81.8	16	1676	-	416355
9	1	50.3	16	-	-	588736
10	3	87.1	16	1996	1756	54571
11	2	71.3	16	1815	-	225175
12	3	97.5	16	1465	1132	394825
13	3	90.6	16	1040	1354	565361
14	3	86.3	16	1183	1792	33643
15	3	97.6	16	1073	1361	203957
16	3	84.7	16	1718	1854	373812
17	3	99.7	16	1244	1988	544060
18						
19						
20						

Trial Number:			6			Detection (Yes/No)
Number of Bursts in Trial:			14			
Chirp Center Frequency:			5300			Yes
Burst	Number of Pulses	Pulse Width (Microseconds)	Chirp Width (MHz)	Pulse 1-to-2 Spacing (µsec)	Pulse 2-to-3 Spacing (µsec)	Starting Location Within Interval (µsec)
1	3	92.9	12	1564	1407	15438
2	2	67.7	12	1747	-	222486
3	1	65.8	12	-	-	430731
4	1	56.3	12	-	-	637784
5	1	53.7	12	-	-	845342
6	3	83.5	12	1930	1025	196720
7	1	65.8	12	-	-	404955
8	3	85.9	12	1034	1808	610711
9	2	76.3	12	1926	-	818057
10	2	81.5	12	1714	-	171459
11	3	89.4	12	1594	1827	377969
12	1	63.4	12	-	-	586875
13	2	69.6	12	1925	-	792834
14	2	74.5	12	1846	-	146044
15						
16						
17						
18						
19						
20						

DFS Radar Parameters
FCC Radar Type 5
Channel 60 Bandwidth 20MHz

Trial Number:			7			Detection (Yes/No)
Number of Bursts in Trial:			15			
Chirp Center Frequency:			5300			
Burst	Number of Pulses	Pulse Width (Microseconds)	Chirp Width (MHz)	Pulse 1-to-2 Spacing (µsec)	Pulse 2-to-3 Spacing (µsec)	Starting Location Within Interval (µsec)
1	3	96.6	13	1609	1581	329022
2	3	96.7	13	1799	1154	521718
3	3	86.5	13	1396	1865	714222
4	2	73.3	13	1318	-	112450
5	1	55.8	13	-	-	306283
6	1	55.4	13	-	-	500239
7	3	85.3	13	1504	1820	690932
8	2	79.4	13	1893	-	88645
9	1	65.7	13	-	-	282508
10	2	68.6	13	1028	-	475842
11	2	77.7	13	1835	-	667887
12	2	79.6	13	1331	-	64845
13	3	94.9	13	1070	1349	257755
14	1	61.4	13	-	-	452335
15	3	90.6	13	1562	1887	643395
16						
17						
18						
19						
20						

Trial Number:			8			Detection (Yes/No)
Number of Bursts in Trial:			12			
Chirp Center Frequency:			5300			
Burst	Number of Pulses	Pulse Width (Microseconds)	Chirp Width (MHz)	Pulse 1-to-2 Spacing (µsec)	Pulse 2-to-3 Spacing (µsec)	Starting Location Within Interval (µsec)
1	1	52.6	10	-	-	51446
2	3	84.1	10	1725	1529	292696
3	3	97.7	10	1868	1805	533989
4	3	97.3	10	1446	1755	775564
5	3	98.8	10	1386	1302	21542
6	2	72.2	10	1184	-	263385
7	2	67.6	10	1027	-	505581
8	2	75.7	10	1871	-	747058
9	1	60.9	10	-	-	989976
10	1	64.2	10	-	-	234024
11	2	78.8	10	1604	-	475207
12	3	87.5	10	1712	1683	715825
13						
14						
15						
16						
17						
18						
19						
20						

DFS Radar Parameters
FCC Radar Type 5
Channel 60 Bandwidth 20MHz

Trial Number:			9			Detection (Yes/No)
Number of Bursts in Trial:			14			
Chirp Center Frequency:			5300			
Burst	Number of Pulses	Pulse Width (Microseconds)	Chirp Width (MHz)	Pulse 1-to-2 Spacing (µsec)	Pulse 2-to-3 Spacing (µsec)	Starting Location Within Interval (µsec)
1	1	54.1	13	-	-	823112
2	1	50.7	13	-	-	174965
3	1	52.3	13	-	-	382216
4	3	99.8	13	1696	1949	587395
5	2	68.4	13	1099	-	796897
6	2	80.8	13	1505	-	149042
7	1	62.5	13	-	-	356750
8	2	74.8	13	1204	-	563824
9	1	50.8	13	-	-	772314
10	1	54	13	-	-	123796
11	1	63	13	-	-	331215
12	3	91.8	13	1270	1347	537402
13	2	79.3	13	1992	-	744805
14	1	64.3	13	-	-	98172
15						
16						
17						
18						
19						
20						

Trial Number:			10			Detection (Yes/No)
Number of Bursts in Trial:			8			
Chirp Center Frequency:			5300			
Burst	Number of Pulses	Pulse Width (Microseconds)	Chirp Width (MHz)	Pulse 1-to-2 Spacing (µsec)	Pulse 2-to-3 Spacing (µsec)	Starting Location Within Interval (µsec)
1	1	63.4	6	-	-	535615
2	1	52	6	-	-	898668
3	3	97.2	6	1605	1583	1259235
4	2	78.7	6	1743	-	127106
5	2	74.2	6	1219	-	490358
6	3	88.7	6	1934	1273	852409
7	1	54.3	6	-	-	1217152
8	3	95.4	6	1555	1791	82296
9						
10						
11						
12						
13						
14						
15						
16						
17						
18						
19						
20						

DFS Radar Parameters
FCC Radar Type 5
Channel 60 Bandwidth 20MHz

Trial Number:			11			Detection (Yes/No)
Number of Bursts in Trial:			17			
Chirp Center Frequency:			5297			
Burst	Number of Pulses	Pulse Width (Microseconds)	Chirp Width (MHz)	Pulse 1-to-2 Spacing (µsec)	Pulse 2-to-3 Spacing (µsec)	Starting Location Within Interval (µsec)
1	2	73.7	16	1497	-	209249
2	3	97.4	16	1754	1613	378386
3	3	91.7	16	1702	1462	548411
4	1	66.2	16	-	-	17733
5	2	70.8	16	1821	-	187952
6	1	52.3	16	-	-	359277
7	2	78.9	16	1984	-	528886
8	2	70.9	16	1358	-	700166
9	2	75.6	16	1430	-	167197
10	1	59.1	16	-	-	338262
11	2	77	16	1304	-	508324
12	2	67.9	16	1083	-	678689
13	2	81.2	16	1932	-	146031
14	2	78.7	16	1121	-	316923
15	1	63.3	16	-	-	488056
16	2	68.9	16	1423	-	657326
17	1	59.3	16	-	-	125509
18						
19						
20						

Trial Number:			12			Detection (Yes/No)
Number of Bursts in Trial:			19			
Chirp Center Frequency:			5298			
Burst	Number of Pulses	Pulse Width (Microseconds)	Chirp Width (MHz)	Pulse 1-to-2 Spacing (µsec)	Pulse 2-to-3 Spacing (µsec)	Starting Location Within Interval (µsec)
1	3	98.9	19	1680	1488	263736
2	2	82.3	19	1855	-	416459
3	3	86.7	19	1400	1919	567902
4	3	89.7	19	1068	1282	92979
5	3	98.6	19	1194	1461	245155
6	2	71.1	19	1789	-	397609
7	1	55.9	19	-	-	551431
8	2	67.9	19	1372	-	74413
9	3	84.4	19	1107	1443	226559
10	1	58.8	19	-	-	380056
11	1	65.6	19	-	-	533408
12	2	78.5	19	1704	-	55547
13	2	82.3	19	1686	-	207876
14	3	90.1	19	1071	1266	359771
15	3	90.2	19	1089	1950	511297
16	2	83.1	19	1406	-	36803
17	1	58.8	19	-	-	189652
18	2	77	19	1657	-	341809
19	1	55	19	-	-	495737
20						

DFS Radar Parameters
FCC Radar Type 5
Channel 60 Bandwidth 20MHz

Trial Number:			13			Detection (Yes/No) Yes
Number of Bursts in Trial:			15			
Chirp Center Frequency:			5296			
Burst	Number of Pulses	Pulse Width (Microseconds)	Chirp Width (MHz)	Pulse 1-to-2 Spacing (µsec)	Pulse 2-to-3 Spacing (µsec)	Starting Location Within Interval (µsec)
1	1	58.1	13	-	-	22911
2	1	52.1	13	-	-	216473
3	1	59.9	13	-	-	410004
4	1	60.2	13	-	-	603671
5	3	95.9	13	1906	1608	794160
6	2	79.9	13	1859	-	192251
7	2	78.5	13	1917	-	385590
8	1	53.8	13	-	-	579862
9	1	64.7	13	-	-	773423
10	1	61.4	13	-	-	168898
11	2	83.2	13	1858	-	361606
12	3	84.7	13	1677	1638	553866
13	3	88.7	13	1528	1058	747241
14	2	78.3	13	1951	-	144710
15	2	69.3	13	1717	-	337856
16						
17						
18						
19						
20						

Trial Number:			14			Detection (Yes/No) Yes
Number of Bursts in Trial:			12			
Chirp Center Frequency:			5294			
Burst	Number of Pulses	Pulse Width (Microseconds)	Chirp Width (MHz)	Pulse 1-to-2 Spacing (µsec)	Pulse 2-to-3 Spacing (µsec)	Starting Location Within Interval (µsec)
1	2	75.3	10	1612	-	664275
2	1	56.3	10	-	-	907886
3	2	67.7	10	1185	-	151316
4	1	55.6	10	-	-	393746
5	2	75.2	10	1267	-	635093
6	2	76.3	10	1305	-	876993
7	3	85.7	10	1362	1924	121278
8	3	98.4	10	1550	1249	362696
9	3	86.4	10	1439	1046	604342
10	3	93.6	10	1031	1452	846453
11	1	63.3	10	-	-	91871
12	3	92.4	10	1673	1322	333050
13						
14						
15						
16						
17						
18						
19						
20						

DFS Radar Parameters
FCC Radar Type 5
Channel 60 Bandwidth 20MHz

Trial Number:			15			Detection (Yes/No)
Number of Bursts in Trial:			19			
Chirp Center Frequency:			5298			
						Yes
Burst	Number of Pulses	Pulse Width (Microseconds)	Chirp Width (MHz)	Pulse 1-to-2 Spacing (µsec)	Pulse 2-to-3 Spacing (µsec)	Starting Location Within Interval (µsec)
1	3	93.3	18	1912	1535	361323
2	2	69.1	18	1794	-	515261
3	3	86.9	18	1152	1148	39025
4	3	84.9	18	1948	1118	190900
5	2	72.3	18	1916	-	343941
6	1	51.7	18	-	-	497624
7	1	58.3	18	-	-	20319
8	1	60.8	18	-	-	172999
9	1	57.1	18	-	-	325872
10	3	88.9	18	1964	1489	475841
11	2	72	18	1297	-	1489
12	3	90.9	18	1566	1370	153647
13	1	59.8	18	-	-	307096
14	2	70	18	1291	-	458804
15	2	67.2	18	1881	-	610798
16	3	91.2	18	1832	1661	134759
17	1	56.5	18	-	-	288306
18	1	51.2	18	-	-	441296
19	2	74.1	18	1245	-	592780
20						

Trial Number:			16			Detection (Yes/No)
Number of Bursts in Trial:			14			
Chirp Center Frequency:			5295			
						Yes
Burst	Number of Pulses	Pulse Width (Microseconds)	Chirp Width (MHz)	Pulse 1-to-2 Spacing (µsec)	Pulse 2-to-3 Spacing (µsec)	Starting Location Within Interval (µsec)
1	2	76.9	12	1140	-	158286
2	1	50.2	12	-	-	366024
3	1	62.9	12	-	-	573452
4	1	64.7	12	-	-	780619
5	3	83.8	12	1097	1621	132455
6	1	65.4	12	-	-	340207
7	1	53.2	12	-	-	548208
8	1	51.7	12	-	-	755333
9	2	78.7	12	1168	-	107117
10	2	72.4	12	1343	-	314500
11	1	53.8	12	-	-	522447
12	2	73.6	12	1553	-	728517
13	2	66.7	12	1122	-	81611
14	2	82.5	12	1019	-	288948
15						
16						
17						
18						
19						
20						

DFS Radar Parameters
FCC Radar Type 5
Channel 60 Bandwidth 20MHz

Trial Number:			17			Detection (Yes/No)
Number of Bursts in Trial:			20			
Chirp Center Frequency:			5298			
Burst	Number of Pulses	Pulse Width (Microseconds)	Chirp Width (MHz)	Pulse 1-to-2 Spacing (µsec)	Pulse 2-to-3 Spacing (µsec)	Starting Location Within Interval (µsec)
1	3	87.6	20	1055	1840	345766
2	3	85.2	20	1541	1408	490019
3	3	84.8	20	1889	1463	39073
4	2	77.9	20	1460	-	183923
5	2	76.5	20	1485	-	328777
6	1	60.9	20	-	-	474728
7	2	83	20	1010	-	21394
8	2	80.4	20	1752	-	165992
9	2	67.5	20	1181	-	310973
10	1	62.1	20	-	-	456884
11	3	86.4	20	1966	1263	3515
12	3	84.3	20	1188	1788	147928
13	2	76.9	20	1537	-	293225
14	3	95.8	20	1298	1844	436922
15	1	55.2	20	-	-	584015
16	1	59	20	-	-	130832
17	3	94.5	20	1700	1283	274684
18	3	91.9	20	1978	1165	418579
19	3	85.2	20	1551	1189	563464
20	2	69.5	20	1224	-	112787

Trial Number:			18			Detection (Yes/No)
Number of Bursts in Trial:			12			
Chirp Center Frequency:			5294			
Burst	Number of Pulses	Pulse Width (Microseconds)	Chirp Width (MHz)	Pulse 1-to-2 Spacing (µsec)	Pulse 2-to-3 Spacing (µsec)	Starting Location Within Interval (µsec)
1	3	86.4	10	1918	1455	429224
2	3	92.2	10	1719	1895	670241
3	2	80.4	10	1899	-	912880
4	1	54.3	10	-	-	158603
5	1	53.1	10	-	-	400824
6	2	69.4	10	1546	-	641915
7	2	69.1	10	1639	-	883823
8	3	100	10	1438	1595	128373
9	2	79.6	10	1705	-	370379
10	3	88.4	10	1579	1623	611194
11	1	53.3	10	-	-	855665
12	1	65.3	10	-	-	98897
13						
14						
15						
16						
17						
18						
19						
20						

DFS Radar Parameters
FCC Radar Type 5
Channel 60 Bandwidth 20MHz

Trial Number:			19			Detection (Yes/No)
Number of Bursts in Trial:			14			
Chirp Center Frequency:			5295			
Burst	Number of Pulses	Pulse Width (Microseconds)	Chirp Width (MHz)	Pulse 1-to-2 Spacing (µsec)	Pulse 2-to-3 Spacing (µsec)	Starting Location Within Interval (µsec)
1	1	55.3	12	-	-	292143
2	1	58.3	12	-	-	499633
3	2	72.3	12	1039	-	706377
4	3	84.8	12	1761	1721	58989
5	2	82.5	12	1431	-	266161
6	1	63.3	12	-	-	474469
7	2	80	12	1913	-	680544
8	3	90.3	12	1853	1123	33519
9	3	91.1	12	1783	1172	240319
10	3	96.6	12	1036	1385	447400
11	2	82.7	12	1990	-	654516
12	1	50.7	12	-	-	8083
13	2	78.4	12	1109	-	215435
14	3	99.5	12	1965	1869	421325
15						
16						
17						
18						
19						
20						

Trial Number:			20			Detection (Yes/No)
Number of Bursts in Trial:			12			
Chirp Center Frequency:			5294			
Burst	Number of Pulses	Pulse Width (Microseconds)	Chirp Width (MHz)	Pulse 1-to-2 Spacing (µsec)	Pulse 2-to-3 Spacing (µsec)	Starting Location Within Interval (µsec)
1	3	88.6	10	1067	1927	733725
2	1	57.4	10	-	-	977882
3	3	96.6	10	1658	1324	221197
4	2	69.7	10	1945	-	462915
5	2	77.9	10	1317	-	705071
6	1	62	10	-	-	947923
7	3	88.4	10	1077	1366	191373
8	3	97.3	10	1896	1367	432561
9	3	96.2	10	1787	1672	674004
10	3	95.4	10	1892	1414	915842
11	1	54.8	10	-	-	162176
12	2	80.4	10	1436	-	403553
13						
14						
15						
16						
17						
18						
19						
20						

DFS Radar Parameters
FCC Radar Type 5
Channel 60 Bandwidth 20MHz

Trial Number:			21			Detection (Yes/No)
Number of Bursts in Trial:			16			
Chirp Center Frequency:			5304			
Burst	Number of Pulses	Pulse Width (Microseconds)	Chirp Width (MHz)	Pulse 1-to-2 Spacing (µsec)	Pulse 2-to-3 Spacing (µsec)	Starting Location Within Interval (µsec)
1	2	74.7	15	1611	-	483470
2	1	57.1	15	-	-	666072
3	3	91.9	15	1475	1276	98810
4	2	83.1	15	1772	-	279914
5	1	50.7	15	-	-	462536
6	2	79.2	15	1600	-	642324
7	1	58.7	15	-	-	76831
8	2	71	15	1567	-	257785
9	2	79	15	1960	-	438554
10	2	68.5	15	1428	-	620397
11	2	73.5	15	1352	-	54310
12	2	70.5	15	1115	-	235506
13	2	76.6	15	1300	-	417036
14	2	81.2	15	1675	-	597974
15	1	61.8	15	-	-	32086
16	3	94.9	15	1206	1860	212751
17						
18						
19						
20						

Trial Number:			22			Detection (Yes/No)
Number of Bursts in Trial:			12			
Chirp Center Frequency:			5306			
Burst	Number of Pulses	Pulse Width (Microseconds)	Chirp Width (MHz)	Pulse 1-to-2 Spacing (µsec)	Pulse 2-to-3 Spacing (µsec)	Starting Location Within Interval (µsec)
1	2	78.5	9	1698	-	526149
2	3	89.8	9	1962	1167	767135
3	1	59.4	9	-	-	12955
4	2	79.6	9	1890	-	254612
5	2	76	9	1811	-	496588
6	1	53.6	9	-	-	739728
7	2	80.9	9	1053	-	980872
8	1	61.6	9	-	-	225249
9	1	53.4	9	-	-	467279
10	1	59.9	9	-	-	709720
11	1	60.4	9	-	-	951847
12	3	91.4	9	1726	1227	194839
13						
14						
15						
16						
17						
18						
19						
20						

DFS Radar Parameters
FCC Radar Type 5
Channel 60 Bandwidth 20MHz

Trial Number:			23			Detection (Yes/No)
Number of Bursts in Trial:			20			
Chirp Center Frequency:			5302			
Burst	Number of Pulses	Pulse Width (Microseconds)	Chirp Width (MHz)	Pulse 1-to-2 Spacing (µsec)	Pulse 2-to-3 Spacing (µsec)	Starting Location Within Interval (µsec)
1	2	77	20	1363	-	261858
2	1	58.1	20	-	-	407646
3	1	62.1	20	-	-	552319
4	2	76.9	20	1236	-	99107
5	2	80	20	1852	-	243514
6	1	52	20	-	-	389464
7	3	88.6	20	1995	1905	531093
8	2	72.9	20	1387	-	81159
9	3	98.5	20	1746	1389	225245
10	1	57.9	20	-	-	371906
11	3	95.9	20	1870	1066	514197
12	1	53.5	20	-	-	63561
13	3	92	20	1654	1458	207510
14	1	57.3	20	-	-	353638
15	2	70.5	20	1586	-	497515
16	2	70	20	1664	-	45553
17	3	84	20	1630	1176	189821
18	2	76.1	20	1057	-	335330
19	3	93.2	20	1018	1340	478825
20	3	96.8	20	1614	1817	27594

Trial Number:			24			Detection (Yes/No)
Number of Bursts in Trial:			14			
Chirp Center Frequency:			5305			
Burst	Number of Pulses	Pulse Width (Microseconds)	Chirp Width (MHz)	Pulse 1-to-2 Spacing (µsec)	Pulse 2-to-3 Spacing (µsec)	Starting Location Within Interval (µsec)
1	1	50.1	12	-	-	247117
2	3	93.5	12	1081	1413	453362
3	2	68.8	12	1577	-	660875
4	1	56.3	12	-	-	14140
5	3	86	12	1108	1987	220734
6	2	75.2	12	1536	-	428367
7	1	54.4	12	-	-	636681
8	2	71.1	12	1243	-	843157
9	2	76.2	12	1770	-	195585
10	2	80.2	12	1209	-	403231
11	2	79.7	12	1214	-	610202
12	3	90.9	12	1862	1601	815229
13	2	68.7	12	1441	-	170267
14	2	67.4	12	1313	-	377306
15						
16						
17						
18						
19						
20						

DFS Radar Parameters
FCC Radar Type 5
Channel 60 Bandwidth 20MHz

Trial Number:			25			Detection (Yes/No)
Number of Bursts in Trial:			13			
Chirp Center Frequency:			5305			
						Yes
Burst	Number of Pulses	Pulse Width (Microseconds)	Chirp Width (MHz)	Pulse 1-to-2 Spacing (µsec)	Pulse 2-to-3 Spacing (µsec)	Starting Location Within Interval (µsec)
1	3	94	11	1748	1941	628071
2	2	70.8	11	1201	-	853391
3	1	56.3	11	-	-	156223
4	3	96.7	11	1163	1332	378734
5	3	90.6	11	1582	1498	601331
6	2	74.5	11	1281	-	825462
7	3	92.6	11	1669	1222	128265
8	3	89	11	1135	1380	351161
9	3	96.5	11	1822	1602	573425
10	2	70.5	11	1178	-	798431
11	3	94	11	1629	1956	100737
12	1	55.8	11	-	-	324661
13	3	87.7	11	1963	1164	546278
14						
15						
16						
17						
18						
19						
20						

Trial Number:			26			Detection (Yes/No)
Number of Bursts in Trial:			8			
Chirp Center Frequency:			5308			
						Yes
Burst	Number of Pulses	Pulse Width (Microseconds)	Chirp Width (MHz)	Pulse 1-to-2 Spacing (µsec)	Pulse 2-to-3 Spacing (µsec)	Starting Location Within Interval (µsec)
1	2	68.6	5	1161	-	1253842
2	2	83.1	5	1315	-	119486
3	1	60.9	5	-	-	482958
4	2	77.7	5	1158	-	845641
5	2	77.4	5	1510	-	1208428
6	2	66.8	5	1323	-	74748
7	1	63.7	5	-	-	438300
8	3	91.2	5	1681	1275	800152
9						
10						
11						
12						
13						
14						
15						
16						
17						
18						
19						
20						

DFS Radar Parameters
FCC Radar Type 5
Channel 60 Bandwidth 20MHz

Trial Number:		27				Detection (Yes/No)
Number of Bursts in Trial:		17				
Chirp Center Frequency:		5303				Yes
Burst	Number of Pulses	Pulse Width (Microseconds)	Chirp Width (MHz)	Pulse 1-to-2 Spacing (µsec)	Pulse 2-to-3 Spacing (µsec)	Starting Location Within Interval (µsec)
1	3	83.6	16	1195	1000	545865
2	3	89.4	16	1627	1656	14067
3	1	55.8	16	-	-	184953
4	3	90.9	16	1554	1998	353759
5	1	54.7	16	-	-	526388
6	3	97.7	16	1202	1250	694806
7	2	67.5	16	1434	-	163568
8	3	96.7	16	1469	1268	333410
9	2	68.3	16	1954	-	504006
10	2	78.3	16	1082	-	675297
11	1	55	16	-	-	142890
12	3	84.9	16	1936	1199	312479
13	2	74.6	16	1856	-	482953
14	1	63.3	16	-	-	655022
15	3	99.8	16	1515	1120	121457
16	1	63.6	16	-	-	292606
17	3	87.3	16	1051	1831	461322
18						
19						
20						

Trial Number:		28				Detection (Yes/No)
Number of Bursts in Trial:		19				
Chirp Center Frequency:		5302				Yes
Burst	Number of Pulses	Pulse Width (Microseconds)	Chirp Width (MHz)	Pulse 1-to-2 Spacing (µsec)	Pulse 2-to-3 Spacing (µsec)	Starting Location Within Interval (µsec)
1	3	85.6	19	1078	1015	565136
2	2	68.6	19	1780	-	89970
3	1	54.2	19	-	-	243121
4	1	61.2	19	-	-	396034
5	3	97.1	19	1969	1100	546225
6	3	98.3	19	1699	1622	70998
7	1	62.4	19	-	-	224093
8	2	80.2	19	1769	-	376127
9	3	87.5	19	1448	1179	527806
10	3	85.8	19	1348	1472	52247
11	3	88.1	19	1124	1631	204582
12	1	65.3	19	-	-	357941
13	1	52.5	19	-	-	510977
14	1	52.3	19	-	-	33698
15	2	74.1	19	1200	-	186023
16	1	54.9	19	-	-	339327
17	2	76.2	19	1502	-	491053
18	1	60.4	19	-	-	14858
19	2	81.5	19	1103	-	167387
20						

DFS Radar Parameters
FCC Radar Type 5
Channel 60 Bandwidth 20MHz

Trial Number:			29			Detection (Yes/No)
Number of Bursts in Trial:			12			
Chirp Center Frequency:			5306			Yes
Burst	Number of Pulses	Pulse Width (Microseconds)	Chirp Width (MHz)	Pulse 1-to-2 Spacing (µsec)	Pulse 2-to-3 Spacing (µsec)	Starting Location Within Interval (µsec)
1	1	50.5	10	-	-	507709
2	1	55.7	10	-	-	750249
3	3	85.8	10	1002	1967	989003
4	2	76.9	10	1474	-	235634
5	2	75.1	10	1052	-	477675
6	3	92.3	10	1486	1492	718312
7	2	78.1	10	1757	-	960895
8	3	92.2	10	1252	1713	205370
9	3	89	10	1706	1411	446940
10	2	70.9	10	1620	-	689225
11	1	63.1	10	-	-	932305
12	1	55.3	10	-	-	176231
13						
14						
15						
16						
17						
18						
19						
20						

Trial Number:			30			Detection (Yes/No)
Number of Bursts in Trial:			18			
Chirp Center Frequency:			5303			Yes
Burst	Number of Pulses	Pulse Width (Microseconds)	Chirp Width (MHz)	Pulse 1-to-2 Spacing (µsec)	Pulse 2-to-3 Spacing (µsec)	Starting Location Within Interval (µsec)
1	3	83.4	17	1205	1801	277485
2	3	97.3	17	1826	1635	437880
3	3	90.4	17	1986	1674	598445
4	3	91.8	17	1151	1802	97088
5	3	98.2	17	1977	1766	257251
6	1	59.5	17	-	-	419893
7	2	80	17	1137	-	580724
8	3	86.5	17	1128	1828	77366
9	3	91.1	17	1599	1442	238032
10	3	93.5	17	1373	1087	398605
11	1	60.7	17	-	-	562025
12	2	67.2	17	1405	-	57684
13	1	61.8	17	-	-	219083
14	2	79.4	17	1667	-	379234
15	2	81.4	17	1464	-	540896
16	1	65.7	17	-	-	37916
17	2	76	17	1255	-	198794
18	2	81	17	1668	-	359754
19						
20						

DFS Radar Parameters
FCC Radar Type 1
Channel 62 Bandwidth 40MHz

Trial #	Pulse Repetition Frequency Number (1 to 23)	Pulse Repetition Frequency (Pulses Per Second)	Pulse Repetition Interval (Microseconds)	Detection (Yes / No)
1	22	1066.10	938	Yes
2	10	1432.66	698	Yes
3	6	1618.12	618	Yes
4	2	1858.74	538	Yes
5	19	1138.95	878	Yes
6	12	326.16	3066	Yes
7	7	1567.40	638	Yes
8	21	1089.32	918	Yes
9	17	1193.32	838	Yes
10	18	1165.50	858	Yes
11	15	1253.13	798	Yes
12	11	1392.76	718	No
13	4	1730.10	578	Yes
14	5	1672.24	598	Yes
15	3	1792.11	558	Yes
16		394.32	2536	Yes
17		1035.20	966	Yes
18		1209.19	827	Yes
19		399.84	2501	Yes
20		385.36	2595	Yes
21		897.67	1114	Yes
22		768.05	1302	Yes
23		328.41	3045	Yes
24		615.76	1624	Yes
25		347.46	2878	Yes
26		973.71	1027	Yes
27		402.41	2485	Yes
28		625.00	1600	Yes
29		853.24	1172	Yes
30		849.62	1177	Yes

DFS Radar Parameters
FCC Radar Type 2
Channel 62 Bandwidth 40MHz

Trial #	Number Pulses per Burst	Pulse Width (Microseconds)	Pulse Repetition Interval (Microseconds)	Detection (Yes / No)
1	26	3.20	179	Yes
2	23	1.10	207	Yes
3	24	2.10	230	Yes
4	29	4.80	200	Yes
5	28	3.90	214	Yes
6	26	2.90	222	Yes
7	26	3.20	204	Yes
8	25	2.50	192	Yes
9	26	3.10	164	Yes
10	23	1.20	156	Yes
11	27	3.90	210	Yes
12	29	4.60	201	Yes
13	26	3.20	162	Yes
14	25	2.20	197	Yes
15	29	4.50	163	Yes
16	26	3.00	203	Yes
17	29	5.00	168	Yes
18	25	2.40	217	Yes
19	26	2.90	191	Yes
20	25	2.30	166	Yes
21	27	3.70	150	Yes
22	25	2.20	176	Yes
23	29	4.90	195	Yes
24	26	2.90	202	Yes
25	25	2.50	178	Yes
26	23	1.10	206	Yes
27	27	3.80	155	Yes
28	29	4.70	157	Yes
29	25	2.40	224	Yes
30	28	4.20	159	Yes

DFS Radar Parameters
FCC Radar Type 3
Channel 62 Bandwidth 40MHz

Trial #	Number Pulses per Burst	Pulse Width (Microseconds)	Pulse Repetition Interval (Microseconds)	Detection (Yes / No)
1	17	8.20	355	Yes
2	16	6.10	487	Yes
3	16	7.10	344	Yes
4	18	9.80	288	Yes
5	18	8.90	230	Yes
6	17	7.90	432	Yes
7	17	8.20	207	Yes
8	17	7.50	443	Yes
9	17	8.10	439	Yes
10	16	6.20	223	Yes
11	18	8.90	208	Yes
12	18	9.60	463	Yes
13	17	8.20	441	Yes
14	16	7.20	323	Yes
15	18	9.50	297	Yes
16	17	8.00	412	Yes
17	18	10.00	324	Yes
18	17	7.40	271	Yes
19	17	7.90	349	Yes
20	16	7.30	409	Yes
21	18	8.70	373	Yes
22	16	7.20	254	Yes
23	18	9.90	274	Yes
24	17	7.90	278	Yes
25	17	7.50	317	Yes
26	16	6.10	260	Yes
27	18	8.80	211	Yes
28	18	9.70	272	Yes
29	17	7.40	264	Yes
30	18	9.20	284	Yes

DFS Radar Parameters
FCC Radar Type 4
Channel 62 Bandwidth 40MHz

Trial #	Number Pulses per Burst	Pulse Width (Microseconds)	Pulse Repetition Interval (Microseconds)	Detection (Yes / No)
1	14	16.00	355	Yes
2	12	11.30	487	Yes
3	13	13.50	344	Yes
4	16	19.40	288	Yes
5	15	17.50	230	Yes
6	14	15.30	432	Yes
7	14	15.90	207	Yes
8	13	14.30	443	Yes
9	14	15.80	439	Yes
10	12	11.50	223	Yes
11	15	17.40	208	Yes
12	16	19.00	463	Yes
13	14	16.00	441	Yes
14	13	13.80	323	Yes
15	16	18.90	297	Yes
16	14	15.50	412	Yes
17	16	19.90	324	Yes
18	13	14.10	271	Yes
19	14	15.20	349	Yes
20	13	13.80	409	Yes
21	15	17.10	373	Yes
22	13	13.80	254	Yes
23	16	19.80	274	Yes
24	14	15.30	278	Yes
25	13	14.50	317	Yes
26	12	11.30	260	Yes
27	15	17.30	211	Yes
28	16	19.20	272	Yes
29	13	14.20	264	Yes
30	15	18.20	284	Yes

DFS Radar Parameters
FCC Radar Type 5
Channel 62 Bandwidth 40MHz

Trial Number:			1			Detection (Yes/No)
Number of Bursts in Trial:			15			
Chirp Center Frequency:			5310			
Burst	Number of Pulses	Pulse Width (Microseconds)	Chirp Width (MHz)	Pulse 1-to-2 Spacing (µsec)	Pulse 2-to-3 Spacing (µsec)	Starting Location Within Interval (µsec)
1	2	77.8	13	1477	-	636185
2	1	51.9	13	-	-	32674
3	1	63.8	13	-	-	226294
4	3	96.6	13	1786	1843	417976
5	3	85.9	13	1215	1729	611152
6	2	73.7	13	1549	-	8789
7	2	77.2	13	1819	-	201917
8	2	68.4	13	1114	-	395530
9	2	76.7	13	1155	-	588564
10	1	53.2	13	-	-	783794
11	3	85.7	13	1695	1394	177933
12	3	94.3	13	1426	1935	370624
13	2	77.6	13	1671	-	564893
14	1	65.7	13	-	-	759583
15	3	93.5	13	1130	1468	154262
16						
17						
18						
19						
20						

Trial Number:			2			Detection (Yes/No)
Number of Bursts in Trial:			8			
Chirp Center Frequency:			5310			
Burst	Number of Pulses	Pulse Width (Microseconds)	Chirp Width (MHz)	Pulse 1-to-2 Spacing (µsec)	Pulse 2-to-3 Spacing (µsec)	Starting Location Within Interval (µsec)
1	2	75	5	1527	-	653020
2	3	99.4	5	1262	1257	1015643
3	2	67.4	5	1403	-	1379398
4	2	73.6	5	1041	-	245489
5	1	65.9	5	-	-	609113
6	3	83.8	5	1292	1419	970852
7	1	65.5	5	-	-	1335913
8	3	98.6	5	1796	1728	200406
9						
10						
11						
12						
13						
14						
15						
16						
17						
18						
19						
20						

DFS Radar Parameters
FCC Radar Type 5
Channel 62 Bandwidth 40MHz

Trial Number:			3			Detection (Yes/No)
Number of Bursts in Trial:			11			
Chirp Center Frequency:			5310			
Burst	Number of Pulses	Pulse Width (Microseconds)	Chirp Width (MHz)	Pulse 1-to-2 Spacing (µsec)	Pulse 2-to-3 Spacing (µsec)	Starting Location Within Interval (µsec)
1	2	73.8	9	1538	-	409565
2	2	69.5	9	1649	-	673692
3	1	51.9	9	-	-	938562
4	3	84.6	9	1032	1271	113209
5	3	95.4	9	1903	1388	376726
6	2	68	9	1351	-	641212
7	3	89.6	9	1514	1573	903714
8	2	81.9	9	1689	-	80863
9	3	88.3	9	1330	1838	344067
10	1	53.7	9	-	-	609331
11	3	91.3	9	1106	1001	871542
12						
13						
14						
15						
16						
17						
18						
19						
20						

Trial Number:			4			Detection (Yes/No)
Number of Bursts in Trial:			20			
Chirp Center Frequency:			5310			
Burst	Number of Pulses	Pulse Width (Microseconds)	Chirp Width (MHz)	Pulse 1-to-2 Spacing (µsec)	Pulse 2-to-3 Spacing (µsec)	Starting Location Within Interval (µsec)
1	2	68.1	19	1355	-	26541
2	1	58.7	19	-	-	171821
3	2	75.3	19	1640	-	316229
4	1	56.4	19	-	-	461864
5	3	99.7	19	1708	1159	8677
6	1	57.7	19	-	-	153995
7	1	59.5	19	-	-	299238
8	2	80	19	1369	-	443177
9	2	82	19	1197	-	587671
10	2	82.8	19	1005	-	135674
11	3	88	19	1928	1101	279928
12	3	93.2	19	1907	1223	424279
13	2	70.4	19	1360	-	570132
14	3	95.3	19	1955	1775	117439
15	2	81.9	19	1545	-	262502
16	3	98.5	19	1169	1062	406573
17	1	65	19	-	-	553328
18	3	85.4	19	1637	1425	99799
19	3	91.6	19	1445	1325	244095
20	2	67.3	19	1218	-	390012

DFS Radar Parameters
FCC Radar Type 5
Channel 62 Bandwidth 40MHz

Trial Number:			5			Detection (Yes/No)
Number of Bursts in Trial:			17			
Chirp Center Frequency:			5310			Yes
Burst	Number of Pulses	Pulse Width (Microseconds)	Chirp Width (MHz)	Pulse 1-to-2 Spacing (µsec)	Pulse 2-to-3 Spacing (µsec)	Starting Location Within Interval (µsec)
1	2	67.9	16	1133	-	629614
2	1	62.3	16	-	-	96856
3	1	53.3	16	-	-	267719
4	3	90	16	1153	1346	436784
5	2	77.1	16	1646	-	608289
6	3	83.9	16	1232	1459	75610
7	3	89.1	16	1384	1939	245638
8	2	81.8	16	1676	-	416355
9	1	50.3	16	-	-	588736
10	3	87.1	16	1996	1756	54571
11	2	71.3	16	1815	-	225175
12	3	97.5	16	1465	1132	394825
13	3	90.6	16	1040	1354	565361
14	3	86.3	16	1183	1792	33643
15	3	97.6	16	1073	1361	203957
16	3	84.7	16	1718	1854	373812
17	3	99.7	16	1244	1988	544060
18						
19						
20						

Trial Number:			6			Detection (Yes/No)
Number of Bursts in Trial:			14			
Chirp Center Frequency:			5310			Yes
Burst	Number of Pulses	Pulse Width (Microseconds)	Chirp Width (MHz)	Pulse 1-to-2 Spacing (µsec)	Pulse 2-to-3 Spacing (µsec)	Starting Location Within Interval (µsec)
1	3	92.9	12	1564	1407	15438
2	2	67.7	12	1747	-	222486
3	1	65.8	12	-	-	430731
4	1	56.3	12	-	-	637784
5	1	53.7	12	-	-	845342
6	3	83.5	12	1930	1025	196720
7	1	65.8	12	-	-	404955
8	3	85.9	12	1034	1808	610711
9	2	76.3	12	1926	-	818057
10	2	81.5	12	1714	-	171459
11	3	89.4	12	1594	1827	377969
12	1	63.4	12	-	-	586875
13	2	69.6	12	1925	-	792834
14	2	74.5	12	1846	-	146044
15						
16						
17						
18						
19						
20						

DFS Radar Parameters
FCC Radar Type 5
Channel 62 Bandwidth 40MHz

Trial Number:			7			Detection (Yes/No)
Number of Bursts in Trial:			15			
Chirp Center Frequency:			5310			
Burst	Number of Pulses	Pulse Width (Microseconds)	Chirp Width (MHz)	Pulse 1-to-2 Spacing (µsec)	Pulse 2-to-3 Spacing (µsec)	Starting Location Within Interval (µsec)
1	3	96.6	13	1609	1581	329022
2	3	96.7	13	1799	1154	521718
3	3	86.5	13	1396	1865	714222
4	2	73.3	13	1318	-	112450
5	1	55.8	13	-	-	306283
6	1	55.4	13	-	-	500239
7	3	85.3	13	1504	1820	690932
8	2	79.4	13	1893	-	88645
9	1	65.7	13	-	-	282508
10	2	68.6	13	1028	-	475842
11	2	77.7	13	1835	-	667887
12	2	79.6	13	1331	-	64845
13	3	94.9	13	1070	1349	257755
14	1	61.4	13	-	-	452335
15	3	90.6	13	1562	1887	643395
16						
17						
18						
19						
20						

Trial Number:			8			Detection (Yes/No)
Number of Bursts in Trial:			12			
Chirp Center Frequency:			5310			
Burst	Number of Pulses	Pulse Width (Microseconds)	Chirp Width (MHz)	Pulse 1-to-2 Spacing (µsec)	Pulse 2-to-3 Spacing (µsec)	Starting Location Within Interval (µsec)
1	1	52.6	10	-	-	51446
2	3	84.1	10	1725	1529	292696
3	3	97.7	10	1868	1805	533989
4	3	97.3	10	1446	1755	775564
5	3	98.8	10	1386	1302	21542
6	2	72.2	10	1184	-	263385
7	2	67.6	10	1027	-	505581
8	2	75.7	10	1871	-	747058
9	1	60.9	10	-	-	989976
10	1	64.2	10	-	-	234024
11	2	78.8	10	1604	-	475207
12	3	87.5	10	1712	1683	715825
13						
14						
15						
16						
17						
18						
19						
20						

DFS Radar Parameters
FCC Radar Type 5
Channel 62 Bandwidth 40MHz

Trial Number:			9			Detection (Yes/No)
Number of Bursts in Trial:			14			
Chirp Center Frequency:			5310			
Burst	Number of Pulses	Pulse Width (Microseconds)	Chirp Width (MHz)	Pulse 1-to-2 Spacing (µsec)	Pulse 2-to-3 Spacing (µsec)	Starting Location Within Interval (µsec)
1	1	54.1	13	-	-	823112
2	1	50.7	13	-	-	174965
3	1	52.3	13	-	-	382216
4	3	99.8	13	1696	1949	587395
5	2	68.4	13	1099	-	796897
6	2	80.8	13	1505	-	149042
7	1	62.5	13	-	-	356750
8	2	74.8	13	1204	-	563824
9	1	50.8	13	-	-	772314
10	1	54	13	-	-	123796
11	1	63	13	-	-	331215
12	3	91.8	13	1270	1347	537402
13	2	79.3	13	1992	-	744805
14	1	64.3	13	-	-	98172
15						
16						
17						
18						
19						
20						

Trial Number:			10			Detection (Yes/No)
Number of Bursts in Trial:			8			
Chirp Center Frequency:			5310			
Burst	Number of Pulses	Pulse Width (Microseconds)	Chirp Width (MHz)	Pulse 1-to-2 Spacing (µsec)	Pulse 2-to-3 Spacing (µsec)	Starting Location Within Interval (µsec)
1	1	63.4	6	-	-	535615
2	1	52	6	-	-	898668
3	3	97.2	6	1605	1583	1259235
4	2	78.7	6	1743	-	127106
5	2	74.2	6	1219	-	490358
6	3	88.7	6	1934	1273	852409
7	1	54.3	6	-	-	1217152
8	3	95.4	6	1555	1791	82296
9						
10						
11						
12						
13						
14						
15						
16						
17						
18						
19						
20						

DFS Radar Parameters
FCC Radar Type 5
Channel 62 Bandwidth 40MHz

Trial Number:			11			Detection (Yes/No)
Number of Bursts in Trial:			17			
Chirp Center Frequency:			5297			
Burst	Number of Pulses	Pulse Width (Microseconds)	Chirp Width (MHz)	Pulse 1-to-2 Spacing (µsec)	Pulse 2-to-3 Spacing (µsec)	Starting Location Within Interval (µsec)
1	2	73.7	16	1497	-	209249
2	3	97.4	16	1754	1613	378386
3	3	91.7	16	1702	1462	548411
4	1	66.2	16	-	-	17733
5	2	70.8	16	1821	-	187952
6	1	52.3	16	-	-	359277
7	2	78.9	16	1984	-	528886
8	2	70.9	16	1358	-	700166
9	2	75.6	16	1430	-	167197
10	1	59.1	16	-	-	338262
11	2	77	16	1304	-	508324
12	2	67.9	16	1083	-	678689
13	2	81.2	16	1932	-	146031
14	2	78.7	16	1121	-	316923
15	1	63.3	16	-	-	488056
16	2	68.9	16	1423	-	657326
17	1	59.3	16	-	-	125509
18						
19						
20						

Trial Number:			12			Detection (Yes/No)
Number of Bursts in Trial:			19			
Chirp Center Frequency:			5299			
Burst	Number of Pulses	Pulse Width (Microseconds)	Chirp Width (MHz)	Pulse 1-to-2 Spacing (µsec)	Pulse 2-to-3 Spacing (µsec)	Starting Location Within Interval (µsec)
1	3	98.9	19	1680	1488	263736
2	2	82.3	19	1855	-	416459
3	3	86.7	19	1400	1919	567902
4	3	89.7	19	1068	1282	92979
5	3	98.6	19	1194	1461	245155
6	2	71.1	19	1789	-	397609
7	1	55.9	19	-	-	551431
8	2	67.9	19	1372	-	74413
9	3	84.4	19	1107	1443	226559
10	1	58.8	19	-	-	380056
11	1	65.6	19	-	-	533408
12	2	78.5	19	1704	-	55547
13	2	82.3	19	1686	-	207876
14	3	90.1	19	1071	1266	359771
15	3	90.2	19	1089	1950	511297
16	2	83.1	19	1406	-	36803
17	1	58.8	19	-	-	189652
18	2	77	19	1657	-	341809
19	1	55	19	-	-	495737
20						

DFS Radar Parameters
FCC Radar Type 5
Channel 62 Bandwidth 40MHz

Trial Number:		13				Detection (Yes/No)
Number of Bursts in Trial:		15				
Chirp Center Frequency:		5296				
Burst	Number of Pulses	Pulse Width (Microseconds)	Chirp Width (MHz)	Pulse 1-to-2 Spacing (µsec)	Pulse 2-to-3 Spacing (µsec)	Starting Location Within Interval (µsec)
1	1	58.1	13	-	-	22911
2	1	52.1	13	-	-	216473
3	1	59.9	13	-	-	410004
4	1	60.2	13	-	-	603671
5	3	95.9	13	1906	1608	794160
6	2	79.9	13	1859	-	192251
7	2	78.5	13	1917	-	385590
8	1	53.8	13	-	-	579862
9	1	64.7	13	-	-	773423
10	1	61.4	13	-	-	168898
11	2	83.2	13	1858	-	361606
12	3	84.7	13	1677	1638	553866
13	3	88.7	13	1528	1058	747241
14	2	78.3	13	1951	-	144710
15	2	69.3	13	1717	-	337856
16						
17						
18						
19						
20						

Trial Number:		14				Detection (Yes/No)
Number of Bursts in Trial:		12				
Chirp Center Frequency:		5295				
Burst	Number of Pulses	Pulse Width (Microseconds)	Chirp Width (MHz)	Pulse 1-to-2 Spacing (µsec)	Pulse 2-to-3 Spacing (µsec)	Starting Location Within Interval (µsec)
1	2	75.3	10	1612	-	664275
2	1	56.3	10	-	-	907886
3	2	67.7	10	1185	-	151316
4	1	55.6	10	-	-	393746
5	2	75.2	10	1267	-	635093
6	2	76.3	10	1305	-	876993
7	3	85.7	10	1362	1924	121278
8	3	98.4	10	1550	1249	362696
9	3	86.4	10	1439	1046	604342
10	3	93.6	10	1031	1452	846453
11	1	63.3	10	-	-	91871
12	3	92.4	10	1673	1322	333050
13						
14						
15						
16						
17						
18						
19						
20						

DFS Radar Parameters
FCC Radar Type 5
Channel 62 Bandwidth 40MHz

Trial Number:			15			Detection (Yes/No)
Number of Bursts in Trial:			19			
Chirp Center Frequency:			5298			
Burst	Number of Pulses	Pulse Width (Microseconds)	Chirp Width (MHz)	Pulse 1-to-2 Spacing (µsec)	Pulse 2-to-3 Spacing (µsec)	Starting Location Within Interval (µsec)
1	3	93.3	18	1912	1535	361323
2	2	69.1	18	1794	-	515261
3	3	86.9	18	1152	1148	39025
4	3	84.9	18	1948	1118	190900
5	2	72.3	18	1916	-	343941
6	1	51.7	18	-	-	497624
7	1	58.3	18	-	-	20319
8	1	60.8	18	-	-	172999
9	1	57.1	18	-	-	325872
10	3	88.9	18	1964	1489	475841
11	2	72	18	1297	-	1489
12	3	90.9	18	1566	1370	153647
13	1	59.8	18	-	-	307096
14	2	70	18	1291	-	458804
15	2	67.2	18	1881	-	610798
16	3	91.2	18	1832	1661	134759
17	1	56.5	18	-	-	288306
18	1	51.2	18	-	-	441296
19	2	74.1	18	1245	-	592780
20						

Trial Number:			16			Detection (Yes/No)
Number of Bursts in Trial:			14			
Chirp Center Frequency:			5296			
Burst	Number of Pulses	Pulse Width (Microseconds)	Chirp Width (MHz)	Pulse 1-to-2 Spacing (µsec)	Pulse 2-to-3 Spacing (µsec)	Starting Location Within Interval (µsec)
1	2	76.9	12	1140	-	158286
2	1	50.2	12	-	-	366024
3	1	62.9	12	-	-	573452
4	1	64.7	12	-	-	780619
5	3	83.8	12	1097	1621	132455
6	1	65.4	12	-	-	340207
7	1	53.2	12	-	-	548208
8	1	51.7	12	-	-	755333
9	2	78.7	12	1168	-	107117
10	2	72.4	12	1343	-	314500
11	1	53.8	12	-	-	522447
12	2	73.6	12	1553	-	728517
13	2	66.7	12	1122	-	81611
14	2	82.5	12	1019	-	288948
15						
16						
17						
18						
19						
20						

DFS Radar Parameters
FCC Radar Type 5
Channel 62 Bandwidth 40MHz

Trial Number:			17			Detection (Yes/No)
Number of Bursts in Trial:			20			
Chirp Center Frequency:			5299			
Burst	Number of Pulses	Pulse Width (Microseconds)	Chirp Width (MHz)	Pulse 1-to-2 Spacing (µsec)	Pulse 2-to-3 Spacing (µsec)	Starting Location Within Interval (µsec)
1	3	87.6	20	1055	1840	345766
2	3	85.2	20	1541	1408	490019
3	3	84.8	20	1889	1463	39073
4	2	77.9	20	1460	-	183923
5	2	76.5	20	1485	-	328777
6	1	60.9	20	-	-	474728
7	2	83	20	1010	-	21394
8	2	80.4	20	1752	-	165992
9	2	67.5	20	1181	-	310973
10	1	62.1	20	-	-	456884
11	3	86.4	20	1966	1263	3515
12	3	84.3	20	1188	1788	147928
13	2	76.9	20	1537	-	293225
14	3	95.8	20	1298	1844	436922
15	1	55.2	20	-	-	584015
16	1	59	20	-	-	130832
17	3	94.5	20	1700	1283	274684
18	3	91.9	20	1978	1165	418579
19	3	85.2	20	1551	1189	563464
20	2	69.5	20	1224	-	112787

Trial Number:			18			Detection (Yes/No)
Number of Bursts in Trial:			12			
Chirp Center Frequency:			5295			
Burst	Number of Pulses	Pulse Width (Microseconds)	Chirp Width (MHz)	Pulse 1-to-2 Spacing (µsec)	Pulse 2-to-3 Spacing (µsec)	Starting Location Within Interval (µsec)
1	3	86.4	10	1918	1455	429224
2	3	92.2	10	1719	1895	670241
3	2	80.4	10	1899	-	912880
4	1	54.3	10	-	-	158603
5	1	53.1	10	-	-	400824
6	2	69.4	10	1546	-	641915
7	2	69.1	10	1639	-	883823
8	3	100	10	1438	1595	128373
9	2	79.6	10	1705	-	370379
10	3	88.4	10	1579	1623	611194
11	1	53.3	10	-	-	855665
12	1	65.3	10	-	-	98897
13						
14						
15						
16						
17						
18						
19						
20						

DFS Radar Parameters
FCC Radar Type 5
Channel 62 Bandwidth 40MHz

Trial Number:			19			Detection (Yes/No)
Number of Bursts in Trial:			14			
Chirp Center Frequency:			5296			
Burst	Number of Pulses	Pulse Width (Microseconds)	Chirp Width (MHz)	Pulse 1-to-2 Spacing (µsec)	Pulse 2-to-3 Spacing (µsec)	Starting Location Within Interval (µsec)
1	1	55.3	12	-	-	292143
2	1	58.3	12	-	-	499633
3	2	72.3	12	1039	-	706377
4	3	84.8	12	1761	1721	58989
5	2	82.5	12	1431	-	266161
6	1	63.3	12	-	-	474469
7	2	80	12	1913	-	680544
8	3	90.3	12	1853	1123	33519
9	3	91.1	12	1783	1172	240319
10	3	96.6	12	1036	1385	447400
11	2	82.7	12	1990	-	654516
12	1	50.7	12	-	-	8083
13	2	78.4	12	1109	-	215435
14	3	99.5	12	1965	1869	421325
15						
16						
17						
18						
19						
20						

Trial Number:			20			Detection (Yes/No)
Number of Bursts in Trial:			12			
Chirp Center Frequency:			5295			
Burst	Number of Pulses	Pulse Width (Microseconds)	Chirp Width (MHz)	Pulse 1-to-2 Spacing (µsec)	Pulse 2-to-3 Spacing (µsec)	Starting Location Within Interval (µsec)
1	3	88.6	10	1067	1927	733725
2	1	57.4	10	-	-	977882
3	3	96.6	10	1658	1324	221197
4	2	69.7	10	1945	-	462915
5	2	77.9	10	1317	-	705071
6	1	62	10	-	-	947923
7	3	88.4	10	1077	1366	191373
8	3	97.3	10	1896	1367	432561
9	3	96.2	10	1787	1672	674004
10	3	95.4	10	1892	1414	915842
11	1	54.8	10	-	-	162176
12	2	80.4	10	1436	-	403553
13						
14						
15						
16						
17						
18						
19						
20						

DFS Radar Parameters
FCC Radar Type 5
Channel 62 Bandwidth 40MHz

Trial Number:			21			Detection (Yes/No)
Number of Bursts in Trial:			16			
Chirp Center Frequency:			5323			
Burst	Number of Pulses	Pulse Width (Microseconds)	Chirp Width (MHz)	Pulse 1-to-2 Spacing (µsec)	Pulse 2-to-3 Spacing (µsec)	Starting Location Within Interval (µsec)
1	2	74.7	15	1611	-	483470
2	1	57.1	15	-	-	666072
3	3	91.9	15	1475	1276	98810
4	2	83.1	15	1772	-	279914
5	1	50.7	15	-	-	462536
6	2	79.2	15	1600	-	642324
7	1	58.7	15	-	-	76831
8	2	71	15	1567	-	257785
9	2	79	15	1960	-	438554
10	2	68.5	15	1428	-	620397
11	2	73.5	15	1352	-	54310
12	2	70.5	15	1115	-	235506
13	2	76.6	15	1300	-	417036
14	2	81.2	15	1675	-	597974
15	1	61.8	15	-	-	32086
16	3	94.9	15	1206	1860	212751
17						
18						
19						
20						

Trial Number:			22			Detection (Yes/No)
Number of Bursts in Trial:			12			
Chirp Center Frequency:			5325			
Burst	Number of Pulses	Pulse Width (Microseconds)	Chirp Width (MHz)	Pulse 1-to-2 Spacing (µsec)	Pulse 2-to-3 Spacing (µsec)	Starting Location Within Interval (µsec)
1	2	78.5	9	1698	-	526149
2	3	89.8	9	1962	1167	767135
3	1	59.4	9	-	-	12955
4	2	79.6	9	1890	-	254612
5	2	76	9	1811	-	496588
6	1	53.6	9	-	-	739728
7	2	80.9	9	1053	-	980872
8	1	61.6	9	-	-	225249
9	1	53.4	9	-	-	467279
10	1	59.9	9	-	-	709720
11	1	60.4	9	-	-	951847
12	3	91.4	9	1726	1227	194839
13						
14						
15						
16						
17						
18						
19						
20						

DFS Radar Parameters
FCC Radar Type 5
Channel 62 Bandwidth 40MHz

Trial Number:		23				Detection (Yes/No)
Number of Bursts in Trial:		20				
Chirp Center Frequency:		5321				
Burst	Number of Pulses	Pulse Width (Microseconds)	Chirp Width (MHz)	Pulse 1-to-2 Spacing (µsec)	Pulse 2-to-3 Spacing (µsec)	Starting Location Within Interval (µsec)
1	2	77	20	1363	-	261858
2	1	58.1	20	-	-	407646
3	1	62.1	20	-	-	552319
4	2	76.9	20	1236	-	99107
5	2	80	20	1852	-	243514
6	1	52	20	-	-	389464
7	3	88.6	20	1995	1905	531093
8	2	72.9	20	1387	-	81159
9	3	98.5	20	1746	1389	225245
10	1	57.9	20	-	-	371906
11	3	95.9	20	1870	1066	514197
12	1	53.5	20	-	-	63561
13	3	92	20	1654	1458	207510
14	1	57.3	20	-	-	353638
15	2	70.5	20	1586	-	497515
16	2	70	20	1664	-	45553
17	3	84	20	1630	1176	189821
18	2	76.1	20	1057	-	335330
19	3	93.2	20	1018	1340	478825
20	3	96.8	20	1614	1817	27594

Trial Number:		24				Detection (Yes/No)
Number of Bursts in Trial:		14				
Chirp Center Frequency:		5324				
Burst	Number of Pulses	Pulse Width (Microseconds)	Chirp Width (MHz)	Pulse 1-to-2 Spacing (µsec)	Pulse 2-to-3 Spacing (µsec)	Starting Location Within Interval (µsec)
1	1	50.1	12	-	-	247117
2	3	93.5	12	1081	1413	453362
3	2	68.8	12	1577	-	660875
4	1	56.3	12	-	-	14140
5	3	86	12	1108	1987	220734
6	2	75.2	12	1536	-	428367
7	1	54.4	12	-	-	636681
8	2	71.1	12	1243	-	843157
9	2	76.2	12	1770	-	195585
10	2	80.2	12	1209	-	403231
11	2	79.7	12	1214	-	610202
12	3	90.9	12	1862	1601	815229
13	2	68.7	12	1441	-	170267
14	2	67.4	12	1313	-	377306
15						
16						
17						
18						
19						
20						

DFS Radar Parameters
FCC Radar Type 5
Channel 62 Bandwidth 40MHz

Trial Number:			25			Detection (Yes/No)
Number of Bursts in Trial:			13			
Chirp Center Frequency:			5325			
Burst	Number of Pulses	Pulse Width (Microseconds)	Chirp Width (MHz)	Pulse 1-to-2 Spacing (µsec)	Pulse 2-to-3 Spacing (µsec)	Starting Location Within Interval (µsec)
1	3	94	11	1748	1941	628071
2	2	70.8	11	1201	-	853391
3	1	56.3	11	-	-	156223
4	3	96.7	11	1163	1332	378734
5	3	90.6	11	1582	1498	601331
6	2	74.5	11	1281	-	825462
7	3	92.6	11	1669	1222	128265
8	3	89	11	1135	1380	351161
9	3	96.5	11	1822	1602	573425
10	2	70.5	11	1178	-	798431
11	3	94	11	1629	1956	100737
12	1	55.8	11	-	-	324661
13	3	87.7	11	1963	1164	546278
14						
15						
16						
17						
18						
19						
20						

Trial Number:			26			Detection (Yes/No)
Number of Bursts in Trial:			8			
Chirp Center Frequency:			5327			
Burst	Number of Pulses	Pulse Width (Microseconds)	Chirp Width (MHz)	Pulse 1-to-2 Spacing (µsec)	Pulse 2-to-3 Spacing (µsec)	Starting Location Within Interval (µsec)
1	2	68.6	5	1161	-	1253842
2	2	83.1	5	1315	-	119486
3	1	60.9	5	-	-	482958
4	2	77.7	5	1158	-	845641
5	2	77.4	5	1510	-	1208428
6	2	66.8	5	1323	-	74748
7	1	63.7	5	-	-	438300
8	3	91.2	5	1681	1275	800152
9						
10						
11						
12						
13						
14						
15						
16						
17						
18						
19						
20						

DFS Radar Parameters
FCC Radar Type 5
Channel 62 Bandwidth 40MHz

Trial Number:		27				Detection (Yes/No)
Number of Bursts in Trial:		17				
Chirp Center Frequency:		5323				
Burst	Number of Pulses	Pulse Width (Microseconds)	Chirp Width (MHz)	Pulse 1-to-2 Spacing (µsec)	Pulse 2-to-3 Spacing (µsec)	Starting Location Within Interval (µsec)
1	3	83.6	16	1195	1000	545865
2	3	89.4	16	1627	1656	14067
3	1	55.8	16	-	-	184953
4	3	90.9	16	1554	1998	353759
5	1	54.7	16	-	-	526388
6	3	97.7	16	1202	1250	694806
7	2	67.5	16	1434	-	163568
8	3	96.7	16	1469	1268	333410
9	2	68.3	16	1954	-	504006
10	2	78.3	16	1082	-	675297
11	1	55	16	-	-	142890
12	3	84.9	16	1936	1199	312479
13	2	74.6	16	1856	-	482953
14	1	63.3	16	-	-	655022
15	3	99.8	16	1515	1120	121457
16	1	63.6	16	-	-	292606
17	3	87.3	16	1051	1831	461322
18						
19						
20						

Trial Number:		28				Detection (Yes/No)
Number of Bursts in Trial:		19				
Chirp Center Frequency:		5321				
Burst	Number of Pulses	Pulse Width (Microseconds)	Chirp Width (MHz)	Pulse 1-to-2 Spacing (µsec)	Pulse 2-to-3 Spacing (µsec)	Starting Location Within Interval (µsec)
1	3	85.6	19	1078	1015	565136
2	2	68.6	19	1780	-	89970
3	1	54.2	19	-	-	243121
4	1	61.2	19	-	-	396034
5	3	97.1	19	1969	1100	546225
6	3	98.3	19	1699	1622	70998
7	1	62.4	19	-	-	224093
8	2	80.2	19	1769	-	376127
9	3	87.5	19	1448	1179	527806
10	3	85.8	19	1348	1472	52247
11	3	88.1	19	1124	1631	204582
12	1	65.3	19	-	-	357941
13	1	52.5	19	-	-	510977
14	1	52.3	19	-	-	33698
15	2	74.1	19	1200	-	186023
16	1	54.9	19	-	-	339327
17	2	76.2	19	1502	-	491053
18	1	60.4	19	-	-	14858
19	2	81.5	19	1103	-	167387
20						

DFS Radar Parameters
FCC Radar Type 5
Channel 62 Bandwidth 40MHz

Trial Number:			29			Detection (Yes/No)
Number of Bursts in Trial:			12			
Chirp Center Frequency:			5325			
Burst	Number of Pulses	Pulse Width (Microseconds)	Chirp Width (MHz)	Pulse 1-to-2 Spacing (µsec)	Pulse 2-to-3 Spacing (µsec)	Starting Location Within Interval (µsec)
1	1	50.5	10	-	-	507709
2	1	55.7	10	-	-	750249
3	3	85.8	10	1002	1967	989003
4	2	76.9	10	1474	-	235634
5	2	75.1	10	1052	-	477675
6	3	92.3	10	1486	1492	718312
7	2	78.1	10	1757	-	960895
8	3	92.2	10	1252	1713	205370
9	3	89	10	1706	1411	446940
10	2	70.9	10	1620	-	689225
11	1	63.1	10	-	-	932305
12	1	55.3	10	-	-	176231
13						
14						
15						
16						
17						
18						
19						
20						

Trial Number:			30			Detection (Yes/No)
Number of Bursts in Trial:			18			
Chirp Center Frequency:			5322			
Burst	Number of Pulses	Pulse Width (Microseconds)	Chirp Width (MHz)	Pulse 1-to-2 Spacing (µsec)	Pulse 2-to-3 Spacing (µsec)	Starting Location Within Interval (µsec)
1	3	83.4	17	1205	1801	277485
2	3	97.3	17	1826	1635	437880
3	3	90.4	17	1986	1674	598445
4	3	91.8	17	1151	1802	97088
5	3	98.2	17	1977	1766	257251
6	1	59.5	17	-	-	419893
7	2	80	17	1137	-	580724
8	3	86.5	17	1128	1828	77366
9	3	91.1	17	1599	1442	238032
10	3	93.5	17	1373	1087	398605
11	1	60.7	17	-	-	562025
12	2	67.2	17	1405	-	57684
13	1	61.8	17	-	-	219083
14	2	79.4	17	1667	-	379234
15	2	81.4	17	1464	-	540896
16	1	65.7	17	-	-	37916
17	2	76	17	1255	-	198794
18	2	81	17	1668	-	359754
19						
20						

DFS Radar Parameters
FCC Radar Type 1
Channel 58 Bandwidth 80MHz

Trial #	Pulse Repetition Frequency Number (1 to 23)	Pulse Repetition Frequency (Pulses Per Second)	Pulse Repetition Interval (Microseconds)	Detection (Yes / No)
1	22	1066.10	938	Yes
2	10	1432.66	698	Yes
3	6	1618.12	618	Yes
4	2	1858.74	538	Yes
5	19	1138.95	878	Yes
6	12	326.16	3066	Yes
7	7	1567.40	638	Yes
8	21	1089.32	918	Yes
9	17	1193.32	838	Yes
10	18	1165.50	858	Yes
11	15	1253.13	798	Yes
12	11	1392.76	718	No
13	4	1730.10	578	Yes
14	5	1672.24	598	Yes
15	3	1792.11	558	Yes
16		394.32	2536	Yes
17		1035.20	966	Yes
18		1209.19	827	Yes
19		399.84	2501	Yes
20		385.36	2595	Yes
21		897.67	1114	Yes
22		768.05	1302	Yes
23		328.41	3045	Yes
24		615.76	1624	Yes
25		347.46	2878	Yes
26		973.71	1027	Yes
27		402.41	2485	Yes
28		625.00	1600	Yes
29		853.24	1172	Yes
30		849.62	1177	Yes

DFS Radar Parameters
FCC Radar Type 2
Channel 58 Bandwidth 80MHz

Trial #	Number Pulses per Burst	Pulse Width (Microseconds)	Pulse Repetition Interval (Microseconds)	Detection (Yes / No)
1	26	3.20	179	Yes
2	23	1.10	207	Yes
3	24	2.10	230	Yes
4	29	4.80	200	Yes
5	28	3.90	214	Yes
6	26	2.90	222	Yes
7	26	3.20	204	Yes
8	25	2.50	192	Yes
9	26	3.10	164	Yes
10	23	1.20	156	Yes
11	27	3.90	210	Yes
12	29	4.60	201	Yes
13	26	3.20	162	Yes
14	25	2.20	197	Yes
15	29	4.50	163	Yes
16	26	3.00	203	Yes
17	29	5.00	168	Yes
18	25	2.40	217	Yes
19	26	2.90	191	Yes
20	25	2.30	166	Yes
21	27	3.70	150	Yes
22	25	2.20	176	Yes
23	29	4.90	195	Yes
24	26	2.90	202	Yes
25	25	2.50	178	Yes
26	23	1.10	206	Yes
27	27	3.80	155	Yes
28	29	4.70	157	Yes
29	25	2.40	224	Yes
30	28	4.20	159	Yes

DFS Radar Parameters
FCC Radar Type 3
Channel 58 Bandwidth 80MHz

Trial #	Number Pulses per Burst	Pulse Width (Microseconds)	Pulse Repetition Interval (Microseconds)	Detection (Yes / No)
1	17	8.20	355	Yes
2	16	6.10	487	Yes
3	16	7.10	344	Yes
4	18	9.80	288	Yes
5	18	8.90	230	Yes
6	17	7.90	432	Yes
7	17	8.20	207	Yes
8	17	7.50	443	Yes
9	17	8.10	439	Yes
10	16	6.20	223	Yes
11	18	8.90	208	Yes
12	18	9.60	463	Yes
13	17	8.20	441	Yes
14	16	7.20	323	Yes
15	18	9.50	297	Yes
16	17	8.00	412	Yes
17	18	10.00	324	Yes
18	17	7.40	271	Yes
19	17	7.90	349	Yes
20	16	7.30	409	Yes
21	18	8.70	373	Yes
22	16	7.20	254	Yes
23	18	9.90	274	Yes
24	17	7.90	278	Yes
25	17	7.50	317	Yes
26	16	6.10	260	Yes
27	18	8.80	211	Yes
28	18	9.70	272	Yes
29	17	7.40	264	Yes
30	18	9.20	284	Yes

DFS Radar Parameters
FCC Radar Type 4
Channel 58 Bandwidth 80MHz

Trial #	Number Pulses per Burst	Pulse Width (Microseconds)	Pulse Repetition Interval (Microseconds)	Detection (Yes / No)
1	14	16.00	355	Yes
2	12	11.30	487	Yes
3	13	13.50	344	Yes
4	16	19.40	288	Yes
5	15	17.50	230	Yes
6	14	15.30	432	Yes
7	14	15.90	207	Yes
8	13	14.30	443	Yes
9	14	15.80	439	Yes
10	12	11.50	223	Yes
11	15	17.40	208	Yes
12	16	19.00	463	Yes
13	14	16.00	441	Yes
14	13	13.80	323	Yes
15	16	18.90	297	Yes
16	14	15.50	412	Yes
17	16	19.90	324	Yes
18	13	14.10	271	Yes
19	14	15.20	349	Yes
20	13	13.80	409	Yes
21	15	17.10	373	Yes
22	13	13.80	254	Yes
23	16	19.80	274	Yes
24	14	15.30	278	Yes
25	13	14.50	317	Yes
26	12	11.30	260	Yes
27	15	17.30	211	Yes
28	16	19.20	272	Yes
29	13	14.20	264	Yes
30	15	18.20	284	Yes

DFS Radar Parameters
FCC Radar Type 5
Channel 58 Bandwidth 80MHz

Trial Number:			1			Detection (Yes/No)
Number of Bursts in Trial:			15			
Chirp Center Frequency:			5290			
Burst	Number of Pulses	Pulse Width (Microseconds)	Chirp Width (MHz)	Pulse 1-to-2 Spacing (µsec)	Pulse 2-to-3 Spacing (µsec)	Starting Location Within Interval (µsec)
1	2	77.8	13	1477	-	636185
2	1	51.9	13	-	-	32674
3	1	63.8	13	-	-	226294
4	3	96.6	13	1786	1843	417976
5	3	85.9	13	1215	1729	611152
6	2	73.7	13	1549	-	8789
7	2	77.2	13	1819	-	201917
8	2	68.4	13	1114	-	395530
9	2	76.7	13	1155	-	588564
10	1	53.2	13	-	-	783794
11	3	85.7	13	1695	1394	177933
12	3	94.3	13	1426	1935	370624
13	2	77.6	13	1671	-	564893
14	1	65.7	13	-	-	759583
15	3	93.5	13	1130	1468	154262
16						
17						
18						
19						
20						

Trial Number:			2			Detection (Yes/No)
Number of Bursts in Trial:			8			
Chirp Center Frequency:			5290			
Burst	Number of Pulses	Pulse Width (Microseconds)	Chirp Width (MHz)	Pulse 1-to-2 Spacing (µsec)	Pulse 2-to-3 Spacing (µsec)	Starting Location Within Interval (µsec)
1	2	75	5	1527	-	653020
2	3	99.4	5	1262	1257	1015643
3	2	67.4	5	1403	-	1379398
4	2	73.6	5	1041	-	245489
5	1	65.9	5	-	-	609113
6	3	83.8	5	1292	1419	970852
7	1	65.5	5	-	-	1335913
8	3	98.6	5	1796	1728	200406
9						
10						
11						
12						
13						
14						
15						
16						
17						
18						
19						
20						

DFS Radar Parameters
FCC Radar Type 5
Channel 58 Bandwidth 80MHz

Trial Number:			3			Detection (Yes/No) Yes
Number of Bursts in Trial:			11			
Chirp Center Frequency:			5290			
Burst	Number of Pulses	Pulse Width (Microseconds)	Chirp Width (MHz)	Pulse 1-to-2 Spacing (µsec)	Pulse 2-to-3 Spacing (µsec)	Starting Location Within Interval (µsec)
1	2	73.8	9	1538	-	409565
2	2	69.5	9	1649	-	673692
3	1	51.9	9	-	-	938562
4	3	84.6	9	1032	1271	113209
5	3	95.4	9	1903	1388	376726
6	2	68	9	1351	-	641212
7	3	89.6	9	1514	1573	903714
8	2	81.9	9	1689	-	80863
9	3	88.3	9	1330	1838	344067
10	1	53.7	9	-	-	609331
11	3	91.3	9	1106	1001	871542
12						
13						
14						
15						
16						
17						
18						
19						
20						

Trial Number:			4			Detection (Yes/No) Yes
Number of Bursts in Trial:			20			
Chirp Center Frequency:			5290			
Burst	Number of Pulses	Pulse Width (Microseconds)	Chirp Width (MHz)	Pulse 1-to-2 Spacing (µsec)	Pulse 2-to-3 Spacing (µsec)	Starting Location Within Interval (µsec)
1	2	68.1	19	1355	-	26541
2	1	58.7	19	-	-	171821
3	2	75.3	19	1640	-	316229
4	1	56.4	19	-	-	461864
5	3	99.7	19	1708	1159	8677
6	1	57.7	19	-	-	153995
7	1	59.5	19	-	-	299238
8	2	80	19	1369	-	443177
9	2	82	19	1197	-	587671
10	2	82.8	19	1005	-	135674
11	3	88	19	1928	1101	279928
12	3	93.2	19	1907	1223	424279
13	2	70.4	19	1360	-	570132
14	3	95.3	19	1955	1775	117439
15	2	81.9	19	1545	-	262502
16	3	98.5	19	1169	1062	406573
17	1	65	19	-	-	553328
18	3	85.4	19	1637	1425	99799
19	3	91.6	19	1445	1325	244095
20	2	67.3	19	1218	-	390012

DFS Radar Parameters
FCC Radar Type 5
Channel 58 Bandwidth 80MHz

Trial Number:			5			Detection (Yes/No)
Number of Bursts in Trial:			17			
Chirp Center Frequency:			5290			Yes
Burst	Number of Pulses	Pulse Width (Microseconds)	Chirp Width (MHz)	Pulse 1-to-2 Spacing (µsec)	Pulse 2-to-3 Spacing (µsec)	Starting Location Within Interval (µsec)
1	2	67.9	16	1133	-	629614
2	1	62.3	16	-	-	96856
3	1	53.3	16	-	-	267719
4	3	90	16	1153	1346	436784
5	2	77.1	16	1646	-	608289
6	3	83.9	16	1232	1459	75610
7	3	89.1	16	1384	1939	245638
8	2	81.8	16	1676	-	416355
9	1	50.3	16	-	-	588736
10	3	87.1	16	1996	1756	54571
11	2	71.3	16	1815	-	225175
12	3	97.5	16	1465	1132	394825
13	3	90.6	16	1040	1354	565361
14	3	86.3	16	1183	1792	33643
15	3	97.6	16	1073	1361	203957
16	3	84.7	16	1718	1854	373812
17	3	99.7	16	1244	1988	544060
18						
19						
20						

Trial Number:			6			Detection (Yes/No)
Number of Bursts in Trial:			14			
Chirp Center Frequency:			5290			Yes
Burst	Number of Pulses	Pulse Width (Microseconds)	Chirp Width (MHz)	Pulse 1-to-2 Spacing (µsec)	Pulse 2-to-3 Spacing (µsec)	Starting Location Within Interval (µsec)
1	3	92.9	12	1564	1407	15438
2	2	67.7	12	1747	-	222486
3	1	65.8	12	-	-	430731
4	1	56.3	12	-	-	637784
5	1	53.7	12	-	-	845342
6	3	83.5	12	1930	1025	196720
7	1	65.8	12	-	-	404955
8	3	85.9	12	1034	1808	610711
9	2	76.3	12	1926	-	818057
10	2	81.5	12	1714	-	171459
11	3	89.4	12	1594	1827	377969
12	1	63.4	12	-	-	586875
13	2	69.6	12	1925	-	792834
14	2	74.5	12	1846	-	146044
15						
16						
17						
18						
19						
20						

DFS Radar Parameters
FCC Radar Type 5
Channel 58 Bandwidth 80MHz

Trial Number:			7			Detection (Yes/No) Yes
Number of Bursts in Trial:			15			
Chirp Center Frequency:			5290			
Burst	Number of Pulses	Pulse Width (Microseconds)	Chirp Width (MHz)	Pulse 1-to-2 Spacing (µsec)	Pulse 2-to-3 Spacing (µsec)	Starting Location Within Interval (µsec)
1	3	96.6	13	1609	1581	329022
2	3	96.7	13	1799	1154	521718
3	3	86.5	13	1396	1865	714222
4	2	73.3	13	1318	-	112450
5	1	55.8	13	-	-	306283
6	1	55.4	13	-	-	500239
7	3	85.3	13	1504	1820	690932
8	2	79.4	13	1893	-	88645
9	1	65.7	13	-	-	282508
10	2	68.6	13	1028	-	475842
11	2	77.7	13	1835	-	667887
12	2	79.6	13	1331	-	64845
13	3	94.9	13	1070	1349	257755
14	1	61.4	13	-	-	452335
15	3	90.6	13	1562	1887	643395
16						
17						
18						
19						
20						

Trial Number:			8			Detection (Yes/No) Yes
Number of Bursts in Trial:			12			
Chirp Center Frequency:			5290			
Burst	Number of Pulses	Pulse Width (Microseconds)	Chirp Width (MHz)	Pulse 1-to-2 Spacing (µsec)	Pulse 2-to-3 Spacing (µsec)	Starting Location Within Interval (µsec)
1	1	52.6	10	-	-	51446
2	3	84.1	10	1725	1529	292696
3	3	97.7	10	1868	1805	533989
4	3	97.3	10	1446	1755	775564
5	3	98.8	10	1386	1302	21542
6	2	72.2	10	1184	-	263385
7	2	67.6	10	1027	-	505581
8	2	75.7	10	1871	-	747058
9	1	60.9	10	-	-	989976
10	1	64.2	10	-	-	234024
11	2	78.8	10	1604	-	475207
12	3	87.5	10	1712	1683	715825
13						
14						
15						
16						
17						
18						
19						
20						

DFS Radar Parameters
FCC Radar Type 5
Channel 58 Bandwidth 80MHz

Trial Number:			9			Detection (Yes/No)
Number of Bursts in Trial:			14			
Chirp Center Frequency:			5290			
Burst	Number of Pulses	Pulse Width (Microseconds)	Chirp Width (MHz)	Pulse 1-to-2 Spacing (µsec)	Pulse 2-to-3 Spacing (µsec)	Starting Location Within Interval (µsec)
1	1	54.1	13	-	-	823112
2	1	50.7	13	-	-	174965
3	1	52.3	13	-	-	382216
4	3	99.8	13	1696	1949	587395
5	2	68.4	13	1099	-	796897
6	2	80.8	13	1505	-	149042
7	1	62.5	13	-	-	356750
8	2	74.8	13	1204	-	563824
9	1	50.8	13	-	-	772314
10	1	54	13	-	-	123796
11	1	63	13	-	-	331215
12	3	91.8	13	1270	1347	537402
13	2	79.3	13	1992	-	744805
14	1	64.3	13	-	-	98172
15						
16						
17						
18						
19						
20						

Trial Number:			10			Detection (Yes/No)
Number of Bursts in Trial:			8			
Chirp Center Frequency:			5290			
Burst	Number of Pulses	Pulse Width (Microseconds)	Chirp Width (MHz)	Pulse 1-to-2 Spacing (µsec)	Pulse 2-to-3 Spacing (µsec)	Starting Location Within Interval (µsec)
1	1	63.4	6	-	-	535615
2	1	52	6	-	-	898668
3	3	97.2	6	1605	1583	1259235
4	2	78.7	6	1743	-	127106
5	2	74.2	6	1219	-	490358
6	3	88.7	6	1934	1273	852409
7	1	54.3	6	-	-	1217152
8	3	95.4	6	1555	1791	82296
9						
10						
11						
12						
13						
14						
15						
16						
17						
18						
19						
20						

DFS Radar Parameters
FCC Radar Type 5
Channel 58 Bandwidth 80MHz

Trial Number:			11			Detection (Yes/No)
Number of Bursts in Trial:			17			
Chirp Center Frequency:			5258			
Burst	Number of Pulses	Pulse Width (Microseconds)	Chirp Width (MHz)	Pulse 1-to-2 Spacing (µsec)	Pulse 2-to-3 Spacing (µsec)	Starting Location Within Interval (µsec)
1	2	73.7	16	1497	-	209249
2	3	97.4	16	1754	1613	378386
3	3	91.7	16	1702	1462	548411
4	1	66.2	16	-	-	17733
5	2	70.8	16	1821	-	187952
6	1	52.3	16	-	-	359277
7	2	78.9	16	1984	-	528886
8	2	70.9	16	1358	-	700166
9	2	75.6	16	1430	-	167197
10	1	59.1	16	-	-	338262
11	2	77	16	1304	-	508324
12	2	67.9	16	1083	-	678689
13	2	81.2	16	1932	-	146031
14	2	78.7	16	1121	-	316923
15	1	63.3	16	-	-	488056
16	2	68.9	16	1423	-	657326
17	1	59.3	16	-	-	125509
18						
19						
20						

Trial Number:			12			Detection (Yes/No)
Number of Bursts in Trial:			19			
Chirp Center Frequency:			5259			
Burst	Number of Pulses	Pulse Width (Microseconds)	Chirp Width (MHz)	Pulse 1-to-2 Spacing (µsec)	Pulse 2-to-3 Spacing (µsec)	Starting Location Within Interval (µsec)
1	3	98.9	19	1680	1488	263736
2	2	82.3	19	1855	-	416459
3	3	86.7	19	1400	1919	567902
4	3	89.7	19	1068	1282	92979
5	3	98.6	19	1194	1461	245155
6	2	71.1	19	1789	-	397609
7	1	55.9	19	-	-	551431
8	2	67.9	19	1372	-	74413
9	3	84.4	19	1107	1443	226559
10	1	58.8	19	-	-	380056
11	1	65.6	19	-	-	533408
12	2	78.5	19	1704	-	55547
13	2	82.3	19	1686	-	207876
14	3	90.1	19	1071	1266	359771
15	3	90.2	19	1089	1950	511297
16	2	83.1	19	1406	-	36803
17	1	58.8	19	-	-	189652
18	2	77	19	1657	-	341809
19	1	55	19	-	-	495737
20						

DFS Radar Parameters
FCC Radar Type 5
Channel 58 Bandwidth 80MHz

Trial Number:			13			Detection (Yes/No)
Number of Bursts in Trial:			15			
Chirp Center Frequency:			5257			
Burst	Number of Pulses	Pulse Width (Microseconds)	Chirp Width (MHz)	Pulse 1-to-2 Spacing (µsec)	Pulse 2-to-3 Spacing (µsec)	Starting Location Within Interval (µsec)
1	1	58.1	13	-	-	22911
2	1	52.1	13	-	-	216473
3	1	59.9	13	-	-	410004
4	1	60.2	13	-	-	603671
5	3	95.9	13	1906	1608	794160
6	2	79.9	13	1859	-	192251
7	2	78.5	13	1917	-	385590
8	1	53.8	13	-	-	579862
9	1	64.7	13	-	-	773423
10	1	61.4	13	-	-	168898
11	2	83.2	13	1858	-	361606
12	3	84.7	13	1677	1638	553866
13	3	88.7	13	1528	1058	747241
14	2	78.3	13	1951	-	144710
15	2	69.3	13	1717	-	337856
16						
17						
18						
19						
20						

Trial Number:			14			Detection (Yes/No)
Number of Bursts in Trial:			12			
Chirp Center Frequency:			5255			
Burst	Number of Pulses	Pulse Width (Microseconds)	Chirp Width (MHz)	Pulse 1-to-2 Spacing (µsec)	Pulse 2-to-3 Spacing (µsec)	Starting Location Within Interval (µsec)
1	2	75.3	10	1612	-	664275
2	1	56.3	10	-	-	907886
3	2	67.7	10	1185	-	151316
4	1	55.6	10	-	-	393746
5	2	75.2	10	1267	-	635093
6	2	76.3	10	1305	-	876993
7	3	85.7	10	1362	1924	121278
8	3	98.4	10	1550	1249	362696
9	3	86.4	10	1439	1046	604342
10	3	93.6	10	1031	1452	846453
11	1	63.3	10	-	-	91871
12	3	92.4	10	1673	1322	333050
13						
14						
15						
16						
17						
18						
19						
20						

DFS Radar Parameters
FCC Radar Type 5
Channel 58 Bandwidth 80MHz

Trial Number:			15			Detection (Yes/No)
Number of Bursts in Trial:			19			
Chirp Center Frequency:			5259			
Burst	Number of Pulses	Pulse Width (Microseconds)	Chirp Width (MHz)	Pulse 1-to-2 Spacing (µsec)	Pulse 2-to-3 Spacing (µsec)	Starting Location Within Interval (µsec)
1	3	93.3	18	1912	1535	361323
2	2	69.1	18	1794	-	515261
3	3	86.9	18	1152	1148	39025
4	3	84.9	18	1948	1118	190900
5	2	72.3	18	1916	-	343941
6	1	51.7	18	-	-	497624
7	1	58.3	18	-	-	20319
8	1	60.8	18	-	-	172999
9	1	57.1	18	-	-	325872
10	3	88.9	18	1964	1489	475841
11	2	72	18	1297	-	1489
12	3	90.9	18	1566	1370	153647
13	1	59.8	18	-	-	307096
14	2	70	18	1291	-	458804
15	2	67.2	18	1881	-	610798
16	3	91.2	18	1832	1661	134759
17	1	56.5	18	-	-	288306
18	1	51.2	18	-	-	441296
19	2	74.1	18	1245	-	592780
20						

Trial Number:			16			Detection (Yes/No)
Number of Bursts in Trial:			14			
Chirp Center Frequency:			5256			
Burst	Number of Pulses	Pulse Width (Microseconds)	Chirp Width (MHz)	Pulse 1-to-2 Spacing (µsec)	Pulse 2-to-3 Spacing (µsec)	Starting Location Within Interval (µsec)
1	2	76.9	12	1140	-	158286
2	1	50.2	12	-	-	366024
3	1	62.9	12	-	-	573452
4	1	64.7	12	-	-	780619
5	3	83.8	12	1097	1621	132455
6	1	65.4	12	-	-	340207
7	1	53.2	12	-	-	548208
8	1	51.7	12	-	-	755333
9	2	78.7	12	1168	-	107117
10	2	72.4	12	1343	-	314500
11	1	53.8	12	-	-	522447
12	2	73.6	12	1553	-	728517
13	2	66.7	12	1122	-	81611
14	2	82.5	12	1019	-	288948
15						
16						
17						
18						
19						
20						

DFS Radar Parameters
FCC Radar Type 5
Channel 58 Bandwidth 80MHz

Trial Number:			17			Detection (Yes/No)
Number of Bursts in Trial:			20			
Chirp Center Frequency:			5259			
Burst	Number of Pulses	Pulse Width (Microseconds)	Chirp Width (MHz)	Pulse 1-to-2 Spacing (µsec)	Pulse 2-to-3 Spacing (µsec)	Starting Location Within Interval (µsec)
1	3	87.6	20	1055	1840	345766
2	3	85.2	20	1541	1408	490019
3	3	84.8	20	1889	1463	39073
4	2	77.9	20	1460	-	183923
5	2	76.5	20	1485	-	328777
6	1	60.9	20	-	-	474728
7	2	83	20	1010	-	21394
8	2	80.4	20	1752	-	165992
9	2	67.5	20	1181	-	310973
10	1	62.1	20	-	-	456884
11	3	86.4	20	1966	1263	3515
12	3	84.3	20	1188	1788	147928
13	2	76.9	20	1537	-	293225
14	3	95.8	20	1298	1844	436922
15	1	55.2	20	-	-	584015
16	1	59	20	-	-	130832
17	3	94.5	20	1700	1283	274684
18	3	91.9	20	1978	1165	418579
19	3	85.2	20	1551	1189	563464
20	2	69.5	20	1224	-	112787

Trial Number:			18			Detection (Yes/No)
Number of Bursts in Trial:			12			
Chirp Center Frequency:			5255			
Burst	Number of Pulses	Pulse Width (Microseconds)	Chirp Width (MHz)	Pulse 1-to-2 Spacing (µsec)	Pulse 2-to-3 Spacing (µsec)	Starting Location Within Interval (µsec)
1	3	86.4	10	1918	1455	429224
2	3	92.2	10	1719	1895	670241
3	2	80.4	10	1899	-	912880
4	1	54.3	10	-	-	158603
5	1	53.1	10	-	-	400824
6	2	69.4	10	1546	-	641915
7	2	69.1	10	1639	-	883823
8	3	100	10	1438	1595	128373
9	2	79.6	10	1705	-	370379
10	3	88.4	10	1579	1623	611194
11	1	53.3	10	-	-	855665
12	1	65.3	10	-	-	98897
13						
14						
15						
16						
17						
18						
19						
20						

DFS Radar Parameters
FCC Radar Type 5
Channel 58 Bandwidth 80MHz

Trial Number:			19			Detection (Yes/No)
Number of Bursts in Trial:			14			
Chirp Center Frequency:			5256			
Burst	Number of Pulses	Pulse Width (Microseconds)	Chirp Width (MHz)	Pulse 1-to-2 Spacing (µsec)	Pulse 2-to-3 Spacing (µsec)	Starting Location Within Interval (µsec)
1	1	55.3	12	-	-	292143
2	1	58.3	12	-	-	499633
3	2	72.3	12	1039	-	706377
4	3	84.8	12	1761	1721	58989
5	2	82.5	12	1431	-	266161
6	1	63.3	12	-	-	474469
7	2	80	12	1913	-	680544
8	3	90.3	12	1853	1123	33519
9	3	91.1	12	1783	1172	240319
10	3	96.6	12	1036	1385	447400
11	2	82.7	12	1990	-	654516
12	1	50.7	12	-	-	8083
13	2	78.4	12	1109	-	215435
14	3	99.5	12	1965	1869	421325
15						
16						
17						
18						
19						
20						

Trial Number:			20			Detection (Yes/No)
Number of Bursts in Trial:			12			
Chirp Center Frequency:			5255			
Burst	Number of Pulses	Pulse Width (Microseconds)	Chirp Width (MHz)	Pulse 1-to-2 Spacing (µsec)	Pulse 2-to-3 Spacing (µsec)	Starting Location Within Interval (µsec)
1	3	88.6	10	1067	1927	733725
2	1	57.4	10	-	-	977882
3	3	96.6	10	1658	1324	221197
4	2	69.7	10	1945	-	462915
5	2	77.9	10	1317	-	705071
6	1	62	10	-	-	947923
7	3	88.4	10	1077	1366	191373
8	3	97.3	10	1896	1367	432561
9	3	96.2	10	1787	1672	674004
10	3	95.4	10	1892	1414	915842
11	1	54.8	10	-	-	162176
12	2	80.4	10	1436	-	403553
13						
14						
15						
16						
17						
18						
19						
20						

DFS Radar Parameters
FCC Radar Type 5
Channel 58 Bandwidth 80MHz

Trial Number:			21			Detection (Yes/No)
Number of Bursts in Trial:			16			
Chirp Center Frequency:			5323			
Burst	Number of Pulses	Pulse Width (Microseconds)	Chirp Width (MHz)	Pulse 1-to-2 Spacing (µsec)	Pulse 2-to-3 Spacing (µsec)	Starting Location Within Interval (µsec)
1	2	74.7	15	1611	-	483470
2	1	57.1	15	-	-	666072
3	3	91.9	15	1475	1276	98810
4	2	83.1	15	1772	-	279914
5	1	50.7	15	-	-	462536
6	2	79.2	15	1600	-	642324
7	1	58.7	15	-	-	76831
8	2	71	15	1567	-	257785
9	2	79	15	1960	-	438554
10	2	68.5	15	1428	-	620397
11	2	73.5	15	1352	-	54310
12	2	70.5	15	1115	-	235506
13	2	76.6	15	1300	-	417036
14	2	81.2	15	1675	-	597974
15	1	61.8	15	-	-	32086
16	3	94.9	15	1206	1860	212751
17						
18						
19						
20						

Trial Number:			22			Detection (Yes/No)
Number of Bursts in Trial:			12			
Chirp Center Frequency:			5325			
Burst	Number of Pulses	Pulse Width (Microseconds)	Chirp Width (MHz)	Pulse 1-to-2 Spacing (µsec)	Pulse 2-to-3 Spacing (µsec)	Starting Location Within Interval (µsec)
1	2	78.5	9	1698	-	526149
2	3	89.8	9	1962	1167	767135
3	1	59.4	9	-	-	12955
4	2	79.6	9	1890	-	254612
5	2	76	9	1811	-	496588
6	1	53.6	9	-	-	739728
7	2	80.9	9	1053	-	980872
8	1	61.6	9	-	-	225249
9	1	53.4	9	-	-	467279
10	1	59.9	9	-	-	709720
11	1	60.4	9	-	-	951847
12	3	91.4	9	1726	1227	194839
13						
14						
15						
16						
17						
18						
19						
20						

DFS Radar Parameters
FCC Radar Type 5
Channel 58 Bandwidth 80MHz

Trial Number:			23			Detection (Yes/No)
Number of Bursts in Trial:			20			
Chirp Center Frequency:			5321			
Burst	Number of Pulses	Pulse Width (Microseconds)	Chirp Width (MHz)	Pulse 1-to-2 Spacing (µsec)	Pulse 2-to-3 Spacing (µsec)	Starting Location Within Interval (µsec)
1	2	77	20	1363	-	261858
2	1	58.1	20	-	-	407646
3	1	62.1	20	-	-	552319
4	2	76.9	20	1236	-	99107
5	2	80	20	1852	-	243514
6	1	52	20	-	-	389464
7	3	88.6	20	1995	1905	531093
8	2	72.9	20	1387	-	81159
9	3	98.5	20	1746	1389	225245
10	1	57.9	20	-	-	371906
11	3	95.9	20	1870	1066	514197
12	1	53.5	20	-	-	63561
13	3	92	20	1654	1458	207510
14	1	57.3	20	-	-	353638
15	2	70.5	20	1586	-	497515
16	2	70	20	1664	-	45553
17	3	84	20	1630	1176	189821
18	2	76.1	20	1057	-	335330
19	3	93.2	20	1018	1340	478825
20	3	96.8	20	1614	1817	27594

Trial Number:			24			Detection (Yes/No)
Number of Bursts in Trial:			14			
Chirp Center Frequency:			5324			
Burst	Number of Pulses	Pulse Width (Microseconds)	Chirp Width (MHz)	Pulse 1-to-2 Spacing (µsec)	Pulse 2-to-3 Spacing (µsec)	Starting Location Within Interval (µsec)
1	1	50.1	12	-	-	247117
2	3	93.5	12	1081	1413	453362
3	2	68.8	12	1577	-	660875
4	1	56.3	12	-	-	14140
5	3	86	12	1108	1987	220734
6	2	75.2	12	1536	-	428367
7	1	54.4	12	-	-	636681
8	2	71.1	12	1243	-	843157
9	2	76.2	12	1770	-	195585
10	2	80.2	12	1209	-	403231
11	2	79.7	12	1214	-	610202
12	3	90.9	12	1862	1601	815229
13	2	68.7	12	1441	-	170267
14	2	67.4	12	1313	-	377306
15						
16						
17						
18						
19						
20						

DFS Radar Parameters
FCC Radar Type 5
Channel 58 Bandwidth 80MHz

Trial Number:			25			Detection (Yes/No)
Number of Bursts in Trial:			13			
Chirp Center Frequency:			5324			
Burst	Number of Pulses	Pulse Width (Microseconds)	Chirp Width (MHz)	Pulse 1-to-2 Spacing (µsec)	Pulse 2-to-3 Spacing (µsec)	Starting Location Within Interval (µsec)
1	3	94	11	1748	1941	628071
2	2	70.8	11	1201	-	853391
3	1	56.3	11	-	-	156223
4	3	96.7	11	1163	1332	378734
5	3	90.6	11	1582	1498	601331
6	2	74.5	11	1281	-	825462
7	3	92.6	11	1669	1222	128265
8	3	89	11	1135	1380	351161
9	3	96.5	11	1822	1602	573425
10	2	70.5	11	1178	-	798431
11	3	94	11	1629	1956	100737
12	1	55.8	11	-	-	324661
13	3	87.7	11	1963	1164	546278
14						
15						
16						
17						
18						
19						
20						

Trial Number:			26			Detection (Yes/No)
Number of Bursts in Trial:			8			
Chirp Center Frequency:			5327			
Burst	Number of Pulses	Pulse Width (Microseconds)	Chirp Width (MHz)	Pulse 1-to-2 Spacing (µsec)	Pulse 2-to-3 Spacing (µsec)	Starting Location Within Interval (µsec)
1	2	68.6	5	1161	-	1253842
2	2	83.1	5	1315	-	119486
3	1	60.9	5	-	-	482958
4	2	77.7	5	1158	-	845641
5	2	77.4	5	1510	-	1208428
6	2	66.8	5	1323	-	74748
7	1	63.7	5	-	-	438300
8	3	91.2	5	1681	1275	800152
9						
10						
11						
12						
13						
14						
15						
16						
17						
18						
19						
20						

DFS Radar Parameters
FCC Radar Type 5
Channel 58 Bandwidth 80MHz

Trial Number:		27				Detection (Yes/No)
Number of Bursts in Trial:		17				
Chirp Center Frequency:		5322				
Burst	Number of Pulses	Pulse Width (Microseconds)	Chirp Width (MHz)	Pulse 1-to-2 Spacing (µsec)	Pulse 2-to-3 Spacing (µsec)	Starting Location Within Interval (µsec)
1	3	83.6	16	1195	1000	545865
2	3	89.4	16	1627	1656	14067
3	1	55.8	16	-	-	184953
4	3	90.9	16	1554	1998	353759
5	1	54.7	16	-	-	526388
6	3	97.7	16	1202	1250	694806
7	2	67.5	16	1434	-	163568
8	3	96.7	16	1469	1268	333410
9	2	68.3	16	1954	-	504006
10	2	78.3	16	1082	-	675297
11	1	55	16	-	-	142890
12	3	84.9	16	1936	1199	312479
13	2	74.6	16	1856	-	482953
14	1	63.3	16	-	-	655022
15	3	99.8	16	1515	1120	121457
16	1	63.6	16	-	-	292606
17	3	87.3	16	1051	1831	461322
18						
19						
20						

Trial Number:		28				Detection (Yes/No)
Number of Bursts in Trial:		19				
Chirp Center Frequency:		5321				
Burst	Number of Pulses	Pulse Width (Microseconds)	Chirp Width (MHz)	Pulse 1-to-2 Spacing (µsec)	Pulse 2-to-3 Spacing (µsec)	Starting Location Within Interval (µsec)
1	3	85.6	19	1078	1015	565136
2	2	68.6	19	1780	-	89970
3	1	54.2	19	-	-	243121
4	1	61.2	19	-	-	396034
5	3	97.1	19	1969	1100	546225
6	3	98.3	19	1699	1622	70998
7	1	62.4	19	-	-	224093
8	2	80.2	19	1769	-	376127
9	3	87.5	19	1448	1179	527806
10	3	85.8	19	1348	1472	52247
11	3	88.1	19	1124	1631	204582
12	1	65.3	19	-	-	357941
13	1	52.5	19	-	-	510977
14	1	52.3	19	-	-	33698
15	2	74.1	19	1200	-	186023
16	1	54.9	19	-	-	339327
17	2	76.2	19	1502	-	491053
18	1	60.4	19	-	-	14858
19	2	81.5	19	1103	-	167387
20						

DFS Radar Parameters
FCC Radar Type 5
Channel 58 Bandwidth 80MHz

Trial Number:			29			Detection (Yes/No)
Number of Bursts in Trial:			12			
Chirp Center Frequency:			5325			
Burst	Number of Pulses	Pulse Width (Microseconds)	Chirp Width (MHz)	Pulse 1-to-2 Spacing (µsec)	Pulse 2-to-3 Spacing (µsec)	Starting Location Within Interval (µsec)
1	1	50.5	10	-	-	507709
2	1	55.7	10	-	-	750249
3	3	85.8	10	1002	1967	989003
4	2	76.9	10	1474	-	235634
5	2	75.1	10	1052	-	477675
6	3	92.3	10	1486	1492	718312
7	2	78.1	10	1757	-	960895
8	3	92.2	10	1252	1713	205370
9	3	89	10	1706	1411	446940
10	2	70.9	10	1620	-	689225
11	1	63.1	10	-	-	932305
12	1	55.3	10	-	-	176231
13						
14						
15						
16						
17						
18						
19						
20						

Trial Number:			30			Detection (Yes/No)
Number of Bursts in Trial:			18			
Chirp Center Frequency:			5322			
Burst	Number of Pulses	Pulse Width (Microseconds)	Chirp Width (MHz)	Pulse 1-to-2 Spacing (µsec)	Pulse 2-to-3 Spacing (µsec)	Starting Location Within Interval (µsec)
1	3	83.4	17	1205	1801	277485
2	3	97.3	17	1826	1635	437880
3	3	90.4	17	1986	1674	598445
4	3	91.8	17	1151	1802	97088
5	3	98.2	17	1977	1766	257251
6	1	59.5	17	-	-	419893
7	2	80	17	1137	-	580724
8	3	86.5	17	1128	1828	77366
9	3	91.1	17	1599	1442	238032
10	3	93.5	17	1373	1087	398605
11	1	60.7	17	-	-	562025
12	2	67.2	17	1405	-	57684
13	1	61.8	17	-	-	219083
14	2	79.4	17	1667	-	379234
15	2	81.4	17	1464	-	540896
16	1	65.7	17	-	-	37916
17	2	76	17	1255	-	198794
18	2	81	17	1668	-	359754
19						
20						

DFS Radar Parameters
FCC Radar Type 1
Channel 50 Bandwidth 160MHz

Trial #	Pulse Repetition Frequency Number (1 to 23)	Pulse Repetition Frequency (Pulses Per Second)	Pulse Repetition Interval (Microseconds)	Detection (Yes / No)
1	22	1066.10	938	Yes
2	10	1432.66	698	Yes
3	6	1618.12	618	Yes
4	2	1858.74	538	Yes
5	19	1138.95	878	Yes
6	12	326.16	3066	Yes
7	7	1567.40	638	Yes
8	21	1089.32	918	Yes
9	17	1193.32	838	Yes
10	18	1165.50	858	Yes
11	15	1253.13	798	Yes
12	11	1392.76	718	No
13	4	1730.10	578	Yes
14	5	1672.24	598	Yes
15	3	1792.11	558	Yes
16		394.32	2536	Yes
17		1035.20	966	Yes
18		1209.19	827	Yes
19		399.84	2501	Yes
20		385.36	2595	Yes
21		897.67	1114	Yes
22		768.05	1302	Yes
23		328.41	3045	Yes
24		615.76	1624	Yes
25		347.46	2878	Yes
26		973.71	1027	Yes
27		402.41	2485	Yes
28		625.00	1600	Yes
29		853.24	1172	Yes
30		849.62	1177	Yes

DFS Radar Parameters
FCC Radar Type 2
Channel 50 Bandwidth 160MHz

Trial #	Number Pulses per Burst	Pulse Width (Microseconds)	Pulse Repetition Interval (Microseconds)	Detection (Yes / No)
1	26	3.20	179	Yes
2	23	1.10	207	Yes
3	24	2.10	230	Yes
4	29	4.80	200	Yes
5	28	3.90	214	Yes
6	26	2.90	222	Yes
7	26	3.20	204	Yes
8	25	2.50	192	Yes
9	26	3.10	164	Yes
10	23	1.20	156	Yes
11	27	3.90	210	Yes
12	29	4.60	201	Yes
13	26	3.20	162	Yes
14	25	2.20	197	Yes
15	29	4.50	163	Yes
16	26	3.00	203	Yes
17	29	5.00	168	Yes
18	25	2.40	217	Yes
19	26	2.90	191	Yes
20	25	2.30	166	Yes
21	27	3.70	150	Yes
22	25	2.20	176	Yes
23	29	4.90	195	Yes
24	26	2.90	202	Yes
25	25	2.50	178	Yes
26	23	1.10	206	Yes
27	27	3.80	155	Yes
28	29	4.70	157	Yes
29	25	2.40	224	Yes
30	28	4.20	159	Yes

DFS Radar Parameters
FCC Radar Type 3
Channel 50 Bandwidth 160MHz

Trial #	Number Pulses per Burst	Pulse Width (Microseconds)	Pulse Repetition Interval (Microseconds)	Detection (Yes / No)
1	17	8.20	355	Yes
2	16	6.10	487	Yes
3	16	7.10	344	Yes
4	18	9.80	288	Yes
5	18	8.90	230	Yes
6	17	7.90	432	Yes
7	17	8.20	207	Yes
8	17	7.50	443	Yes
9	17	8.10	439	Yes
10	16	6.20	223	Yes
11	18	8.90	208	Yes
12	18	9.60	463	Yes
13	17	8.20	441	Yes
14	16	7.20	323	Yes
15	18	9.50	297	Yes
16	17	8.00	412	Yes
17	18	10.00	324	Yes
18	17	7.40	271	Yes
19	17	7.90	349	Yes
20	16	7.30	409	Yes
21	18	8.70	373	Yes
22	16	7.20	254	Yes
23	18	9.90	274	Yes
24	17	7.90	278	Yes
25	17	7.50	317	Yes
26	16	6.10	260	Yes
27	18	8.80	211	Yes
28	18	9.70	272	Yes
29	17	7.40	264	Yes
30	18	9.20	284	Yes

DFS Radar Parameters
FCC Radar Type 4
Channel 50 Bandwidth 160MHz

Trial #	Number Pulses per Burst	Pulse Width (Microseconds)	Pulse Repetition Interval (Microseconds)	Detection (Yes / No)
1	14	16.00	355	Yes
2	12	11.30	487	Yes
3	13	13.50	344	Yes
4	16	19.40	288	Yes
5	15	17.50	230	Yes
6	14	15.30	432	Yes
7	14	15.90	207	Yes
8	13	14.30	443	Yes
9	14	15.80	439	Yes
10	12	11.50	223	Yes
11	15	17.40	208	Yes
12	16	19.00	463	Yes
13	14	16.00	441	Yes
14	13	13.80	323	Yes
15	16	18.90	297	Yes
16	14	15.50	412	Yes
17	16	19.90	324	Yes
18	13	14.10	271	Yes
19	14	15.20	349	Yes
20	13	13.80	409	Yes
21	15	17.10	373	Yes
22	13	13.80	254	Yes
23	16	19.80	274	Yes
24	14	15.30	278	Yes
25	13	14.50	317	Yes
26	12	11.30	260	Yes
27	15	17.30	211	Yes
28	16	19.20	272	Yes
29	13	14.20	264	Yes
30	15	18.20	284	Yes

DFS Radar Parameters
FCC Radar Type 5
Channel 50 Bandwidth 160MHz

Trial Number:			1			Detection (Yes/No)
Number of Bursts in Trial:			15			
Chirp Center Frequency:			5290			
Burst	Number of Pulses	Pulse Width (Microseconds)	Chirp Width (MHz)	Pulse 1-to-2 Spacing (µsec)	Pulse 2-to-3 Spacing (µsec)	Starting Location Within Interval (µsec)
1	2	77.8	13	1477	-	636185
2	1	51.9	13	-	-	32674
3	1	63.8	13	-	-	226294
4	3	96.6	13	1786	1843	417976
5	3	85.9	13	1215	1729	611152
6	2	73.7	13	1549	-	8789
7	2	77.2	13	1819	-	201917
8	2	68.4	13	1114	-	395530
9	2	76.7	13	1155	-	588564
10	1	53.2	13	-	-	783794
11	3	85.7	13	1695	1394	177933
12	3	94.3	13	1426	1935	370624
13	2	77.6	13	1671	-	564893
14	1	65.7	13	-	-	759583
15	3	93.5	13	1130	1468	154262
16						
17						
18						
19						
20						

Trial Number:			2			Detection (Yes/No)
Number of Bursts in Trial:			8			
Chirp Center Frequency:			5290			
Burst	Number of Pulses	Pulse Width (Microseconds)	Chirp Width (MHz)	Pulse 1-to-2 Spacing (µsec)	Pulse 2-to-3 Spacing (µsec)	Starting Location Within Interval (µsec)
1	2	75	5	1527	-	653020
2	3	99.4	5	1262	1257	1015643
3	2	67.4	5	1403	-	1379398
4	2	73.6	5	1041	-	245489
5	1	65.9	5	-	-	609113
6	3	83.8	5	1292	1419	970852
7	1	65.5	5	-	-	1335913
8	3	98.6	5	1796	1728	200406
9						
10						
11						
12						
13						
14						
15						
16						
17						
18						
19						
20						

DFS Radar Parameters
FCC Radar Type 5
Channel 50 Bandwidth 160MHz

Trial Number:			3			Detection (Yes/No)
Number of Bursts in Trial:			11			
Chirp Center Frequency:			5290			
Burst	Number of Pulses	Pulse Width (Microseconds)	Chirp Width (MHz)	Pulse 1-to-2 Spacing (µsec)	Pulse 2-to-3 Spacing (µsec)	Starting Location Within Interval (µsec)
1	2	73.8	9	1538	-	409565
2	2	69.5	9	1649	-	673692
3	1	51.9	9	-	-	938562
4	3	84.6	9	1032	1271	113209
5	3	95.4	9	1903	1388	376726
6	2	68	9	1351	-	641212
7	3	89.6	9	1514	1573	903714
8	2	81.9	9	1689	-	80863
9	3	88.3	9	1330	1838	344067
10	1	53.7	9	-	-	609331
11	3	91.3	9	1106	1001	871542
12						
13						
14						
15						
16						
17						
18						
19						
20						

Trial Number:			4			Detection (Yes/No)
Number of Bursts in Trial:			20			
Chirp Center Frequency:			5290			
Burst	Number of Pulses	Pulse Width (Microseconds)	Chirp Width (MHz)	Pulse 1-to-2 Spacing (µsec)	Pulse 2-to-3 Spacing (µsec)	Starting Location Within Interval (µsec)
1	2	68.1	19	1355	-	26541
2	1	58.7	19	-	-	171821
3	2	75.3	19	1640	-	316229
4	1	56.4	19	-	-	461864
5	3	99.7	19	1708	1159	8677
6	1	57.7	19	-	-	153995
7	1	59.5	19	-	-	299238
8	2	80	19	1369	-	443177
9	2	82	19	1197	-	587671
10	2	82.8	19	1005	-	135674
11	3	88	19	1928	1101	279928
12	3	93.2	19	1907	1223	424279
13	2	70.4	19	1360	-	570132
14	3	95.3	19	1955	1775	117439
15	2	81.9	19	1545	-	262502
16	3	98.5	19	1169	1062	406573
17	1	65	19	-	-	553328
18	3	85.4	19	1637	1425	99799
19	3	91.6	19	1445	1325	244095
20	2	67.3	19	1218	-	390012

DFS Radar Parameters
FCC Radar Type 5
Channel 50 Bandwidth 160MHz

Trial Number:			5			Detection (Yes/No)
Number of Bursts in Trial:			17			
Chirp Center Frequency:			5290			Yes
Burst	Number of Pulses	Pulse Width (Microseconds)	Chirp Width (MHz)	Pulse 1-to-2 Spacing (μ sec)	Pulse 2-to-3 Spacing (μ sec)	Starting Location Within Interval (μ sec)
1	2	67.9	16	1133	-	629614
2	1	62.3	16	-	-	96856
3	1	53.3	16	-	-	267719
4	3	90	16	1153	1346	436784
5	2	77.1	16	1646	-	608289
6	3	83.9	16	1232	1459	75610
7	3	89.1	16	1384	1939	245638
8	2	81.8	16	1676	-	416355
9	1	50.3	16	-	-	588736
10	3	87.1	16	1996	1756	54571
11	2	71.3	16	1815	-	225175
12	3	97.5	16	1465	1132	394825
13	3	90.6	16	1040	1354	565361
14	3	86.3	16	1183	1792	33643
15	3	97.6	16	1073	1361	203957
16	3	84.7	16	1718	1854	373812
17	3	99.7	16	1244	1988	544060
18						
19						
20						

Trial Number:			6			Detection (Yes/No)
Number of Bursts in Trial:			14			
Chirp Center Frequency:			5290			Yes
Burst	Number of Pulses	Pulse Width (Microseconds)	Chirp Width (MHz)	Pulse 1-to-2 Spacing (μ sec)	Pulse 2-to-3 Spacing (μ sec)	Starting Location Within Interval (μ sec)
1	3	92.9	12	1564	1407	15438
2	2	67.7	12	1747	-	222486
3	1	65.8	12	-	-	430731
4	1	56.3	12	-	-	637784
5	1	53.7	12	-	-	845342
6	3	83.5	12	1930	1025	196720
7	1	65.8	12	-	-	404955
8	3	85.9	12	1034	1808	610711
9	2	76.3	12	1926	-	818057
10	2	81.5	12	1714	-	171459
11	3	89.4	12	1594	1827	377969
12	1	63.4	12	-	-	586875
13	2	69.6	12	1925	-	792834
14	2	74.5	12	1846	-	146044
15						
16						
17						
18						
19						
20						

DFS Radar Parameters
FCC Radar Type 5
Channel 50 Bandwidth 160MHz

Trial Number:			7			Detection (Yes/No)
Number of Bursts in Trial:			15			
Chirp Center Frequency:			5290			
Burst	Number of Pulses	Pulse Width (Microseconds)	Chirp Width (MHz)	Pulse 1-to-2 Spacing (µsec)	Pulse 2-to-3 Spacing (µsec)	Starting Location Within Interval (µsec)
1	3	96.6	13	1609	1581	329022
2	3	96.7	13	1799	1154	521718
3	3	86.5	13	1396	1865	714222
4	2	73.3	13	1318	-	112450
5	1	55.8	13	-	-	306283
6	1	55.4	13	-	-	500239
7	3	85.3	13	1504	1820	690932
8	2	79.4	13	1893	-	88645
9	1	65.7	13	-	-	282508
10	2	68.6	13	1028	-	475842
11	2	77.7	13	1835	-	667887
12	2	79.6	13	1331	-	64845
13	3	94.9	13	1070	1349	257755
14	1	61.4	13	-	-	452335
15	3	90.6	13	1562	1887	643395
16						
17						
18						
19						
20						

Trial Number:			8			Detection (Yes/No)
Number of Bursts in Trial:			12			
Chirp Center Frequency:			5290			
Burst	Number of Pulses	Pulse Width (Microseconds)	Chirp Width (MHz)	Pulse 1-to-2 Spacing (µsec)	Pulse 2-to-3 Spacing (µsec)	Starting Location Within Interval (µsec)
1	1	52.6	10	-	-	51446
2	3	84.1	10	1725	1529	292696
3	3	97.7	10	1868	1805	533989
4	3	97.3	10	1446	1755	775564
5	3	98.8	10	1386	1302	21542
6	2	72.2	10	1184	-	263385
7	2	67.6	10	1027	-	505581
8	2	75.7	10	1871	-	747058
9	1	60.9	10	-	-	989976
10	1	64.2	10	-	-	234024
11	2	78.8	10	1604	-	475207
12	3	87.5	10	1712	1683	715825
13						
14						
15						
16						
17						
18						
19						
20						

DFS Radar Parameters
FCC Radar Type 5
Channel 50 Bandwidth 160MHz

Trial Number:			9			Detection (Yes/No)
Number of Bursts in Trial:			14			
Chirp Center Frequency:			5290			
Burst	Number of Pulses	Pulse Width (Microseconds)	Chirp Width (MHz)	Pulse 1-to-2 Spacing (µsec)	Pulse 2-to-3 Spacing (µsec)	Starting Location Within Interval (µsec)
1	1	54.1	13	-	-	823112
2	1	50.7	13	-	-	174965
3	1	52.3	13	-	-	382216
4	3	99.8	13	1696	1949	587395
5	2	68.4	13	1099	-	796897
6	2	80.8	13	1505	-	149042
7	1	62.5	13	-	-	356750
8	2	74.8	13	1204	-	563824
9	1	50.8	13	-	-	772314
10	1	54	13	-	-	123796
11	1	63	13	-	-	331215
12	3	91.8	13	1270	1347	537402
13	2	79.3	13	1992	-	744805
14	1	64.3	13	-	-	98172
15						
16						
17						
18						
19						
20						

Trial Number:			10			Detection (Yes/No)
Number of Bursts in Trial:			8			
Chirp Center Frequency:			5290			
Burst	Number of Pulses	Pulse Width (Microseconds)	Chirp Width (MHz)	Pulse 1-to-2 Spacing (µsec)	Pulse 2-to-3 Spacing (µsec)	Starting Location Within Interval (µsec)
1	1	63.4	6	-	-	535615
2	1	52	6	-	-	898668
3	3	97.2	6	1605	1583	1259235
4	2	78.7	6	1743	-	127106
5	2	74.2	6	1219	-	490358
6	3	88.7	6	1934	1273	852409
7	1	54.3	6	-	-	1217152
8	3	95.4	6	1555	1791	82296
9						
10						
11						
12						
13						
14						
15						
16						
17						
18						
19						
20						

DFS Radar Parameters
FCC Radar Type 5
Channel 50 Bandwidth 160MHz

Trial Number:			11			Detection (Yes/No)
Number of Bursts in Trial:			17			
Chirp Center Frequency:			5256			
Burst	Number of Pulses	Pulse Width (Microseconds)	Chirp Width (MHz)	Pulse 1-to-2 Spacing (µsec)	Pulse 2-to-3 Spacing (µsec)	Starting Location Within Interval (µsec)
1	2	73.7	16	1497	-	209249
2	3	97.4	16	1754	1613	378386
3	3	91.7	16	1702	1462	548411
4	1	66.2	16	-	-	17733
5	2	70.8	16	1821	-	187952
6	1	52.3	16	-	-	359277
7	2	78.9	16	1984	-	528886
8	2	70.9	16	1358	-	700166
9	2	75.6	16	1430	-	167197
10	1	59.1	16	-	-	338262
11	2	77	16	1304	-	508324
12	2	67.9	16	1083	-	678689
13	2	81.2	16	1932	-	146031
14	2	78.7	16	1121	-	316923
15	1	63.3	16	-	-	488056
16	2	68.9	16	1423	-	657326
17	1	59.3	16	-	-	125509
18						
19						
20						

Trial Number:			12			Detection (Yes/No)
Number of Bursts in Trial:			19			
Chirp Center Frequency:			5258			
Burst	Number of Pulses	Pulse Width (Microseconds)	Chirp Width (MHz)	Pulse 1-to-2 Spacing (µsec)	Pulse 2-to-3 Spacing (µsec)	Starting Location Within Interval (µsec)
1	3	98.9	19	1680	1488	263736
2	2	82.3	19	1855	-	416459
3	3	86.7	19	1400	1919	567902
4	3	89.7	19	1068	1282	92979
5	3	98.6	19	1194	1461	245155
6	2	71.1	19	1789	-	397609
7	1	55.9	19	-	-	551431
8	2	67.9	19	1372	-	74413
9	3	84.4	19	1107	1443	226559
10	1	58.8	19	-	-	380056
11	1	65.6	19	-	-	533408
12	2	78.5	19	1704	-	55547
13	2	82.3	19	1686	-	207876
14	3	90.1	19	1071	1266	359771
15	3	90.2	19	1089	1950	511297
16	2	83.1	19	1406	-	36803
17	1	58.8	19	-	-	189652
18	2	77	19	1657	-	341809
19	1	55	19	-	-	495737
20						

DFS Radar Parameters
FCC Radar Type 5
Channel 50 Bandwidth 160MHz

Trial Number:		13				Detection (Yes/No)
Number of Bursts in Trial:		15				
Chirp Center Frequency:		5255				
Burst	Number of Pulses	Pulse Width (Microseconds)	Chirp Width (MHz)	Pulse 1-to-2 Spacing (µsec)	Pulse 2-to-3 Spacing (µsec)	Starting Location Within Interval (µsec)
1	1	58.1	13	-	-	22911
2	1	52.1	13	-	-	216473
3	1	59.9	13	-	-	410004
4	1	60.2	13	-	-	603671
5	3	95.9	13	1906	1608	794160
6	2	79.9	13	1859	-	192251
7	2	78.5	13	1917	-	385590
8	1	53.8	13	-	-	579862
9	1	64.7	13	-	-	773423
10	1	61.4	13	-	-	168898
11	2	83.2	13	1858	-	361606
12	3	84.7	13	1677	1638	553866
13	3	88.7	13	1528	1058	747241
14	2	78.3	13	1951	-	144710
15	2	69.3	13	1717	-	337856
16						
17						
18						
19						
20						

Trial Number:		14				Detection (Yes/No)
Number of Bursts in Trial:		12				
Chirp Center Frequency:		5254				
Burst	Number of Pulses	Pulse Width (Microseconds)	Chirp Width (MHz)	Pulse 1-to-2 Spacing (µsec)	Pulse 2-to-3 Spacing (µsec)	Starting Location Within Interval (µsec)
1	2	75.3	10	1612	-	664275
2	1	56.3	10	-	-	907886
3	2	67.7	10	1185	-	151316
4	1	55.6	10	-	-	393746
5	2	75.2	10	1267	-	635093
6	2	76.3	10	1305	-	876993
7	3	85.7	10	1362	1924	121278
8	3	98.4	10	1550	1249	362696
9	3	86.4	10	1439	1046	604342
10	3	93.6	10	1031	1452	846453
11	1	63.3	10	-	-	91871
12	3	92.4	10	1673	1322	333050
13						
14						
15						
16						
17						
18						
19						
20						

DFS Radar Parameters
FCC Radar Type 5
Channel 50 Bandwidth 160MHz

Trial Number:			15			Detection (Yes/No)
Number of Bursts in Trial:			19			
Chirp Center Frequency:			5257			
Burst	Number of Pulses	Pulse Width (Microseconds)	Chirp Width (MHz)	Pulse 1-to-2 Spacing (µsec)	Pulse 2-to-3 Spacing (µsec)	Starting Location Within Interval (µsec)
1	3	93.3	18	1912	1535	361323
2	2	69.1	18	1794	-	515261
3	3	86.9	18	1152	1148	39025
4	3	84.9	18	1948	1118	190900
5	2	72.3	18	1916	-	343941
6	1	51.7	18	-	-	497624
7	1	58.3	18	-	-	20319
8	1	60.8	18	-	-	172999
9	1	57.1	18	-	-	325872
10	3	88.9	18	1964	1489	475841
11	2	72	18	1297	-	1489
12	3	90.9	18	1566	1370	153647
13	1	59.8	18	-	-	307096
14	2	70	18	1291	-	458804
15	2	67.2	18	1881	-	610798
16	3	91.2	18	1832	1661	134759
17	1	56.5	18	-	-	288306
18	1	51.2	18	-	-	441296
19	2	74.1	18	1245	-	592780
20						

Trial Number:			16			Detection (Yes/No)
Number of Bursts in Trial:			14			
Chirp Center Frequency:			5255			
Burst	Number of Pulses	Pulse Width (Microseconds)	Chirp Width (MHz)	Pulse 1-to-2 Spacing (µsec)	Pulse 2-to-3 Spacing (µsec)	Starting Location Within Interval (µsec)
1	2	76.9	12	1140	-	158286
2	1	50.2	12	-	-	366024
3	1	62.9	12	-	-	573452
4	1	64.7	12	-	-	780619
5	3	83.8	12	1097	1621	132455
6	1	65.4	12	-	-	340207
7	1	53.2	12	-	-	548208
8	1	51.7	12	-	-	755333
9	2	78.7	12	1168	-	107117
10	2	72.4	12	1343	-	314500
11	1	53.8	12	-	-	522447
12	2	73.6	12	1553	-	728517
13	2	66.7	12	1122	-	81611
14	2	82.5	12	1019	-	288948
15						
16						
17						
18						
19						
20						

DFS Radar Parameters
FCC Radar Type 5
Channel 50 Bandwidth 160MHz

Trial Number:			17			Detection (Yes/No)
Number of Bursts in Trial:			20			
Chirp Center Frequency:			5258			
Burst	Number of Pulses	Pulse Width (Microseconds)	Chirp Width (MHz)	Pulse 1-to-2 Spacing (µsec)	Pulse 2-to-3 Spacing (µsec)	Starting Location Within Interval (µsec)
1	3	87.6	20	1055	1840	345766
2	3	85.2	20	1541	1408	490019
3	3	84.8	20	1889	1463	39073
4	2	77.9	20	1460	-	183923
5	2	76.5	20	1485	-	328777
6	1	60.9	20	-	-	474728
7	2	83	20	1010	-	21394
8	2	80.4	20	1752	-	165992
9	2	67.5	20	1181	-	310973
10	1	62.1	20	-	-	456884
11	3	86.4	20	1966	1263	3515
12	3	84.3	20	1188	1788	147928
13	2	76.9	20	1537	-	293225
14	3	95.8	20	1298	1844	436922
15	1	55.2	20	-	-	584015
16	1	59	20	-	-	130832
17	3	94.5	20	1700	1283	274684
18	3	91.9	20	1978	1165	418579
19	3	85.2	20	1551	1189	563464
20	2	69.5	20	1224	-	112787

Trial Number:			18			Detection (Yes/No)
Number of Bursts in Trial:			12			
Chirp Center Frequency:			5254			
Burst	Number of Pulses	Pulse Width (Microseconds)	Chirp Width (MHz)	Pulse 1-to-2 Spacing (µsec)	Pulse 2-to-3 Spacing (µsec)	Starting Location Within Interval (µsec)
1	3	86.4	10	1918	1455	429224
2	3	92.2	10	1719	1895	670241
3	2	80.4	10	1899	-	912880
4	1	54.3	10	-	-	158603
5	1	53.1	10	-	-	400824
6	2	69.4	10	1546	-	641915
7	2	69.1	10	1639	-	883823
8	3	100	10	1438	1595	128373
9	2	79.6	10	1705	-	370379
10	3	88.4	10	1579	1623	611194
11	1	53.3	10	-	-	855665
12	1	65.3	10	-	-	98897
13						
14						
15						
16						
17						
18						
19						
20						

DFS Radar Parameters
FCC Radar Type 5
Channel 50 Bandwidth 160MHz

Trial Number:			19			Detection (Yes/No)
Number of Bursts in Trial:			14			
Chirp Center Frequency:			5255			
Burst	Number of Pulses	Pulse Width (Microseconds)	Chirp Width (MHz)	Pulse 1-to-2 Spacing (µsec)	Pulse 2-to-3 Spacing (µsec)	Starting Location Within Interval (µsec)
1	1	55.3	12	-	-	292143
2	1	58.3	12	-	-	499633
3	2	72.3	12	1039	-	706377
4	3	84.8	12	1761	1721	58989
5	2	82.5	12	1431	-	266161
6	1	63.3	12	-	-	474469
7	2	80	12	1913	-	680544
8	3	90.3	12	1853	1123	33519
9	3	91.1	12	1783	1172	240319
10	3	96.6	12	1036	1385	447400
11	2	82.7	12	1990	-	654516
12	1	50.7	12	-	-	8083
13	2	78.4	12	1109	-	215435
14	3	99.5	12	1965	1869	421325
15						
16						
17						
18						
19						
20						

Trial Number:			20			Detection (Yes/No)
Number of Bursts in Trial:			12			
Chirp Center Frequency:			5254			
Burst	Number of Pulses	Pulse Width (Microseconds)	Chirp Width (MHz)	Pulse 1-to-2 Spacing (µsec)	Pulse 2-to-3 Spacing (µsec)	Starting Location Within Interval (µsec)
1	3	88.6	10	1067	1927	733725
2	1	57.4	10	-	-	977882
3	3	96.6	10	1658	1324	221197
4	2	69.7	10	1945	-	462915
5	2	77.9	10	1317	-	705071
6	1	62	10	-	-	947923
7	3	88.4	10	1077	1366	191373
8	3	97.3	10	1896	1367	432561
9	3	96.2	10	1787	1672	674004
10	3	95.4	10	1892	1414	915842
11	1	54.8	10	-	-	162176
12	2	80.4	10	1436	-	403553
13						
14						
15						
16						
17						
18						
19						
20						

DFS Radar Parameters
FCC Radar Type 5
Channel 50 Bandwidth 160MHz

Trial Number:			21			Detection (Yes/No)
Number of Bursts in Trial:			16			
Chirp Center Frequency:			5324			
Burst	Number of Pulses	Pulse Width (Microseconds)	Chirp Width (MHz)	Pulse 1-to-2 Spacing (µsec)	Pulse 2-to-3 Spacing (µsec)	Starting Location Within Interval (µsec)
1	2	74.7	15	1611	-	483470
2	1	57.1	15	-	-	666072
3	3	91.9	15	1475	1276	98810
4	2	83.1	15	1772	-	279914
5	1	50.7	15	-	-	462536
6	2	79.2	15	1600	-	642324
7	1	58.7	15	-	-	76831
8	2	71	15	1567	-	257785
9	2	79	15	1960	-	438554
10	2	68.5	15	1428	-	620397
11	2	73.5	15	1352	-	54310
12	2	70.5	15	1115	-	235506
13	2	76.6	15	1300	-	417036
14	2	81.2	15	1675	-	597974
15	1	61.8	15	-	-	32086
16	3	94.9	15	1206	1860	212751
17						
18						
19						
20						

Trial Number:			22			Detection (Yes/No)
Number of Bursts in Trial:			12			
Chirp Center Frequency:			5326			
Burst	Number of Pulses	Pulse Width (Microseconds)	Chirp Width (MHz)	Pulse 1-to-2 Spacing (µsec)	Pulse 2-to-3 Spacing (µsec)	Starting Location Within Interval (µsec)
1	2	78.5	9	1698	-	526149
2	3	89.8	9	1962	1167	767135
3	1	59.4	9	-	-	12955
4	2	79.6	9	1890	-	254612
5	2	76	9	1811	-	496588
6	1	53.6	9	-	-	739728
7	2	80.9	9	1053	-	980872
8	1	61.6	9	-	-	225249
9	1	53.4	9	-	-	467279
10	1	59.9	9	-	-	709720
11	1	60.4	9	-	-	951847
12	3	91.4	9	1726	1227	194839
13						
14						
15						
16						
17						
18						
19						
20						

DFS Radar Parameters
FCC Radar Type 5
Channel 50 Bandwidth 160MHz

Trial Number:		23				Detection (Yes/No)
Number of Bursts in Trial:		20				
Chirp Center Frequency:		5322				
Burst	Number of Pulses	Pulse Width (Microseconds)	Chirp Width (MHz)	Pulse 1-to-2 Spacing (µsec)	Pulse 2-to-3 Spacing (µsec)	Starting Location Within Interval (µsec)
1	2	77	20	1363	-	261858
2	1	58.1	20	-	-	407646
3	1	62.1	20	-	-	552319
4	2	76.9	20	1236	-	99107
5	2	80	20	1852	-	243514
6	1	52	20	-	-	389464
7	3	88.6	20	1995	1905	531093
8	2	72.9	20	1387	-	81159
9	3	98.5	20	1746	1389	225245
10	1	57.9	20	-	-	371906
11	3	95.9	20	1870	1066	514197
12	1	53.5	20	-	-	63561
13	3	92	20	1654	1458	207510
14	1	57.3	20	-	-	353638
15	2	70.5	20	1586	-	497515
16	2	70	20	1664	-	45553
17	3	84	20	1630	1176	189821
18	2	76.1	20	1057	-	335330
19	3	93.2	20	1018	1340	478825
20	3	96.8	20	1614	1817	27594

Trial Number:		24				Detection (Yes/No)
Number of Bursts in Trial:		14				
Chirp Center Frequency:		5325				
Burst	Number of Pulses	Pulse Width (Microseconds)	Chirp Width (MHz)	Pulse 1-to-2 Spacing (µsec)	Pulse 2-to-3 Spacing (µsec)	Starting Location Within Interval (µsec)
1	1	50.1	12	-	-	247117
2	3	93.5	12	1081	1413	453362
3	2	68.8	12	1577	-	660875
4	1	56.3	12	-	-	14140
5	3	86	12	1108	1987	220734
6	2	75.2	12	1536	-	428367
7	1	54.4	12	-	-	636681
8	2	71.1	12	1243	-	843157
9	2	76.2	12	1770	-	195585
10	2	80.2	12	1209	-	403231
11	2	79.7	12	1214	-	610202
12	3	90.9	12	1862	1601	815229
13	2	68.7	12	1441	-	170267
14	2	67.4	12	1313	-	377306
15						
16						
17						
18						
19						
20						

DFS Radar Parameters
FCC Radar Type 5
Channel 50 Bandwidth 160MHz

Trial Number:			25			Detection (Yes/No)
Number of Bursts in Trial:			13			
Chirp Center Frequency:			5326			
Burst	Number of Pulses	Pulse Width (Microseconds)	Chirp Width (MHz)	Pulse 1-to-2 Spacing (µsec)	Pulse 2-to-3 Spacing (µsec)	Starting Location Within Interval (µsec)
1	3	94	11	1748	1941	628071
2	2	70.8	11	1201	-	853391
3	1	56.3	11	-	-	156223
4	3	96.7	11	1163	1332	378734
5	3	90.6	11	1582	1498	601331
6	2	74.5	11	1281	-	825462
7	3	92.6	11	1669	1222	128265
8	3	89	11	1135	1380	351161
9	3	96.5	11	1822	1602	573425
10	2	70.5	11	1178	-	798431
11	3	94	11	1629	1956	100737
12	1	55.8	11	-	-	324661
13	3	87.7	11	1963	1164	546278
14						
15						
16						
17						
18						
19						
20						

Trial Number:			26			Detection (Yes/No)
Number of Bursts in Trial:			8			
Chirp Center Frequency:			5328			
Burst	Number of Pulses	Pulse Width (Microseconds)	Chirp Width (MHz)	Pulse 1-to-2 Spacing (µsec)	Pulse 2-to-3 Spacing (µsec)	Starting Location Within Interval (µsec)
1	2	68.6	5	1161	-	1253842
2	2	83.1	5	1315	-	119486
3	1	60.9	5	-	-	482958
4	2	77.7	5	1158	-	845641
5	2	77.4	5	1510	-	1208428
6	2	66.8	5	1323	-	74748
7	1	63.7	5	-	-	438300
8	3	91.2	5	1681	1275	800152
9						
10						
11						
12						
13						
14						
15						
16						
17						
18						
19						
20						

DFS Radar Parameters
FCC Radar Type 5
Channel 50 Bandwidth 160MHz

Trial Number:			27			Detection (Yes/No)
Number of Bursts in Trial:			17			
Chirp Center Frequency:			5324			Yes
Burst	Number of Pulses	Pulse Width (Microseconds)	Chirp Width (MHz)	Pulse 1-to-2 Spacing (µsec)	Pulse 2-to-3 Spacing (µsec)	Starting Location Within Interval (µsec)
1	3	83.6	16	1195	1000	545865
2	3	89.4	16	1627	1656	14067
3	1	55.8	16	-	-	184953
4	3	90.9	16	1554	1998	353759
5	1	54.7	16	-	-	526388
6	3	97.7	16	1202	1250	694806
7	2	67.5	16	1434	-	163568
8	3	96.7	16	1469	1268	333410
9	2	68.3	16	1954	-	504006
10	2	78.3	16	1082	-	675297
11	1	55	16	-	-	142890
12	3	84.9	16	1936	1199	312479
13	2	74.6	16	1856	-	482953
14	1	63.3	16	-	-	655022
15	3	99.8	16	1515	1120	121457
16	1	63.6	16	-	-	292606
17	3	87.3	16	1051	1831	461322
18						
19						
20						

Trial Number:			28			Detection (Yes/No)
Number of Bursts in Trial:			19			
Chirp Center Frequency:			5322			Yes
Burst	Number of Pulses	Pulse Width (Microseconds)	Chirp Width (MHz)	Pulse 1-to-2 Spacing (µsec)	Pulse 2-to-3 Spacing (µsec)	Starting Location Within Interval (µsec)
1	3	85.6	19	1078	1015	565136
2	2	68.6	19	1780	-	89970
3	1	54.2	19	-	-	243121
4	1	61.2	19	-	-	396034
5	3	97.1	19	1969	1100	546225
6	3	98.3	19	1699	1622	70998
7	1	62.4	19	-	-	224093
8	2	80.2	19	1769	-	376127
9	3	87.5	19	1448	1179	527806
10	3	85.8	19	1348	1472	52247
11	3	88.1	19	1124	1631	204582
12	1	65.3	19	-	-	357941
13	1	52.5	19	-	-	510977
14	1	52.3	19	-	-	33698
15	2	74.1	19	1200	-	186023
16	1	54.9	19	-	-	339327
17	2	76.2	19	1502	-	491053
18	1	60.4	19	-	-	14858
19	2	81.5	19	1103	-	167387
20						

DFS Radar Parameters
FCC Radar Type 5
Channel 50 Bandwidth 160MHz

Trial Number:			29			Detection (Yes/No)
Number of Bursts in Trial:			12			
Chirp Center Frequency:			5326			
Burst	Number of Pulses	Pulse Width (Microseconds)	Chirp Width (MHz)	Pulse 1-to-2 Spacing (µsec)	Pulse 2-to-3 Spacing (µsec)	Starting Location Within Interval (µsec)
1	1	50.5	10	-	-	507709
2	1	55.7	10	-	-	750249
3	3	85.8	10	1002	1967	989003
4	2	76.9	10	1474	-	235634
5	2	75.1	10	1052	-	477675
6	3	92.3	10	1486	1492	718312
7	2	78.1	10	1757	-	960895
8	3	92.2	10	1252	1713	205370
9	3	89	10	1706	1411	446940
10	2	70.9	10	1620	-	689225
11	1	63.1	10	-	-	932305
12	1	55.3	10	-	-	176231
13						
14						
15						
16						
17						
18						
19						
20						

Trial Number:			30			Detection (Yes/No)
Number of Bursts in Trial:			18			
Chirp Center Frequency:			5323			
Burst	Number of Pulses	Pulse Width (Microseconds)	Chirp Width (MHz)	Pulse 1-to-2 Spacing (µsec)	Pulse 2-to-3 Spacing (µsec)	Starting Location Within Interval (µsec)
1	3	83.4	17	1205	1801	277485
2	3	97.3	17	1826	1635	437880
3	3	90.4	17	1986	1674	598445
4	3	91.8	17	1151	1802	97088
5	3	98.2	17	1977	1766	257251
6	1	59.5	17	-	-	419893
7	2	80	17	1137	-	580724
8	3	86.5	17	1128	1828	77366
9	3	91.1	17	1599	1442	238032
10	3	93.5	17	1373	1087	398605
11	1	60.7	17	-	-	562025
12	2	67.2	17	1405	-	57684
13	1	61.8	17	-	-	219083
14	2	79.4	17	1667	-	379234
15	2	81.4	17	1464	-	540896
16	1	65.7	17	-	-	37916
17	2	76	17	1255	-	198794
18	2	81	17	1668	-	359754
19						
20						

DFS Radar Parameters
FCC Radar Type 1
Channel 100 Bandwidth 20MHz

Trial #	Pulse Repetition Frequency Number (1 to 23)	Pulse Repetition Frequency (Pulses Per Second)	Pulse Repetition Interval (Microseconds)	Detection (Yes / No)
1	22	1066.10	938	Yes
2	10	1432.66	698	Yes
3	6	1618.12	618	Yes
4	2	1858.74	538	Yes
5	19	1138.95	878	Yes
6	12	326.16	3066	Yes
7	7	1567.40	638	Yes
8	21	1089.32	918	Yes
9	17	1193.32	838	Yes
10	18	1165.50	858	Yes
11	15	1253.13	798	Yes
12	11	1392.76	718	No
13	4	1730.10	578	Yes
14	5	1672.24	598	Yes
15	3	1792.11	558	Yes
16		394.32	2536	Yes
17		1035.20	966	Yes
18		1209.19	827	Yes
19		399.84	2501	Yes
20		385.36	2595	Yes
21		897.67	1114	Yes
22		768.05	1302	Yes
23		328.41	3045	Yes
24		615.76	1624	Yes
25		347.46	2878	Yes
26		973.71	1027	Yes
27		402.41	2485	Yes
28		625.00	1600	Yes
29		853.24	1172	Yes
30		849.62	1177	Yes

DFS Radar Parameters
FCC Radar Type 2
Channel 100 Bandwidth 20MHz

Trial #	Number Pulses per Burst	Pulse Width (Microseconds)	Pulse Repetition Interval (Microseconds)	Detection (Yes / No)
1	26	3.20	179	Yes
2	23	1.10	207	Yes
3	24	2.10	230	Yes
4	29	4.80	200	Yes
5	28	3.90	214	Yes
6	26	2.90	222	Yes
7	26	3.20	204	Yes
8	25	2.50	192	Yes
9	26	3.10	164	Yes
10	23	1.20	156	Yes
11	27	3.90	210	Yes
12	29	4.60	201	Yes
13	26	3.20	162	Yes
14	25	2.20	197	Yes
15	29	4.50	163	Yes
16	26	3.00	203	Yes
17	29	5.00	168	Yes
18	25	2.40	217	Yes
19	26	2.90	191	Yes
20	25	2.30	166	Yes
21	27	3.70	150	Yes
22	25	2.20	176	Yes
23	29	4.90	195	Yes
24	26	2.90	202	Yes
25	25	2.50	178	Yes
26	23	1.10	206	Yes
27	27	3.80	155	Yes
28	29	4.70	157	Yes
29	25	2.40	224	Yes
30	28	4.20	159	Yes

DFS Radar Parameters
FCC Radar Type 3
Channel 100 Bandwidth 20MHz

Trial #	Number Pulses per Burst	Pulse Width (Microseconds)	Pulse Repetition Interval (Microseconds)	Detection (Yes / No)
1	17	8.20	355	Yes
2	16	6.10	487	Yes
3	16	7.10	344	Yes
4	18	9.80	288	Yes
5	18	8.90	230	Yes
6	17	7.90	432	Yes
7	17	8.20	207	Yes
8	17	7.50	443	Yes
9	17	8.10	439	Yes
10	16	6.20	223	Yes
11	18	8.90	208	Yes
12	18	9.60	463	Yes
13	17	8.20	441	Yes
14	16	7.20	323	Yes
15	18	9.50	297	Yes
16	17	8.00	412	Yes
17	18	10.00	324	Yes
18	17	7.40	271	Yes
19	17	7.90	349	Yes
20	16	7.30	409	Yes
21	18	8.70	373	Yes
22	16	7.20	254	Yes
23	18	9.90	274	Yes
24	17	7.90	278	Yes
25	17	7.50	317	Yes
26	16	6.10	260	Yes
27	18	8.80	211	Yes
28	18	9.70	272	Yes
29	17	7.40	264	Yes
30	18	9.20	284	Yes

DFS Radar Parameters
FCC Radar Type 4
Channel 100 Bandwidth 20MHz

Trial #	Number Pulses per Burst	Pulse Width (Microseconds)	Pulse Repetition Interval (Microseconds)	Detection (Yes / No)
1	14	16.00	355	Yes
2	12	11.30	487	Yes
3	13	13.50	344	Yes
4	16	19.40	288	Yes
5	15	17.50	230	Yes
6	14	15.30	432	Yes
7	14	15.90	207	Yes
8	13	14.30	443	Yes
9	14	15.80	439	Yes
10	12	11.50	223	Yes
11	15	17.40	208	Yes
12	16	19.00	463	Yes
13	14	16.00	441	Yes
14	13	13.80	323	Yes
15	16	18.90	297	Yes
16	14	15.50	412	Yes
17	16	19.90	324	Yes
18	13	14.10	271	Yes
19	14	15.20	349	Yes
20	13	13.80	409	Yes
21	15	17.10	373	Yes
22	13	13.80	254	Yes
23	16	19.80	274	Yes
24	14	15.30	278	Yes
25	13	14.50	317	Yes
26	12	11.30	260	Yes
27	15	17.30	211	Yes
28	16	19.20	272	Yes
29	13	14.20	264	Yes
30	15	18.20	284	Yes

DFS Radar Parameters
FCC Radar Type 5
Channel 100 Bandwidth 20MHz

Trial Number:			1			Detection (Yes/No)
Number of Bursts in Trial:			15			
Chirp Center Frequency:			5500			
Burst	Number of Pulses	Pulse Width (Microseconds)	Chirp Width (MHz)	Pulse 1-to-2 Spacing (µsec)	Pulse 2-to-3 Spacing (µsec)	Starting Location Within Interval (µsec)
1	2	77.8	13	1477	-	636185
2	1	51.9	13	-	-	32674
3	1	63.8	13	-	-	226294
4	3	96.6	13	1786	1843	417976
5	3	85.9	13	1215	1729	611152
6	2	73.7	13	1549	-	8789
7	2	77.2	13	1819	-	201917
8	2	68.4	13	1114	-	395530
9	2	76.7	13	1155	-	588564
10	1	53.2	13	-	-	783794
11	3	85.7	13	1695	1394	177933
12	3	94.3	13	1426	1935	370624
13	2	77.6	13	1671	-	564893
14	1	65.7	13	-	-	759583
15	3	93.5	13	1130	1468	154262
16						
17						
18						
19						
20						

Trial Number:			2			Detection (Yes/No)
Number of Bursts in Trial:			8			
Chirp Center Frequency:			5500			
Burst	Number of Pulses	Pulse Width (Microseconds)	Chirp Width (MHz)	Pulse 1-to-2 Spacing (µsec)	Pulse 2-to-3 Spacing (µsec)	Starting Location Within Interval (µsec)
1	2	75	5	1527	-	653020
2	3	99.4	5	1262	1257	1015643
3	2	67.4	5	1403	-	1379398
4	2	73.6	5	1041	-	245489
5	1	65.9	5	-	-	609113
6	3	83.8	5	1292	1419	970852
7	1	65.5	5	-	-	1335913
8	3	98.6	5	1796	1728	200406
9						
10						
11						
12						
13						
14						
15						
16						
17						
18						
19						
20						

DFS Radar Parameters
FCC Radar Type 5
Channel 100 Bandwidth 20MHz

Trial Number:			3			Detection (Yes/No)
Number of Bursts in Trial:			11			
Chirp Center Frequency:			5500			
Burst	Number of Pulses	Pulse Width (Microseconds)	Chirp Width (MHz)	Pulse 1-to-2 Spacing (µsec)	Pulse 2-to-3 Spacing (µsec)	Starting Location Within Interval (µsec)
1	2	73.8	9	1538	-	409565
2	2	69.5	9	1649	-	673692
3	1	51.9	9	-	-	938562
4	3	84.6	9	1032	1271	113209
5	3	95.4	9	1903	1388	376726
6	2	68	9	1351	-	641212
7	3	89.6	9	1514	1573	903714
8	2	81.9	9	1689	-	80863
9	3	88.3	9	1330	1838	344067
10	1	53.7	9	-	-	609331
11	3	91.3	9	1106	1001	871542
12						
13						
14						
15						
16						
17						
18						
19						
20						

Trial Number:			4			Detection (Yes/No)
Number of Bursts in Trial:			20			
Chirp Center Frequency:			5500			
Burst	Number of Pulses	Pulse Width (Microseconds)	Chirp Width (MHz)	Pulse 1-to-2 Spacing (µsec)	Pulse 2-to-3 Spacing (µsec)	Starting Location Within Interval (µsec)
1	2	68.1	19	1355	-	26541
2	1	58.7	19	-	-	171821
3	2	75.3	19	1640	-	316229
4	1	56.4	19	-	-	461864
5	3	99.7	19	1708	1159	8677
6	1	57.7	19	-	-	153995
7	1	59.5	19	-	-	299238
8	2	80	19	1369	-	443177
9	2	82	19	1197	-	587671
10	2	82.8	19	1005	-	135674
11	3	88	19	1928	1101	279928
12	3	93.2	19	1907	1223	424279
13	2	70.4	19	1360	-	570132
14	3	95.3	19	1955	1775	117439
15	2	81.9	19	1545	-	262502
16	3	98.5	19	1169	1062	406573
17	1	65	19	-	-	553328
18	3	85.4	19	1637	1425	99799
19	3	91.6	19	1445	1325	244095
20	2	67.3	19	1218	-	390012

DFS Radar Parameters
FCC Radar Type 5
Channel 100 Bandwidth 20MHz

Trial Number:			5			Detection (Yes/No)
Number of Bursts in Trial:			17			
Chirp Center Frequency:			5500			Yes
Burst	Number of Pulses	Pulse Width (Microseconds)	Chirp Width (MHz)	Pulse 1-to-2 Spacing (µsec)	Pulse 2-to-3 Spacing (µsec)	Starting Location Within Interval (µsec)
1	2	67.9	16	1133	-	629614
2	1	62.3	16	-	-	96856
3	1	53.3	16	-	-	267719
4	3	90	16	1153	1346	436784
5	2	77.1	16	1646	-	608289
6	3	83.9	16	1232	1459	75610
7	3	89.1	16	1384	1939	245638
8	2	81.8	16	1676	-	416355
9	1	50.3	16	-	-	588736
10	3	87.1	16	1996	1756	54571
11	2	71.3	16	1815	-	225175
12	3	97.5	16	1465	1132	394825
13	3	90.6	16	1040	1354	565361
14	3	86.3	16	1183	1792	33643
15	3	97.6	16	1073	1361	203957
16	3	84.7	16	1718	1854	373812
17	3	99.7	16	1244	1988	544060
18						
19						
20						

Trial Number:			6			Detection (Yes/No)
Number of Bursts in Trial:			14			
Chirp Center Frequency:			5500			Yes
Burst	Number of Pulses	Pulse Width (Microseconds)	Chirp Width (MHz)	Pulse 1-to-2 Spacing (µsec)	Pulse 2-to-3 Spacing (µsec)	Starting Location Within Interval (µsec)
1	3	92.9	12	1564	1407	15438
2	2	67.7	12	1747	-	222486
3	1	65.8	12	-	-	430731
4	1	56.3	12	-	-	637784
5	1	53.7	12	-	-	845342
6	3	83.5	12	1930	1025	196720
7	1	65.8	12	-	-	404955
8	3	85.9	12	1034	1808	610711
9	2	76.3	12	1926	-	818057
10	2	81.5	12	1714	-	171459
11	3	89.4	12	1594	1827	377969
12	1	63.4	12	-	-	586875
13	2	69.6	12	1925	-	792834
14	2	74.5	12	1846	-	146044
15						
16						
17						
18						
19						
20						

DFS Radar Parameters
FCC Radar Type 5
Channel 100 Bandwidth 20MHz

Trial Number:			7			Detection (Yes/No) Yes
Number of Bursts in Trial:			15			
Chirp Center Frequency:			5500			
Burst	Number of Pulses	Pulse Width (Microseconds)	Chirp Width (MHz)	Pulse 1-to-2 Spacing (µsec)	Pulse 2-to-3 Spacing (µsec)	Starting Location Within Interval (µsec)
1	3	96.6	13	1609	1581	329022
2	3	96.7	13	1799	1154	521718
3	3	86.5	13	1396	1865	714222
4	2	73.3	13	1318	-	112450
5	1	55.8	13	-	-	306283
6	1	55.4	13	-	-	500239
7	3	85.3	13	1504	1820	690932
8	2	79.4	13	1893	-	88645
9	1	65.7	13	-	-	282508
10	2	68.6	13	1028	-	475842
11	2	77.7	13	1835	-	667887
12	2	79.6	13	1331	-	64845
13	3	94.9	13	1070	1349	257755
14	1	61.4	13	-	-	452335
15	3	90.6	13	1562	1887	643395
16						
17						
18						
19						
20						

Trial Number:			8			Detection (Yes/No) Yes
Number of Bursts in Trial:			12			
Chirp Center Frequency:			5500			
Burst	Number of Pulses	Pulse Width (Microseconds)	Chirp Width (MHz)	Pulse 1-to-2 Spacing (µsec)	Pulse 2-to-3 Spacing (µsec)	Starting Location Within Interval (µsec)
1	1	52.6	10	-	-	51446
2	3	84.1	10	1725	1529	292696
3	3	97.7	10	1868	1805	533989
4	3	97.3	10	1446	1755	775564
5	3	98.8	10	1386	1302	21542
6	2	72.2	10	1184	-	263385
7	2	67.6	10	1027	-	505581
8	2	75.7	10	1871	-	747058
9	1	60.9	10	-	-	989976
10	1	64.2	10	-	-	234024
11	2	78.8	10	1604	-	475207
12	3	87.5	10	1712	1683	715825
13						
14						
15						
16						
17						
18						
19						
20						

DFS Radar Parameters
FCC Radar Type 5
Channel 100 Bandwidth 20MHz

Trial Number:			9			Detection (Yes/No)
Number of Bursts in Trial:			14			
Chirp Center Frequency:			5500			
Burst	Number of Pulses	Pulse Width (Microseconds)	Chirp Width (MHz)	Pulse 1-to-2 Spacing (µsec)	Pulse 2-to-3 Spacing (µsec)	Starting Location Within Interval (µsec)
1	1	54.1	13	-	-	823112
2	1	50.7	13	-	-	174965
3	1	52.3	13	-	-	382216
4	3	99.8	13	1696	1949	587395
5	2	68.4	13	1099	-	796897
6	2	80.8	13	1505	-	149042
7	1	62.5	13	-	-	356750
8	2	74.8	13	1204	-	563824
9	1	50.8	13	-	-	772314
10	1	54	13	-	-	123796
11	1	63	13	-	-	331215
12	3	91.8	13	1270	1347	537402
13	2	79.3	13	1992	-	744805
14	1	64.3	13	-	-	98172
15						
16						
17						
18						
19						
20						

Trial Number:			10			Detection (Yes/No)
Number of Bursts in Trial:			8			
Chirp Center Frequency:			5500			
Burst	Number of Pulses	Pulse Width (Microseconds)	Chirp Width (MHz)	Pulse 1-to-2 Spacing (µsec)	Pulse 2-to-3 Spacing (µsec)	Starting Location Within Interval (µsec)
1	1	63.4	6	-	-	535615
2	1	52	6	-	-	898668
3	3	97.2	6	1605	1583	1259235
4	2	78.7	6	1743	-	127106
5	2	74.2	6	1219	-	490358
6	3	88.7	6	1934	1273	852409
7	1	54.3	6	-	-	1217152
8	3	95.4	6	1555	1791	82296
9						
10						
11						
12						
13						
14						
15						
16						
17						
18						
19						
20						

DFS Radar Parameters
FCC Radar Type 5
Channel 100 Bandwidth 20MHz

Trial Number:			11			Detection (Yes/No)
Number of Bursts in Trial:			17			
Chirp Center Frequency:			5497			
Burst	Number of Pulses	Pulse Width (Microseconds)	Chirp Width (MHz)	Pulse 1-to-2 Spacing (µsec)	Pulse 2-to-3 Spacing (µsec)	Starting Location Within Interval (µsec)
1	2	73.7	16	1497	-	209249
2	3	97.4	16	1754	1613	378386
3	3	91.7	16	1702	1462	548411
4	1	66.2	16	-	-	17733
5	2	70.8	16	1821	-	187952
6	1	52.3	16	-	-	359277
7	2	78.9	16	1984	-	528886
8	2	70.9	16	1358	-	700166
9	2	75.6	16	1430	-	167197
10	1	59.1	16	-	-	338262
11	2	77	16	1304	-	508324
12	2	67.9	16	1083	-	678689
13	2	81.2	16	1932	-	146031
14	2	78.7	16	1121	-	316923
15	1	63.3	16	-	-	488056
16	2	68.9	16	1423	-	657326
17	1	59.3	16	-	-	125509
18						
19						
20						

Trial Number:			12			Detection (Yes/No)
Number of Bursts in Trial:			19			
Chirp Center Frequency:			5498			
Burst	Number of Pulses	Pulse Width (Microseconds)	Chirp Width (MHz)	Pulse 1-to-2 Spacing (µsec)	Pulse 2-to-3 Spacing (µsec)	Starting Location Within Interval (µsec)
1	3	98.9	19	1680	1488	263736
2	2	82.3	19	1855	-	416459
3	3	86.7	19	1400	1919	567902
4	3	89.7	19	1068	1282	92979
5	3	98.6	19	1194	1461	245155
6	2	71.1	19	1789	-	397609
7	1	55.9	19	-	-	551431
8	2	67.9	19	1372	-	74413
9	3	84.4	19	1107	1443	226559
10	1	58.8	19	-	-	380056
11	1	65.6	19	-	-	533408
12	2	78.5	19	1704	-	55547
13	2	82.3	19	1686	-	207876
14	3	90.1	19	1071	1266	359771
15	3	90.2	19	1089	1950	511297
16	2	83.1	19	1406	-	36803
17	1	58.8	19	-	-	189652
18	2	77	19	1657	-	341809
19	1	55	19	-	-	495737
20						

DFS Radar Parameters
FCC Radar Type 5
Channel 100 Bandwidth 20MHz

Trial Number:			13			Detection (Yes/No)
Number of Bursts in Trial:			15			
Chirp Center Frequency:			5496			
Burst	Number of Pulses	Pulse Width (Microseconds)	Chirp Width (MHz)	Pulse 1-to-2 Spacing (µsec)	Pulse 2-to-3 Spacing (µsec)	Starting Location Within Interval (µsec)
1	1	58.1	13	-	-	22911
2	1	52.1	13	-	-	216473
3	1	59.9	13	-	-	410004
4	1	60.2	13	-	-	603671
5	3	95.9	13	1906	1608	794160
6	2	79.9	13	1859	-	192251
7	2	78.5	13	1917	-	385590
8	1	53.8	13	-	-	579862
9	1	64.7	13	-	-	773423
10	1	61.4	13	-	-	168898
11	2	83.2	13	1858	-	361606
12	3	84.7	13	1677	1638	553866
13	3	88.7	13	1528	1058	747241
14	2	78.3	13	1951	-	144710
15	2	69.3	13	1717	-	337856
16						
17						
18						
19						
20						

Trial Number:			14			Detection (Yes/No)
Number of Bursts in Trial:			12			
Chirp Center Frequency:			5495			
Burst	Number of Pulses	Pulse Width (Microseconds)	Chirp Width (MHz)	Pulse 1-to-2 Spacing (µsec)	Pulse 2-to-3 Spacing (µsec)	Starting Location Within Interval (µsec)
1	2	75.3	10	1612	-	664275
2	1	56.3	10	-	-	907886
3	2	67.7	10	1185	-	151316
4	1	55.6	10	-	-	393746
5	2	75.2	10	1267	-	635093
6	2	76.3	10	1305	-	876993
7	3	85.7	10	1362	1924	121278
8	3	98.4	10	1550	1249	362696
9	3	86.4	10	1439	1046	604342
10	3	93.6	10	1031	1452	846453
11	1	63.3	10	-	-	91871
12	3	92.4	10	1673	1322	333050
13						
14						
15						
16						
17						
18						
19						
20						

DFS Radar Parameters
FCC Radar Type 5
Channel 100 Bandwidth 20MHz

Trial Number:			15			Detection (Yes/No)
Number of Bursts in Trial:			19			
Chirp Center Frequency:			5498			
Burst	Number of Pulses	Pulse Width (Microseconds)	Chirp Width (MHz)	Pulse 1-to-2 Spacing (µsec)	Pulse 2-to-3 Spacing (µsec)	Starting Location Within Interval (µsec)
1	3	93.3	18	1912	1535	361323
2	2	69.1	18	1794	-	515261
3	3	86.9	18	1152	1148	39025
4	3	84.9	18	1948	1118	190900
5	2	72.3	18	1916	-	343941
6	1	51.7	18	-	-	497624
7	1	58.3	18	-	-	20319
8	1	60.8	18	-	-	172999
9	1	57.1	18	-	-	325872
10	3	88.9	18	1964	1489	475841
11	2	72	18	1297	-	1489
12	3	90.9	18	1566	1370	153647
13	1	59.8	18	-	-	307096
14	2	70	18	1291	-	458804
15	2	67.2	18	1881	-	610798
16	3	91.2	18	1832	1661	134759
17	1	56.5	18	-	-	288306
18	1	51.2	18	-	-	441296
19	2	74.1	18	1245	-	592780
20						

Trial Number:			16			Detection (Yes/No)
Number of Bursts in Trial:			14			
Chirp Center Frequency:			5495			
Burst	Number of Pulses	Pulse Width (Microseconds)	Chirp Width (MHz)	Pulse 1-to-2 Spacing (µsec)	Pulse 2-to-3 Spacing (µsec)	Starting Location Within Interval (µsec)
1	2	76.9	12	1140	-	158286
2	1	50.2	12	-	-	366024
3	1	62.9	12	-	-	573452
4	1	64.7	12	-	-	780619
5	3	83.8	12	1097	1621	132455
6	1	65.4	12	-	-	340207
7	1	53.2	12	-	-	548208
8	1	51.7	12	-	-	755333
9	2	78.7	12	1168	-	107117
10	2	72.4	12	1343	-	314500
11	1	53.8	12	-	-	522447
12	2	73.6	12	1553	-	728517
13	2	66.7	12	1122	-	81611
14	2	82.5	12	1019	-	288948
15						
16						
17						
18						
19						
20						

DFS Radar Parameters
FCC Radar Type 5
Channel 100 Bandwidth 20MHz

Trial Number:			17			Detection (Yes/No)
Number of Bursts in Trial:			20			
Chirp Center Frequency:			5499			
Burst	Number of Pulses	Pulse Width (Microseconds)	Chirp Width (MHz)	Pulse 1-to-2 Spacing (µsec)	Pulse 2-to-3 Spacing (µsec)	Starting Location Within Interval (µsec)
1	3	87.6	20	1055	1840	345766
2	3	85.2	20	1541	1408	490019
3	3	84.8	20	1889	1463	39073
4	2	77.9	20	1460	-	183923
5	2	76.5	20	1485	-	328777
6	1	60.9	20	-	-	474728
7	2	83	20	1010	-	21394
8	2	80.4	20	1752	-	165992
9	2	67.5	20	1181	-	310973
10	1	62.1	20	-	-	456884
11	3	86.4	20	1966	1263	3515
12	3	84.3	20	1188	1788	147928
13	2	76.9	20	1537	-	293225
14	3	95.8	20	1298	1844	436922
15	1	55.2	20	-	-	584015
16	1	59	20	-	-	130832
17	3	94.5	20	1700	1283	274684
18	3	91.9	20	1978	1165	418579
19	3	85.2	20	1551	1189	563464
20	2	69.5	20	1224	-	112787

Trial Number:			18			Detection (Yes/No)
Number of Bursts in Trial:			12			
Chirp Center Frequency:			5495			
Burst	Number of Pulses	Pulse Width (Microseconds)	Chirp Width (MHz)	Pulse 1-to-2 Spacing (µsec)	Pulse 2-to-3 Spacing (µsec)	Starting Location Within Interval (µsec)
1	3	86.4	10	1918	1455	429224
2	3	92.2	10	1719	1895	670241
3	2	80.4	10	1899	-	912880
4	1	54.3	10	-	-	158603
5	1	53.1	10	-	-	400824
6	2	69.4	10	1546	-	641915
7	2	69.1	10	1639	-	883823
8	3	100	10	1438	1595	128373
9	2	79.6	10	1705	-	370379
10	3	88.4	10	1579	1623	611194
11	1	53.3	10	-	-	855665
12	1	65.3	10	-	-	98897
13						
14						
15						
16						
17						
18						
19						
20						

DFS Radar Parameters
FCC Radar Type 5
Channel 100 Bandwidth 20MHz

Trial Number:			19			Detection (Yes/No)
Number of Bursts in Trial:			14			
Chirp Center Frequency:			5495			
Burst	Number of Pulses	Pulse Width (Microseconds)	Chirp Width (MHz)	Pulse 1-to-2 Spacing (µsec)	Pulse 2-to-3 Spacing (µsec)	Starting Location Within Interval (µsec)
1	1	55.3	12	-	-	292143
2	1	58.3	12	-	-	499633
3	2	72.3	12	1039	-	706377
4	3	84.8	12	1761	1721	58989
5	2	82.5	12	1431	-	266161
6	1	63.3	12	-	-	474469
7	2	80	12	1913	-	680544
8	3	90.3	12	1853	1123	33519
9	3	91.1	12	1783	1172	240319
10	3	96.6	12	1036	1385	447400
11	2	82.7	12	1990	-	654516
12	1	50.7	12	-	-	8083
13	2	78.4	12	1109	-	215435
14	3	99.5	12	1965	1869	421325
15						
16						
17						
18						
19						
20						

Trial Number:			20			Detection (Yes/No)
Number of Bursts in Trial:			12			
Chirp Center Frequency:			5495			
Burst	Number of Pulses	Pulse Width (Microseconds)	Chirp Width (MHz)	Pulse 1-to-2 Spacing (µsec)	Pulse 2-to-3 Spacing (µsec)	Starting Location Within Interval (µsec)
1	3	88.6	10	1067	1927	733725
2	1	57.4	10	-	-	977882
3	3	96.6	10	1658	1324	221197
4	2	69.7	10	1945	-	462915
5	2	77.9	10	1317	-	705071
6	1	62	10	-	-	947923
7	3	88.4	10	1077	1366	191373
8	3	97.3	10	1896	1367	432561
9	3	96.2	10	1787	1672	674004
10	3	95.4	10	1892	1414	915842
11	1	54.8	10	-	-	162176
12	2	80.4	10	1436	-	403553
13						
14						
15						
16						
17						
18						
19						
20						

DFS Radar Parameters
FCC Radar Type 5
Channel 100 Bandwidth 20MHz

Trial Number:			21			Detection (Yes/No)
Number of Bursts in Trial:			16			
Chirp Center Frequency:			5503			
Burst	Number of Pulses	Pulse Width (Microseconds)	Chirp Width (MHz)	Pulse 1-to-2 Spacing (µsec)	Pulse 2-to-3 Spacing (µsec)	Starting Location Within Interval (µsec)
1	2	74.7	15	1611	-	483470
2	1	57.1	15	-	-	666072
3	3	91.9	15	1475	1276	98810
4	2	83.1	15	1772	-	279914
5	1	50.7	15	-	-	462536
6	2	79.2	15	1600	-	642324
7	1	58.7	15	-	-	76831
8	2	71	15	1567	-	257785
9	2	79	15	1960	-	438554
10	2	68.5	15	1428	-	620397
11	2	73.5	15	1352	-	54310
12	2	70.5	15	1115	-	235506
13	2	76.6	15	1300	-	417036
14	2	81.2	15	1675	-	597974
15	1	61.8	15	-	-	32086
16	3	94.9	15	1206	1860	212751
17						
18						
19						
20						

Trial Number:			22			Detection (Yes/No)
Number of Bursts in Trial:			12			
Chirp Center Frequency:			5506			
Burst	Number of Pulses	Pulse Width (Microseconds)	Chirp Width (MHz)	Pulse 1-to-2 Spacing (µsec)	Pulse 2-to-3 Spacing (µsec)	Starting Location Within Interval (µsec)
1	2	78.5	9	1698	-	526149
2	3	89.8	9	1962	1167	767135
3	1	59.4	9	-	-	12955
4	2	79.6	9	1890	-	254612
5	2	76	9	1811	-	496588
6	1	53.6	9	-	-	739728
7	2	80.9	9	1053	-	980872
8	1	61.6	9	-	-	225249
9	1	53.4	9	-	-	467279
10	1	59.9	9	-	-	709720
11	1	60.4	9	-	-	951847
12	3	91.4	9	1726	1227	194839
13						
14						
15						
16						
17						
18						
19						
20						

DFS Radar Parameters
FCC Radar Type 5
Channel 100 Bandwidth 20MHz

Trial Number:			23			Detection (Yes/No)
Number of Bursts in Trial:			20			
Chirp Center Frequency:			5501			
Burst	Number of Pulses	Pulse Width (Microseconds)	Chirp Width (MHz)	Pulse 1-to-2 Spacing (µsec)	Pulse 2-to-3 Spacing (µsec)	Starting Location Within Interval (µsec)
1	2	77	20	1363	-	261858
2	1	58.1	20	-	-	407646
3	1	62.1	20	-	-	552319
4	2	76.9	20	1236	-	99107
5	2	80	20	1852	-	243514
6	1	52	20	-	-	389464
7	3	88.6	20	1995	1905	531093
8	2	72.9	20	1387	-	81159
9	3	98.5	20	1746	1389	225245
10	1	57.9	20	-	-	371906
11	3	95.9	20	1870	1066	514197
12	1	53.5	20	-	-	63561
13	3	92	20	1654	1458	207510
14	1	57.3	20	-	-	353638
15	2	70.5	20	1586	-	497515
16	2	70	20	1664	-	45553
17	3	84	20	1630	1176	189821
18	2	76.1	20	1057	-	335330
19	3	93.2	20	1018	1340	478825
20	3	96.8	20	1614	1817	27594

Trial Number:			24			Detection (Yes/No)
Number of Bursts in Trial:			14			
Chirp Center Frequency:			5505			
Burst	Number of Pulses	Pulse Width (Microseconds)	Chirp Width (MHz)	Pulse 1-to-2 Spacing (µsec)	Pulse 2-to-3 Spacing (µsec)	Starting Location Within Interval (µsec)
1	1	50.1	12	-	-	247117
2	3	93.5	12	1081	1413	453362
3	2	68.8	12	1577	-	660875
4	1	56.3	12	-	-	14140
5	3	86	12	1108	1987	220734
6	2	75.2	12	1536	-	428367
7	1	54.4	12	-	-	636681
8	2	71.1	12	1243	-	843157
9	2	76.2	12	1770	-	195585
10	2	80.2	12	1209	-	403231
11	2	79.7	12	1214	-	610202
12	3	90.9	12	1862	1601	815229
13	2	68.7	12	1441	-	170267
14	2	67.4	12	1313	-	377306
15						
16						
17						
18						
19						
20						

DFS Radar Parameters
FCC Radar Type 5
Channel 100 Bandwidth 20MHz

Trial Number:			25			Detection (Yes/No)
Number of Bursts in Trial:			13			
Chirp Center Frequency:			5505			
Burst	Number of Pulses	Pulse Width (Microseconds)	Chirp Width (MHz)	Pulse 1-to-2 Spacing (µsec)	Pulse 2-to-3 Spacing (µsec)	Starting Location Within Interval (µsec)
1	3	94	11	1748	1941	628071
2	2	70.8	11	1201	-	853391
3	1	56.3	11	-	-	156223
4	3	96.7	11	1163	1332	378734
5	3	90.6	11	1582	1498	601331
6	2	74.5	11	1281	-	825462
7	3	92.6	11	1669	1222	128265
8	3	89	11	1135	1380	351161
9	3	96.5	11	1822	1602	573425
10	2	70.5	11	1178	-	798431
11	3	94	11	1629	1956	100737
12	1	55.8	11	-	-	324661
13	3	87.7	11	1963	1164	546278
14						
15						
16						
17						
18						
19						
20						

Trial Number:			26			Detection (Yes/No)
Number of Bursts in Trial:			8			
Chirp Center Frequency:			5507			
Burst	Number of Pulses	Pulse Width (Microseconds)	Chirp Width (MHz)	Pulse 1-to-2 Spacing (µsec)	Pulse 2-to-3 Spacing (µsec)	Starting Location Within Interval (µsec)
1	2	68.6	5	1161	-	1253842
2	2	83.1	5	1315	-	119486
3	1	60.9	5	-	-	482958
4	2	77.7	5	1158	-	845641
5	2	77.4	5	1510	-	1208428
6	2	66.8	5	1323	-	74748
7	1	63.7	5	-	-	438300
8	3	91.2	5	1681	1275	800152
9						
10						
11						
12						
13						
14						
15						
16						
17						
18						
19						
20						

DFS Radar Parameters
FCC Radar Type 5
Channel 100 Bandwidth 20MHz

Trial Number:		27				Detection (Yes/No)
Number of Bursts in Trial:		17				
Chirp Center Frequency:		5503				Yes
Burst	Number of Pulses	Pulse Width (Microseconds)	Chirp Width (MHz)	Pulse 1-to-2 Spacing (µsec)	Pulse 2-to-3 Spacing (µsec)	Starting Location Within Interval (µsec)
1	3	83.6	16	1195	1000	545865
2	3	89.4	16	1627	1656	14067
3	1	55.8	16	-	-	184953
4	3	90.9	16	1554	1998	353759
5	1	54.7	16	-	-	526388
6	3	97.7	16	1202	1250	694806
7	2	67.5	16	1434	-	163568
8	3	96.7	16	1469	1268	333410
9	2	68.3	16	1954	-	504006
10	2	78.3	16	1082	-	675297
11	1	55	16	-	-	142890
12	3	84.9	16	1936	1199	312479
13	2	74.6	16	1856	-	482953
14	1	63.3	16	-	-	655022
15	3	99.8	16	1515	1120	121457
16	1	63.6	16	-	-	292606
17	3	87.3	16	1051	1831	461322
18						
19						
20						

Trial Number:		28				Detection (Yes/No)
Number of Bursts in Trial:		19				
Chirp Center Frequency:		5502				Yes
Burst	Number of Pulses	Pulse Width (Microseconds)	Chirp Width (MHz)	Pulse 1-to-2 Spacing (µsec)	Pulse 2-to-3 Spacing (µsec)	Starting Location Within Interval (µsec)
1	3	85.6	19	1078	1015	565136
2	2	68.6	19	1780	-	89970
3	1	54.2	19	-	-	243121
4	1	61.2	19	-	-	396034
5	3	97.1	19	1969	1100	546225
6	3	98.3	19	1699	1622	70998
7	1	62.4	19	-	-	224093
8	2	80.2	19	1769	-	376127
9	3	87.5	19	1448	1179	527806
10	3	85.8	19	1348	1472	52247
11	3	88.1	19	1124	1631	204582
12	1	65.3	19	-	-	357941
13	1	52.5	19	-	-	510977
14	1	52.3	19	-	-	33698
15	2	74.1	19	1200	-	186023
16	1	54.9	19	-	-	339327
17	2	76.2	19	1502	-	491053
18	1	60.4	19	-	-	14858
19	2	81.5	19	1103	-	167387
20						

DFS Radar Parameters
FCC Radar Type 5
Channel 100 Bandwidth 20MHz

Trial Number:			29			Detection (Yes/No)
Number of Bursts in Trial:			12			
Chirp Center Frequency:			5505			
Burst	Number of Pulses	Pulse Width (Microseconds)	Chirp Width (MHz)	Pulse 1-to-2 Spacing (µsec)	Pulse 2-to-3 Spacing (µsec)	Starting Location Within Interval (µsec)
1	1	50.5	10	-	-	507709
2	1	55.7	10	-	-	750249
3	3	85.8	10	1002	1967	989003
4	2	76.9	10	1474	-	235634
5	2	75.1	10	1052	-	477675
6	3	92.3	10	1486	1492	718312
7	2	78.1	10	1757	-	960895
8	3	92.2	10	1252	1713	205370
9	3	89	10	1706	1411	446940
10	2	70.9	10	1620	-	689225
11	1	63.1	10	-	-	932305
12	1	55.3	10	-	-	176231
13						
14						
15						
16						
17						
18						
19						
20						

Trial Number:			30			Detection (Yes/No)
Number of Bursts in Trial:			18			
Chirp Center Frequency:			5503			
Burst	Number of Pulses	Pulse Width (Microseconds)	Chirp Width (MHz)	Pulse 1-to-2 Spacing (µsec)	Pulse 2-to-3 Spacing (µsec)	Starting Location Within Interval (µsec)
1	3	83.4	17	1205	1801	277485
2	3	97.3	17	1826	1635	437880
3	3	90.4	17	1986	1674	598445
4	3	91.8	17	1151	1802	97088
5	3	98.2	17	1977	1766	257251
6	1	59.5	17	-	-	419893
7	2	80	17	1137	-	580724
8	3	86.5	17	1128	1828	77366
9	3	91.1	17	1599	1442	238032
10	3	93.5	17	1373	1087	398605
11	1	60.7	17	-	-	562025
12	2	67.2	17	1405	-	57684
13	1	61.8	17	-	-	219083
14	2	79.4	17	1667	-	379234
15	2	81.4	17	1464	-	540896
16	1	65.7	17	-	-	37916
17	2	76	17	1255	-	198794
18	2	81	17	1668	-	359754
19						
20						

DFS Radar Parameters
FCC Radar Type 1
Channel 102 Bandwidth 40MHz

Trial #	Pulse Repetition Frequency Number (1 to 23)	Pulse Repetition Frequency (Pulses Per Second)	Pulse Repetition Interval (Microseconds)	Detection (Yes / No)
1	22	1066.10	938	Yes
2	10	1432.66	698	Yes
3	6	1618.12	618	Yes
4	2	1858.74	538	Yes
5	19	1138.95	878	Yes
6	12	326.16	3066	Yes
7	7	1567.40	638	Yes
8	21	1089.32	918	Yes
9	17	1193.32	838	Yes
10	18	1165.50	858	Yes
11	15	1253.13	798	Yes
12	11	1392.76	718	Yes
13	4	1730.10	578	No
14	5	1672.24	598	Yes
15	3	1792.11	558	Yes
16		394.32	2536	Yes
17		1035.20	966	Yes
18		1209.19	827	Yes
19		399.84	2501	Yes
20		385.36	2595	Yes
21		897.67	1114	Yes
22		768.05	1302	Yes
23		328.41	3045	Yes
24		615.76	1624	Yes
25		347.46	2878	Yes
26		973.71	1027	Yes
27		402.41	2485	Yes
28		625.00	1600	Yes
29		853.24	1172	Yes
30		849.62	1177	Yes

DFS Radar Parameters
FCC Radar Type 2
Channel 102 Bandwidth 40MHz

Trial #	Number Pulses per Burst	Pulse Width (Microseconds)	Pulse Repetition Interval (Microseconds)	Detection (Yes / No)
1	26	3.20	179	Yes
2	23	1.10	207	Yes
3	24	2.10	230	Yes
4	29	4.80	200	Yes
5	28	3.90	214	Yes
6	26	2.90	222	Yes
7	26	3.20	204	Yes
8	25	2.50	192	Yes
9	26	3.10	164	Yes
10	23	1.20	156	Yes
11	27	3.90	210	Yes
12	29	4.60	201	Yes
13	26	3.20	162	Yes
14	25	2.20	197	Yes
15	29	4.50	163	Yes
16	26	3.00	203	Yes
17	29	5.00	168	Yes
18	25	2.40	217	Yes
19	26	2.90	191	Yes
20	25	2.30	166	Yes
21	27	3.70	150	Yes
22	25	2.20	176	Yes
23	29	4.90	195	Yes
24	26	2.90	202	Yes
25	25	2.50	178	Yes
26	23	1.10	206	Yes
27	27	3.80	155	Yes
28	29	4.70	157	Yes
29	25	2.40	224	Yes
30	28	4.20	159	Yes

DFS Radar Parameters
FCC Radar Type 3
Channel 102 Bandwidth 40MHz

Trial #	Number Pulses per Burst	Pulse Width (Microseconds)	Pulse Repetition Interval (Microseconds)	Detection (Yes / No)
1	17	8.20	355	Yes
2	16	6.10	487	Yes
3	16	7.10	344	Yes
4	18	9.80	288	Yes
5	18	8.90	230	Yes
6	17	7.90	432	Yes
7	17	8.20	207	Yes
8	17	7.50	443	Yes
9	17	8.10	439	Yes
10	16	6.20	223	Yes
11	18	8.90	208	Yes
12	18	9.60	463	Yes
13	17	8.20	441	Yes
14	16	7.20	323	Yes
15	18	9.50	297	Yes
16	17	8.00	412	Yes
17	18	10.00	324	Yes
18	17	7.40	271	Yes
19	17	7.90	349	Yes
20	16	7.30	409	Yes
21	18	8.70	373	Yes
22	16	7.20	254	Yes
23	18	9.90	274	Yes
24	17	7.90	278	Yes
25	17	7.50	317	Yes
26	16	6.10	260	Yes
27	18	8.80	211	Yes
28	18	9.70	272	Yes
29	17	7.40	264	Yes
30	18	9.20	284	Yes

DFS Radar Parameters
FCC Radar Type 4
Channel 102 Bandwidth 40MHz

Trial #	Number Pulses per Burst	Pulse Width (Microseconds)	Pulse Repetition Interval (Microseconds)	Detection (Yes / No)
1	14	16.00	355	Yes
2	12	11.30	487	Yes
3	13	13.50	344	Yes
4	16	19.40	288	Yes
5	15	17.50	230	Yes
6	14	15.30	432	Yes
7	14	15.90	207	Yes
8	13	14.30	443	Yes
9	14	15.80	439	Yes
10	12	11.50	223	Yes
11	15	17.40	208	Yes
12	16	19.00	463	Yes
13	14	16.00	441	Yes
14	13	13.80	323	Yes
15	16	18.90	297	Yes
16	14	15.50	412	Yes
17	16	19.90	324	Yes
18	13	14.10	271	Yes
19	14	15.20	349	Yes
20	13	13.80	409	Yes
21	15	17.10	373	Yes
22	13	13.80	254	Yes
23	16	19.80	274	Yes
24	14	15.30	278	Yes
25	13	14.50	317	Yes
26	12	11.30	260	Yes
27	15	17.30	211	Yes
28	16	19.20	272	Yes
29	13	14.20	264	Yes
30	15	18.20	284	Yes

DFS Radar Parameters
FCC Radar Type 5
Channel 102 Bandwidth 40MHz

Trial Number:			1			Detection (Yes/No)
Number of Bursts in Trial:			15			
Chirp Center Frequency:			5510			
Burst	Number of Pulses	Pulse Width (Microseconds)	Chirp Width (MHz)	Pulse 1-to-2 Spacing (µsec)	Pulse 2-to-3 Spacing (µsec)	Starting Location Within Interval (µsec)
1	2	77.8	13	1477	-	636185
2	1	51.9	13	-	-	32674
3	1	63.8	13	-	-	226294
4	3	96.6	13	1786	1843	417976
5	3	85.9	13	1215	1729	611152
6	2	73.7	13	1549	-	8789
7	2	77.2	13	1819	-	201917
8	2	68.4	13	1114	-	395530
9	2	76.7	13	1155	-	588564
10	1	53.2	13	-	-	783794
11	3	85.7	13	1695	1394	177933
12	3	94.3	13	1426	1935	370624
13	2	77.6	13	1671	-	564893
14	1	65.7	13	-	-	759583
15	3	93.5	13	1130	1468	154262
16						
17						
18						
19						
20						

Trial Number:			2			Detection (Yes/No)
Number of Bursts in Trial:			8			
Chirp Center Frequency:			5510			
Burst	Number of Pulses	Pulse Width (Microseconds)	Chirp Width (MHz)	Pulse 1-to-2 Spacing (µsec)	Pulse 2-to-3 Spacing (µsec)	Starting Location Within Interval (µsec)
1	2	75	5	1527	-	653020
2	3	99.4	5	1262	1257	1015643
3	2	67.4	5	1403	-	1379398
4	2	73.6	5	1041	-	245489
5	1	65.9	5	-	-	609113
6	3	83.8	5	1292	1419	970852
7	1	65.5	5	-	-	1335913
8	3	98.6	5	1796	1728	200406
9						
10						
11						
12						
13						
14						
15						
16						
17						
18						
19						
20						

DFS Radar Parameters
FCC Radar Type 5
Channel 102 Bandwidth 40MHz

Trial Number:			3			Detection (Yes/No)
Number of Bursts in Trial:			11			
Chirp Center Frequency:			5510			Yes
Burst	Number of Pulses	Pulse Width (Microseconds)	Chirp Width (MHz)	Pulse 1-to-2 Spacing (µsec)	Pulse 2-to-3 Spacing (µsec)	Starting Location Within Interval (µsec)
1	2	73.8	9	1538	-	409565
2	2	69.5	9	1649	-	673692
3	1	51.9	9	-	-	938562
4	3	84.6	9	1032	1271	113209
5	3	95.4	9	1903	1388	376726
6	2	68	9	1351	-	641212
7	3	89.6	9	1514	1573	903714
8	2	81.9	9	1689	-	80863
9	3	88.3	9	1330	1838	344067
10	1	53.7	9	-	-	609331
11	3	91.3	9	1106	1001	871542
12						
13						
14						
15						
16						
17						
18						
19						
20						

Trial Number:			4			Detection (Yes/No)
Number of Bursts in Trial:			20			
Chirp Center Frequency:			5510			Yes
Burst	Number of Pulses	Pulse Width (Microseconds)	Chirp Width (MHz)	Pulse 1-to-2 Spacing (µsec)	Pulse 2-to-3 Spacing (µsec)	Starting Location Within Interval (µsec)
1	2	68.1	19	1355	-	26541
2	1	58.7	19	-	-	171821
3	2	75.3	19	1640	-	316229
4	1	56.4	19	-	-	461864
5	3	99.7	19	1708	1159	8677
6	1	57.7	19	-	-	153995
7	1	59.5	19	-	-	299238
8	2	80	19	1369	-	443177
9	2	82	19	1197	-	587671
10	2	82.8	19	1005	-	135674
11	3	88	19	1928	1101	279928
12	3	93.2	19	1907	1223	424279
13	2	70.4	19	1360	-	570132
14	3	95.3	19	1955	1775	117439
15	2	81.9	19	1545	-	262502
16	3	98.5	19	1169	1062	406573
17	1	65	19	-	-	553328
18	3	85.4	19	1637	1425	99799
19	3	91.6	19	1445	1325	244095
20	2	67.3	19	1218	-	390012

DFS Radar Parameters
FCC Radar Type 5
Channel 102 Bandwidth 40MHz

Trial Number:			5			Detection (Yes/No)
Number of Bursts in Trial:			17			
Chirp Center Frequency:			5510			Yes
Burst	Number of Pulses	Pulse Width (Microseconds)	Chirp Width (MHz)	Pulse 1-to-2 Spacing (µsec)	Pulse 2-to-3 Spacing (µsec)	Starting Location Within Interval (µsec)
1	2	67.9	16	1133	-	629614
2	1	62.3	16	-	-	96856
3	1	53.3	16	-	-	267719
4	3	90	16	1153	1346	436784
5	2	77.1	16	1646	-	608289
6	3	83.9	16	1232	1459	75610
7	3	89.1	16	1384	1939	245638
8	2	81.8	16	1676	-	416355
9	1	50.3	16	-	-	588736
10	3	87.1	16	1996	1756	54571
11	2	71.3	16	1815	-	225175
12	3	97.5	16	1465	1132	394825
13	3	90.6	16	1040	1354	565361
14	3	86.3	16	1183	1792	33643
15	3	97.6	16	1073	1361	203957
16	3	84.7	16	1718	1854	373812
17	3	99.7	16	1244	1988	544060
18						
19						
20						

Trial Number:			6			Detection (Yes/No)
Number of Bursts in Trial:			14			
Chirp Center Frequency:			5510			Yes
Burst	Number of Pulses	Pulse Width (Microseconds)	Chirp Width (MHz)	Pulse 1-to-2 Spacing (µsec)	Pulse 2-to-3 Spacing (µsec)	Starting Location Within Interval (µsec)
1	3	92.9	12	1564	1407	15438
2	2	67.7	12	1747	-	222486
3	1	65.8	12	-	-	430731
4	1	56.3	12	-	-	637784
5	1	53.7	12	-	-	845342
6	3	83.5	12	1930	1025	196720
7	1	65.8	12	-	-	404955
8	3	85.9	12	1034	1808	610711
9	2	76.3	12	1926	-	818057
10	2	81.5	12	1714	-	171459
11	3	89.4	12	1594	1827	377969
12	1	63.4	12	-	-	586875
13	2	69.6	12	1925	-	792834
14	2	74.5	12	1846	-	146044
15						
16						
17						
18						
19						
20						

DFS Radar Parameters
FCC Radar Type 5
Channel 102 Bandwidth 40MHz

Trial Number:			7			Detection (Yes/No)
Number of Bursts in Trial:			15			
Chirp Center Frequency:			5510			
Burst	Number of Pulses	Pulse Width (Microseconds)	Chirp Width (MHz)	Pulse 1-to-2 Spacing (µsec)	Pulse 2-to-3 Spacing (µsec)	Starting Location Within Interval (µsec)
1	3	96.6	13	1609	1581	329022
2	3	96.7	13	1799	1154	521718
3	3	86.5	13	1396	1865	714222
4	2	73.3	13	1318	-	112450
5	1	55.8	13	-	-	306283
6	1	55.4	13	-	-	500239
7	3	85.3	13	1504	1820	690932
8	2	79.4	13	1893	-	88645
9	1	65.7	13	-	-	282508
10	2	68.6	13	1028	-	475842
11	2	77.7	13	1835	-	667887
12	2	79.6	13	1331	-	64845
13	3	94.9	13	1070	1349	257755
14	1	61.4	13	-	-	452335
15	3	90.6	13	1562	1887	643395
16						
17						
18						
19						
20						

Trial Number:			8			Detection (Yes/No)
Number of Bursts in Trial:			12			
Chirp Center Frequency:			5510			
Burst	Number of Pulses	Pulse Width (Microseconds)	Chirp Width (MHz)	Pulse 1-to-2 Spacing (µsec)	Pulse 2-to-3 Spacing (µsec)	Starting Location Within Interval (µsec)
1	1	52.6	10	-	-	51446
2	3	84.1	10	1725	1529	292696
3	3	97.7	10	1868	1805	533989
4	3	97.3	10	1446	1755	775564
5	3	98.8	10	1386	1302	21542
6	2	72.2	10	1184	-	263385
7	2	67.6	10	1027	-	505581
8	2	75.7	10	1871	-	747058
9	1	60.9	10	-	-	989976
10	1	64.2	10	-	-	234024
11	2	78.8	10	1604	-	475207
12	3	87.5	10	1712	1683	715825
13						
14						
15						
16						
17						
18						
19						
20						

DFS Radar Parameters
FCC Radar Type 5
Channel 102 Bandwidth 40MHz

Trial Number:			9			Detection (Yes/No)
Number of Bursts in Trial:			14			
Chirp Center Frequency:			5510			
Burst	Number of Pulses	Pulse Width (Microseconds)	Chirp Width (MHz)	Pulse 1-to-2 Spacing (µsec)	Pulse 2-to-3 Spacing (µsec)	Starting Location Within Interval (µsec)
1	1	54.1	13	-	-	823112
2	1	50.7	13	-	-	174965
3	1	52.3	13	-	-	382216
4	3	99.8	13	1696	1949	587395
5	2	68.4	13	1099	-	796897
6	2	80.8	13	1505	-	149042
7	1	62.5	13	-	-	356750
8	2	74.8	13	1204	-	563824
9	1	50.8	13	-	-	772314
10	1	54	13	-	-	123796
11	1	63	13	-	-	331215
12	3	91.8	13	1270	1347	537402
13	2	79.3	13	1992	-	744805
14	1	64.3	13	-	-	98172
15						
16						
17						
18						
19						
20						

Trial Number:			10			Detection (Yes/No)
Number of Bursts in Trial:			8			
Chirp Center Frequency:			5510			
Burst	Number of Pulses	Pulse Width (Microseconds)	Chirp Width (MHz)	Pulse 1-to-2 Spacing (µsec)	Pulse 2-to-3 Spacing (µsec)	Starting Location Within Interval (µsec)
1	1	63.4	6	-	-	535615
2	1	52	6	-	-	898668
3	3	97.2	6	1605	1583	1259235
4	2	78.7	6	1743	-	127106
5	2	74.2	6	1219	-	490358
6	3	88.7	6	1934	1273	852409
7	1	54.3	6	-	-	1217152
8	3	95.4	6	1555	1791	82296
9						
10						
11						
12						
13						
14						
15						
16						
17						
18						
19						
20						

DFS Radar Parameters
FCC Radar Type 5
Channel 102 Bandwidth 40MHz

Trial Number:			11			Detection (Yes/No)
Number of Bursts in Trial:			17			
Chirp Center Frequency:			5498			
Burst	Number of Pulses	Pulse Width (Microseconds)	Chirp Width (MHz)	Pulse 1-to-2 Spacing (µsec)	Pulse 2-to-3 Spacing (µsec)	Starting Location Within Interval (µsec)
1	2	73.7	16	1497	-	209249
2	3	97.4	16	1754	1613	378386
3	3	91.7	16	1702	1462	548411
4	1	66.2	16	-	-	17733
5	2	70.8	16	1821	-	187952
6	1	52.3	16	-	-	359277
7	2	78.9	16	1984	-	528886
8	2	70.9	16	1358	-	700166
9	2	75.6	16	1430	-	167197
10	1	59.1	16	-	-	338262
11	2	77	16	1304	-	508324
12	2	67.9	16	1083	-	678689
13	2	81.2	16	1932	-	146031
14	2	78.7	16	1121	-	316923
15	1	63.3	16	-	-	488056
16	2	68.9	16	1423	-	657326
17	1	59.3	16	-	-	125509
18						
19						
20						

Trial Number:			12			Detection (Yes/No)
Number of Bursts in Trial:			19			
Chirp Center Frequency:			5499			
Burst	Number of Pulses	Pulse Width (Microseconds)	Chirp Width (MHz)	Pulse 1-to-2 Spacing (µsec)	Pulse 2-to-3 Spacing (µsec)	Starting Location Within Interval (µsec)
1	3	98.9	19	1680	1488	263736
2	2	82.3	19	1855	-	416459
3	3	86.7	19	1400	1919	567902
4	3	89.7	19	1068	1282	92979
5	3	98.6	19	1194	1461	245155
6	2	71.1	19	1789	-	397609
7	1	55.9	19	-	-	551431
8	2	67.9	19	1372	-	74413
9	3	84.4	19	1107	1443	226559
10	1	58.8	19	-	-	380056
11	1	65.6	19	-	-	533408
12	2	78.5	19	1704	-	55547
13	2	82.3	19	1686	-	207876
14	3	90.1	19	1071	1266	359771
15	3	90.2	19	1089	1950	511297
16	2	83.1	19	1406	-	36803
17	1	58.8	19	-	-	189652
18	2	77	19	1657	-	341809
19	1	55	19	-	-	495737
20						

DFS Radar Parameters
FCC Radar Type 5
Channel 102 Bandwidth 40MHz

Trial Number:			13			Detection (Yes/No)
Number of Bursts in Trial:			15			
Chirp Center Frequency:			5497			
Burst	Number of Pulses	Pulse Width (Microseconds)	Chirp Width (MHz)	Pulse 1-to-2 Spacing (µsec)	Pulse 2-to-3 Spacing (µsec)	Starting Location Within Interval (µsec)
1	1	58.1	13	-	-	22911
2	1	52.1	13	-	-	216473
3	1	59.9	13	-	-	410004
4	1	60.2	13	-	-	603671
5	3	95.9	13	1906	1608	794160
6	2	79.9	13	1859	-	192251
7	2	78.5	13	1917	-	385590
8	1	53.8	13	-	-	579862
9	1	64.7	13	-	-	773423
10	1	61.4	13	-	-	168898
11	2	83.2	13	1858	-	361606
12	3	84.7	13	1677	1638	553866
13	3	88.7	13	1528	1058	747241
14	2	78.3	13	1951	-	144710
15	2	69.3	13	1717	-	337856
16						
17						
18						
19						
20						

Trial Number:			14			Detection (Yes/No)
Number of Bursts in Trial:			12			
Chirp Center Frequency:			5496			
Burst	Number of Pulses	Pulse Width (Microseconds)	Chirp Width (MHz)	Pulse 1-to-2 Spacing (µsec)	Pulse 2-to-3 Spacing (µsec)	Starting Location Within Interval (µsec)
1	2	75.3	10	1612	-	664275
2	1	56.3	10	-	-	907886
3	2	67.7	10	1185	-	151316
4	1	55.6	10	-	-	393746
5	2	75.2	10	1267	-	635093
6	2	76.3	10	1305	-	876993
7	3	85.7	10	1362	1924	121278
8	3	98.4	10	1550	1249	362696
9	3	86.4	10	1439	1046	604342
10	3	93.6	10	1031	1452	846453
11	1	63.3	10	-	-	91871
12	3	92.4	10	1673	1322	333050
13						
14						
15						
16						
17						
18						
19						
20						

DFS Radar Parameters
FCC Radar Type 5
Channel 102 Bandwidth 40MHz

Trial Number:			15			Detection (Yes/No)
Number of Bursts in Trial:			19			
Chirp Center Frequency:			5499			
Burst	Number of Pulses	Pulse Width (Microseconds)	Chirp Width (MHz)	Pulse 1-to-2 Spacing (µsec)	Pulse 2-to-3 Spacing (µsec)	Starting Location Within Interval (µsec)
1	3	93.3	18	1912	1535	361323
2	2	69.1	18	1794	-	515261
3	3	86.9	18	1152	1148	39025
4	3	84.9	18	1948	1118	190900
5	2	72.3	18	1916	-	343941
6	1	51.7	18	-	-	497624
7	1	58.3	18	-	-	20319
8	1	60.8	18	-	-	172999
9	1	57.1	18	-	-	325872
10	3	88.9	18	1964	1489	475841
11	2	72	18	1297	-	1489
12	3	90.9	18	1566	1370	153647
13	1	59.8	18	-	-	307096
14	2	70	18	1291	-	458804
15	2	67.2	18	1881	-	610798
16	3	91.2	18	1832	1661	134759
17	1	56.5	18	-	-	288306
18	1	51.2	18	-	-	441296
19	2	74.1	18	1245	-	592780
20						

Trial Number:			16			Detection (Yes/No)
Number of Bursts in Trial:			14			
Chirp Center Frequency:			5497			
Burst	Number of Pulses	Pulse Width (Microseconds)	Chirp Width (MHz)	Pulse 1-to-2 Spacing (µsec)	Pulse 2-to-3 Spacing (µsec)	Starting Location Within Interval (µsec)
1	2	76.9	12	1140	-	158286
2	1	50.2	12	-	-	366024
3	1	62.9	12	-	-	573452
4	1	64.7	12	-	-	780619
5	3	83.8	12	1097	1621	132455
6	1	65.4	12	-	-	340207
7	1	53.2	12	-	-	548208
8	1	51.7	12	-	-	755333
9	2	78.7	12	1168	-	107117
10	2	72.4	12	1343	-	314500
11	1	53.8	12	-	-	522447
12	2	73.6	12	1553	-	728517
13	2	66.7	12	1122	-	81611
14	2	82.5	12	1019	-	288948
15						
16						
17						
18						
19						
20						

DFS Radar Parameters
FCC Radar Type 5
Channel 102 Bandwidth 40MHz

Trial Number:			17			Detection (Yes/No)
Number of Bursts in Trial:			20			
Chirp Center Frequency:			5500			
Burst	Number of Pulses	Pulse Width (Microseconds)	Chirp Width (MHz)	Pulse 1-to-2 Spacing (µsec)	Pulse 2-to-3 Spacing (µsec)	Starting Location Within Interval (µsec)
1	3	87.6	20	1055	1840	345766
2	3	85.2	20	1541	1408	490019
3	3	84.8	20	1889	1463	39073
4	2	77.9	20	1460	-	183923
5	2	76.5	20	1485	-	328777
6	1	60.9	20	-	-	474728
7	2	83	20	1010	-	21394
8	2	80.4	20	1752	-	165992
9	2	67.5	20	1181	-	310973
10	1	62.1	20	-	-	456884
11	3	86.4	20	1966	1263	3515
12	3	84.3	20	1188	1788	147928
13	2	76.9	20	1537	-	293225
14	3	95.8	20	1298	1844	436922
15	1	55.2	20	-	-	584015
16	1	59	20	-	-	130832
17	3	94.5	20	1700	1283	274684
18	3	91.9	20	1978	1165	418579
19	3	85.2	20	1551	1189	563464
20	2	69.5	20	1224	-	112787

Trial Number:			18			Detection (Yes/No)
Number of Bursts in Trial:			12			
Chirp Center Frequency:			5496			
Burst	Number of Pulses	Pulse Width (Microseconds)	Chirp Width (MHz)	Pulse 1-to-2 Spacing (µsec)	Pulse 2-to-3 Spacing (µsec)	Starting Location Within Interval (µsec)
1	3	86.4	10	1918	1455	429224
2	3	92.2	10	1719	1895	670241
3	2	80.4	10	1899	-	912880
4	1	54.3	10	-	-	158603
5	1	53.1	10	-	-	400824
6	2	69.4	10	1546	-	641915
7	2	69.1	10	1639	-	883823
8	3	100	10	1438	1595	128373
9	2	79.6	10	1705	-	370379
10	3	88.4	10	1579	1623	611194
11	1	53.3	10	-	-	855665
12	1	65.3	10	-	-	98897
13						
14						
15						
16						
17						
18						
19						
20						

DFS Radar Parameters
FCC Radar Type 5
Channel 102 Bandwidth 40MHz

Trial Number:			19			Detection (Yes/No)
Number of Bursts in Trial:			14			
Chirp Center Frequency:			5497			
Burst	Number of Pulses	Pulse Width (Microseconds)	Chirp Width (MHz)	Pulse 1-to-2 Spacing (µsec)	Pulse 2-to-3 Spacing (µsec)	Starting Location Within Interval (µsec)
1	1	55.3	12	-	-	292143
2	1	58.3	12	-	-	499633
3	2	72.3	12	1039	-	706377
4	3	84.8	12	1761	1721	58989
5	2	82.5	12	1431	-	266161
6	1	63.3	12	-	-	474469
7	2	80	12	1913	-	680544
8	3	90.3	12	1853	1123	33519
9	3	91.1	12	1783	1172	240319
10	3	96.6	12	1036	1385	447400
11	2	82.7	12	1990	-	654516
12	1	50.7	12	-	-	8083
13	2	78.4	12	1109	-	215435
14	3	99.5	12	1965	1869	421325
15						
16						
17						
18						
19						
20						

Trial Number:			20			Detection (Yes/No)
Number of Bursts in Trial:			12			
Chirp Center Frequency:			5496			
Burst	Number of Pulses	Pulse Width (Microseconds)	Chirp Width (MHz)	Pulse 1-to-2 Spacing (µsec)	Pulse 2-to-3 Spacing (µsec)	Starting Location Within Interval (µsec)
1	3	88.6	10	1067	1927	733725
2	1	57.4	10	-	-	977882
3	3	96.6	10	1658	1324	221197
4	2	69.7	10	1945	-	462915
5	2	77.9	10	1317	-	705071
6	1	62	10	-	-	947923
7	3	88.4	10	1077	1366	191373
8	3	97.3	10	1896	1367	432561
9	3	96.2	10	1787	1672	674004
10	3	95.4	10	1892	1414	915842
11	1	54.8	10	-	-	162176
12	2	80.4	10	1436	-	403553
13						
14						
15						
16						
17						
18						
19						
20						

DFS Radar Parameters
FCC Radar Type 5
Channel 102 Bandwidth 40MHz

Trial Number:			21			Detection (Yes/No)
Number of Bursts in Trial:			16			
Chirp Center Frequency:			5522			
Burst	Number of Pulses	Pulse Width (Microseconds)	Chirp Width (MHz)	Pulse 1-to-2 Spacing (µsec)	Pulse 2-to-3 Spacing (µsec)	Starting Location Within Interval (µsec)
1	2	74.7	15	1611	-	483470
2	1	57.1	15	-	-	666072
3	3	91.9	15	1475	1276	98810
4	2	83.1	15	1772	-	279914
5	1	50.7	15	-	-	462536
6	2	79.2	15	1600	-	642324
7	1	58.7	15	-	-	76831
8	2	71	15	1567	-	257785
9	2	79	15	1960	-	438554
10	2	68.5	15	1428	-	620397
11	2	73.5	15	1352	-	54310
12	2	70.5	15	1115	-	235506
13	2	76.6	15	1300	-	417036
14	2	81.2	15	1675	-	597974
15	1	61.8	15	-	-	32086
16	3	94.9	15	1206	1860	212751
17						
18						
19						
20						

Trial Number:			22			Detection (Yes/No)
Number of Bursts in Trial:			12			
Chirp Center Frequency:			5525			
Burst	Number of Pulses	Pulse Width (Microseconds)	Chirp Width (MHz)	Pulse 1-to-2 Spacing (µsec)	Pulse 2-to-3 Spacing (µsec)	Starting Location Within Interval (µsec)
1	2	78.5	9	1698	-	526149
2	3	89.8	9	1962	1167	767135
3	1	59.4	9	-	-	12955
4	2	79.6	9	1890	-	254612
5	2	76	9	1811	-	496588
6	1	53.6	9	-	-	739728
7	2	80.9	9	1053	-	980872
8	1	61.6	9	-	-	225249
9	1	53.4	9	-	-	467279
10	1	59.9	9	-	-	709720
11	1	60.4	9	-	-	951847
12	3	91.4	9	1726	1227	194839
13						
14						
15						
16						
17						
18						
19						
20						

DFS Radar Parameters
FCC Radar Type 5
Channel 102 Bandwidth 40MHz

Trial Number:		23				Detection (Yes/No)
Number of Bursts in Trial:		20				
Chirp Center Frequency:		5520				Yes
Burst	Number of Pulses	Pulse Width (Microseconds)	Chirp Width (MHz)	Pulse 1-to-2 Spacing (μ sec)	Pulse 2-to-3 Spacing (μ sec)	Starting Location Within Interval (μ sec)
1	2	77	20	1363	-	261858
2	1	58.1	20	-	-	407646
3	1	62.1	20	-	-	552319
4	2	76.9	20	1236	-	99107
5	2	80	20	1852	-	243514
6	1	52	20	-	-	389464
7	3	88.6	20	1995	1905	531093
8	2	72.9	20	1387	-	81159
9	3	98.5	20	1746	1389	225245
10	1	57.9	20	-	-	371906
11	3	95.9	20	1870	1066	514197
12	1	53.5	20	-	-	63561
13	3	92	20	1654	1458	207510
14	1	57.3	20	-	-	353638
15	2	70.5	20	1586	-	497515
16	2	70	20	1664	-	45553
17	3	84	20	1630	1176	189821
18	2	76.1	20	1057	-	335330
19	3	93.2	20	1018	1340	478825
20	3	96.8	20	1614	1817	27594

Trial Number:		24				Detection (Yes/No)
Number of Bursts in Trial:		14				
Chirp Center Frequency:		5523				Yes
Burst	Number of Pulses	Pulse Width (Microseconds)	Chirp Width (MHz)	Pulse 1-to-2 Spacing (μ sec)	Pulse 2-to-3 Spacing (μ sec)	Starting Location Within Interval (μ sec)
1	1	50.1	12	-	-	247117
2	3	93.5	12	1081	1413	453362
3	2	68.8	12	1577	-	660875
4	1	56.3	12	-	-	14140
5	3	86	12	1108	1987	220734
6	2	75.2	12	1536	-	428367
7	1	54.4	12	-	-	636681
8	2	71.1	12	1243	-	843157
9	2	76.2	12	1770	-	195585
10	2	80.2	12	1209	-	403231
11	2	79.7	12	1214	-	610202
12	3	90.9	12	1862	1601	815229
13	2	68.7	12	1441	-	170267
14	2	67.4	12	1313	-	377306
15						
16						
17						
18						
19						
20						

DFS Radar Parameters
FCC Radar Type 5
Channel 102 Bandwidth 40MHz

Trial Number:			25			Detection (Yes/No)
Number of Bursts in Trial:			13			
Chirp Center Frequency:			5524			
Burst	Number of Pulses	Pulse Width (Microseconds)	Chirp Width (MHz)	Pulse 1-to-2 Spacing (µsec)	Pulse 2-to-3 Spacing (µsec)	Starting Location Within Interval (µsec)
1	3	94	11	1748	1941	628071
2	2	70.8	11	1201	-	853391
3	1	56.3	11	-	-	156223
4	3	96.7	11	1163	1332	378734
5	3	90.6	11	1582	1498	601331
6	2	74.5	11	1281	-	825462
7	3	92.6	11	1669	1222	128265
8	3	89	11	1135	1380	351161
9	3	96.5	11	1822	1602	573425
10	2	70.5	11	1178	-	798431
11	3	94	11	1629	1956	100737
12	1	55.8	11	-	-	324661
13	3	87.7	11	1963	1164	546278
14						
15						
16						
17						
18						
19						
20						

Trial Number:			26			Detection (Yes/No)
Number of Bursts in Trial:			8			
Chirp Center Frequency:			5526			
Burst	Number of Pulses	Pulse Width (Microseconds)	Chirp Width (MHz)	Pulse 1-to-2 Spacing (µsec)	Pulse 2-to-3 Spacing (µsec)	Starting Location Within Interval (µsec)
1	2	68.6	5	1161	-	1253842
2	2	83.1	5	1315	-	119486
3	1	60.9	5	-	-	482958
4	2	77.7	5	1158	-	845641
5	2	77.4	5	1510	-	1208428
6	2	66.8	5	1323	-	74748
7	1	63.7	5	-	-	438300
8	3	91.2	5	1681	1275	800152
9						
10						
11						
12						
13						
14						
15						
16						
17						
18						
19						
20						

DFS Radar Parameters
FCC Radar Type 5
Channel 102 Bandwidth 40MHz

Trial Number:		27				Detection (Yes/No)
Number of Bursts in Trial:		17				
Chirp Center Frequency:		5522				Yes
Burst	Number of Pulses	Pulse Width (Microseconds)	Chirp Width (MHz)	Pulse 1-to-2 Spacing (µsec)	Pulse 2-to-3 Spacing (µsec)	Starting Location Within Interval (µsec)
1	3	83.6	16	1195	1000	545865
2	3	89.4	16	1627	1656	14067
3	1	55.8	16	-	-	184953
4	3	90.9	16	1554	1998	353759
5	1	54.7	16	-	-	526388
6	3	97.7	16	1202	1250	694806
7	2	67.5	16	1434	-	163568
8	3	96.7	16	1469	1268	333410
9	2	68.3	16	1954	-	504006
10	2	78.3	16	1082	-	675297
11	1	55	16	-	-	142890
12	3	84.9	16	1936	1199	312479
13	2	74.6	16	1856	-	482953
14	1	63.3	16	-	-	655022
15	3	99.8	16	1515	1120	121457
16	1	63.6	16	-	-	292606
17	3	87.3	16	1051	1831	461322
18						
19						
20						

Trial Number:		28				Detection (Yes/No)
Number of Bursts in Trial:		19				
Chirp Center Frequency:		5521				Yes
Burst	Number of Pulses	Pulse Width (Microseconds)	Chirp Width (MHz)	Pulse 1-to-2 Spacing (µsec)	Pulse 2-to-3 Spacing (µsec)	Starting Location Within Interval (µsec)
1	3	85.6	19	1078	1015	565136
2	2	68.6	19	1780	-	89970
3	1	54.2	19	-	-	243121
4	1	61.2	19	-	-	396034
5	3	97.1	19	1969	1100	546225
6	3	98.3	19	1699	1622	70998
7	1	62.4	19	-	-	224093
8	2	80.2	19	1769	-	376127
9	3	87.5	19	1448	1179	527806
10	3	85.8	19	1348	1472	52247
11	3	88.1	19	1124	1631	204582
12	1	65.3	19	-	-	357941
13	1	52.5	19	-	-	510977
14	1	52.3	19	-	-	33698
15	2	74.1	19	1200	-	186023
16	1	54.9	19	-	-	339327
17	2	76.2	19	1502	-	491053
18	1	60.4	19	-	-	14858
19	2	81.5	19	1103	-	167387
20						

DFS Radar Parameters
FCC Radar Type 5
Channel 102 Bandwidth 40MHz

Trial Number:			29			Detection (Yes/No)
Number of Bursts in Trial:			12			
Chirp Center Frequency:			5524			
Burst	Number of Pulses	Pulse Width (Microseconds)	Chirp Width (MHz)	Pulse 1-to-2 Spacing (µsec)	Pulse 2-to-3 Spacing (µsec)	Starting Location Within Interval (µsec)
1	1	50.5	10	-	-	507709
2	1	55.7	10	-	-	750249
3	3	85.8	10	1002	1967	989003
4	2	76.9	10	1474	-	235634
5	2	75.1	10	1052	-	477675
6	3	92.3	10	1486	1492	718312
7	2	78.1	10	1757	-	960895
8	3	92.2	10	1252	1713	205370
9	3	89	10	1706	1411	446940
10	2	70.9	10	1620	-	689225
11	1	63.1	10	-	-	932305
12	1	55.3	10	-	-	176231
13						
14						
15						
16						
17						
18						
19						
20						

Trial Number:			30			Detection (Yes/No)
Number of Bursts in Trial:			18			
Chirp Center Frequency:			5521			
Burst	Number of Pulses	Pulse Width (Microseconds)	Chirp Width (MHz)	Pulse 1-to-2 Spacing (µsec)	Pulse 2-to-3 Spacing (µsec)	Starting Location Within Interval (µsec)
1	3	83.4	17	1205	1801	277485
2	3	97.3	17	1826	1635	437880
3	3	90.4	17	1986	1674	598445
4	3	91.8	17	1151	1802	97088
5	3	98.2	17	1977	1766	257251
6	1	59.5	17	-	-	419893
7	2	80	17	1137	-	580724
8	3	86.5	17	1128	1828	77366
9	3	91.1	17	1599	1442	238032
10	3	93.5	17	1373	1087	398605
11	1	60.7	17	-	-	562025
12	2	67.2	17	1405	-	57684
13	1	61.8	17	-	-	219083
14	2	79.4	17	1667	-	379234
15	2	81.4	17	1464	-	540896
16	1	65.7	17	-	-	37916
17	2	76	17	1255	-	198794
18	2	81	17	1668	-	359754
19						
20						

DFS Radar Parameters
FCC Radar Type 1
Channel 106 Bandwidth 80MHz

Trial #	Pulse Repetition Frequency Number (1 to 23)	Pulse Repetition Frequency (Pulses Per Second)	Pulse Repetition Interval (Microseconds)	Detection (Yes / No)
1	22	1066.10	938	Yes
2	10	1432.66	698	Yes
3	6	1618.12	618	Yes
4	2	1858.74	538	Yes
5	19	1138.95	878	Yes
6	12	326.16	3066	Yes
7	7	1567.40	638	Yes
8	21	1089.32	918	Yes
9	17	1193.32	838	Yes
10	18	1165.50	858	Yes
11	15	1253.13	798	Yes
12	11	1392.76	718	No
13	4	1730.10	578	Yes
14	5	1672.24	598	Yes
15	3	1792.11	558	Yes
16		394.32	2536	Yes
17		1035.20	966	Yes
18		1209.19	827	Yes
19		399.84	2501	Yes
20		385.36	2595	Yes
21		897.67	1114	Yes
22		768.05	1302	Yes
23		328.41	3045	Yes
24		615.76	1624	Yes
25		347.46	2878	Yes
26		973.71	1027	Yes
27		402.41	2485	Yes
28		625.00	1600	Yes
29		853.24	1172	Yes
30		849.62	1177	Yes

DFS Radar Parameters
FCC Radar Type 2
Channel 106 Bandwidth 80MHz

Trial #	Number Pulses per Burst	Pulse Width (Microseconds)	Pulse Repetition Interval (Microseconds)	Detection (Yes / No)
1	26	3.20	179	Yes
2	23	1.10	207	Yes
3	24	2.10	230	Yes
4	29	4.80	200	Yes
5	28	3.90	214	Yes
6	26	2.90	222	Yes
7	26	3.20	204	Yes
8	25	2.50	192	Yes
9	26	3.10	164	Yes
10	23	1.20	156	Yes
11	27	3.90	210	Yes
12	29	4.60	201	Yes
13	26	3.20	162	Yes
14	25	2.20	197	Yes
15	29	4.50	163	Yes
16	26	3.00	203	Yes
17	29	5.00	168	Yes
18	25	2.40	217	Yes
19	26	2.90	191	Yes
20	25	2.30	166	Yes
21	27	3.70	150	Yes
22	25	2.20	176	Yes
23	29	4.90	195	Yes
24	26	2.90	202	Yes
25	25	2.50	178	Yes
26	23	1.10	206	Yes
27	27	3.80	155	Yes
28	29	4.70	157	Yes
29	25	2.40	224	Yes
30	28	4.20	159	Yes

DFS Radar Parameters
FCC Radar Type 3
Channel 106 Bandwidth 80MHz

Trial #	Number Pulses per Burst	Pulse Width (Microseconds)	Pulse Repetition Interval (Microseconds)	Detection (Yes / No)
1	17	8.20	355	Yes
2	16	6.10	487	Yes
3	16	7.10	344	Yes
4	18	9.80	288	Yes
5	18	8.90	230	Yes
6	17	7.90	432	Yes
7	17	8.20	207	Yes
8	17	7.50	443	Yes
9	17	8.10	439	Yes
10	16	6.20	223	Yes
11	18	8.90	208	Yes
12	18	9.60	463	Yes
13	17	8.20	441	Yes
14	16	7.20	323	Yes
15	18	9.50	297	Yes
16	17	8.00	412	Yes
17	18	10.00	324	Yes
18	17	7.40	271	Yes
19	17	7.90	349	Yes
20	16	7.30	409	Yes
21	18	8.70	373	Yes
22	16	7.20	254	Yes
23	18	9.90	274	Yes
24	17	7.90	278	Yes
25	17	7.50	317	Yes
26	16	6.10	260	Yes
27	18	8.80	211	Yes
28	18	9.70	272	Yes
29	17	7.40	264	Yes
30	18	9.20	284	Yes

DFS Radar Parameters
FCC Radar Type 4
Channel 106 Bandwidth 80MHz

Trial #	Number Pulses per Burst	Pulse Width (Microseconds)	Pulse Repetition Interval (Microseconds)	Detection (Yes / No)
1	14	16.00	355	Yes
2	12	11.30	487	Yes
3	13	13.50	344	Yes
4	16	19.40	288	Yes
5	15	17.50	230	Yes
6	14	15.30	432	Yes
7	14	15.90	207	Yes
8	13	14.30	443	Yes
9	14	15.80	439	Yes
10	12	11.50	223	Yes
11	15	17.40	208	Yes
12	16	19.00	463	Yes
13	14	16.00	441	Yes
14	13	13.80	323	Yes
15	16	18.90	297	Yes
16	14	15.50	412	Yes
17	16	19.90	324	Yes
18	13	14.10	271	Yes
19	14	15.20	349	Yes
20	13	13.80	409	Yes
21	15	17.10	373	Yes
22	13	13.80	254	Yes
23	16	19.80	274	Yes
24	14	15.30	278	Yes
25	13	14.50	317	Yes
26	12	11.30	260	Yes
27	15	17.30	211	Yes
28	16	19.20	272	Yes
29	13	14.20	264	Yes
30	15	18.20	284	Yes

DFS Radar Parameters
FCC Radar Type 5
Channel 106 Bandwidth 80MHz

Trial Number:			1			Detection (Yes/No)
Number of Bursts in Trial:			15			
Chirp Center Frequency:			5530			
Burst	Number of Pulses	Pulse Width (Microseconds)	Chirp Width (MHz)	Pulse 1-to-2 Spacing (µsec)	Pulse 2-to-3 Spacing (µsec)	Starting Location Within Interval (µsec)
1	2	77.8	13	1477	-	636185
2	1	51.9	13	-	-	32674
3	1	63.8	13	-	-	226294
4	3	96.6	13	1786	1843	417976
5	3	85.9	13	1215	1729	611152
6	2	73.7	13	1549	-	8789
7	2	77.2	13	1819	-	201917
8	2	68.4	13	1114	-	395530
9	2	76.7	13	1155	-	588564
10	1	53.2	13	-	-	783794
11	3	85.7	13	1695	1394	177933
12	3	94.3	13	1426	1935	370624
13	2	77.6	13	1671	-	564893
14	1	65.7	13	-	-	759583
15	3	93.5	13	1130	1468	154262
16						
17						
18						
19						
20						

Trial Number:			2			Detection (Yes/No)
Number of Bursts in Trial:			8			
Chirp Center Frequency:			5530			
Burst	Number of Pulses	Pulse Width (Microseconds)	Chirp Width (MHz)	Pulse 1-to-2 Spacing (µsec)	Pulse 2-to-3 Spacing (µsec)	Starting Location Within Interval (µsec)
1	2	75	5	1527	-	653020
2	3	99.4	5	1262	1257	1015643
3	2	67.4	5	1403	-	1379398
4	2	73.6	5	1041	-	245489
5	1	65.9	5	-	-	609113
6	3	83.8	5	1292	1419	970852
7	1	65.5	5	-	-	1335913
8	3	98.6	5	1796	1728	200406
9						
10						
11						
12						
13						
14						
15						
16						
17						
18						
19						
20						

DFS Radar Parameters
FCC Radar Type 5
Channel 106 Bandwidth 80MHz

Trial Number:			3			Detection (Yes/No) Yes
Number of Bursts in Trial:			11			
Chirp Center Frequency:			5530			
Burst	Number of Pulses	Pulse Width (Microseconds)	Chirp Width (MHz)	Pulse 1-to-2 Spacing (µsec)	Pulse 2-to-3 Spacing (µsec)	Starting Location Within Interval (µsec)
1	2	73.8	9	1538	-	409565
2	2	69.5	9	1649	-	673692
3	1	51.9	9	-	-	938562
4	3	84.6	9	1032	1271	113209
5	3	95.4	9	1903	1388	376726
6	2	68	9	1351	-	641212
7	3	89.6	9	1514	1573	903714
8	2	81.9	9	1689	-	80863
9	3	88.3	9	1330	1838	344067
10	1	53.7	9	-	-	609331
11	3	91.3	9	1106	1001	871542
12						
13						
14						
15						
16						
17						
18						
19						
20						

Trial Number:			4			Detection (Yes/No) Yes
Number of Bursts in Trial:			20			
Chirp Center Frequency:			5530			
Burst	Number of Pulses	Pulse Width (Microseconds)	Chirp Width (MHz)	Pulse 1-to-2 Spacing (µsec)	Pulse 2-to-3 Spacing (µsec)	Starting Location Within Interval (µsec)
1	2	68.1	19	1355	-	26541
2	1	58.7	19	-	-	171821
3	2	75.3	19	1640	-	316229
4	1	56.4	19	-	-	461864
5	3	99.7	19	1708	1159	8677
6	1	57.7	19	-	-	153995
7	1	59.5	19	-	-	299238
8	2	80	19	1369	-	443177
9	2	82	19	1197	-	587671
10	2	82.8	19	1005	-	135674
11	3	88	19	1928	1101	279928
12	3	93.2	19	1907	1223	424279
13	2	70.4	19	1360	-	570132
14	3	95.3	19	1955	1775	117439
15	2	81.9	19	1545	-	262502
16	3	98.5	19	1169	1062	406573
17	1	65	19	-	-	553328
18	3	85.4	19	1637	1425	99799
19	3	91.6	19	1445	1325	244095
20	2	67.3	19	1218	-	390012

DFS Radar Parameters
FCC Radar Type 5
Channel 106 Bandwidth 80MHz

Trial Number:			5			Detection (Yes/No)
Number of Bursts in Trial:			17			
Chirp Center Frequency:			5530			Yes
Burst	Number of Pulses	Pulse Width (Microseconds)	Chirp Width (MHz)	Pulse 1-to-2 Spacing (μ sec)	Pulse 2-to-3 Spacing (μ sec)	Starting Location Within Interval (μ sec)
1	2	67.9	16	1133	-	629614
2	1	62.3	16	-	-	96856
3	1	53.3	16	-	-	267719
4	3	90	16	1153	1346	436784
5	2	77.1	16	1646	-	608289
6	3	83.9	16	1232	1459	75610
7	3	89.1	16	1384	1939	245638
8	2	81.8	16	1676	-	416355
9	1	50.3	16	-	-	588736
10	3	87.1	16	1996	1756	54571
11	2	71.3	16	1815	-	225175
12	3	97.5	16	1465	1132	394825
13	3	90.6	16	1040	1354	565361
14	3	86.3	16	1183	1792	33643
15	3	97.6	16	1073	1361	203957
16	3	84.7	16	1718	1854	373812
17	3	99.7	16	1244	1988	544060
18						
19						
20						

Trial Number:			6			Detection (Yes/No)
Number of Bursts in Trial:			14			
Chirp Center Frequency:			5530			Yes
Burst	Number of Pulses	Pulse Width (Microseconds)	Chirp Width (MHz)	Pulse 1-to-2 Spacing (μ sec)	Pulse 2-to-3 Spacing (μ sec)	Starting Location Within Interval (μ sec)
1	3	92.9	12	1564	1407	15438
2	2	67.7	12	1747	-	222486
3	1	65.8	12	-	-	430731
4	1	56.3	12	-	-	637784
5	1	53.7	12	-	-	845342
6	3	83.5	12	1930	1025	196720
7	1	65.8	12	-	-	404955
8	3	85.9	12	1034	1808	610711
9	2	76.3	12	1926	-	818057
10	2	81.5	12	1714	-	171459
11	3	89.4	12	1594	1827	377969
12	1	63.4	12	-	-	586875
13	2	69.6	12	1925	-	792834
14	2	74.5	12	1846	-	146044
15						
16						
17						
18						
19						
20						

DFS Radar Parameters
FCC Radar Type 5
Channel 106 Bandwidth 80MHz

Trial Number:			7			Detection (Yes/No)
Number of Bursts in Trial:			15			
Chirp Center Frequency:			5530			
Burst	Number of Pulses	Pulse Width (Microseconds)	Chirp Width (MHz)	Pulse 1-to-2 Spacing (µsec)	Pulse 2-to-3 Spacing (µsec)	Starting Location Within Interval (µsec)
1	3	96.6	13	1609	1581	329022
2	3	96.7	13	1799	1154	521718
3	3	86.5	13	1396	1865	714222
4	2	73.3	13	1318	-	112450
5	1	55.8	13	-	-	306283
6	1	55.4	13	-	-	500239
7	3	85.3	13	1504	1820	690932
8	2	79.4	13	1893	-	88645
9	1	65.7	13	-	-	282508
10	2	68.6	13	1028	-	475842
11	2	77.7	13	1835	-	667887
12	2	79.6	13	1331	-	64845
13	3	94.9	13	1070	1349	257755
14	1	61.4	13	-	-	452335
15	3	90.6	13	1562	1887	643395
16						
17						
18						
19						
20						

Trial Number:			8			Detection (Yes/No)
Number of Bursts in Trial:			12			
Chirp Center Frequency:			5530			
Burst	Number of Pulses	Pulse Width (Microseconds)	Chirp Width (MHz)	Pulse 1-to-2 Spacing (µsec)	Pulse 2-to-3 Spacing (µsec)	Starting Location Within Interval (µsec)
1	1	52.6	10	-	-	51446
2	3	84.1	10	1725	1529	292696
3	3	97.7	10	1868	1805	533989
4	3	97.3	10	1446	1755	775564
5	3	98.8	10	1386	1302	21542
6	2	72.2	10	1184	-	263385
7	2	67.6	10	1027	-	505581
8	2	75.7	10	1871	-	747058
9	1	60.9	10	-	-	989976
10	1	64.2	10	-	-	234024
11	2	78.8	10	1604	-	475207
12	3	87.5	10	1712	1683	715825
13						
14						
15						
16						
17						
18						
19						
20						

DFS Radar Parameters
FCC Radar Type 5
Channel 106 Bandwidth 80MHz

Trial Number:			9			Detection (Yes/No)
Number of Bursts in Trial:			14			
Chirp Center Frequency:			5530			
Burst	Number of Pulses	Pulse Width (Microseconds)	Chirp Width (MHz)	Pulse 1-to-2 Spacing (µsec)	Pulse 2-to-3 Spacing (µsec)	Starting Location Within Interval (µsec)
1	1	54.1	13	-	-	823112
2	1	50.7	13	-	-	174965
3	1	52.3	13	-	-	382216
4	3	99.8	13	1696	1949	587395
5	2	68.4	13	1099	-	796897
6	2	80.8	13	1505	-	149042
7	1	62.5	13	-	-	356750
8	2	74.8	13	1204	-	563824
9	1	50.8	13	-	-	772314
10	1	54	13	-	-	123796
11	1	63	13	-	-	331215
12	3	91.8	13	1270	1347	537402
13	2	79.3	13	1992	-	744805
14	1	64.3	13	-	-	98172
15						
16						
17						
18						
19						
20						

Trial Number:			10			Detection (Yes/No)
Number of Bursts in Trial:			8			
Chirp Center Frequency:			5530			
Burst	Number of Pulses	Pulse Width (Microseconds)	Chirp Width (MHz)	Pulse 1-to-2 Spacing (µsec)	Pulse 2-to-3 Spacing (µsec)	Starting Location Within Interval (µsec)
1	1	63.4	6	-	-	535615
2	1	52	6	-	-	898668
3	3	97.2	6	1605	1583	1259235
4	2	78.7	6	1743	-	127106
5	2	74.2	6	1219	-	490358
6	3	88.7	6	1934	1273	852409
7	1	54.3	6	-	-	1217152
8	3	95.4	6	1555	1791	82296
9						
10						
11						
12						
13						
14						
15						
16						
17						
18						
19						
20						

DFS Radar Parameters
FCC Radar Type 5
Channel 106 Bandwidth 80MHz

Trial Number:			11			Detection (Yes/No)
Number of Bursts in Trial:			17			
Chirp Center Frequency:			5498			
Burst	Number of Pulses	Pulse Width (Microseconds)	Chirp Width (MHz)	Pulse 1-to-2 Spacing (µsec)	Pulse 2-to-3 Spacing (µsec)	Starting Location Within Interval (µsec)
1	2	73.7	16	1497	-	209249
2	3	97.4	16	1754	1613	378386
3	3	91.7	16	1702	1462	548411
4	1	66.2	16	-	-	17733
5	2	70.8	16	1821	-	187952
6	1	52.3	16	-	-	359277
7	2	78.9	16	1984	-	528886
8	2	70.9	16	1358	-	700166
9	2	75.6	16	1430	-	167197
10	1	59.1	16	-	-	338262
11	2	77	16	1304	-	508324
12	2	67.9	16	1083	-	678689
13	2	81.2	16	1932	-	146031
14	2	78.7	16	1121	-	316923
15	1	63.3	16	-	-	488056
16	2	68.9	16	1423	-	657326
17	1	59.3	16	-	-	125509
18						
19						
20						

Trial Number:			12			Detection (Yes/No)
Number of Bursts in Trial:			19			
Chirp Center Frequency:			5499			
Burst	Number of Pulses	Pulse Width (Microseconds)	Chirp Width (MHz)	Pulse 1-to-2 Spacing (µsec)	Pulse 2-to-3 Spacing (µsec)	Starting Location Within Interval (µsec)
1	3	98.9	19	1680	1488	263736
2	2	82.3	19	1855	-	416459
3	3	86.7	19	1400	1919	567902
4	3	89.7	19	1068	1282	92979
5	3	98.6	19	1194	1461	245155
6	2	71.1	19	1789	-	397609
7	1	55.9	19	-	-	551431
8	2	67.9	19	1372	-	74413
9	3	84.4	19	1107	1443	226559
10	1	58.8	19	-	-	380056
11	1	65.6	19	-	-	533408
12	2	78.5	19	1704	-	55547
13	2	82.3	19	1686	-	207876
14	3	90.1	19	1071	1266	359771
15	3	90.2	19	1089	1950	511297
16	2	83.1	19	1406	-	36803
17	1	58.8	19	-	-	189652
18	2	77	19	1657	-	341809
19	1	55	19	-	-	495737
20						

DFS Radar Parameters
FCC Radar Type 5
Channel 106 Bandwidth 80MHz

Trial Number:			13			Detection (Yes/No)
Number of Bursts in Trial:			15			
Chirp Center Frequency:			5497			
Burst	Number of Pulses	Pulse Width (Microseconds)	Chirp Width (MHz)	Pulse 1-to-2 Spacing (µsec)	Pulse 2-to-3 Spacing (µsec)	Starting Location Within Interval (µsec)
1	1	58.1	13	-	-	22911
2	1	52.1	13	-	-	216473
3	1	59.9	13	-	-	410004
4	1	60.2	13	-	-	603671
5	3	95.9	13	1906	1608	794160
6	2	79.9	13	1859	-	192251
7	2	78.5	13	1917	-	385590
8	1	53.8	13	-	-	579862
9	1	64.7	13	-	-	773423
10	1	61.4	13	-	-	168898
11	2	83.2	13	1858	-	361606
12	3	84.7	13	1677	1638	553866
13	3	88.7	13	1528	1058	747241
14	2	78.3	13	1951	-	144710
15	2	69.3	13	1717	-	337856
16						
17						
18						
19						
20						

Trial Number:			14			Detection (Yes/No)
Number of Bursts in Trial:			12			
Chirp Center Frequency:			5495			
Burst	Number of Pulses	Pulse Width (Microseconds)	Chirp Width (MHz)	Pulse 1-to-2 Spacing (µsec)	Pulse 2-to-3 Spacing (µsec)	Starting Location Within Interval (µsec)
1	2	75.3	10	1612	-	664275
2	1	56.3	10	-	-	907886
3	2	67.7	10	1185	-	151316
4	1	55.6	10	-	-	393746
5	2	75.2	10	1267	-	635093
6	2	76.3	10	1305	-	876993
7	3	85.7	10	1362	1924	121278
8	3	98.4	10	1550	1249	362696
9	3	86.4	10	1439	1046	604342
10	3	93.6	10	1031	1452	846453
11	1	63.3	10	-	-	91871
12	3	92.4	10	1673	1322	333050
13						
14						
15						
16						
17						
18						
19						
20						

DFS Radar Parameters
FCC Radar Type 5
Channel 106 Bandwidth 80MHz

Trial Number:			15			Detection (Yes/No)
Number of Bursts in Trial:			19			
Chirp Center Frequency:			5499			
Burst	Number of Pulses	Pulse Width (Microseconds)	Chirp Width (MHz)	Pulse 1-to-2 Spacing (µsec)	Pulse 2-to-3 Spacing (µsec)	Starting Location Within Interval (µsec)
1	3	93.3	18	1912	1535	361323
2	2	69.1	18	1794	-	515261
3	3	86.9	18	1152	1148	39025
4	3	84.9	18	1948	1118	190900
5	2	72.3	18	1916	-	343941
6	1	51.7	18	-	-	497624
7	1	58.3	18	-	-	20319
8	1	60.8	18	-	-	172999
9	1	57.1	18	-	-	325872
10	3	88.9	18	1964	1489	475841
11	2	72	18	1297	-	1489
12	3	90.9	18	1566	1370	153647
13	1	59.8	18	-	-	307096
14	2	70	18	1291	-	458804
15	2	67.2	18	1881	-	610798
16	3	91.2	18	1832	1661	134759
17	1	56.5	18	-	-	288306
18	1	51.2	18	-	-	441296
19	2	74.1	18	1245	-	592780
20						

Trial Number:			16			Detection (Yes/No)
Number of Bursts in Trial:			14			
Chirp Center Frequency:			5496			
Burst	Number of Pulses	Pulse Width (Microseconds)	Chirp Width (MHz)	Pulse 1-to-2 Spacing (µsec)	Pulse 2-to-3 Spacing (µsec)	Starting Location Within Interval (µsec)
1	2	76.9	12	1140	-	158286
2	1	50.2	12	-	-	366024
3	1	62.9	12	-	-	573452
4	1	64.7	12	-	-	780619
5	3	83.8	12	1097	1621	132455
6	1	65.4	12	-	-	340207
7	1	53.2	12	-	-	548208
8	1	51.7	12	-	-	755333
9	2	78.7	12	1168	-	107117
10	2	72.4	12	1343	-	314500
11	1	53.8	12	-	-	522447
12	2	73.6	12	1553	-	728517
13	2	66.7	12	1122	-	81611
14	2	82.5	12	1019	-	288948
15						
16						
17						
18						
19						
20						

DFS Radar Parameters
FCC Radar Type 5
Channel 106 Bandwidth 80MHz

Trial Number:			17			Detection (Yes/No)
Number of Bursts in Trial:			20			
Chirp Center Frequency:			5499			
Burst	Number of Pulses	Pulse Width (Microseconds)	Chirp Width (MHz)	Pulse 1-to-2 Spacing (µsec)	Pulse 2-to-3 Spacing (µsec)	Starting Location Within Interval (µsec)
1	3	87.6	20	1055	1840	345766
2	3	85.2	20	1541	1408	490019
3	3	84.8	20	1889	1463	39073
4	2	77.9	20	1460	-	183923
5	2	76.5	20	1485	-	328777
6	1	60.9	20	-	-	474728
7	2	83	20	1010	-	21394
8	2	80.4	20	1752	-	165992
9	2	67.5	20	1181	-	310973
10	1	62.1	20	-	-	456884
11	3	86.4	20	1966	1263	3515
12	3	84.3	20	1188	1788	147928
13	2	76.9	20	1537	-	293225
14	3	95.8	20	1298	1844	436922
15	1	55.2	20	-	-	584015
16	1	59	20	-	-	130832
17	3	94.5	20	1700	1283	274684
18	3	91.9	20	1978	1165	418579
19	3	85.2	20	1551	1189	563464
20	2	69.5	20	1224	-	112787

Trial Number:			18			Detection (Yes/No)
Number of Bursts in Trial:			12			
Chirp Center Frequency:			5495			
Burst	Number of Pulses	Pulse Width (Microseconds)	Chirp Width (MHz)	Pulse 1-to-2 Spacing (µsec)	Pulse 2-to-3 Spacing (µsec)	Starting Location Within Interval (µsec)
1	3	86.4	10	1918	1455	429224
2	3	92.2	10	1719	1895	670241
3	2	80.4	10	1899	-	912880
4	1	54.3	10	-	-	158603
5	1	53.1	10	-	-	400824
6	2	69.4	10	1546	-	641915
7	2	69.1	10	1639	-	883823
8	3	100	10	1438	1595	128373
9	2	79.6	10	1705	-	370379
10	3	88.4	10	1579	1623	611194
11	1	53.3	10	-	-	855665
12	1	65.3	10	-	-	98897
13						
14						
15						
16						
17						
18						
19						
20						

DFS Radar Parameters
FCC Radar Type 5
Channel 106 Bandwidth 80MHz

Trial Number:			19			Detection (Yes/No)
Number of Bursts in Trial:			14			
Chirp Center Frequency:			5496			
Burst	Number of Pulses	Pulse Width (Microseconds)	Chirp Width (MHz)	Pulse 1-to-2 Spacing (µsec)	Pulse 2-to-3 Spacing (µsec)	Starting Location Within Interval (µsec)
1	1	55.3	12	-	-	292143
2	1	58.3	12	-	-	499633
3	2	72.3	12	1039	-	706377
4	3	84.8	12	1761	1721	58989
5	2	82.5	12	1431	-	266161
6	1	63.3	12	-	-	474469
7	2	80	12	1913	-	680544
8	3	90.3	12	1853	1123	33519
9	3	91.1	12	1783	1172	240319
10	3	96.6	12	1036	1385	447400
11	2	82.7	12	1990	-	654516
12	1	50.7	12	-	-	8083
13	2	78.4	12	1109	-	215435
14	3	99.5	12	1965	1869	421325
15						
16						
17						
18						
19						
20						

Trial Number:			20			Detection (Yes/No)
Number of Bursts in Trial:			12			
Chirp Center Frequency:			5495			
Burst	Number of Pulses	Pulse Width (Microseconds)	Chirp Width (MHz)	Pulse 1-to-2 Spacing (µsec)	Pulse 2-to-3 Spacing (µsec)	Starting Location Within Interval (µsec)
1	3	88.6	10	1067	1927	733725
2	1	57.4	10	-	-	977882
3	3	96.6	10	1658	1324	221197
4	2	69.7	10	1945	-	462915
5	2	77.9	10	1317	-	705071
6	1	62	10	-	-	947923
7	3	88.4	10	1077	1366	191373
8	3	97.3	10	1896	1367	432561
9	3	96.2	10	1787	1672	674004
10	3	95.4	10	1892	1414	915842
11	1	54.8	10	-	-	162176
12	2	80.4	10	1436	-	403553
13						
14						
15						
16						
17						
18						
19						
20						

DFS Radar Parameters
FCC Radar Type 5
Channel 106 Bandwidth 80MHz

Trial Number:			21			Detection (Yes/No)
Number of Bursts in Trial:			16			
Chirp Center Frequency:			5563			
Burst	Number of Pulses	Pulse Width (Microseconds)	Chirp Width (MHz)	Pulse 1-to-2 Spacing (µsec)	Pulse 2-to-3 Spacing (µsec)	Starting Location Within Interval (µsec)
1	2	74.7	15	1611	-	483470
2	1	57.1	15	-	-	666072
3	3	91.9	15	1475	1276	98810
4	2	83.1	15	1772	-	279914
5	1	50.7	15	-	-	462536
6	2	79.2	15	1600	-	642324
7	1	58.7	15	-	-	76831
8	2	71	15	1567	-	257785
9	2	79	15	1960	-	438554
10	2	68.5	15	1428	-	620397
11	2	73.5	15	1352	-	54310
12	2	70.5	15	1115	-	235506
13	2	76.6	15	1300	-	417036
14	2	81.2	15	1675	-	597974
15	1	61.8	15	-	-	32086
16	3	94.9	15	1206	1860	212751
17						
18						
19						
20						

Trial Number:			22			Detection (Yes/No)
Number of Bursts in Trial:			12			
Chirp Center Frequency:			5565			
Burst	Number of Pulses	Pulse Width (Microseconds)	Chirp Width (MHz)	Pulse 1-to-2 Spacing (µsec)	Pulse 2-to-3 Spacing (µsec)	Starting Location Within Interval (µsec)
1	2	78.5	9	1698	-	526149
2	3	89.8	9	1962	1167	767135
3	1	59.4	9	-	-	12955
4	2	79.6	9	1890	-	254612
5	2	76	9	1811	-	496588
6	1	53.6	9	-	-	739728
7	2	80.9	9	1053	-	980872
8	1	61.6	9	-	-	225249
9	1	53.4	9	-	-	467279
10	1	59.9	9	-	-	709720
11	1	60.4	9	-	-	951847
12	3	91.4	9	1726	1227	194839
13						
14						
15						
16						
17						
18						
19						
20						

DFS Radar Parameters
FCC Radar Type 5
Channel 106 Bandwidth 80MHz

Trial Number:			23			Detection (Yes/No)
Number of Bursts in Trial:			20			
Chirp Center Frequency:			5561			
Burst	Number of Pulses	Pulse Width (Microseconds)	Chirp Width (MHz)	Pulse 1-to-2 Spacing (µsec)	Pulse 2-to-3 Spacing (µsec)	Starting Location Within Interval (µsec)
1	2	77	20	1363	-	261858
2	1	58.1	20	-	-	407646
3	1	62.1	20	-	-	552319
4	2	76.9	20	1236	-	99107
5	2	80	20	1852	-	243514
6	1	52	20	-	-	389464
7	3	88.6	20	1995	1905	531093
8	2	72.9	20	1387	-	81159
9	3	98.5	20	1746	1389	225245
10	1	57.9	20	-	-	371906
11	3	95.9	20	1870	1066	514197
12	1	53.5	20	-	-	63561
13	3	92	20	1654	1458	207510
14	1	57.3	20	-	-	353638
15	2	70.5	20	1586	-	497515
16	2	70	20	1664	-	45553
17	3	84	20	1630	1176	189821
18	2	76.1	20	1057	-	335330
19	3	93.2	20	1018	1340	478825
20	3	96.8	20	1614	1817	27594

Trial Number:			24			Detection (Yes/No)
Number of Bursts in Trial:			14			
Chirp Center Frequency:			5564			
Burst	Number of Pulses	Pulse Width (Microseconds)	Chirp Width (MHz)	Pulse 1-to-2 Spacing (µsec)	Pulse 2-to-3 Spacing (µsec)	Starting Location Within Interval (µsec)
1	1	50.1	12	-	-	247117
2	3	93.5	12	1081	1413	453362
3	2	68.8	12	1577	-	660875
4	1	56.3	12	-	-	14140
5	3	86	12	1108	1987	220734
6	2	75.2	12	1536	-	428367
7	1	54.4	12	-	-	636681
8	2	71.1	12	1243	-	843157
9	2	76.2	12	1770	-	195585
10	2	80.2	12	1209	-	403231
11	2	79.7	12	1214	-	610202
12	3	90.9	12	1862	1601	815229
13	2	68.7	12	1441	-	170267
14	2	67.4	12	1313	-	377306
15						
16						
17						
18						
19						
20						

DFS Radar Parameters
FCC Radar Type 5
Channel 106 Bandwidth 80MHz

Trial Number:			25			Detection (Yes/No)
Number of Bursts in Trial:			13			
Chirp Center Frequency:			5564			
Burst	Number of Pulses	Pulse Width (Microseconds)	Chirp Width (MHz)	Pulse 1-to-2 Spacing (µsec)	Pulse 2-to-3 Spacing (µsec)	Starting Location Within Interval (µsec)
1	3	94	11	1748	1941	628071
2	2	70.8	11	1201	-	853391
3	1	56.3	11	-	-	156223
4	3	96.7	11	1163	1332	378734
5	3	90.6	11	1582	1498	601331
6	2	74.5	11	1281	-	825462
7	3	92.6	11	1669	1222	128265
8	3	89	11	1135	1380	351161
9	3	96.5	11	1822	1602	573425
10	2	70.5	11	1178	-	798431
11	3	94	11	1629	1956	100737
12	1	55.8	11	-	-	324661
13	3	87.7	11	1963	1164	546278
14						
15						
16						
17						
18						
19						
20						

Trial Number:			26			Detection (Yes/No)
Number of Bursts in Trial:			8			
Chirp Center Frequency:			5567			
Burst	Number of Pulses	Pulse Width (Microseconds)	Chirp Width (MHz)	Pulse 1-to-2 Spacing (µsec)	Pulse 2-to-3 Spacing (µsec)	Starting Location Within Interval (µsec)
1	2	68.6	5	1161	-	1253842
2	2	83.1	5	1315	-	119486
3	1	60.9	5	-	-	482958
4	2	77.7	5	1158	-	845641
5	2	77.4	5	1510	-	1208428
6	2	66.8	5	1323	-	74748
7	1	63.7	5	-	-	438300
8	3	91.2	5	1681	1275	800152
9						
10						
11						
12						
13						
14						
15						
16						
17						
18						
19						
20						

DFS Radar Parameters
FCC Radar Type 5
Channel 106 Bandwidth 80MHz

Trial Number:		27				Detection (Yes/No)
Number of Bursts in Trial:		17				
Chirp Center Frequency:		5562				Yes
Burst	Number of Pulses	Pulse Width (Microseconds)	Chirp Width (MHz)	Pulse 1-to-2 Spacing (µsec)	Pulse 2-to-3 Spacing (µsec)	Starting Location Within Interval (µsec)
1	3	83.6	16	1195	1000	545865
2	3	89.4	16	1627	1656	14067
3	1	55.8	16	-	-	184953
4	3	90.9	16	1554	1998	353759
5	1	54.7	16	-	-	526388
6	3	97.7	16	1202	1250	694806
7	2	67.5	16	1434	-	163568
8	3	96.7	16	1469	1268	333410
9	2	68.3	16	1954	-	504006
10	2	78.3	16	1082	-	675297
11	1	55	16	-	-	142890
12	3	84.9	16	1936	1199	312479
13	2	74.6	16	1856	-	482953
14	1	63.3	16	-	-	655022
15	3	99.8	16	1515	1120	121457
16	1	63.6	16	-	-	292606
17	3	87.3	16	1051	1831	461322
18						
19						
20						

Trial Number:		28				Detection (Yes/No)
Number of Bursts in Trial:		19				
Chirp Center Frequency:		5561				Yes
Burst	Number of Pulses	Pulse Width (Microseconds)	Chirp Width (MHz)	Pulse 1-to-2 Spacing (µsec)	Pulse 2-to-3 Spacing (µsec)	Starting Location Within Interval (µsec)
1	3	85.6	19	1078	1015	565136
2	2	68.6	19	1780	-	89970
3	1	54.2	19	-	-	243121
4	1	61.2	19	-	-	396034
5	3	97.1	19	1969	1100	546225
6	3	98.3	19	1699	1622	70998
7	1	62.4	19	-	-	224093
8	2	80.2	19	1769	-	376127
9	3	87.5	19	1448	1179	527806
10	3	85.8	19	1348	1472	52247
11	3	88.1	19	1124	1631	204582
12	1	65.3	19	-	-	357941
13	1	52.5	19	-	-	510977
14	1	52.3	19	-	-	33698
15	2	74.1	19	1200	-	186023
16	1	54.9	19	-	-	339327
17	2	76.2	19	1502	-	491053
18	1	60.4	19	-	-	14858
19	2	81.5	19	1103	-	167387
20						

DFS Radar Parameters
FCC Radar Type 5
Channel 106 Bandwidth 80MHz

Trial Number:			29			Detection (Yes/No)
Number of Bursts in Trial:			12			
Chirp Center Frequency:			5565			
Burst	Number of Pulses	Pulse Width (Microseconds)	Chirp Width (MHz)	Pulse 1-to-2 Spacing (µsec)	Pulse 2-to-3 Spacing (µsec)	Starting Location Within Interval (µsec)
1	1	50.5	10	-	-	507709
2	1	55.7	10	-	-	750249
3	3	85.8	10	1002	1967	989003
4	2	76.9	10	1474	-	235634
5	2	75.1	10	1052	-	477675
6	3	92.3	10	1486	1492	718312
7	2	78.1	10	1757	-	960895
8	3	92.2	10	1252	1713	205370
9	3	89	10	1706	1411	446940
10	2	70.9	10	1620	-	689225
11	1	63.1	10	-	-	932305
12	1	55.3	10	-	-	176231
13						
14						
15						
16						
17						
18						
19						
20						

Trial Number:			30			Detection (Yes/No)
Number of Bursts in Trial:			18			
Chirp Center Frequency:			5562			
Burst	Number of Pulses	Pulse Width (Microseconds)	Chirp Width (MHz)	Pulse 1-to-2 Spacing (µsec)	Pulse 2-to-3 Spacing (µsec)	Starting Location Within Interval (µsec)
1	3	83.4	17	1205	1801	277485
2	3	97.3	17	1826	1635	437880
3	3	90.4	17	1986	1674	598445
4	3	91.8	17	1151	1802	97088
5	3	98.2	17	1977	1766	257251
6	1	59.5	17	-	-	419893
7	2	80	17	1137	-	580724
8	3	86.5	17	1128	1828	77366
9	3	91.1	17	1599	1442	238032
10	3	93.5	17	1373	1087	398605
11	1	60.7	17	-	-	562025
12	2	67.2	17	1405	-	57684
13	1	61.8	17	-	-	219083
14	2	79.4	17	1667	-	379234
15	2	81.4	17	1464	-	540896
16	1	65.7	17	-	-	37916
17	2	76	17	1255	-	198794
18	2	81	17	1668	-	359754
19						
20						

DFS Radar Parameters
FCC Radar Type 1
Channel 114 Bandwidth 160MHz

Trial #	Pulse Repetition Frequency Number (1 to 23)	Pulse Repetition Frequency (Pulses Per Second)	Pulse Repetition Interval (Microseconds)	Detection (Yes / No)
1	22	1066.10	938	Yes
2	10	1432.66	698	Yes
3	6	1618.12	618	Yes
4	2	1858.74	538	Yes
5	19	1138.95	878	Yes
6	12	326.16	3066	Yes
7	7	1567.40	638	Yes
8	21	1089.32	918	Yes
9	17	1193.32	838	Yes
10	18	1165.50	858	Yes
11	15	1253.13	798	Yes
12	11	1392.76	718	No
13	4	1730.10	578	Yes
14	5	1672.24	598	Yes
15	3	1792.11	558	Yes
16		394.32	2536	Yes
17		1035.20	966	Yes
18		1209.19	827	Yes
19		399.84	2501	Yes
20		385.36	2595	Yes
21		897.67	1114	Yes
22		768.05	1302	Yes
23		328.41	3045	Yes
24		615.76	1624	Yes
25		347.46	2878	Yes
26		973.71	1027	Yes
27		402.41	2485	Yes
28		625.00	1600	Yes
29		853.24	1172	Yes
30		849.62	1177	Yes

DFS Radar Parameters
FCC Radar Type 2
Channel 114 Bandwidth 160MHz

Trial #	Number Pulses per Burst	Pulse Width (Microseconds)	Pulse Repetition Interval (Microseconds)	Detection (Yes / No)
1	26	3.20	179	Yes
2	23	1.10	207	Yes
3	24	2.10	230	Yes
4	29	4.80	200	Yes
5	28	3.90	214	Yes
6	26	2.90	222	Yes
7	26	3.20	204	Yes
8	25	2.50	192	Yes
9	26	3.10	164	Yes
10	23	1.20	156	Yes
11	27	3.90	210	Yes
12	29	4.60	201	Yes
13	26	3.20	162	Yes
14	25	2.20	197	Yes
15	29	4.50	163	Yes
16	26	3.00	203	Yes
17	29	5.00	168	Yes
18	25	2.40	217	Yes
19	26	2.90	191	Yes
20	25	2.30	166	Yes
21	27	3.70	150	Yes
22	25	2.20	176	Yes
23	29	4.90	195	Yes
24	26	2.90	202	Yes
25	25	2.50	178	Yes
26	23	1.10	206	Yes
27	27	3.80	155	Yes
28	29	4.70	157	Yes
29	25	2.40	224	Yes
30	28	4.20	159	Yes

DFS Radar Parameters
FCC Radar Type 3
Channel 114 Bandwidth 160MHz

Trial #	Number Pulses per Burst	Pulse Width (Microseconds)	Pulse Repetition Interval (Microseconds)	Detection (Yes / No)
1	17	8.20	355	Yes
2	16	6.10	487	Yes
3	16	7.10	344	Yes
4	18	9.80	288	Yes
5	18	8.90	230	Yes
6	17	7.90	432	Yes
7	17	8.20	207	Yes
8	17	7.50	443	Yes
9	17	8.10	439	Yes
10	16	6.20	223	Yes
11	18	8.90	208	Yes
12	18	9.60	463	Yes
13	17	8.20	441	Yes
14	16	7.20	323	Yes
15	18	9.50	297	Yes
16	17	8.00	412	Yes
17	18	10.00	324	Yes
18	17	7.40	271	Yes
19	17	7.90	349	Yes
20	16	7.30	409	Yes
21	18	8.70	373	Yes
22	16	7.20	254	Yes
23	18	9.90	274	Yes
24	17	7.90	278	Yes
25	17	7.50	317	Yes
26	16	6.10	260	Yes
27	18	8.80	211	Yes
28	18	9.70	272	Yes
29	17	7.40	264	Yes
30	18	9.20	284	Yes

DFS Radar Parameters
FCC Radar Type 4
Channel 114 Bandwidth 160MHz

Trial #	Number Pulses per Burst	Pulse Width (Microseconds)	Pulse Repetition Interval (Microseconds)	Detection (Yes / No)
1	14	16.00	355	Yes
2	12	11.30	487	Yes
3	13	13.50	344	Yes
4	16	19.40	288	Yes
5	15	17.50	230	Yes
6	14	15.30	432	Yes
7	14	15.90	207	Yes
8	13	14.30	443	Yes
9	14	15.80	439	Yes
10	12	11.50	223	Yes
11	15	17.40	208	Yes
12	16	19.00	463	Yes
13	14	16.00	441	Yes
14	13	13.80	323	Yes
15	16	18.90	297	Yes
16	14	15.50	412	Yes
17	16	19.90	324	Yes
18	13	14.10	271	Yes
19	14	15.20	349	Yes
20	13	13.80	409	Yes
21	15	17.10	373	Yes
22	13	13.80	254	Yes
23	16	19.80	274	Yes
24	14	15.30	278	Yes
25	13	14.50	317	Yes
26	12	11.30	260	Yes
27	15	17.30	211	Yes
28	16	19.20	272	Yes
29	13	14.20	264	Yes
30	15	18.20	284	Yes

DFS Radar Parameters
FCC Radar Type 5
Channel 114 Bandwidth 160MHz

Trial Number:			1			Detection (Yes/No)
Number of Bursts in Trial:			15			
Chirp Center Frequency:			5570			
Burst	Number of Pulses	Pulse Width (Microseconds)	Chirp Width (MHz)	Pulse 1-to-2 Spacing (µsec)	Pulse 2-to-3 Spacing (µsec)	Starting Location Within Interval (µsec)
1	2	77.8	13	1477	-	636185
2	1	51.9	13	-	-	32674
3	1	63.8	13	-	-	226294
4	3	96.6	13	1786	1843	417976
5	3	85.9	13	1215	1729	611152
6	2	73.7	13	1549	-	8789
7	2	77.2	13	1819	-	201917
8	2	68.4	13	1114	-	395530
9	2	76.7	13	1155	-	588564
10	1	53.2	13	-	-	783794
11	3	85.7	13	1695	1394	177933
12	3	94.3	13	1426	1935	370624
13	2	77.6	13	1671	-	564893
14	1	65.7	13	-	-	759583
15	3	93.5	13	1130	1468	154262
16						
17						
18						
19						
20						

Trial Number:			2			Detection (Yes/No)
Number of Bursts in Trial:			8			
Chirp Center Frequency:			5570			
Burst	Number of Pulses	Pulse Width (Microseconds)	Chirp Width (MHz)	Pulse 1-to-2 Spacing (µsec)	Pulse 2-to-3 Spacing (µsec)	Starting Location Within Interval (µsec)
1	2	75	5	1527	-	653020
2	3	99.4	5	1262	1257	1015643
3	2	67.4	5	1403	-	1379398
4	2	73.6	5	1041	-	245489
5	1	65.9	5	-	-	609113
6	3	83.8	5	1292	1419	970852
7	1	65.5	5	-	-	1335913
8	3	98.6	5	1796	1728	200406
9						
10						
11						
12						
13						
14						
15						
16						
17						
18						
19						
20						

DFS Radar Parameters
FCC Radar Type 5
Channel 114 Bandwidth 160MHz

Trial Number:			3			Detection (Yes/No)
Number of Bursts in Trial:			11			
Chirp Center Frequency:			5570			
Burst	Number of Pulses	Pulse Width (Microseconds)	Chirp Width (MHz)	Pulse 1-to-2 Spacing (µsec)	Pulse 2-to-3 Spacing (µsec)	Starting Location Within Interval (µsec)
1	2	73.8	9	1538	-	409565
2	2	69.5	9	1649	-	673692
3	1	51.9	9	-	-	938562
4	3	84.6	9	1032	1271	113209
5	3	95.4	9	1903	1388	376726
6	2	68	9	1351	-	641212
7	3	89.6	9	1514	1573	903714
8	2	81.9	9	1689	-	80863
9	3	88.3	9	1330	1838	344067
10	1	53.7	9	-	-	609331
11	3	91.3	9	1106	1001	871542
12						
13						
14						
15						
16						
17						
18						
19						
20						

Trial Number:			4			Detection (Yes/No)
Number of Bursts in Trial:			20			
Chirp Center Frequency:			5570			
Burst	Number of Pulses	Pulse Width (Microseconds)	Chirp Width (MHz)	Pulse 1-to-2 Spacing (µsec)	Pulse 2-to-3 Spacing (µsec)	Starting Location Within Interval (µsec)
1	2	68.1	19	1355	-	26541
2	1	58.7	19	-	-	171821
3	2	75.3	19	1640	-	316229
4	1	56.4	19	-	-	461864
5	3	99.7	19	1708	1159	8677
6	1	57.7	19	-	-	153995
7	1	59.5	19	-	-	299238
8	2	80	19	1369	-	443177
9	2	82	19	1197	-	587671
10	2	82.8	19	1005	-	135674
11	3	88	19	1928	1101	279928
12	3	93.2	19	1907	1223	424279
13	2	70.4	19	1360	-	570132
14	3	95.3	19	1955	1775	117439
15	2	81.9	19	1545	-	262502
16	3	98.5	19	1169	1062	406573
17	1	65	19	-	-	553328
18	3	85.4	19	1637	1425	99799
19	3	91.6	19	1445	1325	244095
20	2	67.3	19	1218	-	390012

DFS Radar Parameters
FCC Radar Type 5
Channel 114 Bandwidth 160MHz

Trial Number:		5				Detection (Yes/No)
Number of Bursts in Trial:		17				
Chirp Center Frequency:		5570				Yes
Burst	Number of Pulses	Pulse Width (Microseconds)	Chirp Width (MHz)	Pulse 1-to-2 Spacing (μ sec)	Pulse 2-to-3 Spacing (μ sec)	Starting Location Within Interval (μ sec)
1	2	67.9	16	1133	-	629614
2	1	62.3	16	-	-	96856
3	1	53.3	16	-	-	267719
4	3	90	16	1153	1346	436784
5	2	77.1	16	1646	-	608289
6	3	83.9	16	1232	1459	75610
7	3	89.1	16	1384	1939	245638
8	2	81.8	16	1676	-	416355
9	1	50.3	16	-	-	588736
10	3	87.1	16	1996	1756	54571
11	2	71.3	16	1815	-	225175
12	3	97.5	16	1465	1132	394825
13	3	90.6	16	1040	1354	565361
14	3	86.3	16	1183	1792	33643
15	3	97.6	16	1073	1361	203957
16	3	84.7	16	1718	1854	373812
17	3	99.7	16	1244	1988	544060
18						
19						
20						

Trial Number:		6				Detection (Yes/No)
Number of Bursts in Trial:		14				
Chirp Center Frequency:		5570				Yes
Burst	Number of Pulses	Pulse Width (Microseconds)	Chirp Width (MHz)	Pulse 1-to-2 Spacing (μ sec)	Pulse 2-to-3 Spacing (μ sec)	Starting Location Within Interval (μ sec)
1	3	92.9	12	1564	1407	15438
2	2	67.7	12	1747	-	222486
3	1	65.8	12	-	-	430731
4	1	56.3	12	-	-	637784
5	1	53.7	12	-	-	845342
6	3	83.5	12	1930	1025	196720
7	1	65.8	12	-	-	404955
8	3	85.9	12	1034	1808	610711
9	2	76.3	12	1926	-	818057
10	2	81.5	12	1714	-	171459
11	3	89.4	12	1594	1827	377969
12	1	63.4	12	-	-	586875
13	2	69.6	12	1925	-	792834
14	2	74.5	12	1846	-	146044
15						
16						
17						
18						
19						
20						

DFS Radar Parameters
FCC Radar Type 5
Channel 114 Bandwidth 160MHz

Trial Number:			7			Detection (Yes/No) Yes
Number of Bursts in Trial:			15			
Chirp Center Frequency:			5570			
Burst	Number of Pulses	Pulse Width (Microseconds)	Chirp Width (MHz)	Pulse 1-to-2 Spacing (µsec)	Pulse 2-to-3 Spacing (µsec)	Starting Location Within Interval (µsec)
1	3	96.6	13	1609	1581	329022
2	3	96.7	13	1799	1154	521718
3	3	86.5	13	1396	1865	714222
4	2	73.3	13	1318	-	112450
5	1	55.8	13	-	-	306283
6	1	55.4	13	-	-	500239
7	3	85.3	13	1504	1820	690932
8	2	79.4	13	1893	-	88645
9	1	65.7	13	-	-	282508
10	2	68.6	13	1028	-	475842
11	2	77.7	13	1835	-	667887
12	2	79.6	13	1331	-	64845
13	3	94.9	13	1070	1349	257755
14	1	61.4	13	-	-	452335
15	3	90.6	13	1562	1887	643395
16						
17						
18						
19						
20						

Trial Number:			8			Detection (Yes/No) Yes
Number of Bursts in Trial:			12			
Chirp Center Frequency:			5570			
Burst	Number of Pulses	Pulse Width (Microseconds)	Chirp Width (MHz)	Pulse 1-to-2 Spacing (µsec)	Pulse 2-to-3 Spacing (µsec)	Starting Location Within Interval (µsec)
1	1	52.6	10	-	-	51446
2	3	84.1	10	1725	1529	292696
3	3	97.7	10	1868	1805	533989
4	3	97.3	10	1446	1755	775564
5	3	98.8	10	1386	1302	21542
6	2	72.2	10	1184	-	263385
7	2	67.6	10	1027	-	505581
8	2	75.7	10	1871	-	747058
9	1	60.9	10	-	-	989976
10	1	64.2	10	-	-	234024
11	2	78.8	10	1604	-	475207
12	3	87.5	10	1712	1683	715825
13						
14						
15						
16						
17						
18						
19						
20						

DFS Radar Parameters
FCC Radar Type 5
Channel 114 Bandwidth 160MHz

Trial Number:			9			Detection (Yes/No)
Number of Bursts in Trial:			14			
Chirp Center Frequency:			5570			
Burst	Number of Pulses	Pulse Width (Microseconds)	Chirp Width (MHz)	Pulse 1-to-2 Spacing (µsec)	Pulse 2-to-3 Spacing (µsec)	Starting Location Within Interval (µsec)
1	1	54.1	13	-	-	823112
2	1	50.7	13	-	-	174965
3	1	52.3	13	-	-	382216
4	3	99.8	13	1696	1949	587395
5	2	68.4	13	1099	-	796897
6	2	80.8	13	1505	-	149042
7	1	62.5	13	-	-	356750
8	2	74.8	13	1204	-	563824
9	1	50.8	13	-	-	772314
10	1	54	13	-	-	123796
11	1	63	13	-	-	331215
12	3	91.8	13	1270	1347	537402
13	2	79.3	13	1992	-	744805
14	1	64.3	13	-	-	98172
15						
16						
17						
18						
19						
20						

Trial Number:			10			Detection (Yes/No)
Number of Bursts in Trial:			8			
Chirp Center Frequency:			5570			
Burst	Number of Pulses	Pulse Width (Microseconds)	Chirp Width (MHz)	Pulse 1-to-2 Spacing (µsec)	Pulse 2-to-3 Spacing (µsec)	Starting Location Within Interval (µsec)
1	1	63.4	6	-	-	535615
2	1	52	6	-	-	898668
3	3	97.2	6	1605	1583	1259235
4	2	78.7	6	1743	-	127106
5	2	74.2	6	1219	-	490358
6	3	88.7	6	1934	1273	852409
7	1	54.3	6	-	-	1217152
8	3	95.4	6	1555	1791	82296
9						
10						
11						
12						
13						
14						
15						
16						
17						
18						
19						
20						

DFS Radar Parameters
FCC Radar Type 5
Channel 114 Bandwidth 160MHz

Trial Number:			11			Detection (Yes/No)
Number of Bursts in Trial:			17			
Chirp Center Frequency:			5498			
Burst	Number of Pulses	Pulse Width (Microseconds)	Chirp Width (MHz)	Pulse 1-to-2 Spacing (µsec)	Pulse 2-to-3 Spacing (µsec)	Starting Location Within Interval (µsec)
1	2	73.7	16	1497	-	209249
2	3	97.4	16	1754	1613	378386
3	3	91.7	16	1702	1462	548411
4	1	66.2	16	-	-	17733
5	2	70.8	16	1821	-	187952
6	1	52.3	16	-	-	359277
7	2	78.9	16	1984	-	528886
8	2	70.9	16	1358	-	700166
9	2	75.6	16	1430	-	167197
10	1	59.1	16	-	-	338262
11	2	77	16	1304	-	508324
12	2	67.9	16	1083	-	678689
13	2	81.2	16	1932	-	146031
14	2	78.7	16	1121	-	316923
15	1	63.3	16	-	-	488056
16	2	68.9	16	1423	-	657326
17	1	59.3	16	-	-	125509
18						
19						
20						

Trial Number:			12			Detection (Yes/No)
Number of Bursts in Trial:			19			
Chirp Center Frequency:			5499			
Burst	Number of Pulses	Pulse Width (Microseconds)	Chirp Width (MHz)	Pulse 1-to-2 Spacing (µsec)	Pulse 2-to-3 Spacing (µsec)	Starting Location Within Interval (µsec)
1	3	98.9	19	1680	1488	263736
2	2	82.3	19	1855	-	416459
3	3	86.7	19	1400	1919	567902
4	3	89.7	19	1068	1282	92979
5	3	98.6	19	1194	1461	245155
6	2	71.1	19	1789	-	397609
7	1	55.9	19	-	-	551431
8	2	67.9	19	1372	-	74413
9	3	84.4	19	1107	1443	226559
10	1	58.8	19	-	-	380056
11	1	65.6	19	-	-	533408
12	2	78.5	19	1704	-	55547
13	2	82.3	19	1686	-	207876
14	3	90.1	19	1071	1266	359771
15	3	90.2	19	1089	1950	511297
16	2	83.1	19	1406	-	36803
17	1	58.8	19	-	-	189652
18	2	77	19	1657	-	341809
19	1	55	19	-	-	495737
20						

DFS Radar Parameters
FCC Radar Type 5
Channel 114 Bandwidth 160MHz

Trial Number:			13			Detection (Yes/No)
Number of Bursts in Trial:			15			
Chirp Center Frequency:			5497			
Burst	Number of Pulses	Pulse Width (Microseconds)	Chirp Width (MHz)	Pulse 1-to-2 Spacing (µsec)	Pulse 2-to-3 Spacing (µsec)	Starting Location Within Interval (µsec)
1	1	58.1	13	-	-	22911
2	1	52.1	13	-	-	216473
3	1	59.9	13	-	-	410004
4	1	60.2	13	-	-	603671
5	3	95.9	13	1906	1608	794160
6	2	79.9	13	1859	-	192251
7	2	78.5	13	1917	-	385590
8	1	53.8	13	-	-	579862
9	1	64.7	13	-	-	773423
10	1	61.4	13	-	-	168898
11	2	83.2	13	1858	-	361606
12	3	84.7	13	1677	1638	553866
13	3	88.7	13	1528	1058	747241
14	2	78.3	13	1951	-	144710
15	2	69.3	13	1717	-	337856
16						
17						
18						
19						
20						

Trial Number:			14			Detection (Yes/No)
Number of Bursts in Trial:			12			
Chirp Center Frequency:			5496			
Burst	Number of Pulses	Pulse Width (Microseconds)	Chirp Width (MHz)	Pulse 1-to-2 Spacing (µsec)	Pulse 2-to-3 Spacing (µsec)	Starting Location Within Interval (µsec)
1	2	75.3	10	1612	-	664275
2	1	56.3	10	-	-	907886
3	2	67.7	10	1185	-	151316
4	1	55.6	10	-	-	393746
5	2	75.2	10	1267	-	635093
6	2	76.3	10	1305	-	876993
7	3	85.7	10	1362	1924	121278
8	3	98.4	10	1550	1249	362696
9	3	86.4	10	1439	1046	604342
10	3	93.6	10	1031	1452	846453
11	1	63.3	10	-	-	91871
12	3	92.4	10	1673	1322	333050
13						
14						
15						
16						
17						
18						
19						
20						

DFS Radar Parameters
FCC Radar Type 5
Channel 114 Bandwidth 160MHz

Trial Number:			15			Detection (Yes/No)
Number of Bursts in Trial:			19			
Chirp Center Frequency:			5499			
Burst	Number of Pulses	Pulse Width (Microseconds)	Chirp Width (MHz)	Pulse 1-to-2 Spacing (µsec)	Pulse 2-to-3 Spacing (µsec)	Starting Location Within Interval (µsec)
1	3	93.3	18	1912	1535	361323
2	2	69.1	18	1794	-	515261
3	3	86.9	18	1152	1148	39025
4	3	84.9	18	1948	1118	190900
5	2	72.3	18	1916	-	343941
6	1	51.7	18	-	-	497624
7	1	58.3	18	-	-	20319
8	1	60.8	18	-	-	172999
9	1	57.1	18	-	-	325872
10	3	88.9	18	1964	1489	475841
11	2	72	18	1297	-	1489
12	3	90.9	18	1566	1370	153647
13	1	59.8	18	-	-	307096
14	2	70	18	1291	-	458804
15	2	67.2	18	1881	-	610798
16	3	91.2	18	1832	1661	134759
17	1	56.5	18	-	-	288306
18	1	51.2	18	-	-	441296
19	2	74.1	18	1245	-	592780
20						

Trial Number:			16			Detection (Yes/No)
Number of Bursts in Trial:			14			
Chirp Center Frequency:			5496			
Burst	Number of Pulses	Pulse Width (Microseconds)	Chirp Width (MHz)	Pulse 1-to-2 Spacing (µsec)	Pulse 2-to-3 Spacing (µsec)	Starting Location Within Interval (µsec)
1	2	76.9	12	1140	-	158286
2	1	50.2	12	-	-	366024
3	1	62.9	12	-	-	573452
4	1	64.7	12	-	-	780619
5	3	83.8	12	1097	1621	132455
6	1	65.4	12	-	-	340207
7	1	53.2	12	-	-	548208
8	1	51.7	12	-	-	755333
9	2	78.7	12	1168	-	107117
10	2	72.4	12	1343	-	314500
11	1	53.8	12	-	-	522447
12	2	73.6	12	1553	-	728517
13	2	66.7	12	1122	-	81611
14	2	82.5	12	1019	-	288948
15						
16						
17						
18						
19						
20						

DFS Radar Parameters
FCC Radar Type 5
Channel 114 Bandwidth 160MHz

Trial Number:			17			Detection (Yes/No)
Number of Bursts in Trial:			20			
Chirp Center Frequency:			5500			
Burst	Number of Pulses	Pulse Width (Microseconds)	Chirp Width (MHz)	Pulse 1-to-2 Spacing (µsec)	Pulse 2-to-3 Spacing (µsec)	Starting Location Within Interval (µsec)
1	3	87.6	20	1055	1840	345766
2	3	85.2	20	1541	1408	490019
3	3	84.8	20	1889	1463	39073
4	2	77.9	20	1460	-	183923
5	2	76.5	20	1485	-	328777
6	1	60.9	20	-	-	474728
7	2	83	20	1010	-	21394
8	2	80.4	20	1752	-	165992
9	2	67.5	20	1181	-	310973
10	1	62.1	20	-	-	456884
11	3	86.4	20	1966	1263	3515
12	3	84.3	20	1188	1788	147928
13	2	76.9	20	1537	-	293225
14	3	95.8	20	1298	1844	436922
15	1	55.2	20	-	-	584015
16	1	59	20	-	-	130832
17	3	94.5	20	1700	1283	274684
18	3	91.9	20	1978	1165	418579
19	3	85.2	20	1551	1189	563464
20	2	69.5	20	1224	-	112787

Trial Number:			18			Detection (Yes/No)
Number of Bursts in Trial:			12			
Chirp Center Frequency:			5496			
Burst	Number of Pulses	Pulse Width (Microseconds)	Chirp Width (MHz)	Pulse 1-to-2 Spacing (µsec)	Pulse 2-to-3 Spacing (µsec)	Starting Location Within Interval (µsec)
1	3	86.4	10	1918	1455	429224
2	3	92.2	10	1719	1895	670241
3	2	80.4	10	1899	-	912880
4	1	54.3	10	-	-	158603
5	1	53.1	10	-	-	400824
6	2	69.4	10	1546	-	641915
7	2	69.1	10	1639	-	883823
8	3	100	10	1438	1595	128373
9	2	79.6	10	1705	-	370379
10	3	88.4	10	1579	1623	611194
11	1	53.3	10	-	-	855665
12	1	65.3	10	-	-	98897
13						
14						
15						
16						
17						
18						
19						
20						

DFS Radar Parameters
FCC Radar Type 5
Channel 114 Bandwidth 160MHz

Trial Number:			19			Detection (Yes/No)
Number of Bursts in Trial:			14			
Chirp Center Frequency:			5496			
Burst	Number of Pulses	Pulse Width (Microseconds)	Chirp Width (MHz)	Pulse 1-to-2 Spacing (µsec)	Pulse 2-to-3 Spacing (µsec)	Starting Location Within Interval (µsec)
1	1	55.3	12	-	-	292143
2	1	58.3	12	-	-	499633
3	2	72.3	12	1039	-	706377
4	3	84.8	12	1761	1721	58989
5	2	82.5	12	1431	-	266161
6	1	63.3	12	-	-	474469
7	2	80	12	1913	-	680544
8	3	90.3	12	1853	1123	33519
9	3	91.1	12	1783	1172	240319
10	3	96.6	12	1036	1385	447400
11	2	82.7	12	1990	-	654516
12	1	50.7	12	-	-	8083
13	2	78.4	12	1109	-	215435
14	3	99.5	12	1965	1869	421325
15						
16						
17						
18						
19						
20						

Trial Number:			20			Detection (Yes/No)
Number of Bursts in Trial:			12			
Chirp Center Frequency:			5496			
Burst	Number of Pulses	Pulse Width (Microseconds)	Chirp Width (MHz)	Pulse 1-to-2 Spacing (µsec)	Pulse 2-to-3 Spacing (µsec)	Starting Location Within Interval (µsec)
1	3	88.6	10	1067	1927	733725
2	1	57.4	10	-	-	977882
3	3	96.6	10	1658	1324	221197
4	2	69.7	10	1945	-	462915
5	2	77.9	10	1317	-	705071
6	1	62	10	-	-	947923
7	3	88.4	10	1077	1366	191373
8	3	97.3	10	1896	1367	432561
9	3	96.2	10	1787	1672	674004
10	3	95.4	10	1892	1414	915842
11	1	54.8	10	-	-	162176
12	2	80.4	10	1436	-	403553
13						
14						
15						
16						
17						
18						
19						
20						

DFS Radar Parameters
FCC Radar Type 5
Channel 114 Bandwidth 160MHz

Trial Number:			21			Detection (Yes/No)
Number of Bursts in Trial:			16			
Chirp Center Frequency:			5642			
Burst	Number of Pulses	Pulse Width (Microseconds)	Chirp Width (MHz)	Pulse 1-to-2 Spacing (µsec)	Pulse 2-to-3 Spacing (µsec)	Starting Location Within Interval (µsec)
1	2	74.7	15	1611	-	483470
2	1	57.1	15	-	-	666072
3	3	91.9	15	1475	1276	98810
4	2	83.1	15	1772	-	279914
5	1	50.7	15	-	-	462536
6	2	79.2	15	1600	-	642324
7	1	58.7	15	-	-	76831
8	2	71	15	1567	-	257785
9	2	79	15	1960	-	438554
10	2	68.5	15	1428	-	620397
11	2	73.5	15	1352	-	54310
12	2	70.5	15	1115	-	235506
13	2	76.6	15	1300	-	417036
14	2	81.2	15	1675	-	597974
15	1	61.8	15	-	-	32086
16	3	94.9	15	1206	1860	212751
17						
18						
19						
20						

Trial Number:			22			Detection (Yes/No)
Number of Bursts in Trial:			12			
Chirp Center Frequency:			5645			
Burst	Number of Pulses	Pulse Width (Microseconds)	Chirp Width (MHz)	Pulse 1-to-2 Spacing (µsec)	Pulse 2-to-3 Spacing (µsec)	Starting Location Within Interval (µsec)
1	2	78.5	9	1698	-	526149
2	3	89.8	9	1962	1167	767135
3	1	59.4	9	-	-	12955
4	2	79.6	9	1890	-	254612
5	2	76	9	1811	-	496588
6	1	53.6	9	-	-	739728
7	2	80.9	9	1053	-	980872
8	1	61.6	9	-	-	225249
9	1	53.4	9	-	-	467279
10	1	59.9	9	-	-	709720
11	1	60.4	9	-	-	951847
12	3	91.4	9	1726	1227	194839
13						
14						
15						
16						
17						
18						
19						
20						

DFS Radar Parameters
FCC Radar Type 5
Channel 114 Bandwidth 160MHz

Trial Number:			23			Detection (Yes/No)
Number of Bursts in Trial:			20			
Chirp Center Frequency:			5640			
Burst	Number of Pulses	Pulse Width (Microseconds)	Chirp Width (MHz)	Pulse 1-to-2 Spacing (µsec)	Pulse 2-to-3 Spacing (µsec)	Starting Location Within Interval (µsec)
1	2	77	20	1363	-	261858
2	1	58.1	20	-	-	407646
3	1	62.1	20	-	-	552319
4	2	76.9	20	1236	-	99107
5	2	80	20	1852	-	243514
6	1	52	20	-	-	389464
7	3	88.6	20	1995	1905	531093
8	2	72.9	20	1387	-	81159
9	3	98.5	20	1746	1389	225245
10	1	57.9	20	-	-	371906
11	3	95.9	20	1870	1066	514197
12	1	53.5	20	-	-	63561
13	3	92	20	1654	1458	207510
14	1	57.3	20	-	-	353638
15	2	70.5	20	1586	-	497515
16	2	70	20	1664	-	45553
17	3	84	20	1630	1176	189821
18	2	76.1	20	1057	-	335330
19	3	93.2	20	1018	1340	478825
20	3	96.8	20	1614	1817	27594

Trial Number:			24			Detection (Yes/No)
Number of Bursts in Trial:			14			
Chirp Center Frequency:			5644			
Burst	Number of Pulses	Pulse Width (Microseconds)	Chirp Width (MHz)	Pulse 1-to-2 Spacing (µsec)	Pulse 2-to-3 Spacing (µsec)	Starting Location Within Interval (µsec)
1	1	50.1	12	-	-	247117
2	3	93.5	12	1081	1413	453362
3	2	68.8	12	1577	-	660875
4	1	56.3	12	-	-	14140
5	3	86	12	1108	1987	220734
6	2	75.2	12	1536	-	428367
7	1	54.4	12	-	-	636681
8	2	71.1	12	1243	-	843157
9	2	76.2	12	1770	-	195585
10	2	80.2	12	1209	-	403231
11	2	79.7	12	1214	-	610202
12	3	90.9	12	1862	1601	815229
13	2	68.7	12	1441	-	170267
14	2	67.4	12	1313	-	377306
15						
16						
17						
18						
19						
20						

DFS Radar Parameters
FCC Radar Type 5
Channel 114 Bandwidth 160MHz

Trial Number:			25			Detection (Yes/No)
Number of Bursts in Trial:			13			
Chirp Center Frequency:			5644			
Burst	Number of Pulses	Pulse Width (Microseconds)	Chirp Width (MHz)	Pulse 1-to-2 Spacing (µsec)	Pulse 2-to-3 Spacing (µsec)	Starting Location Within Interval (µsec)
1	3	94	11	1748	1941	628071
2	2	70.8	11	1201	-	853391
3	1	56.3	11	-	-	156223
4	3	96.7	11	1163	1332	378734
5	3	90.6	11	1582	1498	601331
6	2	74.5	11	1281	-	825462
7	3	92.6	11	1669	1222	128265
8	3	89	11	1135	1380	351161
9	3	96.5	11	1822	1602	573425
10	2	70.5	11	1178	-	798431
11	3	94	11	1629	1956	100737
12	1	55.8	11	-	-	324661
13	3	87.7	11	1963	1164	546278
14						
15						
16						
17						
18						
19						
20						

Trial Number:			26			Detection (Yes/No)
Number of Bursts in Trial:			8			
Chirp Center Frequency:			5646			
Burst	Number of Pulses	Pulse Width (Microseconds)	Chirp Width (MHz)	Pulse 1-to-2 Spacing (µsec)	Pulse 2-to-3 Spacing (µsec)	Starting Location Within Interval (µsec)
1	2	68.6	5	1161	-	1253842
2	2	83.1	5	1315	-	119486
3	1	60.9	5	-	-	482958
4	2	77.7	5	1158	-	845641
5	2	77.4	5	1510	-	1208428
6	2	66.8	5	1323	-	74748
7	1	63.7	5	-	-	438300
8	3	91.2	5	1681	1275	800152
9						
10						
11						
12						
13						
14						
15						
16						
17						
18						
19						
20						

DFS Radar Parameters
FCC Radar Type 5
Channel 114 Bandwidth 160MHz

Trial Number:		27				Detection (Yes/No)
Number of Bursts in Trial:		17				
Chirp Center Frequency:		5642				
Burst	Number of Pulses	Pulse Width (Microseconds)	Chirp Width (MHz)	Pulse 1-to-2 Spacing (µsec)	Pulse 2-to-3 Spacing (µsec)	Starting Location Within Interval (µsec)
1	3	83.6	16	1195	1000	545865
2	3	89.4	16	1627	1656	14067
3	1	55.8	16	-	-	184953
4	3	90.9	16	1554	1998	353759
5	1	54.7	16	-	-	526388
6	3	97.7	16	1202	1250	694806
7	2	67.5	16	1434	-	163568
8	3	96.7	16	1469	1268	333410
9	2	68.3	16	1954	-	504006
10	2	78.3	16	1082	-	675297
11	1	55	16	-	-	142890
12	3	84.9	16	1936	1199	312479
13	2	74.6	16	1856	-	482953
14	1	63.3	16	-	-	655022
15	3	99.8	16	1515	1120	121457
16	1	63.6	16	-	-	292606
17	3	87.3	16	1051	1831	461322
18						
19						
20						

Trial Number:		28				Detection (Yes/No)
Number of Bursts in Trial:		19				
Chirp Center Frequency:		5641				
Burst	Number of Pulses	Pulse Width (Microseconds)	Chirp Width (MHz)	Pulse 1-to-2 Spacing (µsec)	Pulse 2-to-3 Spacing (µsec)	Starting Location Within Interval (µsec)
1	3	85.6	19	1078	1015	565136
2	2	68.6	19	1780	-	89970
3	1	54.2	19	-	-	243121
4	1	61.2	19	-	-	396034
5	3	97.1	19	1969	1100	546225
6	3	98.3	19	1699	1622	70998
7	1	62.4	19	-	-	224093
8	2	80.2	19	1769	-	376127
9	3	87.5	19	1448	1179	527806
10	3	85.8	19	1348	1472	52247
11	3	88.1	19	1124	1631	204582
12	1	65.3	19	-	-	357941
13	1	52.5	19	-	-	510977
14	1	52.3	19	-	-	33698
15	2	74.1	19	1200	-	186023
16	1	54.9	19	-	-	339327
17	2	76.2	19	1502	-	491053
18	1	60.4	19	-	-	14858
19	2	81.5	19	1103	-	167387
20						

DFS Radar Parameters
FCC Radar Type 5
Channel 114 Bandwidth 160MHz

Trial Number:			29			Detection (Yes/No)
Number of Bursts in Trial:			12			
Chirp Center Frequency:			5644			
Burst	Number of Pulses	Pulse Width (Microseconds)	Chirp Width (MHz)	Pulse 1-to-2 Spacing (µsec)	Pulse 2-to-3 Spacing (µsec)	Starting Location Within Interval (µsec)
1	1	50.5	10	-	-	507709
2	1	55.7	10	-	-	750249
3	3	85.8	10	1002	1967	989003
4	2	76.9	10	1474	-	235634
5	2	75.1	10	1052	-	477675
6	3	92.3	10	1486	1492	718312
7	2	78.1	10	1757	-	960895
8	3	92.2	10	1252	1713	205370
9	3	89	10	1706	1411	446940
10	2	70.9	10	1620	-	689225
11	1	63.1	10	-	-	932305
12	1	55.3	10	-	-	176231
13						
14						
15						
16						
17						
18						
19						
20						

Trial Number:			30			Detection (Yes/No)
Number of Bursts in Trial:			18			
Chirp Center Frequency:			5642			
Burst	Number of Pulses	Pulse Width (Microseconds)	Chirp Width (MHz)	Pulse 1-to-2 Spacing (µsec)	Pulse 2-to-3 Spacing (µsec)	Starting Location Within Interval (µsec)
1	3	83.4	17	1205	1801	277485
2	3	97.3	17	1826	1635	437880
3	3	90.4	17	1986	1674	598445
4	3	91.8	17	1151	1802	97088
5	3	98.2	17	1977	1766	257251
6	1	59.5	17	-	-	419893
7	2	80	17	1137	-	580724
8	3	86.5	17	1128	1828	77366
9	3	91.1	17	1599	1442	238032
10	3	93.5	17	1373	1087	398605
11	1	60.7	17	-	-	562025
12	2	67.2	17	1405	-	57684
13	1	61.8	17	-	-	219083
14	2	79.4	17	1667	-	379234
15	2	81.4	17	1464	-	540896
16	1	65.7	17	-	-	37916
17	2	76	17	1255	-	198794
18	2	81	17	1668	-	359754
19						
20						