

TEST REPORT

Report Number: 14749497-E4V3

Applicant : eero LLC
660 3rd Street 4th Floor
San Francisco, CA 94107, U.S.A.

Model : V010001

Brand : eero

FCC ID : 2AEM4-711917312

IC : 20631-711917312

EUT Description : Wireless Access Point

Test Standard(s) : FCC 47 CFR PART 15 SUBPART C
ISED RSS-247 ISSUE 3
ISED RSS-GEN ISSUE 5 + A1 + A2

Date Of Issue:
2023-09-19

Prepared by:
UL VERIFICATION SERVICES INC.
47173 Benicia Street
Fremont, CA 94538 U.S.A.
TEL: (510) 319-4000
FAX: (510) 661-0888



REPORT REVISION HISTORY

Rev.	Issue Date	Revisions	Revised By
V1	2023-08-16	Initial Issue	---
V2	2023-09-06	Updated Section 6.6 info, updated RSS 247 to issue 3.	Tina Chu
V3	2023-09-19	Added directional antenna gain formula on Section 9.4. Updated section 9.5 to address TCB's questions	Tina Chu

TABLE OF CONTENTS

REPORT REVISION HISTORY	2
TABLE OF CONTENTS	3
1. ATTESTATION OF TEST RESULTS.....	5
2. TEST RESULTS SUMMARY	7
3. TEST METHODOLOGY	8
4. FACILITIES AND ACCREDITATION.....	8
5. DECISION RULES AND MEASUREMENT UNCERTAINTY.....	9
5.1. METROLOGICAL TRACEABILITY	9
5.2. DECISION RULES	9
5.3. MEASUREMENT UNCERTAINTY	9
5.4. SAMPLE CALCULATION.....	10
6. EQUIPMENT UNDER TEST	11
6.1. EUT DESCRIPTION.....	11
6.2. MAXIMUM OUTPUT POWER.....	11
6.3. DESCRIPTION OF AVAILABLE ANTENNAS AND CABLE LOSS	12
6.4. SOFTWARE AND FIRMWARE.....	12
6.5. WORST-CASE CONFIGURATION AND MODE.....	12
6.6. DESCRIPTION OF TEST SETUP.....	13
7. MEASUREMENT METHOD	16
8. TEST AND MEASUREMENT EQUIPMENT	17
9. ANTENNA PORT TEST RESULTS	18
9.1. ON TIME AND DUTY CYCLE	18
9.2. 99% BANDWIDTH.....	19
9.2.1. 802.11ax HE20 MODE 1TX	19
9.2.2. 802.11ax HE20 MODE 2TX	20
9.2.3. 802.11ax HE40 MODE 1TX	22
9.2.4. 802.11ax HE40 MODE 2TX	24
9.3. 6 dB BANDWIDTH	26
9.3.1. 802.11ax HE20 MODE 1TX	27
9.3.2. 802.11ax HE20 MODE 2TX	28
9.3.3. 802.11ax HE40 MODE 1TX	30
9.3.4. 802.11ax HE40 MODE 2TX	32
9.4. OUTPUT POWER.....	35

9.4.1.	802.11ax HE20 MODE 1TX	37
9.4.2.	802.11ax HE20 MODE 2TX	38
9.4.3.	802.11ax HE40 MODE 1TX	39
9.4.4.	802.11ax HE40 MODE 2TX	40
9.5.	<i>POWER SPECTRAL DENSITY</i>	41
9.5.1.	802.11ax HE20 MODE 1TX	42
9.5.2.	802.11ax HE20 MODE 2TX	43
9.5.3.	802.11ax HE40 MODE 1TX	45
9.5.4.	802.11ax HE40 MODE 2TX	47
9.6.	<i>CONDUCTED SPURIOUS EMISSIONS</i>	50
9.6.1.	802.11ax HE20 MODE 1TX	51
9.6.2.	802.11ax HE20 MODE 2TX	53
9.6.3.	802.11ax HE40 MODE 1TX	57
9.6.4.	802.11ax HE40 MODE 2TX	59
10.	RADIATED TEST RESULTS	63
10.1.	<i>TRANSMITTER ABOVE 1 GHz</i>	65
10.1.1.	TX ABOVE 1 GHz 802.11ax HE20 MODE IN THE 2.4GHz BAND	65
10.1.2.	TX ABOVE 1 GHz 802.11ax HE40 MODE IN THE 2.4GHz BAND	85
10.2.	<i>WORST CASE BELOW 30MHz</i>	111
10.3.	<i>WORST CASE BELOW 1 GHz (Foxlink PSU)</i>	112
10.4.	<i>WORST CASE BELOW 1 GHz (Luxshare PSU)</i>	114
10.5.	<i>WORST CASE 18-26 GHz</i>	116
10.6.	<i>WORST CASE 26 TO 40 GHz</i>	118
11.	AC POWER LINE CONDUCTED EMISSIONS	120
11.1.	<i>AC Power Line (Foxlink PSU)</i>	121
11.2.	<i>AC Power Line (Luxshare PSU)</i>	123
12.	SETUP PHOTOS	125

1. ATTESTATION OF TEST RESULTS

COMPANY NAME: eero LLC
660 3rd Street 4th Floor
San Francisco, CA 94107, U.S.A.

EUT DESCRIPTION: Wireless Access Point

MODEL: V010001

BRAND: eero

SERIAL NUMBER: Radiated: GGB2-1E06-3237-0089, GGB2-1E04-3062-004P,
GGB2-1E08-3287-0037
Conducted: GGB2-1E04-3057-00DA, GGB2-1E06-3237-OOBQ

SAMPLE RECEIPT DATE: 2023-04-05

DATE TESTED: 2023-04-28 TO 2023-08-08

APPLICABLE STANDARDS	
STANDARD	TEST RESULTS
FCC 47 CRF Part 15 Subpart C	Complies
ISED RSS-247 Issue 3	Complies
ISED RSS-GEN Issue 5 + A1 + A2	Complies

UL Verification Services Inc. tested the above equipment in accordance with the requirements set forth in the above standards. The test results show that the equipment tested is capable of demonstrating compliance with the requirements as documented in this report.

The results documented in this report apply only to the tested sample, under the conditions and modes of operation as described herein. It is the manufacturer's responsibility to assure that additional production units of this model are manufactured with identical electrical and mechanical components. All samples tested were in good operating condition throughout the entire test program. Measurement Uncertainties are published for informational purposes only and were not taken into account unless noted otherwise.

This document may not be altered or revised in any way unless done so by UL Verification Services Inc. and all revisions are duly noted in the revisions section. Any alteration of this document not carried out by UL Verification Services Inc. will constitute fraud and shall nullify the document.

Approved & Released For
UL Verification Services Inc. By:



Francisco de Anda
Staff Engineer
Consumer Technology Division
UL Verification Services Inc.

Prepared By:



Gerardo Abrego
Test Engineer
Consumer Technology Division
UL Verification Services Inc.

Reviewed By:



Vien Tran
Senior Laboratory Engineer
Consumer Technology Division
UL Verification Services Inc.

2. TEST RESULTS SUMMARY

This report contains data provided by the customer which can impact the validity of results. UL Verification Services Inc. is only responsible for the validity of results after the integration of the data provided by the customer.

Below is a list of the data provided by the customer:

- 1) Antenna gain and type (see section 6.3)
- 2) Cable Loss (see section 6.3)

FCC Clause	ISED Clause	Requirement	Result	Comment
See Comment		Duty Cycle	Reporting purposes only	ANSI C63.10 Section 11.6.
-	RSS-GEN 6.7	99% OBW	Reporting purposes only	ANSI C63.10 Section 6.9.3.
15.247 (a) (2)	RSS-247 5.2 (a)	6dB BW	Complies	None.
15.247 (b) (3)	RSS-247 5.4 (d)	Output Power	Complies	None.
See Comment		Average power	Reporting purposes only	Per ANSI C63.10, Section 11.9.2.3.2.
15.247 (e)	RSS-247 5.2 (b)	PSD	Complies	None.
15.247 (d)	RSS-247 5.5	Conducted Spurious Emissions	Complies	None.
15.209, 15.205	RSS-GEN 8.9, 8.10	Radiated Emissions	Complies	None.
15.207	RSS-Gen 8.8	AC Mains Conducted Emissions	Complies	None.

3. TEST METHODOLOGY

The tests documented in this report were performed in accordance with FCC 47 CFR Part 2, FCC 47 CFR Part 15, ANSI C63.10-2013, and KDB 558074 D01 15.247 Meas Guidance v05r02, KDB 414788 D01 Radiated Test Site v01r01, RSS-GEN Issue 5 + A1 + A2, and RSS-247 Issue 3

4. FACILITIES AND ACCREDITATION

UL Verification Services Inc. is accredited by A2LA, Certificate Number 0751.05, for all testing performed within the scope of this report. Testing was performed at the locations noted below.

	Address	ISED CABID	ISED Company Number	FCC Registration
<input checked="" type="checkbox"/>	Building 1: 47173 Benicia Street Fremont, CA 94538, U.S.A	US0104	2324A	550739
<input type="checkbox"/>	Building 2: 47266 Benicia Street Fremont, CA 94538, U.S.A			
<input checked="" type="checkbox"/>	Building 4: 47658 Kato Rd Fremont, CA 94538, U.S.A			

5. DECISION RULES AND MEASUREMENT UNCERTAINTY

5.1. METROLOGICAL TRACEABILITY

All test and measuring equipment utilized to perform the tests documented in this report are calibrated on a regular basis, with a maximum time between calibrations of one year or the manufacturers' recommendation, whichever is less, and where applicable is traceable to recognized national standards.

5.2. DECISION RULES

The Decision Rule is based on Simple Acceptance in accordance with ISO Guide 98-4:2012 Clause 8.2. (Measurement uncertainty is not taken into account when stating conformity with a specified requirement.)

5.3. MEASUREMENT UNCERTAINTY

Where relevant, the following measurement uncertainty levels have been estimated for tests performed on the apparatus:

PARAMETER	U _{Lab}
Radio Frequency (Spectrum Analyzer)	141.16 Hz
Occupied Bandwidth	1.22%
Power Spectral Density	2.47 dB
RF Power Measurement Direct Method Using Power Meter	1.3 dB (PK) / 0.45 dB (AV)
Unwanted Emissions, Conducted	1.94 dB
Worst Case Conducted Disturbance, 9kHz to 0.15 MHz	3.78 dB
Worst Case Conducted Disturbance, 0.15 to 30 MHz	3.40 dB
Worst Case Radiated Disturbance, 9kHz to 30 MHz	2.87 dB
Worst Case Radiated Disturbance, 30 to 1000 MHz	6.01 dB
Worst Case Radiated Disturbance, 1000 to 18000 MHz	4.73 dB
Worst Case Radiated Disturbance, 18000 to 26000 MHz	4.51 dB
Worst Case Radiated Disturbance, 26000 to 40000 MHz	5.29 dB
Time Domain Measurements	3.39%
Temperature	0.57°C
Humidity	3.39%
DC Supply Voltages	0.57%

Uncertainty figures are valid to a confidence level of 95%.

5.4. SAMPLE CALCULATION

RADIATED EMISSIONS

Where relevant, the following sample calculation is provided:

$$\text{Field Strength (dBuV/m)} = \text{Measured Voltage (dBuV)} + \text{Antenna Factor (dB/m)} + \text{Cable Loss (dB)} - \text{Preamp Gain (dB)}$$
$$36.5 \text{ dBuV} + 18.7 \text{ dB/m} + 0.6 \text{ dB} - 26.9 \text{ dB} = 28.9 \text{ dBuV/m}$$

MAINS CONDUCTED EMISSIONS

Where relevant, the following sample calculation is provided:

$$\text{Final Voltage (dBuV)} = \text{Measured Voltage (dBuV)} + \text{Cable Loss (dB)} + \text{Limiter Factor (dB)} + \text{LISN Insertion Loss.}$$
$$36.5 \text{ dBuV} + 0 \text{ dB} + 10.1 \text{ dB} + 0 \text{ dB} = 46.6 \text{ dBuV}$$

6. EQUIPMENT UNDER TEST

6.1. EUT DESCRIPTION

The EUT is a low power indoor Access Point that supports 802.11 a/b/g/n/ac/ax/be 2.4G DTS/ 5G UNII band 1 and band 3 Wifi, BLE 1Mbps/2Mbps and 802.15.4 technologies.

This report covers ax 2.4GHz Wifi radio.

6.2. MAXIMUM OUTPUT POWER

The transmitter has a maximum conducted output power as follows:

2.4GHz BAND 802.11 ax MODE 1TX

Frequency Range (MHz)	Mode	Output Power (dBm)	Output Power (mW)
1TX			
2412 - 2462	802.11ax HE20 RU size 242T	24.58	287.08
2422 - 2452	802.11ax HE40 RU size 484T	25.80	380.19

2.4GHz BAND 802.11 ax MODE 2TX

Frequency Range (MHz)	Mode	Output Power (dBm)	Output Power (mW)
2TX CDD			
2412 - 2462	802.11ax HE20 RU size 242T	27.52	564.94
2422 - 2452	802.11ax HE40 RU size 484T	28.75	749.89

6.3. DESCRIPTION OF AVAILABLE ANTENNAS AND CABLE LOSS

The antenna(s) gain and type, cable loss as provided by the manufacturer' are as follows:

The radio utilizes Flex PCB antennas, with a maximum gain as below table. EUT only supportsTx/Rx SISO (1x1) WLAN 2.4GHz on Chain 0 and MIMO (2x2) WLAN 2.4GHz on both Chain 0 and Chain 1.

Frequency Band (GHz)	Chain 0	Chain 1
	Antenna Gain (dBi)	Antenna Gain (dBi)
2412-2462	3.8	3.8

Cable loss: 1dB

6.4. SOFTWARE AND FIRMWARE

The EUT firmware installed during testing was 2023-03-30T01.

The test utility software used during testing was QRCT4 version 4.0.81.1.

6.5. WORST-CASE CONFIGURATION AND MODE

Radiated emissions below 1GHz, 1GHz and 18GHz, above 18GHz, and power line conducted emission were performed with the EUT set to transmit at the channel with highest output power as worst-case scenario.

Investigation was performed on 1TX, 2TX and determined that 2Tx mode covers 1TX, 2TX for radiated spurious emissions.

Band edge was performed with the EUT set to transmit at the highest power on low, middle, and high channels.

The EUT can only be setup in desktop orientation; therefore, all radiated testing was performed with the EUT in desktop orientation.

EUT only supports full tones, all testing was performed on the full tones only.

Worst-case data rates as provided by the client were:

802.11ax HE20 mode: MCS0
802.11ax HE40 mode: MCS0

6.6. DESCRIPTION OF TEST SETUP

SUPPORT TEST EQUIPMENT						
Description	Manufacturer	Model	Serial Number	FCC ID/ DoC		
EUT AC/DC Adapter (Luxshare)	eero	C310011	NA	DoC		
EUT AC/DC Adapter (Foxlink)	eero	C310011	NA	DoC		
Laptop	Lenovo	ThinkPad P15s Gen 2	PF-2YV2K6	DoC		
Laptop AC/DC Adapter	Lenovo	ADLX65Y	8SSA10R16875C1SG09PRSHT	DoC		
Laptop	Lenovo	ThinkPadT460	PC0JLLUT	DoC		
Laptop AC/DC Adapter	Lenovo	A-17-065N2A	8SSA10J20161C1SG8720X55 Rev:000	DoC		
Switch	Netgear	XS505M	6H11197M00054	DoC		
I/O CABLES (CONDUCTED TEST)						
Cable No.	Port	# of Identical Ports	Connector Type	Cable Type	Cable Length (m)	Remarks
1	AC	1	2-Prong	Un-shielded	1	AC Mains to LT AC/DC Adapter
2	DC	1	Barrel	Un-shielded	1.5	AC/DC Adapter to Laptop
3	Ethernet	1	RJ45	Un-shielded	1	Laptop to EUT
4	DC	1	Barrel	Un-shielded	1.5	AC/DC Adapter to EUT
5	SMA	1	SMA	Un-shielded	0.1	EUT to Spectrum Analyzer
6	AC	1	3-Prong	Un-shielded	1.5	AC Mains to Spectrum Analyzer
I/O CABLES (RADIATED TEST EMISSIONS)						
Cable No.	Port	# of Identical Ports	Connector Type	Cable Type	Cable Length (m)	Remarks
3	AC	1	2-Prong	Un-shielded	2	AC Mains to Switch
4	DC	1	Barrel	Un-shielded	1.5	AC/DC Adapter to EUT
5	I/O	4	RJ45	Un-shielded	>3 meter	EUT to Switch /Laptop. One cable connected to switch is <3 meter for 30MHz to 1GHz test.
6	AC	1	3-Prong	Un-shielded	1.5	AC Mains to Spectrum Analyzer
I/O CABLES (AC POWER LINE EMISSIONS)						
Cable No.	Port	# of Identical Ports	Connector Type	Cable Type	Cable Length (m)	Remarks
3	AC	1	2-Prong	Un-shielded	2	AC Mains to Switch
4	DC	1	Barrel	Un-shielded	1.5	AC/DC Adapter to EUT
5	I/O	5	RJ45	Un-shielded	>3 meter	EUT to Switch, Laptop to Switch

TEST SETUP

The EUT is powered by AC/DC adapter and connected to support equipment, and the radio is exercised remotely by command prompt GUI test utility software via ethernet.

SETUP DIAGRAM

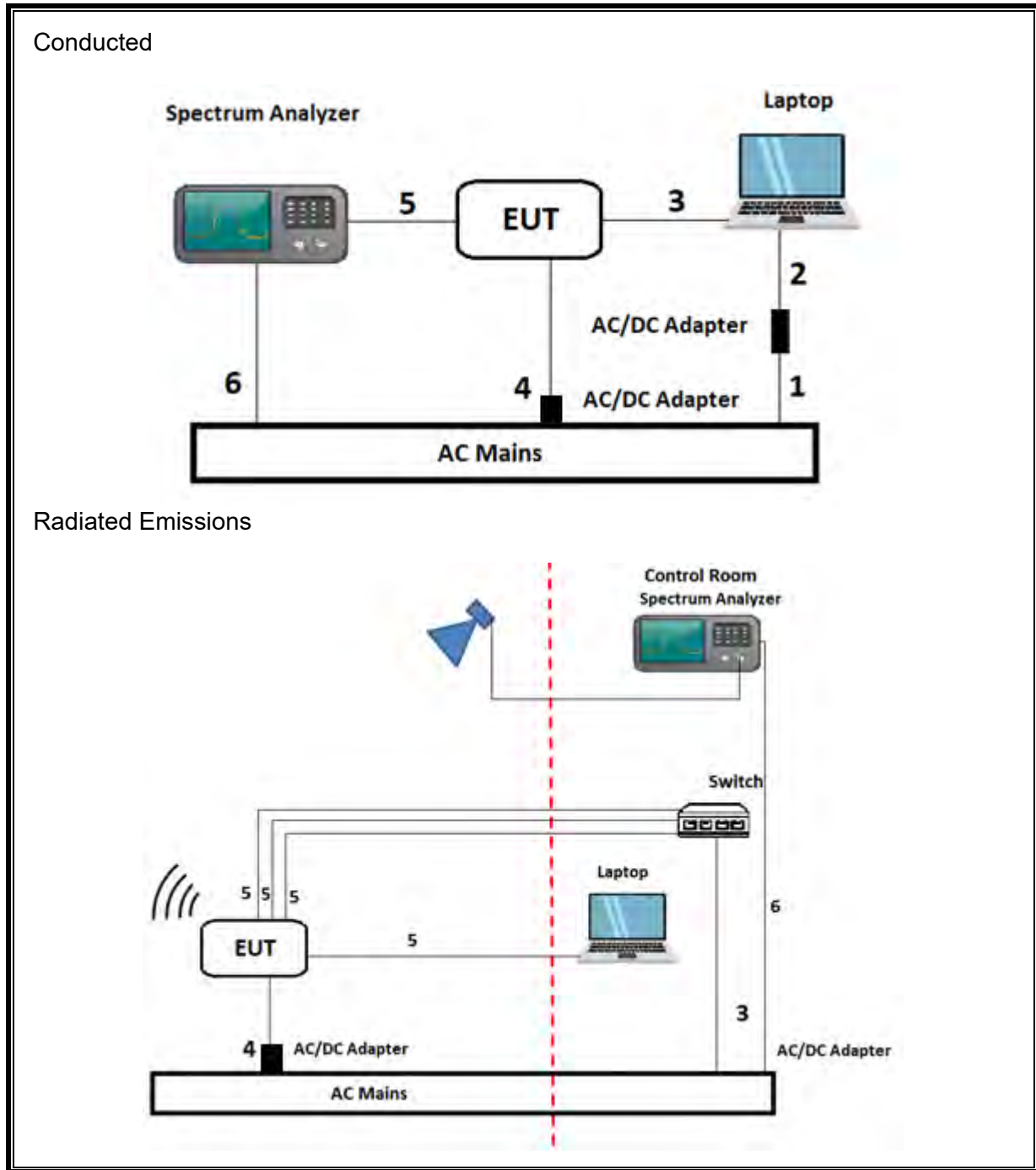

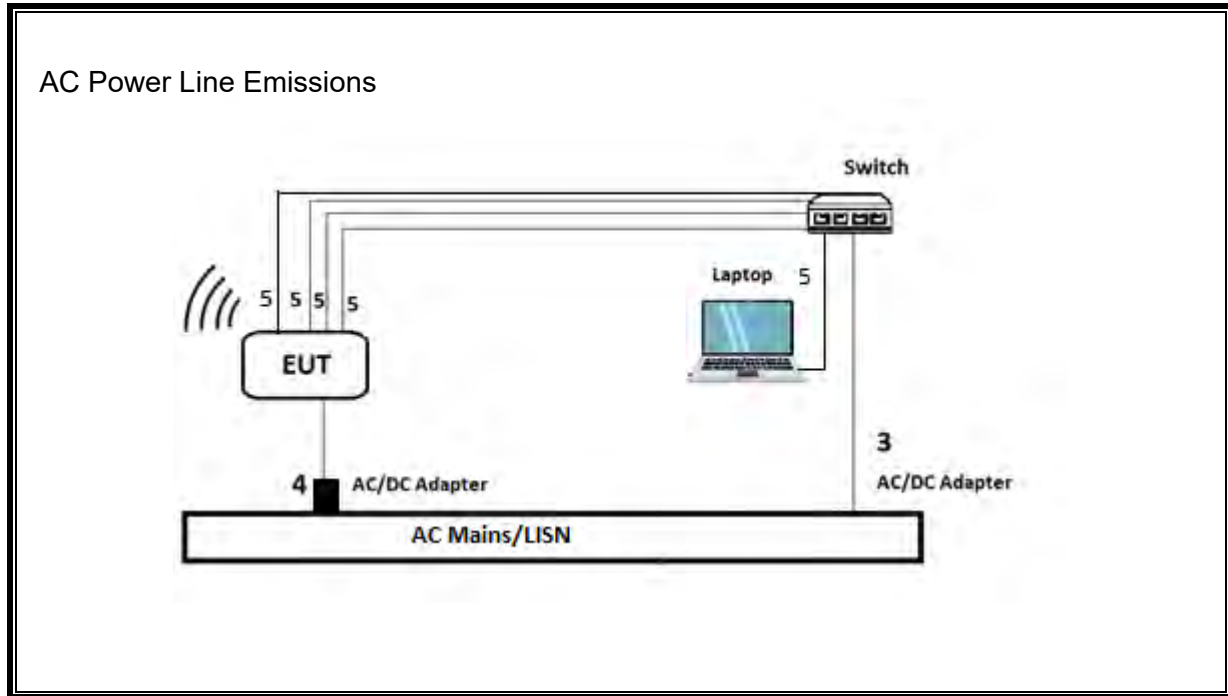

7. MEASUREMENT METHOD

On Time and Duty Cycle: ANSI C63.10 Section 11.6.

6 dB BW: ANSI C63.10 Subclause -11.8.1 RBW \geq DTS BW

Occupied BW (99%): ANSI C63.10-2013 Section 6.9.3

Output Power: ANSI C63.10 Subclause -11.9.2.3.2 Method AVGPM-G (Measurement using a gated RF average-reading power meter)

PSD: ANSI C63.10 Subclause -11.10.3 Method AVGPSD-1

Radiated emissions non-restricted frequency bands: ANSI C63.10 Subclause -11.11

Radiated emissions restricted frequency bands: ANSI C63.10 Subclause -11.12.1

Conducted emissions in restricted frequency bands: ANSI C63.10 Subclause -11.12.2

Band-edge: ANSI C63.10 Subclause -11.13.3.2 Integration method -Peak detection

Band-edge: ANSI C63.10 Subclause -11.13.3.4 Integration method -Trace averaging across ON and OFF times DC correction

AC Power Line Conducted Emissions: ANSI C63.10-2013, Section 6.2.

Radiated Spurious Emissions Below 30MHz: ANSI C63.10-2013 Section 6.4

8. TEST AND MEASUREMENT EQUIPMENT

The following test and measurement equipment was utilized for the tests documented in this report:

TEST EQUIPMENT LIST					
Description	Manufacturer	Model	ID Num	Cal Due	Last Cal
Antenna, Passive Loop 30Hz - 1MHz	ELECTRO METRICS	EM-6871	219908	2024-05-31	2023-05-31
Antenna, Passive Loop 100KHz - 30MHz	ELECTRO METRICS	EM-6872	219910	2024-05-31	2023-05-31
Antenna, Broadband Hybrid, 30MHz to 2000MHz	Sunol Sciences Corp.	JB1	80293	2024-04-30	2023-04-11
Amplifier, 9KHz to 1GHz, 32dB	SONOMA INSTRUMENT	310	170647	2023-11-11	2022-11-11
Antenna, Horn 1-18GHz	ETS-Lindgren	3117	222741	2023-08-31	2022-08-31
RF Filter Box, 1-18GHz	UL-FR1	n/a	171875	2023-11-10	2022-11-10
EMI TEST RECEIVER	Rohde & Schwarz	ESW44	230547	2024-02-29	2023-02-15
Antenna, Horn 18 to 26.5GHz	A.R.A.	MWH-1826/B	199659	2023-12-06	2022-12-06
Amplifier 18-26.5GHz, +5Vdc, -54dBm P1dB	AMPLICAL	AMP18G26.5-60	234683	2024-03-29	2023-03-18
Antenna, Horn 26.5 to 40GHz	ARA	MWH-2640/B	199661	2023-12-06	2022-12-06
Amplifier 26-40GHz +5Vdc, -62dBm P1dB	AMPLICAL	AMP26G40-60	234684	2024-03-29	2023-03-18
EMI TEST RECEIVER	Rohde & Schwarz	ESW44	225688 (chamber k)	2024-02-29	2023-02-14
Spectrum Analyzer, PXA, 3Hz to 44GHz	Keysight Technologies Inc	N9030A	125178	2024-02-29	2023-02-06
10dB Fixed Attenuator, up to 26GHz	Pasternack Enterprises	PE7087-10	236189	Verified/characterized before use	
Power Meter, P-series single channel	Keysight Technologies Inc	N1921A	81319	2024-01-25	2023-01-25
Power Sensor, P-series, 50MHz to 18GHz, Wideband	Keysight Technologies Inc	N1911A	90718	2024-01-31	2023-01-31
AC Line Conducted					
LISN	Fischer Custom Communications, Inc	FCC-LISN-50/250-25-2-01-480V	175765	2024-01-31	2023-01-27
EMI TEST RECEIVER	Rohde & Schwarz	ESR	93091	2024-02-29	2023-02-20
Transient Limiter	TE	TBFL1	207996	2023-07-31	2022-07-15
UL TEST SOFTWARE LIST					
Radiated Software	UL	UL EMC	Ver 2023-01-18, 2023-03-03, 2023-05-01		
Antenna Port Software	UL	UL RF	Ver 2022-08-16		
AC Line Conducted Software	UL	UL EMC	Rev 9.5, 2022-02-17		

9. ANTENNA PORT TEST RESULTS

9.1. ON TIME AND DUTY CYCLE

LIMITS

None; for reporting purposes only.

PROCEDURE

KDB 558074 D01 Zero-Span Spectrum Analyzer Method.

ON TIME AND DUTY CYCLE RESULTS

Mode	ON Time B (msec)	Period (msec)	Duty Cycle x (linear)	Duty Cycle (%)	DCCF (dB)	1/B Minimum VBW (kHz)
802.11ax HE20 OFDMA, RU 242T 1x1	3.747	3.907	0.96	95.90	0.18	0.267
802.11ax HE20 OFDMA, RU 242T 2x2	3.753	3.869	0.97	97.00	0.13	0.266
802.11ax HE40 OFDMA, RU 484T 1x1	3.747	3.862	0.97	97.02	0.13	0.267
802.11ax HE40 OFDMA, RU 484T 2x2	3.753	3.895	0.96	96.35	0.16	0.266



802.11ax HE20 OFDMA, RU index 242T 1TX MODE



802.11ax HE20 OFDMA, RU index 242T 2x2 MODE



802.11ax HE40 OFDMA, RU index 484T 1TX MODE



802.11ax HE40 OFDMA, RU index 484T 2x2 MODE

9.2. 99% BANDWIDTH

LIMITS

None; for reporting purposes only.

RESULTS

9.2.1. 802.11ax HE20 MODE 1TX

1TX Chain 0 OFDMA MODE: 242-Tones, RU Index 61

Channel	Frequency (MHz)	99% Bandwidth (MHz)
Low 1	2412	18.935
Low 2	2417	18.972
Mid 6	2437	18.959
High 11	2462	19.077

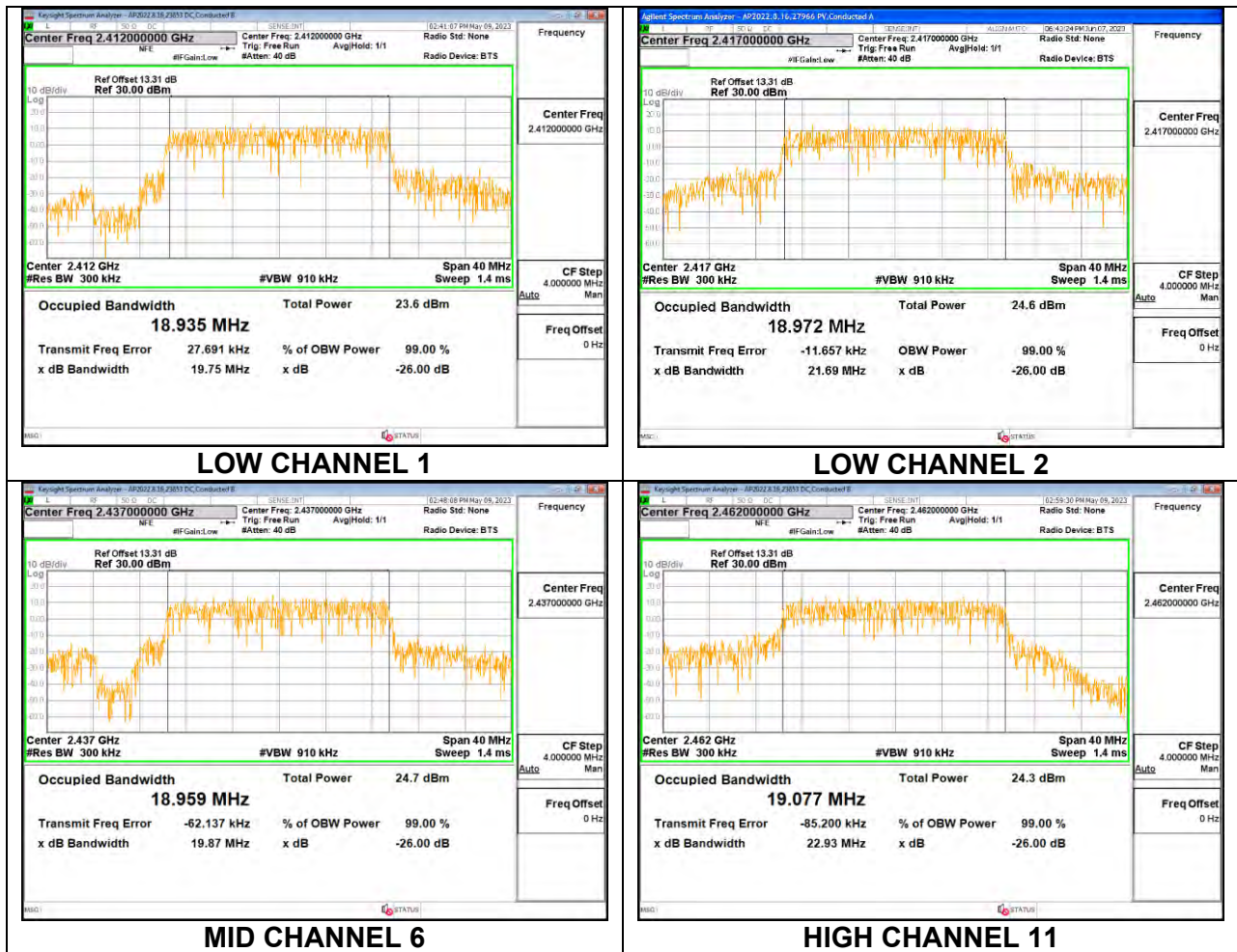

9.2.2. 802.11ax HE20 MODE 2TX

2TX Chain 0 + Chain 1 CDD OFDMA MODE: 242-Tones, RU Index 61

Channel	Frequency (MHz)	99% Bandwidth Chain 0 (MHz)	99% Bandwidth Chain 1 (MHz)
Low 1	2412	18.983	18.962
Low 2	2417	18.905	18.963
Mid 6	2437	19.036	19.181
High 11	2462	18.999	19.000

LOW CHANNEL 1

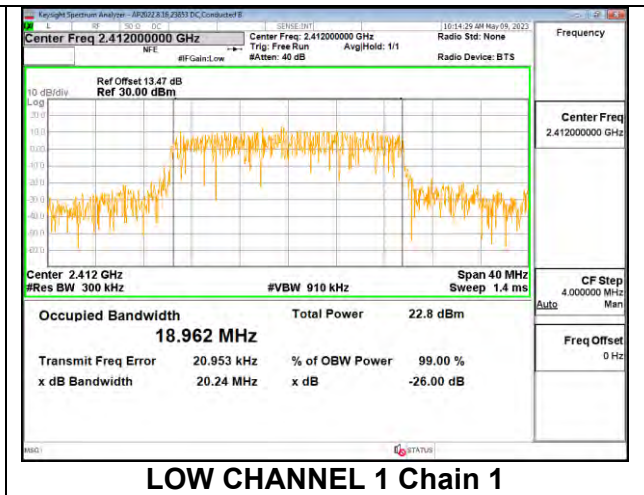
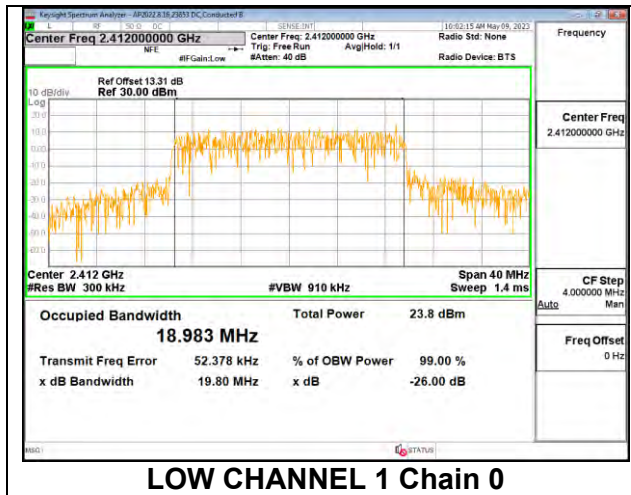

LOW CHANNEL 2

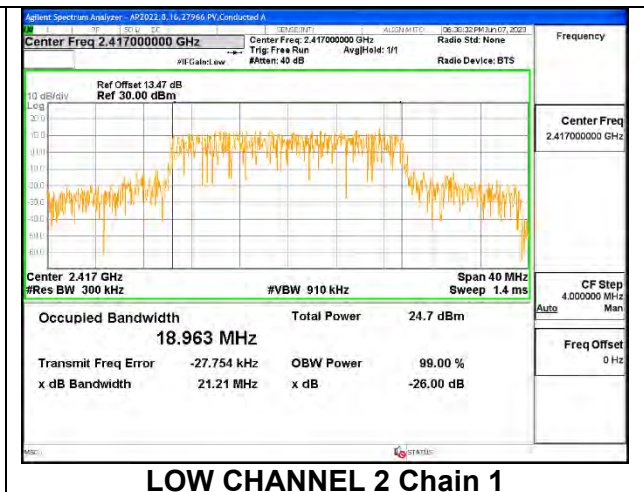
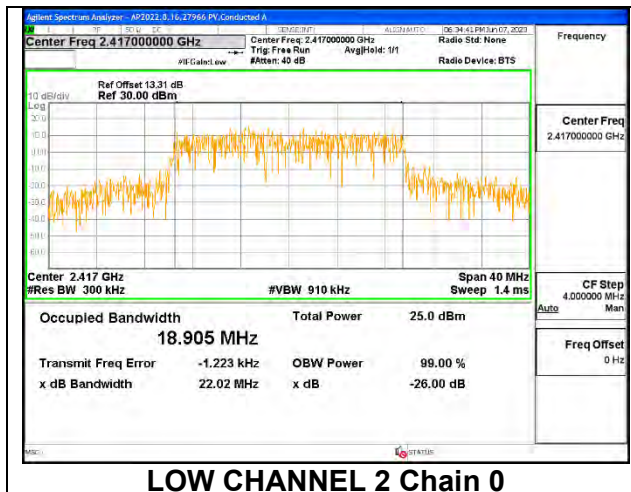

MID CHANNEL 6

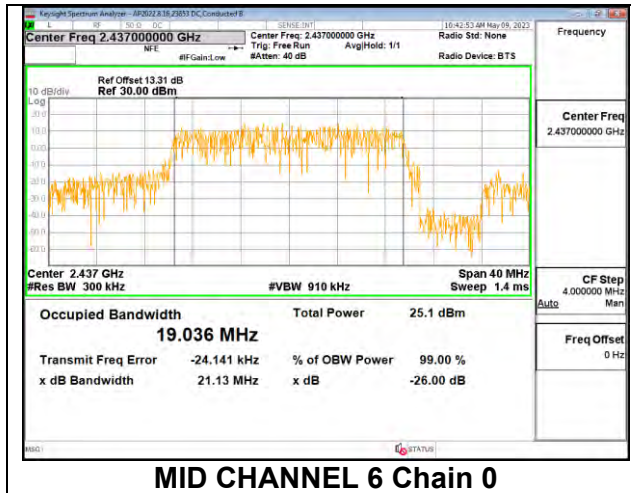

MID CHANNEL 6 Chain 0

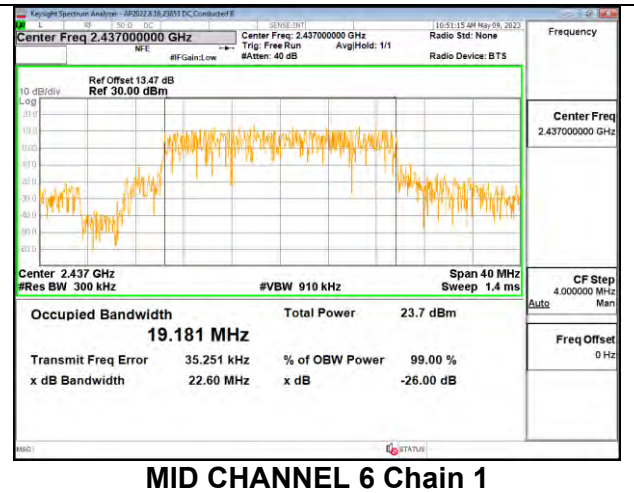

MID CHANNEL 6 Chain 1

HIGH CHANNEL 11

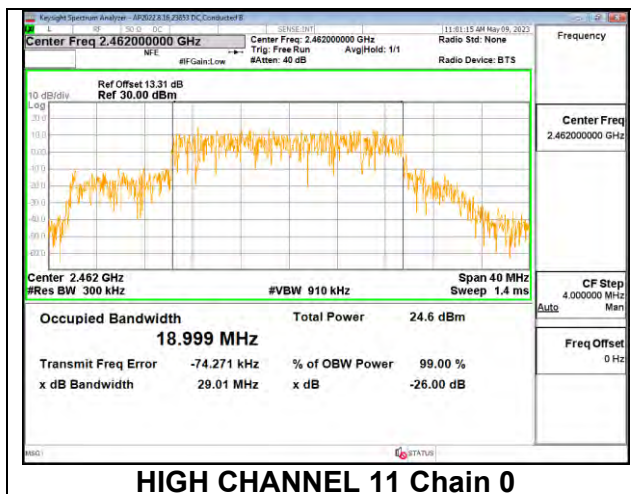

HIGH CHANNEL 11 Chain 0

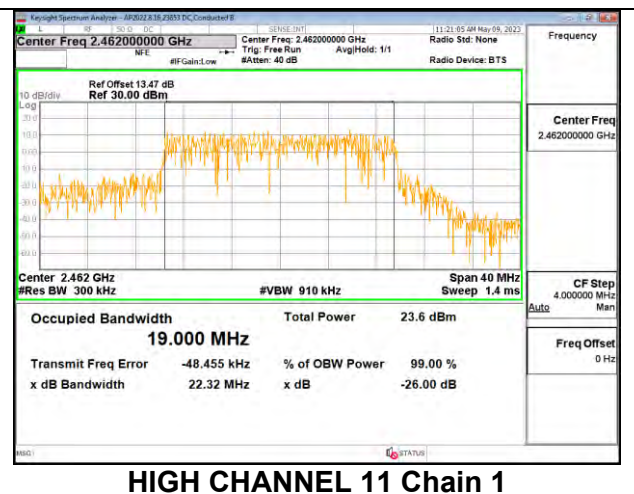

HIGH CHANNEL 11 Chain 1

9.2.3. 802.11ax HE40 MODE 1TX

1TX Chain 0 OFDMA MODE: 484-Tones, RU Index 65

Channel	Frequency (MHz)	99% Bandwidth (MHz)
Low 3	2422	37.489
Low 4	2427	37.771
Mid 6	2437	38.102
High 8	2447	37.896
High 9	2452	37.840

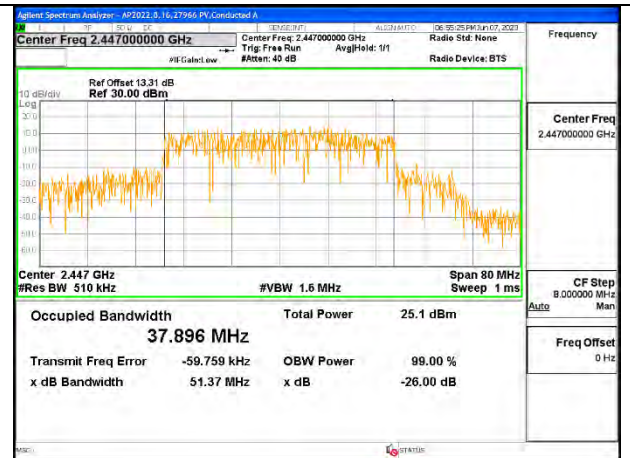
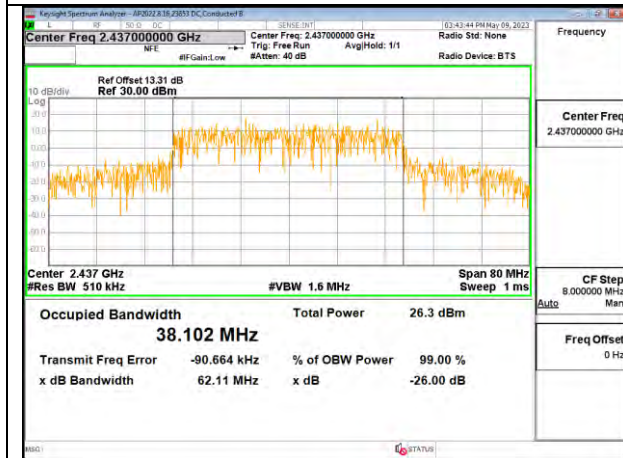
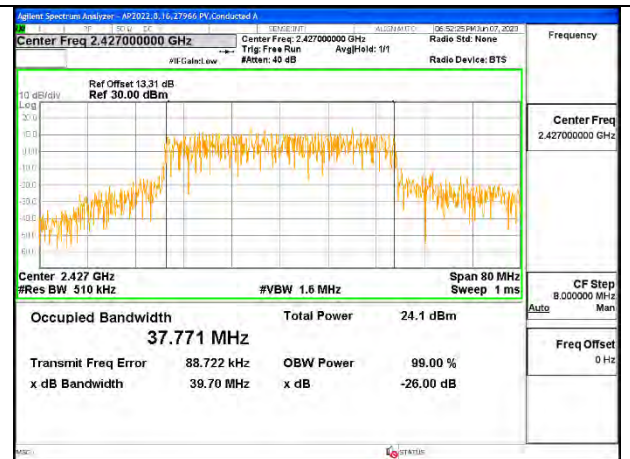
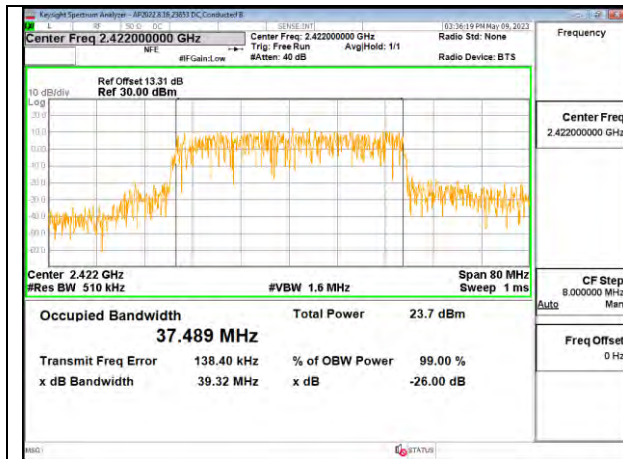

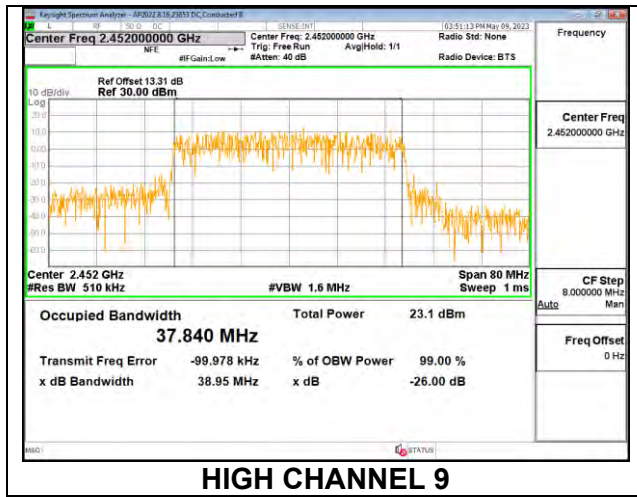

9.2.4. 802.11ax HE40 MODE 2TX

2TX Chain 0 + Chain 1 CDD OFDMA MODE: 484-Tones, RU Index 65

Channel	Frequency (MHz)	99% Bandwidth Chain 0 (MHz)	99% Bandwidth Chain 1 (MHz)
Low 3	2422	37.848	37.784
Low 4	2427	37.570	37.394
Mid 6	2437	38.375	38.109
High 8	2447	37.942	37.794
High 9	2452	37.730	37.751

LOW CHANNEL 3

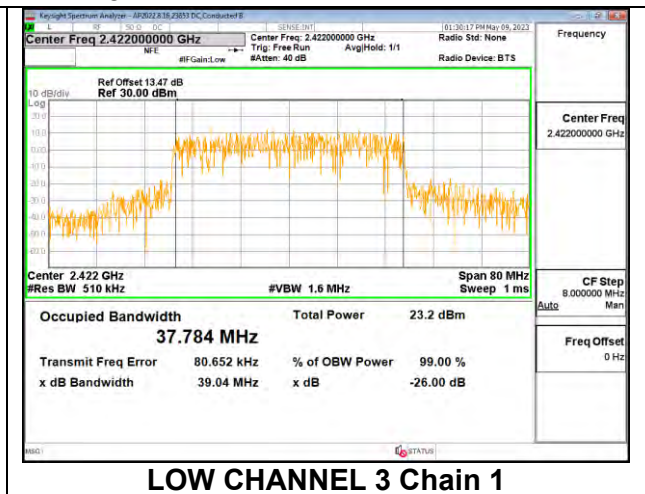
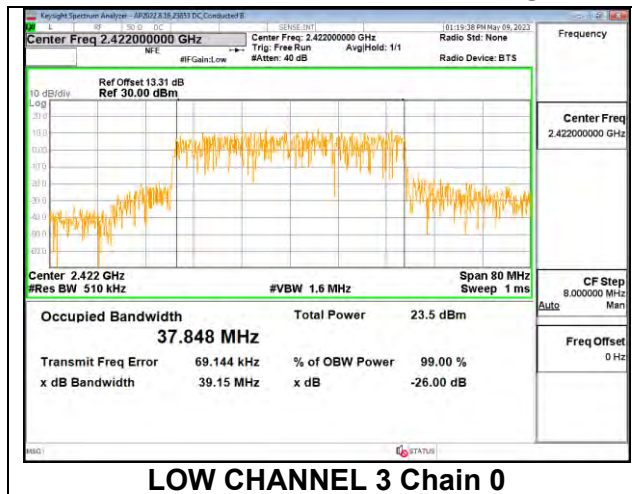

LOW CHANNEL 4

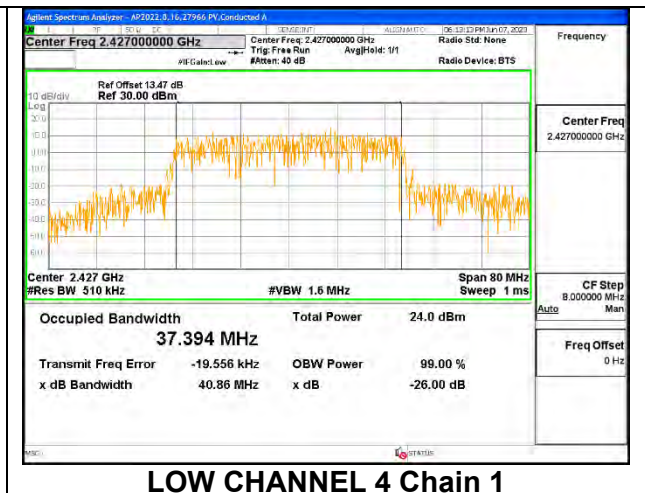
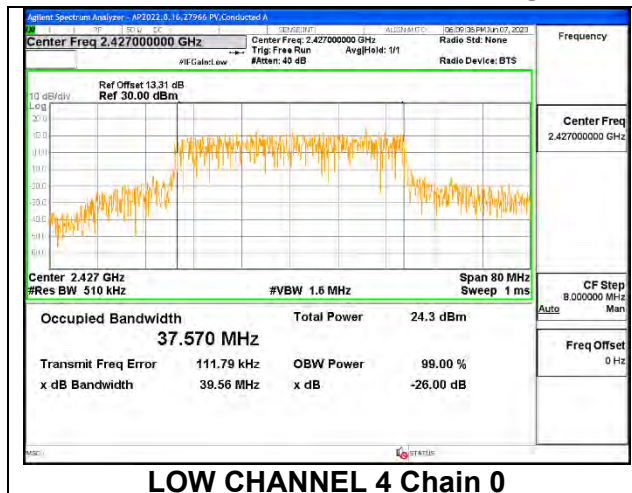

MID CHANNEL 6

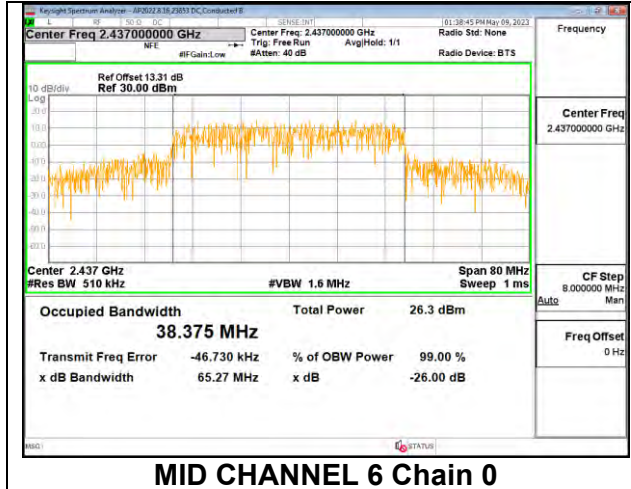

MID CHANNEL 6 Chain 0

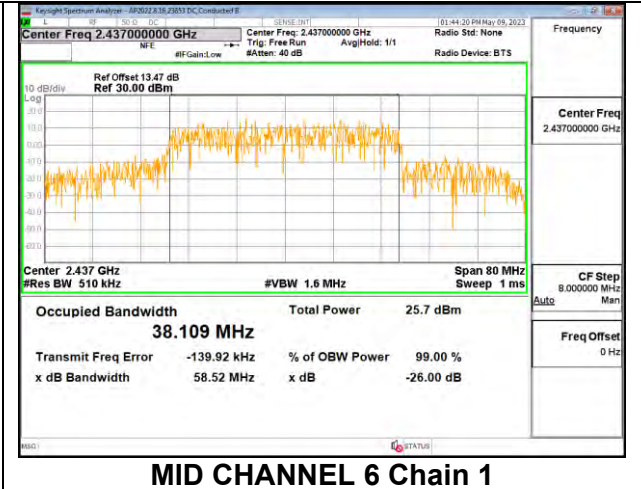

MID CHANNEL 6 Chain 1

HIGH CHANNEL 8

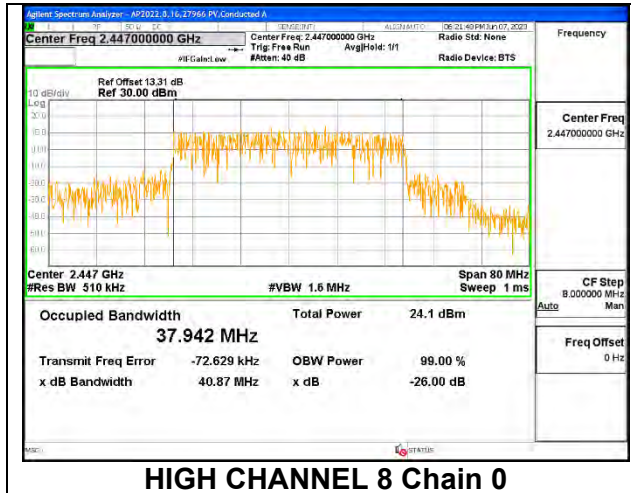

HIGH CHANNEL 8 Chain 0

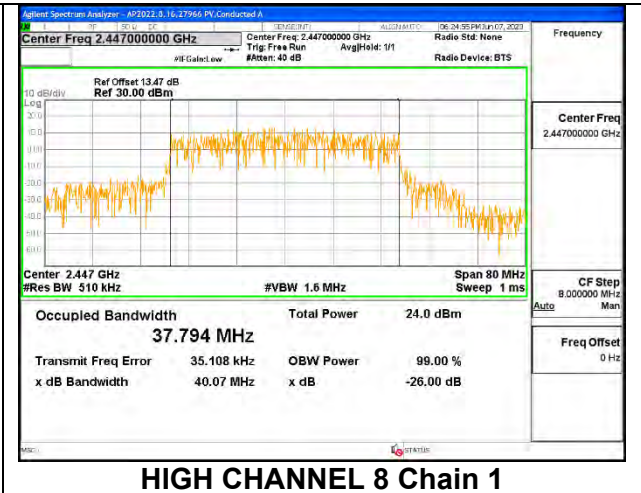

HIGH CHANNEL 8 Chain 1

HIGH CHANNEL 9

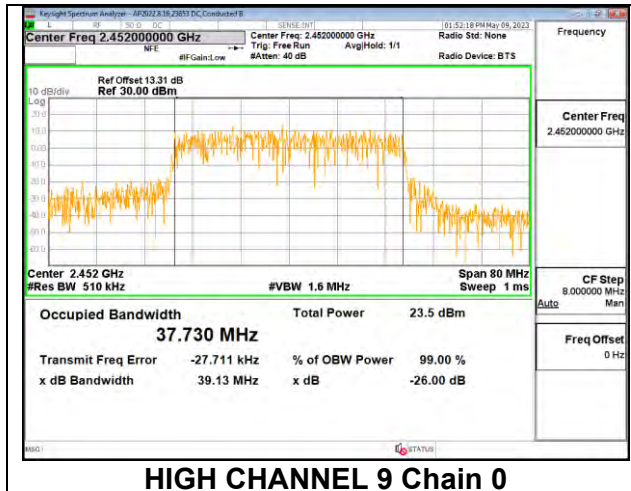

HIGH CHANNEL 9 Chain 0

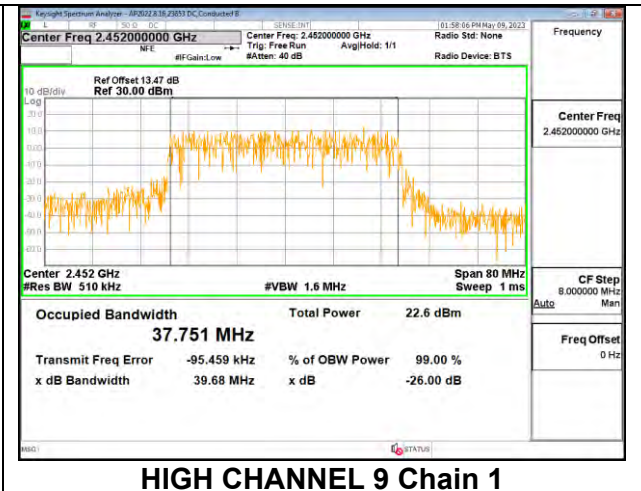

HIGH CHANNEL 9 Chain 1

9.3. 6 dB BANDWIDTH

LIMITS

FCC §15.247 (a) (2)

RSS-247 5.2 (a)

The minimum 6 dB bandwidth shall be at least 500 kHz.

RESULTS

9.3.1. 802.11ax HE20 MODE 1TX

1TX Chain 0 OFDMA MODE: 242-Tones, RU Index 61

Channel	Frequency (MHz)	6 dB Bandwidth (MHz)	Minimum Limit (MHz)
Low 1	2412	19.120	0.5
Low 2	2417	19.120	0.5
Mid 6	2437	19.120	0.5
High 11	2462	18.520	0.5

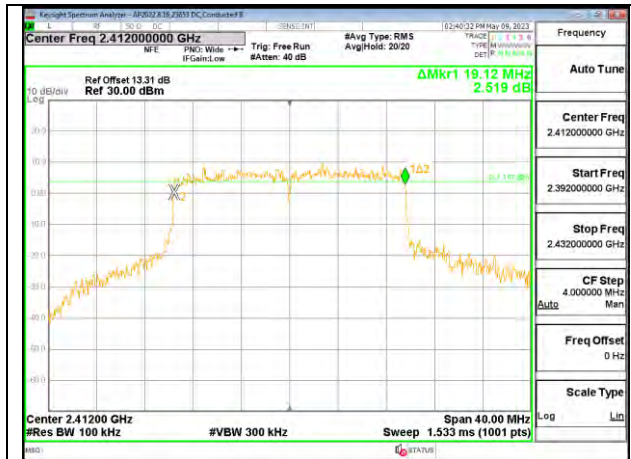

LOW CHANNEL 1



LOW CHANNEL 2



MID CHANNEL 6



HIGH CHANNEL 11

9.3.2. 802.11ax HE20 MODE 2TX

2TX Chain 0 + Chain 1 CDD OFDMA MODE: 242-Tones, RU Index 61

Channel	Frequency (MHz)	6 dB BW Chain 0 (MHz)	6 dB BW Chain 1 (MHz)	Minimum Limit (MHz)
Low 1	2412	18.76	17.72	0.5
Low 2	2417	18.84	19.16	0.5
Mid 6	2437	19.08	19.12	0.5
High 11	2462	19.00	19.12	0.5

LOW CHANNEL 1

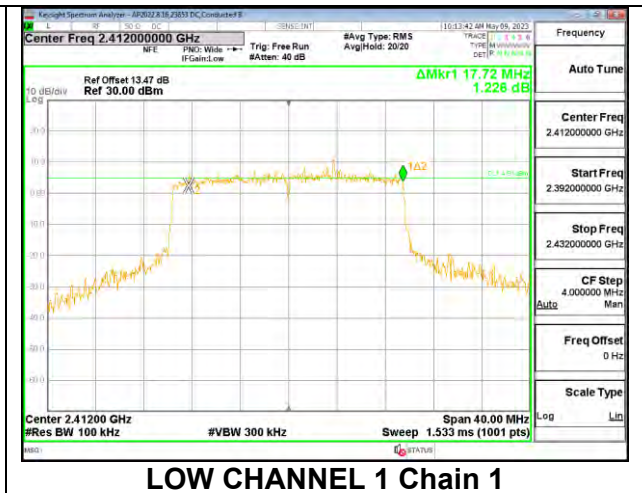
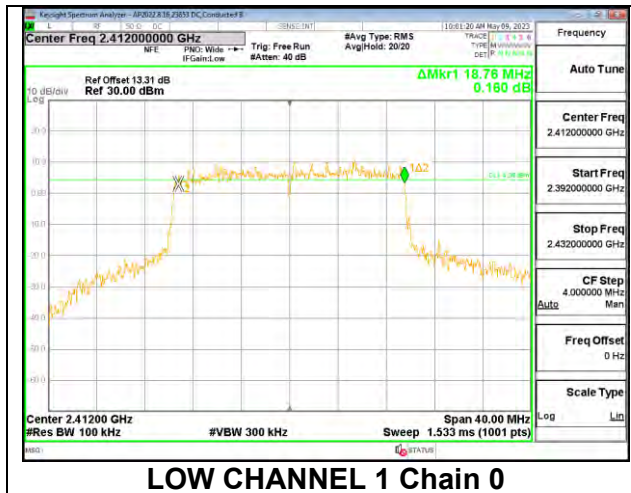

LOW CHANNEL 2

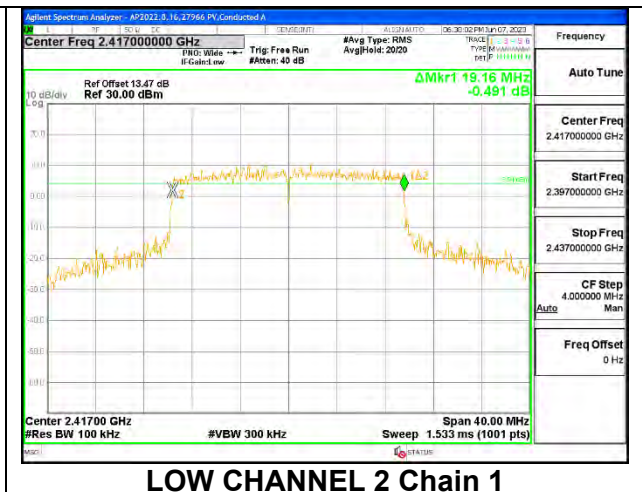
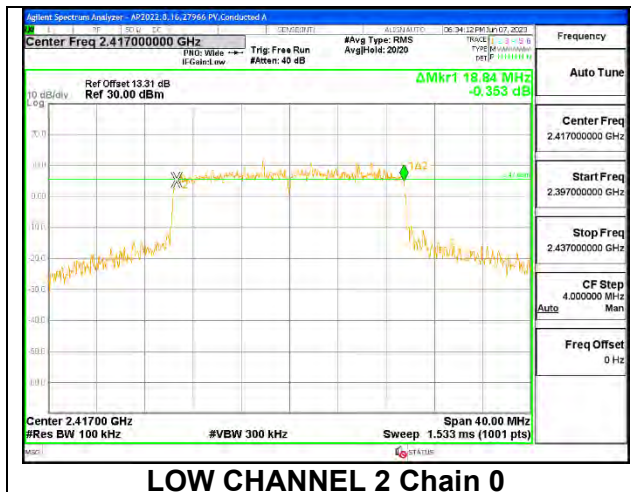

MID CHANNEL 6

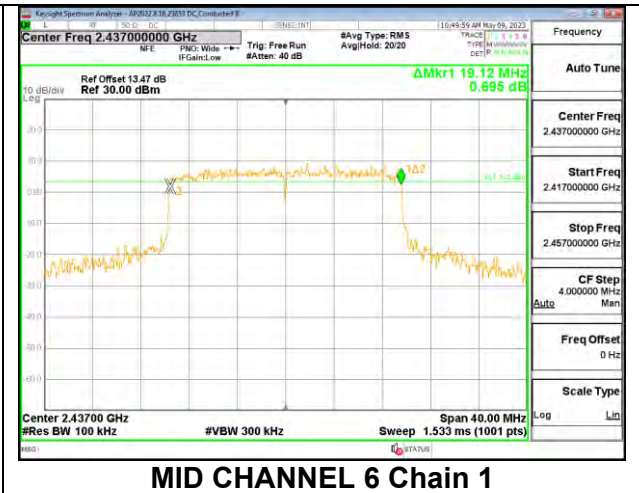
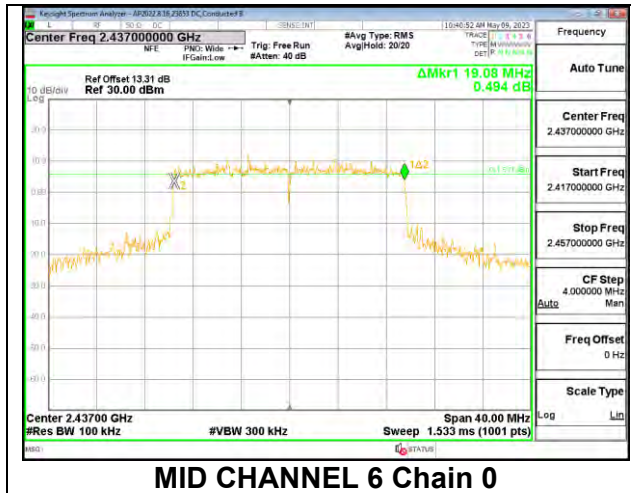

HIGH CHANNEL 11

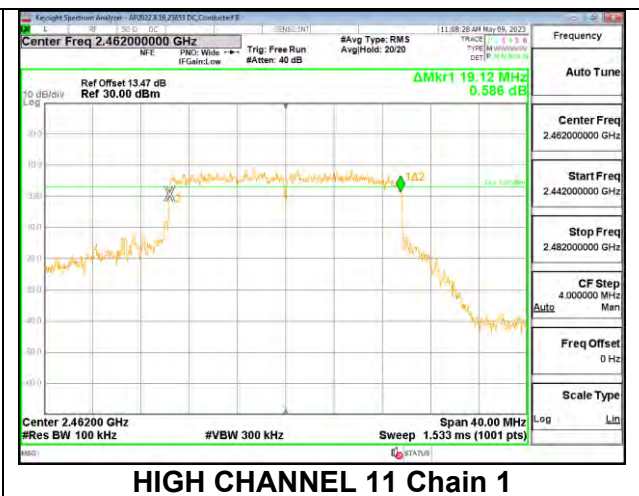
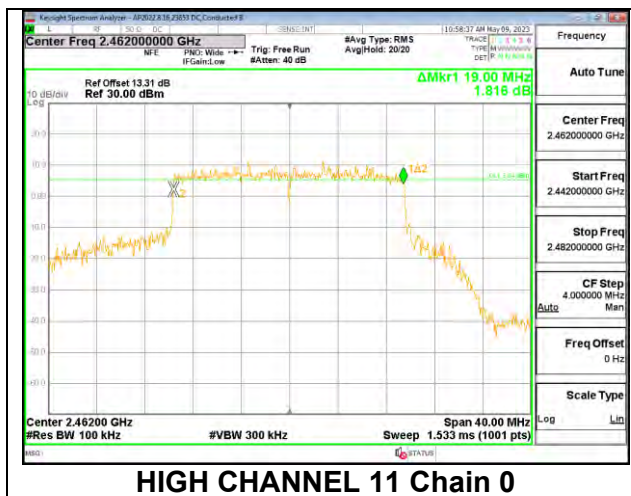

9.3.3. 802.11ax HE40 MODE 1TX

1TX Chain 0 OFDMA MODE: 484-Tones, RU Index 65

Channel	Frequency (MHz)	6 dB Bandwidth (MHz)	Minimum Limit (MHz)
Low 3	2422	37.36	0.5
Low 4	2427	37.84	0.5
Mid 6	2437	38.00	0.5
High 8	2447	37.92	0.5
High 9	2452	38.32	0.5



LOW CHANNEL 3

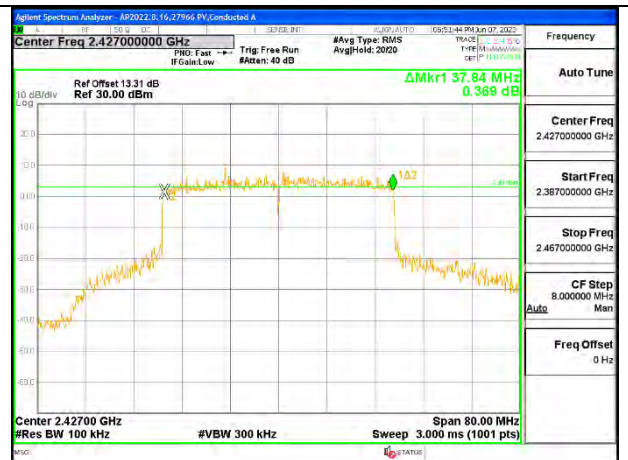

LOW CHANNEL 4



MID CHANNEL 6



HIGH CHANNEL 8

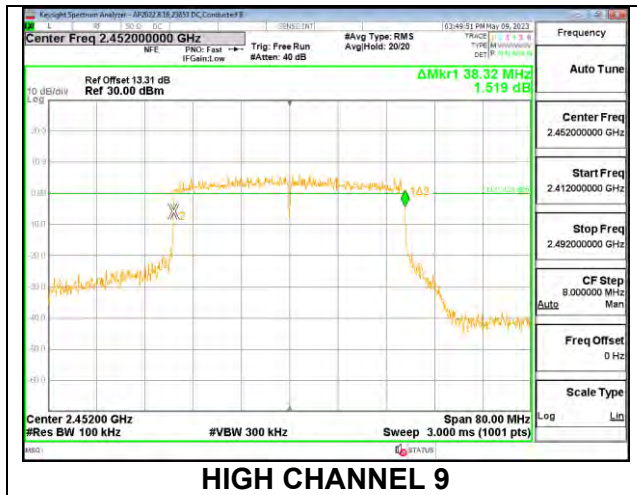

9.3.4. 802.11ax HE40 MODE 2TX

2TX Chain 0 + Chain 1 CDD OFDMA MODE: 484-Tones, RU Index 65

Channel	Frequency (MHz)	6 dB BW Chain 0 (MHz)	6 dB BW Chain 1 (MHz)	Minimum Limit (MHz)
Low 3	2422	37.60	36.96	0.5
Low 4	2427	38.24	38.08	0.5
Mid 6	2437	38.24	37.92	0.5
High 8	2447	38.24	38.08	0.5
High 9	2452	38.08	37.04	0.5

LOW CHANNEL 3

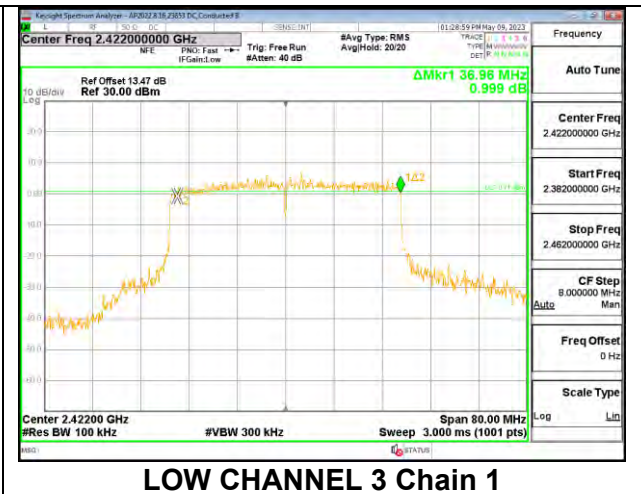
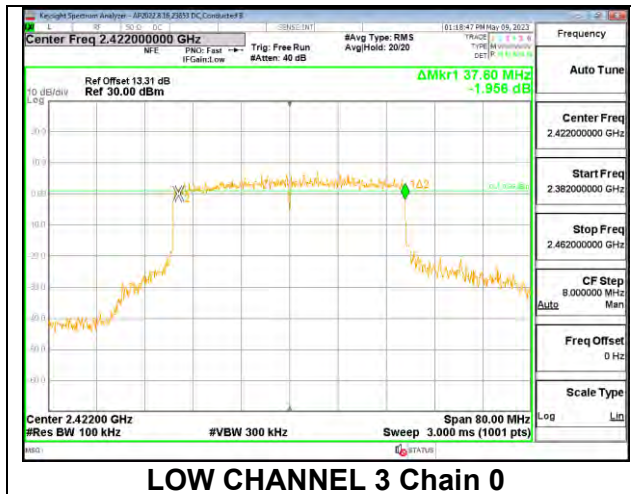

LOW CHANNEL 4

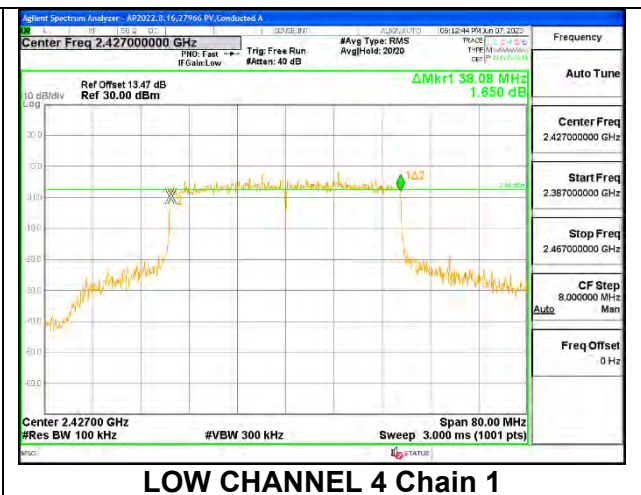

MID CHANNEL 6

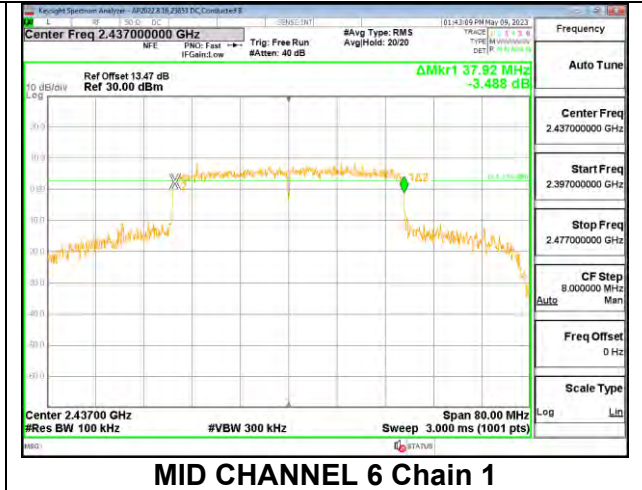
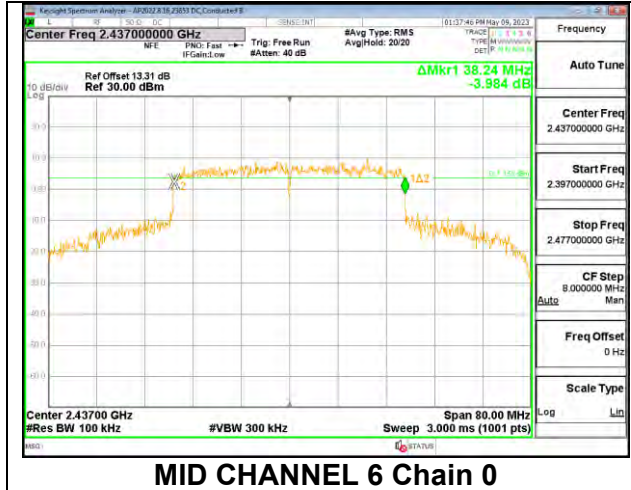

HIGH CHANNEL 8



HIGH CHANNEL 9

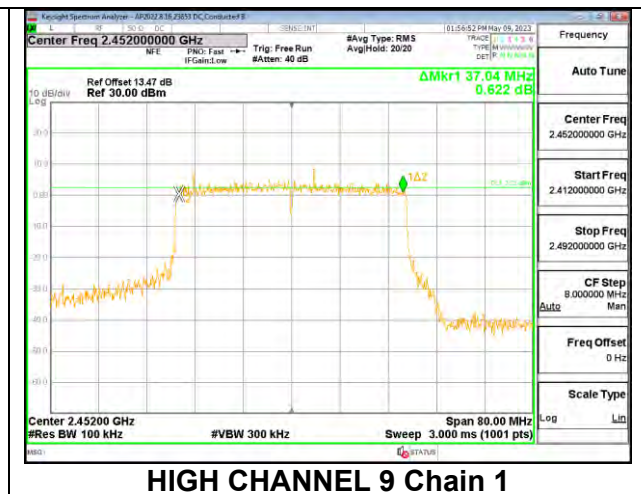

9.4. OUTPUT POWER

LIMITS

FCC §15.247 (b) (3)

RSS-247 5.4 (d)

For systems using digital modulation in the 902–928 MHz, 2400–2483.5 MHz, and 5725–5850 MHz bands: 1 Watt, based on the use of antennas with directional gains that do not exceed 6 dBi. If transmitting antennas of directional gain greater than 6 dBi are used, the conducted output power from the intentional radiator shall be reduced by the amount in dB that the directional gain of the antenna exceeds 6 dBi.

TEST PROCEDURE

The transmitter output is connected to a power meter.

The power output was measured on the EUT antenna port using SMA cable with 10dB attenuator connected to a power meter via wideband power sensor. Gated average output power was read directly from power meter.

DIRECTIONAL ANTENNA GAIN

For 1 TX:

There is only one transmitter output therefore the directional gain is equal to the antenna gain.

For 2 TX:

Tx chains are uncorrelated for power and correlated for PSD due to the device supporting CDD in all MIMO modes. The directional gains are as follows:

Band (GHz)	Chain 0 Antenna Gain (dBi)	Chain 1 Antenna Gain (dBi)	Uncorrelated Chains Directional Gain (dBi)	Correlated Chains Directional Gain (dBi)
2.4	3.80	3.80	3.80	6.81

DIRECTIONAL GAIN CALCULATION

ANSI C63.10-2013 section 14.4.3

In the commonly occurring case of N_{ANT} transmit antennas, each with the same directional gain G_{ANT} dBi, being driven by N_{ANT} transmitter outputs of equal power, directional gain shall be computed as follows:

- a) If any transmit signals are correlated with each other:
Directional gain = $G_{ANT} + 10 \log (N_{ANT})$ dBi
- b) If all transmit signals are completely uncorrelated with each other:
Directional gain = G_{ANT}

Sample Calculation:

Ant1=3.8, Ant2=3.8

Correlated Antenna gain=3.8 + 10log (2) =6.81dBi

RESULT

9.4.1. 802.11ax HE20 MODE 1TX

1TX Chain 0 OFDMA MODE: 242-Tones, RU Index 61

Test Engineer:	PV 27966
Test Date:	2023-05-30

Limits

Channel	Frequency (MHz)	Directional Gain (dBi)	FCC Power Limit (dBm)	ISED Power Limit (dBm)	ISED EIRP Limit (dBm)	Max Power (dBm)
Low 1	2412	3.80	30.00	30.00	36.00	30.00
Low 2	2417	3.80	30.00	30.00	36.00	30.00
Mid 6	2437	3.80	30.00	30.00	36.00	30.00
High 11	2462	3.80	30.00	30.00	36.00	30.00

Results

Channel	Frequency (MHz)	Meas Power (dBm)	Total Corr'd Power (dBm)	Power Limit (dBm)	Margin (dB)
Low 1	2412	22.37	22.37	30.00	-7.63
Low 2	2417	22.61	22.61	30.00	-7.39
Mid 6	2437	24.58	24.58	30.00	-5.42
High 11	2462	23.48	23.48	30.00	-6.52

9.4.2. 802.11ax HE20 MODE 2TX

2TX Chain 0 + Chain 1 CDD OFDMA MODE: 242-Tones, RU Index 61

Test Engineer:	PV 27966
Test Date:	2023-05-30

Limits

Channel	Frequency (MHz)	Directional Gain (dBi)	FCC/ISED Power Limit (dBm)	ISED EIRP Limit (dBm)	Max Power (dBm)
Low 1	2412	3.80	30.00	36.00	30.00
Low 2	2417	3.80	30.00	36.00	30.00
Mid 6	2437	3.80	30.00	36.00	30.00
High 11	2462	3.80	30.00	36.00	30.00

Results

Channel	Frequency (MHz)	Chain 0 Meas Power (dBm)	Chain 1 Meas Power (dBm)	Total Corr'd Power (dBm)	Power Limit (dBm)	Margin (dB)
Low 1	2412	22.27	22.04	25.17	30.00	-4.83
Low 2	2417	22.87	22.76	25.83	30.00	-4.17
Mid 6	2437	24.78	24.22	27.52	30.00	-2.48
High 11	2462	22.78	22.42	25.61	30.00	-4.39

9.4.3. 802.11ax HE40 MODE 1TX

1TX Chain 0 OFDMA MODE: 484-Tones, RU Index 65

Test Engineer:	ZS 16080
Test Date:	2023-05-30

Limits

Channel	Frequency (MHz)	Directional Gain (dBi)	FCC Power Limit (dBm)	ISED Power Limit (dBm)	ISED EIRP Limit (dBm)	Max Power (dBm)
Low 3	2422	3.80	30.00	30.00	36.00	30.00
Low 4	2427	3.80	30.00	30.00	36.00	30.00
Mid 6	2437	3.80	30.00	30.00	36.00	30.00
High 8	2447	3.80	30.00	30.00	36.00	30.00
High 9	2452	3.80	30.00	30.00	36.00	30.00

Results

Channel	Frequency (MHz)	Meas Power (dBm)	Total Corr'd Power (dBm)	Power Limit (dBm)	Margin (dB)
Low 3	2422	23.52	23.52	30.00	-6.48
Low 4	2427	24.22	24.22	30.00	-5.78
Mid 6	2437	25.80	25.80	30.00	-4.20
High 8	2447	24.74	24.74	30.00	-5.26
High 9	2452	23.05	23.05	30.00	-6.95

9.4.4. 802.11ax HE40 MODE 2TX

2TX Chain 0 + Chain 1 CDD OFDMA MODE: 484-Tones, RU Index 65

Test Engineer:	ZS 16080
Test Date:	2023-05-30

Limits

Channel	Frequency (MHz)	Directional Gain (dBi)	FCC/ISED Power Limit (dBm)	ISED EIRP Limit (dBm)	Max Power (dBm)
Low 3	2422	3.80	30.00	36.00	30.00
Low 4	2427	3.80	30.00	36.00	30.00
Mid 6	2437	3.80	30.00	36.00	30.00
High 8	2447	3.80	30.00	36.00	30.00
High 9	2452	3.80	30.00	36.00	30.00

Results

Channel	Frequency (MHz)	Chain 0 Meas Power (dBm)	Chain 1 Meas Power (dBm)	Total Corr'd Power (dBm)	Power Limit (dBm)	Margin (dB)
Low 3	2422	23.40	23.14	26.28	30.00	-3.72
Low 4	2427	23.89	23.63	26.77	30.00	-3.23
Mid 6	2437	25.79	25.68	28.75	30.00	-1.25
High 8	2447	23.82	23.65	26.75	30.00	-3.25
High 9	2452	23.21	23.44	26.34	30.00	-3.66

9.5. POWER SPECTRAL DENSITY

LIMITS

FCC §15.407 (e)

RSS-247(5.2)(b)

The power spectral density conducted from the transmitter to the antenna shall not be greater than 8 dBm in any 3 kHz band during any time interval of continuous transmission.

RESULTS

RBW setting used 30kHz according to ANSI 63.10, Section 11.10.3 Method AVGPS-1

9.5.1. 802.11ax HE20 MODE 1TX

1TX Chain 0 OFDMA MODE: 242-Tones, RU Index 61

Duty Cycle CF (dB)	0.18	Included in Calculations of Corr'd PSD
--------------------	------	--

PSD Results

Channel	Frequency (MHz)	Chain 0 Meas (dBm/30kHz)	Total Corr'd PSD (dBm/30kHz)	Limit (dBm/30kHz)	Margin (dB)
Low 1	2412	-2.45	-2.27	8.0	-10.3
Low 2	2417	-1.81	-1.63	8.0	-9.6
Mid 6	2437	-1.63	-1.45	8.0	-9.4
High 11	2462	-1.97	-1.79	8.0	-9.8

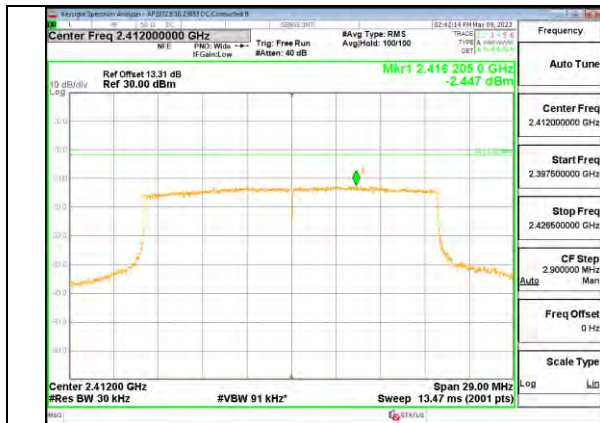

LOW CHANNEL 1

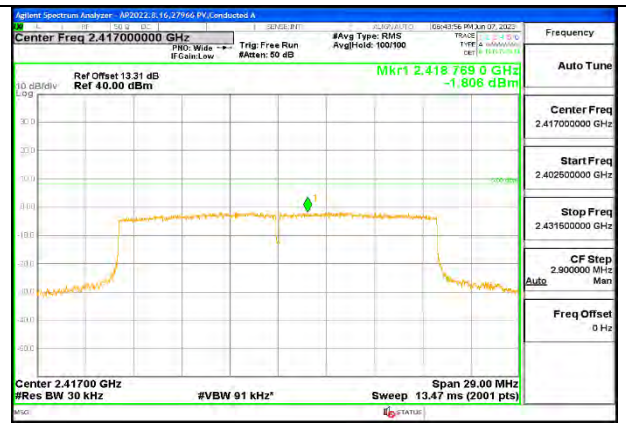

LOW CHANNEL 2

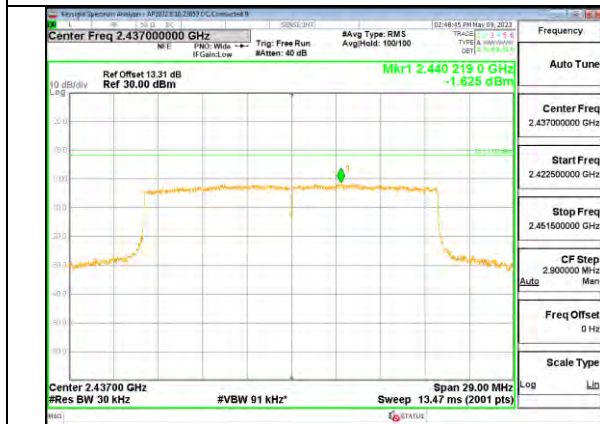

MID CHANNEL 6

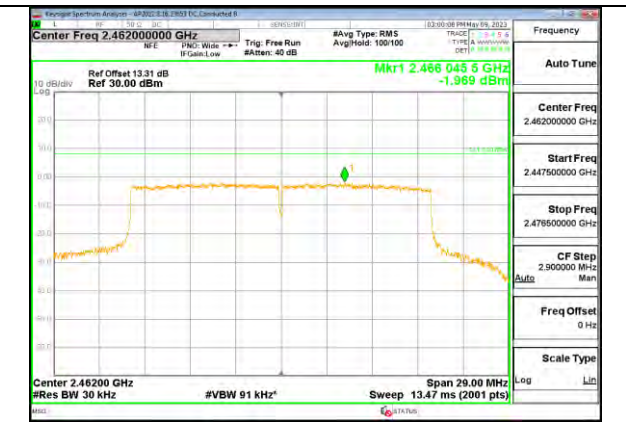

HIGH CHANNEL 11

9.5.2. 802.11ax HE20 MODE 2TX

2TX Chain 0 + Chain 1 CDD OFDMA MODE: 242-Tones, RU Index 61

Duty Cycle CF (dB)	0.13	Included in Calculations of Corr'd PSD
--------------------	------	--

PSD Results

Channel	Frequency (MHz)	Chain 0 Meas (dBm/30kHz)	Chain 1 Meas (dBm/30kHz)	Total Corr'd PSD (dBm/30kHz)	Limit (dBm/30kHz)	Margin (dB)
Low 1	2412	-2.33	-3.25	0.37	8.0	-7.6
Low 2	2417	-1.44	-1.60	1.62	8.0	-6.4
Mid 6	2437	-1.31	-2.34	1.34	8.0	-6.7
High 11	2462	-1.46	-3.04	0.96	8.0	-7.0

LOW CHANNEL 1

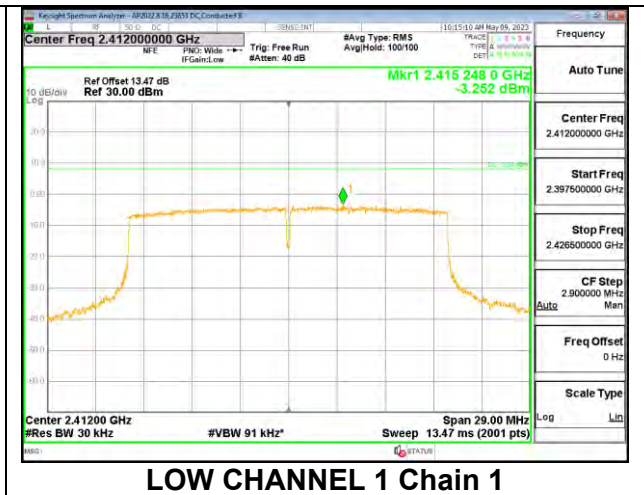
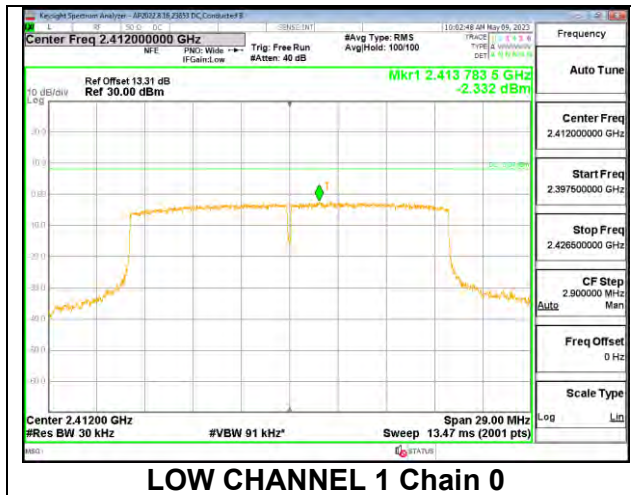

LOW CHANNEL 2

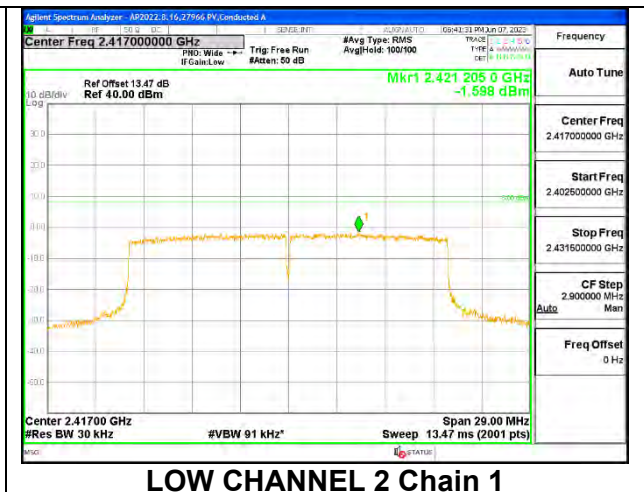
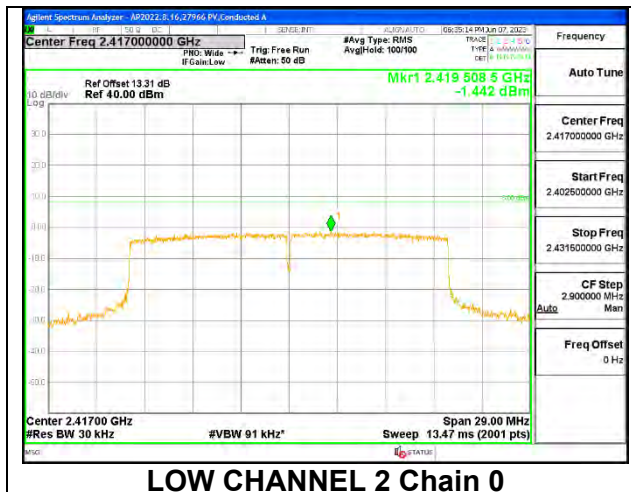

MID CHANNEL 6

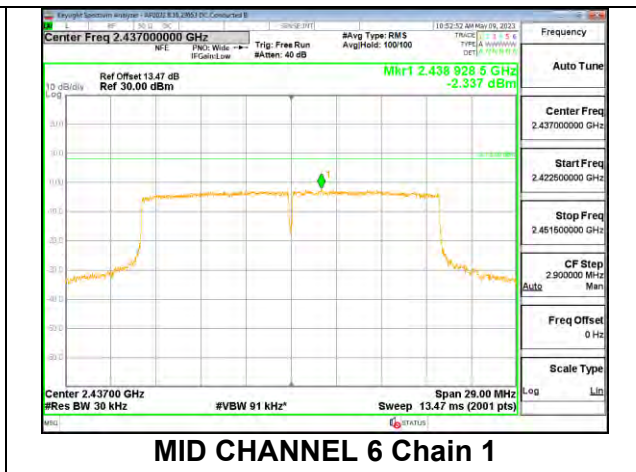
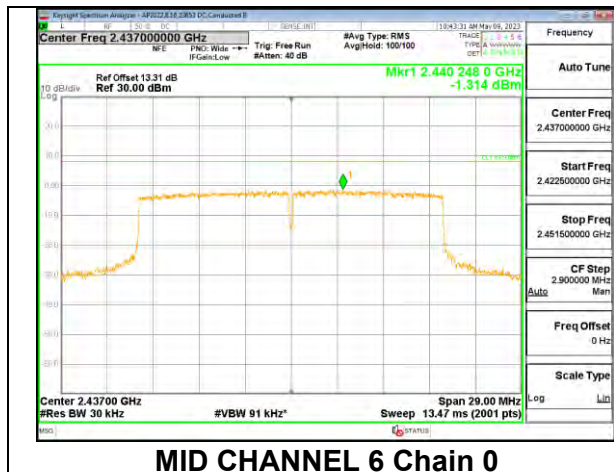

HIGH CHANNEL 11

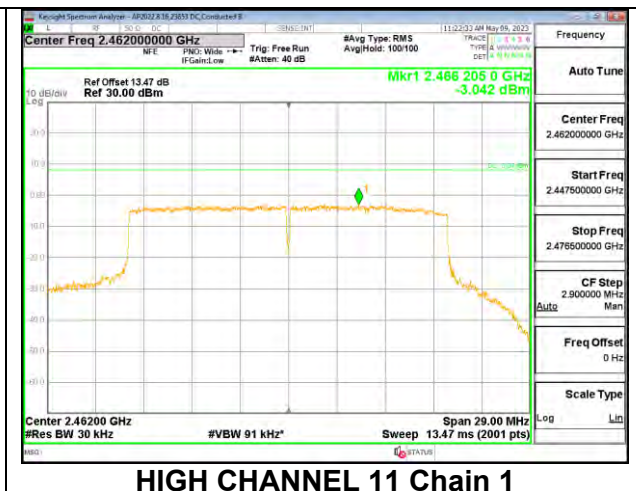
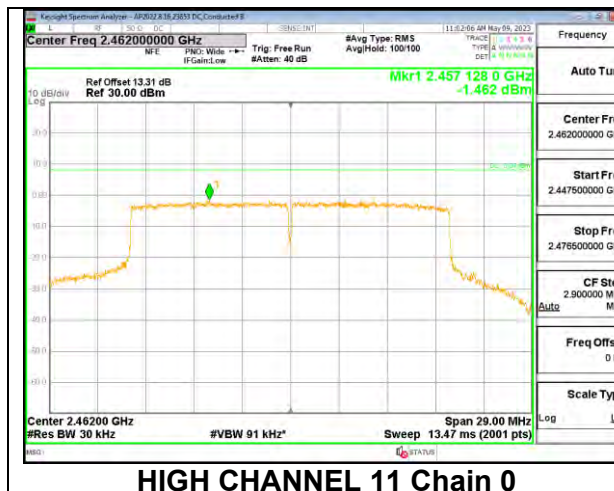

9.5.3. 802.11ax HE40 MODE 1TX

1TX Chain 0 OFDMA MODE: 484-Tones, RU Index 65

Duty Cycle CF (dB) 0.13 Included in Calculations of Corr'd PSD

PSD Results

Channel	Frequency (MHz)	Chain 0 Meas (dBm/30kHz)	Total Corr'd PSD (dBm/30kHz)	Limit (dBm/30kHz)	Margin (dB)
Low 3	2422	-5.48	-5.35	8.0	-13.3
Low 4	2427	-5.06	-4.93	8.0	-12.9
Mid 6	2437	-2.87	-2.74	8.0	-10.7
High 8	2447	-4.08	-3.95	8.0	-11.9
High 9	2452	-5.74	-5.61	8.0	-13.6

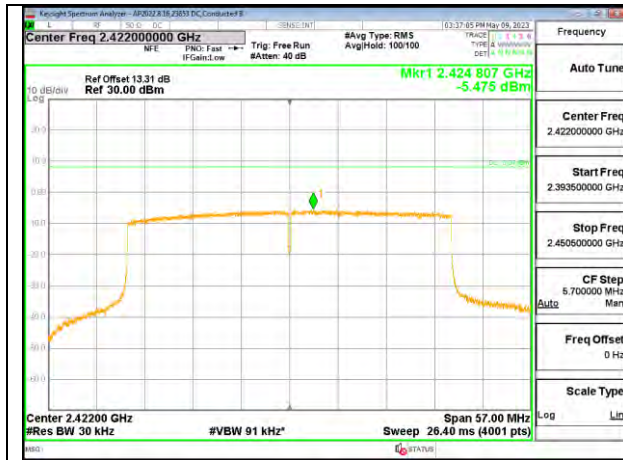

LOW CHANNEL 3

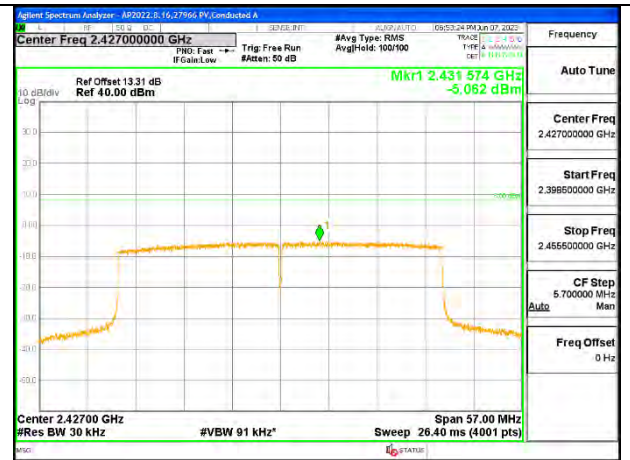

LOW CHANNEL 4



MID CHANNEL 6

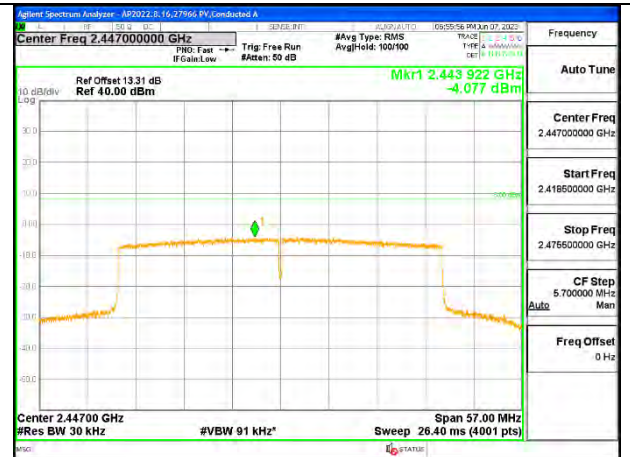

HIGH CHANNEL 8

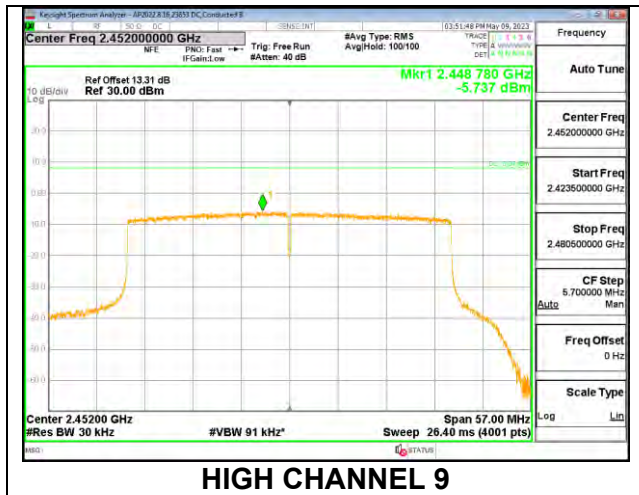

9.5.4. 802.11ax HE40 MODE 2TX

2TX Chain 0 + Chain 1 CDD OFDMA MODE: 484-Tones, RU Index 65

Duty Cycle CF (dB)		Included in Calculations of Corr'd PSD				
0.16						
PSD Results						
Channel	Frequency (MHz)	Chain 0 Meas (dBm/30kHz)	Chain 1 Meas (dBm/30kHz)	Total Corr'd PSD (dBm/30kHz)	Limit (dBm/30kHz)	Margin (dB)
Low 3	2422	-5.32	-6.02	-2.49	8.0	-10.5
Low 4	2427	-5.00	-5.29	-1.97	8.0	-10.0
Mid 6	2437	-2.99	-3.31	0.02	8.0	-8.0
High 8	2447	-4.82	-5.12	-1.80	8.0	-9.8
High 9	2452	-5.89	-6.63	-3.07	8.0	-11.1

LOW CHANNEL 3

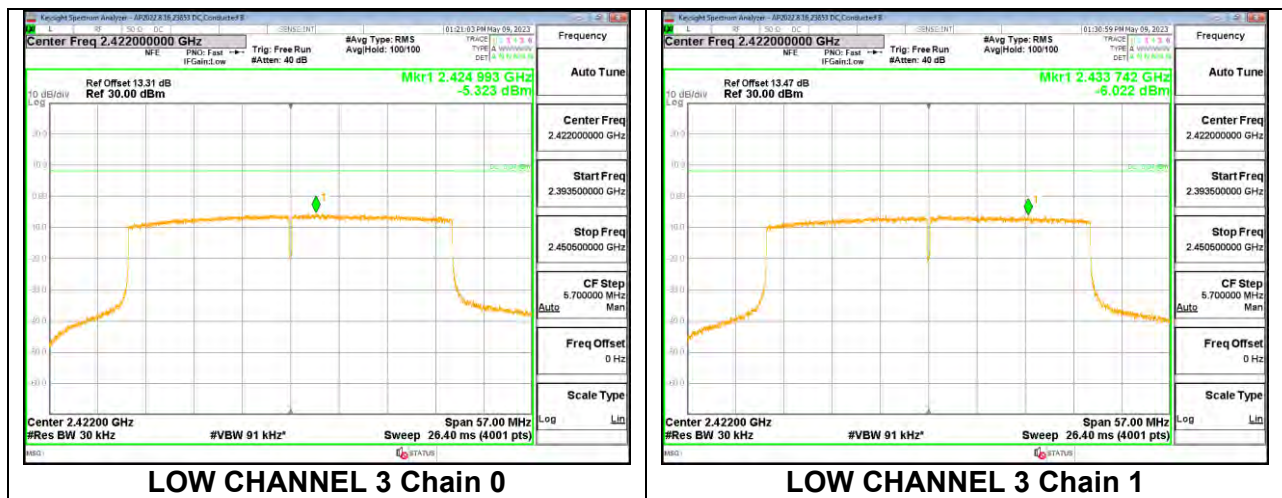

LOW CHANNEL 4

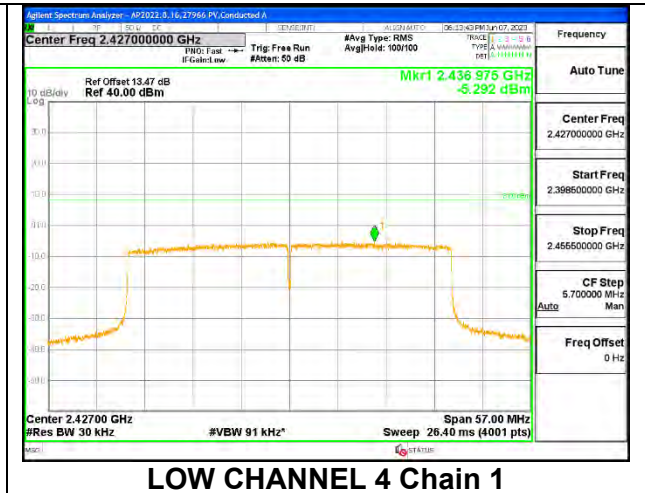
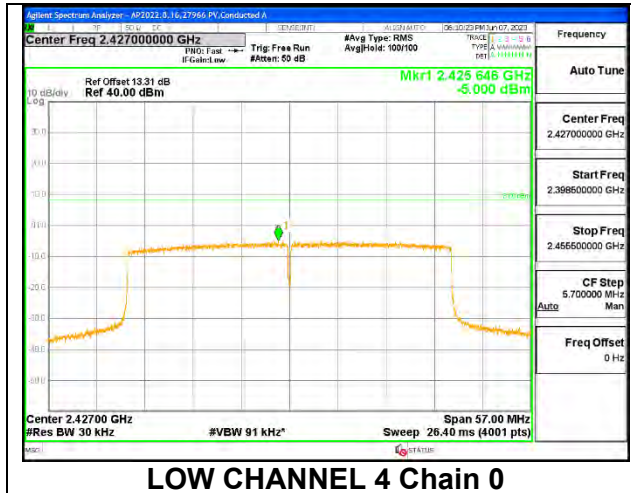

MID CHANNEL 6

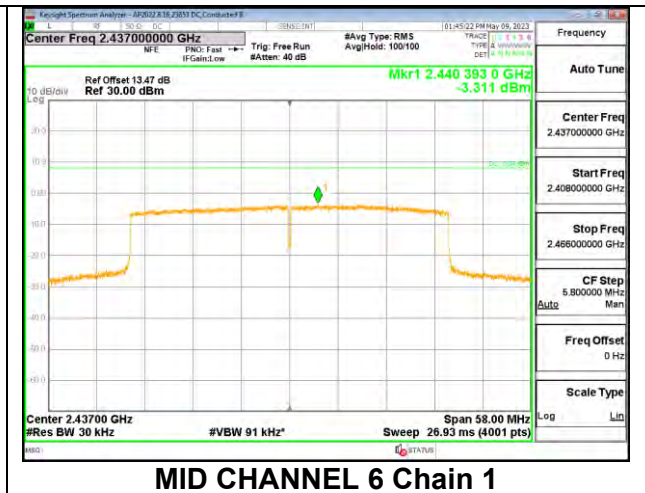
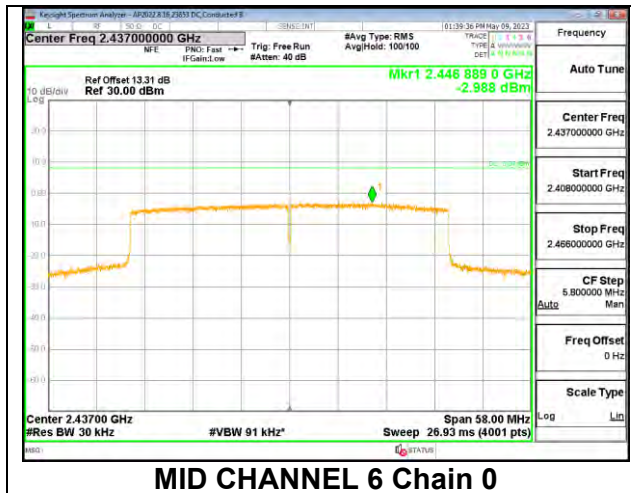

HIGH CHANNEL 8

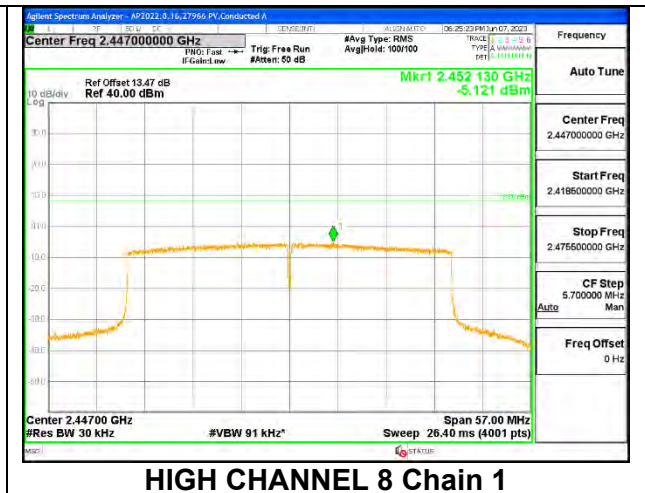
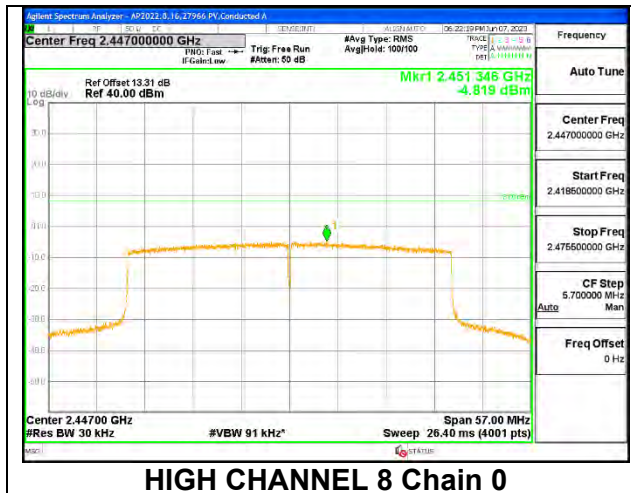

HIGH CHANNEL 9

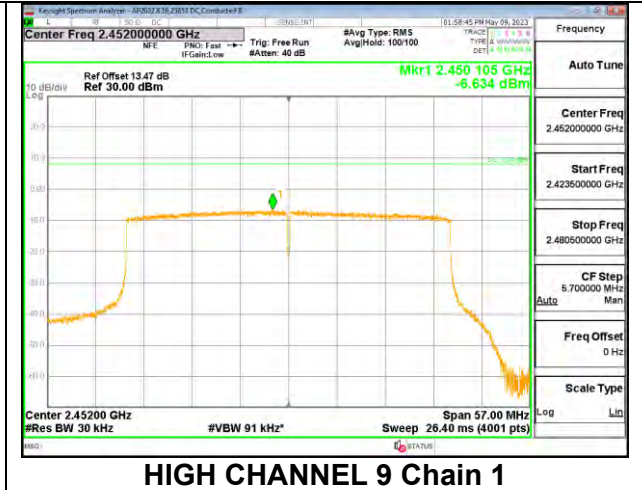
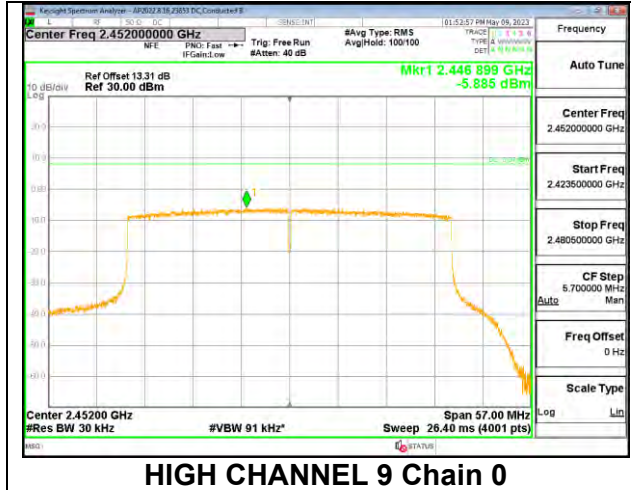

9.6. CONDUCTED SPURIOUS EMISSIONS

LIMITS

FCC §15.407 (d)

RSS-247 5.5

(d) In any 100 kHz bandwidth outside the frequency band in which the spread spectrum or digitally modulated intentional radiator is operating, the radio frequency power that is produced by the intentional radiator shall be at least 20 dB below that in the 100 kHz bandwidth within the band that contains the highest level of the desired power, based on either an RF conducted or a radiated measurement, provided the transmitter demonstrates compliance with the peak conducted power limits. If the transmitter complies with the conducted power limits based on the use of RMS averaging over a time interval, as permitted under paragraph (b)(3) of this section, the attenuation required under this paragraph shall be 30 dB instead of 20 dB.

PROCEDURE

Output power was measured based on the use of average measurement, therefore the required attenuation is 30 dBc.

RESULTS

9.6.1. 802.11ax HE20 MODE 1TX

1TX Chain 0 OFDMA MODE: 242-Tones, RU Index 61

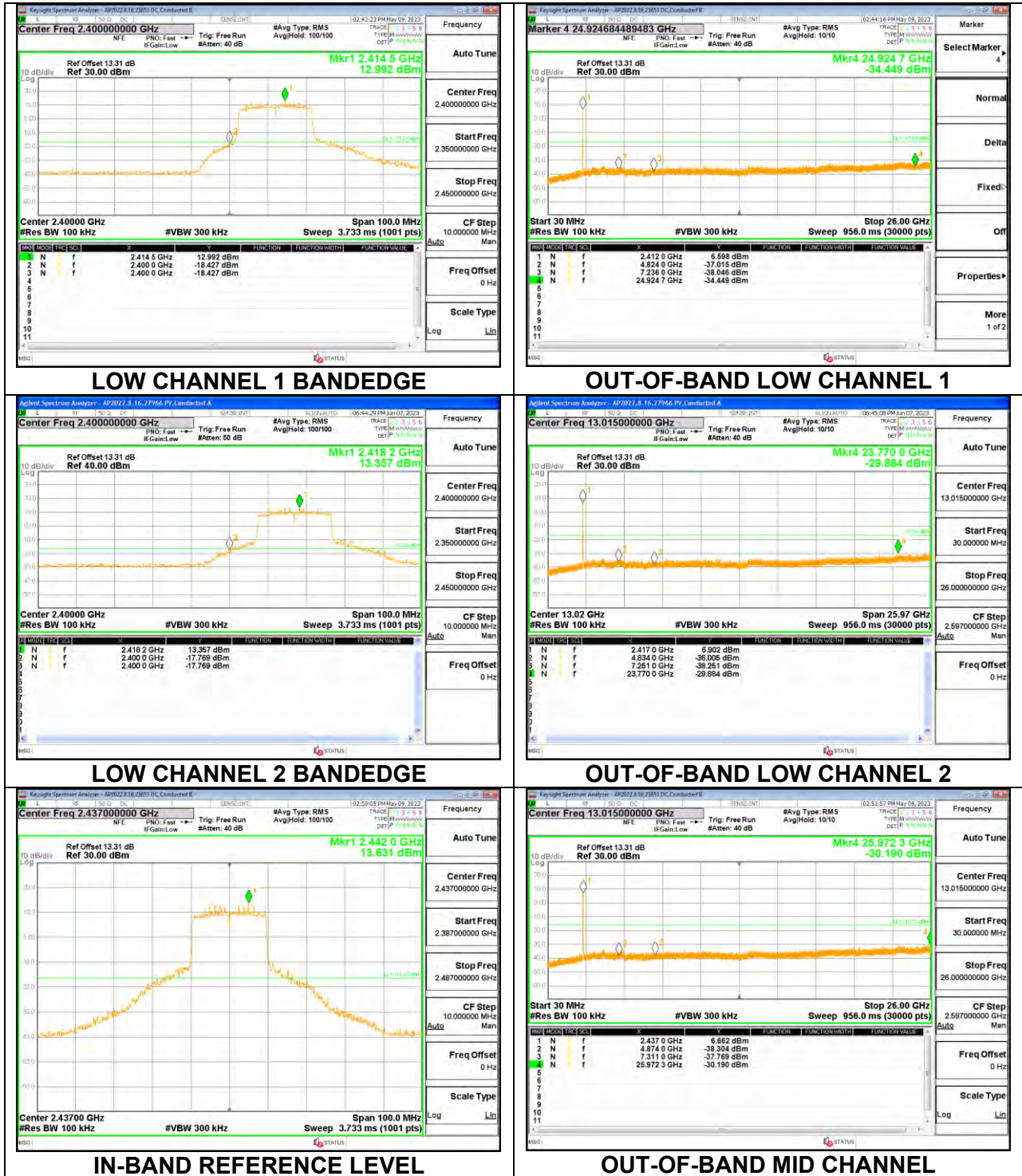

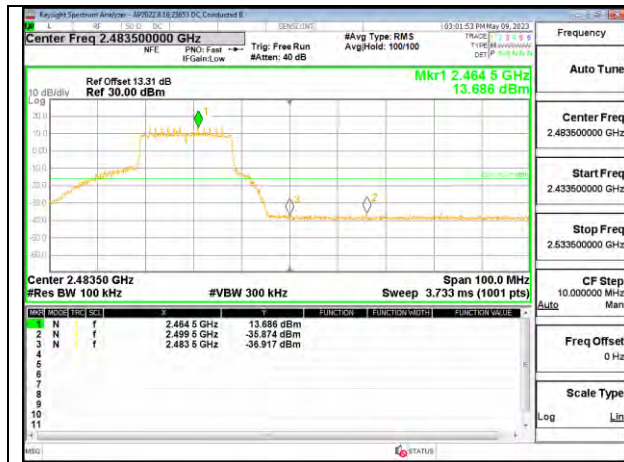

HIGH CHANNEL 11 BANDEDGE

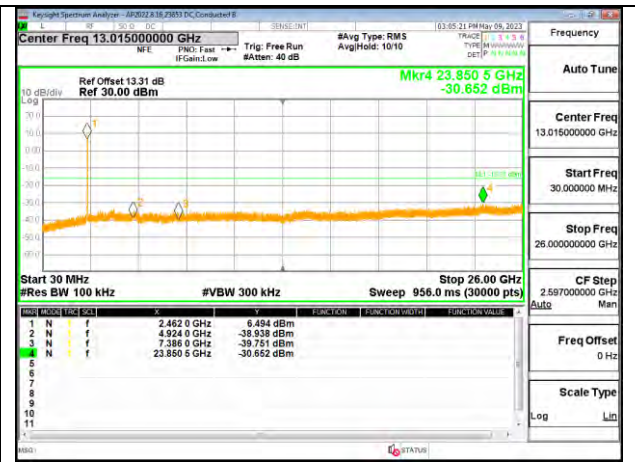

OUT-OF-BAND HIGH CHANNEL 11

9.6.2. 802.11ax HE20 MODE 2TX

2TX Chain 0 + Chain 1 CDD OFDMA MODE: 242-Tones, RU Index 61

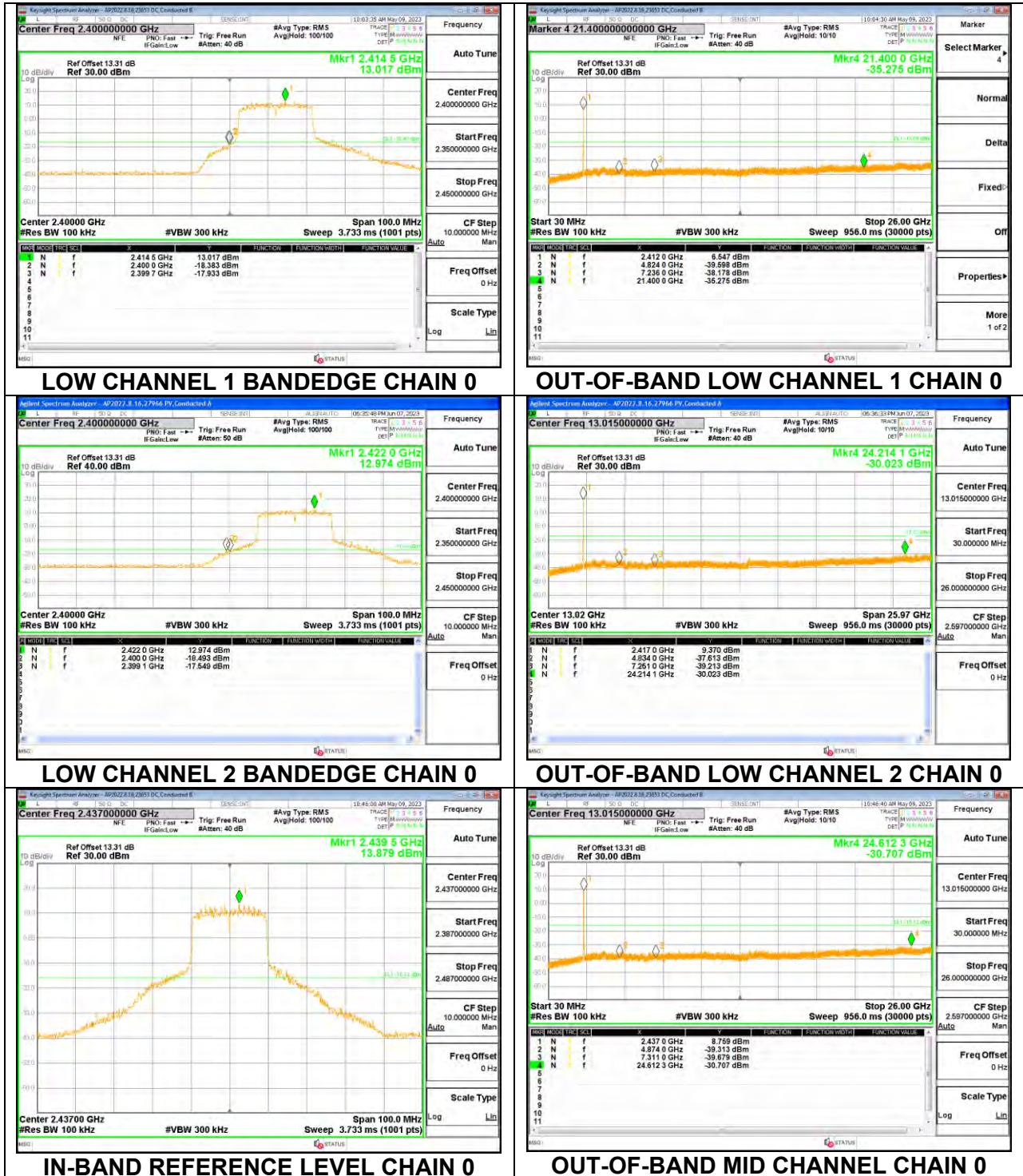

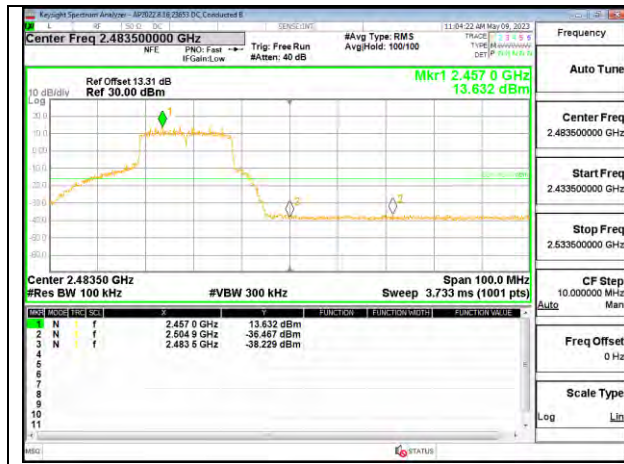

HIGH CHANNEL 11 BANDEDGE CHAIN 0

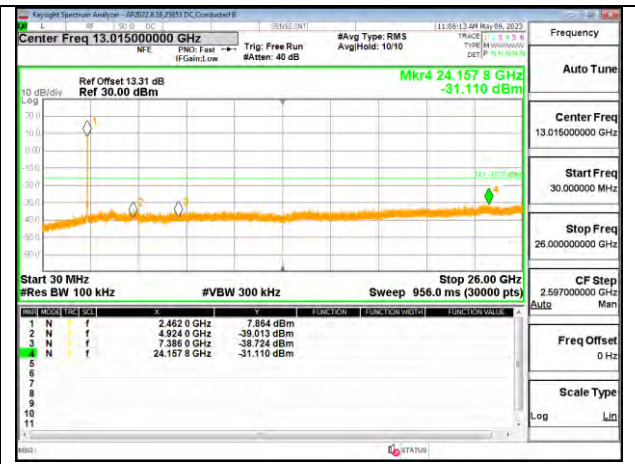

OUT-OF-BAND HIGH CHANNEL 11 CHAIN 0

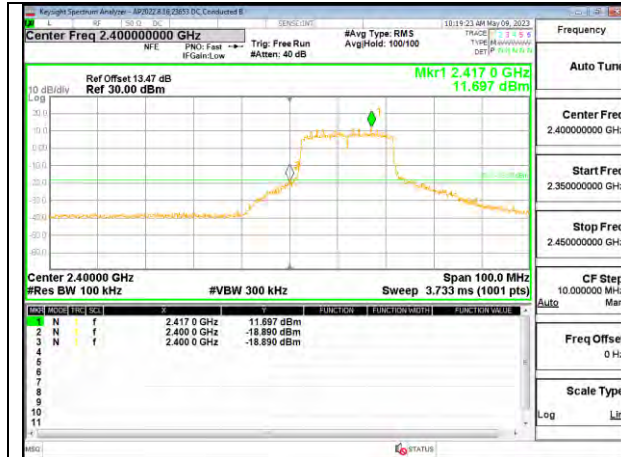

LOW CHANNEL 1 BANDEDGE CHAIN 1



OUT-OF-BAND LOW CHANNEL 1 CHAIN 1

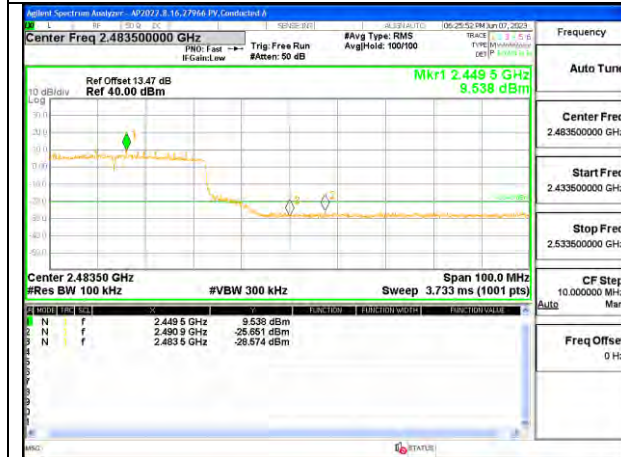

LOW CHANNEL 2 BANDEDGE CHAIN 1

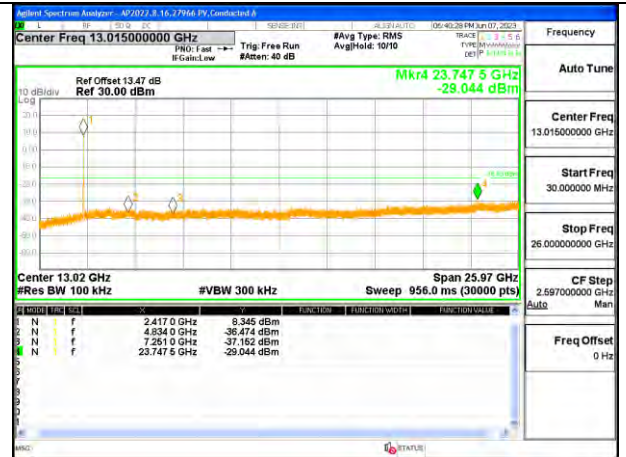

OUT-OF-BAND LOW CHANNEL 2 CHAIN 1

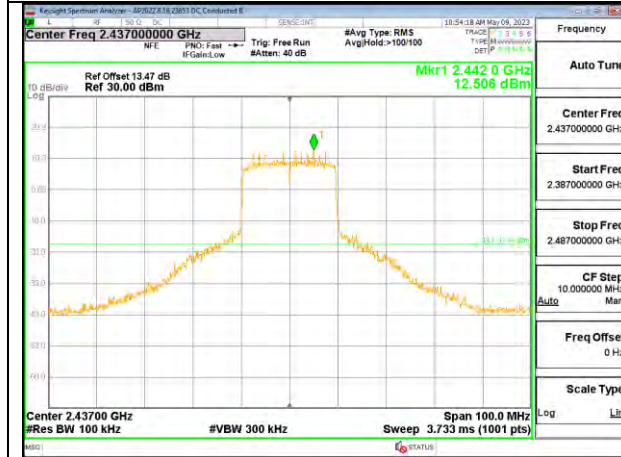

IN-BAND REFERENCE LEVEL CHAIN 1

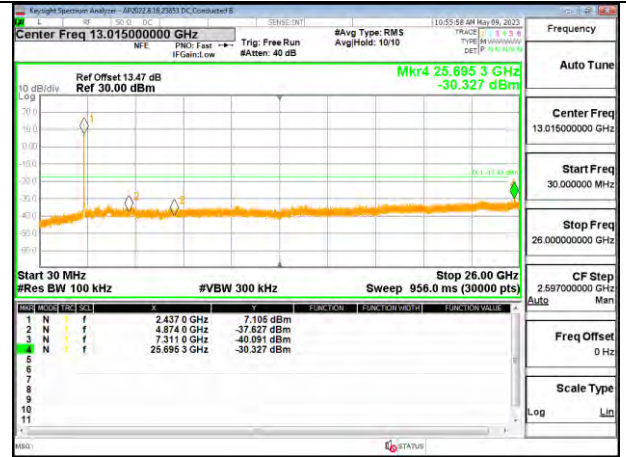

OUT-OF-BAND MID CHANNEL CHAIN 1

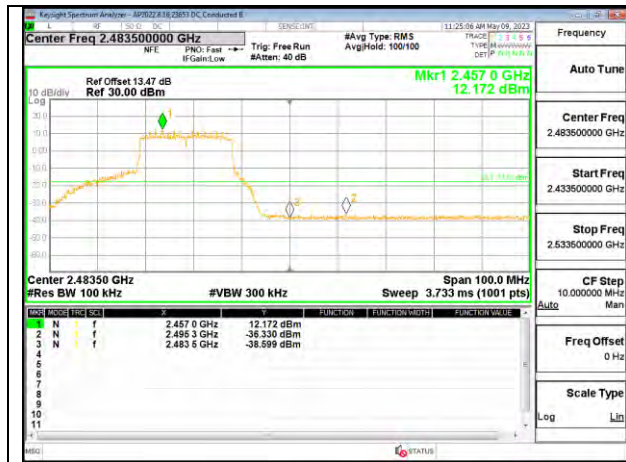

HIGH CHANNEL 11 BANDEDGE CHAIN 1

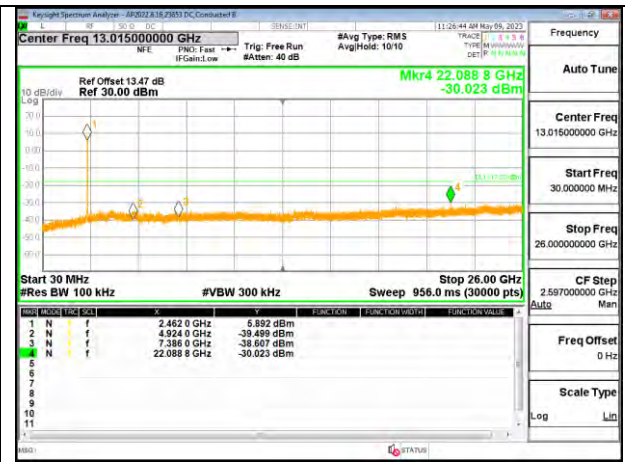

OUT-OF-BAND HIGH CHANNEL 11 CHAIN 1

9.6.3. 802.11ax HE40 MODE 1TX

1TX Chain 0 OFDMA MODE: 484-Tones, RU Index 65

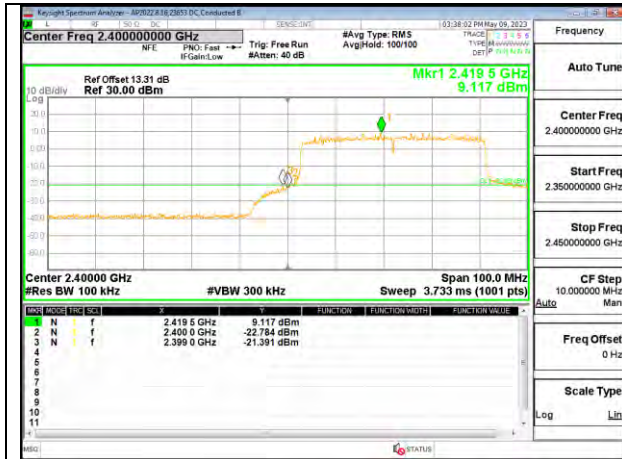

LOW CHANNEL 3 BANDEDGE

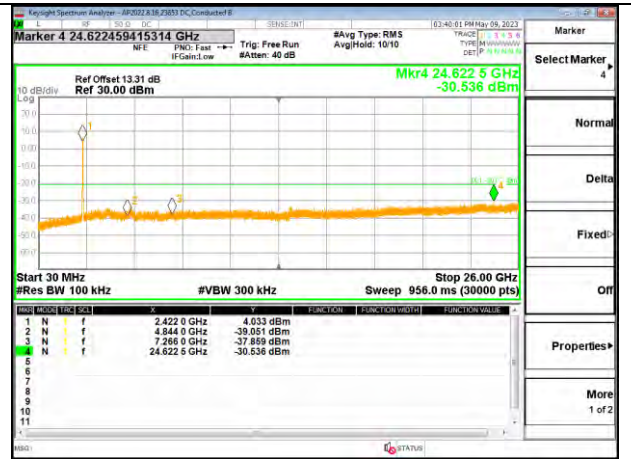

OUT-OF-BAND LOW CHANNEL 3



LOW CHANNEL 4 BANDEDGE

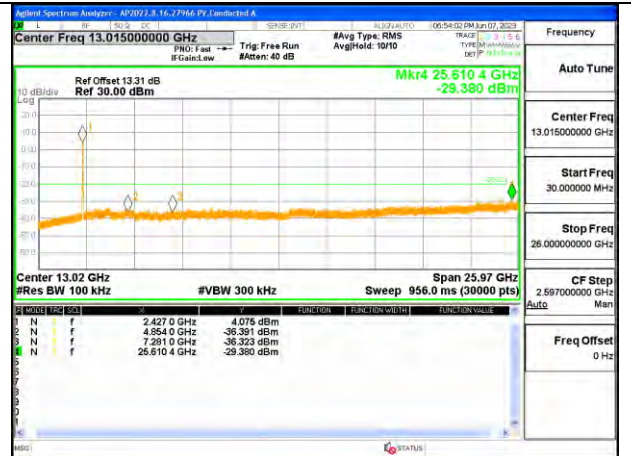

OUT-OF-BAND LOW CHANNEL 4

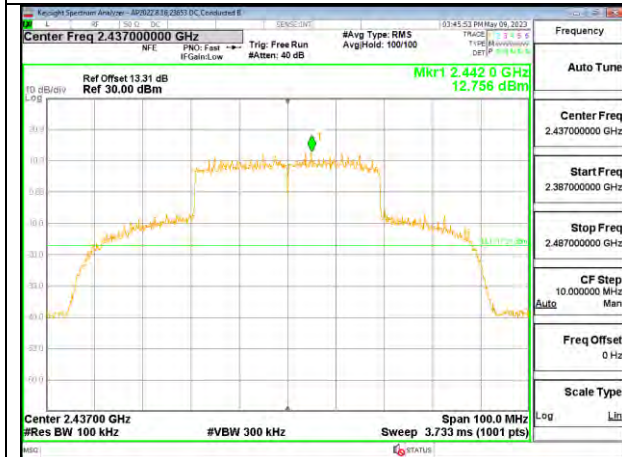

IN-BAND REFERENCE LEVEL

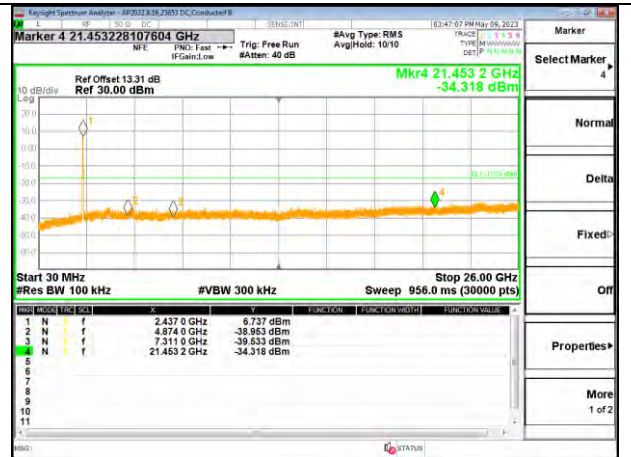

OUT-OF-BAND MID CHANNEL



HIGH CHANNEL 8 BANDEDGE



OUT-OF-BAND HIGH CHANNEL 8



HIGH CHANNEL 9 BANDEDGE



OUT-OF-BAND HIGH CHANNEL 9

9.6.4. 802.11ax HE40 MODE 2TX

2TX Chain 0 + Chain 1 CDD OFDMA MODE: 484-Tones, RU Index 65

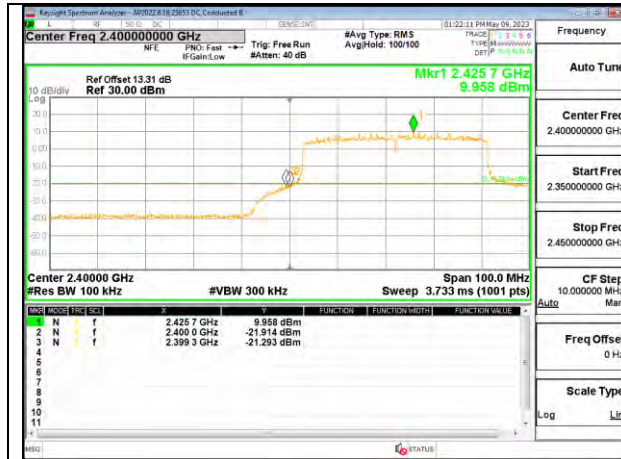

LOW CHANNEL 3 BANDEDGE CHAIN 0

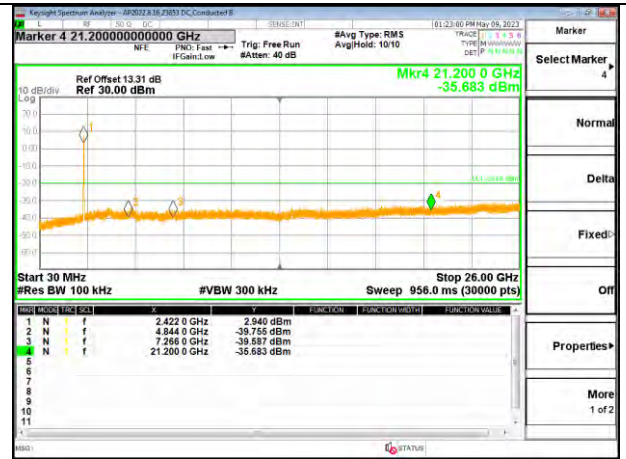

OUT-OF-BAND LOW CHANNEL 3 CHAIN 0

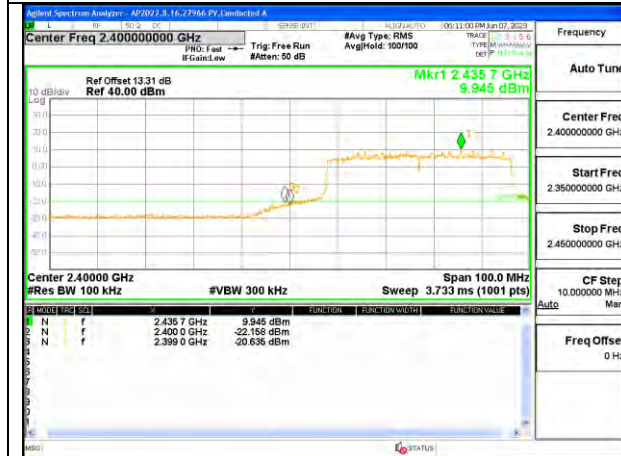

LOW CHANNEL 4 BANDEDGE CHAIN 0

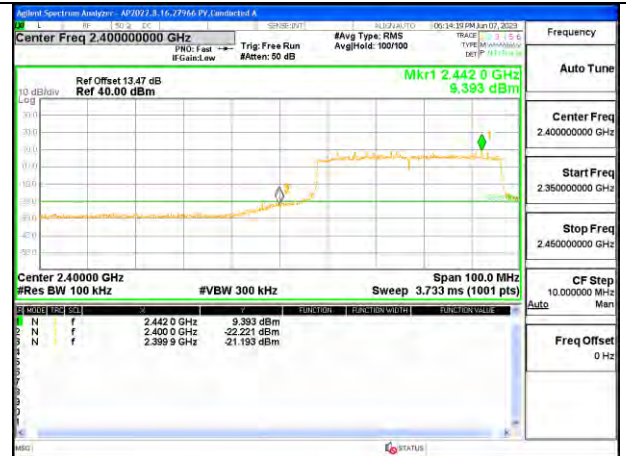

OUT-OF-BAND LOW CHANNEL 4 CHAIN 0

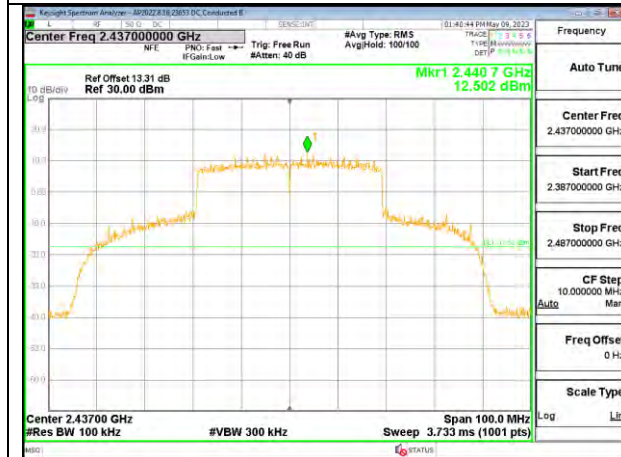

IN-BAND REFERENCE LEVEL CHAIN 0



OUT-OF-BAND MID CHANNEL CHAIN 0



HIGH CHANNEL 8 BANDEDGE CHAIN 0

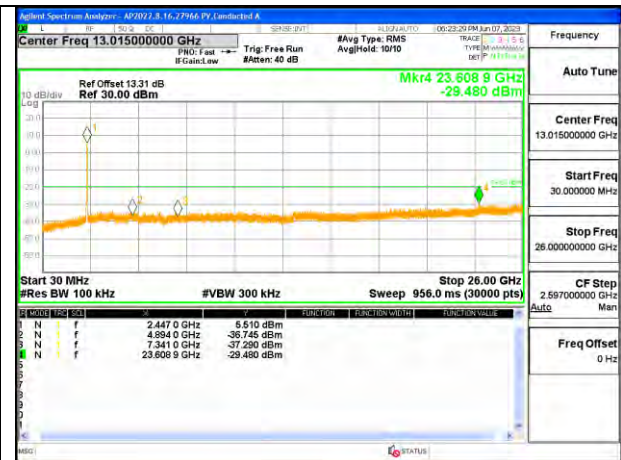

OUT-OF-BAND HIGH CHANNEL 8 CHAIN 0

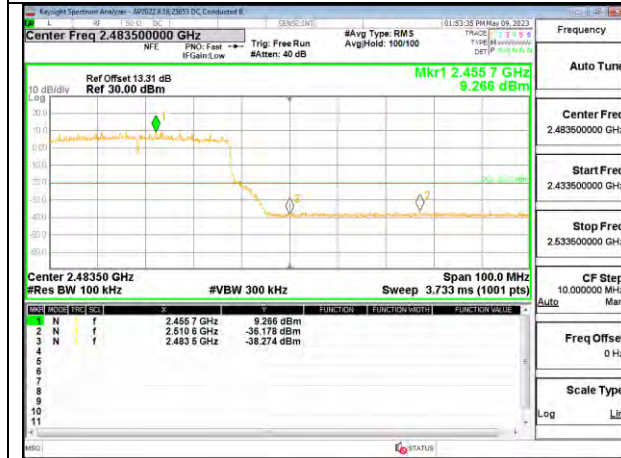

HIGH CHANNEL 9 BANDEDGE CHAIN 0

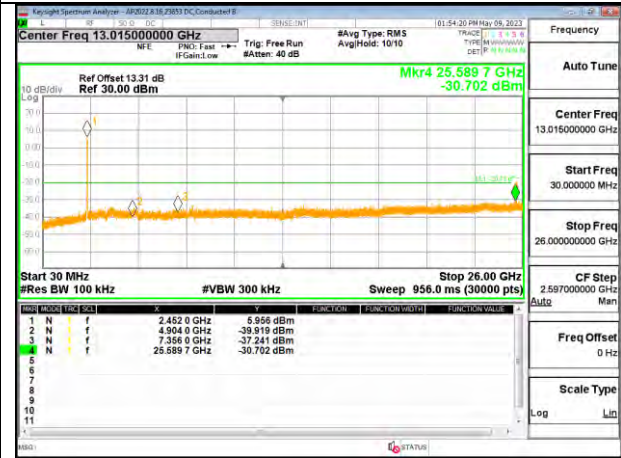

OUT-OF-BAND HIGH CHANNEL 9 CHAIN 0

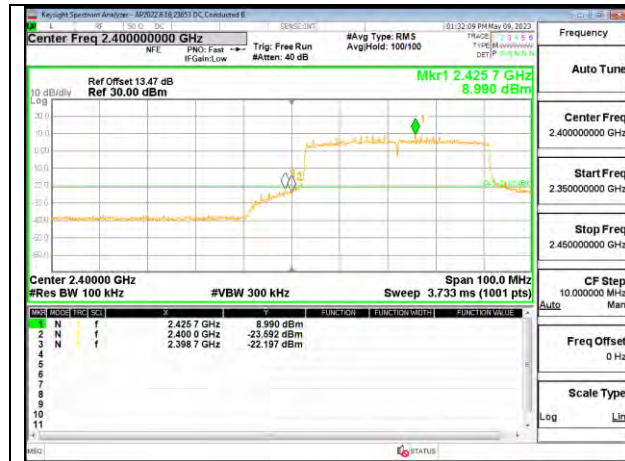

LOW CHANNEL 3 BANDEDGE CHAIN 1



OUT-OF-BAND LOW CHANNEL 3 CHAIN 1



LOW CHANNEL 4 BANDEDGE CHAIN 1



OUT-OF-BAND LOW CHANNEL 4 CHAIN 1

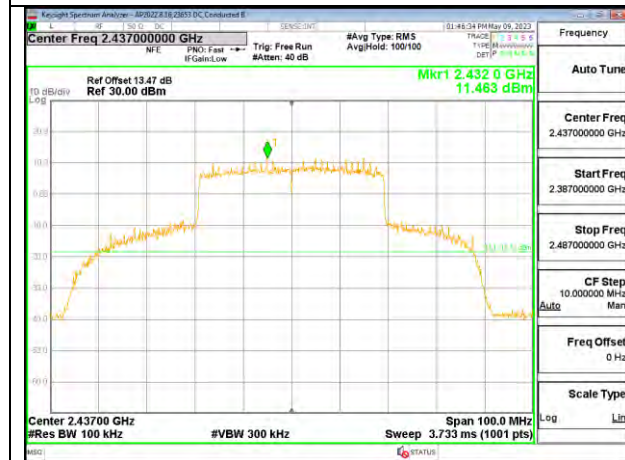

IN-BAND REFERENCE LEVEL CHAIN 1



OUT-OF-BAND MID CHANNEL CHAIN 1



HIGH CHANNEL 8 BANDEDGE CHAIN 1



OUT-OF-BAND HIGH CHANNEL 8 CHAIN 1



HIGH CHANNEL 9 BANDEDGE CHAIN 1



OUT-OF-BAND HIGH CHANNEL 9 CHAIN 1

10. RADIATED TEST RESULTS

LIMITS

FCC §15.205 and §15.209

RSS-GEN, Section 8.9 and 8.10

Frequency Range (MHz)	Field Strength Limit (uV/m) at 3 m	Field Strength Limit (dBuV/m) at 3 m
0.009-0.490	2400/F(kHz) @ 300 m	-
0.490-1.705	24000/F(kHz) @ 30 m	-
1.705 - 30	30 @ 30m	-
30 - 88	100	40
88 - 216	150	43.5
216 - 960	200	46
Above 960	500	54

TEST PROCEDURE

The EUT is placed on a non-conducting table 80 cm above the ground plane for measurement below 1GHz; 1.5 m above the ground plane for measurement above 1GHz. The antenna to EUT distance is 3 meters. The EUT is configured in accordance with ANSI C63.10. The EUT is set to transmit in a continuous mode.

For measurements below 1 GHz the resolution bandwidth is set to 100 kHz for peak detection measurements or 120 kHz for quasi-peak detection measurements in the 30-1000MHz range, 9kHz for peak and/or quasi-peak detection measurements in the 0.15-30MHz range and 200Hz for peak and/or quasi-peak detection measurements in the 9 to 150kHz range. Peak detection is used unless otherwise noted as quasi-peak or average (9-90kHz and 110-490kHz).

For pre-scans above 1 GHz the resolution bandwidth is set to 1 MHz; the video bandwidth is set to 30 KHz for peak measurements.

For final measurements above 1 GHz the resolution bandwidth is set to 1 MHz; the video bandwidth is set to 3 MHz for peak measurements and as applicable for average measurements.

The spectrum from 1 GHz to 18 GHz is investigated with the transmitter set to the lowest, middle, and highest channels in each applicable band. Below 30MHz, below 1GHz and above 18GHz emissions, the channel with the highest output power was tested.

The frequency range of interest is monitored at a fixed antenna height and EUT azimuth. The EUT is rotated through 360 degrees to maximize emissions received. The antenna is scanned from 1 to 4 meters above the ground plane to further maximize the emission. Measurements are made with the antenna polarized in both the vertical and the horizontal positions.

For below 30MHz testing, investigation was done on three antenna orientations (parallel, perpendicular, and ground-parallel), parallel and perpendicular are the worst orientations, therefore testing was performed on these two orientations only. Blue color trace on plots: Parallel orientation. Green color trace on plots: Perpendicular orientation.

Based on FCC 15.31 (f) (2): measurements may be performed at a distance closer than that specified in the regulations; however, an attempt should be made to avoid making measurements in the near field.

KDB 414788 Open Field Site (OFS) and Chamber Correlation Justification

OFS and chamber correlation testing had been performed and chamber measured test result is the worst-case test result.

NOTE: The limits in FCC 47 CFR, Part 15, Subpart C, paragraph 15.209(a), are identical to those in RSS-Gen section 8.9, Table 6, since the measurements are performed in terms of magnetic field strength and converted to electric field strength levels (as reported in the table), using the free space impedance of 377 Ohms. For example, the measurement at frequency X kHz resulted in a level of Y dBuV/m, which is equivalent to $Y - 51.5 = Z$ dBuA/m, which has the same margin, W dB, to the corresponding RSS-Gen Table 6 limit as it has to 15.209(a) limit.

10.1. TRANSMITTER ABOVE 1 GHz

10.1.1. TX ABOVE 1 GHz 802.11ax HE20 MODE IN THE 2.4GHz BAND 1TX Chain 0 OFDMA MODE: 242-Tones, RU Index 61

BANDEDGE (LOW CHANNEL 1)

HORIZONTAL RESULT

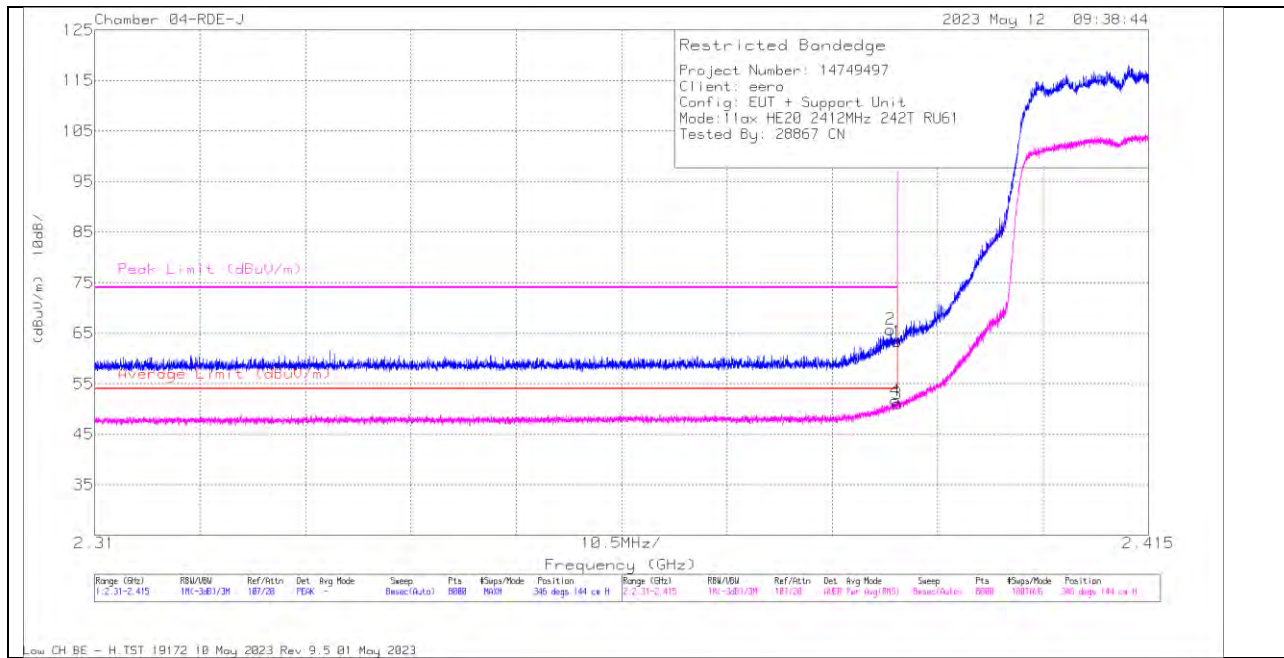

TRACE MARKER

Marker	Frequency (GHz)	Meter Reading (dBuV)	Det	222741 ACF(dB) - 3MHz	Amp/Cb/Pad (dB)	DCCF (dB)	Corrected Reading (dBuV/m)	Average Limit (dBuV/m)	Margin (dB)	Peak Limit (dBuV/m)	PK Margin (dB)	Azimuth (Degs)	Height (cm)	Polarity
1	* 2.39	49.68	Pk	32	-18.4	0	63.28	-	-	74	-10.72	346	144	H
2	* 2.389313	52.15	Pk	32	-18.4	0	65.75	-	-	74	-8.25	346	144	H
3	* 2.39	37.46	RMS	32	-18.4	0.18	51.24	54	-2.94	-	-	346	144	H
4	* 2.389812	38.08	RMS	32	-18.4	0.18	51.86	54	-2.32	-	-	346	144	H

* - indicates frequency in CFR47 Pt 15 / IC RSS-Restricted Band
 Pk - Peak detector
 RMS - RMS detection

VERTICAL RESULT

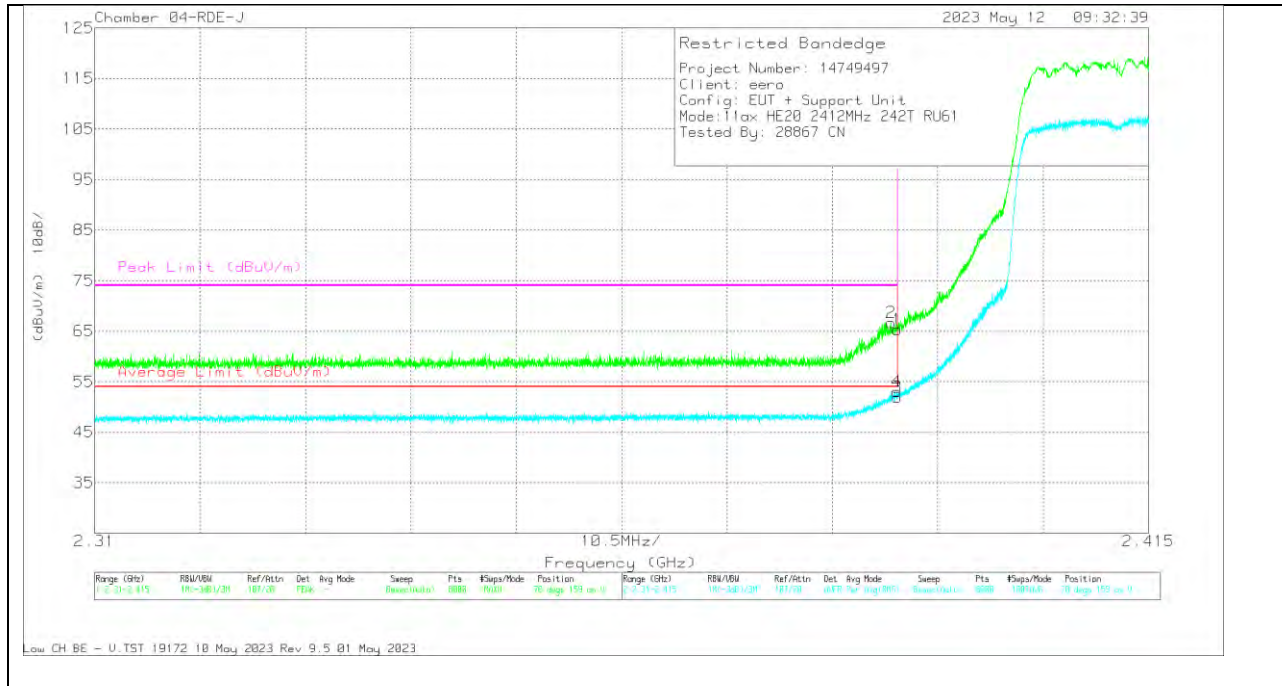

TRACE MARKER

Marker	Frequency (GHz)	Meter Reading (dBuV)	Det	222741 ACF(dB) -3mH	Amp/Cbl/Pad (dB)	DCCF (dB)	Corrected Reading (dBuV/m)	Average Limit (dBuV/m)	Margin (dB)	Peak Limit (dBuV/m)	PK Margin (dB)	Azimuth (Degs)	Height (cm)	Polarity
1	* 2.39	51.76	Pk	32	-18.4	0	65.36	-	-	74	-8.64	70	159	V
2	* 2.389326	53.12	Pk	32	-18.4	0	66.72	-	-	74	-7.28	70	159	V
3	* 2.39	38.33	RMS	32	-18.4	.18	52.11	54	-1.89	-	-	70	159	V
4	* 2.389891	39.4	RMS	32	-18.4	.18	53.18	54	-.82	-	-	70	159	V

* - indicates frequency in CFR47 Pt 15 / IC RSS-Restricted Band
 Pk - Peak detector
 RMS - RMS detection

BANDEDGE (LOW CHANNEL 2)

HORIZONTAL RESULT

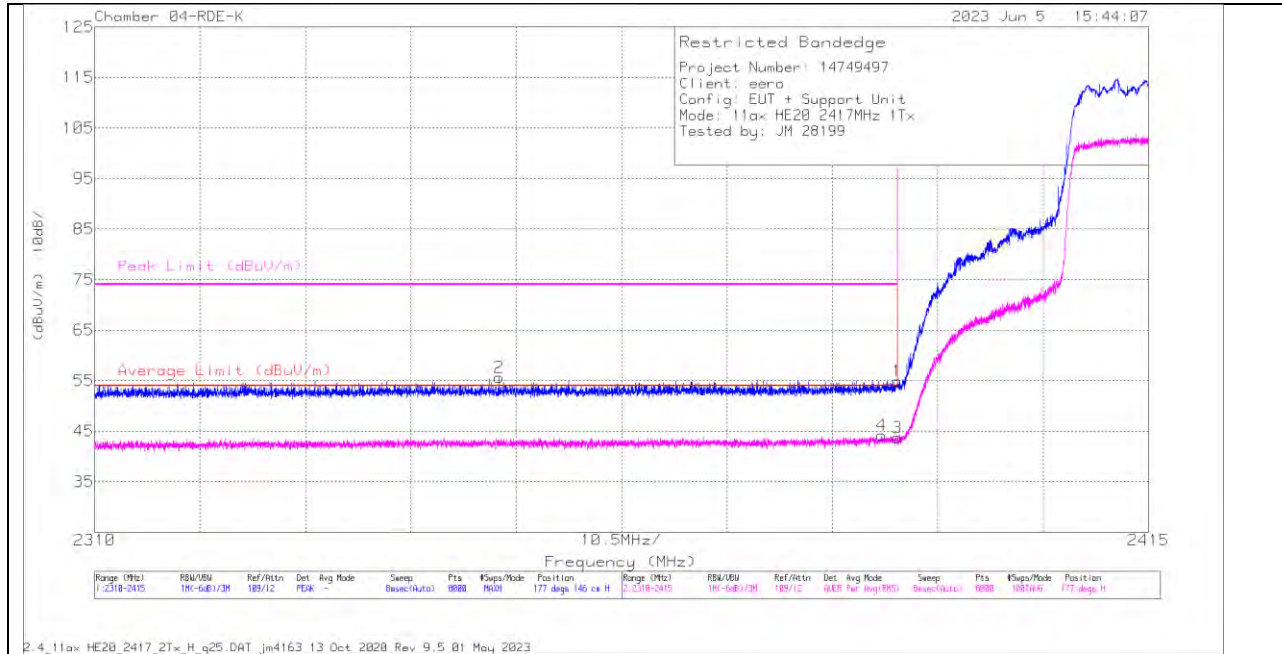

TRACE MARKER

Marker	Frequency (MHz)	Meter Reading (dBuV)	Det	223083 ACF (dB) 3mH	Cbl/Amp (dB)	DCCF (dB)	Corrected Reading (dBuV/m)	Average Limit (dBuV/m)	Margin (dB)	Peak Limit (dBuV/m)	PK Margin (dB)	Azimuth (Degs)	Height (cm)	Polarity
1	* 2390	34.44	Pk	31.8	-11.3	0	54.94	-	-	74	-19.06	177	146	H
2	* 2390.313	35.45	Pk	31.6	-11.4	0	55.65	-	-	74	-18.35	177	146	H
3	* 2390	23.08	RMS	31.8	-11.3	.18	43.76	54	-10.24	-	-	177	146	H
4	* 2388.421	23.52	RMS	31.8	-11.3	.18	44.2	54	-9.8	-	-	177	146	H

* - indicates frequency in CFR47 Pt 15 / IC RSS-Restricted Band
 Pk - Peak detector
 RMS - RMS detection

VERTICAL RESULT

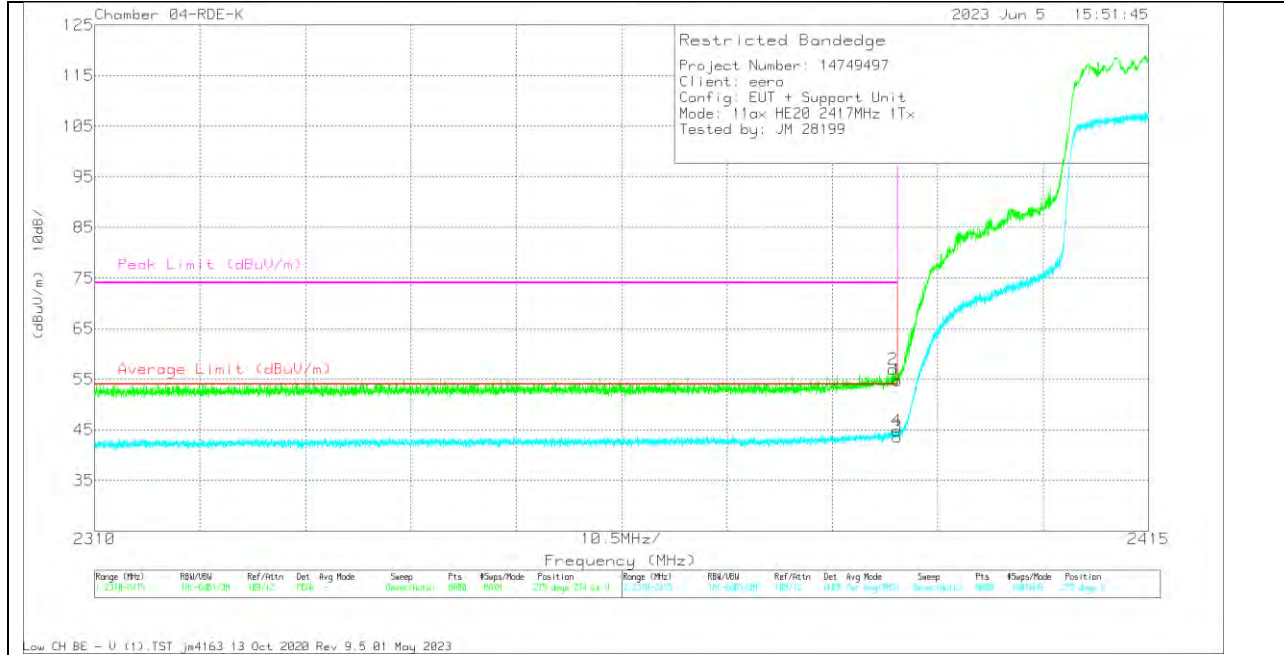

TRACE MARKER

Marker	Frequency (MHz)	Meter Reading (dBuV)	Det	223083 ACF (dB) 3mH	Cbl/Amp (dB)	DCCF (dB)	Corrected Reading (dBuV/m)	Average Limit (dBuV/m)	Margin (dB)	Peak Limit (dBuV/m)	PK Margin (dB)	Azimuth (Degs)	Height (cm)	Polarity
1	* 2390	34.32	Pk	31.8	-11.3	0	54.82	-	-	74	-19.18	275	274	V
2	* 2389.563	36.55	Pk	31.8	-11.3	0	57.05	-	-	74	-16.95	275	274	V
3	* 2390	22.97	RMS	31.8	-11.3	.18	43.65	54	-10.35	-	-	275	274	V
4	* 2389.891	24.15	RMS	31.8	-11.3	.18	44.83	54	-9.17	-	-	275	274	V

* - indicates frequency in CFR47 Pt 15 / IC RSS-Restricted Band
 Pk - Peak detector
 RMS - RMS detection

BANDEDGE (HIGH CHANNEL 11)

HORIZONTAL RESULT

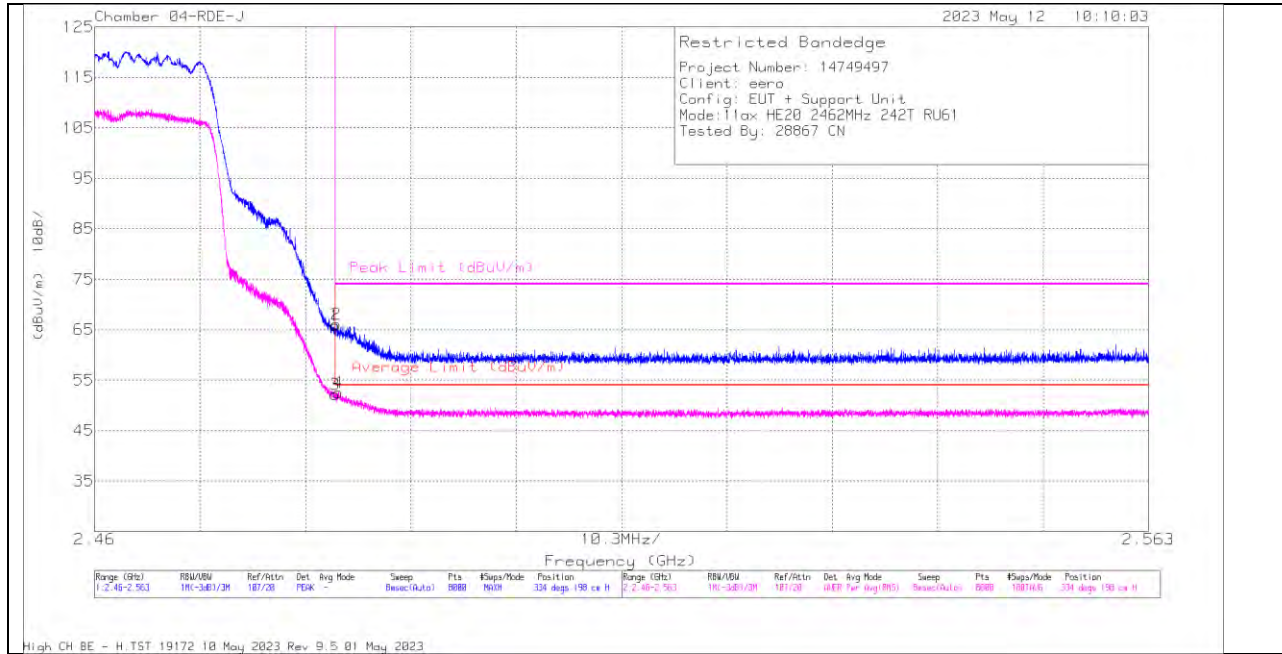

TRACE MARKER

Marker	Frequency (GHz)	Meter Reading (dBuV)	Det	22741 ACF(dB) -3mH	Amp/Cbl/Pad (dB)	DCCF (dB)	Corrected Reading (dBuV/m)	Average Limit (dBuV/m)	Margin (dB)	Peak Limit (dBuV/m)	PK Margin (dB)	Azimuth (Degs)	Height (cm)	Polarity
1	* 2.4835	51.94	Pk	32.2	-18.3	0	65.84	-	-	74	-8.16	334	198	H
2	* 2.483604	52.07	Pk	32.3	-18.3	0	66.07	-	-	74	-7.93	334	198	H
3	* 2.4835	38.26	RMS	32.2	-18.3	.18	52.34	54	-1.66	-	-	334	198	H
4	* 2.48381	38.57	RMS	32.3	-18.3	.18	52.75	54	-1.25	-	-	334	198	H

* - indicates frequency in CFR47 Pt 15 / IC RSS-Restricted Band
 Pk - Peak detector

VERTICAL RESULT

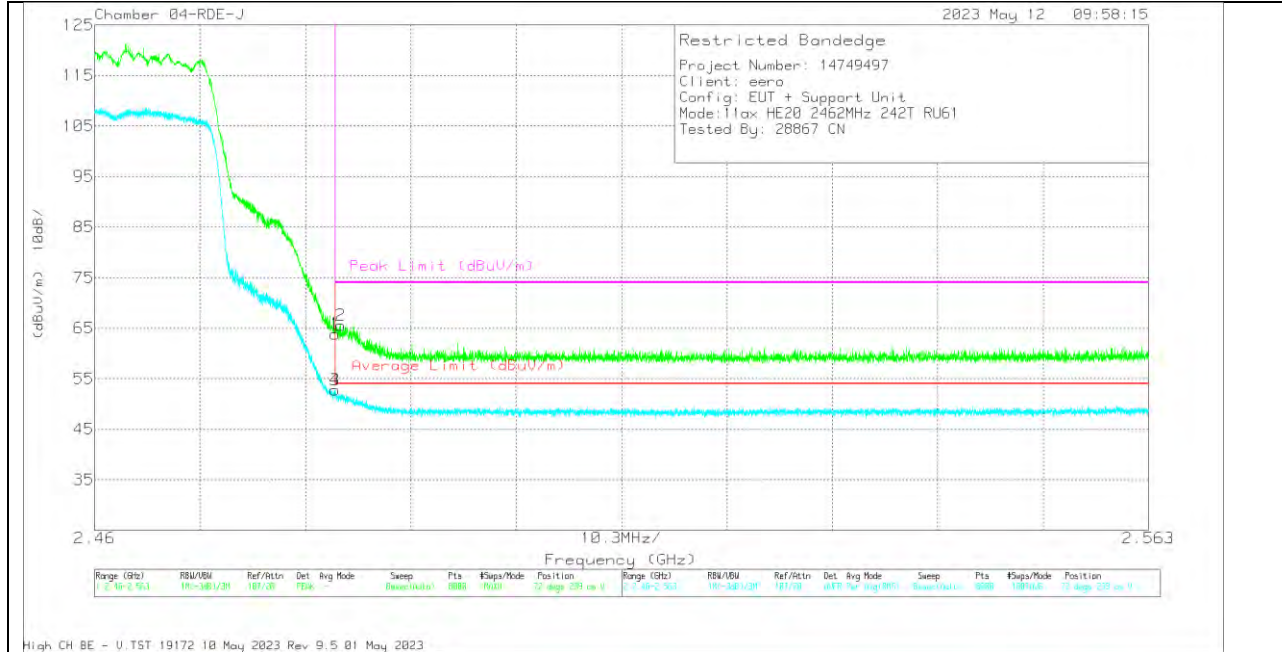

TRACE MARKER

Marker	Frequency (GHz)	Meter Reading (dBuV)	Det	222741 ACF(dB) -3mH	Amp/Cbl/Pad (dB)	DCCF (dB)	Corrected Reading (dBuV/m)	Average Limit (dBuV/m)	Margin (dB)	Peak Limit (dBuV/m)	PK Margin (dB)	Azimuth (Degs)	Height (cm)	Polarity
1	* 2.4835	49.99	Pk	32.2	-18.3	0	63.89	-	-	74	-10.11	72	239	V
2	* 2.484041	51.53	Pk	32.3	-18.3	0	65.53	-	-	74	-8.47	72	239	V
3	* 2.4835	38.85	RMS	32.2	-18.3	.18	52.93	54	-1.07	-	-	72	239	V
4	* 2.483501	38.88	RMS	32.2	-18.3	.18	52.96	54	-1.04	-	-	72	239	V

* - indicates frequency in CFR47 Pt 15 / IC RSS-Restricted Band
 Pk - Peak detector
 RMS - RMS detection