

RF TEST REPORT

FCC / ISED DFS

APPLICANT

eero LLC

MODEL NAME

R010001

FCC ID

2AEM4-41123474

ISED ID

20631-41123474

REPORT NUMBER

HA210810-AER-001-R06

TEST REPORT

Date of Issue
January 18, 2022

Test Site
Hyundai C-Tech, Inc. dba HCT America, Inc.
1726 Ringwood Ave, San Jose, CA 95131, USA

Applicant	eero LLC
Applicant Address	660 3 rd Street, 4 th Floor, San Francisco, CA 94107, USA
FCC ID	2AEM4-41123474
ISED ID	20631-41123474
Model Name	R010001
EUT Type	Wireless Router / Access Point
Modulation Type	OFDM / OFDM-A
FCC Classification	Unlicensed National Information Infrastructure (NII)
FCC Rule Part(s)	Part 15.407
ISED Rule Part(s)	RSS-247 Issue 2 (February 2017) RSS-Gen Issue 5 Amd 2 (February 2021)
Test Procedure	KDB 905462 D02 v02

The device bearing the trade name and model specified above, has been shown to comply with the applicable technical standards as indicated in the measurement report and was tested in accordance with the measurement procedures required. The results of testing in this report apply only to the product which was tested. Other similar equipment will not necessarily produce the same results due to production tolerance and measurement uncertainties.

I attest to the accuracy of data. All measurements reported herein were performed by me or were made under my supervision and are correct to the best of my knowledge and belief. I assume full responsibility for the completeness of these measurements and vouch for the qualifications of all persons taking them.

Hyundai C-Tech, Inc. dba HCT America, Inc. certifies that no party to application has been denied the FCC benefits pursuant to Section 5301 of the Anti-Drug Abuse Act of 1988, 21 U.S.C 862

Tested By



Yongsoo Park

Test Engineer

Reviewed By



Sunwoo Kim

Technical Manager

REVISION HISTORY

The revision history for this document is shown in table.

TEST REPORT NO.	DATE	DESCRIPTION
HA210810-AER-001-R06	01/18/2022	Initial Release

TABLE OF CONTENTS

1. GENERAL INFORMATION	4
2. METHODOLOGY	7
3. INSTRUMENT CALIBRATION	7
4. FACILITIES AND ACCREDITATIONS	8
5. TECHNICAL REQUIREMENT AND PARAMETERS FOR DFS TEST	9
6. RADAR TEST WAVEFORMS	12
7. SUMMARY OF TEST RESULTS	15
8. DYNAMIC FREQUENCY SELECTION	18
8.1 Calibration of Radar Waveform	18
8.2 U-NII Detection Bandwidth	21
8.3 Channel Availability Check Time	27
8.4 In-Service monitoring : Channel Closing Time / Channel Move Time / Non-Occupancy Period	32
8.5 Statistical Performance Check	36
9. LIST OF TEST EQUIPMENT	68
10. LIST OF TEST EQUIPMENT	84
APPENDIX A. TEST SETUP PHOTOS	85
APPENDIX B. PHOTOGRAPHS OF EUT	86

1. GENERAL INFORMATION

EUT DESCRIPTION

Model	R010001
EUT Type	Wireless Router / Access Point
Serial Number	GGC1-UC01-1305-0A1T
Power Supply	5 V d.c. (USB type C - External adaptor)
RF Specification	WIFI 2.4 GHz : 802.11b/g/n(HT20/40)/ ax(HE20/40) WIFI 5 GHz : 802.11a/n(HT20/40)/ ac(VHT20/40/80/160)/ ax(HE20/40/80/160) Bluetooth 5.0 LE (1M) IEEE 802.15.4
Transmitter Chain	WIFI 2.4 GHz / 5 GHz : 2x2 MIMO Bluetooth LE / IEEE 802.15.4 : SISO
Operating Environment	Indoor
Operating Temperature	0 °C ~ +40 °C

RF SPECIFICATION SUBJECT TO THE REPORT

RF Specification	802.11a / 802.11n HT20 / 802.11ac VHT20 / 802.11ax HE20 802.11n HT40 / 802.11ac VHT40 / 802.11ax HE40 802.11ac VHT80 / 802.11ax HE80 802.11ac VHT160 / 802.11ax HE160	
Frequency Range ¹⁾	U-NII 2a	20 MHz BW : 5260 MHz – 5320 MHz 40 MHz BW : 5270 MHz – 5310 MHz 80 MHz BW : 5290 MHz 160 MHz BW : 5250 MHz (Straddle)
	U-NII 2c	20 MHz BW : 5500 MHz – 5720 MHz (Straddle at 5720 MHz) 40 MHz BW : 5510 MHz – 5710 MHz (Straddle at 5710 MHz) 80 MHz BW : 5530 MHz – 5690 MHz (Straddle at 5690 MHz) 160 MHz BW : 5570 MHz
Modulation Type	OFDM / OFDM-A	
Operating Modes	<input checked="" type="checkbox"/> Master	
	<input type="checkbox"/> Mesh	
	<input type="checkbox"/> Slave with radar detection	
	<input type="checkbox"/> Slave without radar detection	
TPC Feature ²⁾	<input checked="" type="checkbox"/> TPC function	<input type="checkbox"/> No TPC function
Uniform spreading	The first operating channel is randomly selected by software control.	
System architecture	IP based	
Antenna Specification ³⁾	Integrated Antenna Peak Gain: 4.36 dBi uncorrelated	
Firmware Version ⁴⁾	eeroOS 6.9	
Hardware Version ⁴⁾	Rev. A	
Date(s) of Tests	October 12 2021 ~ October 22, 2021, November 3, 2021 January 17, 2022	

Note :

1. The frequency range 5600 – 5650 MHz is restricted for Canada.
2. The EUT employs TPC mechanism having the capability to operate at least 6 dB below the highest RF output power.
3. Antenna information is based on the document provided.
4. Firmware and Hardware Version are as received by the client.

ANTENNA CONFIGURATION

The device employs 2x2 MIMO technologies with possible configurations below.

Frequency	Configuration	SDM	CDD
		ANT1 + ANT2	ANT1 + ANT2
2.4 GHz	802.11b	X	O
	802.11g	X	O
	802.11n	O	O
	802.11ax	O	O
5 GHz	802.11a	X	O
	802.11n	O	O
	802.11ac	O	O
	802.11ax	O	O

The equipment under test supports Cyclic Diversity mode.

CDD mode was picked as worst case for testing even though the device support both CDD and SDM

ANTENNA DIRECTIONAL GAIN

Antenna Type	Type	RF Technology	Frequency	Gain (Ant 1)	Gain (Ant 2)
PCB	Dipole	802.11b/g/n/ax	2.4 GHz	3.69 dBi	3.06 dBi
PCB	Dipole	802.11a/n/ac/ax	5 GHz	4.50 dBi	4.22 dBi
Metal	Monopole	BLE / IEEE 802.15.4	2.4 GHz	2.90 dBi	

Ant 1 : 2.4 GHz (Chain 0) / 5 GHz (Chain 1)

Ant 2 : 2.4 GHz (Chain 1) / 5 GHz (Chain 0)

Directional Gain (2.4 GHz : Uncorrelated) = $10 \log\left[\frac{10^{(3.69/10)} + 10^{(3.06/10)}}{2}\right] = 3.39 \text{ dBi}$

Directional Gain (5 GHz : Uncorrelated) = $10 \log\left[\frac{10^{(4.50/10)} + 10^{(4.22/10)}}{2}\right] = 4.36 \text{ dBi}$

Directional Gain (2.4 GHz : Correlated) = $10 \log\left[\frac{10^{(3.69/20)} + 10^{(3.06/20)}}{2}\right]^2 = 6.39 \text{ dBi}$

Directional Gain (5 GHz : Correlated) = $10 \log\left[\frac{10^{(4.50/20)} + 10^{(4.22/20)}}{2}\right]^2 = 7.37 \text{ dBi}$

The device does not support beam foaming.

2. METHODOLOGY

The measurement procedure described in FCC KDB 905462 D02 UNII DFS Compliance Procedures New Rules v02 dated April 8, 2016 entitled "Compliance Measurement Procedure for Unlicensed-National Information Infrastructure Devices Operating in the 5250 – 5350 MHz and 5470 – 5725 MHz Bands incorporating Dynamic Frequency Selection" was used in the measurement.

DESCRIPTION OF TEST MODES

There were two different modes to cover all the requirement of FCC DFS testing. Radar detection mode which overwrites the channel to stay in the same channel even though the radar is detected was used for statistical performance check as well as Detection bandwidth testing. For all other testing, normal mode was used to verify compliance

EUT EXERCISE

The EUT was operated in the engineering mode to fix the Tx frequency that was for the purpose of the measurements. According to its specifications, the EUT must comply with the requirements of the Section 15.407 under the FCC Rules Part 15 Subpart E. / RSS-247 issue 2.

3. INSTRUMENT CALIBRATION

The measuring equipment, which was utilized in performing the tests documented herein, has been calibrated in accordance with the manufacturer's recommendations for utilizing calibration equipment's, which is traceable to recognized national standards. Especially, all antenna for measurement is calibrated in accordance with the requirements of C63.5 (Version : 2017).

4. FACILITIES AND ACCREDITATIONS

FACILITIES

The SAC (Semi-Anechoic Chamber) and conducted measurement facility used to collect the radiated data are located at 1726 Ringwood Avenue, San Jose, California 95131, USA.

The site is constructed in conformance with the requirements of ANSI C63.4. (Version :2014) and CISPR Publication 22.



EQUIPMENT

Radiated emissions are measured with one or more of the following types of Linearly polarized antennas: tuned dipole, bi-conical, log periodic, bi-log, and/or ridged waveguide, horn. Spectrum analyzers with pre-selectors and quasi-peak detectors are used to perform radiated measurements.

Conducted emissions are measured with Line Impedance Stabilization Networks and EMI Test Receivers. Calibrated wideband preamplifiers, coaxial cables, and coaxial attenuators are also used for making measurements.

All receiving equipment conforms to CISPR Publication 16-1, "Radio Interference Measuring Apparatus and Measurement Methods."

5. TECHNICAL REQUIREMENT AND PARAMETERS FOR DFS TEST

5.1. Applicability of DFS Requirements

Table 1 : Applicability of DFS Requirement Prior to Use of a Channel

Requirement	Operational mode		
	Master	Client without Radar Detection	Client with Radar Detection
Non-Occupancy Period	O	Not required	O
DFS Detection Threshold	O	Not required	O
Channel Availability Check Time	O	Not required	Not required
U-NII Detection Bandwidth	O	Not required	O

Table 2 : Applicability of DFS Requirement during Normal Operation

Requirement	Operational mode	
	Master Device or Client with Radar Detection	Client without Radar Detection
Non-Occupancy Period	O	Not required
DFS Detection Threshold	O	Not required
Channel Availability Check Time	O	Not required
U-NII Detection Bandwidth	O	Not required

Additional Requirement for Devices with Multiple Bandwidth Modes	Master Device or Client with Radar Detection	Client without Radar Detection
U-NII Detection Bandwidth	All BW modes must be tested	Not required
Statistical Performance Check	All BW modes must be tested	Not required
Channel Move Time / Channel Closing Transmission Time	Widest BW mode available	Widest BW mode available for the link
All other tests	Any single BW mode	Not required

NOTE : Frequencies selected for statistical performance check (Section 7.8.4) should include several frequencies within the radar detection bandwidth and frequencies near the edge of the radar detection bandwidth. For 802.11 devices it is suggested to select frequencies in each of the bonded 20 MHz channels and the channel center frequency.

5.2. DFS Detection Thresholds

Table 3 : DFS Detection Thresholds for Master Devices and Client Devices with Radar Detection

Maximum Transmit Power	Value (See. Note 1,2, and 3)
EIRP \geq 200 mW	-64 dBm
EIRP < 200 mW and Power Spectral Density < 10 dBm/MHz	-62 dBm
EIRP < 200 mW and Power Spectral Density > 10 dBm/MHz	-64 dBm
<p>Note 1 : This is the level at the input of the receiver assuming a 0 dBi receive antenna.</p> <p>Note 2 : Throughout these test procedures an additional 1 dB has been added to the amplitude of the test transmission waveforms to account for variations in measurement equipment. This will ensure that the test signal is at or above the detection threshold level to trigger a DFS response.</p> <p>Note 3 : EIRP is based on the highest antenna gain. For MIMO devices refer to KDB Publication 662911 D01</p>	

Threshold Level : $(-64 \text{ dBm}) + 4.36 \text{ dBi} + 1 \text{ dB} = -58.64 \text{ dBm}$

5.3. Response Requirement

Table 4 : DFS Response Requirement Values

Parameter	Value
Non-Occupancy Period	> 30 min
Channel Availability Check Time	> 60 sec
Channel Move Time	< 10 sec (See Note 1)
Channel Closing Transmission Time	< 200 ms + aggregate of 60 ms over remaining 10 s period (See Note 1 and 2)
U-NII Detection Bandwidth	> 100 % of U-NII 99 % Tx Power Bandwidth
<p>Note 1 : Channel Move Time and the Channel Closing Transmission Time should be performed with the Radar Type 0. The measurement timing begins at the end of the Radar Type 0 burst.</p> <p>Note 2 : The Channel Closing Transmission Time is comprised of 200 milliseconds starting at the beginning of the Channel Move Time plus any additional intermittent control signals required to facilitate a Channel move (an aggregate of 60 milliseconds) during the remainder of the 10 second period. The aggregate duration of control signals will not count quiet periods in between transmissions.</p> <p>Note 3 : During the U-NII Detection Bandwidth detection test, radar type 0 should be used. For each frequency step the minimum percentage of detection is 90 percent. Measurements are performed with no data traffic.</p>	

6. RADAR TEST WAVEFORMS

6.1. Short Pulse Radar Test Waveforms

Table 5 : Short Pulse Radar Test Waveforms

Radar Type	Pulse Width (us)	PRI (us)	No of Pulses	Minimum % of Successful Detection	Minimum Number of Trials
0	1	1428	18	See Note 1	See Note 1
1	1	TEST A (See Note 2) TEST B (See Note 3)	Roundup $\left\{ \left(\frac{1}{360} \right), \left(\frac{19 \cdot 10^6}{PRI_{\mu sec}} \right) \right\}$	60 %	30
2	1 – 5	150 – 230	23 – 29	60 %	30
3	6 – 10	200 – 500	16 – 18	60 %	30
4	11 – 20	200 – 500	12 – 16	60 %	30
Aggregate (Radar Type 1 – 4)				80 %	120
Note 1 : Short Pulse Radar Type 0 should be used for the detection bandwidth test, channel move time, and channel closing time tests.					
Note 2 : TEST A : 15 unique PRI values randomly selected from the list of 23 PRI in Table 5a					
Note 3 : TEST B : 15 unique PRI values randomly selected with the range of 519 – 3066 us with a minimum increment of 1 us, excluding PRI values selected in TEST A					

A minimum of 30 unique waveforms are required for each of the Short Pulse Radar Types 2 through 4. If more than 30 waveforms are used for Short Pulse Radar Types 2 through 4, then each additional waveform must also be unique and not repeated from the previous waveforms. If more than 30 waveforms are used for Short Pulse Radar Type 1, then each additional waveform is generated with Test B and must also be unique and not repeated from the previous waveforms in Tests A or B.

Table 5a : Pulse Repetition Interval Values for TEST A

PRF Number	PRF (Pulse/Sec)	PRI (us)	PRF Number	PRF (Pulse/Sec)	PRI (us)
1	1930.5	518	13	1319.3	758
2	1858.7	538	14	1285.3	778
3	1792.1	558	15	1253.1	798
4	1730.1	578	16	1222.5	818
5	1672.2	598	17	1193.3	838
6	1618.1	618	18	1165.6	858
7	1567.4	638	19	1139	878
8	1519.8	658	20	1113.6	898
9	1474.9	678	21	1089.3	918
10	1432.7	698	22	1066.1	938
11	1392.8	718	23	326.2	3066
12	1355	738			

6.2. Long Pulse Radar Test Waveforms

Table 6 : Long Pulse Radar Test Waveform

Radar Type	Pulse Width (us)	Chirp Width (MHz)	PRI (us)	Number of Pulses	Number of Bursts	Minimum % of Successful Detection	Minimum Number of Trials
5	50 – 100	5 – 20	1000 – 2000	1 – 3	8 – 20	80 %	30

The parameters for this waveform are randomly chosen. Thirty unique waveforms are required for the Long Pulse Radar Type waveforms. If more than 30 waveforms are used for the Long Pulse Radar Type waveforms, then each additional waveform must also be unique and not repeated from the previous waveforms.

Each waveform is defined as follows:

- 1) The transmission period for the Long Pulse Radar test signal is 12 seconds.
- 2) There are total of 8 to 20 Bursts in the 12 second period, with the number of Bursts being randomly chosen. This number is Burst Count.
- 3) Each Burst consists of 1 to 3 pulses, with the number of pulses being randomly chosen. Each Burst within the 12 second sequence may have a different number of pulses.
- 4) The pulse width is between 50 and 100 microseconds, with the pulse width being randomly chosen. Each pulse within a Burst will have the same pulse width. Pulses in different Bursts may have different pulse widths.
- 5) Each pulse has a linear frequency modulated chirp between 5 and 20 MHz, with the chirp width being randomly chosen. Each pulse within a transmission period will have the same chirp width. The chirp is centered on the pulse. For example, with a radar frequency of 5300 MHz and a 20 MHz chirped signal, the chirp starts at 5290 MHz and ends at 5310 MHz.
- 6) If more than one pulse is present in a Burst, the time between the pulses will be between 1000 and 2000 microseconds, with the time being randomly chosen. If three pulses are present in a Burst, the random time interval between the first and second pulses is chosen independently of the random time interval between the second and third pulses.
- 7) The 12 second transmission period is divided into even intervals. The number of intervals is equal to Burst Count. Each interval is of length $(12,000,000 / \text{Burst Count})$ microseconds. Each interval contains one Burst. The start time for the Burst, relative to the beginning of the interval, is between 1 and $[(12,000,000 / \text{Burst Count}) - (\text{Total Burst Length}) + (\text{One Random PRI Interval})]$ microseconds, with the start time being randomly chosen. The step interval for the start time is 1 microsecond. The start time for each Burst is chosen randomly.

Representative Example of Radar Waveform :

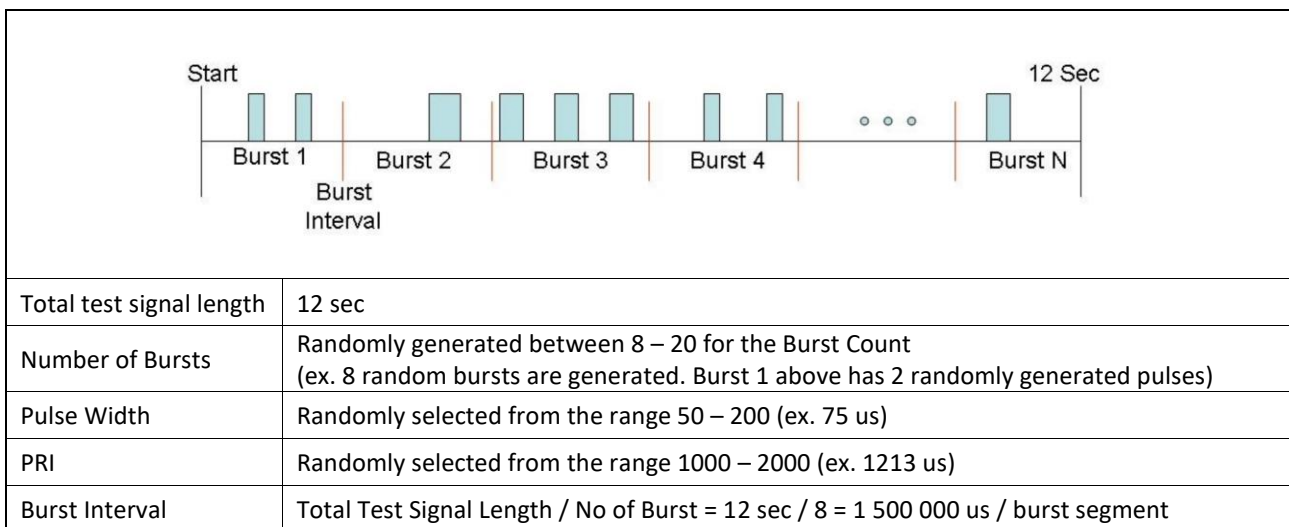

6.3. Frequency Hopping Radar Test Waveform

Table 7 : Frequency Radar Test Waveform

Radar Type	Pulse Width (us)	PRI (us)	Pulses Per Hop	Hopping Rate (kHz)	Hopping Sequence Length (ms)	Minimum % of Successful Detection	Minimum Number of Trials
6	1	333	9	0.333	300	70 %	30

For the Frequency Hopping Radar Type, the same Burst parameters are used for each waveform. The hopping sequence is different for each waveform and a 100-length segment is selected from the hopping sequence defined by the following algorithm:

The first frequency in a hopping sequence is selected randomly from the group of 475 integer frequencies from 5250 – 5724 MHz. Next, the frequency that was just chosen is removed from the group and a frequency is randomly selected from the remaining 474 frequencies in the group. This process continues until all 475 frequencies are chosen for the set. For selection of a random frequency, the frequencies remaining within the group are always treated as equally likely.

7. SUMMARY OF TEST RESULTS

DFS Summary

Response Requirement	Limit	Result
U-NII Detection Bandwidth	> 100 % of U-NII 99 % Tx Power BW	Compliant
Channel Availability Check Time	> 60 sec	Compliant
Channel Move Time	< 10 sec	Compliant
Channel Closing Transmission Time	< 200 ms + aggregate of 60 ms over remaining 10 s period	Compliant
Non-Occupancy Period	> 30 mins	Compliant

Statistical Performance Check : 802.11ax HE20 (5500 MHz)					
Radar Type	No of Trial	No of Successful Detection	Detection Rate (%)	Limit (%)	Result
1	30	29	96.7%	60.0%	Compliant
2	30	30	100.0%	60.0%	Compliant
3	30	30	100.0%	60.0%	Compliant
4	30	30	100.0%	60.0%	Compliant
Aggregate (Radar Type 1 – 4)			99.2%	80.0%	Compliant
5	30	30	100.0%	80.0%	Compliant
6	30	29	96.7%	70.0%	Compliant

Statistical Performance Check : 802.11ax HE40 (5510 MHz)					
Radar Type	No of Trial	No of Successful Detection	Detection Rate (%)	Limit (%)	Result
1	30	30	100.0%	60.0%	Compliant
2	30	30	100.0%	60.0%	Compliant
3	30	27	90.0%	60.0%	Compliant
4	30	30	100.0%	60.0%	Compliant
Aggregate (Radar Type 1 – 4)			97.5%	80.0%	Compliant
5	30	30	100.0%	80.0%	Compliant
6	30	30	100.0%	70.0%	Compliant

Statistical Performance Check : 802.11ax HE80 (5530 MHz)					
Radar Type	No of Trial	No of Successful Detection	Detection Rate (%)	Limit (%)	Result
1	30	30	100.0%	60.0%	Compliant
2	30	29	96.7%	60.0%	Compliant
3	30	29	96.7%	60.0%	Compliant
4	30	30	100.0%	60.0%	Compliant
Aggregate (Radar Type 1 – 4)			98.3%	80.0%	Compliant
5	30	30	100.0%	80.0%	Compliant
6	30	30	100.0%	70.0%	Compliant

Statistical Performance Check : 802.11ax HE160 (5570 MHz)					
Radar Type	No of Trial	No of Successful Detection	Detection Rate (%)	Limit (%)	Result
1	30	29	96.7%	60.0%	Compliant
2	30	29	96.7%	60.0%	Compliant
3	30	26	86.7%	60.0%	Compliant
4	30	28	93.3%	60.0%	Compliant
Aggregate (Radar Type 1 – 4)			93.3%	80.0%	Compliant
5	30	30	100.0%	80.0%	Compliant
6	30	30	100.0%	70.0%	Compliant

Statistical Performance Check : 802.11ax HE160 (5250 MHz)					
Radar Type	No of Trial	No of Successful Detection	Detection Rate (%)	Limit (%)	Result
1	30	29	96.7%	60.0%	Compliant
2	30	28	93.3%	60.0%	Compliant
3	30	27	90.0%	60.0%	Compliant
4	30	29	96.7%	60.0%	Compliant
Aggregate (Radar Type 1 – 4)			94.2%	80.0%	Compliant
5	30	30	100.0%	80.0%	Compliant
6	30	30	100.0%	70.0%	Compliant

Note:

1. 5250 MHz was selected for Canada.

8. DYNAMIC FREQUENCY SELECTION

8.1 Calibration of Radar Waveform

8.1.1 Radar Waveform Calibration Procedure

Conducted test setup where Client with injection at the Master

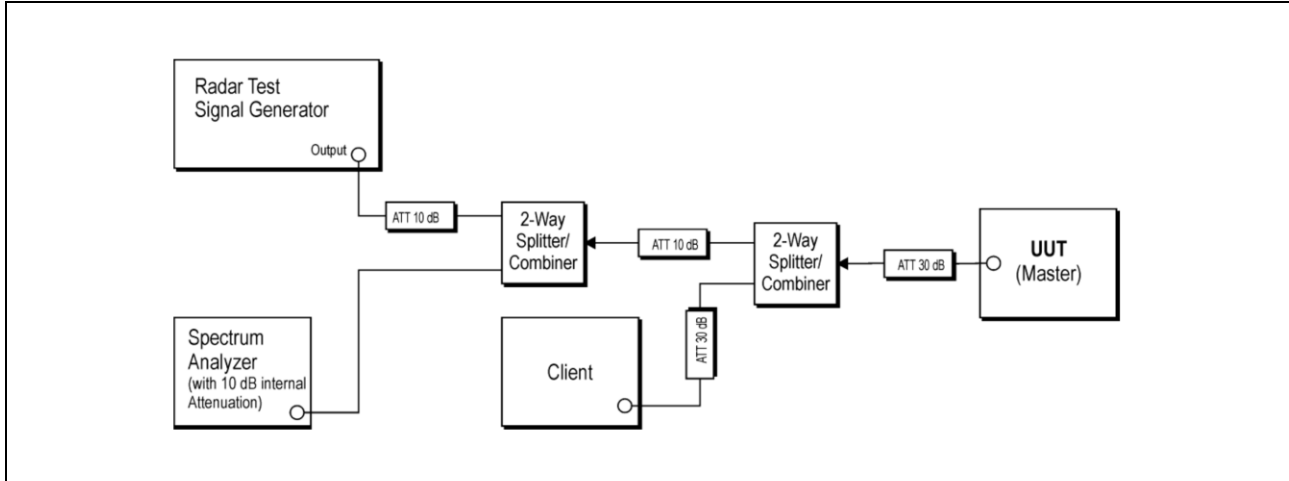

8.1.2 Radar Detection Threshold Level

Detection Threshold = $-64 + G \text{ (dBi)} + 1 = -58.64 \text{ dBm}$

Insertion loss of the cables and dividers connected between VSG and SA : 14.63 dB

Insertion loss of the cables and dividers connected between the EUT RF input port and VSG : 49.64 dB.

The DUT input level from the vector signal generator was adjusted to be able to have the same detection threshold level at the antenna port properly.

8.1.3 Channel Loading

17% of channel loading is applied for all DFS test items except for U-NII Detection Bandwidth test using iperf3 and the power sensor was used to get duty cycle of the burst.

TEST PLOTS

Radar Waveforms Type 1 – 6 (CH 114 : 5570 MHz)

Type 1

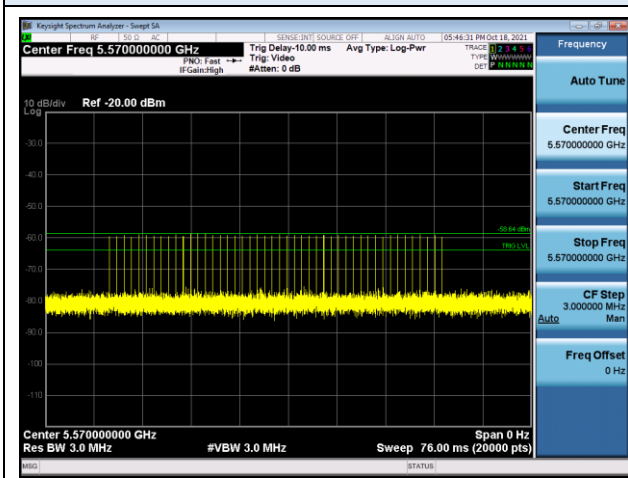

Type 2

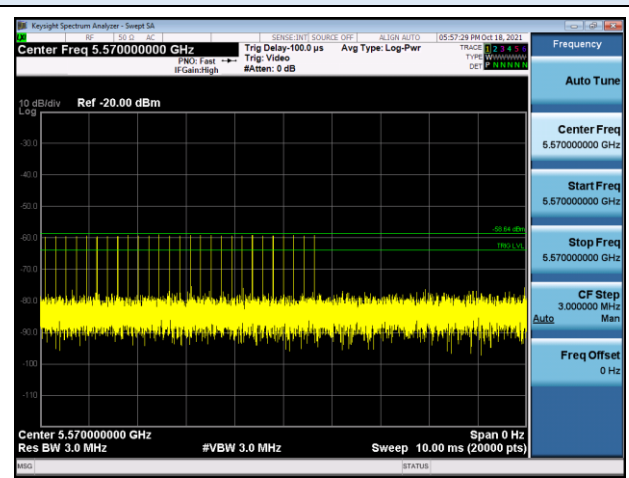

Type 3

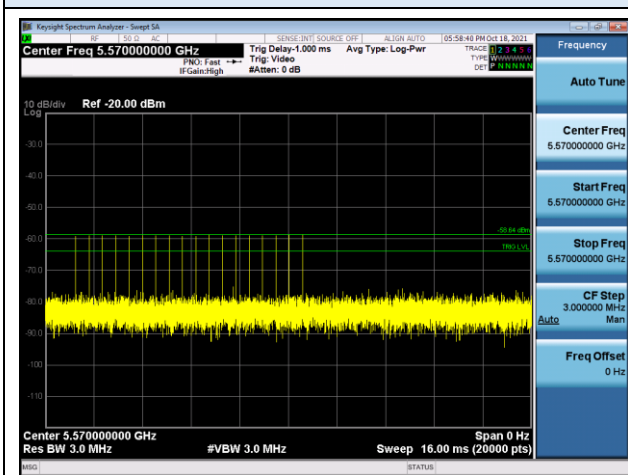

Type 4

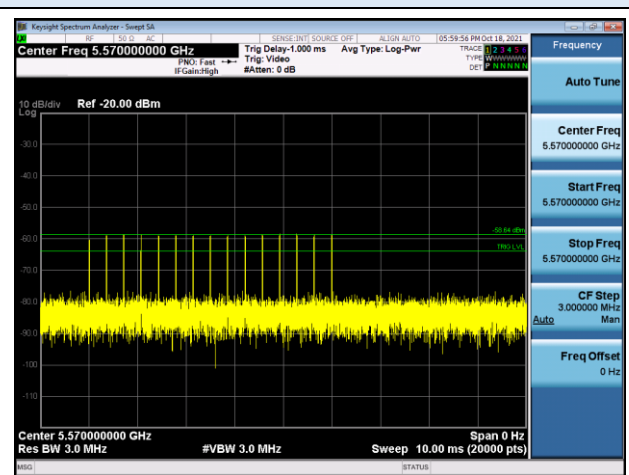

Type 5 (Single Burst)

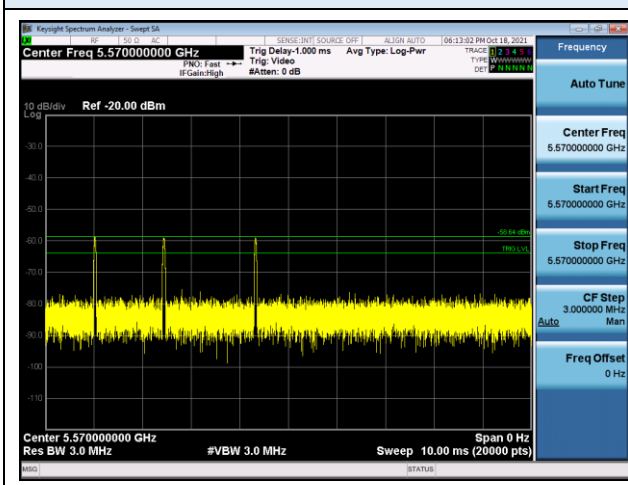

Type 6 (Single Burst)

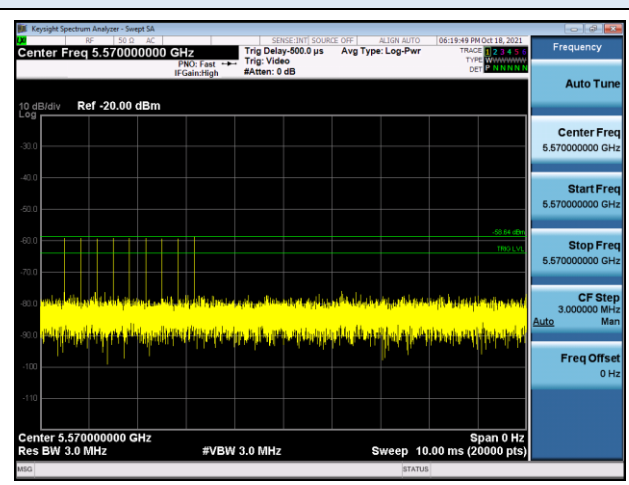

Note :

The radar waveforms only at the representative frequency (5570 MHz) are included in this test report.

TEST PLOTS



8.2 U-NII Detection Bandwidth

8.2.1 Limit

The U-NII Detection Bandwidth shall be greater than or equal to the U-NII 99% transmission bandwidth according to table 4, section 5.3, KDB 905462 D02 v02 (April 8, 2016). Otherwise, the UUT does not comply with DFS requirements.

This is essential to ensure that the UUT is capable of detecting Radar Waveforms across the same frequency spectrum that contains the significant energy from the system.

8.2.2 Test Procedure

Adjust the equipment to produce a single Burst of any one of the Short Pulse Radar Types 0 at the center frequency of the UUT Operating Channel at the specified DFS Detection Threshold level.

Set the UUT up as a standalone device (no associated Client or Master, as appropriate) and no traffic. Frame based systems will be set to a talk/listen ratio reflecting the worst case (maximum) that is user configurable during this test.

Generate a single radar burst and note the response of the UUT. Repeat for a minimum of 10 trials. The UUT must detect the Radar Waveform within the DFS band using the specified U-NII Detection Bandwidth criterion shown in Table 4.

In cases where the channel bandwidth may exceed past the DFS band edge on specific channels (i.e., 802.11ac or wideband frame-based systems) select a channel that has the entire emission bandwidth within the DFS band. If this is not possible, test the detection BW to the DFS band edge.

Starting at the center frequency of the UUT operating Channel, increase the radar frequency in 5 MHz steps, repeating the above test sequence, until the detection rate falls below the U-NII Detection Bandwidth criterion specified in Table 4. Repeat this measurement in 1MHz steps at frequencies 5 MHz below where the detection rate begins to fall. Record the highest frequency (denote as F_H) at which detection is greater than or equal to the U-NII Detection Bandwidth criterion. Recording the detection rate at frequencies above F_H is not required to demonstrate compliance.

Starting at the center frequency of the UUT operating Channel, decrease the radar frequency in 5 MHz steps, repeating the above test sequence, until the detection rate falls below the U-NII Detection Bandwidth criterion specified in Table 4. Repeat this measurement in 1MHz steps at frequencies 5 MHz above where the detection rate begins to fall. Record the lowest frequency (denote as F_L) at which detection is greater than or equal to the U-NII Detection Bandwidth criterion. Recording the detection rate at frequencies below F_L is not required to demonstrate compliance.

The U-NII Detection Bandwidth is calculated as follows:

$$U\text{-NII Detection Bandwidth} = F_H - F_L$$

8.2.3 Test Result

Test Frequency 5500 MHz (CH 100)
 Mode 802.11ax HE20

Radar Frequency (MHz)	Number of Trial (Detected = O, Not Detected = -)										Detection Rate (%)
	1	2	3	4	5	6	7	8	9	10	
5489	-	-	-	-	-	-	-	-	-	-	0 %
5490	O	O	O	O	O	O	O	O	O	O	100 %
5491	O	O	O	O	O	O	O	O	O	O	100 %
5492	O	O	O	O	O	O	O	O	O	O	100 %
5493	O	O	O	O	O	O	O	O	O	O	100 %
5494	O	O	O	O	O	O	O	O	O	O	100 %
5495	O	O	O	O	O	O	O	O	O	O	100 %
5500	O	O	O	O	O	O	O	O	O	O	100 %
5505	O	O	O	O	O	O	O	O	O	O	100 %
5506	O	O	O	O	O	O	O	O	O	O	100 %
5507	O	O	O	O	O	O	O	O	O	O	100 %
5508	O	O	O	O	O	O	O	O	O	O	100 %
5509	O	O	O	O	O	O	O	O	O	O	100 %
5510	O	O	O	O	O	O	O	O	O	O	100 %
5511	-	-	-	-	-	-	-	-	-	-	0 %
Detection Bandwidth = $F_H - F_L = 5510 - 5490 = 20$ MHz											
EUT 99% Bandwidth = 19.14 MHz											
Result : Compliant											

Test Frequency 5510 MHz (CH 102)
 Mode 802.11ax HE40

Radar Frequency (MHz)	Number of Trial (Detected = O, Not Detected = -)										Detection Rate (%)
	1	2	3	4	5	6	7	8	9	10	
5489	-	-	-	-	-	-	-	-	-	-	0 %
5490	O	O	O	O	O	O	O	O	O	O	100 %
5491	O	O	O	O	O	O	O	O	O	O	100 %
5492	O	O	O	O	O	O	O	O	O	O	100 %
5493	O	O	O	O	O	O	O	O	O	O	100 %
5494	O	O	O	O	O	O	O	O	O	O	100 %
5495	O	O	O	O	O	O	O	O	O	O	100 %
5500	O	O	O	O	O	O	O	O	O	O	100 %
5505	O	O	O	O	O	O	O	O	O	O	100 %
5510	O	O	O	O	O	O	O	O	O	O	100 %
5515	O	O	O	O	O	O	O	O	O	O	100 %
5520	O	O	O	O	O	O	O	O	O	O	100 %
5525	O	O	O	O	O	O	O	O	O	O	100 %
5526	O	O	O	O	O	O	O	O	O	O	100 %
5527	O	O	O	O	O	O	O	O	O	O	100 %
5528	O	O	O	O	O	O	O	O	O	O	100 %
5529	O	O	O	O	O	O	O	O	O	O	100 %
5530	O	O	O	O	O	O	O	O	O	O	100 %
5531	-	-	-	-	-	-	-	-	-	-	0 %
Detection Bandwidth = $F_H - F_L = 5530 - 5490 = 40$ MHz											
EUT 99% Bandwidth = 37.65 MHz											
Result : Compliant											

Test Frequency 5530 MHz (CH 106)
 Mode 802.11ax HE80

Radar Frequency (MHz)	Number of Trial (Detected = 0, Not Detected = -)										Detection Rate (%)
	1	2	3	4	5	6	7	8	9	10	
5489	-	-	-	-	-	-	-	-	-	-	0 %
5490	0	0	0	0	0	0	0	0	0	0	100 %
5491	0	0	0	0	0	0	0	0	0	0	100 %
5492	0	0	0	0	0	0	0	0	0	0	100 %
5493	0	0	0	0	0	0	0	0	0	0	100 %
5494	0	0	0	0	0	0	0	0	0	0	100 %
5495	0	0	0	0	0	0	0	0	0	0	100 %
5500	0	0	0	0	0	0	0	0	0	0	100 %
5505	0	0	0	0	0	0	0	0	0	0	100 %
5510	0	0	0	0	0	0	0	0	0	0	100 %
5515	0	0	0	0	0	0	0	0	0	0	100 %
5520	0	0	0	0	0	0	0	0	0	0	100 %
5525	0	0	0	0	0	0	0	0	0	0	100 %
5530	0	0	0	0	0	0	0	0	0	0	100 %
5535	0	0	0	0	0	0	0	0	0	0	100 %
5540	0	0	0	0	0	0	0	0	0	0	100 %
5545	0	0	0	0	0	0	0	0	0	0	100 %
5550	0	0	0	0	0	0	0	0	0	0	100 %
5555	0	0	0	0	0	0	0	0	0	0	100 %
5560	0	0	0	0	0	0	0	0	0	0	100 %
5565	0	0	0	0	0	0	0	0	0	0	100 %
5566	0	0	0	0	0	0	0	0	0	0	100 %
5567	0	0	0	0	0	0	0	0	0	0	100 %
5568	0	0	0	0	0	0	0	0	0	0	100 %
5569	0	0	0	0	0	0	0	0	0	0	100 %
5570	0	0	0	0	0	0	0	0	0	0	100 %
5571	-	-	-	-	-	-	-	-	-	-	0 %
Detection Bandwidth = $F_H - F_L = 5570 - 5490 = 80$ MHz											
EUT 99% Bandwidth = 76.83 MHz											
Result : Compliant											

Test Frequency 5570 MHz (CH 114)
 Mode 802.11ax HE160

Radar Frequency (MHz)	Number of Trial (Detected = O, Not Detected = -)										Detection Rate (%)
	1	2	3	4	5	6	7	8	9	10	
5489	-	-	-	-	-	-	-	-	-	-	0 %
5490	O	O	O	O	O	O	O	O	O	O	100 %
5491	O	O	O	O	O	O	O	O	O	O	100 %
5492	O	O	O	O	O	O	O	O	O	O	100 %
5493	O	O	O	O	O	O	O	O	O	O	100 %
5495	O	O	O	O	O	O	O	O	O	O	100 %
5500	O	O	O	O	O	O	O	O	O	O	100 %
5505	O	O	O	O	O	O	O	O	O	O	100 %
5510	O	O	O	O	O	O	O	O	O	O	100 %
5515	O	O	O	O	O	O	O	O	O	O	100 %
5520	O	O	O	O	O	O	O	O	O	O	100 %
5525	O	O	O	O	O	O	O	O	O	O	100 %
5530	O	O	O	O	O	O	O	O	O	O	100 %
5535	O	O	O	O	O	O	O	O	O	O	100 %
5540	O	O	O	O	O	O	O	O	O	O	100 %
5545	O	O	O	O	O	O	O	O	O	O	100 %
5550	O	O	O	O	O	O	O	O	O	O	100 %
5555	O	O	O	O	O	O	O	O	O	O	100 %
5560	O	O	O	O	O	O	O	O	O	O	100 %
5565	O	O	O	O	O	O	O	O	O	O	100 %
5570	O	O	O	O	O	O	O	O	O	O	100 %
5575	O	O	O	O	O	O	O	O	O	O	100 %
5580	O	O	O	O	O	O	O	O	O	O	100 %
5585	O	O	O	O	O	O	O	O	O	O	100 %
5590	O	O	O	O	O	O	O	O	O	O	100 %
5595	O	O	O	O	O	O	O	O	O	O	100 %
5600	O	O	O	O	O	O	O	O	O	O	100 %
5605	O	O	O	O	O	O	O	O	O	O	100 %
5610	O	O	O	O	O	O	O	O	O	O	100 %
5615	O	O	O	O	O	O	O	O	O	O	100 %
5620	O	O	O	O	O	O	O	O	O	O	100 %
5625	O	O	O	O	O	O	O	O	O	O	100 %
5630	O	O	O	O	O	O	O	O	O	O	100 %
5635	O	O	O	O	O	O	O	O	O	O	100 %
5640	O	O	O	O	O	O	O	O	O	O	100 %
5645	O	O	O	O	O	O	O	O	O	O	100 %
5646	O	O	O	O	O	O	O	O	O	O	100 %
5647	O	O	O	O	O	O	O	O	O	O	100 %
5648	O	O	O	O	O	O	O	O	O	O	100 %
5649	O	O	O	O	O	O	O	O	O	O	100 %
5650	O	O	O	O	O	O	O	O	O	O	100 %
5651	-	-	-	-	-	-	-	-	-	-	0 %
Detection Bandwidth = $F_H - F_L = 5650 - 5490 = 160$ MHz											
EUT 99% Bandwidth = 156.83 MHz											
Result : Compliant											

Test Frequency 5250 MHz (CH 50)
 Mode 802.11ax HE160

Radar Frequency (MHz)	Number of Trial (Detected = O, Not Detected = -)										Detection Rate (%)
	1	2	3	4	5	6	7	8	9	10	
5249	-	-	-	-	-	-	-	-	-	-	0 %
5250	O	O	O	O	O	O	O	O	O	O	100 %
5255	O	O	O	O	O	O	O	O	O	O	100 %
5260	O	O	O	O	O	O	O	O	O	O	100 %
5265	O	O	O	O	O	O	O	O	O	O	100 %
5270	O	O	O	O	O	O	O	O	O	O	100 %
5275	O	O	O	O	O	O	O	O	O	O	100 %
5280	O	O	O	O	O	O	O	O	O	O	100 %
5285	O	O	O	O	O	O	O	O	O	O	100 %
5290	O	O	O	O	O	O	O	O	O	O	100 %
5295	O	O	O	O	O	O	O	O	O	O	100 %
5300	O	O	O	O	O	O	O	O	O	O	100 %
5305	O	O	O	O	O	O	O	O	O	O	100 %
5310	O	O	O	O	O	O	O	O	O	O	100 %
5315	O	O	O	O	O	O	O	O	O	O	100 %
5320	O	O	O	O	O	O	O	O	O	O	100 %
5325	O	O	O	O	O	O	O	O	O	O	100 %
5326	O	O	O	O	O	O	O	O	O	O	100 %
5327	O	O	O	O	O	O	O	O	O	O	100 %
5328	O	O	O	O	O	O	O	O	O	O	100 %
5329	O	O	O	O	O	O	O	O	O	O	100 %
5330	O	O	O	O	O	O	O	O	O	O	100 %
5331	-	-	-	-	-	-	-	-	-	-	0 %
Detection Bandwidth = $F_H - F_L = 5530 - 5250 = 80$ MHz											
EUT 99% Bandwidth (U-NII 2a) = 77.40 MHz											
Result : Compliant											

8.3 Channel Availability Check Time

8.3.1 Limit

According to 7.8.2.1, KDB 905462 D02 v02, the Initial Channel Availability Check Time tests that the UUT does not emit beacon, control, or data signals on the test channel until the power-up sequence has been complete and the U-NII device checks for radar waveforms for 1 minute (60 seconds) on the test channel.

8.3.2 Initial Channel Availability Check Time

- 1) The U-NII devices will be powered on and be instructed to operate on the appropriate U-NII Channel that must incorporate DFS functions. At the same time the UUT is powered on, the spectrum analyzer will be set to zero span mode with a 3 MHz RBW and 3 MHz VBW on the Channel occupied by the radar (Ch_r) with a 2.5 minute (150 seconds) sweep time. The spectrum analyzer's sweep will be started at the same time power is applied to the U-NII device.
- 2) The UUT should not transmit any beacon or data transmissions until at least 1 minute after the completion of the power-on cycle.
- 3) Confirm that the UUT initiates transmission on the channel.

This measurement can be used to determine the length of the power-on cycle if it is not supplied by the manufacturer. If the spectrum analyzer sweep is started at the same time the UUT is powered on and the UUT does not begin transmissions until it has completed the cycle, the power-on time can be determined by comparing the two times.

8.3.3 Radar Burst at the Beginning of Channel Availability Check Time

The steps below define the procedure to verify successful radar detection on the test Channel during a period equal to the Channel Availability Check Time and avoidance of operation on that Channel when a radar Burst with a level equal to the DFS Detection Threshold + 1 dB occurs at the beginning of the Channel Availability Check Time as illustrated in the figure below.

- 1) The Radar Waveform generator and UUT are connected using the applicable test setup described in the sections on configuration for Conducted Tests or Radiated Tests and the power of the UUT is switched off.
- 2) The UUT is powered on at T_0 . T_1 denotes the instant when the UUT has completed its power-up sequence (T_{power_up}). The Channel Availability Check Time commences on Ch_r at instant T_1 and will end no sooner than $T_1 + T_{ch_avail_check}$.
- 3) A single Burst of one of the Short Pulse Radar Types 0-4 will commence within a 6 second window starting at T_1 . An additional 1 dB is added to the radar test signal to ensure it is at or above the DFS Detection Threshold, accounting for equipment variations/errors.
- 4) Visual indication or measured results on the UUT of successful detection of the radar Burst will be recorded and reported. Observation of Ch_r for UUT emissions will continue for 2.5 minutes after the radar Burst has been generated.
- 5) Verify that during the 2.5 minute measurement window no UUT transmissions occurred on Ch_r . The Channel Availability Check results will be recorded.

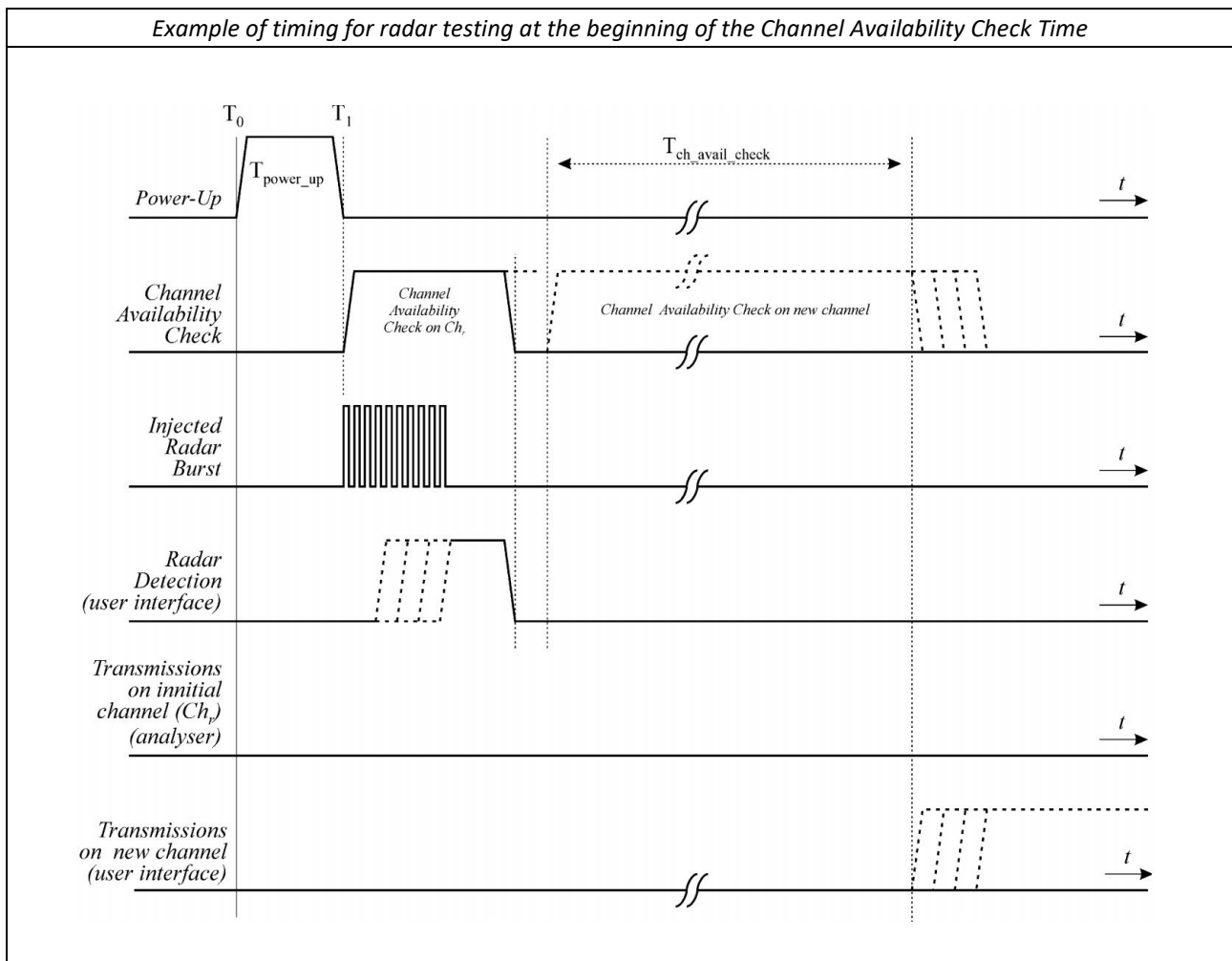

8.3.4 Radar Burst at the End of Channel Availability Check Time

The steps below define the procedure to verify successful radar detection on the test Channel during a period equal to the Channel Availability Check Time and avoidance of operation on that Channel when a radar Burst with a level equal to the DFS Detection Threshold + 1dB occurs at the end of the Channel Availability Check Time as illustrated in the figure below.

- 1) The Radar Waveform generator and UUT are connected using the applicable test setup described in the sections for Conducted Tests (7.2) or Radiated Tests (7.3) and the power of the UUT is switched off.
- 2) The UUT is powered on at T_0 . T_1 denotes the instant when the UUT has completed its power-up sequence (T_{power_up}). The Channel Availability Check Time commences on Ch_r at instant T_1 and will end no sooner than $T_1 + T_{ch_avail_check}$.
- 3) A single Burst of one of the Short Pulse Radar Types 0-4 will commence within a 6 second window starting at $T_1 + 54$ seconds. An additional 1 dB is added to the radar test signal to ensure it is at or above the DFS Detection Threshold, accounting for equipment variations/errors.
- 4) Visual indication or measured results on the UUT of successful detection of the radar Burst will be recorded and reported. Observation of Ch_r for UUT emissions will continue for 2.5 minutes after the radar Burst has been generated.
- 5) Verify that during the 2.5 minute measurement window no UUT transmissions occurred on Ch_r . The Channel Availability Check results will be recorded.

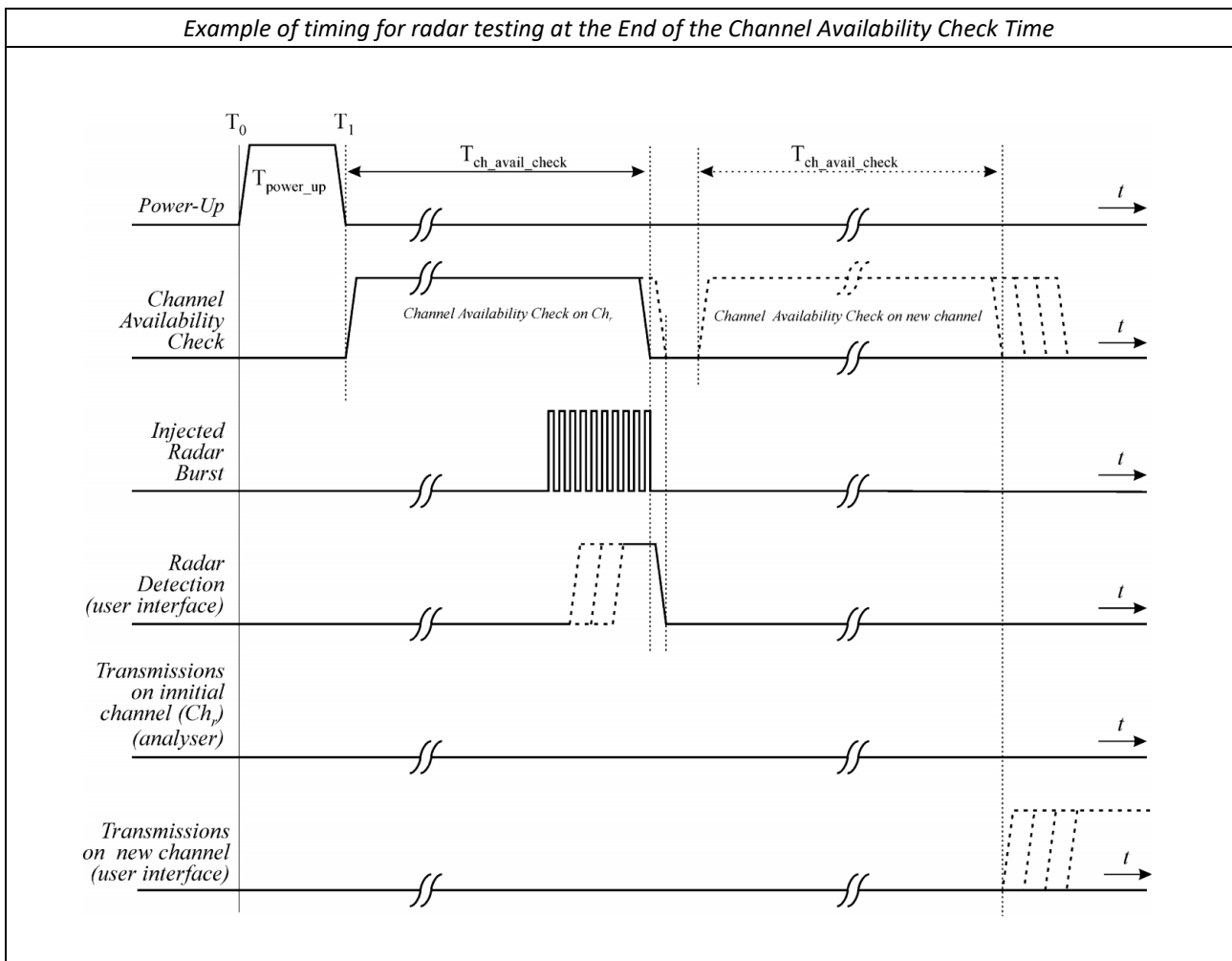

8.3.5 Test Result

Test Frequency 5570 MHz (CH 114)
 Mode 802.11ax HE160

TEST PLOTS



Test Frequency 5250 MHz (CH 50)
 Mode 802.11ax HE160

TEST PLOTS



8.4 In-Service monitoring : Channel Closing Time / Channel Move Time / Non-Occupancy Period

8.4.1 Limit

The EUT has In-Service Monitoring function to continuously monitor the radar signals. If a radar signal is detected, it must leave the channel (Channel Shutdown) and move to a next available channel.

The Channel Move Time stops any transmissions on the current Channel within 10 sec when a Radar Waveform above the DFS Detection Threshold. The total duration of Channel Closing Transmission Time is comprised of 200 milliseconds starting at the beginning of the Channel Move Time plus any additional intermittent control signals required to facilitate Channel changes (an aggregate of 60 milliseconds) during the remainder of the 10 second period. The aggregate duration of control signals will not count quiet periods in between transmissions.

After the channel has been shut down, that same channel should not be utilized at least 30 minutes Non-Occupancy

8.4.2 Test Procedure

The steps below define the procedure to determine the above mentioned parameters when a radar Burst with a level equal to the DFS Detection Threshold + 1dB is generated on the Operating Channel of the UNII device (In- Service Monitoring).

- 1) One frequency will be chosen from the Operating Channels of the UUT within the 5250-5350 MHz or 5470-5725 MHz bands. For 802.11 devices, the test frequency must contain control signals. This can be verified by disabling channel loading and monitoring the spectrum analyzer. If no control signals are detected, another frequency must be selected within the emission bandwidth where control signals are detected.
- 2) In case the UUT is a U-NII device operating as a Client Device (with or without DFS), a U-NII device operating as a Master Device will be used to allow the UUT (Client device) to Associate with the Master Device. In case the UUT is a Master Device, a U-NII device operating as a Client Device will be used and it is assumed that the Client will Associate with the UUT (Master). In both cases for conducted tests, the Radar Waveform generator will be connected to the Master Device. For radiated tests, the emissions of the Radar Waveform generator will be directed towards the Master Device. If the Master Device has antenna gain, the main beam of the antenna will be directed toward the radar emitter. Vertical polarization is used for testing.
- 3) Stream the channel loading test file from the Master Device to the Client Device on the test Channel for the entire period of the test.
- 4) At time T_0 the Radar Waveform generator sends a Burst of pulses for one of the Radar Type 0 in Table 5 at levels defined in Table 3, on the Operating Channel. An additional 1 dB is added to the radar test signal to ensure it is at or above the DFS Detection Threshold, accounting for equipment variations/errors.
- 5) Observe the transmissions of the UUT at the end of the radar Burst on the Operating Channel for duration greater than 10 seconds. Measure and record the transmissions from the UUT during the observation time (Channel Move Time). Measure and record the Channel Move Time and Channel Closing Transmission Time if radar detection occurs. Figure 17 illustrates Channel Closing Transmission Time.
- 6) When operating as a Master Device, monitor the UUT for more than 30 minutes following instant T_2 to verify that the UUT does not resume any transmissions on this Channel. Perform this test once and record the measurement result.
- 7) In case the UUT is a U-NII device operating as a Client Device with In-Service Monitoring, perform steps 1) to 6).

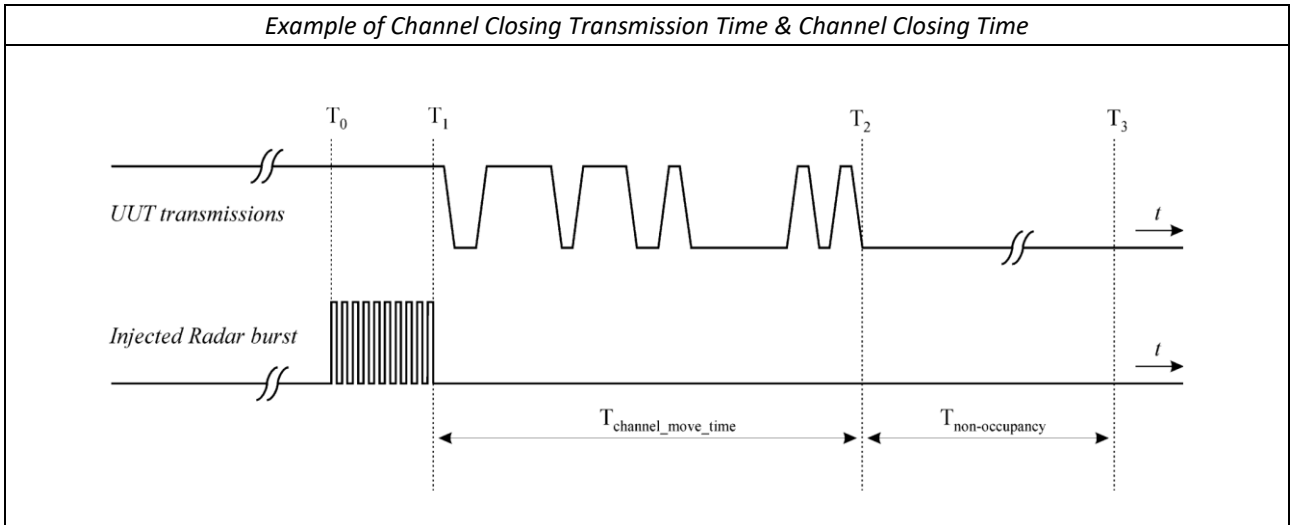

8.4.3 Test Result

Test Frequency	5570 MHz (CH 114)
Mode	802.11ax HE160
Operation Mode	Master

Test Items	Measured Time	Limit	Result
Aggregate Channel Closing Transmission Time After 200 ms	0 ms	60 ms	Compliant
Channel Move Time	0.017 s	10 s	Compliant
Non-Occupancy Period	≥ 30 minutes	≥ 30 minutes	Compliant

TEST PLOTS

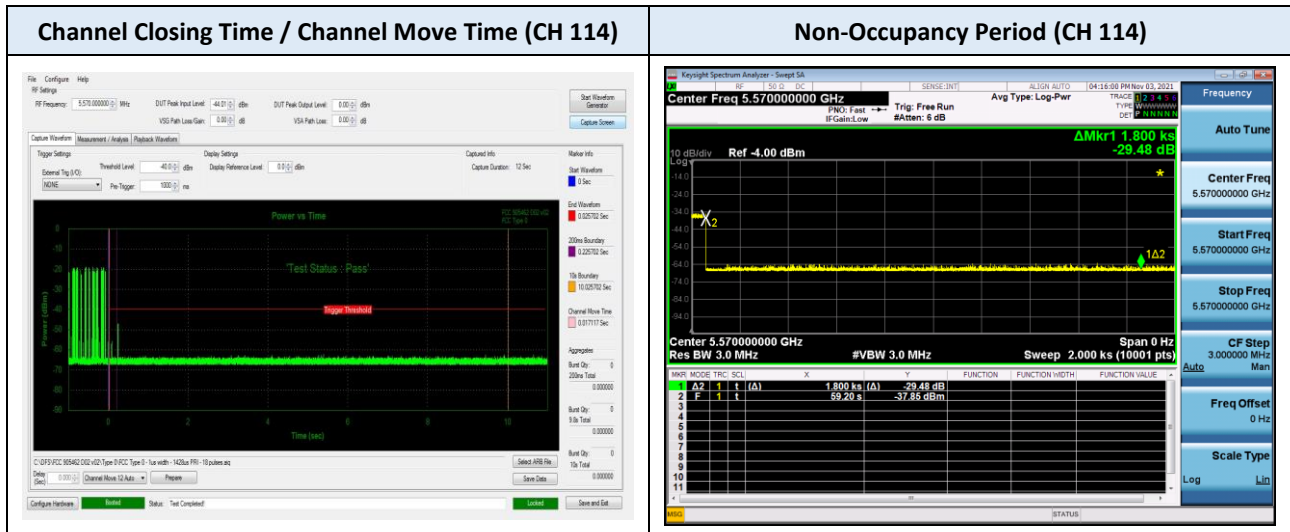

Test Frequency 5250 MHz (CH 50)
 Mode 802.11ax HE160
 Operation Mode Master

Test Items	Measured Time	Limit	Result
Aggregate Channel Closing Transmission Time After 200 ms	0 ms	60 ms	Compliant
Channel Move Time	0.095 s	10 s	Compliant
Non-Occupancy Period	≥ 30 minutes	≥ 30 minutes	Compliant

TEST PLOTS

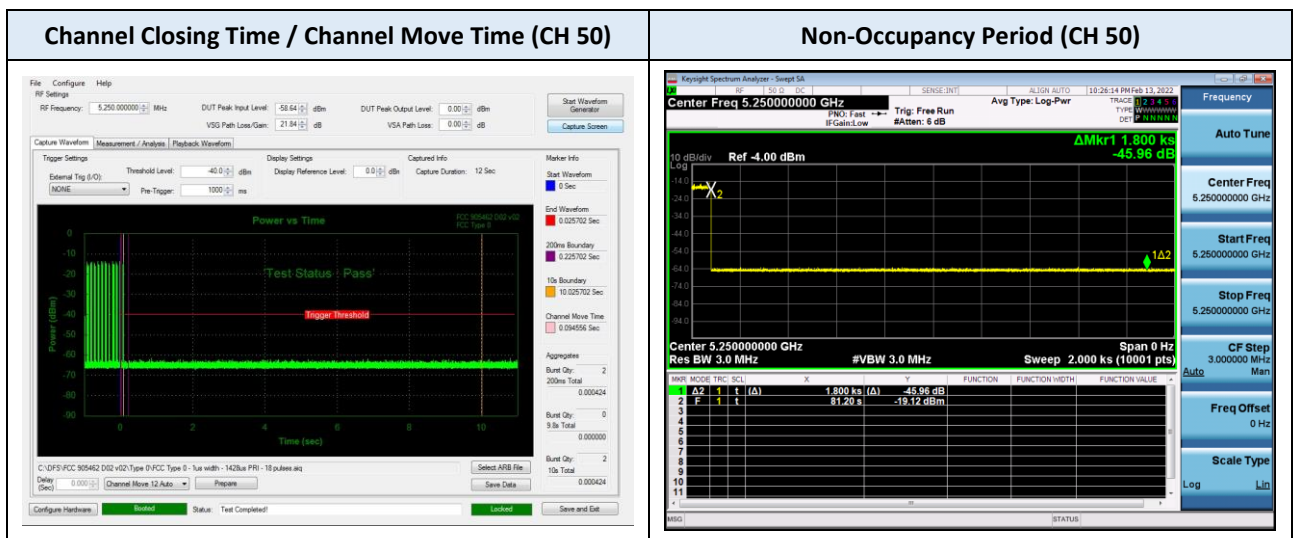

8.5 Statistical Performance Check

8.5.1 Limit

Short Pulse Radar Waveforms

Once the performance requirements check is complete, statistical data will be gathered, to determine the ability of the device to detect the radar test waveforms (Short Pulse Radar Types 1-4). See detailed radar parameters in Table 5

The device can utilize a test mode to demonstrate when detection occurs to prevent the need to reset the device between trials. The percentage of successful detection is calculated by:

$$\text{Total Waveform Detections} / \text{Total Waveform Trials} \times 100 = \% \text{ of Successful Detection Radar Waveform } N = P_d N$$

Radar Type	Minimum % of Successful Detection	Minimum Number of Trials
1	$P_{d1} \geq 60 \%$	15 (TEST A) + 15 (TEST B)
2	$P_{d2} \geq 60 \%$	30
3	$P_{d3} \geq 60 \%$	30
4	$P_{d4} \geq 60 \%$	30
Aggregate (Radar Type 1 – 4)	$(P_{d1} + P_{d2} + P_{d3} + P_{d4}) / 4 \geq 80 \%$	-

Long Pulse Radar Waveforms

Radar Type	Minimum % of Successful Detection	Minimum Number of Trials
5	$P_{d5} \geq 80 \%$	30

Three subsets of trials will be performed with a minimum of ten trials per subset. The subset of trials differs in where the Long Pulse Type 5 Signal is tuned in frequency:

- The Channel center frequency
- Tuned frequencies such that 90% of the Long Pulse Type 5 frequency modulation is within the low edge of the UUT Occupied Bandwidth
- Tuned frequencies such that 90% of the Long Pulse Type 5 frequency modulation is within the high edge of the UUT Occupied Bandwidth

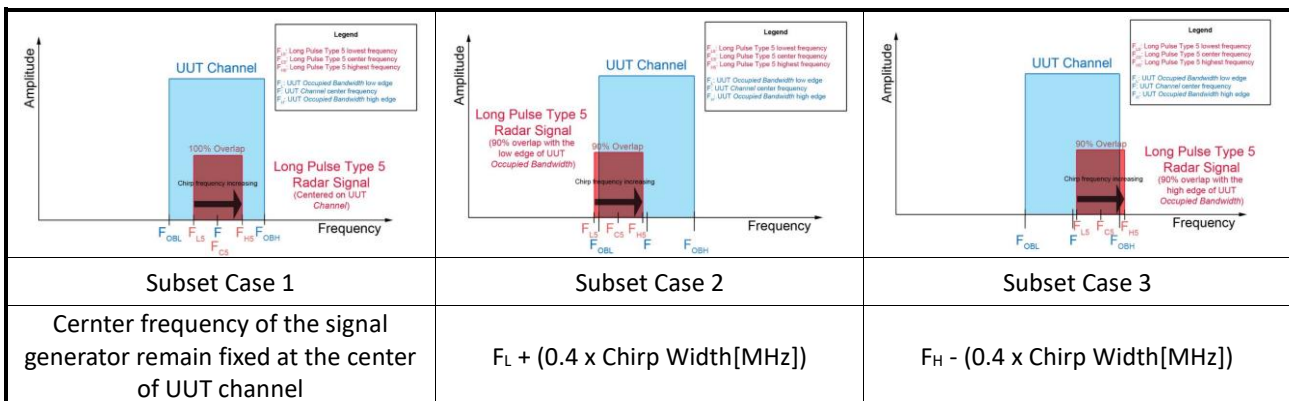

Frequency Hopping Radar Waveforms

Radar Type	Minimum % of Successful Detection	Minimum Number of Trials
6	$P_{d6} \geq 70 \%$	30

8.5.2 Test Procedure

- 1) Generate data traffic between client devices which are connected through UUT network and check the channel loading is 17% (Streaming movie provided by FCC may be used as an alternative method)
- 2) At time T_0 the Radar Waveform generator sends the individual waveform for each of the Radar Types 1-6, at levels equal to the DFS Detection Threshold + 1dB, on the Operating Channel.
- 3) Setup up the UUT to radar detection mode which let the channel stay instead of moving to different channel. Apply the reference radar type 0 to ensure detection occurs, staying in the same channel as original even though radar is detected. Allow 10 seconds for Short Pulse Radar Waveforms and 22 seconds for Long Pulse Radar Waveforms.
- 4) Change test frequency across the detection bandwidth for each trials
- 5) The Minimum number of trails, minimum percentage of successful detection and the average minimum percentage of successful detection are found in the table above.

8.5.3 Test Result

Test Frequency 5500 MHz (CH 100)
 Mode 802.11ax HE20

802.11ax HE20 (5500 MHz)		RADAR TYPE 1			
Trial #	Frequency (MHz)	Pulse Width (us)	PRI (us)	Pulses	Detection (O: Yes, X: No)
1	5505.1	1	518	102	O
2	5493.0	1	538	99	O
3	5502.2	1	540	98	O
4	5492.9	1	618	86	O
5	5490.1	1	638	83	O
6	5500.0	1	658	81	O
7	5505.0	1	678	78	O
8	5502.9	1	698	76	O
9	5497.1	1	718	74	X
10	5505.2	1	758	70	O
11	5509.1	1	778	68	O
12	5507.3	1	798	67	O
13	5492.8	1	824	65	O
14	5494.9	1	878	61	O
15	5499.1	1	895	59	O
16	5500.1	1	898	59	O
17	5496.0	1	917	58	O
18	5499.0	1	938	57	O
19	5501.2	1	948	56	O
20	5490.9	1	1156	46	O
21	5492.7	1	1398	38	O
22	5502.0	1	1444	37	O
23	5500.0	1	1487	36	O
24	5490.0	1	1708	31	O
25	5509.1	1	1721	31	O
26	5507.9	1	2045	26	O
27	5493.0	1	2408	22	O
28	5500.2	1	2705	20	O
29	5497.0	1	2948	18	O
30	5497.7	1	3066	18	O
Number of Successful Detection			29 / 30		
Successful Detection (%)			96.7 %		
Result			Compliant		

Test Frequency 5500 MHz (CH 100)
 Mode 802.11ax HE20

802.11ax HE20 (5500 MHz)		RADAR TYPE 2			
Trial #	Frequency (MHz)	Pulse Width (us)	PRI (us)	Pulses	Detection (O: Yes, X: No)
1	5495.1	1.1	157	28	O
2	5507.0	1.2	218	27	O
3	5491.9	1.3	212	29	O
4	5494.2	1.4	207	26	O
5	5499.1	1.4	213	28	O
6	5510.0	1.6	181	26	O
7	5494.8	1.8	193	24	O
8	5510.1	2.1	187	23	O
9	5502.2	2.2	157	28	O
10	5506.8	2.3	194	25	O
11	5499.1	2.3	203	26	O
12	5508.9	2.3	228	25	O
13	5509.3	2.4	167	26	O
14	5496.1	2.5	203	29	O
15	5509.1	3.1	178	24	O
16	5502.0	3.3	220	29	O
17	5505.0	3.5	219	29	O
18	5490.1	3.7	187	29	O
19	5501.7	3.8	222	27	O
20	5498.8	4.4	158	24	O
21	5510.0	4.4	158	26	O
22	5506.0	4.4	181	26	O
23	5500.1	4.4	213	25	O
24	5509.1	4.5	171	27	O
25	5506.9	4.8	203	25	O
26	5496.8	4.9	164	27	O
27	5504.9	4.9	184	25	O
28	5503.1	4.9	221	28	O
29	5499.3	5	157	26	O
30	5491.1	5	191	26	O
Number of Successful Detection			30 / 30		
Successful Detection (%)			100.0 %		
Result			Compliant		

Test Frequency 5500 MHz (CH 100)
 Mode 802.11ax HE20

802.11ax HE20 (5500 MHz)		RADAR TYPE 3			
Trial #	Frequency (MHz)	Pulse Width (us)	PRI (us)	Pulses	Detection (O: Yes, X: No)
1	5490.0	6.2	439	18	O
2	5508.1	6.2	489	18	O
3	5502.9	6.3	438	18	O
4	5504.2	6.4	453	17	O
5	5506.1	6.4	454	17	O
6	5502.9	6.5	209	16	O
7	5506.3	6.5	451	18	O
8	5490.1	6.6	310	17	O
9	5497.0	6.6	423	17	O
10	5510.0	6.8	206	18	O
11	5496.2	6.8	338	16	O
12	5505.1	6.8	487	17	O
13	5502.1	7.4	372	17	O
14	5497.9	7.6	243	18	O
15	5508.3	7.6	443	17	O
16	5504.9	7.7	242	16	O
17	5496.0	7.8	375	16	O
18	5500.1	8	357	18	O
19	5510.0	8	446	18	O
20	5493.0	8.4	425	18	O
21	5494.8	9	212	18	O
22	5510.1	9	273	18	O
23	5509.0	9.3	302	17	O
24	5497.2	9.5	303	16	O
25	5510.0	9.5	419	17	O
26	5497.9	9.8	223	17	O
27	5492.3	9.8	374	16	O
28	5510.1	9.8	422	17	O
29	5493.0	9.9	442	17	O
30	5500.0	9.9	498	16	O
Number of Successful Detection			30 / 30		
Successful Detection (%)			100.0 %		
Result			Compliant		

Test Frequency 5500 MHz (CH 100)
 Mode 802.11ax HE20

802.11ax HE20 (5500 MHz)		RADAR TYPE 4			
Trial #	Frequency (MHz)	Pulse Width (us)	PRI (us)	Pulses	Detection (O: Yes, X: No)
1	5504.1	11.1	356	15	O
2	5494.9	11.1	491	16	O
3	5501.1	11.2	431	16	O
4	5498.2	11.7	361	12	O
5	5493.9	11.8	298	12	O
6	5500.0	12	478	14	O
7	5507.0	12.1	497	14	O
8	5508.1	12.4	365	16	O
9	5499.0	13.5	366	13	O
10	5496.9	13.6	455	15	O
11	5510.0	13.7	280	14	O
12	5501.2	13.8	354	15	O
13	5500.0	14.5	412	14	O
14	5508.0	14.6	356	14	O
15	5494.1	14.7	301	12	O
16	5498.0	15.2	230	13	O
17	5495.3	15.4	257	12	O
18	5497.0	15.4	498	15	O
19	5503.1	15.8	313	13	O
20	5495.0	15.8	400	12	O
21	5493.0	15.9	477	16	O
22	5502.9	16.1	287	13	O
23	5502.1	16.2	435	14	O
24	5490.4	16.4	304	13	O
25	5504.0	16.9	230	16	O
26	5504.1	17.2	379	13	O
27	5508.2	17.2	410	12	O
28	5492.3	17.5	500	13	O
29	5500.0	18.4	233	15	O
30	5509.1	19.3	213	15	O
Number of Successful Detection			30 / 30		
Successful Detection (%)			100.0 %		
Result			Compliant		

Note :

Aggregate (Radar Type 1 – 4) = (96.7 % + 100.0 % + 100.0 % + 100.0 %) / 4 = 99.2 % > 80 %

Test Frequency 5500 MHz (CH 100)
 Mode 802.11ax HE20

802.11ax HE20 (5500 MHz)		RADAR TYPE 5			
Trial #	Frequency (MHz)	Chirp Width (MHz)	Specification	Number of Detection	Detection (O:Yes, X: No)
1 (Note a)	5500.0	19	See Section 9 (Chirp 00)	2	O
2 (Note b)	5497.2	18	See Section 9 (Chirp 01)	2	O
3 (Note c)	5507.6	6	See Section 9 (Chirp 02)	2	O
4 (Note a)	5500.1	12	See Section 9 (Chirp 03)	2	O
5 (Note b)	5493.2	8	See Section 9 (Chirp 04)	2	O
6 (Note c)	5504.4	14	See Section 9 (Chirp 05)	2	O
7 (Note a)	5499.9	6	See Section 9 (Chirp 06)	2	O
8 (Note b)	5495.2	13	See Section 9 (Chirp 07)	2	O
9 (Note c)	5506.4	9	See Section 9 (Chirp 08)	2	O
10 (Note a)	5500.0	8	See Section 9 (Chirp 09)	2	O
11 (Note b)	5493.2	8	See Section 9 (Chirp 10)	2	O
12 (Note c)	5504.8	13	See Section 9 (Chirp 11)	2	O
13 (Note a)	5500.5	17	See Section 9 (Chirp 12)	2	O
14 (Note b)	5495.2	13	See Section 9 (Chirp 13)	2	O
15 (Note c)	5502.4	19	See Section 9 (Chirp 14)	2	O
16 (Note a)	5500.9	15	See Section 9 (Chirp 15)	2	O
17 (Note b)	5492.4	6	See Section 9 (Chirp 16)	2	O
18 (Note c)	5503.6	16	See Section 9 (Chirp 17)	2	O
19 (Note a)	5499.2	11	See Section 9 (Chirp 18)	2	O
20 (Note b)	5492.8	7	See Section 9 (Chirp 19)	2	O
21 (Note c)	5504.0	15	See Section 9 (Chirp 20)	2	O
22 (Note a)	5498.9	17	See Section 9 (Chirp 21)	2	O
23 (Note b)	5496.4	16	See Section 9 (Chirp 22)	2	O
24 (Note c)	5502.8	18	See Section 9 (Chirp 23)	2	O
25 (Note a)	5500.0	12	See Section 9 (Chirp 24)	2	O
26 (Note b)	5493.6	9	See Section 9 (Chirp 25)	2	O
27 (Note c)	5502.4	19	See Section 9 (Chirp 26)	2	O
28 (Note a)	5500.4	5	See Section 9 (Chirp 27)	2	O
29 (Note b)	5495.2	13	See Section 9 (Chirp 28)	2	O
30 (Note c)	5503.6	16	See Section 9 (Chirp 29)	1	O
Number of Successful Detection				30 / 30	
Successful Detection (%)				100.0 %	
Result				Compliant	

Note:

- (a) Channel center frequency
- (b) Tuned frequencies such that 90% of the Long Pulse Type 5 frequency modulation is within the low edge of the UUT Occupied Bandwidth [$FL + (0.4 * Chirp\ Width\ [in\ MHz])$]
- (c) Tuned frequencies such that 90% of the Long Pulse Type 5 frequency modulation is within the high edge of the UUT Occupied Bandwidth [$FH - (0.4 * Chirp\ Width\ [in\ MHz])$]

Test Frequency 5500 MHz (CH 100)
 Mode 802.11ax HE20

802.11ax HE20 (5500 MHz)		RADAR TYPE 6			
Trial #	Frequency (MHz)	Pulse Width (us)	PRI (us)	Pulses / Hop	Detection (O: Yes, X: No)
1	5507.9	1	333	9	O
2	5507.0	1	333	9	X
3	5503.0	1	333	9	O
4	5500.1	1	333	9	O
5	5507.0	1	333	9	O
6	5495.2	1	333	9	O
7	5502.0	1	333	9	O
8	5494.1	1	333	9	O
9	5501.1	1	333	9	O
10	5500.0	1	333	9	O
11	5502.0	1	333	9	O
12	5510.0	1	333	9	O
13	5491.4	1	333	9	O
14	5501.2	1	333	9	O
15	5496.1	1	333	9	O
16	5508.3	1	333	9	O
17	5491.1	1	333	9	O
18	5500.2	1	333	9	O
19	5508.1	1	333	9	O
20	5493.0	1	333	9	O
21	5498.0	1	333	9	O
22	5505.2	1	333	9	O
23	5496.1	1	333	9	O
24	5504.0	1	333	9	O
25	5495.0	1	333	9	O
26	5505.9	1	333	9	O
27	5505.0	1	333	9	O
28	5495.4	1	333	9	O
29	5494.1	1	333	9	O
30	5500.0	1	333	9	O
Number of Successful Detection			29 / 30		
Successful Detection (%)			96.7 %		
Result			Compliant		

Test Frequency 5510 MHz (CH 102)
 Mode 802.11ax HE40

802.11ax HE40 (5510 MHz)		RADAR TYPE 1			
Trial #	Frequency (MHz)	Pulse Width (us)	PRI (us)	Pulses	Detection (O: Yes, X: No)
1	5510.0	1	518	102	O
2	5514.1	1	538	99	O
3	5494.1	1	540	98	O
4	5490.6	1	618	86	O
5	5510.0	1	638	83	O
6	5507.1	1	658	81	O
7	5515.0	1	678	78	O
8	5507.1	1	698	76	O
9	5520.0	1	718	74	O
10	5518.9	1	758	70	O
11	5519.1	1	778	68	O
12	5515.2	1	798	67	O
13	5525.9	1	824	65	O
14	5494.3	1	878	61	O
15	5490.0	1	895	59	O
16	5503.0	1	898	59	O
17	5525.3	1	917	58	O
18	5507.0	1	938	57	O
19	5502.0	1	948	56	O
20	5490.1	1	1156	46	O
21	5524.0	1	1398	38	O
22	5506.0	1	1444	37	O
23	5510.1	1	1487	36	O
24	5490.2	1	1708	31	O
25	5526.0	1	1721	31	O
26	5529.2	1	2045	26	O
27	5506.0	1	2408	22	O
28	5500.8	1	2705	20	O
29	5495.0	1	2948	18	O
30	5491.1	1	3066	18	O
Number of Successful Detection			30 / 30		
Successful Detection (%)			100.0 %		
Result			Compliant		

Test Frequency 5510 MHz (CH 102)
 Mode 802.11ax HE40

802.11ax HE40 (5510 MHz)		RADAR TYPE 2			
Trial #	Frequency (MHz)	Pulse Width (us)	PRI (us)	Pulses	Detection (O: Yes, X: No)
1	5521.0	1.1	157	28	O
2	5520.0	1.2	218	27	O
3	5510.0	1.3	212	29	O
4	5498.1	1.4	207	26	O
5	5511.0	1.4	213	28	O
6	5508.0	1.6	181	26	O
7	5497.1	1.8	193	24	O
8	5502.2	2.1	187	23	O
9	5516.0	2.2	157	28	O
10	5510.3	2.3	194	25	O
11	5520.1	2.3	203	26	O
12	5494.0	2.3	228	25	O
13	5517.0	2.4	167	26	O
14	5495.1	2.5	203	29	O
15	5508.2	3.1	178	24	O
16	5520.0	3.3	220	29	O
17	5527.0	3.5	219	29	O
18	5500.7	3.7	187	29	O
19	5513.0	3.8	222	27	O
20	5503.0	4.4	158	24	O
21	5505.0	4.4	158	26	O
22	5510.0	4.4	181	26	O
23	5496.1	4.4	213	25	O
24	5506.9	4.5	171	27	O
25	5501.8	4.8	203	25	O
26	5506.4	4.9	164	27	O
27	5498.2	4.9	184	25	O
28	5491.5	4.9	221	28	O
29	5502.3	5	157	26	O
30	5512.0	5	191	26	O
Number of Successful Detection			30 / 30		
Successful Detection (%)			100.0 %		
Result			Compliant		

Test Frequency 5510 MHz (CH 102)
 Mode 802.11ax HE40

802.11ax HE40 (5510 MHz)		RADAR TYPE 3			
Trial #	Frequency (MHz)	Pulse Width (us)	PRI (us)	Pulses	Detection (O: Yes, X: No)
1	5507.1	6.2	439	18	O
2	5524.8	6.2	489	18	O
3	5507.0	6.3	438	18	X
4	5503.1	6.4	453	17	O
5	5496.4	6.4	454	17	O
6	5510.0	6.5	209	16	O
7	5524.0	6.5	451	18	X
8	5509.1	6.6	310	17	O
9	5496.2	6.6	423	17	O
10	5523.3	6.8	206	18	O
11	5500.0	6.8	338	16	O
12	5516.0	6.8	487	17	O
13	5493.2	7.4	372	17	O
14	5505.2	7.6	243	18	O
15	5523.1	7.6	443	17	O
16	5507.0	7.7	242	16	O
17	5525.0	7.8	375	16	O
18	5513.0	8	357	18	O
19	5518.9	8	446	18	O
20	5491.0	8.4	425	18	O
21	5513.1	9	212	18	O
22	5520.2	9	273	18	O
23	5504.1	9.3	302	17	O
24	5516.0	9.5	303	16	O
25	5503.1	9.5	419	17	O
26	5499.2	9.8	223	17	O
27	5529.0	9.8	374	16	X
28	5527.0	9.8	422	17	O
29	5498.4	9.9	442	17	O
30	5510.0	9.9	498	16	O
Number of Successful Detection			27 / 30		
Successful Detection (%)			90.0 %		
Result			Compliant		

Test Frequency 5510 MHz (CH 102)
 Mode 802.11ax HE40

802.11ax HE40 (5510 MHz)		RADAR TYPE 4			
Trial #	Frequency (MHz)	Pulse Width (us)	PRI (us)	Pulses	Detection (O: Yes, X: No)
1	5528.1	11.1	356	15	O
2	5490.0	11.1	491	16	O
3	5492.2	11.2	431	16	O
4	5518.0	11.7	361	12	O
5	5510.0	11.8	298	12	O
6	5514.1	12	478	14	O
7	5515.0	12.1	497	14	O
8	5524.0	12.4	365	16	O
9	5524.9	13.5	366	13	O
10	5495.2	13.6	455	15	O
11	5503.0	13.7	280	14	O
12	5494.3	13.8	354	15	O
13	5517.4	14.5	412	14	O
14	5509.0	14.6	356	14	O
15	5524.2	14.7	301	12	O
16	5510.0	15.2	230	13	O
17	5495.0	15.4	257	12	O
18	5499.0	15.4	498	15	O
19	5507.0	15.8	313	13	O
20	5518.1	15.8	400	12	O
21	5529.0	15.9	477	16	O
22	5502.2	16.1	287	13	O
23	5527.0	16.2	435	14	O
24	5517.0	16.4	304	13	O
25	5501.1	16.9	230	16	O
26	5513.1	17.2	379	13	O
27	5525.8	17.2	410	12	O
28	5502.2	17.5	500	13	O
29	5526.9	18.4	233	15	O
30	5492.2	19.3	213	15	O
Number of Successful Detection			30 / 30		
Successful Detection (%)			100.0 %		
Result			Compliant		

Note :

Aggregate (Radar Type 1 – 4) = (100.0 % + 100.0 % + 90.0 % + 100.0 %) / 4 = 97.5 % > 80 %

Test Frequency 5510 MHz (CH 102)
 Mode 802.11ax HE40

802.11ax HE40 (5510 MHz)		RADAR TYPE 5			
Trial #	Frequency (MHz)	Chirp Width (MHz)	Specification	Number of Detection	Detection (O:Yes, X: No)
1 (Note a)	5510.0	19	See Section 9 (Chirp 00)	2	O
2 (Note b)	5497.2	18	See Section 9 (Chirp 01)	2	O
3 (Note c)	5527.6	6	See Section 9 (Chirp 02)	1	O
4 (Note a)	5510.1	12	See Section 9 (Chirp 03)	2	O
5 (Note b)	5493.2	8	See Section 9 (Chirp 04)	2	O
6 (Note c)	5524.4	14	See Section 9 (Chirp 05)	2	O
7 (Note a)	5509.9	6	See Section 9 (Chirp 06)	2	O
8 (Note b)	5495.2	13	See Section 9 (Chirp 07)	2	O
9 (Note c)	5526.4	9	See Section 9 (Chirp 08)	2	O
10 (Note a)	5511.4	8	See Section 9 (Chirp 09)	2	O
11 (Note b)	5493.2	8	See Section 9 (Chirp 10)	2	O
12 (Note c)	5524.8	13	See Section 9 (Chirp 11)	2	O
13 (Note a)	5510.5	17	See Section 9 (Chirp 12)	1	O
14 (Note b)	5495.2	13	See Section 9 (Chirp 13)	2	O
15 (Note c)	5522.4	19	See Section 9 (Chirp 14)	2	O
16 (Note a)	5510.9	15	See Section 9 (Chirp 15)	2	O
17 (Note b)	5492.4	6	See Section 9 (Chirp 16)	2	O
18 (Note c)	5523.6	16	See Section 9 (Chirp 17)	2	O
19 (Note a)	5509.2	11	See Section 9 (Chirp 18)	1	O
20 (Note b)	5492.8	7	See Section 9 (Chirp 19)	1	O
21 (Note c)	5524.0	15	See Section 9 (Chirp 20)	2	O
22 (Note a)	5508.9	17	See Section 9 (Chirp 21)	2	O
23 (Note b)	5496.4	16	See Section 9 (Chirp 22)	1	O
24 (Note c)	5522.8	18	See Section 9 (Chirp 23)	2	O
25 (Note a)	5510.0	12	See Section 9 (Chirp 24)	2	O
26 (Note b)	5493.6	9	See Section 9 (Chirp 25)	1	O
27 (Note c)	5522.4	19	See Section 9 (Chirp 26)	2	O
28 (Note a)	5510.4	5	See Section 9 (Chirp 27)	2	O
29 (Note b)	5495.2	13	See Section 9 (Chirp 28)	2	O
30 (Note c)	5523.6	16	See Section 9 (Chirp 29)	2	O
Number of Successful Detection				30 / 30	
Successful Detection (%)				100.0 %	
Result				Compliant	

Note:

- (a) Channel center frequency
- (b) Tuned frequencies such that 90% of the Long Pulse Type 5 frequency modulation is within the low edge of the UUT Occupied Bandwidth [$FL + (0.4 * Chirp\ Width\ [in\ MHz])$]
- (c) Tuned frequencies such that 90% of the Long Pulse Type 5 frequency modulation is within the high edge of the UUT Occupied Bandwidth [$FH - (0.4 * Chirp\ Width\ [in\ MHz])$]

Test Frequency 5510 MHz (CH 102)
 Mode 802.11ax HE40

802.11ax HE40 (5510 MHz)		RADAR TYPE 6			
Trial #	Frequency (MHz)	Pulse Width (us)	PRI (us)	Pulses / Hop	Detection (O: Yes, X: No)
1	5499.7	1	333	9	O
2	5510.0	1	333	9	O
3	5512.9	1	333	9	O
4	5496.0	1	333	9	O
5	5520.1	1	333	9	O
6	5490.2	1	333	9	O
7	5510.0	1	333	9	O
8	5528.8	1	333	9	O
9	5490.1	1	333	9	O
10	5497.9	1	333	9	O
11	5502.1	1	333	9	O
12	5518.0	1	333	9	O
13	5507.0	1	333	9	O
14	5520.3	1	333	9	O
15	5505.1	1	333	9	O
16	5509.1	1	333	9	O
17	5498.0	1	333	9	O
18	5504.0	1	333	9	O
19	5491.0	1	333	9	O
20	5528.2	1	333	9	O
21	5516.3	1	333	9	O
22	5510.0	1	333	9	O
23	5493.1	1	333	9	O
24	5503.7	1	333	9	O
25	5495.0	1	333	9	O
26	5513.0	1	333	9	O
27	5492.1	1	333	9	O
28	5491.0	1	333	9	O
29	5528.0	1	333	9	O
30	5507.2	1	333	9	O
Number of Successful Detection			30 / 30		
Successful Detection (%)			100.0 %		
Result			Compliant		

Test Frequency 5530 MHz (CH 106)
 Mode 802.11ax HE80

802.11ax HE80 (5530 MHz)		RADAR TYPE 1			
Trial #	Frequency (MHz)	Pulse Width (us)	PRI (us)	Pulses	Detection (O: Yes, X: No)
1	5493.0	1	518	102	O
2	5530.0	1	538	99	O
3	5538.2	1	540	98	O
4	5511.0	1	618	86	O
5	5554.1	1	638	83	O
6	5506.0	1	658	81	O
7	5524.8	1	678	78	O
8	5507.0	1	698	76	O
9	5569.1	1	718	74	O
10	5548.9	1	758	70	O
11	5499.3	1	778	68	O
12	5494.0	1	798	67	O
13	5537.1	1	824	65	O
14	5532.1	1	878	61	O
15	5544.0	1	895	59	O
16	5568.8	1	898	59	O
17	5530.0	1	917	58	O
18	5556.1	1	938	57	O
19	5497.0	1	948	56	O
20	5518.2	1	1156	46	O
21	5535.0	1	1398	38	O
22	5493.0	1	1444	37	O
23	5551.1	1	1487	36	O
24	5540.9	1	1708	31	O
25	5498.0	1	1721	31	O
26	5491.0	1	2045	26	O
27	5532.8	1	2408	22	O
28	5493.1	1	2705	20	O
29	5539.0	1	2948	18	O
30	5553.2	1	3066	18	O
Number of Successful Detection			30 / 30		
Successful Detection (%)			100.0 %		
Result			Compliant		

Test Frequency 5530 MHz (CH 106)
 Mode 802.11ax HE80

802.11ax HE80 (5530 MHz)		RADAR TYPE 2			
Trial #	Frequency (MHz)	Pulse Width (us)	PRI (us)	Pulses	Detection (O: Yes, X: No)
1	5491.2	1.1	157	28	O
2	5538.0	1.2	218	27	O
3	5530.0	1.3	212	29	O
4	5556.0	1.4	207	26	O
5	5525.0	1.4	213	28	O
6	5493.0	1.6	181	26	O
7	5569.1	1.8	193	24	O
8	5511.2	2.1	187	23	O
9	5520.0	2.2	157	28	O
10	5530.0	2.3	194	25	O
11	5495.3	2.3	203	26	O
12	5542.0	2.3	228	25	O
13	5495.6	2.4	167	26	O
14	5551.1	2.5	203	29	O
15	5560.0	3.1	178	24	O
16	5542.0	3.3	220	29	O
17	5530.4	3.5	219	29	O
18	5502.2	3.7	187	29	O
19	5553.1	3.8	222	27	O
20	5518.1	4.4	158	24	O
21	5490.5	4.4	158	26	O
22	5547.8	4.4	181	26	O
23	5560.9	4.4	213	25	O
24	5555.0	4.5	171	27	O
25	5510.2	4.8	203	25	O
26	5547.1	4.9	164	27	O
27	5548.0	4.9	184	25	O
28	5510.4	4.9	221	28	O
29	5529.1	5	157	26	O
30	5506.1	5	191	26	X
Number of Successful Detection			29 / 30		
Successful Detection (%)			96.7 %		
Result			Compliant		

Test Frequency 5530 MHz (CH 106)
 Mode 802.11ax HE80

802.11ax HE80 (5530 MHz)		RADAR TYPE 3			
Trial #	Frequency (MHz)	Pulse Width (us)	PRI (us)	Pulses	Detection (O: Yes, X: No)
1	5540.1	6.2	439	18	O
2	5506.0	6.2	489	18	O
3	5534.0	6.3	438	18	O
4	5530.2	6.4	453	17	O
5	5513.4	6.4	454	17	O
6	5519.0	6.5	209	16	O
7	5496.0	6.5	451	18	O
8	5512.8	6.6	310	17	O
9	5547.0	6.6	423	17	X
10	5551.9	6.8	206	18	O
11	5490.0	6.8	338	16	O
12	5531.2	6.8	487	17	O
13	5537.3	7.4	372	17	O
14	5565.0	7.6	243	18	O
15	5568.0	7.6	443	17	O
16	5514.4	7.7	242	16	O
17	5502.1	7.8	375	16	O
18	5555.1	8	357	18	O
19	5529.0	8	446	18	O
20	5530.0	8.4	425	18	O
21	5539.9	9	212	18	O
22	5546.2	9	273	18	O
23	5516.9	9.3	302	17	O
24	5500.0	9.5	303	16	O
25	5553.8	9.5	419	17	O
26	5545.0	9.8	223	17	O
27	5530.0	9.8	374	16	O
28	5492.1	9.8	422	17	O
29	5552.0	9.9	442	17	O
30	5562.0	9.9	498	16	O
Number of Successful Detection			29 / 30		
Successful Detection (%)			96.7 %		
Result			Compliant		

Test Frequency 5530 MHz (CH 106)
 Mode 802.11ax HE80

802.11ax HE80 (5530 MHz)		RADAR TYPE 4			
Trial #	Frequency (MHz)	Pulse Width (us)	PRI (us)	Pulses	Detection (O: Yes, X: No)
1	5566.0	11.1	356	15	O
2	5530.0	11.1	491	16	O
3	5555.1	11.2	431	16	O
4	5536.2	11.7	361	12	O
5	5559.2	11.8	298	12	O
6	5517.0	12	478	14	O
7	5522.0	12.1	497	14	O
8	5523.1	12.4	365	16	O
9	5494.2	13.5	366	13	O
10	5552.0	13.6	455	15	O
11	5550.0	13.7	280	14	O
12	5494.1	13.8	354	15	O
13	5567.0	14.5	412	14	O
14	5512.9	14.6	356	14	O
15	5490.8	14.7	301	12	O
16	5539.0	15.2	230	13	O
17	5493.0	15.4	257	12	O
18	5531.1	15.4	498	15	O
19	5556.1	15.8	313	13	O
20	5530.0	15.8	400	12	O
21	5513.2	15.9	477	16	O
22	5566.8	16.1	287	13	O
23	5550.1	16.2	435	14	O
24	5494.2	16.4	304	13	O
25	5498.9	16.9	230	16	O
26	5531.0	17.2	379	13	O
27	5535.0	17.2	410	12	O
28	5505.0	17.5	500	13	O
29	5563.1	18.4	233	15	O
30	5540.0	19.3	213	15	O
Number of Successful Detection			30 / 30		
Successful Detection (%)			100.0 %		
Result			Compliant		

Note :

Aggregate (Radar Type 1 – 4) = (100.0 % + 96.7 % + 96.7 % + 100.0 %) / 4 = 98.3 % > 80 %

Test Frequency 5530 MHz (CH 106)
 Mode 802.11ax HE80

802.11ax HE80 (5530 MHz)		RADAR TYPE 5			
Trial #	Frequency (MHz)	Chirp Width (MHz)	Specification	Number of Detection	Detection (O:Yes, X: No)
1 (Note a)	5530.0	19	See Section 9 (Chirp 00)	2	O
2 (Note b)	5497.2	18	See Section 9 (Chirp 01)	2	O
3 (Note c)	5567.6	6	See Section 9 (Chirp 02)	1	O
4 (Note a)	5530.1	12	See Section 9 (Chirp 03)	2	O
5 (Note b)	5493.2	8	See Section 9 (Chirp 04)	1	O
6 (Note c)	5564.4	14	See Section 9 (Chirp 05)	2	O
7 (Note a)	5529.9	6	See Section 9 (Chirp 06)	1	O
8 (Note b)	5495.2	13	See Section 9 (Chirp 07)	2	O
9 (Note c)	5566.4	9	See Section 9 (Chirp 08)	2	O
10 (Note a)	5530.0	8	See Section 9 (Chirp 09)	2	O
11 (Note b)	5493.2	8	See Section 9 (Chirp 10)	2	O
12 (Note c)	5564.8	13	See Section 9 (Chirp 11)	2	O
13 (Note a)	5530.5	17	See Section 9 (Chirp 12)	1	O
14 (Note b)	5495.2	13	See Section 9 (Chirp 13)	2	O
15 (Note c)	5562.4	19	See Section 9 (Chirp 14)	2	O
16 (Note a)	5530.9	15	See Section 9 (Chirp 15)	1	O
17 (Note b)	5492.4	6	See Section 9 (Chirp 16)	2	O
18 (Note c)	5563.6	16	See Section 9 (Chirp 17)	2	O
19 (Note a)	5529.2	11	See Section 9 (Chirp 18)	1	O
20 (Note b)	5492.8	7	See Section 9 (Chirp 19)	2	O
21 (Note c)	5564.0	15	See Section 9 (Chirp 20)	2	O
22 (Note a)	5528.9	17	See Section 9 (Chirp 21)	2	O
23 (Note b)	5496.4	16	See Section 9 (Chirp 22)	2	O
24 (Note c)	5562.8	18	See Section 9 (Chirp 23)	2	O
25 (Note a)	5530.0	12	See Section 9 (Chirp 24)	2	O
26 (Note b)	5493.6	9	See Section 9 (Chirp 25)	2	O
27 (Note c)	5562.4	19	See Section 9 (Chirp 26)	2	O
28 (Note a)	5530.4	5	See Section 9 (Chirp 27)	2	O
29 (Note b)	5495.2	13	See Section 9 (Chirp 28)	1	O
30 (Note c)	5563.6	16	See Section 9 (Chirp 29)	1	O
Number of Successful Detection				30 / 30	
Successful Detection (%)				100.0 %	
Result				Compliant	

Note:

- (a) Channel center frequency
- (b) Tuned frequencies such that 90% of the Long Pulse Type 5 frequency modulation is within the low edge of the UUT Occupied Bandwidth [$FL + (0.4 * Chirp\ Width\ [in\ MHz])$]
- (c) Tuned frequencies such that 90% of the Long Pulse Type 5 frequency modulation is within the high edge of the UUT Occupied Bandwidth [$FH - (0.4 * Chirp\ Width\ [in\ MHz])$]

Test Frequency 5530 MHz (CH 106)
 Mode 802.11ax HE80

802.11ax HE80 (5530 MHz)		RADAR TYPE 6			
Trial #	Frequency (MHz)	Pulse Width (us)	PRI (us)	Pulses / Hop	Detection (O: Yes, X: No)
1	5530.0	1	333	9	O
2	5525.5	1	333	9	O
3	5510.2	1	333	9	O
4	5569.0	1	333	9	O
5	5526.1	1	333	9	O
6	5556.2	1	333	9	O
7	5550.0	1	333	9	O
8	5531.1	1	333	9	O
9	5510.3	1	333	9	O
10	5561.1	1	333	9	O
11	5568.1	1	333	9	O
12	5526.0	1	333	9	O
13	5540.0	1	333	9	O
14	5500.7	1	333	9	O
15	5539.0	1	333	9	O
16	5508.2	1	333	9	O
17	5518.0	1	333	9	O
18	5495.0	1	333	9	O
19	5520.9	1	333	9	O
20	5569.1	1	333	9	O
21	5560.1	1	333	9	O
22	5515.0	1	333	9	O
23	5536.3	1	333	9	O
24	5547.0	1	333	9	O
25	5493.0	1	333	9	O
26	5543.0	1	333	9	O
27	5519.4	1	333	9	O
28	5566.9	1	333	9	O
29	5521.0	1	333	9	O
30	5526.8	1	333	9	O
Number of Successful Detection			30 / 30		
Successful Detection (%)			100.0 %		
Result			Compliant		

Test Frequency 5570 MHz (CH 114)
 Mode 802.11ax HE160

802.11ax HE160 (5570 MHz)		RADAR TYPE 1			
Trial #	Frequency (MHz)	Pulse Width (us)	PRI (us)	Pulses	Detection (O: Yes, X: No)
1	5595.1	1	518	102	O
2	5543.2	1	538	99	O
3	5570.0	1	540	98	O
4	5632.9	1	618	86	O
5	5497.8	1	638	83	O
6	5650.0	1	658	81	O
7	5592.1	1	678	78	O
8	5597.1	1	698	76	O
9	5522.3	1	718	74	X
10	5628.2	1	758	70	O
11	5583.0	1	778	68	O
12	5568.1	1	798	67	O
13	5570.0	1	824	65	O
14	5566.8	1	878	61	O
15	5495.1	1	895	59	O
16	5647.1	1	898	59	O
17	5631.0	1	917	58	O
18	5623.9	1	938	57	O
19	5578.9	1	948	56	O
20	5570.0	1	1156	46	O
21	5647.1	1	1398	38	O
22	5570.7	1	1444	37	O
23	5529.1	1	1487	36	O
24	5584.2	1	1708	31	O
25	5541.0	1	1721	31	O
26	5497.3	1	2045	26	O
27	5490.0	1	2408	22	O
28	5571.1	1	2705	20	O
29	5494.9	1	2948	18	O
30	5527.1	1	3066	18	O
Number of Successful Detection			29 / 30		
Successful Detection (%)			96.7 %		
Result			Compliant		

Test Frequency 5570 MHz (CH 114)
 Mode 802.11ax HE160

802.11ax HE160 (5570 MHz)		RADAR TYPE 2			
Trial #	Frequency (MHz)	Pulse Width (us)	PRI (us)	Pulses	Detection (O: Yes, X: No)
1	5570.0	1.1	157	28	O
2	5624.1	1.2	218	27	O
3	5565.1	1.3	212	29	O
4	5650.0	1.4	207	26	O
5	5505.9	1.4	213	28	O
6	5493.8	1.6	181	26	O
7	5628.9	1.8	193	24	O
8	5570.1	2.1	187	23	O
9	5549.1	2.2	157	28	O
10	5556.2	2.3	194	25	O
11	5614.1	2.3	203	26	O
12	5498.0	2.3	228	25	O
13	5614.9	2.4	167	26	O
14	5630.0	2.5	203	29	X
15	5571.8	3.1	178	24	O
16	5616.1	3.3	220	29	O
17	5609.1	3.5	219	29	O
18	5581.0	3.7	187	29	O
19	5645.2	3.8	222	27	O
20	5570.0	4.4	158	24	O
21	5634.7	4.4	158	26	O
22	5632.9	4.4	181	26	O
23	5520.1	4.4	213	25	O
24	5540.2	4.5	171	27	O
25	5508.0	4.8	203	25	O
26	5490.0	4.9	164	27	O
27	5593.1	4.9	184	25	O
28	5560.0	4.9	221	28	O
29	5611.1	5	157	26	O
30	5604.9	5	191	26	O
Number of Successful Detection			29 / 30		
Successful Detection (%)			96.7 %		
Result			Compliant		

Test Frequency 5570 MHz (CH 114)
 Mode 802.11ax HE160

802.11ax HE160 (5570 MHz)		RADAR TYPE 3			
Trial #	Frequency (MHz)	Pulse Width (us)	PRI (us)	Pulses	Detection (O: Yes, X: No)
1	5543.0	6.2	439	18	X
2	5496.1	6.2	489	18	O
3	5572.2	6.3	438	18	O
4	5646.1	6.4	453	17	O
5	5497.9	6.4	454	17	O
6	5570.0	6.5	209	16	O
7	5601.0	6.5	451	18	X
8	5513.1	6.6	310	17	O
9	5586.8	6.6	423	17	O
10	5522.9	6.8	206	18	O
11	5530.0	6.8	338	16	O
12	5623.1	6.8	487	17	O
13	5647.9	7.4	372	17	O
14	5504.0	7.6	243	18	X
15	5610.0	7.6	443	17	O
16	5583.1	7.7	242	16	O
17	5650.0	7.8	375	16	O
18	5552.1	8	357	18	O
19	5493.3	8	446	18	O
20	5629.1	8.4	425	18	O
21	5598.0	9	212	18	X
22	5626.0	9	273	18	O
23	5568.9	9.3	302	17	O
24	5490.0	9.5	303	16	O
25	5522.0	9.5	419	17	O
26	5617.1	9.8	223	17	O
27	5580.2	9.8	374	16	O
28	5646.1	9.8	422	17	O
29	5572.8	9.9	442	17	O
30	5548.9	9.9	498	16	O
Number of Successful Detection			26 / 30		
Successful Detection (%)			86.7 %		
Result			Compliant		

Test Frequency 5570 MHz (CH 114)
 Mode 802.11ax HE160

802.11ax HE160 (5570 MHz)		RADAR TYPE 4			
Trial #	Frequency (MHz)	Pulse Width (us)	PRI (us)	Pulses	Detection (O: Yes, X: No)
1	5502.1	11.1	356	15	O
2	5637.2	11.1	491	16	O
3	5493.0	11.2	431	16	O
4	5507.9	11.7	361	12	O
5	5605.1	11.8	298	12	O
6	5570.0	12	478	14	O
7	5599.1	12.1	497	14	O
8	5592.0	12.4	365	16	X
9	5637.3	13.5	366	13	O
10	5490.0	13.6	455	15	O
11	5540.1	13.7	280	14	O
12	5522.0	13.8	354	15	X
13	5603.8	14.5	412	14	O
14	5534.9	14.6	356	14	O
15	5631.7	14.7	301	12	O
16	5560.0	15.2	230	13	O
17	5499.1	15.4	257	12	O
18	5520.0	15.4	498	15	O
19	5580.9	15.8	313	13	O
20	5570.0	15.8	400	12	O
21	5640.0	15.9	477	16	O
22	5632.1	16.1	287	13	O
23	5630.2	16.2	435	14	O
24	5625.2	16.4	304	13	O
25	5536.9	16.9	230	16	O
26	5650.0	17.2	379	13	O
27	5607.0	17.2	410	12	O
28	5559.1	17.5	500	13	O
29	5592.1	18.4	233	15	O
30	5582.2	19.3	213	15	O
Number of Successful Detection			28 / 30		
Successful Detection (%)			93.3 %		
Result			Compliant		

Note :

Aggregate (Radar Type 1 – 4) = (96.7 % + 96.7 % + 86.7 % + 93.3 %) / 4 = 93.3 % > 80 %

Test Frequency 5570 MHz (CH 114)
 Mode 802.11ax HE160

802.11ax HE160 (5570 MHz)		RADAR TYPE 5			
Trial #	Frequency (MHz)	Chirp Width (MHz)	Specification	Number of Detection	Detection (O:Yes, X: No)
1 (Note a)	5570.0	19	See Section 9 (Chirp 00)	2	O
2 (Note b)	5497.2	18	See Section 9 (Chirp 01)	2	O
3 (Note c)	5647.6	6	See Section 9 (Chirp 02)	1	O
4 (Note a)	5570.1	12	See Section 9 (Chirp 03)	1	O
5 (Note b)	5493.2	8	See Section 9 (Chirp 04)	1	O
6 (Note c)	5644.4	14	See Section 9 (Chirp 05)	1	O
7 (Note a)	5569.9	6	See Section 9 (Chirp 06)	1	O
8 (Note b)	5495.2	13	See Section 9 (Chirp 07)	2	O
9 (Note c)	5646.4	9	See Section 9 (Chirp 08)	2	O
10 (Note a)	5570.0	8	See Section 9 (Chirp 09)	2	O
11 (Note b)	5493.2	8	See Section 9 (Chirp 10)	1	O
12 (Note c)	5644.8	13	See Section 9 (Chirp 11)	1	O
13 (Note a)	5570.5	17	See Section 9 (Chirp 12)	1	O
14 (Note b)	5495.2	13	See Section 9 (Chirp 13)	2	O
15 (Note c)	5642.4	19	See Section 9 (Chirp 14)	1	O
16 (Note a)	5570.9	15	See Section 9 (Chirp 15)	1	O
17 (Note b)	5492.4	6	See Section 9 (Chirp 16)	1	O
18 (Note c)	5643.6	16	See Section 9 (Chirp 17)	2	O
19 (Note a)	5569.2	11	See Section 9 (Chirp 18)	2	O
20 (Note b)	5492.8	7	See Section 9 (Chirp 19)	1	O
21 (Note c)	5644.0	15	See Section 9 (Chirp 20)	2	O
22 (Note a)	5568.9	17	See Section 9 (Chirp 21)	2	O
23 (Note b)	5496.4	16	See Section 9 (Chirp 22)	1	O
24 (Note c)	5642.8	18	See Section 9 (Chirp 23)	1	O
25 (Note a)	5570.0	12	See Section 9 (Chirp 24)	1	O
26 (Note b)	5493.6	9	See Section 9 (Chirp 25)	2	O
27 (Note c)	5642.4	19	See Section 9 (Chirp 26)	2	O
28 (Note a)	5570.4	5	See Section 9 (Chirp 27)	1	O
29 (Note b)	5495.2	13	See Section 9 (Chirp 28)	2	O
30 (Note c)	5643.6	16	See Section 9 (Chirp 29)	1	O
Number of Successful Detection				30 / 30	
Successful Detection (%)				100.0 %	
Result				Compliant	

Note:

- (a) Channel center frequency
- (b) Tuned frequencies such that 90% of the Long Pulse Type 5 frequency modulation is within the low edge of the UUT Occupied Bandwidth [$FL + (0.4 * Chirp Width [in MHz])$]
- (c) Tuned frequencies such that 90% of the Long Pulse Type 5 frequency modulation is within the high edge of the UUT Occupied Bandwidth [$FH - (0.4 * Chirp Width [in MHz])$]

Test Frequency 5570 MHz (CH 114)
 Mode 802.11ax HE160

802.11ax HE160 (5570 MHz)		RADAR TYPE 6			
Trial #	Frequency (MHz)	Pulse Width (us)	PRI (us)	Pulses / Hop	Detection (O: Yes, X: No)
1	5594.1	1	333	9	O
2	5570.0	1	333	9	O
3	5650.0	1	333	9	O
4	5565.2	1	333	9	O
5	5490.1	1	333	9	O
6	5602.9	1	333	9	O
7	5613.8	1	333	9	O
8	5612.9	1	333	9	O
9	5532.1	1	333	9	O
10	5505.0	1	333	9	O
11	5519.0	1	333	9	O
12	5495.2	1	333	9	O
13	5615.3	1	333	9	O
14	5607.1	1	333	9	O
15	5501.0	1	333	9	O
16	5567.7	1	333	9	O
17	5570.1	1	333	9	O
18	5630.2	1	333	9	O
19	5507.0	1	333	9	O
20	5522.1	1	333	9	O
21	5568.9	1	333	9	O
22	5561.9	1	333	9	O
23	5540.2	1	333	9	O
24	5620.8	1	333	9	O
25	5571.1	1	333	9	O
26	5646.1	1	333	9	O
27	5535.2	1	333	9	O
28	5553.0	1	333	9	O
29	5534.8	1	333	9	O
30	5511.1	1	333	9	O
Number of Successful Detection			30 / 30		
Successful Detection (%)			100.0 %		
Result			Compliant		

Test Frequency 5250 MHz (CH 50)
 Mode 802.11ax HE160

802.11ax HE160 (5250 MHz)		RADAR TYPE 1			
Trial #	Frequency (MHz)	Pulse Width (us)	PRI (us)	Pulses	Detection (O: Yes, X: No)
1	5250.1	1	518	102	O
2	5250.0	1	538	99	O
3	5272.5	1	540	98	O
4	5250.0	1	618	86	O
5	5288.9	1	638	83	O
6	5310.9	1	658	81	O
7	5273.6	1	678	78	O
8	5325.0	1	698	76	O
9	5292.0	1	718	74	X
10	5298.8	1	758	70	O
11	5312.6	1	778	68	O
12	5278.7	1	798	67	O
13	5330.0	1	824	65	O
14	5267.0	1	878	61	O
15	5251.0	1	895	59	O
16	5297.4	1	898	59	O
17	5316.7	1	917	58	O
18	5304.0	1	938	57	O
19	5257.5	1	948	56	O
20	5326.8	1	1156	46	O
21	5297.0	1	1398	38	O
22	5282.3	1	1444	37	O
23	5250.0	1	1487	36	O
24	5307.4	1	1708	31	O
25	5256.7	1	1721	31	O
26	5278.3	1	2045	26	O
27	5329.8	1	2408	22	O
28	5327.0	1	2705	20	O
29	5290.1	1	2948	18	O
30	5311.5	1	3066	18	O
Number of Successful Detection			29 / 30		
Successful Detection (%)			96.7 %		
Result			Compliant		

Test Frequency 5250 MHz (CH 50)
 Mode 802.11ax HE160

802.11ax HE160 (5250 MHz)		RADAR TYPE 2			
Trial #	Frequency (MHz)	Pulse Width (us)	PRI (us)	Pulses	Detection (O: Yes, X: No)
1	5255.0	1.1	157	28	O
2	5250.0	1.2	218	27	O
3	5275.7	1.3	212	29	O
4	5250.0	1.4	207	26	O
5	5314.2	1.4	213	28	O
6	5310.4	1.6	181	26	O
7	5257.6	1.8	193	24	O
8	5273.4	2.1	187	23	O
9	5267.8	2.2	157	28	O
10	5317.4	2.3	194	25	O
11	5252.1	2.3	203	26	O
12	5283.1	2.3	228	25	O
13	5330.0	2.4	167	26	O
14	5315.7	2.5	203	29	O
15	5270.0	3.1	178	24	O
16	5281.6	3.3	220	29	X
17	5272.8	3.5	219	29	O
18	5316.7	3.7	187	29	O
19	5321.3	3.8	222	27	O
20	5293.4	4.4	158	24	O
21	5286.2	4.4	158	26	O
22	5311.2	4.4	181	26	X
23	5250.0	4.4	213	25	O
24	5322.5	4.5	171	27	O
25	5285.5	4.8	203	25	O
26	5264.1	4.9	164	27	O
27	5276.3	4.9	184	25	O
28	5290.8	4.9	221	28	O
29	5278.8	5	157	26	O
30	5322.8	5	191	26	O
Number of Successful Detection			28 / 30		
Successful Detection (%)			93.3 %		
Result			Compliant		

Test Frequency 5250 MHz (CH 50)
 Mode 802.11ax HE160

802.11ax HE160 (5250 MHz)		RADAR TYPE 3			
Trial #	Frequency (MHz)	Pulse Width (us)	PRI (us)	Pulses	Detection (O: Yes, X: No)
1	5322.4	6.2	439	18	X
2	5250.0	6.2	489	18	O
3	5317.5	6.3	438	18	O
4	5250.0	6.4	453	17	O
5	5272.1	6.4	454	17	O
6	5260.1	6.5	209	16	O
7	5250.0	6.5	451	18	O
8	5328.2	6.6	310	17	O
9	5303.3	6.6	423	17	O
10	5323.5	6.8	206	18	O
11	5273.2	6.8	338	16	O
12	5322.2	6.8	487	17	X
13	5330.0	7.4	372	17	O
14	5250.4	7.6	243	18	O
15	5262.3	7.6	443	17	O
16	5274.7	7.7	242	16	O
17	5274.8	7.8	375	16	O
18	5282.0	8	357	18	O
19	5265.4	8	446	18	O
20	5316.5	8.4	425	18	O
21	5275.3	9	212	18	O
22	5276.6	9	273	18	O
23	5250.0	9.3	302	17	O
24	5288.6	9.5	303	16	O
25	5285.1	9.5	419	17	O
26	5266.8	9.8	223	17	O
27	5316.9	9.8	374	16	O
28	5274.3	9.8	422	17	O
29	5293.8	9.9	442	17	X
30	5266.0	9.9	498	16	O
Number of Successful Detection			27 / 30		
Successful Detection (%)			90.0 %		
Result			Compliant		

Test Frequency 5250 MHz (CH 50)
 Mode 802.11ax HE160

802.11ax HE160 (5250 MHz)		RADAR TYPE 4			
Trial #	Frequency (MHz)	Pulse Width (us)	PRI (us)	Pulses	Detection (O: Yes, X: No)
1	5286.1	11.1	356	15	O
2	5250.0	11.1	491	16	O
3	5252.6	11.2	431	16	O
4	5250.0	11.7	361	12	O
5	5252.7	11.8	298	12	O
6	5292.0	12	478	14	O
7	5258.6	12.1	497	14	O
8	5283.8	12.4	365	16	O
9	5287.6	13.5	366	13	O
10	5293.6	13.6	455	15	O
11	5283.1	13.7	280	14	O
12	5318.4	13.8	354	15	O
13	5330.0	14.5	412	14	O
14	5256.3	14.6	356	14	O
15	5295.7	14.7	301	12	O
16	5275.2	15.2	230	13	O
17	5302.5	15.4	257	12	O
18	5291.6	15.4	498	15	O
19	5250.2	15.8	313	13	O
20	5251.7	15.8	400	12	O
21	5269.9	15.9	477	16	O
22	5270.8	16.1	287	13	O
23	5250.0	16.2	435	14	O
24	5304.4	16.4	304	13	O
25	5291.7	16.9	230	16	O
26	5277.5	17.2	379	13	O
27	5329.6	17.2	410	12	X
28	5313.6	17.5	500	13	O
29	5263.7	18.4	233	15	O
30	5326.2	19.3	213	15	O
Number of Successful Detection			29 / 30		
Successful Detection (%)			96.7 %		
Result			Compliant		

Note :

Aggregate (Radar Type 1 – 4) = (96.7 % + 96.7 % + 86.7 % + 93.3 %) / 4 = 93.3 % > 80 %

Test Frequency 5250 MHz (CH 50)
 Mode 802.11ax HE160

802.11ax HE160 (5250 MHz)		RADAR TYPE 5			
Trial #	Frequency (MHz)	Chirp Width (MHz)	Specification	Number of Detection	Detection (O:Yes, X: No)
1 (Note a)	5290.0	19	See Section 9 (Chirp 00)	2	O
2 (Note b)	5257.2	18	See Section 9 (Chirp 01)	2	O
3 (Note c)	5327.6	6	See Section 9 (Chirp 02)	1	O
4 (Note a)	5290.1	12	See Section 9 (Chirp 03)	2	O
5 (Note b)	5253.2	8	See Section 9 (Chirp 04)	1	O
6 (Note c)	5324.4	14	See Section 9 (Chirp 05)	2	O
7 (Note a)	5289.9	6	See Section 9 (Chirp 06)	2	O
8 (Note b)	5255.2	13	See Section 9 (Chirp 07)	1	O
9 (Note c)	5326.4	9	See Section 9 (Chirp 08)	2	O
10 (Note a)	5290.0	8	See Section 9 (Chirp 09)	2	O
11 (Note b)	5253.2	8	See Section 9 (Chirp 10)	2	O
12 (Note c)	5324.8	13	See Section 9 (Chirp 11)	2	O
13 (Note a)	5290.5	17	See Section 9 (Chirp 12)	2	O
14 (Note b)	5255.2	13	See Section 9 (Chirp 13)	2	O
15 (Note c)	5322.4	19	See Section 9 (Chirp 14)	1	O
16 (Note a)	5290.9	15	See Section 9 (Chirp 15)	2	O
17 (Note b)	5252.4	6	See Section 9 (Chirp 16)	2	O
18 (Note c)	5323.6	16	See Section 9 (Chirp 17)	2	O
19 (Note a)	5289.2	11	See Section 9 (Chirp 18)	1	O
20 (Note b)	5252.8	7	See Section 9 (Chirp 19)	1	O
21 (Note c)	5324.0	15	See Section 9 (Chirp 20)	2	O
22 (Note a)	5288.9	17	See Section 9 (Chirp 21)	2	O
23 (Note b)	5256.4	16	See Section 9 (Chirp 22)	1	O
24 (Note c)	5322.8	18	See Section 9 (Chirp 23)	1	O
25 (Note a)	5290.0	12	See Section 9 (Chirp 24)	2	O
26 (Note b)	5253.6	9	See Section 9 (Chirp 25)	2	O
27 (Note c)	5322.4	19	See Section 9 (Chirp 26)	2	O
28 (Note a)	5290.4	5	See Section 9 (Chirp 27)	1	O
29 (Note b)	5255.2	13	See Section 9 (Chirp 28)	2	O
30 (Note c)	5323.6	16	See Section 9 (Chirp 29)	1	O
Number of Successful Detection				30 / 30	
Successful Detection (%)				100.0 %	
Result				Compliant	

Note:

- (a) Channel center frequency
- (b) Tuned frequencies such that 90% of the Long Pulse Type 5 frequency modulation is within the low edge of the UUT Occupied Bandwidth [$FL + (0.4 * Chirp\ Width\ [in\ MHz])$]
- (c) Tuned frequencies such that 90% of the Long Pulse Type 5 frequency modulation is within the high edge of the UUT Occupied Bandwidth [$FH - (0.4 * Chirp\ Width\ [in\ MHz])$]

Test Frequency 5250 MHz (CH 50)
 Mode 802.11ax HE160

802.11ax HE160 (5250 MHz)		RADAR TYPE 6			
Trial #	Frequency (MHz)	Pulse Width (us)	PRI (us)	Pulses / Hop	Detection (O: Yes, X: No)
1	5304.2	1	333	9	O
2	5250.0	1	333	9	O
3	5287.0	1	333	9	O
4	5250.0	1	333	9	O
5	5326.7	1	333	9	O
6	5252.1	1	333	9	O
7	5282.7	1	333	9	O
8	5257.0	1	333	9	O
9	5311.3	1	333	9	O
10	5250.5	1	333	9	O
11	5326.3	1	333	9	O
12	5301.9	1	333	9	O
13	5330.0	1	333	9	O
14	5283.9	1	333	9	O
15	5294.3	1	333	9	O
16	5322.5	1	333	9	O
17	5298.5	1	333	9	O
18	5267.5	1	333	9	O
19	5302.7	1	333	9	O
20	5315.0	1	333	9	O
21	5294.4	1	333	9	O
22	5277.4	1	333	9	O
23	5250.0	1	333	9	O
24	5281.7	1	333	9	O
25	5322.4	1	333	9	O
26	5290.8	1	333	9	O
27	5256.2	1	333	9	O
28	5300.1	1	333	9	O
29	5308.3	1	333	9	O
30	5255.5	1	333	9	O
Number of Successful Detection			30 / 30		
Successful Detection (%)			100.0 %		
Result			Compliant		

9. LIST OF TEST EQUIPMENT

Chirp 00		Number of Burst Segment = 19 Total Burst Segment Length = 631578 us						
Burst Segment	No of Pulse	Chirp Width (MHz)	T1 (us)	Pulse Width (us)	T3 (us)	T4 (us)	T5 (us)	Total Length (us)
1	2	19	232711	55	1780	0	396977	631578
2	1	19	498711	54	0	0	132813	631578
3	3	19	407701	84	1254	1691	220680	631578
4	3	19	187630	77	1228	1092	441397	631578
5	1	19	524472	53	0	0	107053	631578
6	2	19	73627	66	1567	0	556252	631578
7	1	19	593441	73	0	0	38064	631578
8	1	19	269687	97	0	0	361794	631578
9	1	19	586139	75	0	0	45364	631578
10	1	19	613840	60	0	0	17678	631578
11	3	19	474686	91	1101	1341	154177	631578
12	3	19	565339	75	1597	1313	63104	631578
13	3	19	626831	50	1567	1591	1439	631578
14	2	19	233928	86	971	0	396507	631578
15	1	19	453451	74	0	0	178053	631578
16	2	19	453824	88	1060	0	176518	631578
17	3	19	453329	63	1125	1206	175729	631578
18	3	19	309437	67	1266	1401	319273	631578
19	1	19	47775	82	0	0	583721	631578

- >> Back to Result of Chirped Radar Detection (5500 MHz)
- >> Back to Result of Chirped Radar Detection (5510 MHz)
- >> Back to Result of Chirped Radar Detection (5530 MHz)
- >> Back to Result of Chirped Radar Detection (5570 MHz)
- >> Back to Result of Chirped Radar Detection (5250 MHz)

Chirp 01		Number of Burst Segment = 18 Total Burst Segment Length = 666666 us						
Burst Segment	No of Pulse	Chirp Width (MHz)	T1 (us)	Pulse Width (us)	T3 (us)	T4 (us)	T5 (us)	Total Length (us)
1	3	18	615638	87	1019	1486	48262	666666
2	2	18	390832	65	1364	0	274340	666666
3	3	18	327922	94	1750	912	335800	666666
4	3	18	23148	72	1365	1212	640725	666666
5	3	18	118817	62	1421	1056	545186	666666
6	1	18	189125	84	0	0	477457	666666
7	1	18	312057	75	0	0	354534	666666
8	1	18	374431	100	0	0	292135	666666
9	2	18	170365	76	1913	0	494236	666666
10	1	18	177943	61	0	0	488662	666666
11	2	18	312432	92	1509	0	352541	666666
12	3	18	321908	97	1231	1742	341494	666666
13	1	18	240566	83	0	0	426017	666666
14	1	18	383259	97	0	0	283310	666666
15	2	18	310404	81	1847	0	354253	666666
16	1	18	84678	58	0	0	581930	666666
17	3	18	187114	56	1683	1834	475867	666666
18	2	18	124016	99	1896	0	540556	666666

- >> Back to Result of Chirped Radar Detection (5500 MHz)
- >> Back to Result of Chirped Radar Detection (5510 MHz)
- >> Back to Result of Chirped Radar Detection (5530 MHz)
- >> Back to Result of Chirped Radar Detection (5570 MHz)
- >> Back to Result of Chirped Radar Detection (5250 MHz)

Chirp 02		Number of Burst Segment = 11 Total Burst Segment Length = 1090909 us						
Burst Segment	No of Pulse	Chirp Width (MHz)	T1 (us)	Pulse Width (us)	T3 (us)	T4 (us)	T5 (us)	Total Length (us)
1	3	6	705075	67	1350	1816	382467	1090909
2	1	6	380623	59	0	0	710227	1090909
3	2	6	883218	85	1371	0	206150	1090909
4	3	6	41311	97	1540	1702	1046065	1090909
5	2	6	1057369	66	1649	0	31759	1090909
6	1	6	988117	70	0	0	102722	1090909
7	2	6	704703	87	1873	0	384159	1090909
8	3	6	437998	93	1398	1770	649464	1090909
9	1	6	626136	63	0	0	464710	1090909
10	1	6	1050207	80	0	0	40622	1090909
11	2	6	788939	64	1837	0	300005	1090909

Chirp 03		Number of Burst Segment = 13 Total Burst Segment Length = 923076 us						
Burst Segment	No of Pulse	Chirp Width (MHz)	T1 (us)	Pulse Width (us)	T3 (us)	T4 (us)	T5 (us)	Total Length (us)
1	1	12	875936	51	0	0	47089	923076
2	2	12	567633	92	1848	0	353411	923076
3	3	12	869557	77	1015	1593	50680	923076
4	2	12	340276	70	1847	0	580813	923076
5	2	12	181107	83	1501	0	740302	923076
6	2	12	615443	70	1333	0	306160	923076
7	1	12	408465	82	0	0	514529	923076
8	2	12	64551	87	1338	0	857013	923076
9	2	12	158940	99	1339	0	762599	923076
10	3	12	847765	50	951	1812	72398	923076
11	3	12	554331	50	1814	1155	365626	923076
12	2	12	42321	82	1111	0	879480	923076
13	1	12	228725	88	0	0	694263	923076

- >> Back to Result of Chirped Radar Detection (5500 MHz)
- >> Back to Result of Chirped Radar Detection (5510 MHz)
- >> Back to Result of Chirped Radar Detection (5530 MHz)
- >> Back to Result of Chirped Radar Detection (5570 MHz)
- >> Back to Result of Chirped Radar Detection (5250 MHz)

Chirp 04		Number of Burst Segment = 9 Total Burst Segment Length = 1333333 us						
Burst Segment	No of Pulse	Chirp Width (MHz)	T1 (us)	Pulse Width (us)	T3 (us)	T4 (us)	T5 (us)	Total Length (us)
1	3	8	775447	95	1540	1186	554875	1333333
2	1	8	268416	75	0	0	1064842	1333333
3	1	8	29730	55	0	0	1303548	1333333
4	1	8	97820	99	0	0	1235414	1333333
5	1	8	477942	61	0	0	855330	1333333
6	2	8	428277	90	1573	0	903303	1333333
7	2	8	86897	77	1120	0	1245162	1333333
8	2	8	491580	100	1149	0	840404	1333333
9	2	8	309316	83	1740	0	1022111	1333333

Chirp 05		Number of Burst Segment = 17 Total Burst Segment Length = 705882 us						
Burst Segment	No of Pulse	Chirp Width (MHz)	T1 (us)	Pulse Width (us)	T3 (us)	T4 (us)	T5 (us)	Total Length (us)
1	1	14	515092	52	0	0	190738	705882
2	2	14	474467	84	1340	0	229907	705882
3	3	14	457874	88	1095	1217	245432	705882
4	2	14	612879	99	1724	0	91081	705882
5	1	14	337698	73	0	0	368111	705882
6	3	14	151821	64	1292	1374	551203	705882
7	1	14	175379	60	0	0	530443	705882
8	3	14	45594	81	1369	1119	657557	705882
9	1	14	675757	75	0	0	30050	705882
10	1	14	77174	82	0	0	628626	705882
11	1	14	457393	62	0	0	248427	705882
12	3	14	550165	90	924	1670	152853	705882
13	2	14	443862	64	1483	0	260409	705882
14	2	14	565441	68	1686	0	138619	705882
15	1	14	437704	96	0	0	268082	705882
16	2	14	123674	63	1407	0	580675	705882
17	3	14	169003	62	1237	1921	533535	705882

- >> Back to Result of Chirped Radar Detection (5500 MHz)
- >> Back to Result of Chirped Radar Detection (5510 MHz)
- >> Back to Result of Chirped Radar Detection (5530 MHz)
- >> Back to Result of Chirped Radar Detection (5570 MHz)
- >> Back to Result of Chirped Radar Detection (5250 MHz)

Chirp 06		Number of Burst Segment = 13 Total Burst Segment Length = 923076 us						
Burst Segment	No of Pulse	Chirp Width (MHz)	T1 (us)	Pulse Width (us)	T3 (us)	T4 (us)	T5 (us)	Total Length (us)
1	1	6	223281	83	0	0	699712	923076
2	1	6	221663	67	0	0	701346	923076
3	1	6	517216	79	0	0	405781	923076
4	2	6	714486	73	1294	0	207150	923076
5	3	6	767579	64	1934	953	152418	923076
6	1	6	211432	72	0	0	711572	923076
7	1	6	106046	77	0	0	816953	923076
8	3	6	426961	83	979	1724	493163	923076
9	2	6	355140	51	1468	0	566366	923076
10	2	6	357704	64	1826	0	563418	923076
11	1	6	474169	51	0	0	448856	923076
12	2	6	180998	86	1269	0	740637	923076
13	1	6	641621	96	0	0	281359	923076

Chirp 07		Number of Burst Segment = 10 Total Burst Segment Length = 1200000 us						
Burst Segment	No of Pulse	Chirp Width (MHz)	T1 (us)	Pulse Width (us)	T3 (us)	T4 (us)	T5 (us)	Total Length (us)
1	1	13	178411	64	0	0	1021525	1200000
2	3	13	134361	98	1737	1868	1061740	1200000
3	1	13	817334	64	0	0	382602	1200000
4	1	13	129176	73	0	0	1070751	1200000
5	1	13	1124149	70	0	0	75781	1200000
6	3	13	728601	71	1616	1325	468245	1200000
7	3	13	623107	90	1708	1831	573084	1200000
8	3	13	1145848	67	990	1871	51090	1200000
9	3	13	1056851	62	1150	1153	140660	1200000
10	2	13	373522	72	1453	0	824881	1200000

- >> Back to Result of Chirped Radar Detection (5500 MHz)
- >> Back to Result of Chirped Radar Detection (5510 MHz)
- >> Back to Result of Chirped Radar Detection (5530 MHz)
- >> Back to Result of Chirped Radar Detection (5570 MHz)
- >> Back to Result of Chirped Radar Detection (5250 MHz)

Chirp 08		Number of Burst Segment = 18 Total Burst Segment Length = 666666 us						
Burst Segment	No of Pulse	Chirp Width (MHz)	T1 (us)	Pulse Width (us)	T3 (us)	T4 (us)	T5 (us)	Total Length (us)
1	1	9	224162	67	0	0	442437	666666
2	1	9	194319	80	0	0	472267	666666
3	3	9	347805	56	1866	1223	315604	666666
4	1	9	382056	82	0	0	284528	666666
5	2	9	208685	56	969	0	456900	666666
6	1	9	46540	88	0	0	620038	666666
7	2	9	143186	86	1240	0	522068	666666
8	3	9	359997	93	1417	1254	303719	666666
9	3	9	452882	69	1551	1278	210748	666666
10	2	9	611825	73	1784	0	52911	666666
11	2	9	10530	77	1860	0	654122	666666
12	3	9	426069	66	1026	1503	237870	666666
13	2	9	140555	73	1340	0	524625	666666
14	1	9	127657	50	0	0	538959	666666
15	3	9	467966	81	929	1768	195760	666666
16	2	9	251956	64	1710	0	412872	666666
17	2	9	196598	57	1482	0	468472	666666
18	3	9	260935	95	1576	1074	402796	666666

Chirp 09		Number of Burst Segment = 19 Total Burst Segment Length = 631578 us						
Burst Segment	No of Pulse	Chirp Width (MHz)	T1 (us)	Pulse Width (us)	T3 (us)	T4 (us)	T5 (us)	Total Length (us)
1	1	8	28877	66	0	0	602635	631578
2	3	8	612599	56	1270	1151	16390	631578
3	3	8	381282	56	1624	1287	247217	631578
4	1	8	520458	50	0	0	111070	631578
5	2	8	600210	50	1165	0	30103	631578
6	1	8	402193	58	0	0	229327	631578
7	1	8	349191	59	0	0	282328	631578
8	1	8	404699	88	0	0	226791	631578
9	3	8	499221	62	1756	1086	129329	631578
10	1	8	367165	67	0	0	264346	631578
11	1	8	239185	86	0	0	392307	631578
12	1	8	558207	66	0	0	73305	631578
13	1	8	508950	86	0	0	122542	631578
14	3	8	138618	57	1832	1014	489943	631578
15	1	8	588701	59	0	0	42818	631578
16	3	8	515462	99	1594	1657	112568	631578
17	2	8	209864	52	1404	0	420206	631578
18	1	8	544111	95	0	0	87372	631578
19	1	8	61836	91	0	0	569651	631578

- >> Back to Result of Chirped Radar Detection (5500 MHz)
- >> Back to Result of Chirped Radar Detection (5510 MHz)
- >> Back to Result of Chirped Radar Detection (5530 MHz)
- >> Back to Result of Chirped Radar Detection (5570 MHz)
- >> Back to Result of Chirped Radar Detection (5250 MHz)

Chirp 10		Number of Burst Segment = 16 Total Burst Segment Length = 750000 us						
Burst Segment	No of Pulse	Chirp Width (MHz)	T1 (us)	Pulse Width (us)	T3 (us)	T4 (us)	T5 (us)	Total Length (us)
1	2	8	536388	64	1773	0	211711	750000
2	3	8	278082	64	1323	1518	468885	750000
3	2	8	426238	56	1807	0	321843	750000
4	2	8	161531	54	1587	0	586774	750000
5	3	8	142165	54	1603	1772	604298	750000
6	1	8	584178	66	0	0	165756	750000
7	3	8	456303	89	1276	1758	290396	750000
8	1	8	177048	52	0	0	572900	750000
9	3	8	160686	89	1789	1252	586006	750000
10	1	8	229525	85	0	0	520390	750000
11	1	8	712260	72	0	0	37668	750000
12	3	8	598120	80	1684	1458	148498	750000
13	1	8	739455	99	0	0	10446	750000
14	1	8	312730	100	0	0	437170	750000
15	1	8	382902	56	0	0	367042	750000
16	3	8	549380	98	1401	924	198001	750000

Chirp 11		Number of Burst Segment = 17 Total Burst Segment Length = 705882 us						
Burst Segment	No of Pulse	Chirp Width (MHz)	T1 (us)	Pulse Width (us)	T3 (us)	T4 (us)	T5 (us)	Total Length (us)
1	1	13	523285	81	0	0	182516	705882
2	3	13	555472	60	1239	940	148051	705882
3	2	13	522470	67	1585	0	181693	705882
4	1	13	130800	70	0	0	575012	705882
5	1	13	397830	62	0	0	307990	705882
6	2	13	21864	82	1052	0	682802	705882
7	1	13	375365	70	0	0	330447	705882
8	3	13	136152	92	1185	1000	567269	705882
9	1	13	485098	72	0	0	220712	705882
10	2	13	15414	92	1876	0	688408	705882
11	3	13	137933	80	1843	1899	563967	705882
12	2	13	357057	82	1684	0	346977	705882
13	3	13	180177	55	1698	1666	522176	705882
14	2	13	258061	55	1074	0	446637	705882
15	1	13	232964	69	0	0	472849	705882
16	1	13	330706	73	0	0	375103	705882
17	3	13	149692	85	1116	982	553837	705882

- >> Back to Result of Chirped Radar Detection (5500 MHz)
- >> Back to Result of Chirped Radar Detection (5510 MHz)
- >> Back to Result of Chirped Radar Detection (5530 MHz)
- >> Back to Result of Chirped Radar Detection (5570 MHz)
- >> Back to Result of Chirped Radar Detection (5250 MHz)

Chirp 12		Number of Burst Segment = 8 Total Burst Segment Length = 1500000 us						
Burst Segment	No of Pulse	Chirp Width (MHz)	T1 (us)	Pulse Width (us)	T3 (us)	T4 (us)	T5 (us)	Total Length (us)
1	2	17	731938	61	1140	0	766800	1500000
2	3	17	621640	85	1569	1853	874683	1500000
3	2	17	1239794	82	942	0	259100	1500000
4	3	17	1234591	76	1296	1861	262024	1500000
5	1	17	124955	78	0	0	1374967	1500000
6	3	17	205930	79	1613	1422	1290798	1500000
7	2	17	620374	62	1437	0	878065	1500000
8	2	17	249392	78	1374	0	1249078	1500000

Chirp 13		Number of Burst Segment = 14 Total Burst Segment Length = 857142 us						
Burst Segment	No of Pulse	Chirp Width (MHz)	T1 (us)	Pulse Width (us)	T3 (us)	T4 (us)	T5 (us)	Total Length (us)
1	2	13	347677	89	1401	0	507886	857142
2	2	13	675890	71	1575	0	179535	857142
3	3	13	169922	61	1569	1681	683787	857142
4	1	13	207543	63	0	0	649536	857142
5	3	13	543757	75	1598	1740	309822	857142
6	2	13	213614	100	1732	0	641596	857142
7	2	13	15540	72	929	0	840529	857142
8	1	13	566269	79	0	0	290794	857142
9	1	13	730558	100	0	0	126484	857142
10	1	13	790968	67	0	0	66107	857142
11	1	13	102749	83	0	0	754310	857142
12	3	13	608434	50	1223	1458	245877	857142
13	1	13	128107	58	0	0	728977	857142
14	2	13	422242	84	1872	0	432860	857142

- >> Back to Result of Chirped Radar Detection (5500 MHz)
- >> Back to Result of Chirped Radar Detection (5510 MHz)
- >> Back to Result of Chirped Radar Detection (5530 MHz)
- >> Back to Result of Chirped Radar Detection (5570 MHz)
- >> Back to Result of Chirped Radar Detection (5250 MHz)

Chirp 14		Number of Burst Segment = 17 Total Burst Segment Length = 705882 us						
Burst Segment	No of Pulse	Chirp Width (MHz)	T1 (us)	Pulse Width (us)	T3 (us)	T4 (us)	T5 (us)	Total Length (us)
1	1	19	464574	89	0	0	241219	705882
2	1	19	699146	53	0	0	6683	705882
3	2	19	461891	89	1502	0	242311	705882
4	3	19	67280	77	1132	1396	635843	705882
5	3	19	488827	98	1316	920	214525	705882
6	3	19	377800	75	1640	1249	324968	705882
7	2	19	480545	63	1789	0	223422	705882
8	2	19	349601	81	1086	0	355033	705882
9	1	19	273980	92	0	0	431810	705882
10	3	19	334428	89	917	1575	368695	705882
11	1	19	435402	71	0	0	270409	705882
12	2	19	493465	58	1789	0	210512	705882
13	1	19	499971	71	0	0	205840	705882
14	2	19	36294	74	939	0	668501	705882
15	2	19	436086	53	1281	0	268409	705882
16	3	19	116822	87	1706	1002	586091	705882
17	1	19	28909	90	0	0	676883	705882

Chirp 15		Number of Burst Segment = 9 Total Burst Segment Length = 1333333 us						
Burst Segment	No of Pulse	Chirp Width (MHz)	T1 (us)	Pulse Width (us)	T3 (us)	T4 (us)	T5 (us)	Total Length (us)
1	3	15	470874	61	1133	1346	859797	1333333
2	1	15	113069	92	0	0	1220172	1333333
3	1	15	483299	90	0	0	849944	1333333
4	2	15	338219	78	1720	0	993238	1333333
5	3	15	54496	53	1638	1430	1275610	1333333
6	2	15	196155	66	1276	0	1135770	1333333
7	1	15	911055	97	0	0	422181	1333333
8	3	15	178388	62	1515	1675	1151569	1333333
9	3	15	683965	53	1293	1145	646771	1333333

- >> Back to Result of Chirped Radar Detection (5500 MHz)
- >> Back to Result of Chirped Radar Detection (5510 MHz)
- >> Back to Result of Chirped Radar Detection (5530 MHz)
- >> Back to Result of Chirped Radar Detection (5570 MHz)
- >> Back to Result of Chirped Radar Detection (5250 MHz)

Chirp 16		Number of Burst Segment = 9 Total Burst Segment Length = 1333333 us						
Burst Segment	No of Pulse	Chirp Width (MHz)	T1 (us)	Pulse Width (us)	T3 (us)	T4 (us)	T5 (us)	Total Length (us)
1	3	6	730517	61	1362	1908	599363	1333333
2	1	6	217632	62	0	0	1115639	1333333
3	3	6	147776	92	1358	1874	1182049	1333333
4	2	6	513183	53	1241	0	818803	1333333
5	3	6	713304	52	1081	1364	617428	1333333
6	3	6	303884	92	1429	956	1026788	1333333
7	3	6	268916	75	1377	980	1061835	1333333
8	3	6	1213733	79	1611	1738	116014	1333333
9	2	6	48589	90	1801	0	1282763	1333333

Chirp 17		Number of Burst Segment = 18 Total Burst Segment Length = 666666 us						
Burst Segment	No of Pulse	Chirp Width (MHz)	T1 (us)	Pulse Width (us)	T3 (us)	T4 (us)	T5 (us)	Total Length (us)
1	1	16	407421	90	0	0	259155	666666
2	2	16	516157	79	1576	0	148775	666666
3	3	16	468751	65	1402	936	195382	666666
4	1	16	392532	66	0	0	274068	666666
5	2	16	313085	75	953	0	352478	666666
6	3	16	18247	77	1703	1171	645314	666666
7	2	16	254070	94	1165	0	411243	666666
8	1	16	104226	54	0	0	562386	666666
9	1	16	564457	82	0	0	102127	666666
10	3	16	432558	51	1859	1373	230723	666666
11	1	16	327219	86	0	0	339361	666666
12	3	16	286060	87	1850	1777	376718	666666
13	2	16	194576	66	1841	0	470117	666666
14	3	16	208890	78	1025	1069	455448	666666
15	2	16	470929	79	1004	0	194575	666666
16	2	16	144252	70	1860	0	520414	666666
17	1	16	42773	96	0	0	623797	666666
18	2	16	357806	76	1480	0	307228	666666

- >> Back to Result of Chirped Radar Detection (5500 MHz)
- >> Back to Result of Chirped Radar Detection (5510 MHz)
- >> Back to Result of Chirped Radar Detection (5530 MHz)
- >> Back to Result of Chirped Radar Detection (5570 MHz)
- >> Back to Result of Chirped Radar Detection (5250 MHz)

Chirp 18		Number of Burst Segment = 8 Total Burst Segment Length = 1500000 us						
Burst Segment	No of Pulse	Chirp Width (MHz)	T1 (us)	Pulse Width (us)	T3 (us)	T4 (us)	T5 (us)	Total Length (us)
1	2	11	53769	98	953	0	1445082	1500000
2	2	11	654725	54	1625	0	843542	1500000
3	3	11	439711	52	1072	1750	1057311	1500000
4	2	11	731640	77	1623	0	766583	1500000
5	2	11	1415454	66	1274	0	83140	1500000
6	3	11	635733	66	1495	1461	861113	1500000
7	1	11	31028	90	0	0	1468882	1500000
8	3	11	728657	89	1279	1127	768670	1500000

Chirp 19		Number of Burst Segment = 10 Total Burst Segment Length = 1200000 us						
Burst Segment	No of Pulse	Chirp Width (MHz)	T1 (us)	Pulse Width (us)	T3 (us)	T4 (us)	T5 (us)	Total Length (us)
1	1	7	47901	64	0	0	1152035	1200000
2	2	7	748966	70	1200	0	449694	1200000
3	2	7	20114	91	1324	0	1178380	1200000
4	2	7	43499	76	1635	0	1154714	1200000
5	1	7	883710	60	0	0	316230	1200000
6	2	7	587442	82	1551	0	610843	1200000
7	2	7	1054306	54	1003	0	144583	1200000
8	2	7	906174	91	1199	0	292445	1200000
9	2	7	466829	91	1232	0	731757	1200000
10	2	7	997868	60	1380	0	200632	1200000

- >> Back to Result of Chirped Radar Detection (5500 MHz)
- >> Back to Result of Chirped Radar Detection (5510 MHz)
- >> Back to Result of Chirped Radar Detection (5530 MHz)
- >> Back to Result of Chirped Radar Detection (5570 MHz)
- >> Back to Result of Chirped Radar Detection (5250 MHz)

Chirp 20		Number of Burst Segment = 20 Total Burst Segment Length = 600000 us						
Burst Segment	No of Pulse	Chirp Width (MHz)	T1 (us)	Pulse Width (us)	T3 (us)	T4 (us)	T5 (us)	Total Length (us)
1	1	15	453442	100	0	0	146458	600000
2	1	15	395778	70	0	0	204152	600000
3	1	15	556757	65	0	0	43178	600000
4	3	15	338156	57	1422	998	259253	600000
5	2	15	569313	80	1690	0	28837	600000
6	2	15	489738	76	1779	0	108331	600000
7	1	15	497920	52	0	0	102028	600000
8	1	15	81946	52	0	0	518002	600000
9	1	15	381115	92	0	0	218793	600000
10	2	15	328758	90	1668	0	269394	600000
11	2	15	407110	87	1310	0	191406	600000
12	2	15	525725	80	1026	0	73089	600000
13	2	15	450258	80	1026	0	148556	600000
14	3	15	291394	94	1905	1346	305073	600000
15	2	15	163360	70	1750	0	434750	600000
16	3	15	364599	86	1195	1112	232836	600000
17	1	15	60898	60	0	0	539042	600000
18	1	15	407152	89	0	0	192759	600000
19	1	15	520342	50	0	0	79608	600000
20	3	15	549205	68	1203	969	48419	600000

Chirp 21		Number of Burst Segment = 10 Total Burst Segment Length = 1200000 us						
Burst Segment	No of Pulse	Chirp Width (MHz)	T1 (us)	Pulse Width (us)	T3 (us)	T4 (us)	T5 (us)	Total Length (us)
1	2	17	713850	87	1382	0	484594	1200000
2	3	17	166523	53	1577	975	1030766	1200000
3	1	17	1018474	50	0	0	181476	1200000
4	1	17	512737	91	0	0	687172	1200000
5	1	17	274492	52	0	0	925456	1200000
6	1	17	756940	79	0	0	442981	1200000
7	1	17	921031	87	0	0	278882	1200000
8	2	17	1175271	55	1341	0	23278	1200000
9	1	17	592147	69	0	0	607784	1200000
10	3	17	57605	97	975	1602	1139527	1200000

- >> Back to Result of Chirped Radar Detection (5500 MHz)
- >> Back to Result of Chirped Radar Detection (5510 MHz)
- >> Back to Result of Chirped Radar Detection (5530 MHz)
- >> Back to Result of Chirped Radar Detection (5570 MHz)
- >> Back to Result of Chirped Radar Detection (5250 MHz)

Chirp 22		Number of Burst Segment = 18 Total Burst Segment Length = 666666 us						
Burst Segment	No of Pulse	Chirp Width (MHz)	T1 (us)	Pulse Width (us)	T3 (us)	T4 (us)	T5 (us)	Total Length (us)
1	1	16	407421	90	0	0	259155	666666
2	2	16	516157	79	1576	0	148775	666666
3	3	16	468751	65	1402	936	195382	666666
4	1	16	392532	66	0	0	274068	666666
5	2	16	313085	75	953	0	352478	666666
6	3	16	18247	77	1703	1171	645314	666666
7	2	16	254070	94	1165	0	411243	666666
8	1	16	104226	54	0	0	562386	666666
9	1	16	564457	82	0	0	102127	666666
10	3	16	432558	51	1859	1373	230723	666666
11	1	16	327219	86	0	0	339361	666666
12	3	16	286060	87	1850	1777	376718	666666
13	2	16	194576	66	1841	0	470117	666666
14	3	16	208890	78	1025	1069	455448	666666
15	2	16	470929	79	1004	0	194575	666666
16	2	16	144252	70	1860	0	520414	666666
17	1	16	42773	96	0	0	623797	666666
18	2	16	357806	76	1480	0	307228	666666

Chirp 23		Number of Burst Segment = 18 Total Burst Segment Length = 666666 us						
Burst Segment	No of Pulse	Chirp Width (MHz)	T1 (us)	Pulse Width (us)	T3 (us)	T4 (us)	T5 (us)	Total Length (us)
1	1	18	185757	55	0	0	480854	666666
2	2	18	365314	58	1851	0	299385	666666
3	2	18	334200	85	1423	0	330873	666666
4	2	18	516372	93	1544	0	148564	666666
5	2	18	3000	57	1239	0	662313	666666
6	3	18	430670	99	1599	1567	232533	666666
7	3	18	604093	88	1513	1117	59679	666666
8	1	18	252776	55	0	0	413835	666666
9	1	18	130627	59	0	0	535980	666666
10	1	18	22243	65	0	0	644358	666666
11	1	18	145306	92	0	0	521268	666666
12	1	18	591776	71	0	0	74819	666666
13	2	18	569401	83	1450	0	95649	666666
14	1	18	622026	65	0	0	44575	666666
15	2	18	583302	52	1025	0	82235	666666
16	2	18	492513	72	1557	0	172452	666666
17	2	18	330464	65	1279	0	334793	666666
18	2	18	119658	70	1053	0	545815	666666

- >> Back to Result of Chirped Radar Detection (5500 MHz)
- >> Back to Result of Chirped Radar Detection (5510 MHz)
- >> Back to Result of Chirped Radar Detection (5530 MHz)
- >> Back to Result of Chirped Radar Detection (5570 MHz)
- >> Back to Result of Chirped Radar Detection (5250 MHz)

Chirp 24		Number of Burst Segment = 16 Total Burst Segment Length = 750000 us						
Burst Segment	No of Pulse	Chirp Width (MHz)	T1 (us)	Pulse Width (us)	T3 (us)	T4 (us)	T5 (us)	Total Length (us)
1	3	12	131712	67	1039	1125	615923	750000
2	2	12	582165	89	1192	0	166465	750000
3	1	12	162341	59	0	0	587600	750000
4	3	12	529681	59	1551	1219	217372	750000
5	2	12	644360	62	1250	0	104266	750000
6	2	12	521505	84	1209	0	227118	750000
7	2	12	695980	94	1621	0	52211	750000
8	2	12	647494	68	1413	0	100957	750000
9	2	12	618408	65	1900	0	129562	750000
10	1	12	445293	94	0	0	304613	750000
11	1	12	494977	52	0	0	254971	750000
12	2	12	420962	77	1114	0	327770	750000
13	1	12	155669	95	0	0	594236	750000
14	3	12	433513	90	1837	1266	313114	750000
15	1	12	610164	83	0	0	139753	750000
16	2	12	37845	83	1527	0	710462	750000

Chirp 25		Number of Burst Segment = 12 Total Burst Segment Length = 1000000 us						
Burst Segment	No of Pulse	Chirp Width (MHz)	T1 (us)	Pulse Width (us)	T3 (us)	T4 (us)	T5 (us)	Total Length (us)
1	3	9	876940	86	1265	1244	120293	1000000
2	2	9	467410	73	1425	0	531019	1000000
3	2	9	965189	60	1747	0	32944	1000000
4	1	9	505333	88	0	0	494579	1000000
5	3	9	800745	86	1742	1637	195618	1000000
6	2	9	832875	78	1431	0	165538	1000000
7	1	9	13140	65	0	0	986795	1000000
8	3	9	699984	60	1924	1000	296912	1000000
9	2	9	838276	82	1748	0	159812	1000000
10	1	9	242382	64	0	0	757554	1000000
11	3	9	154020	59	1260	1207	843336	1000000
12	3	9	987433	56	1391	1009	9999	1000000

- >> Back to Result of Chirped Radar Detection (5500 MHz)
- >> Back to Result of Chirped Radar Detection (5510 MHz)
- >> Back to Result of Chirped Radar Detection (5530 MHz)
- >> Back to Result of Chirped Radar Detection (5570 MHz)
- >> Back to Result of Chirped Radar Detection (5250 MHz)

Chirp 26		Number of Burst Segment = 17 Total Burst Segment Length = 705882 us						
Burst Segment	No of Pulse	Chirp Width (MHz)	T1 (us)	Pulse Width (us)	T3 (us)	T4 (us)	T5 (us)	Total Length (us)
1	1	19	340742	82	0	0	365058	705882
2	1	19	594265	58	0	0	111559	705882
3	2	19	308690	83	1259	0	395767	705882
4	3	19	73794	63	1613	1078	629208	705882
5	2	19	468433	79	1839	0	235452	705882
6	3	19	431501	72	1513	1895	270757	705882
7	1	19	250558	64	0	0	455260	705882
8	1	19	603811	55	0	0	102016	705882
9	3	19	588975	86	1430	1004	114215	705882
10	1	19	276643	95	0	0	429144	705882
11	3	19	632297	100	1636	1521	70128	705882
12	1	19	44946	70	0	0	660866	705882
13	2	19	369325	50	1619	0	334838	705882
14	3	19	319802	57	1267	1913	382729	705882
15	2	19	1416	83	1786	0	702514	705882
16	3	19	342112	74	1361	1479	360708	705882
17	2	19	412378	52	1688	0	291712	705882

Chirp 27		Number of Burst Segment = 11 Total Burst Segment Length = 1090909 us						
Burst Segment	No of Pulse	Chirp Width (MHz)	T1 (us)	Pulse Width (us)	T3 (us)	T4 (us)	T5 (us)	Total Length (us)
1	3	5	1078125	59	1188	1609	9810	1090909
2	3	5	199962	84	1564	1124	888007	1090909
3	3	5	1068591	67	1325	1513	19279	1090909
4	3	5	217698	70	1476	1565	869960	1090909
5	2	5	870585	51	1339	0	218883	1090909
6	2	5	450505	65	1003	0	639271	1090909
7	3	5	773085	67	1256	937	315430	1090909
8	2	5	980958	91	1600	0	108169	1090909
9	2	5	1037120	99	1539	0	52052	1090909
10	1	5	892533	83	0	0	198293	1090909
11	1	5	47148	57	0	0	1043704	1090909

- >> Back to Result of Chirped Radar Detection (5500 MHz)
- >> Back to Result of Chirped Radar Detection (5510 MHz)
- >> Back to Result of Chirped Radar Detection (5530 MHz)
- >> Back to Result of Chirped Radar Detection (5570 MHz)
- >> Back to Result of Chirped Radar Detection (5250 MHz)

Chirp 28		Number of Burst Segment = 20 Total Burst Segment Length = 600000 us						
Burst Segment	No of Pulse	Chirp Width (MHz)	T1 (us)	Pulse Width (us)	T3 (us)	T4 (us)	T5 (us)	Total Length (us)
1	3	13	61566	83	1111	1868	535206	600000
2	2	13	268110	84	1708	0	330014	600000
3	1	13	449400	85	0	0	150515	600000
4	1	13	515601	91	0	0	84308	600000
5	3	13	452156	85	1546	1671	144372	600000
6	1	13	446322	95	0	0	153583	600000
7	2	13	237591	100	1148	0	361061	600000
8	2	13	218664	79	1547	0	379631	600000
9	1	13	545291	54	0	0	54655	600000
10	1	13	77777	85	0	0	522138	600000
11	1	13	9768	80	0	0	590152	600000
12	1	13	271417	95	0	0	328488	600000
13	2	13	406904	64	1825	0	191143	600000
14	1	13	574717	90	0	0	25193	600000
15	2	13	128689	76	1212	0	469947	600000
16	1	13	547517	90	0	0	52393	600000
17	2	13	133823	98	1758	0	464223	600000
18	1	13	493453	61	0	0	106486	600000
19	3	13	409063	72	1582	1291	187848	600000
20	1	13	383319	87	0	0	216594	600000

Chirp 29		Number of Burst Segment = 8 Total Burst Segment Length = 1500000 us						
Burst Segment	No of Pulse	Chirp Width (MHz)	T1 (us)	Pulse Width (us)	T3 (us)	T4 (us)	T5 (us)	Total Length (us)
1	2	16	365094	69	1377	0	1133391	1500000
2	1	16	851302	55	0	0	648643	1500000
3	1	16	920548	78	0	0	579374	1500000
4	1	16	1453776	93	0	0	46131	1500000
5	3	16	753220	85	1258	1695	743572	1500000
6	1	16	1188702	88	0	0	311210	1500000
7	3	16	1279212	84	1546	1625	217365	1500000
8	1	16	761507	66	0	0	738427	1500000

- >> Back to Result of Chirped Radar Detection (5500 MHz)
- >> Back to Result of Chirped Radar Detection (5510 MHz)
- >> Back to Result of Chirped Radar Detection (5530 MHz)
- >> Back to Result of Chirped Radar Detection (5570 MHz)
- >> Back to Result of Chirped Radar Detection (5250 MHz)

10. LIST OF TEST EQUIPMENT

No.	Instrument	Model No.	Calibration Due (mm/dd/yy)	Manufacture	Serial No.
<input checked="" type="checkbox"/>	Signal Analyzer (3 Hz ~ 50 GHz)	N9030A	06/07/2022	Keysight	MY53311083
<input checked="" type="checkbox"/>	Attenuator (20 dB, DC ~ 26.5 GHz)	8493C	01/13/2023	HP	09072
<input checked="" type="checkbox"/>	Attenuator (10 dB, DC ~ 26.5 GHz)	CFADC261002	01/19/2023	Cernex	-
<input checked="" type="checkbox"/>	Power Divider-4way (DC ~ 10 GHz)	804-2.6000	01/19/2023	Meca	-
<input checked="" type="checkbox"/>	Power Divider-2way (DC ~ 26.5 GHz)	11636B	12/02/2022	HP	50820
<input checked="" type="checkbox"/>	DFS Radar Simulator (SA)	3035C	01/19/2023	AEROFLEX	302570/248
<input checked="" type="checkbox"/>	DFS Radar simulator (VSG)	3025C	01/19/2023	AEROFLEX	303570/536
<input checked="" type="checkbox"/>	DFS Test Software	-	N/A	AEROFLEX	-

Note:

1. Equipment listed above that calibrated during the testing period was set for test after the calibration.
2. Equipment listed above that has a calibration due date during the testing period, the testing is completed before equipment expiration date

APPENDIX A. TEST SETUP PHOTOS

The setup photos are provided as a separate document.

APPENDIX B. PHOTOGRAPHS OF EUT

B.1. EXTERNAL PHOTOS

The external photos are provided as a separate document.

B.2. INTERNAL PHOTOS

The internal photos are provided as a separate document.

END OF TEST REPORT