

FCC TEST REPORT
for
Alinket Electronic Technology (Shanghai) Co., Ltd.

Embedded Wi-Fi Controller
Model No.: ALX8XX

Prepared for : Alinket Electronic Technology (Shanghai) Co., Ltd.
Address : Room 403, No. 10, Lane 198, Zhangheng Road, Pudong,
Shanghai, China

Prepared By : Shenzhen Anbotek Compliance Laboratory Limited
Address : 1/F., Building 1, SEC Industrial Park, No.0409 Qianhai Road,
Nanshan District, Shenzhen, Guangdong, China
Tel: (86) 755-26066544
Fax: (86) 755-26014772

Report Number : R011503627E
Date of Test : Mar. 27~ Apr. 21, 2015
Date of Report : Apr. 22, 2015

TABLE OF CONTENT

Description

Page

Test Report

1. GENERAL INFORMATION.....	4
1.1. Description of Device (EUT).....	4
1.2. Auxiliary Equipment Used during Test.....	5
1.3. Description of Test Facility.....	5
1.4. Measurement Uncertainty.....	5
2. TEST METHODOLOGY.....	6
2.1. Summary of Test Results.....	6
2.2. Description of Test Modes.....	6
2.3. List of channels:.....	7
3. CONDUCTED EMISSION TEST.....	8
3.1. Block Diagram of Test Setup.....	8
3.2. Power Line Conducted Emission Measurement Limits (15.207).....	8
3.3. Configuration of EUT on Measurement.....	8
3.4. Operating Condition of EUT.....	8
3.5. Test Procedure.....	9
3.6. Test equipment.....	9
3.7. Power Line Conducted Emission Measurement Results.....	9
4. FCC PART 15.247 REQUIREMENTS FOR DSSS & OFDM MODULATION.....	12
4.1 Test Setup.....	12
4.2 6dB Bandwidth.....	12
4.3. Maximum Output Power Test.....	28
4.4. Band Edges Measurement.....	36
4.5. Peak Power Spectral Density.....	74
4.6. Radiated Emissions.....	82
5. ANTENNA APPLICATION.....	93
5.1. Antenna requirement.....	93
5.2. Result.....	93
6. PHOTOGRAPH.....	94
6.1. Photo of Conducted Emission Measurement.....	94
6.2. Photo of Radiation Emission Test.....	94
APPENDIX I (EXTERNAL PHOTOS).....	96
APPENDIX II (INTERNAL PHOTOS).....	98

TEST REPORT

Applicant : Alinket Electronic Technology (Shanghai) Co., Ltd.
Manufacturer : Alinket Electronic Technology (Shanghai) Co., Ltd.
EUT : Embedded Wi-Fi Controller
Model No. : ALX8XX
Serial No. : N.A.
Trade Mark : Alinket®
Rating : DC 3.3V

Measurement Procedure Used:
FCC Part15 Subpart C, Paragraph 15.247

The device described above is tested by Shenzhen Anbotek Compliance Laboratory Limited to determine the maximum emission levels emanating from the device and the severe levels of the device can endure and its performance criterion. The measurement results are contained in this test report and Shenzhen Anbotek Compliance Laboratory Limited is assumed full of responsibility for the accuracy and completeness of these measurements. Also, this report shows that the EUT (Equipment Under Test) is technically compliant with the FCC Part 15 Subpart C requirements.

This report applies to above tested sample only and shall not be reproduced in part without written approval of Shenzhen Anbotek Compliance Laboratory Limited.

Date of Test : Mar. 27~ Apr. 21, 2015

Prepared by :

Kebo Zhang
(Tested Engineer / Kebo Zhang)

Reviewer :

Amy Ding
(Project Manager / Amy Ding)

Approved & Authorized Signer :

Tom Chen
(Manager / Tom Chen)

1. GENERAL INFORMATION

1.1. Description of Device (EUT)

EUT : Embedded Wi-Fi Controller

Model Number : ALX8XX

Test Power Supply : AC 120V, 60Hz for adapter

RF Transmission : 2412MHz~2462MHz (802.11b/802.11g/802.11n(HT20))
Frequency : 2422MHz~2452MHz (802.11n(HT40))

Channels : 11 For (802.11b/802.11g/802.11n(HT20))
7 For (802.11n(HT40))

Modulation : 802.11b CCK
802.11g OFDM
802.11n MCS

Antenna Gain: : 2dBi

Applicant : Alinket Electronic Technology (Shanghai) Co., Ltd.
Address : Room 403, No. 10, Lane 198, Zhangheng Road, Pudong, Shanghai,
China

Manufacturer : Alinket Electronic Technology (Shanghai) Co., Ltd.
Address : Room 403, No. 10, Lane 198, Zhangheng Road, Pudong, Shanghai,
China

Factory : Alinket Electronic Technology (Shanghai) Co., Ltd.
Address : Room 403, No. 10, Lane 198, Zhangheng Road, Pudong, Shanghai,
China

Date of receipt : Mar. 27, 2015

Date of Test : Mar. 27~ Apr. 21, 2015

1.2. Auxiliary Equipment Used during Test

Adapter : Power Supply
Model:MX12L3-0502000V
Input: AC 100-240V, 50-60Hz, 0.35A
Output: DC 5V, 2A
CE , FCC

1.3. Description of Test Facility

The test facility is recognized, certified, or accredited by the following organizations:

CNAS - LAB Code: L3503

Shenzhen Anbotek Compliance Laboratory Limited., Laboratory has been assessed and in compliance with CNAS/CL01: 2006 accreditation criteria for testing laboratories (identical to ISO/IEC 17025:2005 General Requirements) for the Competence of Testing Laboratories.

FCC-Registration No.: 752021

Shenzhen Anbotek Compliance Laboratory Limited, EMC Laboratory has been registered and fully described in a report filed with the (FCC) Federal Communications Commission. The acceptance letter from the FCC is maintained in our files. Registration 752021, July 10, 2013.

IC-Registration No.: 8058A-1

Shenzhen Anbotek Compliance Laboratory Limited., EMC Laboratory has been registered and fully described in a report filed with the (IC) Industry Canada. The acceptance letter from the IC is maintained in our files. Registration 8058A, February 22, 2013.

Test Location

All Emissions tests were performed at
Shenzhen Anbotek Compliance Laboratory Limited. at 1/F., Building 1, SEC Industrial Park, No.0409 Qianhai Road, Nanshan District, Shenzhen, Guangdong, China

1.4. Measurement Uncertainty

Radiation Uncertainty : Ur = 4.1 dB (Horizontal)
Ur = 4.3 dB (Vertical)
Conduction Uncertainty : Uc = 3.4dB

2. TEST METHODOLOGY

The tests documented in this report were performed in accordance with ANSI C63.10: 2013 and FCC Part 15, Paragraph 15.247.

2.1. Summary of Test Results

The EUT has been tested according to the following specifications:

Standard	Test Type	Result	Notes
FCC Part 15, Paragraph 15.107, 15.207	Conducted Emission Test	PASS	Complies
FCC Part 15, Paragraph 15.247(b)(1)	Maximum Output Power	PASS	Complies
FCC Part 15, Paragraph 15.247(a)(2)	6dB Bandwidth	PASS	Complies
FCC Part 15, Paragraph 15.247(c)	100kHz Bandwidth of Frequency Band Edges	PASS	Complies
FCC Part 15, Paragraph 15.209(a)(f)	Spurious Emission	PASS	Complies
FCC Part 15, Paragraph 15.247(a)(1)	Frequency Separation	-	N/A
FCC Part 15, Paragraph 15.247(a)(1)(iii)	Number of Hopping Frequency	-	N/A
FCC Part 15, Paragraph 15.247(a)(1)(iii)	Time of Occupancy	-	N/A
FCC Part 15, Paragraph 15.247(c)	Peak Power Density	PASS	Complies

2.2. Description of Test Modes

The EUT has been tested under operating condition.

Software used to control the EUT for staying in continuous transmitting and receiving mode is programmed.

IEEE802.11b: Channel 1(2412MHz), Channel 6(2437MHz) and Channel 11(2462MHz) with 1 Mbps lowest data rate (worst case) are chosen for the final testing.

IEEE802.11g: Channel 1(2412MHz), Channel 6(2437MHz) and Channel 11(2462MHz) with 6 Mbps lowest data rate (the worst case) are chosen for the final testing.

IEEE802.11n (HT20): Channel 1(2412MHz), Channel 6(2437MHz) and Channel 11(2462MHz) with MCS 0 Mbps lowest data rate (the worst case) are chosen for the final testing.

IEEE802.11n (HT40): Channel 3(2422MHz), Channel 6(2437MHz) and Channel 9(2452MHz) with MCS 0 Mbps lowest data rate (the worst case) are chosen for the final testing.

2.3. List of channels:

√ - available

X - tested

Number	Frequency(MHz)		802.11 b/g/n (HT20)	802.11 b/g/n (HT40)
1	2412	√	X	
2	2417	√		
3	2422	√		X
4	2427	√		
5	2432	√		
6	2437	√	X	X
7	2442	√		
8	2447	√		
9	2452	√		X
10	2457	√		
11	2462	√	X	

3. Conducted Emission Test

3.1. Block Diagram of Test Setup

3.1.1. Block diagram of connection between the EUT and simulators

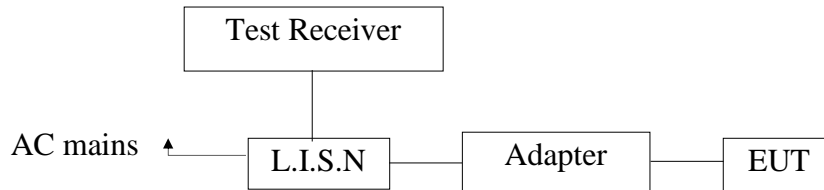

3.2. Power Line Conducted Emission Measurement Limits (15.207)

Frequency MHz	Limits dB(μV)	
	Quasi-peak Level	Average Level
0.15 ~ 0.50	66 ~ 56*	56 ~ 46*
0.50 ~ 5.00	56	46
5.00 ~ 30.00	60	50

- Notes: 1. *Decreasing linearly with logarithm of frequency.
2. The lower limit shall apply at the transition frequencies.

3.3. Configuration of EUT on Measurement

The following equipments are installed on Power Line Conducted Emission Measurement to meet the commission requirement and operating regulations in a manner which tends to maximize its emission characteristics in a normal application.

3.4. Operating Condition of EUT

- 3.4.1. Setup the EUT and simulator as shown as Section 3.1.
- 3.4.2. Turn on the power of all equipment.
- 3.4.3. Let the EUT work in test mode (On) and measure it.

3.5. Test Procedure

The EUT system is connected to the power mains through a line impedance stabilization network (L.I.S.N.). This provides a 50ohm coupling impedance for the EUT system. Please refer the block diagram of the test setup and photographs. Both sides of AC line are checked to find out the maximum conducted emission. In order to find the maximum emission levels, the relative positions of equipment and all of the interface cables shall be changed according to FCC ANSI C63.10-2013 on Conducted Emission Measurement.

The bandwidth of test receiver (ESCI) set at 9KHz.

The frequency range from 150KHz to 30MHz is checked.

The test results are reported on Section 3.6.

3.6. Test equipment

Item	Equipment	Manufacturer	Model No.	Serial No.	Last Cal.	Cal. Interval
1.	Two-Line V-network	Rohde & Schwarz	ENV216	100055	Apr. 17, 2015	1 Year
2.	EMI Test Receiver	Rohde & Schwarz	ESCI	100627	Apr. 17, 2015	1 Year
3.	RF Switching Unit	Compliance Direction	RSU-M2	38303	Apr. 17, 2015	1 Year

3.7. Power Line Conducted Emission Measurement Results

PASS.

The frequency range from 150KHz to 30 MHz is investigated.

Please refer the following pages.

CONDUCTED EMISSION TEST DATA

Test Site: 1# Shielded Room
 Operating Condition: On
 Test Specification: AC 120V, 60Hz for adapter
 Comment: Live Line
 Tem.:25°C Hum.:50%

SCAN TABLE: "Voltage (150K~30M) FIN"
 Short Description: 150K-30M Disturbance Voltages

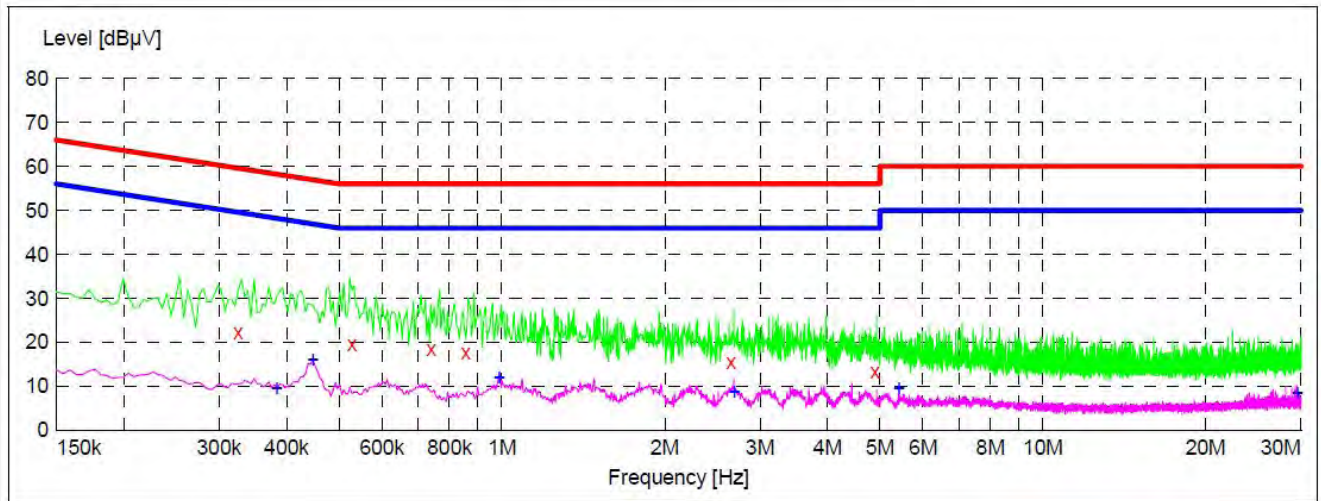

Frequency MHz	Level dBµV	Transd dB	Limit dBµV	Margin dB	Detector	Line	PE
0.325500	22.20	20.1	60	37.4	QP	L1	GND
0.528000	19.70	20.1	56	36.3	QP	L1	GND
0.739500	18.40	20.1	56	37.6	QP	L1	GND
0.856500	17.60	20.1	56	38.4	QP	L1	GND
2.651500	15.60	20.4	56	40.4	QP	L1	GND
4.892500	13.30	20.5	56	42.7	QP	L1	GND

Frequency MHz	Level dBµV	Transd dB	Limit dBµV	Margin dB	Detector	Line	PE
0.384000	9.60	20.1	48	38.6	AV	L1	GND
0.447000	16.10	20.1	47	30.8	AV	L1	GND
0.987000	12.10	20.2	46	33.9	AV	L1	GND
2.687500	8.70	20.4	46	37.3	AV	L1	GND
5.419000	9.60	20.5	50	40.4	AV	L1	GND
29.507500	8.50	20.9	50	41.5	AV	L1	GND

CONDUCTED EMISSION TEST DATA

Test Site: 1# Shielded Room
 Operating Condition: On
 Test Specification: AC 120V, 60Hz for adapter
 Comment: Neutral Line
 Tem.:25°C Hum.:50%

SCAN TABLE: "Voltage (150K~30M) FIN"
 Short Description: 150K-30M Disturbance Voltages

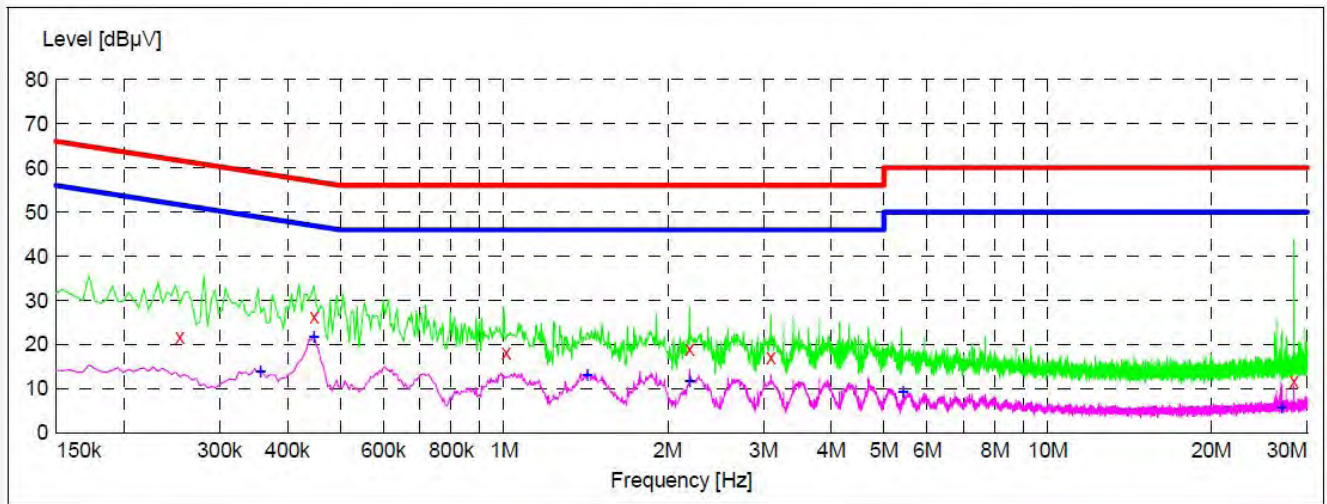

Frequency MHz	Level dBµV	Transd dB	Limit dBµV	Margin dB	Detector	Line	PE
0.253500	21.80	20.1	62	39.8	QP	N	GND
0.447000	26.30	20.1	57	30.6	QP	N	GND
1.009000	18.20	20.2	56	37.8	QP	N	GND
2.197000	18.90	20.3	56	37.1	QP	N	GND
3.097000	17.20	20.4	56	38.8	QP	N	GND
28.346500	11.70	20.9	60	48.3	QP	N	GND

Frequency MHz	Level dBµV	Transd dB	Limit dBµV	Margin dB	Detector	Line	PE
0.357000	13.90	20.1	49	34.9	AV	N	GND
0.447000	21.80	20.1	47	25.1	AV	N	GND
1.423000	13.10	20.3	46	32.9	AV	N	GND
2.197000	11.70	20.3	46	34.3	AV	N	GND
5.419000	9.20	20.5	50	40.8	AV	N	GND
26.875000	5.80	20.9	50	44.2	AV	N	GND

4. FCC Part 15.247 Requirements for DSSS & OFDM Modulation

4.1 Test Setup

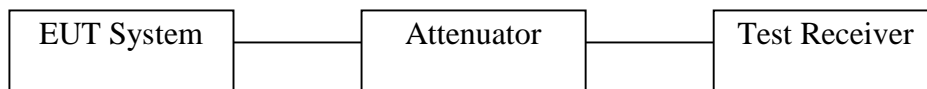

4.2 6dB Bandwidth

a. Limit

For the direct sequence systems, the minimum 6dB bandwidth shall be at least 500kHz.

b. Test Procedure

1. Place the EUT on the table and set it in the transmitting mode.
2. Remove the antenna from the EUT and then connect a low loss RF cable from the antenna port to the spectrum analyzer.
3. Set the spectrum analyzer as:
RBW = 100kHz, VBW $\geq 3 \times$ RBW = 300kHz,
Detector= Peak
Trace mode= Max hold.
Sweep- auto couple.
4. Mark the peak frequency and -6dB (upper and lower) frequency.
5. Repeat until all the rest channels are investigated.

20dB Bandwidth:

C63.10

Occupied Bandwidth (OBW=20dB Bandwidth)

1. Set RBW=1%~5% OBW
2. Set the VBW $\geq 3 \times$ RBW
3. Set the span range between 2 times and 5 times of the OBW
4. Sweep Time= Auto
Detector= Peak
Trace= Max hold
5. Once the reference level is established, the equipment is conditioned with typical modulating signals to produce the worst case (i.e. the widest) bandwidth. Unless otherwise specified for an unlicensed wireless device, measure the bandwidth at the -20dB levels with respect to the reference level.

c. Test Setup See 4.1

d. Test Equipment

Item	Equipment	Manufacturer	Model No.	Serial No.	Last Cal.	Cal. Interval
1.	Spectrum Analysis	Agilent	E4407B	US39390582	Apr. 17, 2015	1 Year
2.	Preamplifier	Instruments corporation	EMC011830	980100	Apr. 17, 2015	1 Year
3.	EMI Test Receiver	Rohde & Schwarz	ESPI	101604	Apr. 17, 2015	1 Year
4.	Double Ridged Horn Antenna	Instruments corporation	GTH-0118	351600	Apr. 20, 2015	1 Year
5.	Bilog Broadband Antenna	Schwarzbeck	VULB9163	VULB 9163-289	Apr. 20, 2015	1 Year
6.	Pre-amplifier	SONOMA	310N	186860	Apr. 17, 2015	1 Year
7.	EMI Test Software EZ-EMC	SHURPLE	N/A	N/A	N/A	N/A

e. Test Results

Pass.

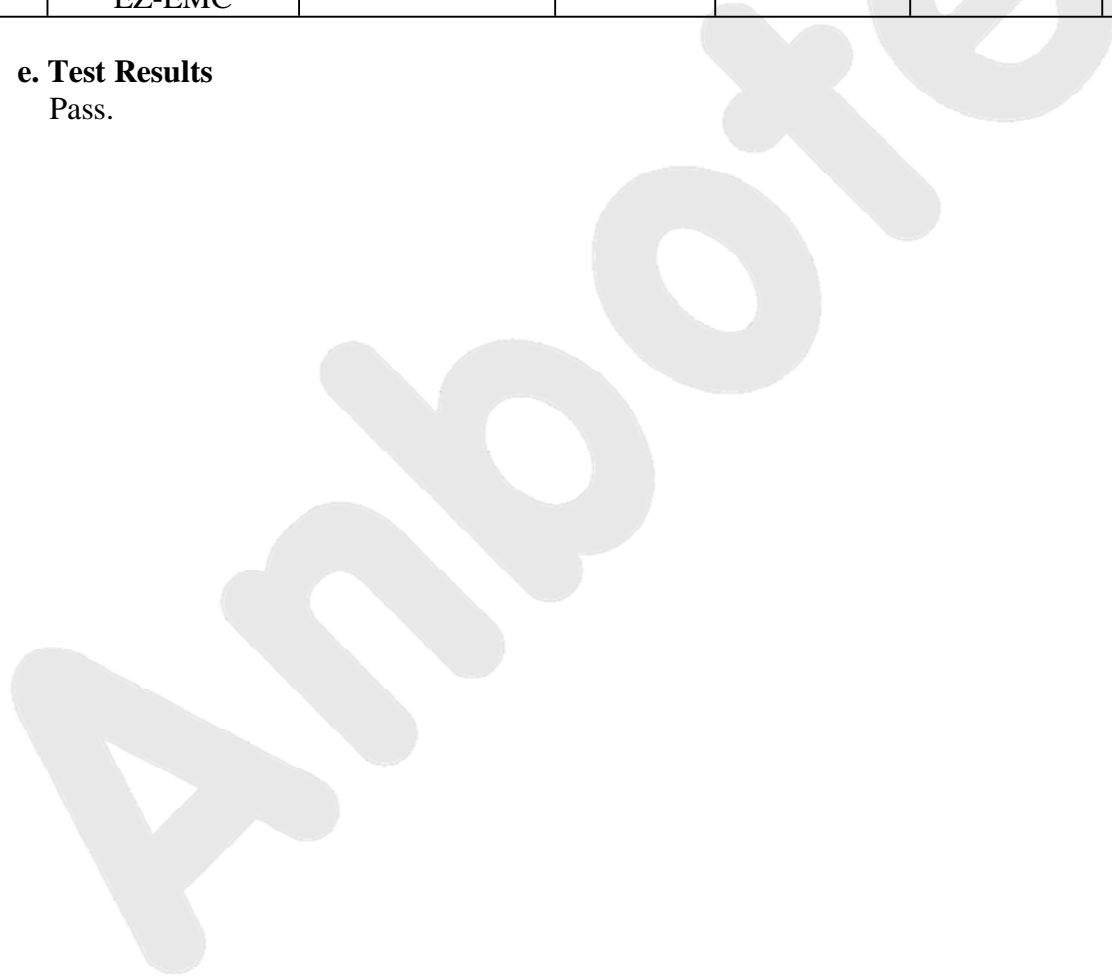

f. Test Data
6dB Bandwidth

Test mode: IEEE 802.11b

Channel	Frequency (MHz)	Bandwidth (MHz)	Limit (kHz)	Results
Low	2412	11.76		Pass
Mid	2437	11.76	>500	Pass
High	2462	11.76		Pass

Test mode: IEEE 802.11g

Channel	Frequency (MHz)	Bandwidth (MHz)	Limit (kHz)	Results
Low	2412	16.56		Pass
Mid	2437	16.52	>500	Pass
High	2462	16.56		Pass

Test mode: IEEE 802.11n (HT20)

Channel	Frequency (MHz)	Bandwidth (MHz)	Limit (kHz)	Results
Low	2412	17.76		Pass
Mid	2437	17.76	>500	Pass
High	2462	17.76		Pass

Test mode: IEEE 802.11n (HT40)

Channel	Frequency (MHz)	Bandwidth (MHz)	Limit (kHz)	Results
Low	2422	36.56		Pass
Mid	2437	36.56	>500	Pass
High	2452	36.56		Pass

Test Plots See the following page.

Test Mode: 802.11b---Low



*RBW 100 kHz Delta 1 [T1]
*VBW 300 kHz 0.43 dB
SWT 2.5 ms 11.760000000 MHz

Ref 25 dBm *Att 40 dB

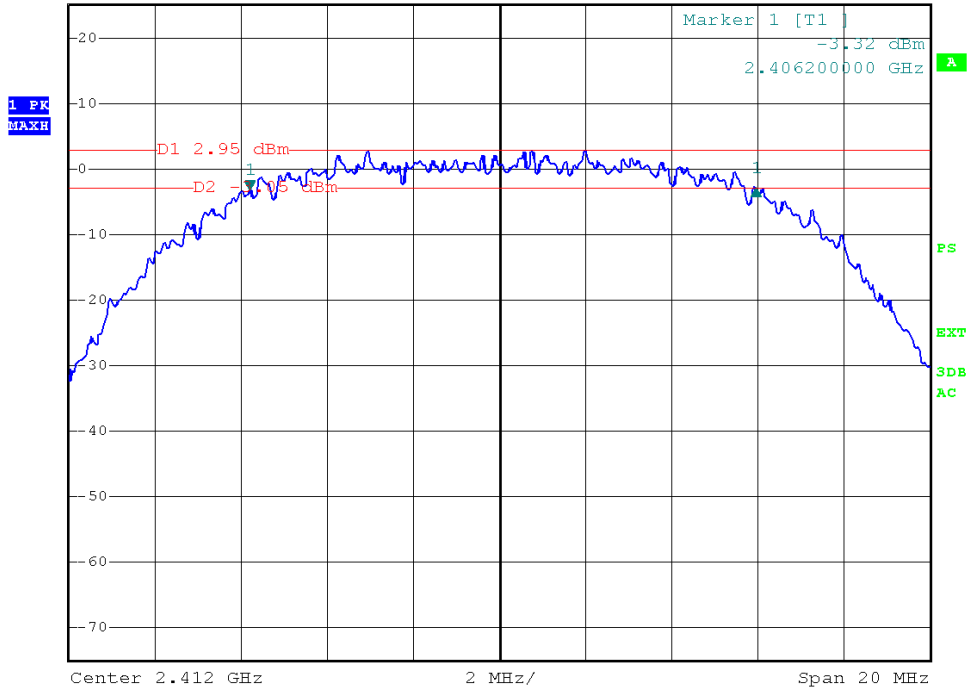

Test Mode: 802.11b---Mid



*RBW 100 kHz Delta 1 [T1]
*VBW 300 kHz 0.41 dB
SWT 2.5 ms 11.760000000 MHz

Ref 25 dBm *Att 40 dB

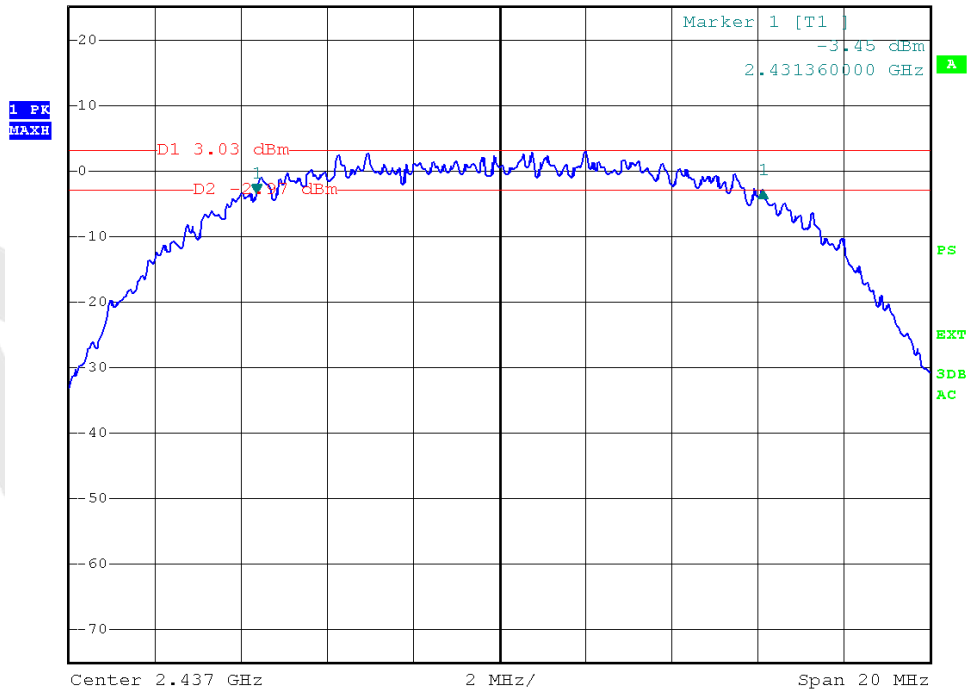

Test Mode: 802.11b---High



*RBW 100 kHz Delta 1 [T1]
*VBW 300 kHz -1.35 dB
SWT 2.5 ms 11.760000000 MHz

Ref 25 dBm *Att 40 dB

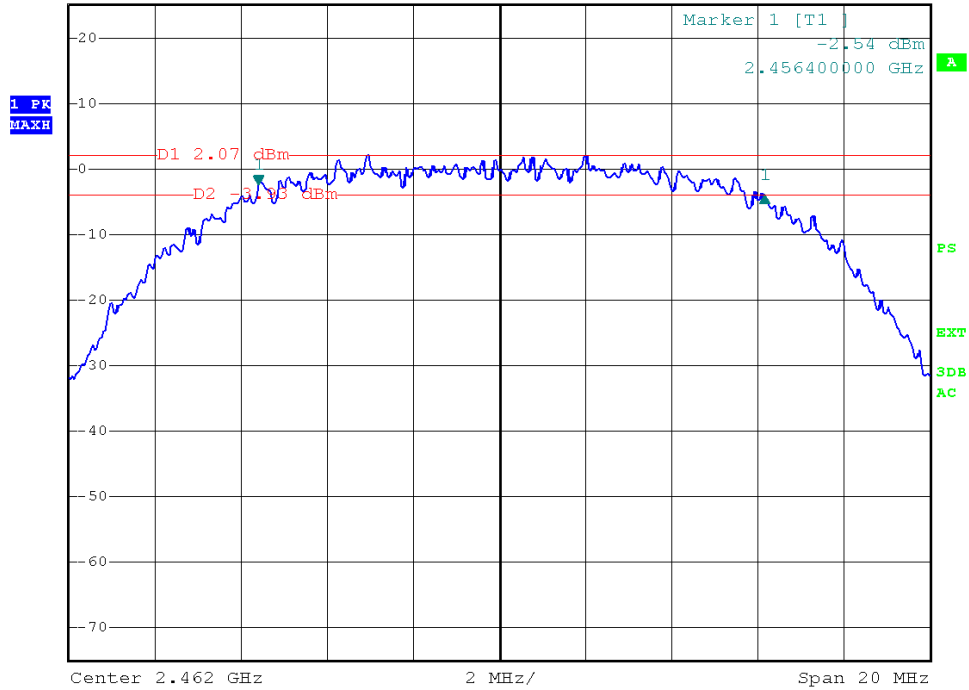

Test Mode: 802.11g---Low



*RBW 100 kHz Delta 1 [T1]
*VBW 300 kHz 0.80 dB
SWT 2.5 ms 16.560000000 MHz

Ref 25 dBm *Att 40 dB

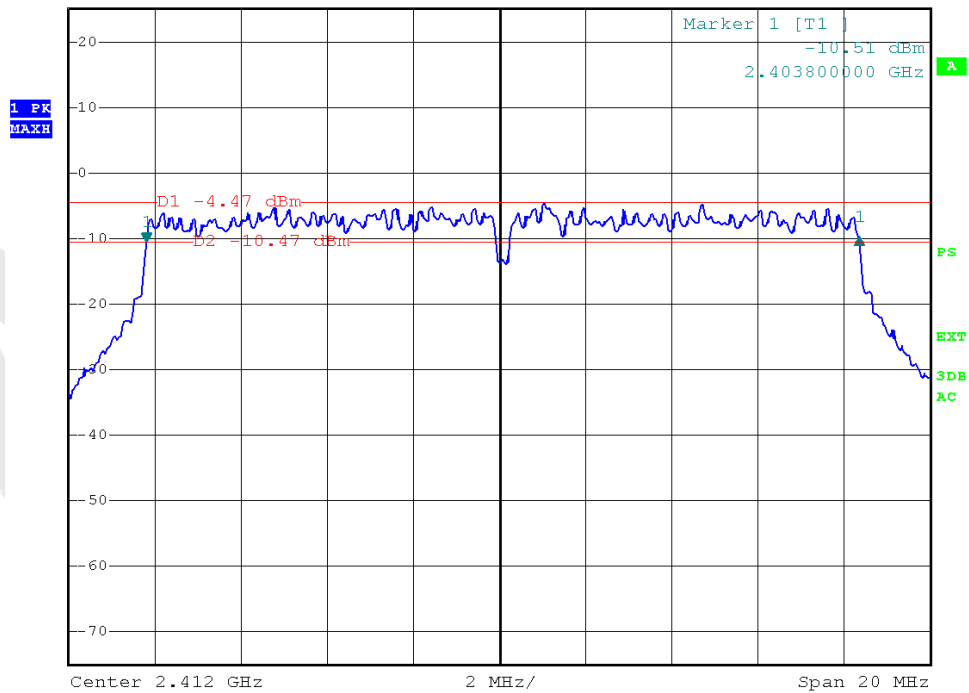

Test Mode: 802.11g---Mid



*RBW 100 kHz Delta 1 [T1]
*VBW 300 kHz -1.71 dB
SWT 2.5 ms 16.520000000 MHz

Ref 25 dBm *Att 40 dB

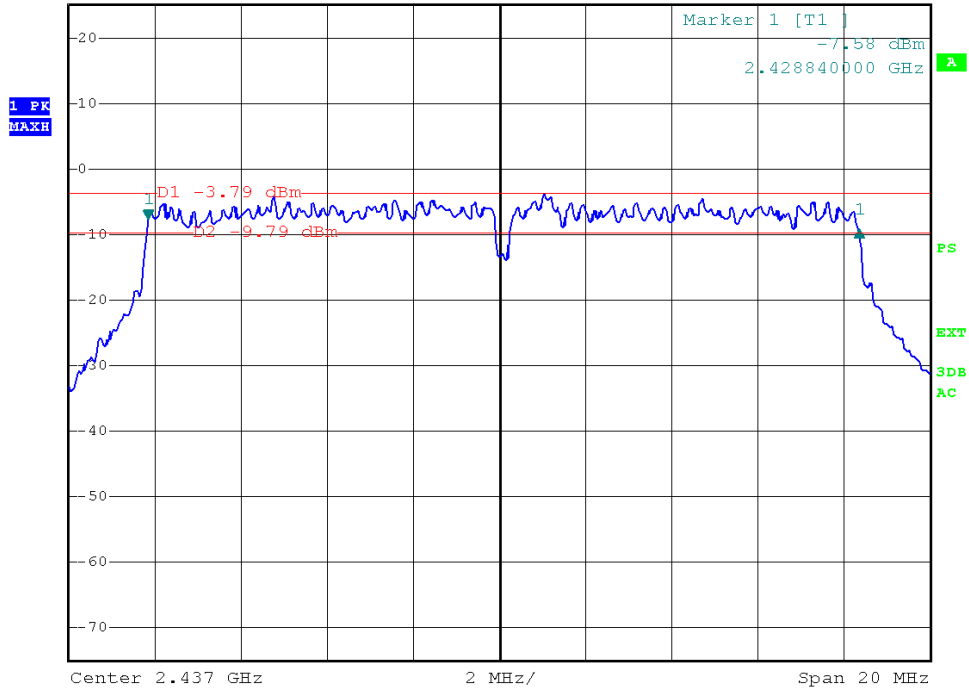

Test Mode: 802.11g---High



*RBW 100 kHz Delta 1 [T1]
*VBW 300 kHz 0.27 dB
SWT 2.5 ms 16.560000000 MHz

Ref 25 dBm *Att 40 dB

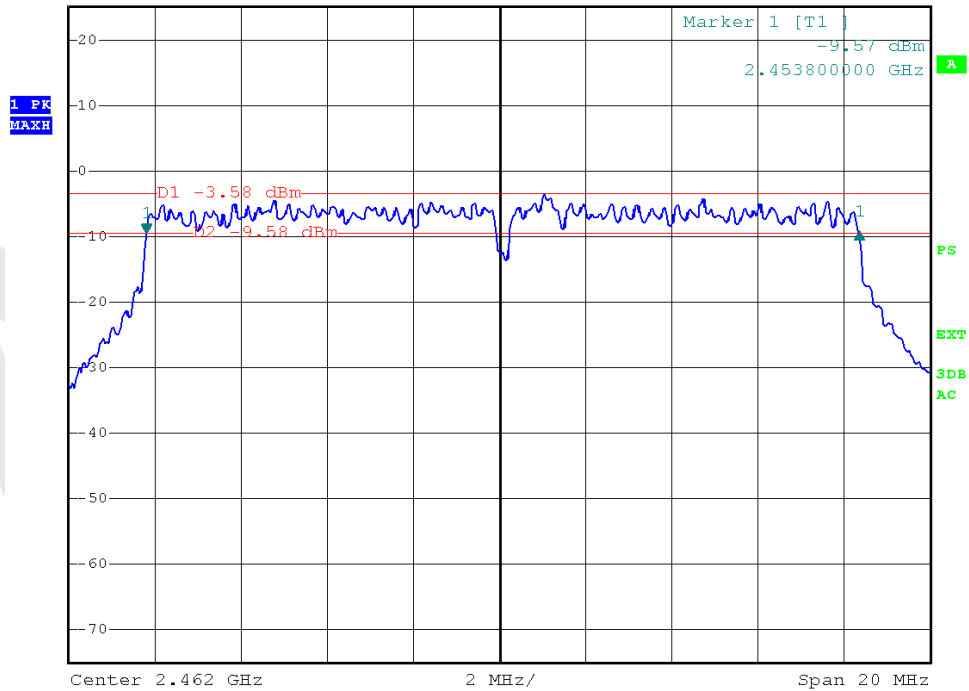

Test Mode: 802.11n (HT20)---Low

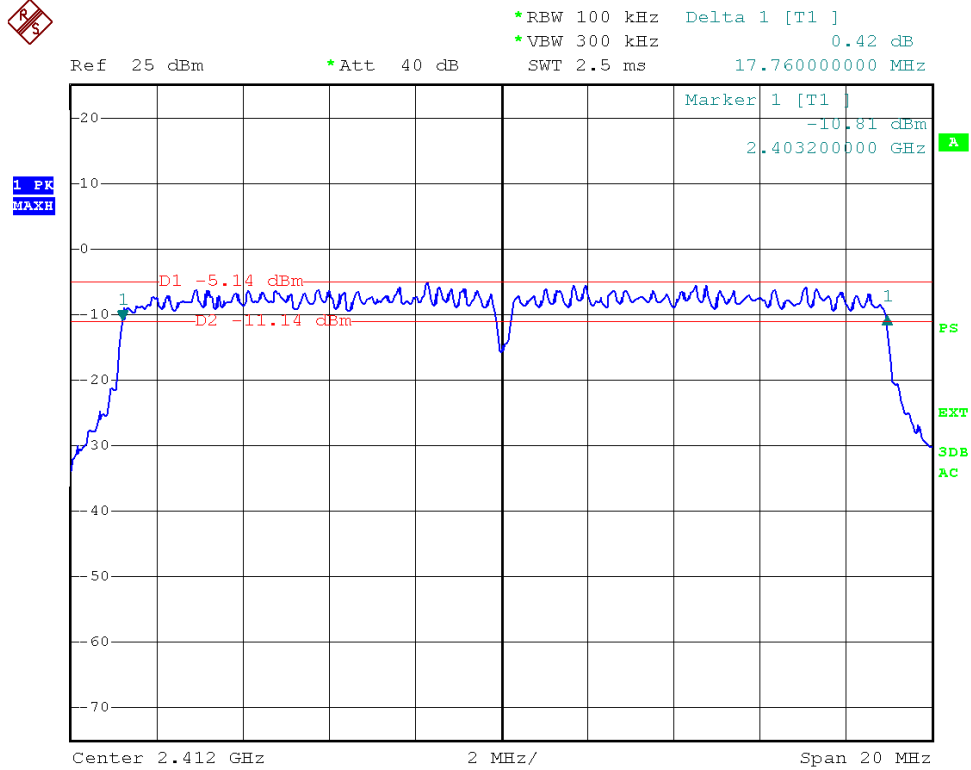

Test Mode: 802.11n (HT20)---Mid

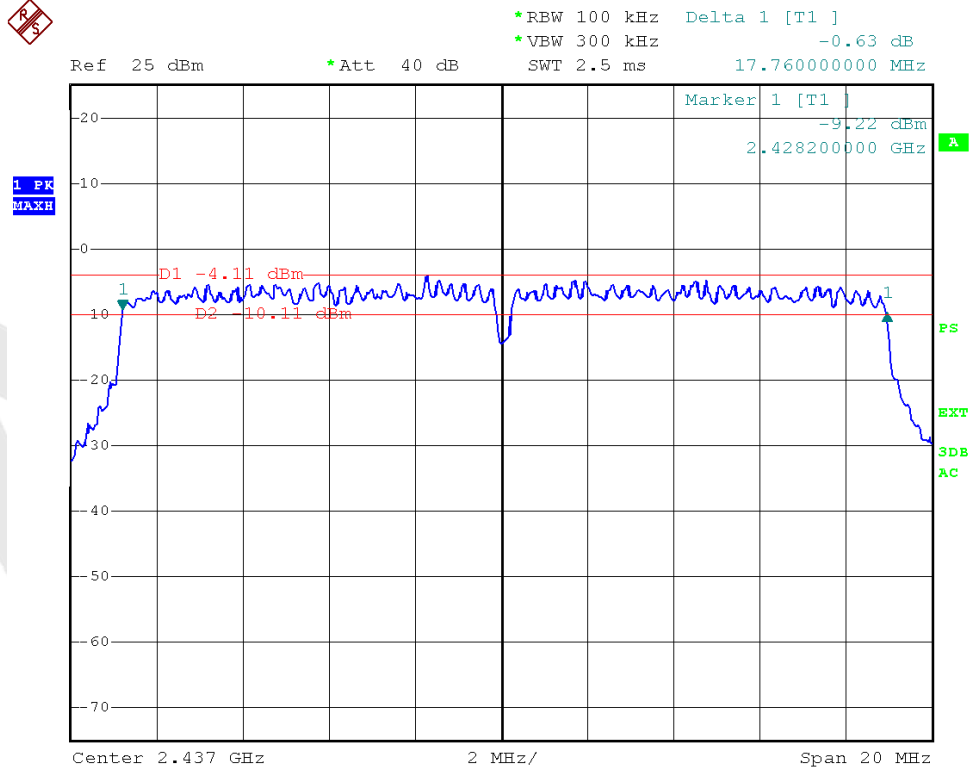

Test Mode: 802.11n (HT20)---High



*RBW 100 kHz Delta 1 [T1]
*VBW 300 kHz -1.03 dB
SWT 2.5 ms 17.760000000 MHz

Ref 25 dBm *Att 40 dB

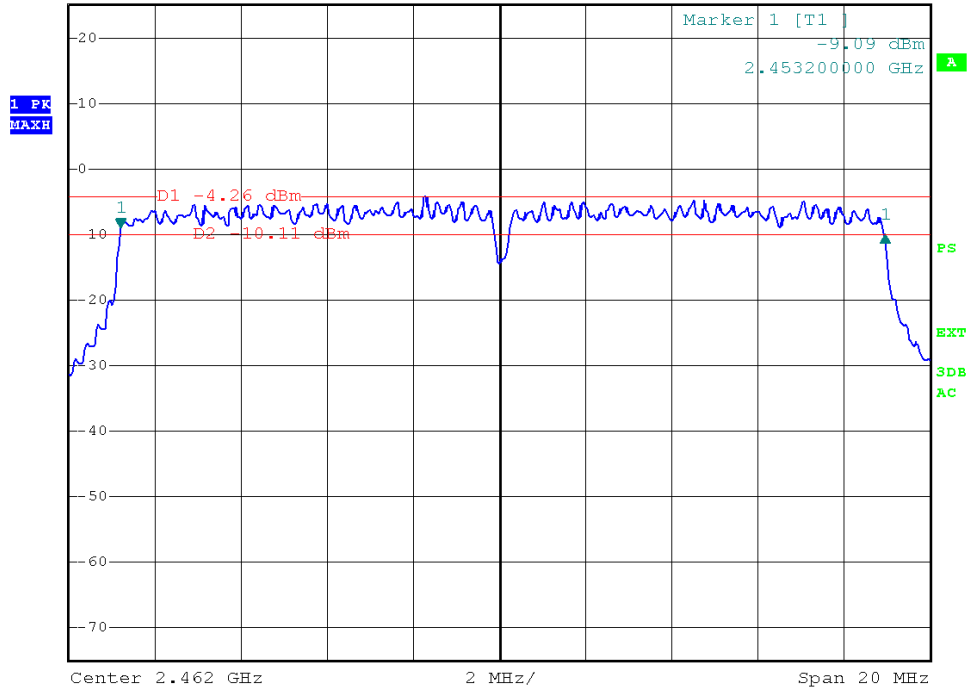

Test Mode: 802.11n (HT40)---Low



*RBW 100 kHz Delta 1 [T1]
*VBW 300 kHz -0.23 dB
SWT 5 ms 36.560000000 MHz

Ref 25 dBm *Att 40 dB

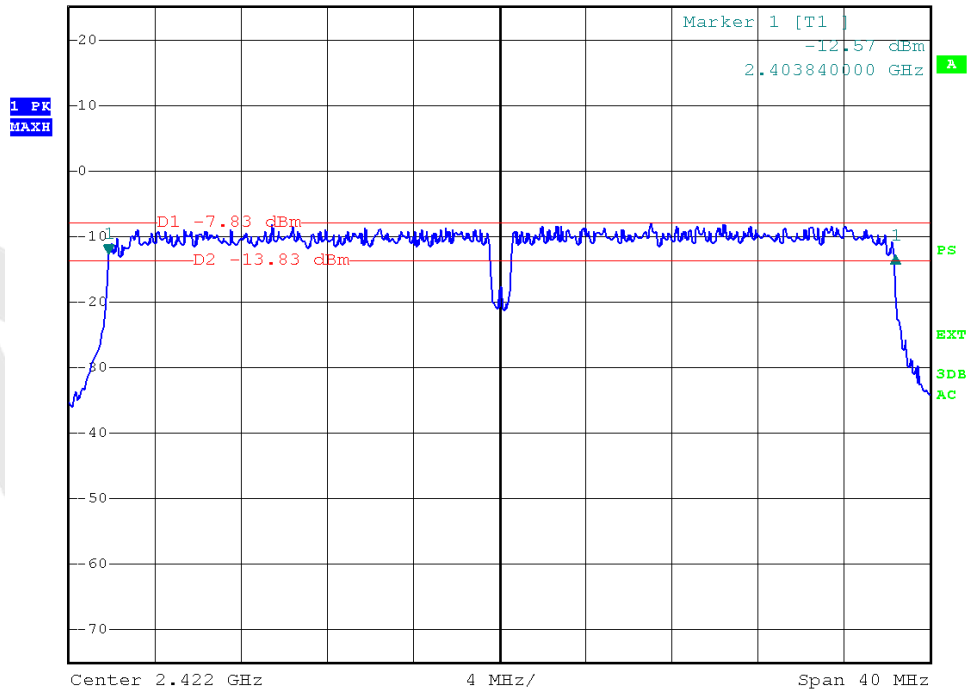

Test Mode: 802.11n (HT40)---Mid



*RBW 100 kHz Delta 1 [T1]
*VBW 300 kHz -0.95 dB
SWT 5 ms 36.560000000 MHz

Ref 25 dBm *Att 40 dB

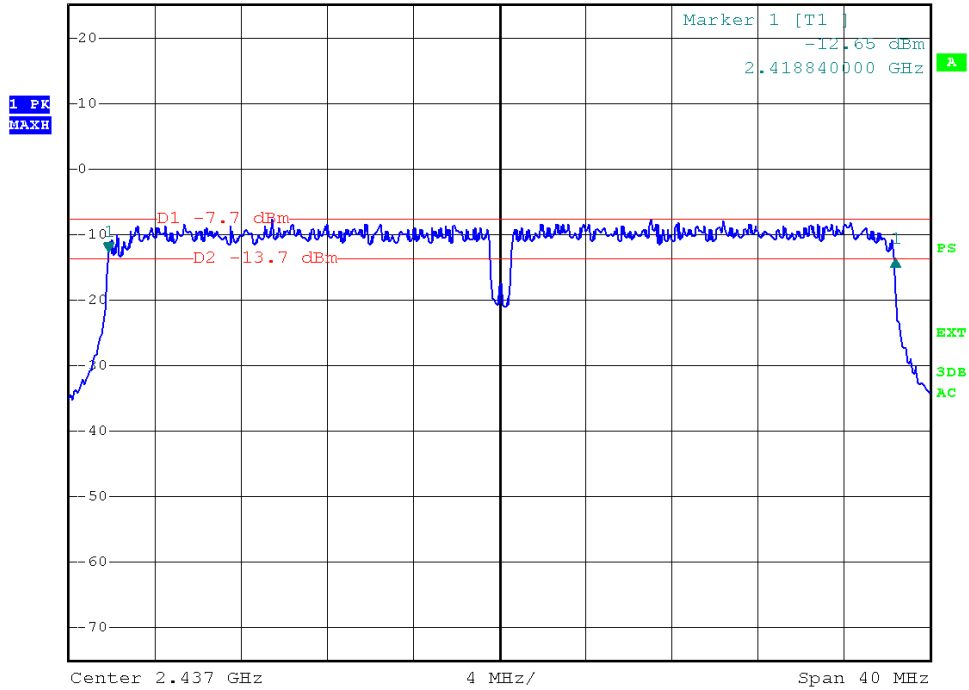

Test Mode: 802.11n (HT40)---High



*RBW 100 kHz Delta 1 [T1]
*VBW 300 kHz -0.74 dB
SWT 5 ms 36.560000000 MHz

Ref 25 dBm *Att 40 dB

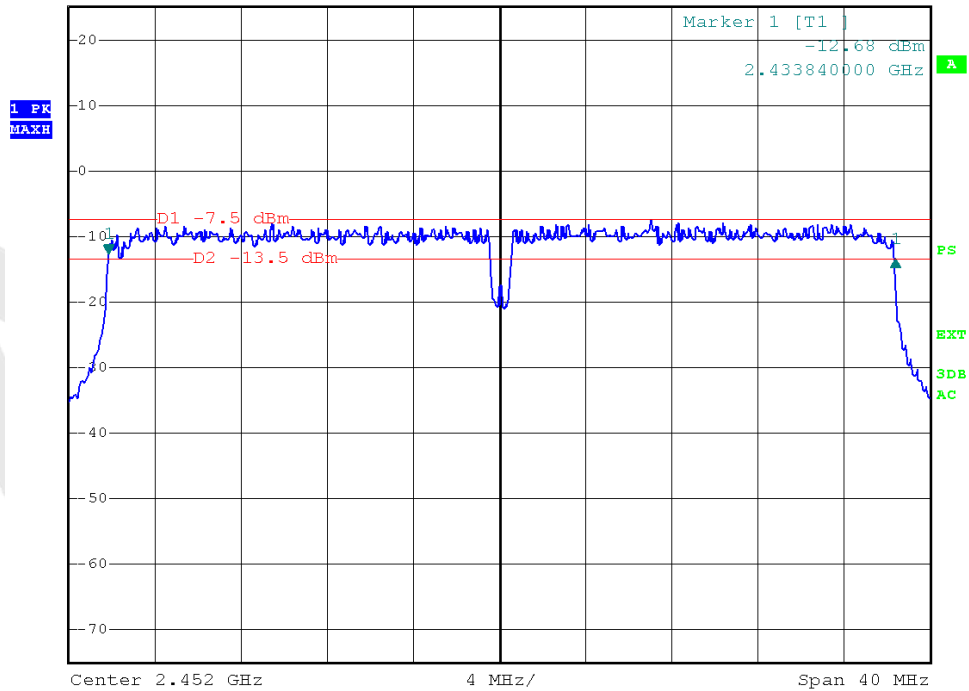

20dB Bandwidth

Test mode: IEEE 802.11b

Channel	Frequency (MHz)	Bandwidth (MHz)	Results
Low	2412	19.04	Pass
Mid	2437	19.04	Pass
High	2462	18.96	Pass

Test mode: IEEE 802.11g

Channel	Frequency (MHz)	Bandwidth (MHz)	Results
Low	2412	22.32	Pass
Mid	2437	22.64	Pass
High	2462	22.32	Pass

Test mode: IEEE 802.11n (HT20)

Channel	Frequency (MHz)	Bandwidth (MHz)	Results
Low	2412	23.12	Pass
Mid	2437	23.20	Pass
High	2462	23.12	Pass

Test mode: IEEE 802.11n (HT40)

Channel	Frequency (MHz)	Bandwidth (MHz)	Results
Low	2422	42.24	Pass
Mid	2437	42.24	Pass
High	2452	42.24	Pass

Test Plots See the following page.

Test Mode: 802.11b---Low



*RBW 300 kHz Marker 1 [T1] 9.38 dBm
*VBW 1 MHz
SWT 2.5 ms 2.413040000 GHz

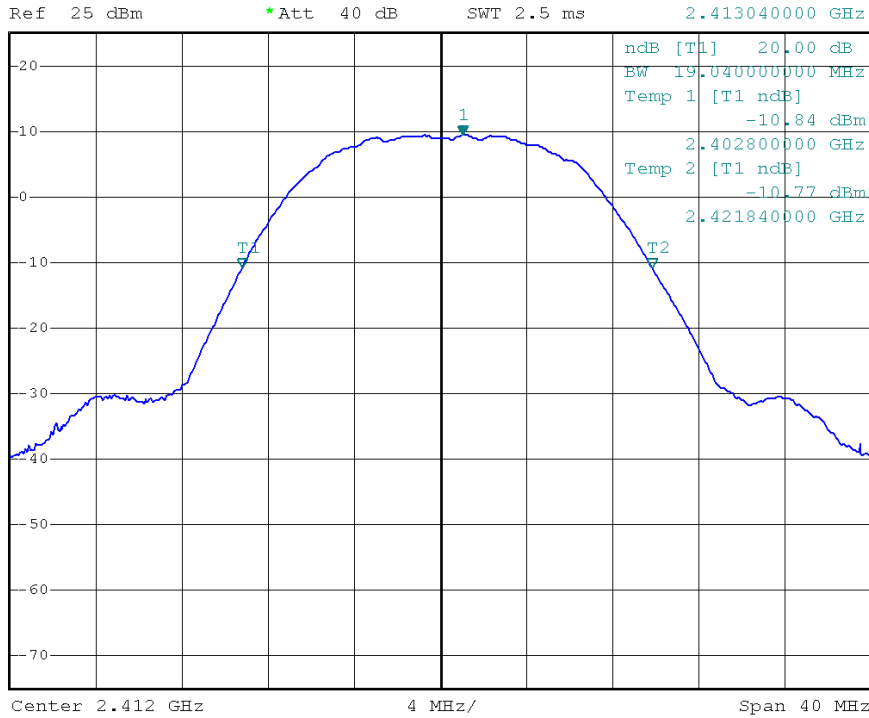

Test Mode: 802.11b---Mid



*RBW 300 kHz Marker 1 [T1] 9.80 dBm
*VBW 1 MHz
SWT 2.5 ms 2.438040000 GHz

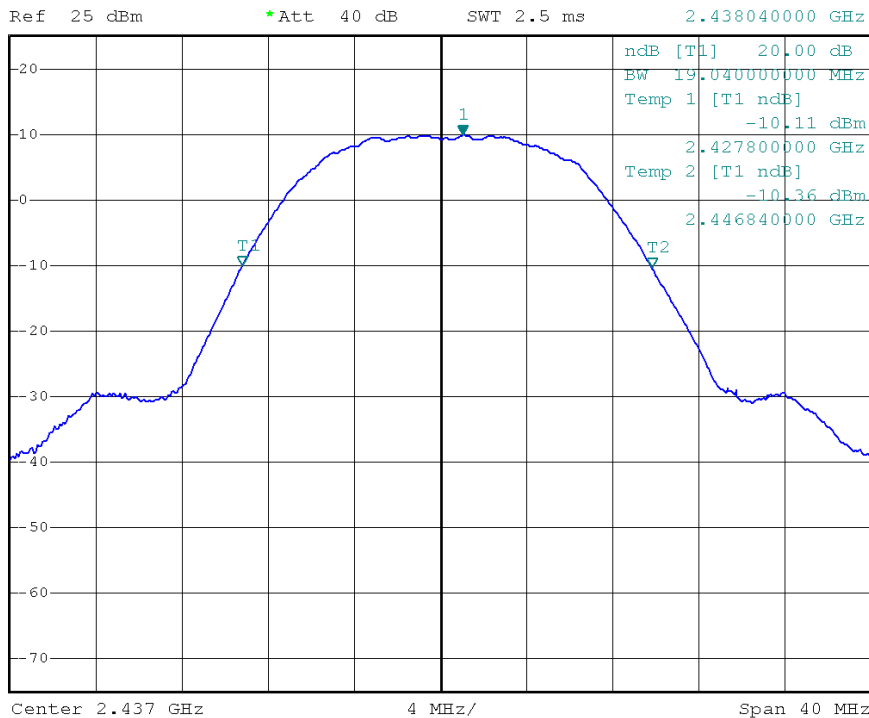

Test Mode: 802.11b---High

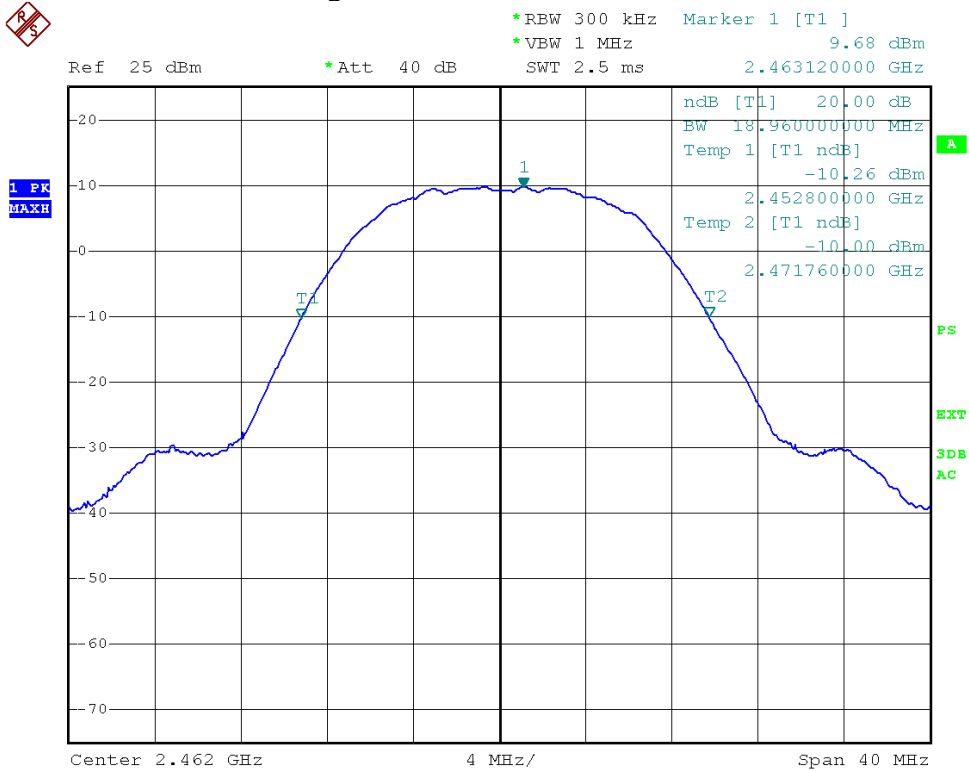

Test Mode: 802.11g---Low

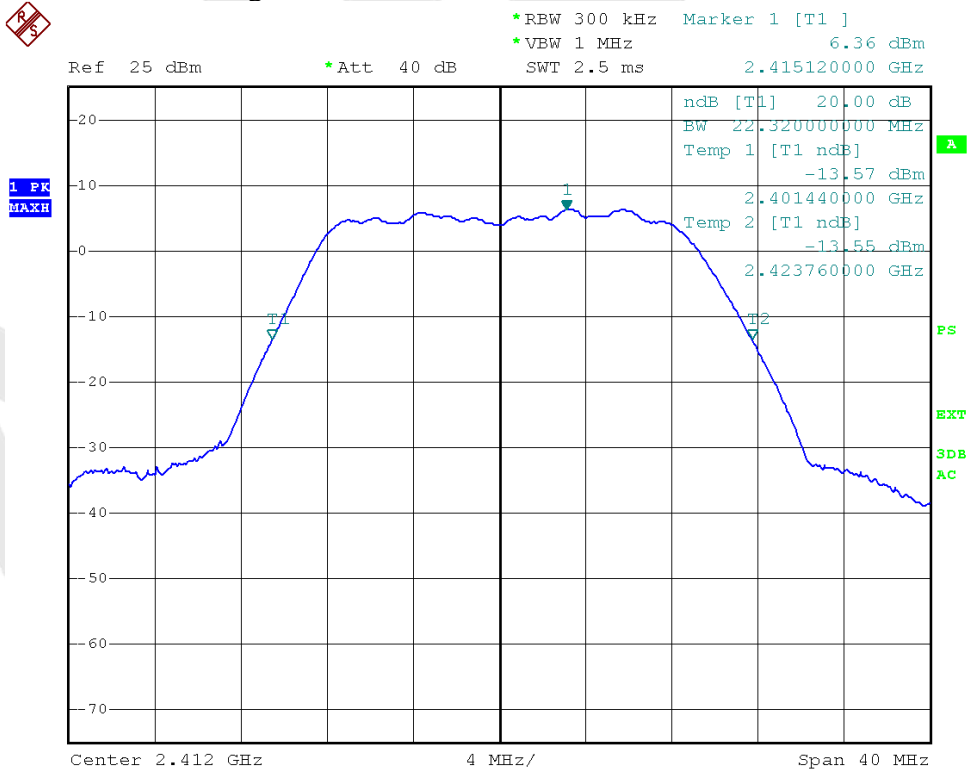

Test Mode: 802.11g---Mid



*RBW 300 kHz Marker 1 [T1]
*VBW 1 MHz 6.38 dBm
SWT 2.5 ms 2.442280000 GHz

Ref 25 dBm *Att 40 dB

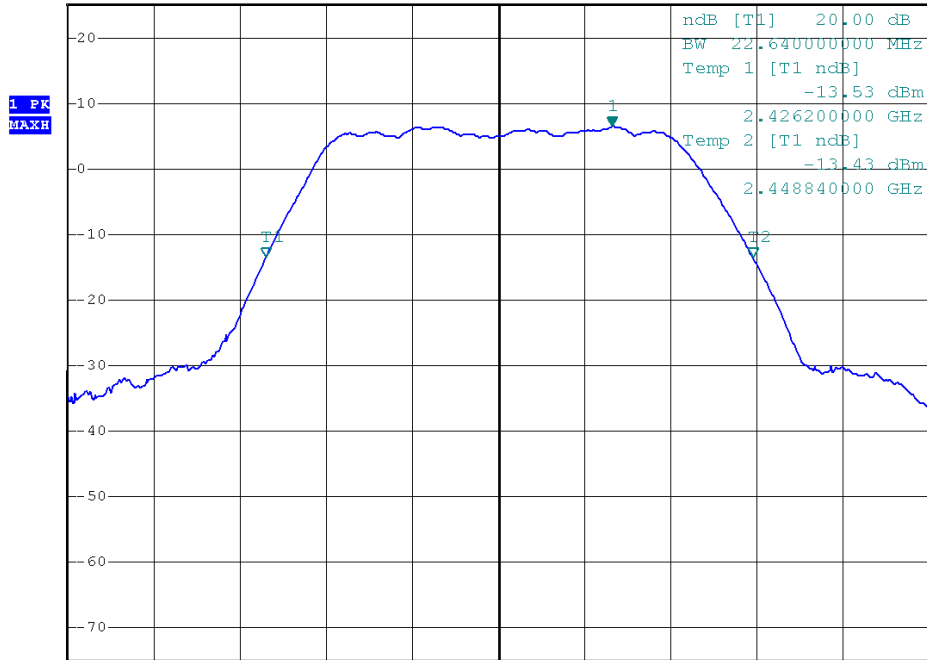

Center 2.437 GHz 4 MHz/ Span 40 MHz

Test Mode: 802.11g---High



*RBW 300 kHz Marker 1 [T1]
*VBW 1 MHz 7.12 dBm
SWT 2.5 ms 2.465200000 GHz

Ref 25 dBm *Att 40 dB

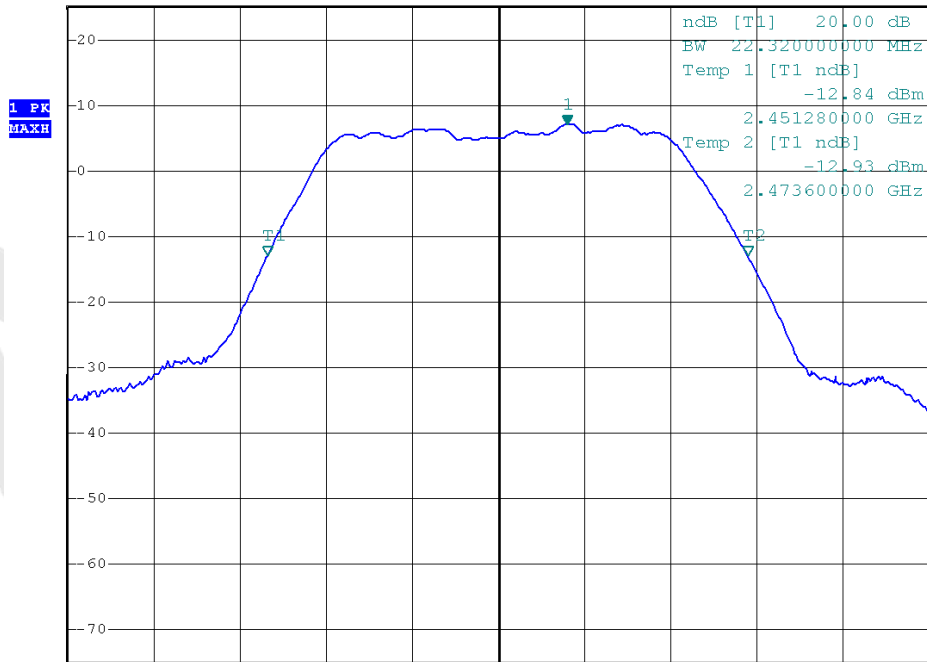

Center 2.462 GHz 4 MHz/ Span 40 MHz

Test Mode: 802.11n (HT20)---Low

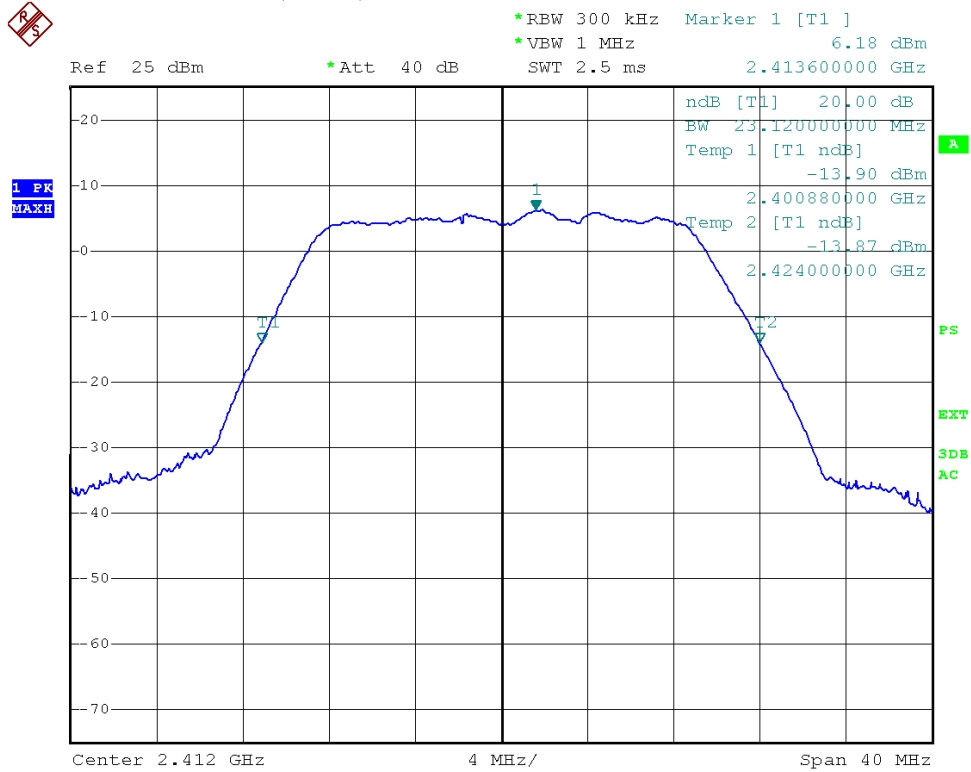

Test Mode: 802.11n (HT20)---Mid

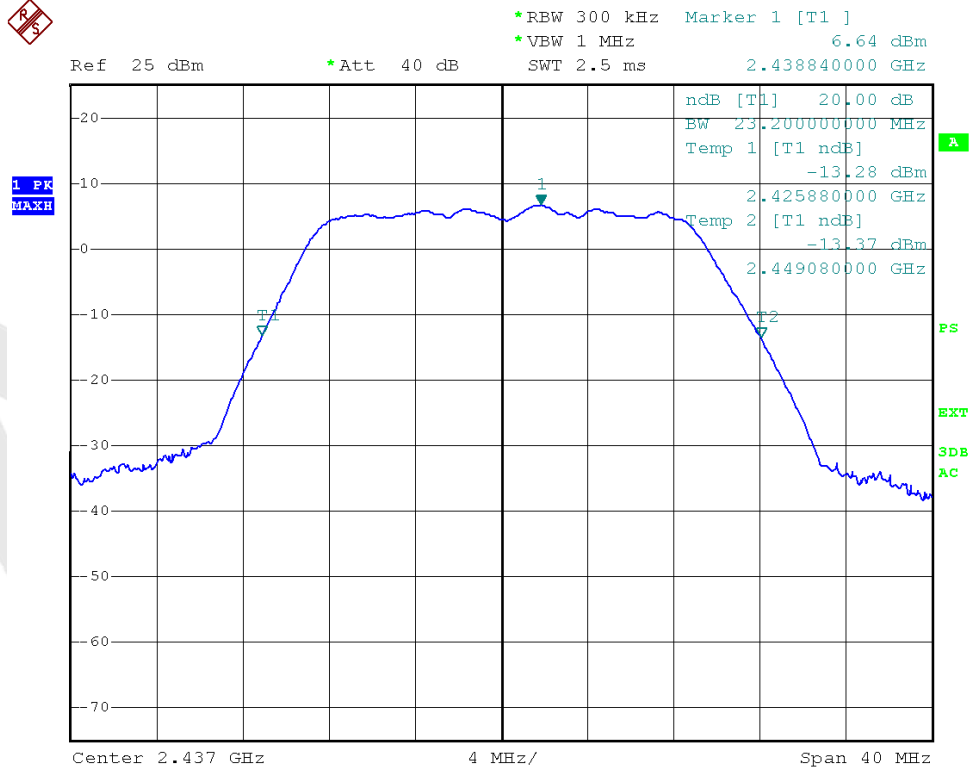

Test Mode: 802.11n (HT20)---High



*RBW 300 kHz Marker 1 [T1] 6.71 dBm
*VBW 1 MHz
SWT 2.5 ms 2.463600000 GHz

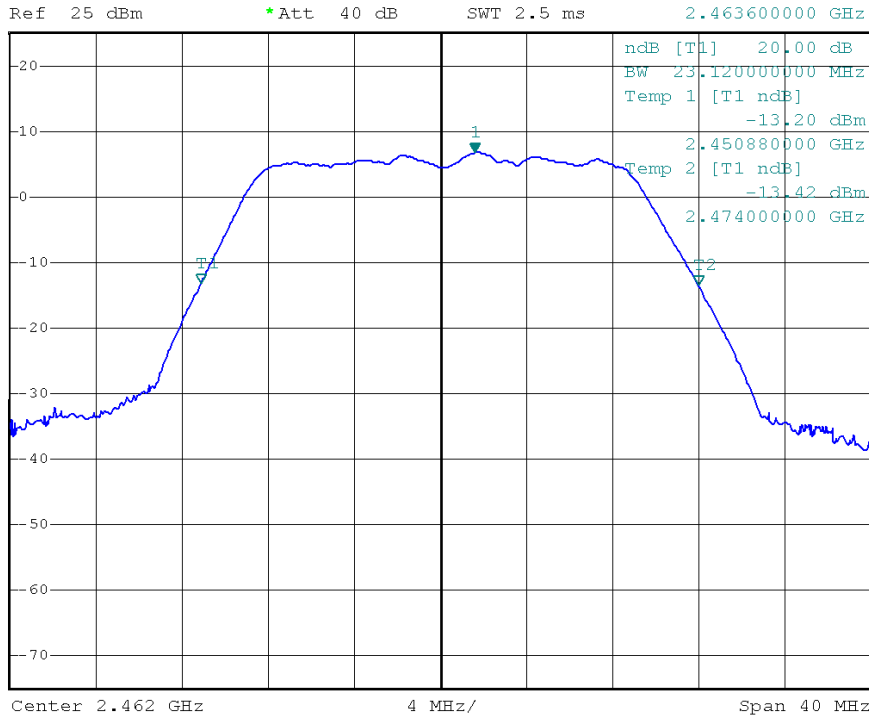

Test Mode: 802.11n (HT40)---Low



*RBW 300 kHz Marker 1 [T1] 3.45 dBm
*VBW 1 MHz
SWT 2.5 ms 2.414960000 GHz

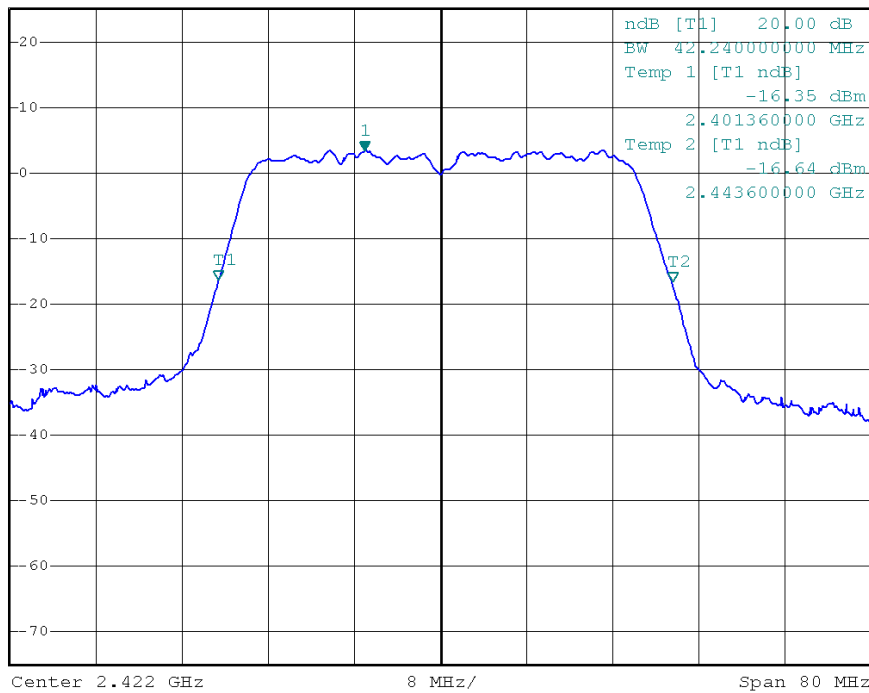

Test Mode: 802.11n (HT40)---Mid



*RBW 300 kHz Marker 1 [T1] 3.44 dBm
*VBW 1 MHz
SWT 2.5 ms 2.426600000 GHz

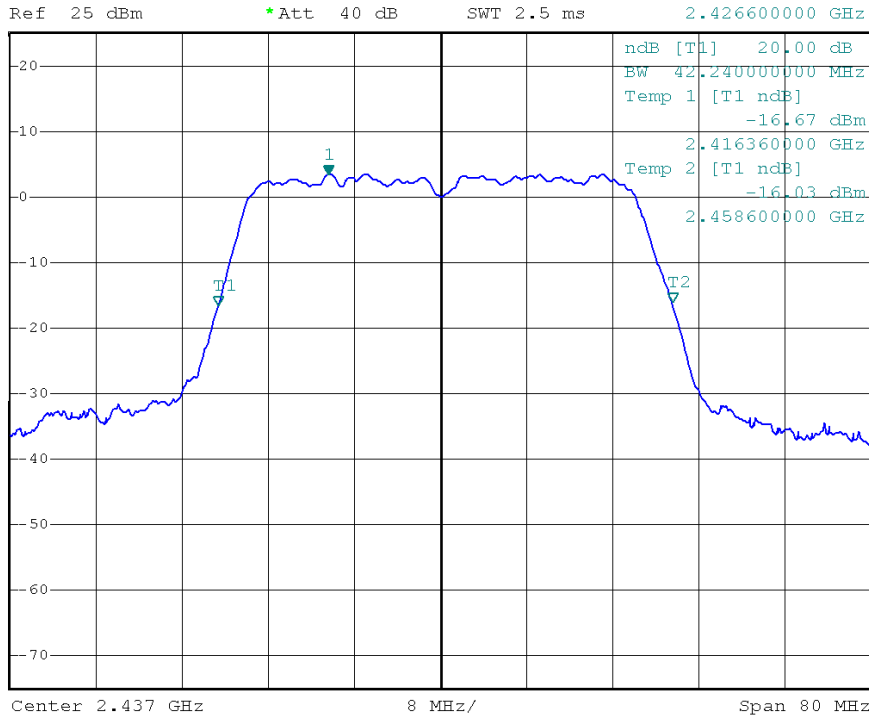

Test Mode: 802.11n (HT40)---High



*RBW 300 kHz Marker 1 [T1] 3.86 dBm
*VBW 1 MHz
SWT 2.5 ms 2.445280000 GHz

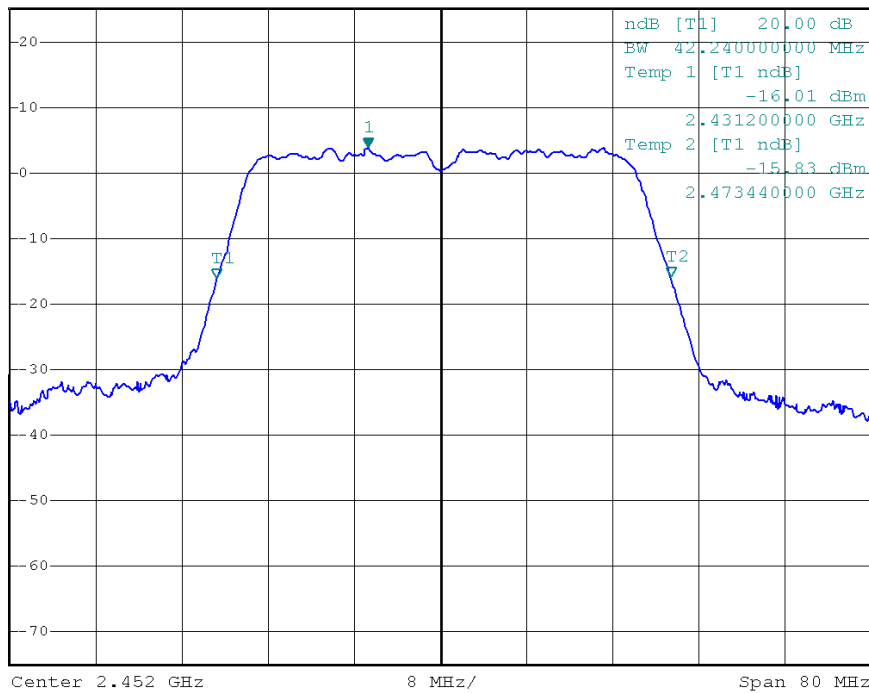

4.3. Maximum Output Power Test

a. Limit

The maximum output power of the intentional radiator shall not exceed the following:

1. For systems using digital modulation in the bands of 902-928 MHz, 2400-2483.5 MHz, and 5725-5850 MHz: 1 watt (30dBm).
2. Except as shown in paragraphs (b)(3) (i), (ii) and (iii) of this section, if transmitting antenna of directional gain greater than 6 dBi are used the peak output power from the intentional radiator shall be reduced below the stated values in paragraphs (b)(1) or (b)(2) of this section, as appropriate, by the amount in dB that the directional gain of the antenna exceeds 6 dBi.

b. Configuration of Measurement

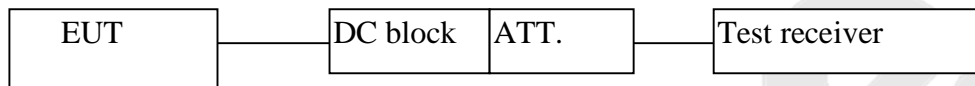

c. Data Rates

IEEE802.11b: Channel 1(2412MHz), Channel 6(2437MHz) and Channel 11(2462MHz) with 1 Mbps data rate (worst case) are chosen for the final testing.

IEEE802.11g: Channel 1(2412MHz), Channel 6(2437MHz) and Channel 11(2462MHz) with 6 Mbps data rate (the worst case) are chosen for the final testing.

IEEE802.11n (HT20: Channel 1(2412MHz), Channel 6(2437MHz) and Channel 11(2462MHz) with 6.5Mbps data rate (the worst case) are chosen for the final testing.

IEEE802.11n (HT40: Channel 3(2422MHz), Channel 6(2437MHz) and Channel 9(2452MHz) with 13.5Mbps data rate (the worst case) are chosen for the final testing.

d. Test Procedure

This test was according the kDB 558074 9.2.2:

1. Set span to at least 1.5 times the OBW.
2. Set the RBW =1~5% of the OBW, not to exceed 1MHz.
3. Set VBW $\geq 3 \times$ RBW.
4. Detector = Average.
5. Sweep time = auto couple.
6. Trace mode = max hold.
7. Allow trace to fully stabilize.

e. Test Equipment

Same as the equipment listed in 4.2.

f. Test Results

Pass.

g. Test Data

Test mode: IEEE 802.11b

Channel	Frequency (MHz)	Maximum transmit power (dBm)	Limit		Result
			(dBm)	(watts)	
Low	2412	14.66	30	1	Pass
Mid	2437	14.55			Pass
High	2462	14.17			Pass

Test mode: IEEE 802.11g

Channel	Frequency (MHz)	Maximum transmit power (dBm)	Limit		Result
			(dBm)	(watts)	
Low	2412	10.36	30	1	Pass
Mid	2437	10.73			Pass
High	2462	10.76			Pass

Test mode: IEEE 802.11n (HT20)

Channel	Frequency (MHz)	Maximum transmit power (dBm)	Limit		Result
			(dBm)	(watts)	
Low	2412	9.98	30	1	Pass
Mid	2437	10.29			Pass
High	2462	10.82			Pass

Test mode: IEEE 802.11n (HT40)

Channel	Frequency (MHz)	Maximum transmit power (dBm)	Limit		Result
			(dBm)	(watts)	
Low	2422	9.40	30	1	Pass
Mid	2437	9.59			Pass
High	2452	9.97			Pass

Test Mode: 802.11b---Low



*RBW 300 kHz
*VBW 3 MHz
SWT 2.5 ms

Marker 1 [T1]
0.09 dBm
2.413440000 GHz

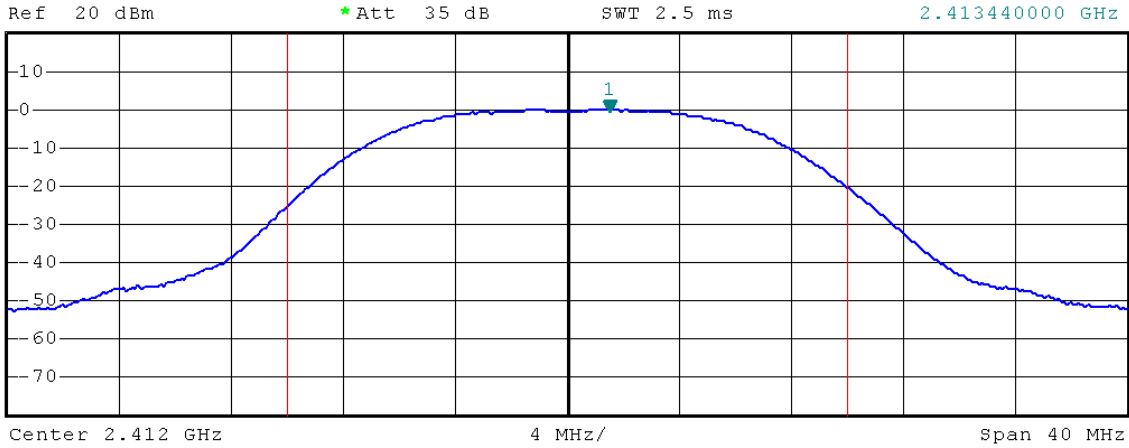

Tx Channel
Bandwidth 20 MHz Power 14.66 dBm

Test Mode: 802.11b---Mid



*RBW 300 kHz
*VBW 3 MHz
SWT 2.5 ms

Marker 1 [T1]
-0.06 dBm
2.438360000 GHz

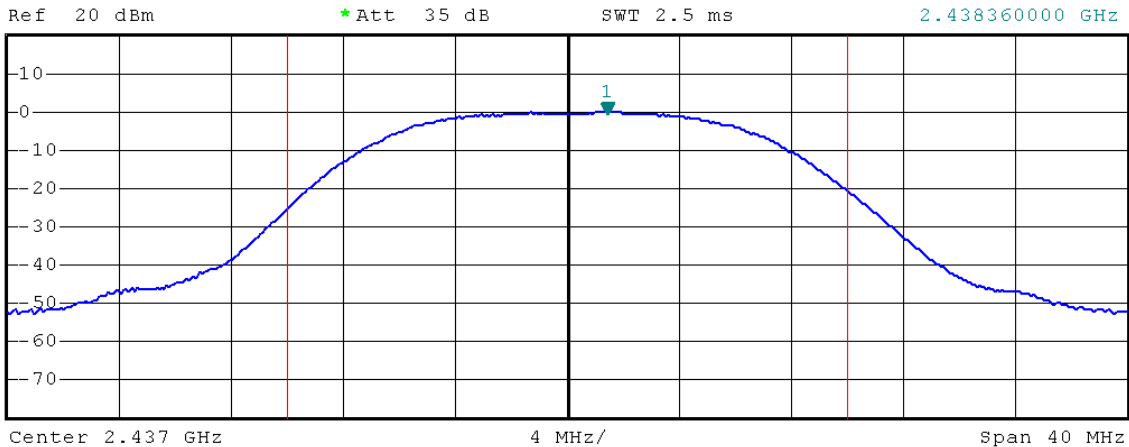

Tx Channel
Bandwidth 20 MHz Power 14.55 dBm

Test Mode: 802.11b---High



Ref 20 dBm *Att 35 dB *RBW 300 kHz Marker 1 [T1]
 *VBW 3 MHz -0.35 dBm
 SWT 2.5 ms 2.463680000 GHz

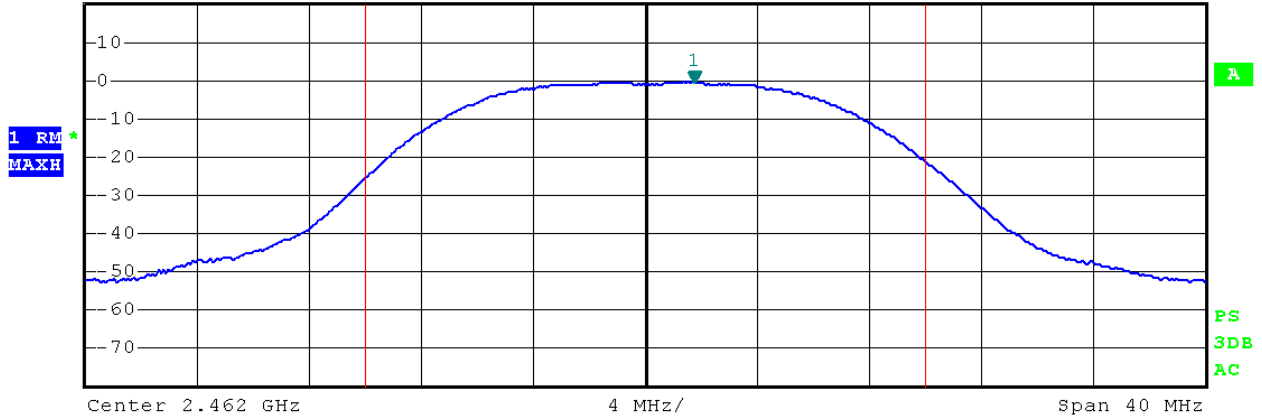

Tx Channel
 Bandwidth 20 MHz Power 14.17 dBm EXT

Test Mode: 802.11g---Low



Ref 20 dBm *Att 35 dB *RBW 300 kHz Marker 1 [T1]
 *VBW 3 MHz -5.76 dBm
 SWT 2.5 ms 2.413200000 GHz

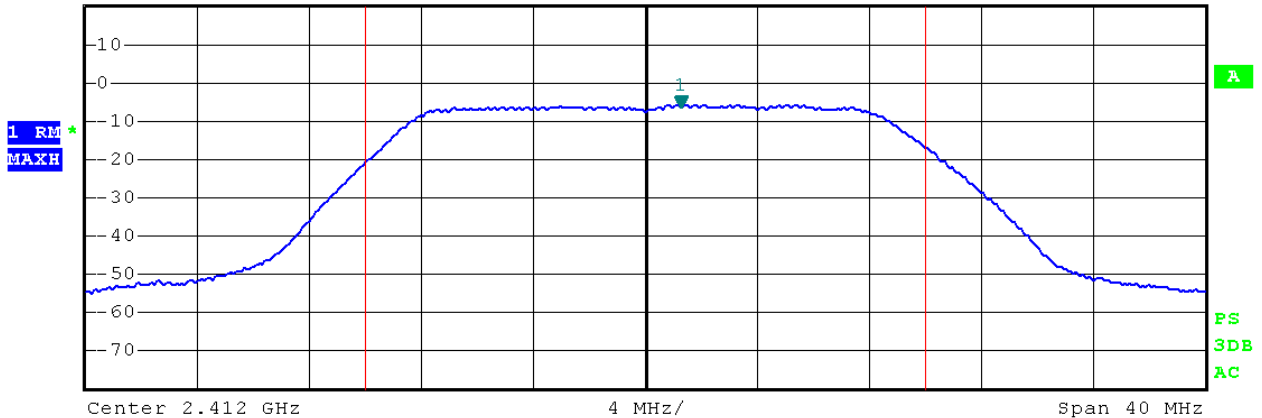

Tx Channel
 Bandwidth 20 MHz Power 10.36 dBm EXT

Test Mode: 802.11g---Mid



Ref 20 dBm *Att 35 dB *RBW 300 kHz *VBW 3 MHz SWT 2.5 ms Marker 1 [T1] -5.37 dBm 2.442440000 GHz

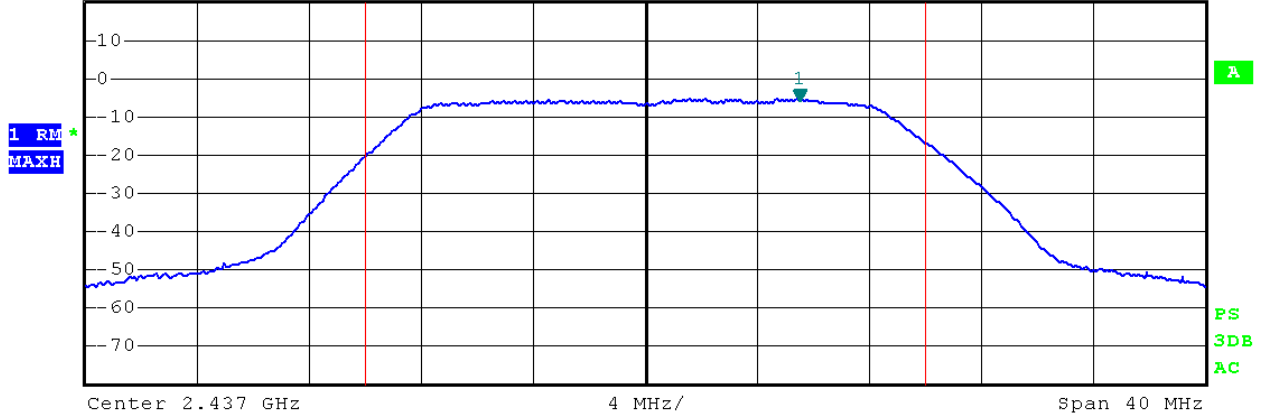

Tx Channel Bandwidth 20 MHz Power 10.73 dBm EXT

Test Mode: 802.11g---High



Ref 20 dBm *Att 35 dB *RBW 300 kHz *VBW 3 MHz SWT 2.5 ms Marker 1 [T1] -5.20 dBm 2.467200000 GHz

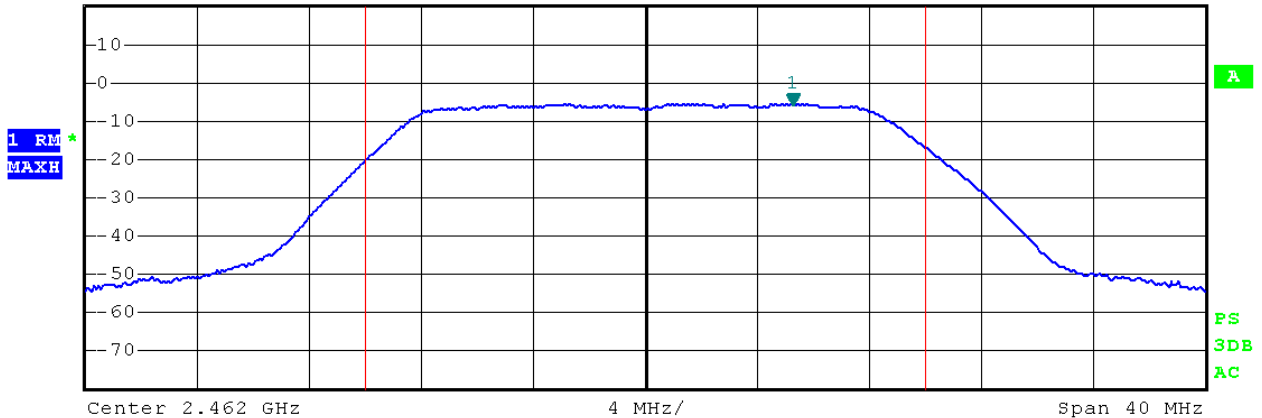

Tx Channel Bandwidth 20 MHz Power 10.76 dBm EXT

Test Mode: 802.11n(HT20)---Low

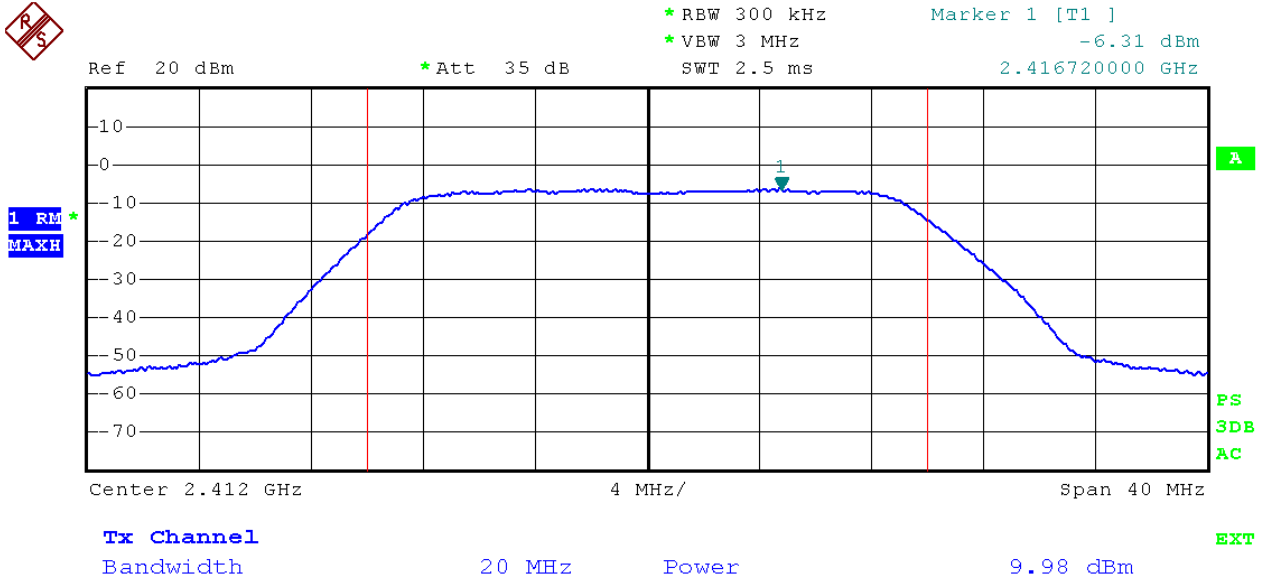

Test Mode: 802.11n(HT20)---Mid

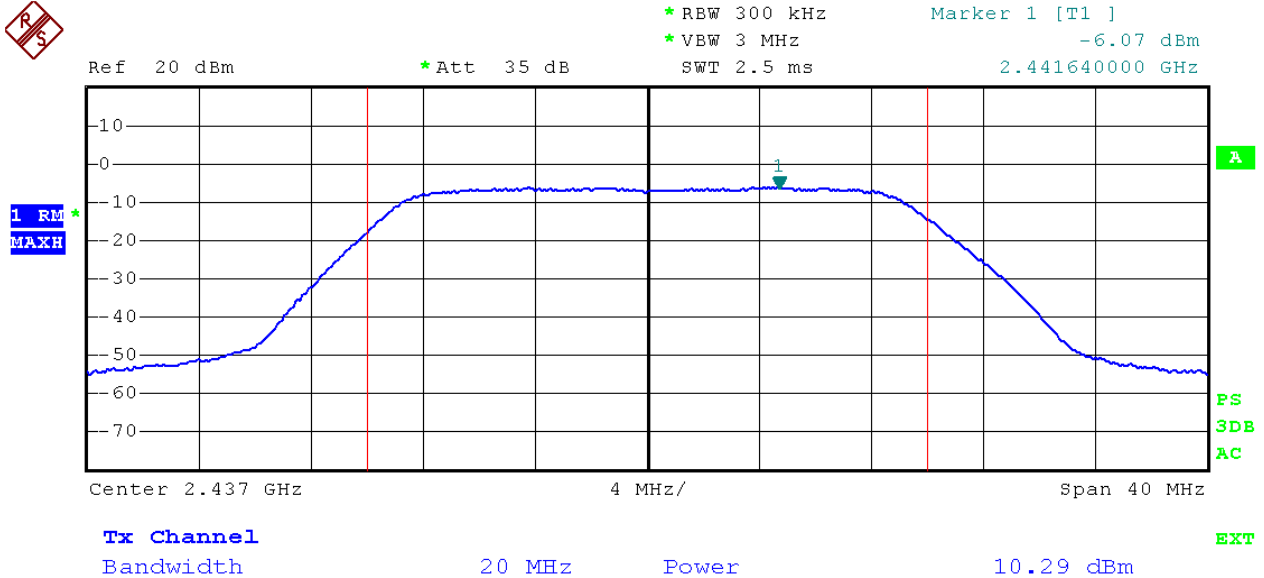

Test Mode: 802.11n(HT20)---High



Ref 20 dBm *Att 35 dB *RBW 300 kHz *VBW 3 MHz SWT 2.5 ms Marker 1 [T1] -5.57 dBm 2.466640000 GHz

1 RM *
MAXH

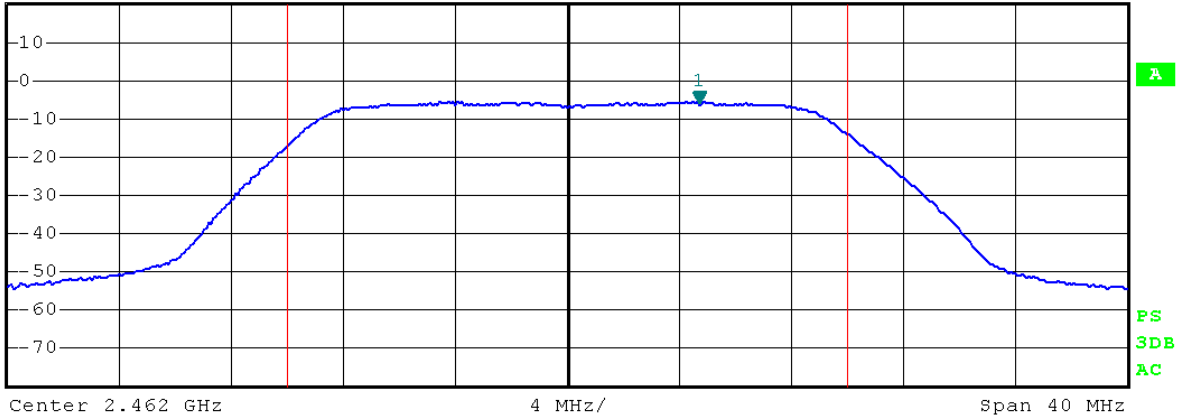

Tx Channel Bandwidth 20 MHz Power 10.82 dBm

Test Mode: 802.11n(HT40)---Low



Ref 20 dBm *Att 35 dB *RBW 300 kHz *VBW 3 MHz SWT 2.5 ms Marker 1 [T1] -10.12 dBm 2.437840000 GHz

1 RM *
MAXH

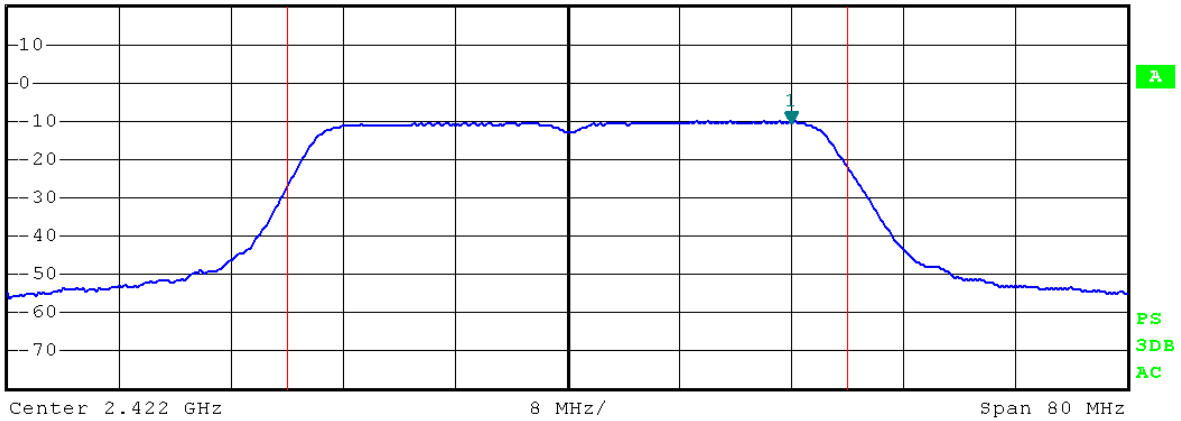

Tx Channel Bandwidth 40 MHz Power 9.40 dBm

Test Mode: 802.11n(HT40)---Mid

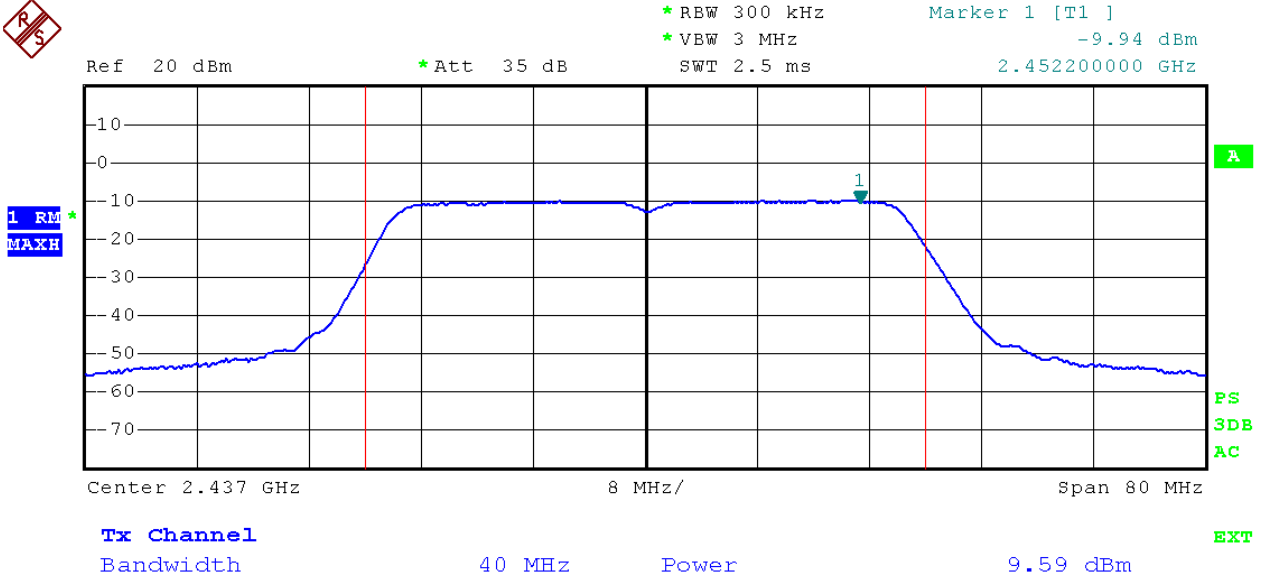

Test Mode: 802.11n(HT40)---High

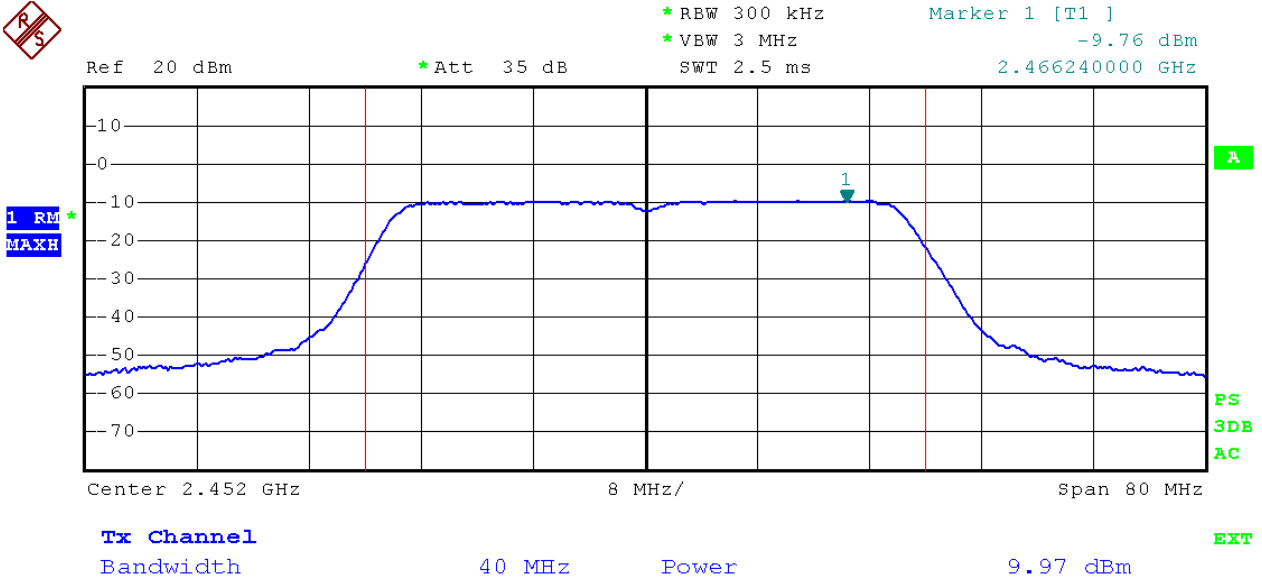

4.4. Band Edges Measurement

a. Limit

According to §15.247(c), in any 100 kHz bandwidth outside the frequency bands in which the spread spectrum intentional radiator is operating, the radio frequency power that is produced by the intentional radiator shall be at least 20dB below that in the 100kHz bandwidth within the band that contains the highest level of the desired power, In addition, radiated emissions which fall in the restricted bands, as defined in §15.205(a), must also comply with the radiated emission limits specified in §15.209(a).

b. Test Procedure

1. Conducted Method:

- 1) Set RBW=100KHz, VBW=300KHz
- 2) Detector=peak
- 3) Sweep time= auto
- 4) Trace mode=max hold.

2. Radiated Method:

- 1) For below 1GHz: The EUT is placed on a turntable, which is 0.8m above the ground plane. The EUT is tested in 9*6*6 Chamber.
For above 1GHz: The EUT is placed on a turntable, which is 1.5m above the ground plane. The EUT is tested in 9*6*6 Chamber.
- 2) The turntable shall be rotated for 360 degrees to determine the position of maximum emission level.
- 3) EUT is set 3m away from the receiving antenna, which is varied from 1m to 4m to find out the highest emission.
- 4) Peak detector: RBW=1MHz, VBW=3MHz, SWT=AUTO
Average detector: RBW=1MHz, VBW=10Hz, SWT=AUTO
The EUT is tested in 9*6*6 Chamber.
- 5) Repeat the procedures until all the PEAK and AVERAGE versus POLARIZATION are measured.

30M to 1G emissions:

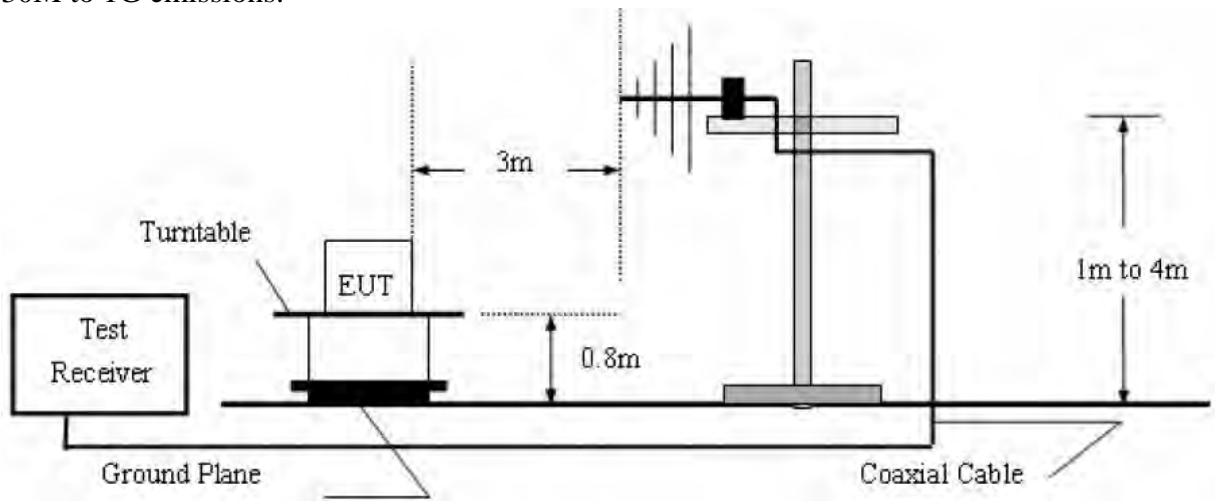

1G to 40G emissions:

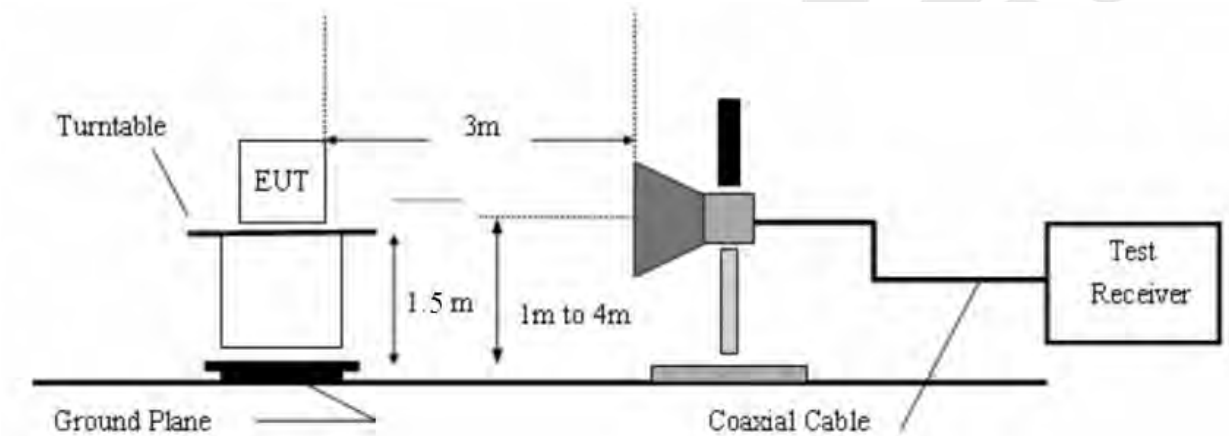

c. Test Equipment

Same as the equipment listed in 4.2.

d. Test Results

Pass.

e. Test Plots

See the following page.

Test Mode: 802.11b ---Low

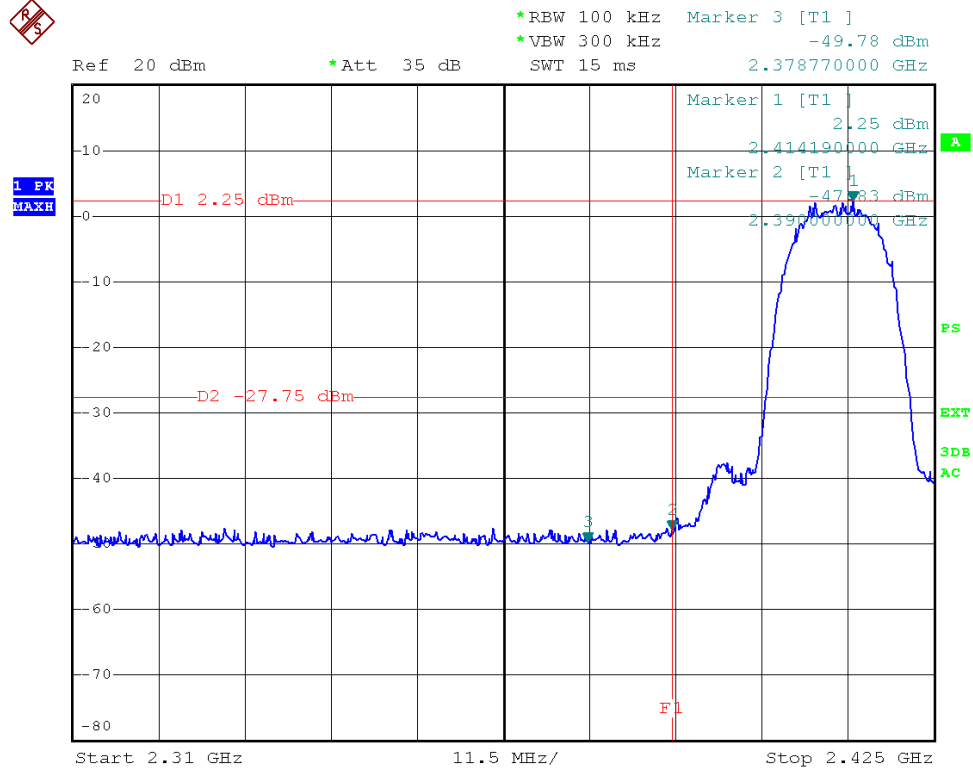

Test Mode: 802.11b ---High

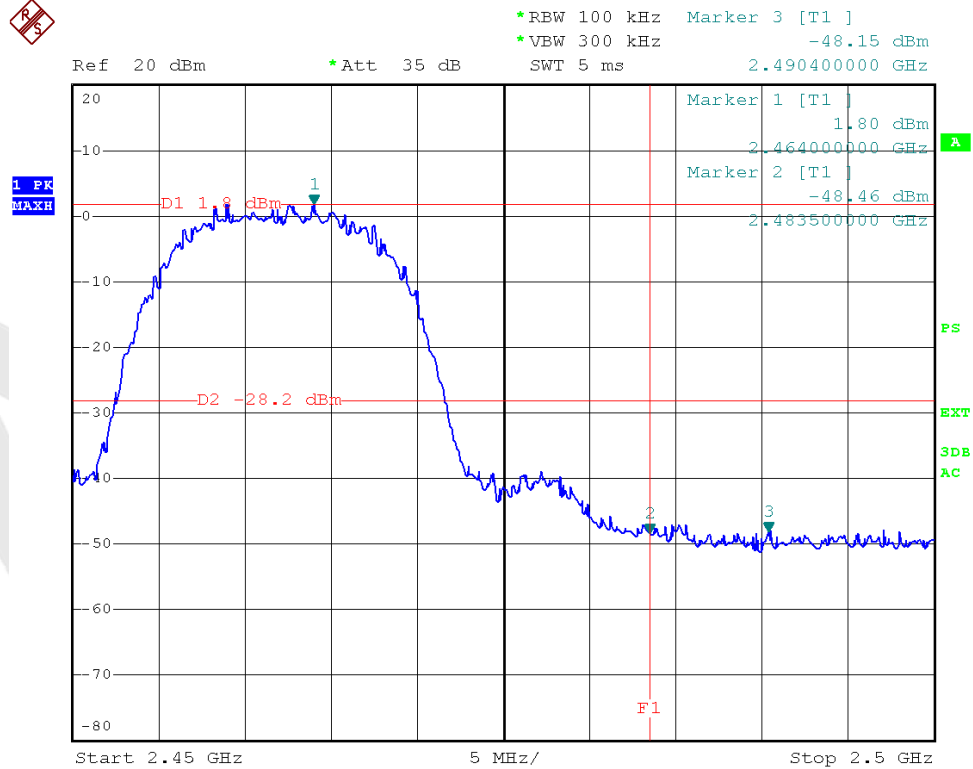

Test Mode: 802.11g ---Low



*RBW 100 kHz Marker 3 [T1]
*VBW 300 kHz -47.37 dBm
SWT 15 ms 2.375320000 GHz

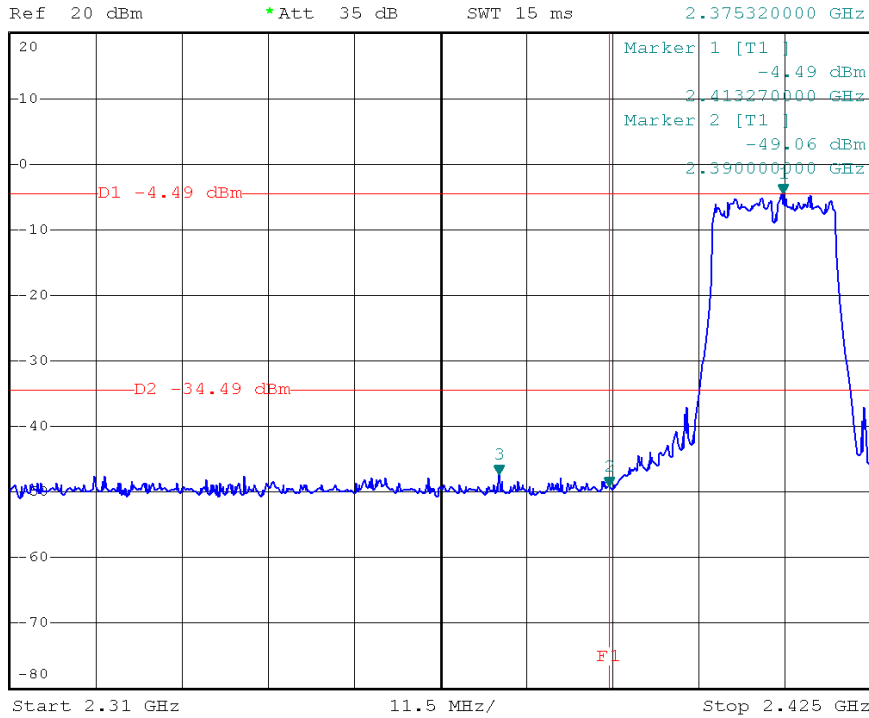

Test Mode: 802.11g ---High



*RBW 100 kHz Marker 3 [T1]
*VBW 300 kHz -49.23 dBm
SWT 5 ms 2.488800000 GHz

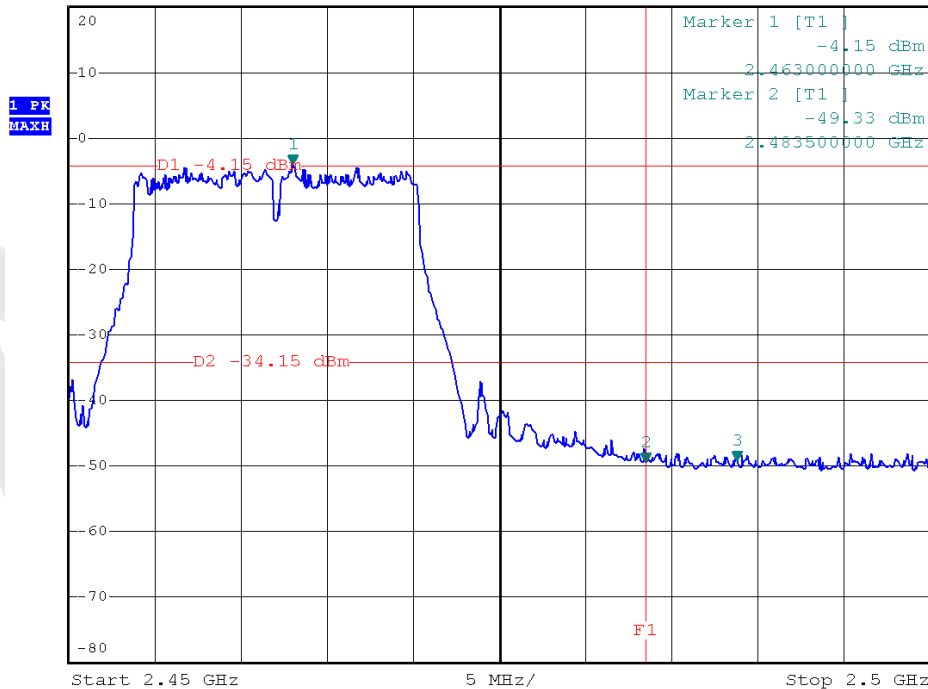

Test Mode: 802.11n (HT20) ---Low

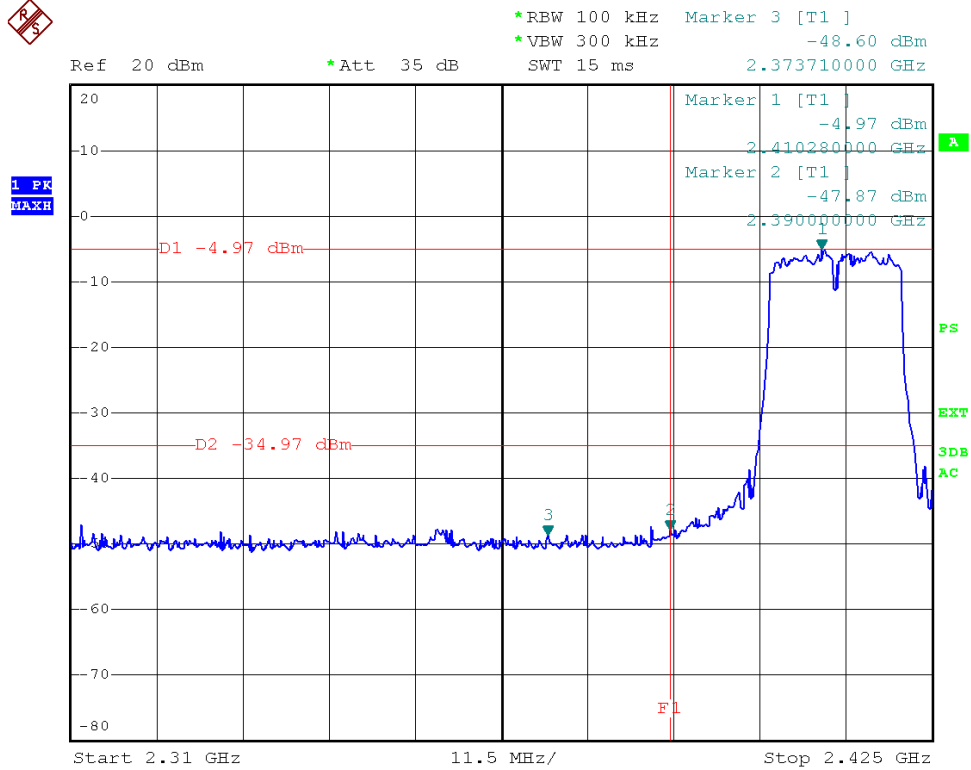

Test Mode: 802.11n (HT20)---High

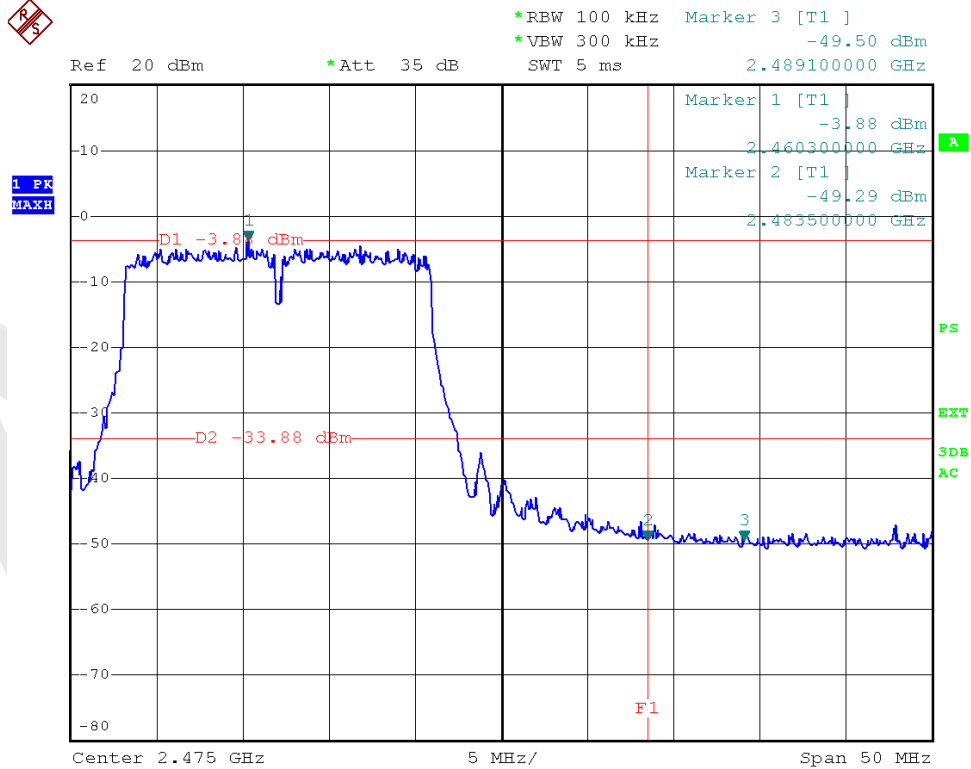

Test Mode: 802.11n (HT40) ---Low



*RBW 100 kHz Marker 3 [T1]
*VBW 300 kHz -47.04 dBm
SWT 15 ms 2.375070000 GHz

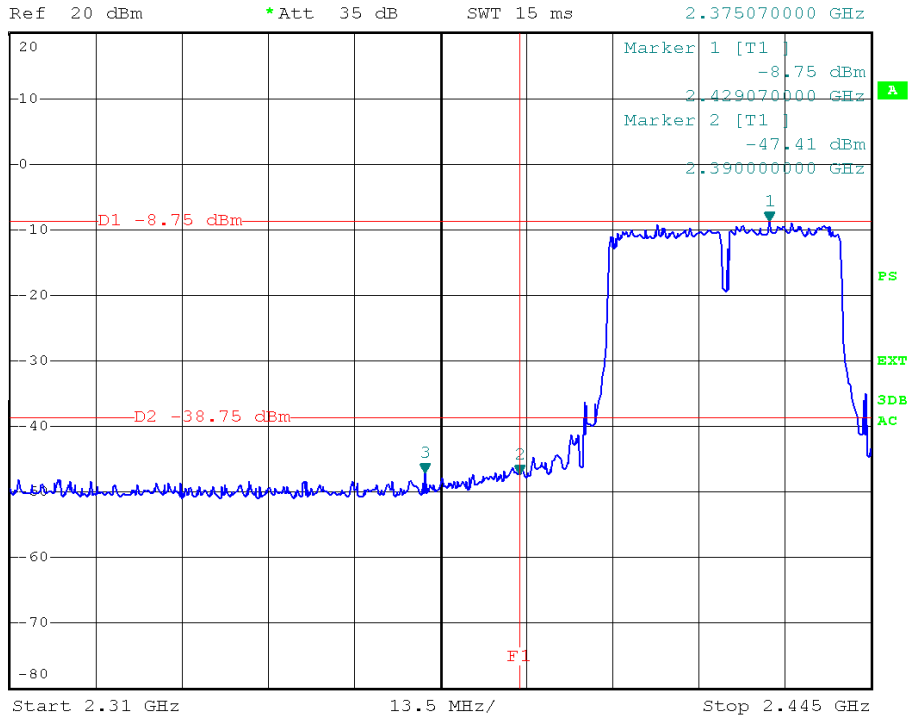

Test Mode: 802.11n (HT40) ---High



*RBW 100 kHz Marker 3 [T1]
*VBW 300 kHz -47.34 dBm
SWT 10 ms 2.488800000 GHz

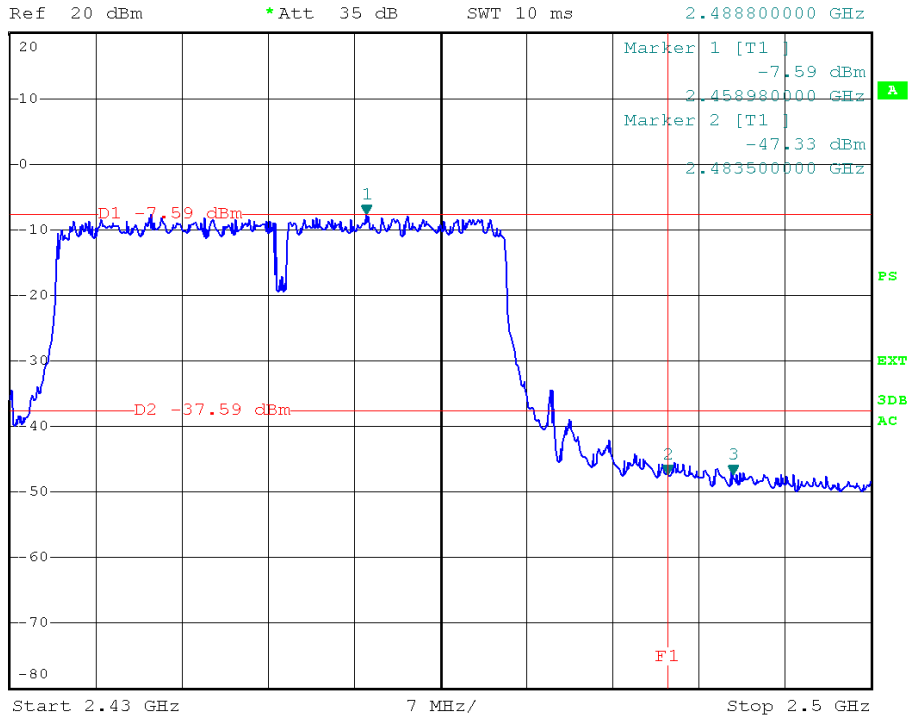

Test Mode: 802.11b

2412MHz

Horizontal-PEAK:

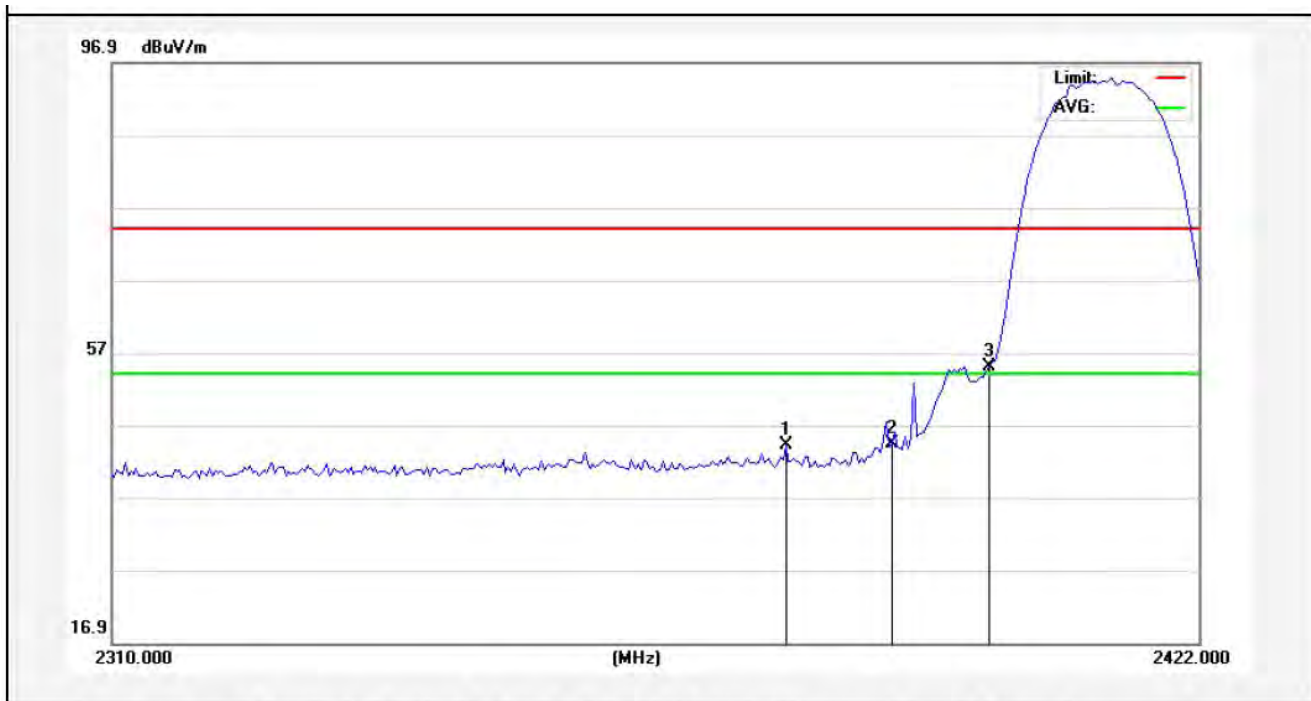

No.	Freq. (MHz)	Reading (dBuV/m)	Factor (dB/m)	Result (dBuV/m)	Limit (dBuV/)	Over Limit (dB)	Detector	Height (cm)	degree (deg)	Remark
1	2378.880	46.78	-2.54	44.24	74.00	-29.76	peak			
2	2390.000	46.82	-2.51	44.31	74.00	-29.69	peak			
3	2400.000	57.49	-2.49	55.00	74.00	-19.00	peak			

AMB

Horizontal-AV:

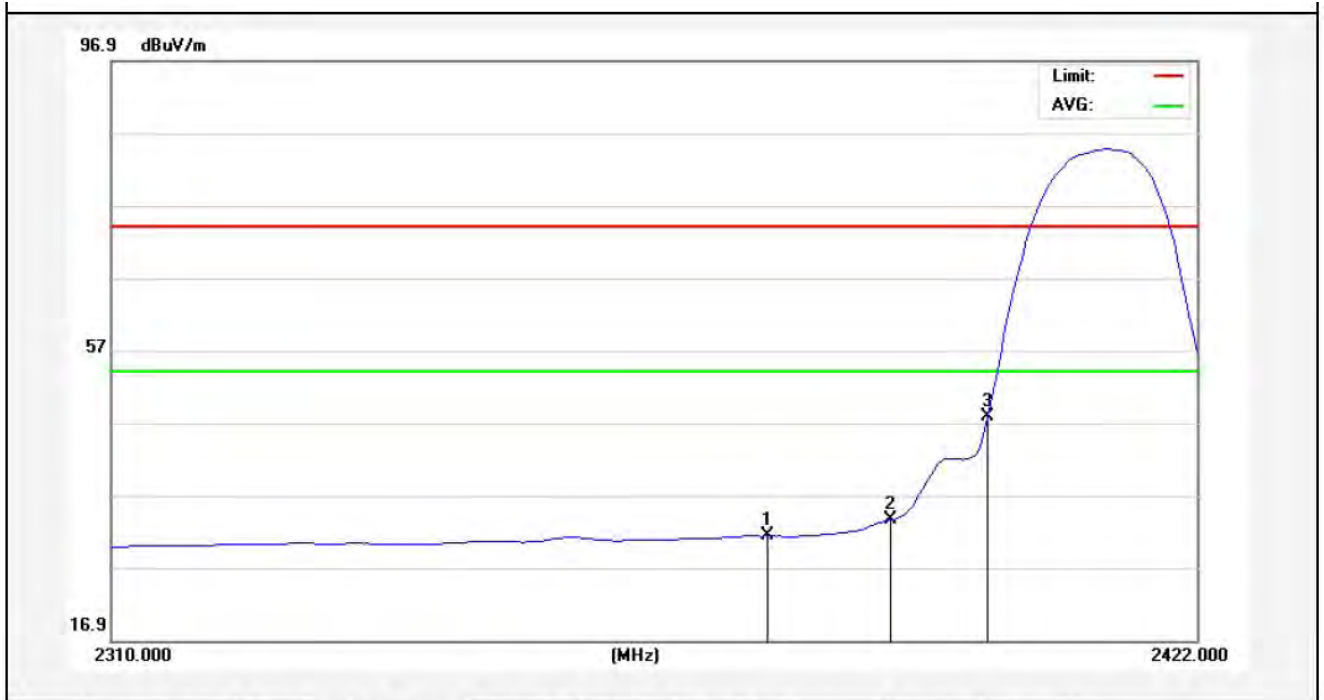

No.	Freq. (MHz)	Reading (dBuV/m)	Factor (dB/m)	Result (dBuV/m)	Limit (dBuV/)	Over Limit (dB)	Detector	Height (cm)	degree (deg)	Remark
1	2377.200	33.88	-2.54	31.34	54.00	-22.66	AVG			
2	2390.000	36.02	-2.51	33.51	54.00	-20.49	AVG			
3	2400.000	50.27	-2.49	47.78	54.00	-6.22	AVG			

Anbotek

Test Mode: 802.11b

2412MHz

Vertical-PEAK:

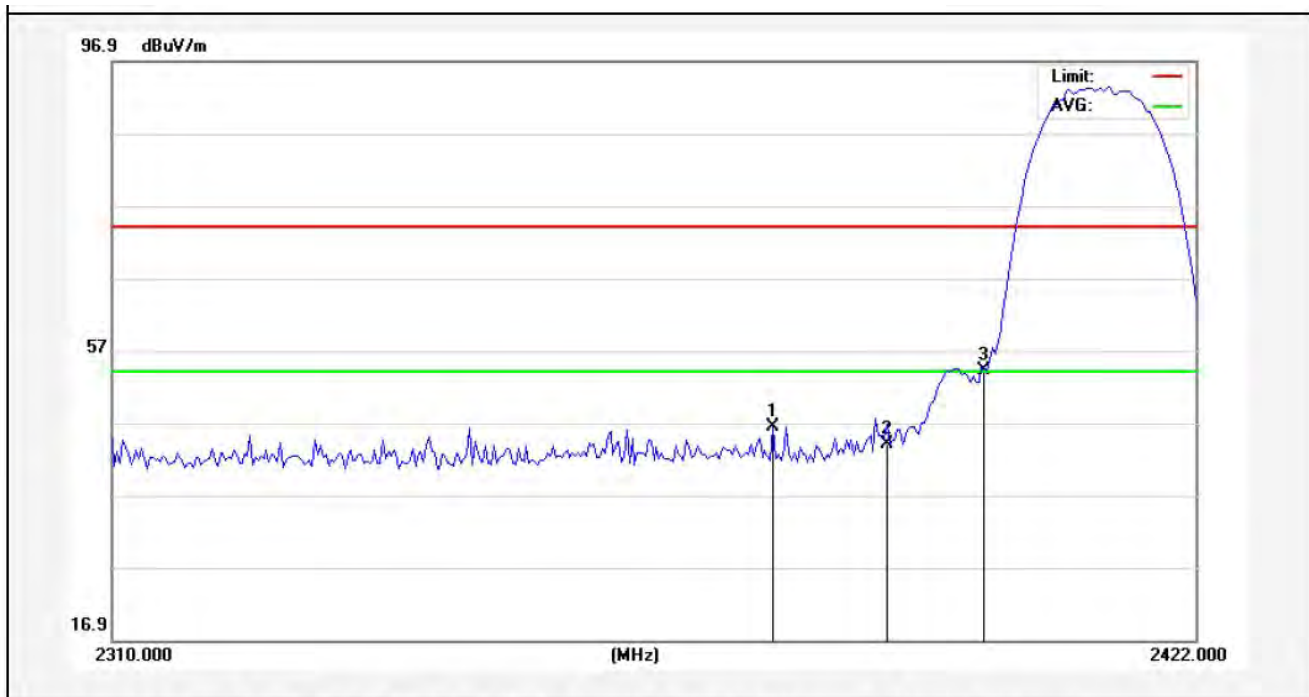

No.	Freq. (MHz)	Reading (dBuV/m)	Factor (dB/m)	Result (dBuV/m)	Limit (dBuV/)	Over Limit (dB)	Detector	Height (cm)	degree (deg)	Remark
1	2377.760	49.02	-2.54	46.48	74.00	-27.52	peak			
2	2390.000	46.58	-2.51	44.07	74.00	-29.93	peak			
3	2400.000	56.64	-2.49	54.15	74.00	-19.85	peak			

AMB

Vertical-AV:



No.	Freq. (MHz)	Reading (dBuV/m)	Factor (dB/m)	Result (dBuV/m)	Limit (dBuV/)	Over Limit (dB)	Detector	Height (cm)	degree (deg)	Remark
1	2373.000	34.42	-2.55	31.87	54.00	-22.13	AVG			
2	2390.000	36.67	-2.51	34.16	54.00	-19.84	AVG			
3	2400.000	51.11	-2.49	48.62	54.00	-5.38	AVG			

Anbotek

Test Mode: 802.11b
2462MHz
Horizontal-PEAK:

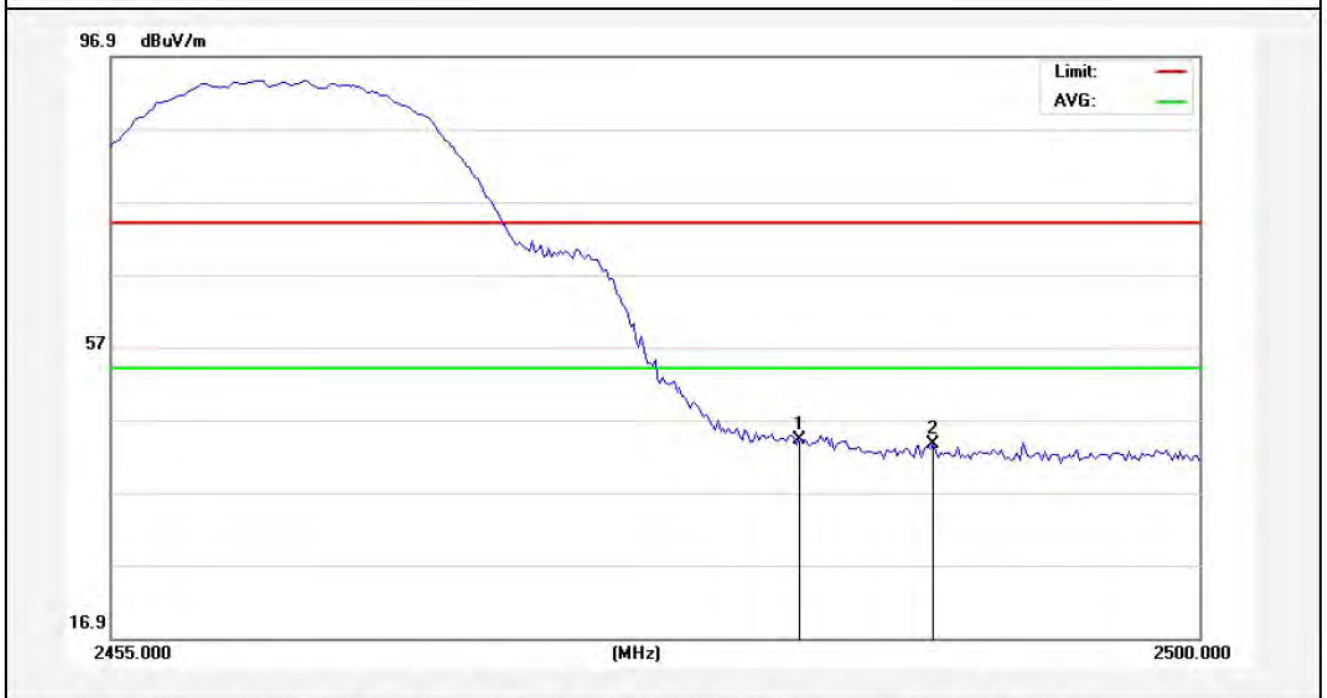

No.	Freq. (MHz)	Reading (dBuV/m)	Factor (dB/m)	Result (dBuV/m)	Limit (dBuV/)	Over Limit (dB)	Detector	Height (cm)	degree (deg)	Remark
1	2483.500	46.60	-2.31	44.29	74.00	-29.71	peak			
2	2488.975	45.92	-2.29	43.63	74.00	-30.37	peak			

Anbotek

Horizontal-AV:

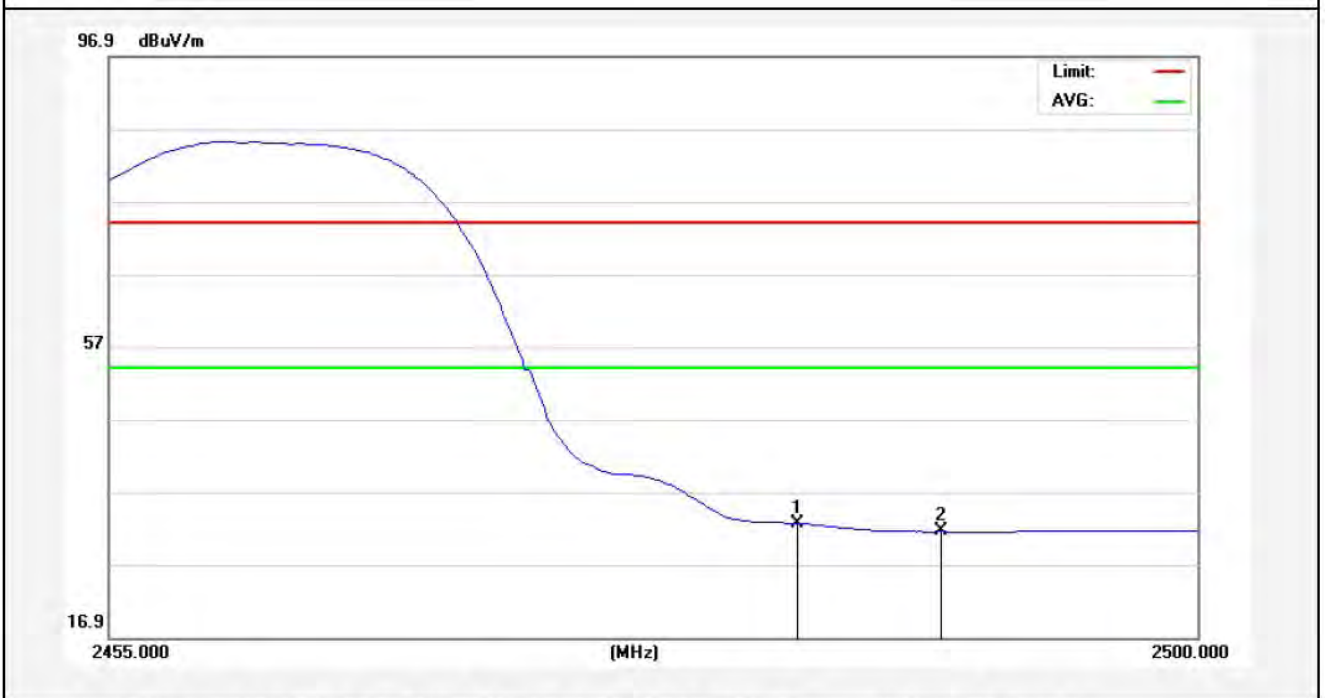

No.	Freq. (MHz)	Reading (dBuV/m)	Factor (dB/m)	Result (dBuV/m)	Limit (dBuV/)	Over Limit (dB)	Detector	Height (cm)	degree (deg)	Remark
1	2483.500	34.89	-2.31	32.58	54.00	-21.42	AVG			
2	2489.425	33.80	-2.29	31.51	54.00	-22.49	AVG			

Anbotek

Test Mode: 802.11b
2462MHz
Vertical-PEAK:

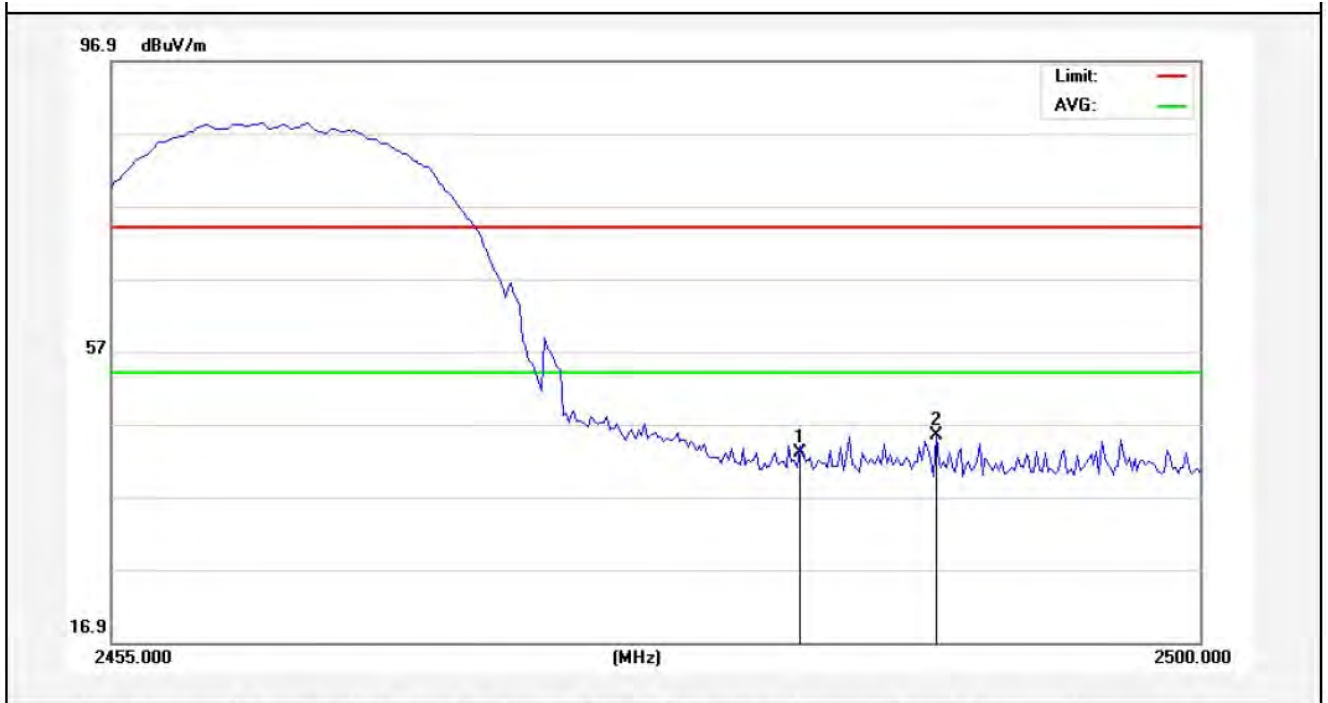

No.	Freq. (MHz)	Reading (dBuV/m)	Factor (dB/m)	Result (dBuV/m)	Limit (dBuV/)	Over Limit (dB)	Detector	Height (cm)	degree (deg)	Remark
1	2483.500	45.25	-2.31	42.94	74.00	-31.06	peak			
2	2489.088	47.62	-2.29	45.33	74.00	-28.67	peak			

Anbotek

Vertical-AV:

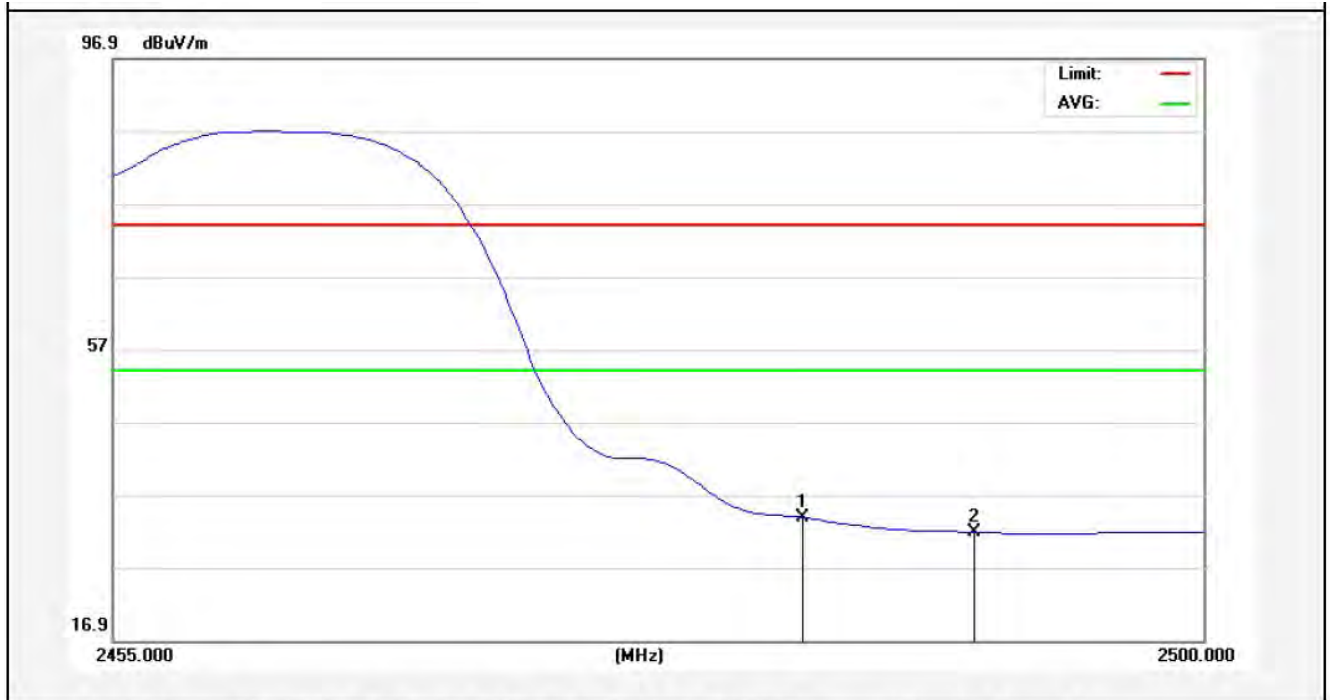

No.	Freq. (MHz)	Reading (dBuV/m)	Factor (dB/m)	Result (dBuV/m)	Limit (dBuV/)	Over Limit (dB)	Detector	Height (cm)	degree (deg)	Remark
1	2483.500	36.09	-2.31	33.78	54.00	-20.22	AVG			
2	2490.550	34.10	-2.29	31.81	54.00	-22.19	AVG			

Anbotek

Test Mode: 802.11g
2412MHz
Horizontal-PEAK:

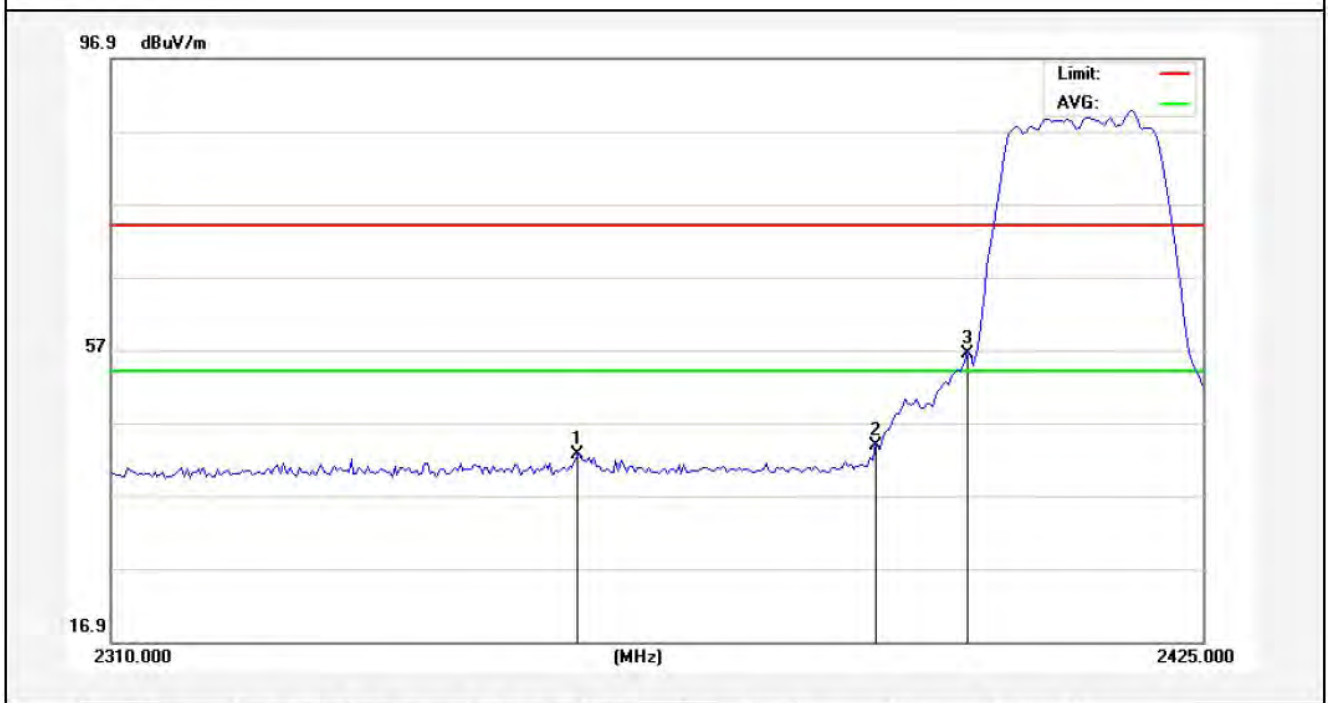

No.	Freq. (MHz)	Reading (dBuV/m)	Factor (dB/m)	Result (dBuV/m)	Limit (dBuV/)	Over Limit (dB)	Detector	Height (cm)	degree (deg)	Remark
1	2358.588	45.14	-2.58	42.56	74.00	-31.44	peak			
2	2390.000	46.25	-2.51	43.74	74.00	-30.26	peak			
3	2400.000	58.93	-2.49	56.44	74.00	-17.56	peak			

AMB

Horizontal-AV:

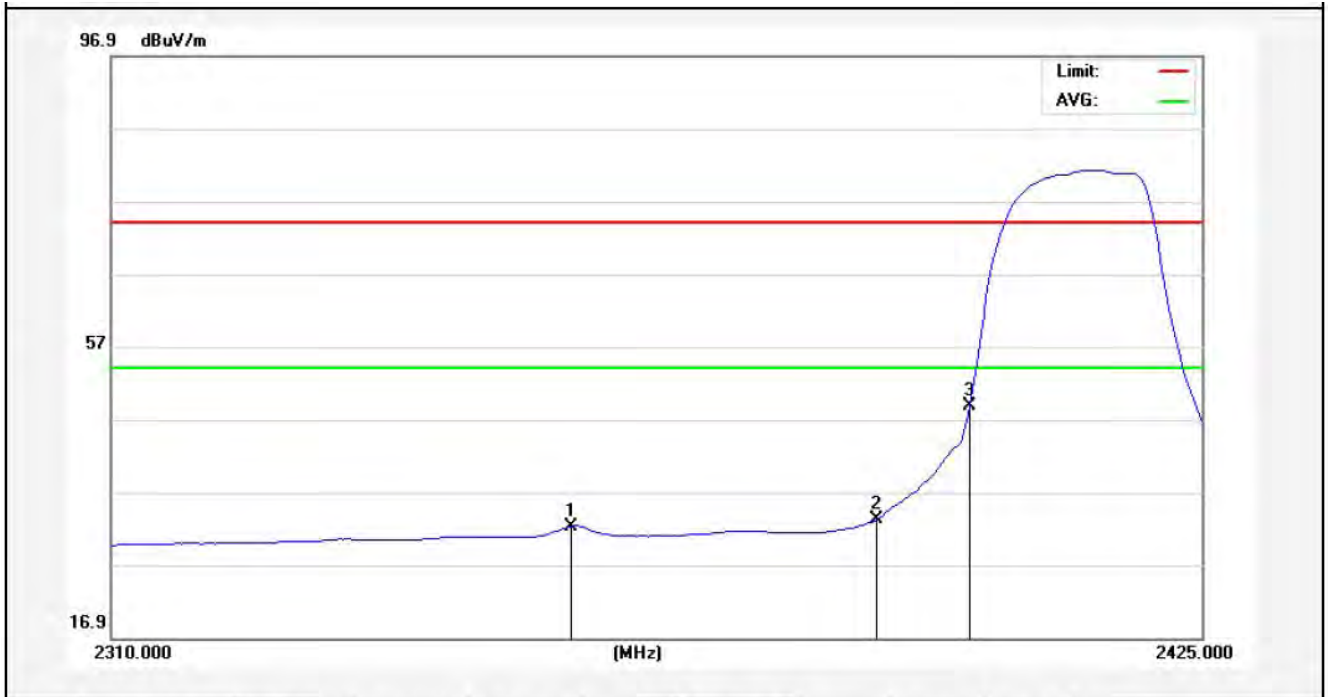

No.	Freq. (MHz)	Reading (dBuV/m)	Factor (dB/m)	Result (dBuV/m)	Limit (dBuV/)	Over Limit (dB)	Detector	Height (cm)	degree (deg)	Remark
1	2358.012	34.88	-2.59	32.29	54.00	-21.71	AVG			
2	2390.000	35.77	-2.51	33.26	54.00	-20.74	AVG			
3	2400.000	51.29	-2.49	48.80	54.00	-5.20	AVG			

Anbotek

Test Mode: 802.11g
2412MHz
Vertical-PEAK:

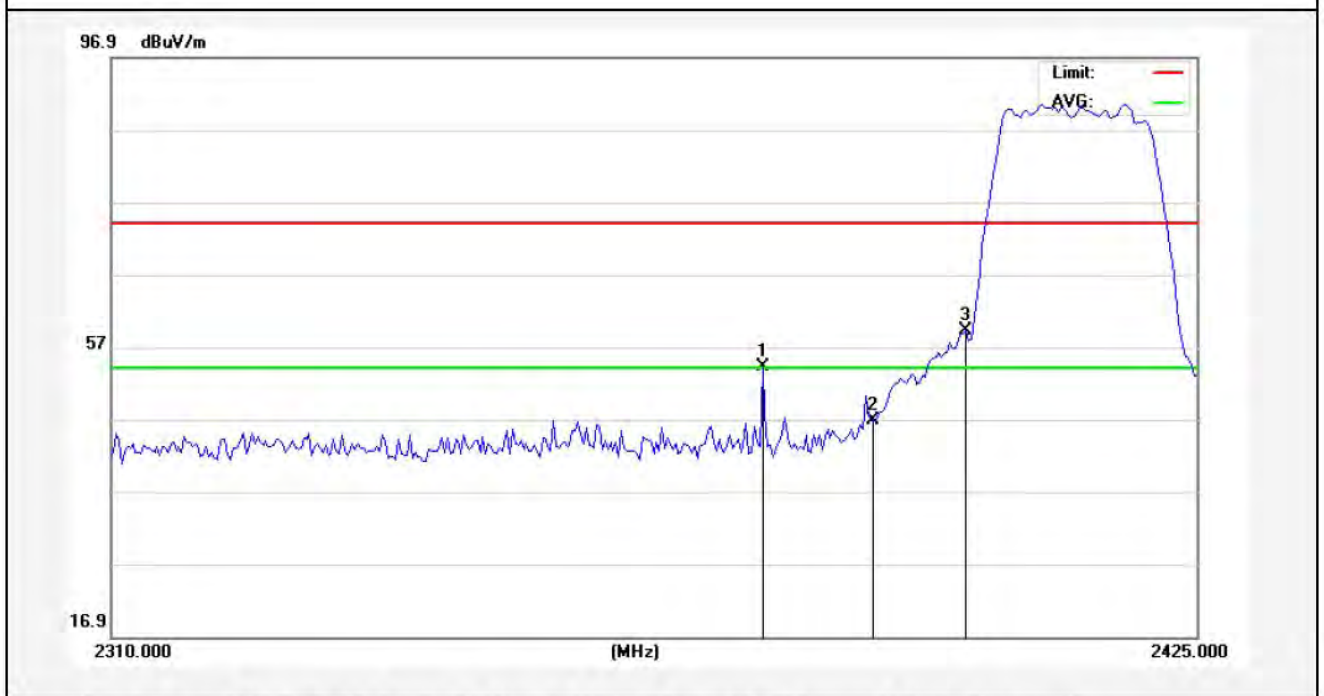

No.	Freq. (MHz)	Reading (dBuV/m)	Factor (dB/m)	Result (dBuV/m)	Limit (dBuV/)	Over Limit (dB)	Detector	Height (cm)	degree (deg)	Remark
1	2378.425	56.79	-2.54	54.25	74.00	-19.75	peak			
2	2390.000	49.33	-2.51	46.82	74.00	-27.18	peak			
3	2400.000	61.65	-2.49	59.16	74.00	-14.84	peak			

Anbotek

Vertical-AV:

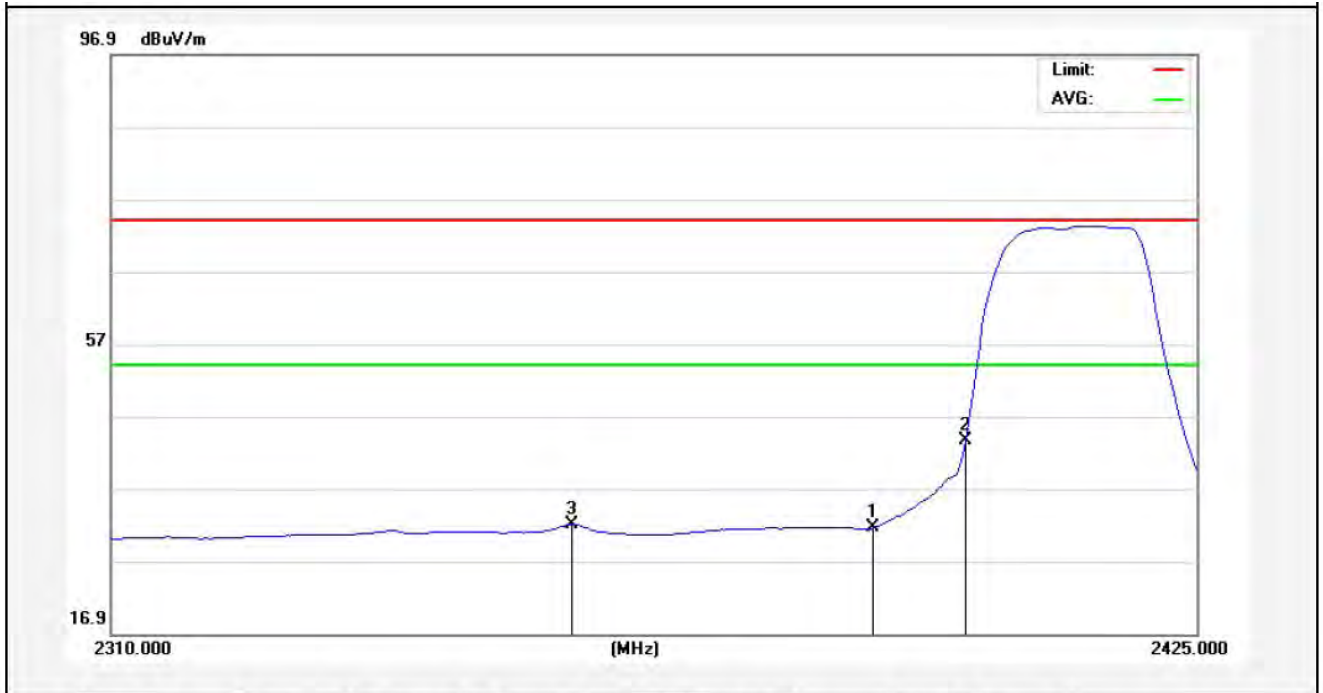

No.	Freq. (MHz)	Reading (dBuV/m)	Factor (dB/m)	Result (dBuV/m)	Limit (dBuV/)	Over Limit (dB)	Detector	Height (cm)	degree (deg)	Remark
1	2390.000	34.10	-2.51	31.59	54.00	-22.41	AVG			
2	2400.000	46.14	-2.49	43.65	54.00	-10.35	AVG			
3	2358.300	34.62	-2.58	32.04	54.00	-21.96	AVG			

Anbotek

Test Mode: 802.11g
2462MHz
Horizontal-PEAK:

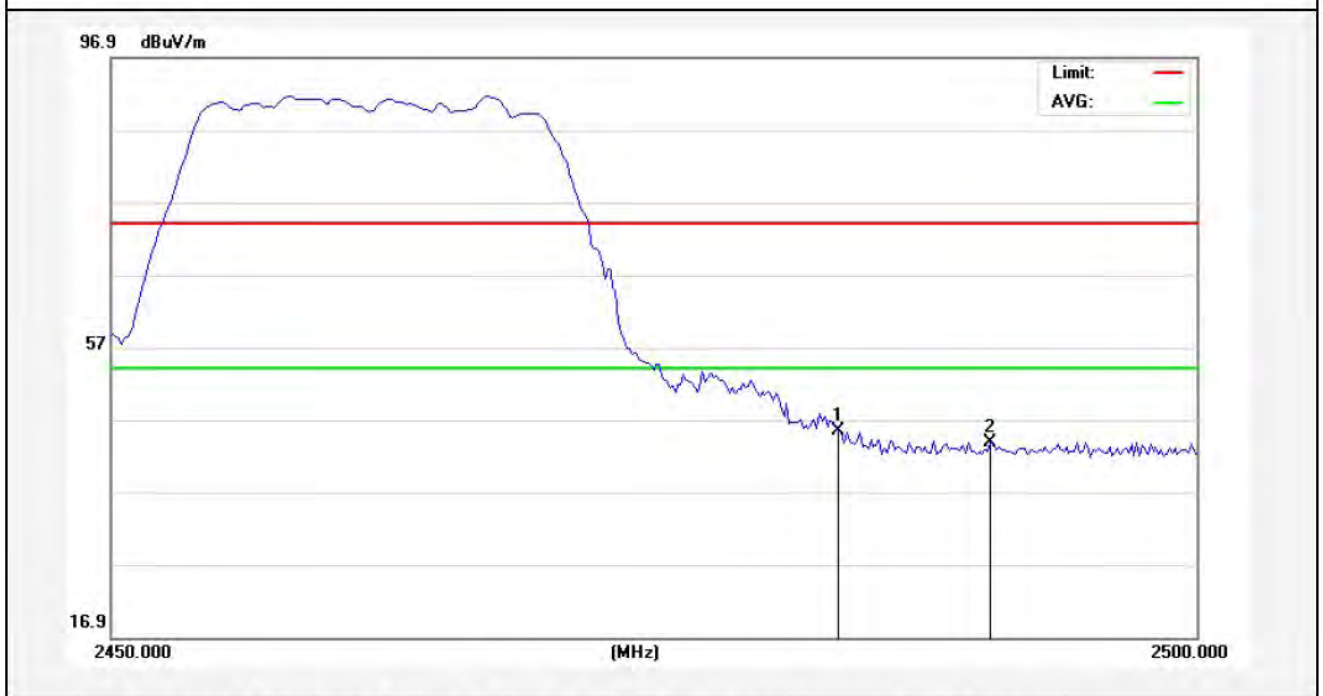

No.	Freq. (MHz)	Reading (dBuV/m)	Factor (dB/m)	Result (dBuV/m)	Limit (dBuV/)	Over Limit (dB)	Detector	Height (cm)	degree (deg)	Remark
1	2483.500	47.64	-2.31	45.33	74.00	-28.67	peak			
2	2490.500	46.13	-2.29	43.84	74.00	-30.16	peak			

Anbotek

Horizontal-AV:

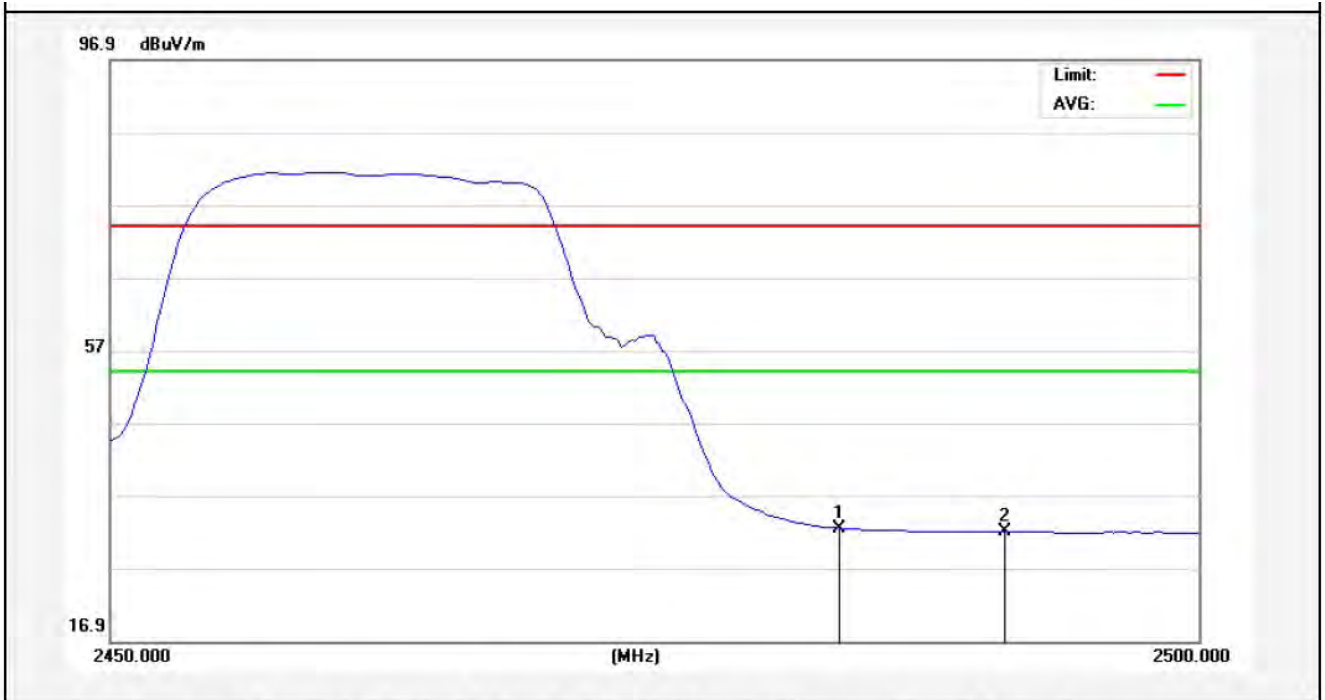

No.	Freq. (MHz)	Reading (dBuV/m)	Factor (dB/m)	Result (dBuV/m)	Limit (dBuV/)	Over Limit (dB)	Detector	Height (cm)	degree (deg)	Remark
1	2483.500	34.79	-2.31	32.48	54.00	-21.52	AVG			
2	2491.125	34.27	-2.29	31.98	54.00	-22.02	AVG			

Anbotek

Test Mode: 802.11g
2462MHz
Vertical-PEAK:

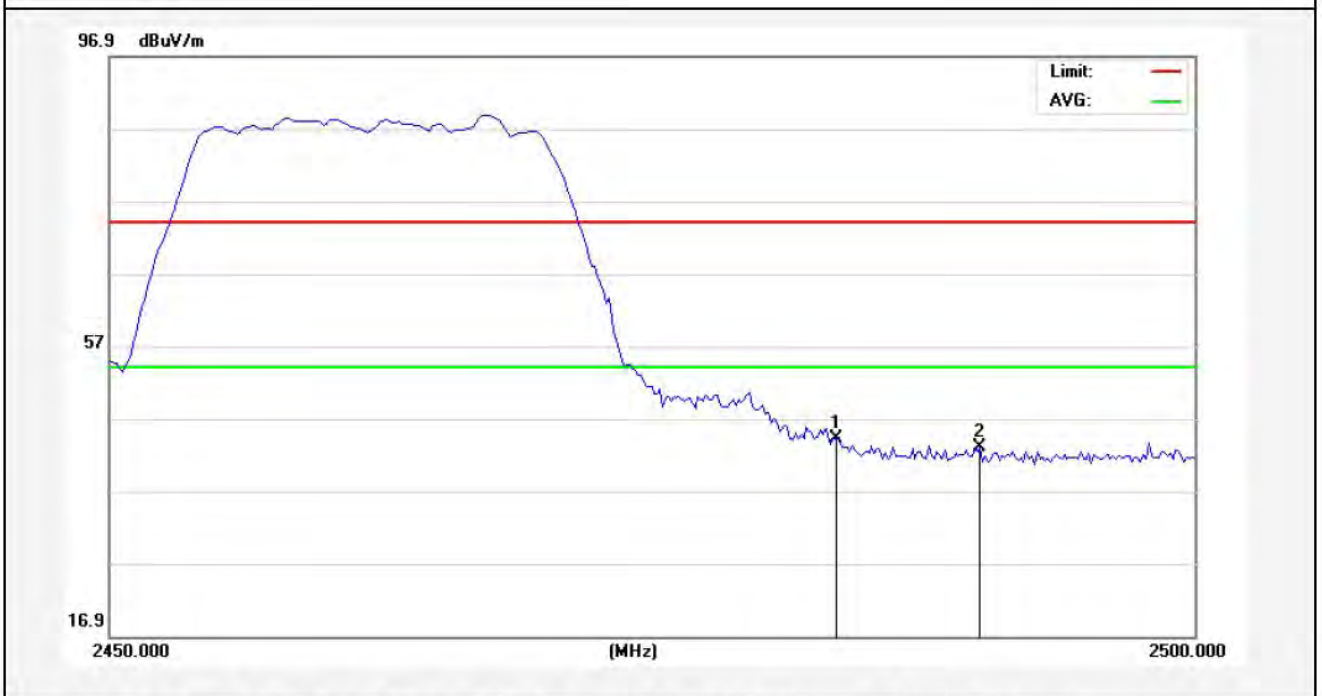

No.	Freq. (MHz)	Reading (dBuV/m)	Factor (dB/m)	Result (dBuV/m)	Limit (dBuV/)	Over Limit (dB)	Detector	Height (cm)	degree (deg)	Remark
1	2483.500	46.53	-2.31	44.22	74.00	-29.78	peak			
2	2490.125	45.30	-2.29	43.01	74.00	-30.99	peak			

Anbotek

Vertical-AV:

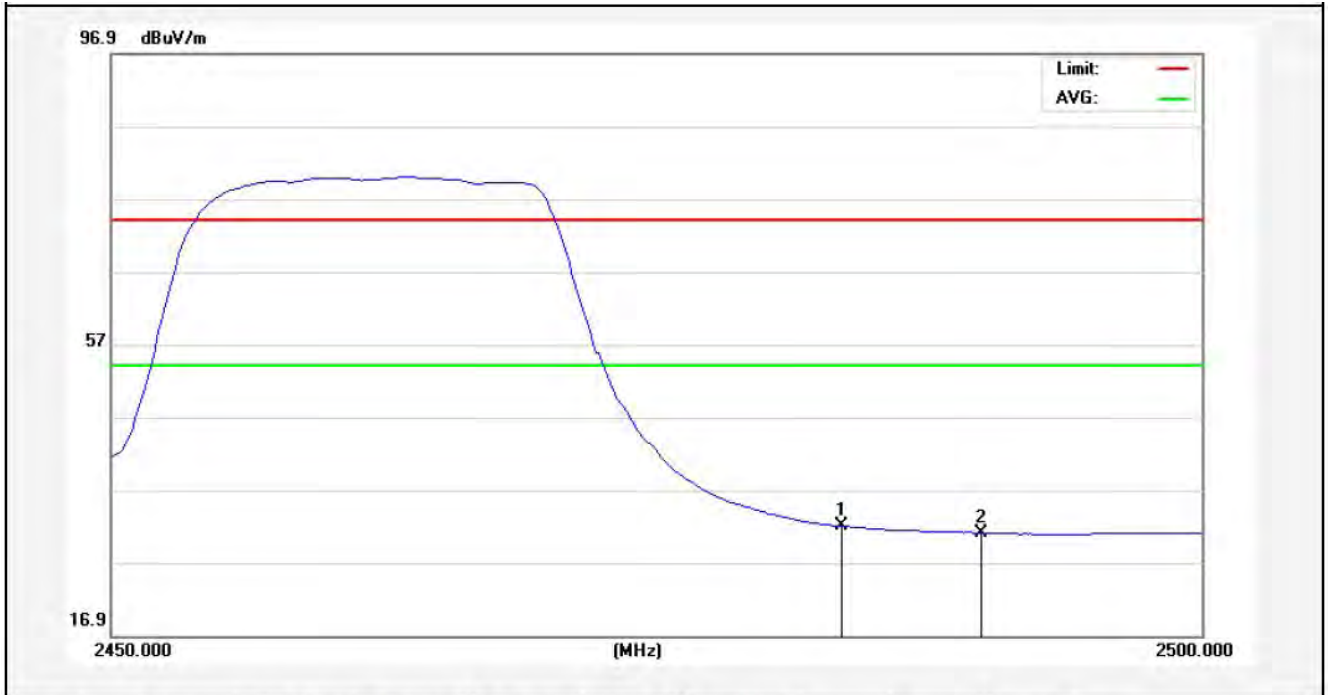

No.	Freq. (MHz)	Reading (dBuV/m)	Factor (dB/m)	Result (dBuV/m)	Limit (dBuV/)	Over Limit (dB)	Detector	Height (cm)	degree (deg)	Remark
1	2483.500	34.29	-2.31	31.98	54.00	-22.02	AVG			
2	2489.875	33.34	-2.29	31.05	54.00	-22.95	AVG			

Anbotek

Test Mode: 802.11n (HT20)
2412MHz
Horizontal-PEAK:

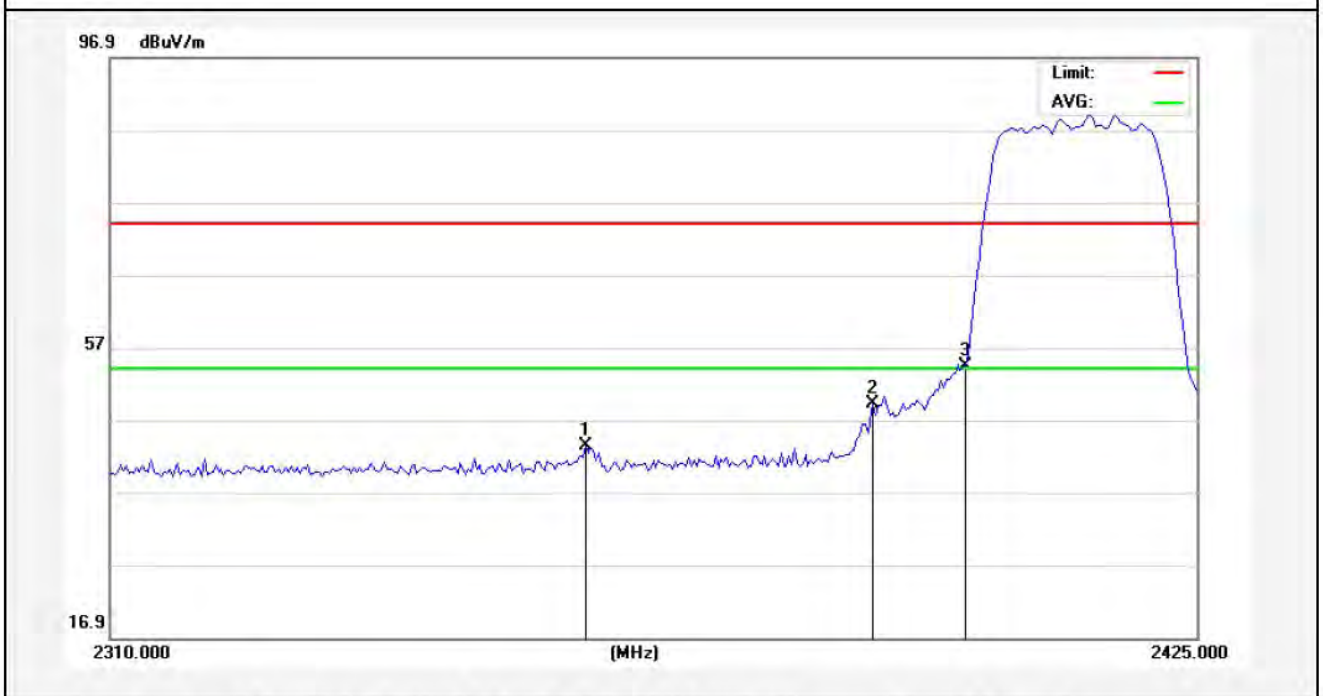

No.	Freq. (MHz)	Reading (dBuV/m)	Factor (dB/m)	Result (dBuV/m)	Limit (dBuV/)	Over Limit (dB)	Detector	Height (cm)	degree (deg)	Remark
1	2359.738	45.92	-2.58	43.34	74.00	-30.66	peak			
2	2390.000	51.70	-2.51	49.19	74.00	-24.81	peak			
3	2400.000	56.81	-2.49	54.32	74.00	-19.68	peak			

AMB

Horizontal-AV:

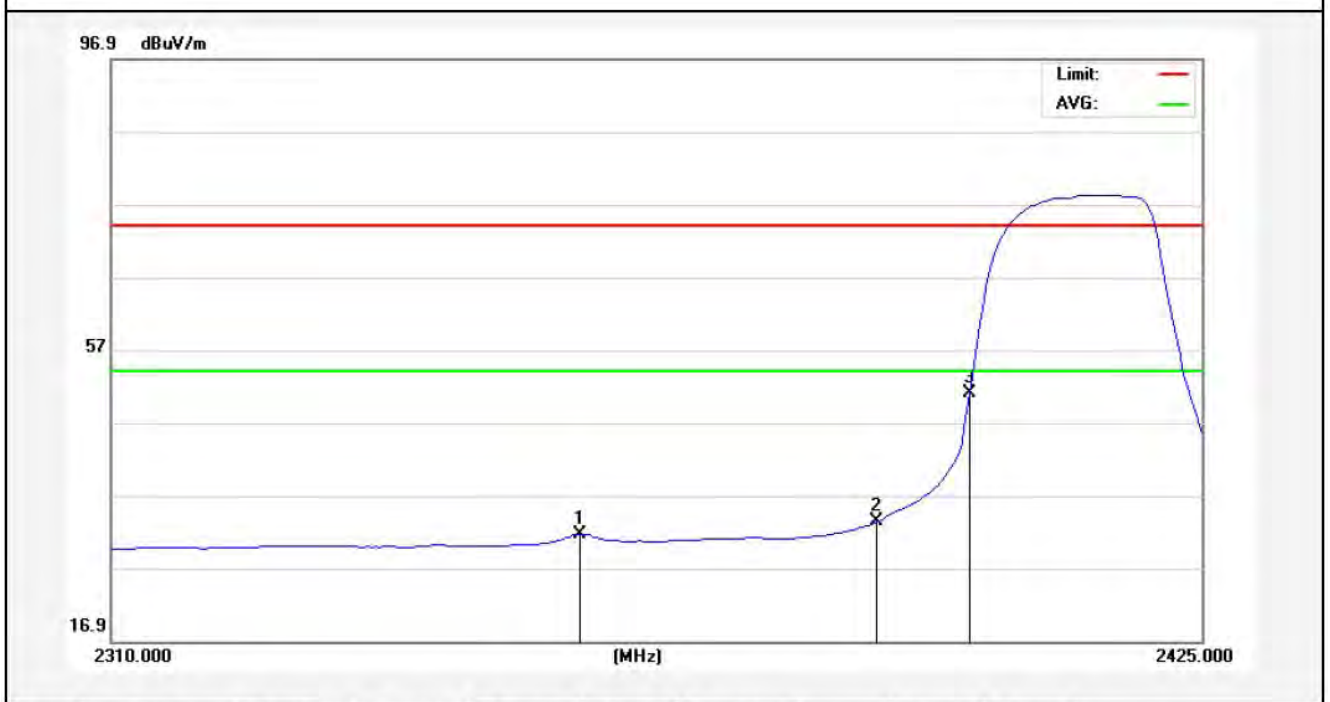

No.	Freq. (MHz)	Reading (dBuV/m)	Factor (dB/m)	Result (dBuV/m)	Limit (dBuV/)	Over Limit (dB)	Detector	Height (cm)	degree (deg)	Remark
1	2358.875	34.26	-2.58	31.68	54.00	-22.32	AVG			
2	2390.000	35.82	-2.51	33.31	54.00	-20.69	AVG			
3	2400.000	53.48	-2.49	50.99	54.00	-3.01	AVG			

Anbotek

Test Mode: 802.11n (HT20)
2412MHz
Vertical-PEAK:

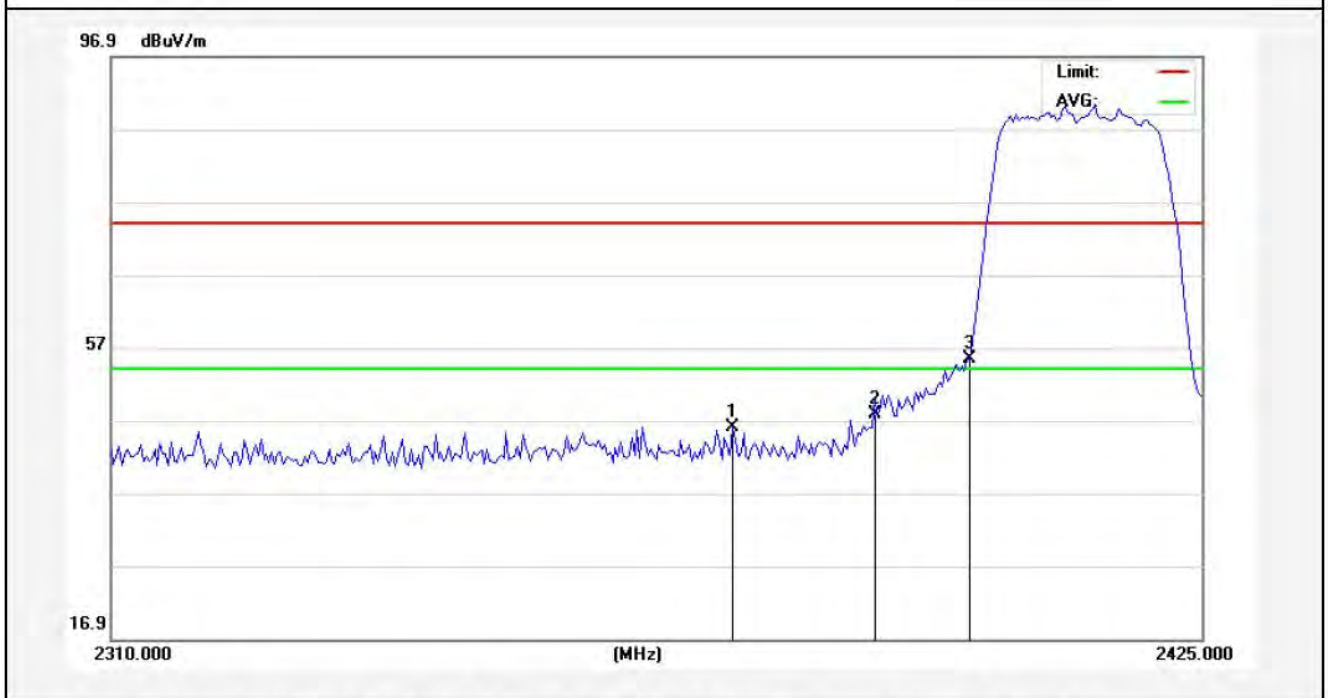

No.	Freq. (MHz)	Reading (dBuV/m)	Factor (dB/m)	Result (dBuV/m)	Limit (dBuV/)	Over Limit (dB)	Detector	Height (cm)	degree (deg)	Remark
1	2374.975	48.60	-2.55	46.05	74.00	-27.95	peak			
2	2390.000	50.25	-2.51	47.74	74.00	-26.26	peak			
3	2400.000	57.86	-2.49	55.37	74.00	-18.63	peak			

AMB

Vertical-AV:

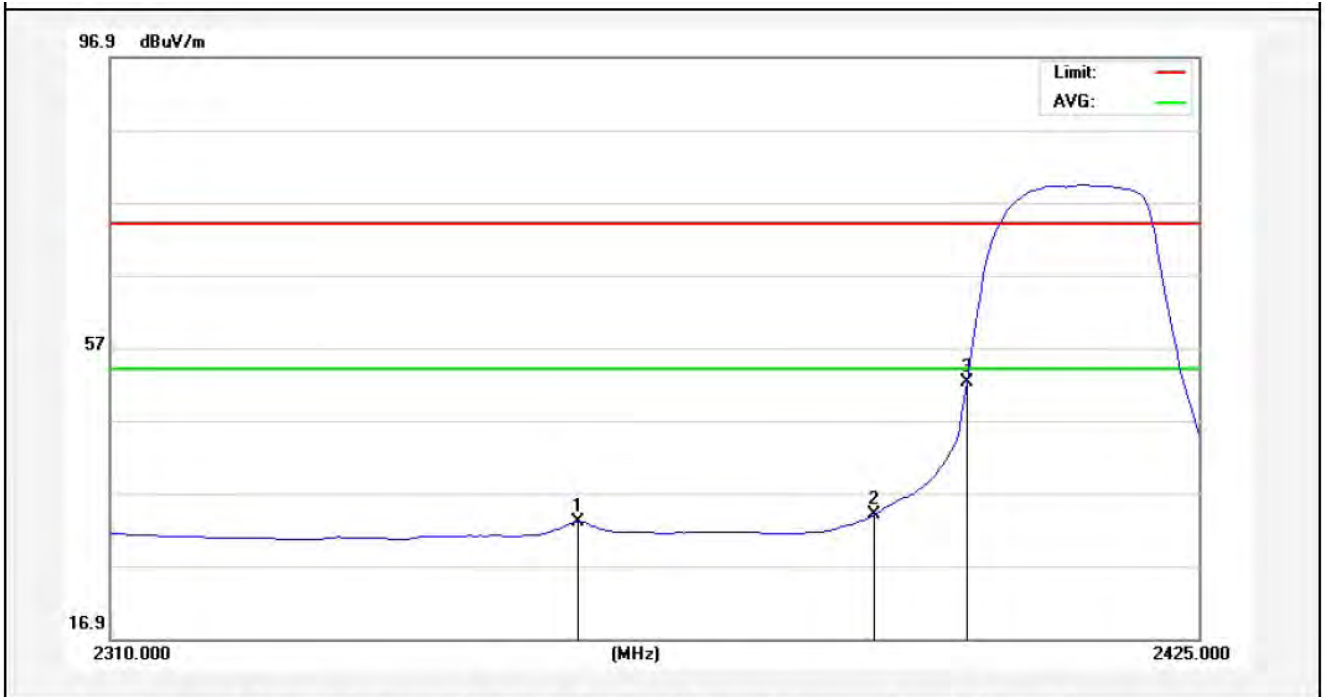

No.	Freq. (MHz)	Reading (dBuV/m)	Factor (dB/m)	Result (dBuV/m)	Limit (dBuV/)	Over Limit (dB)	Detector	Height (cm)	degree (deg)	Remark
1	2358.875	35.65	-2.58	33.07	54.00	-20.93	AVG			
2	2390.000	36.51	-2.51	34.00	54.00	-20.00	AVG			
3	2400.000	54.75	-2.49	52.26	54.00	-1.74	AVG			

Anbotek

Test Mode: 802.11n (HT20)
2462MHz
Horizontal-PEAK:

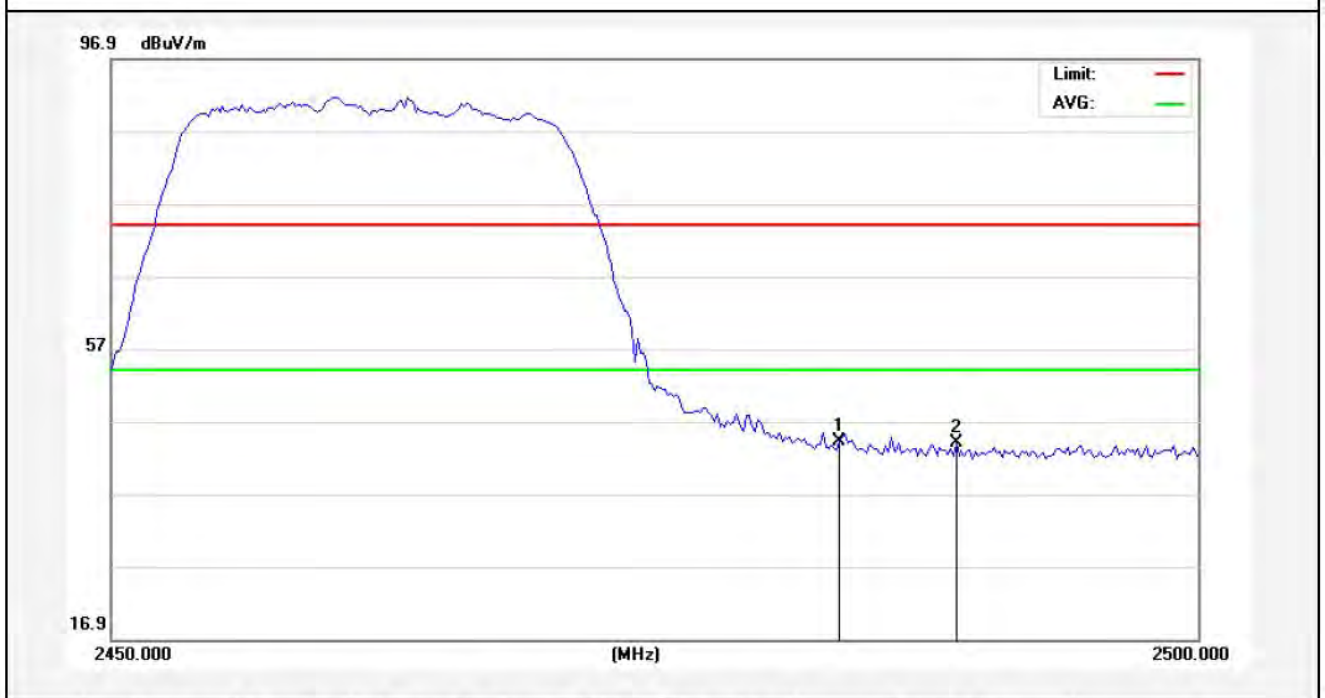

No.	Freq. (MHz)	Reading (dBuV/m)	Factor (dB/m)	Result (dBuV/m)	Limit (dBuV/)	Over Limit (dB)	Detector	Height (cm)	degree (deg)	Remark
1	2483.500	46.60	-2.31	44.29	74.00	-29.71	peak			
2	2488.875	46.21	-2.29	43.92	74.00	-30.08	peak			

Anbotek

Horizontal-AV:

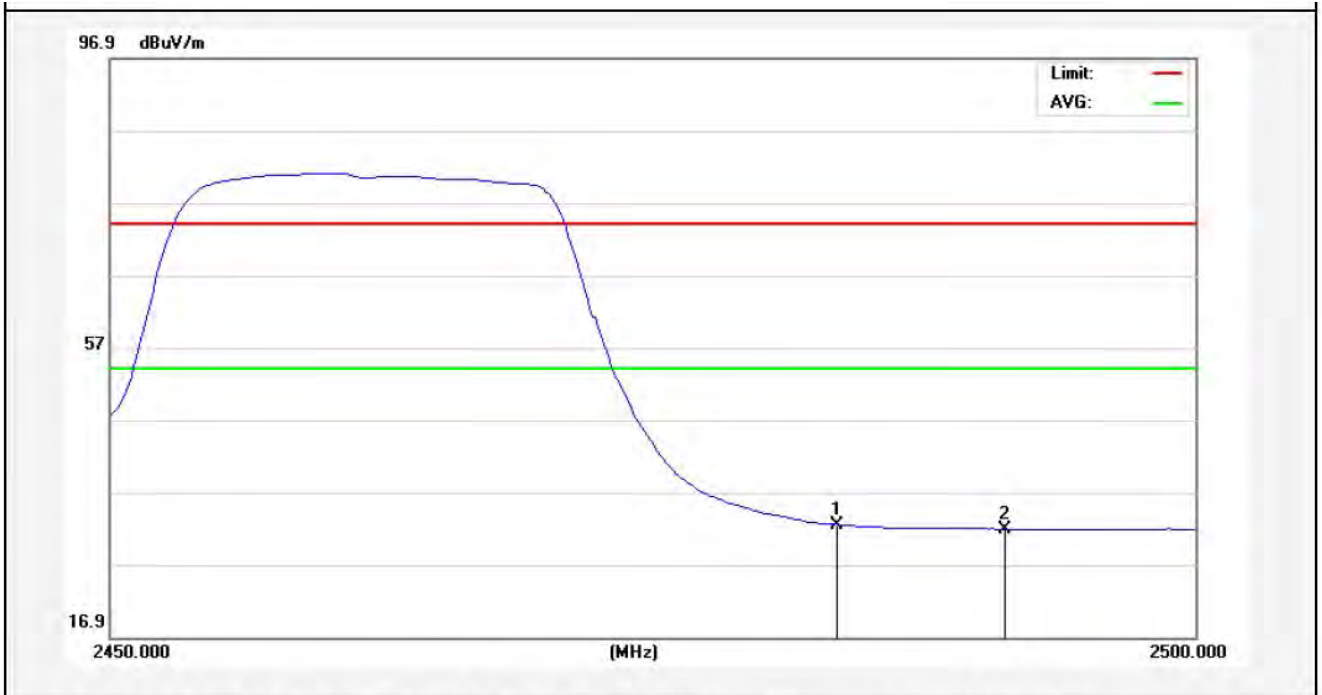

No.	Freq. (MHz)	Reading (dBuV/m)	Factor (dB/m)	Result (dBuV/m)	Limit (dBuV/)	Over Limit (dB)	Detector	Height (cm)	degree (deg)	Remark
1	2483.500	34.81	-2.31	32.50	54.00	-21.50	AVG			
2	2491.250	34.15	-2.29	31.86	54.00	-22.14	AVG			

Anbotek

Test Mode: 802.11n (HT20)
2462MHz
Vertical-PEAK:

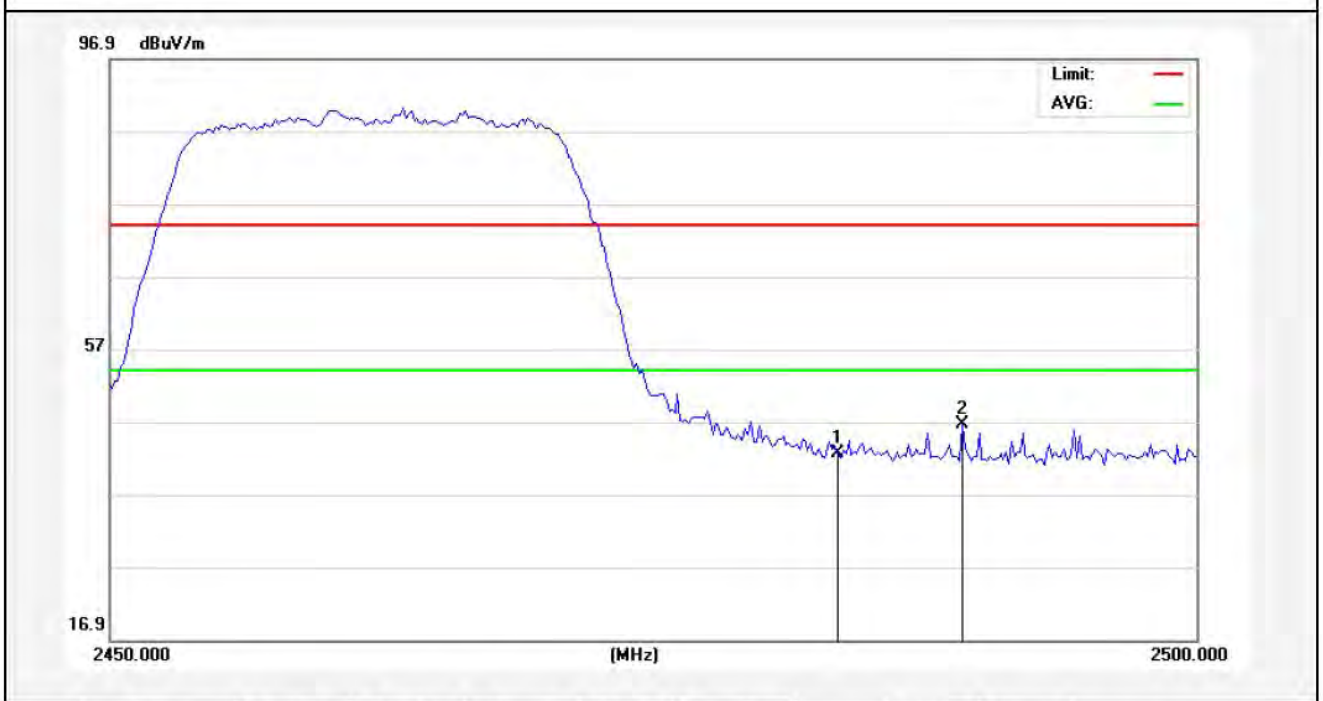

No.	Freq. (MHz)	Reading (dBuV/m)	Factor (dB/m)	Result (dBuV/m)	Limit (dBuV/)	Over Limit (dB)	Detector	Height (cm)	degree (deg)	Remark
1	2483.500	44.84	-2.31	42.53	74.00	-31.47	peak			
2	2489.250	48.95	-2.29	46.66	74.00	-27.34	peak			

Anbotek

Vertical-AV:

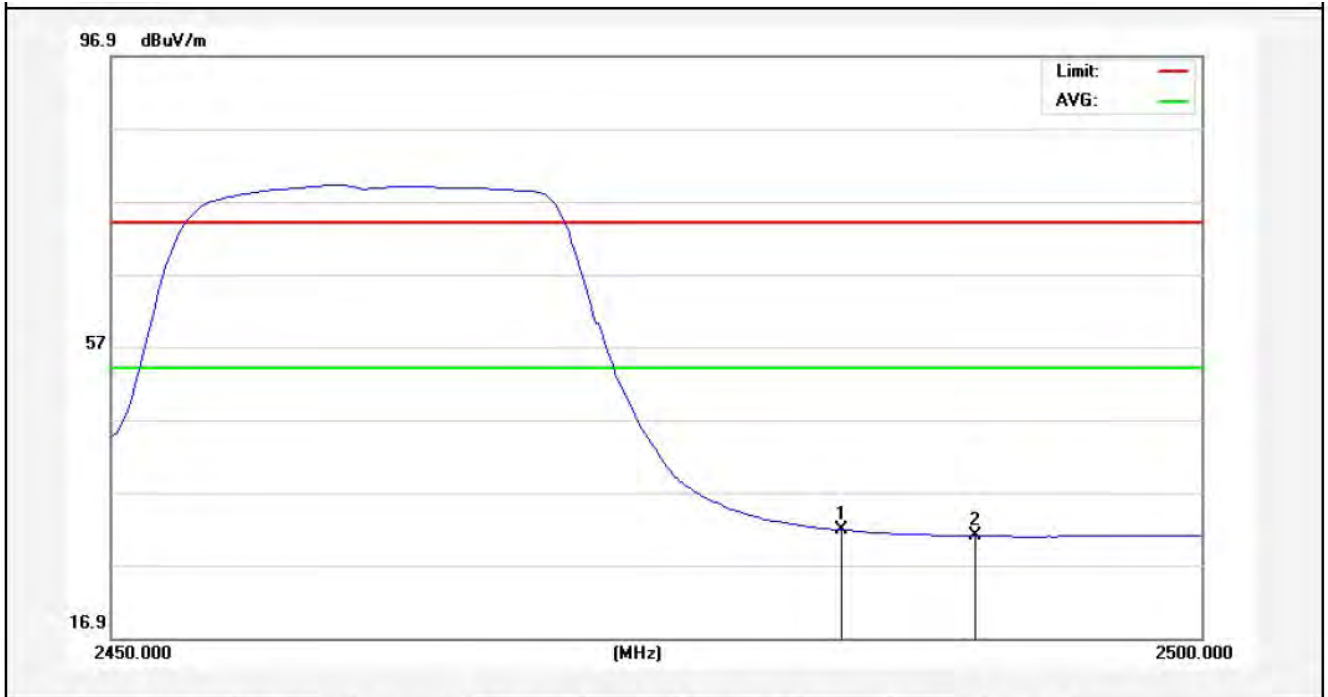

No.	Freq. (MHz)	Reading (dBuV/m)	Factor (dB/m)	Result (dBuV/m)	Limit (dBuV/)	Over Limit (dB)	Detector	Height (cm)	degree (deg)	Remark
1	2483.500	34.09	-2.31	31.78	54.00	-22.22	AVG			
2	2489.625	33.31	-2.29	31.02	54.00	-22.98	AVG			

Anbotek

Test Mode: 802.11n (HT40)
2422MHz
Horizontal-PEAK:

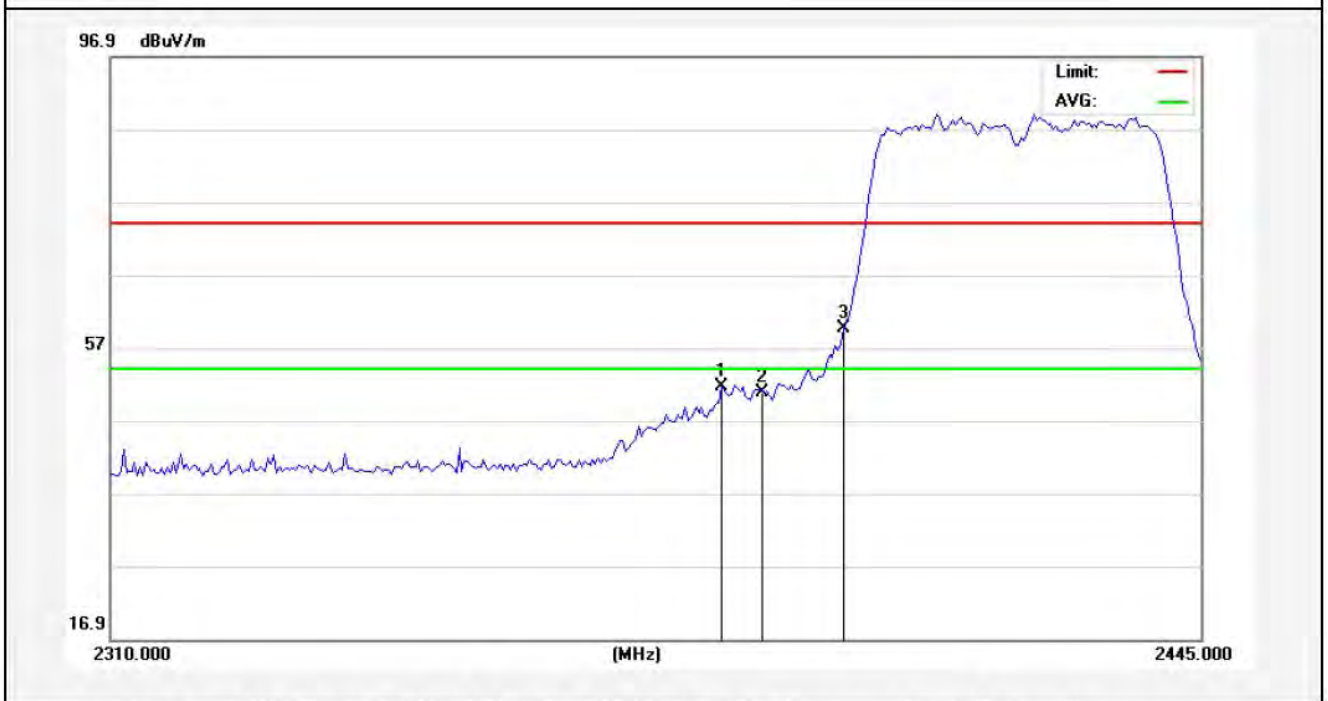

No.	Freq. (MHz)	Reading (dBuV/m)	Factor (dB/m)	Result (dBuV/m)	Limit (dBuV/)	Over Limit (dB)	Detector	Height (cm)	degree (deg)	Remark
1	2384.925	54.09	-2.53	51.56	74.00	-22.44	peak			
2	2390.000	53.32	-2.51	50.81	74.00	-23.19	peak			
3	2400.000	62.05	-2.49	59.56	74.00	-14.44	peak			

AMB

Horizontal-AV:

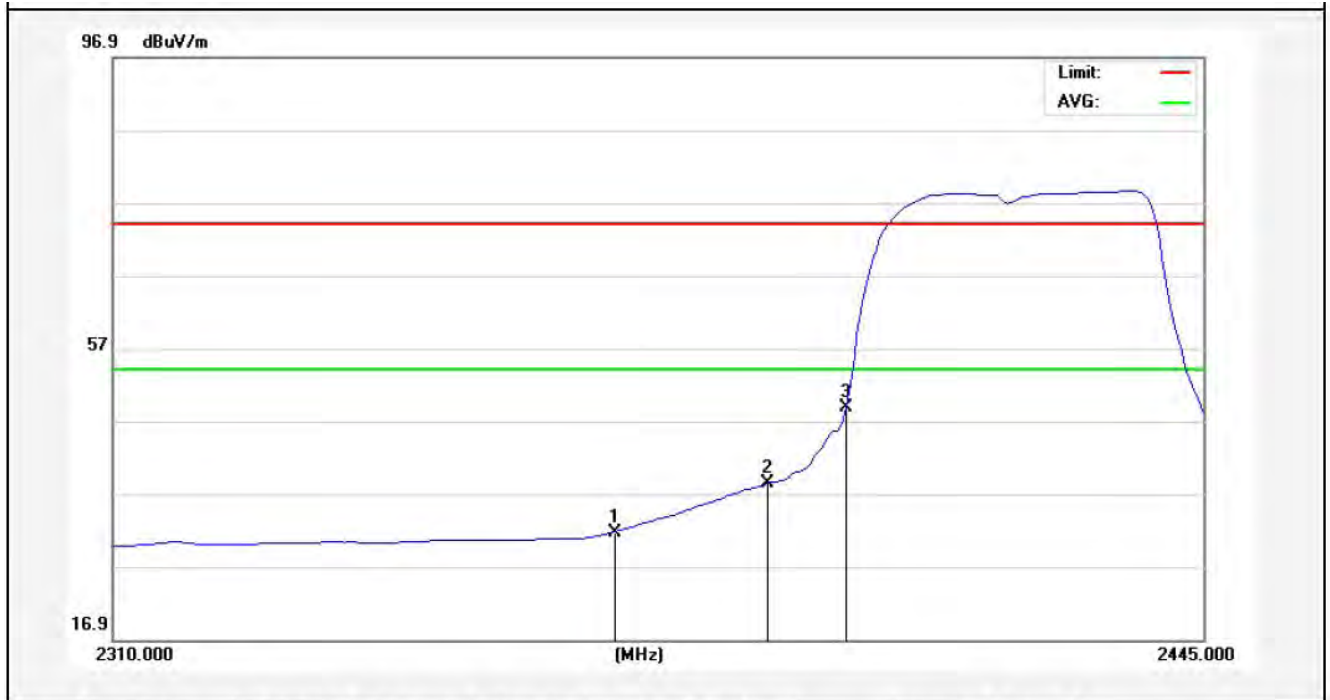

No.	Freq. (MHz)	Reading (dBuV/m)	Factor (dB/m)	Result (dBuV/m)	Limit (dBuV/)	Over Limit (dB)	Detector	Height (cm)	degree (deg)	Remark
1	2371.088	34.19	-2.56	31.63	54.00	-22.37	AVG			
2	2390.000	40.92	-2.51	38.41	54.00	-15.59	AVG			
3	2400.000	51.36	-2.49	48.87	54.00	-5.13	AVG			

Anbotek

Test Mode: 802.11n (HT40)
2422MHz
Vertical-PEAK:

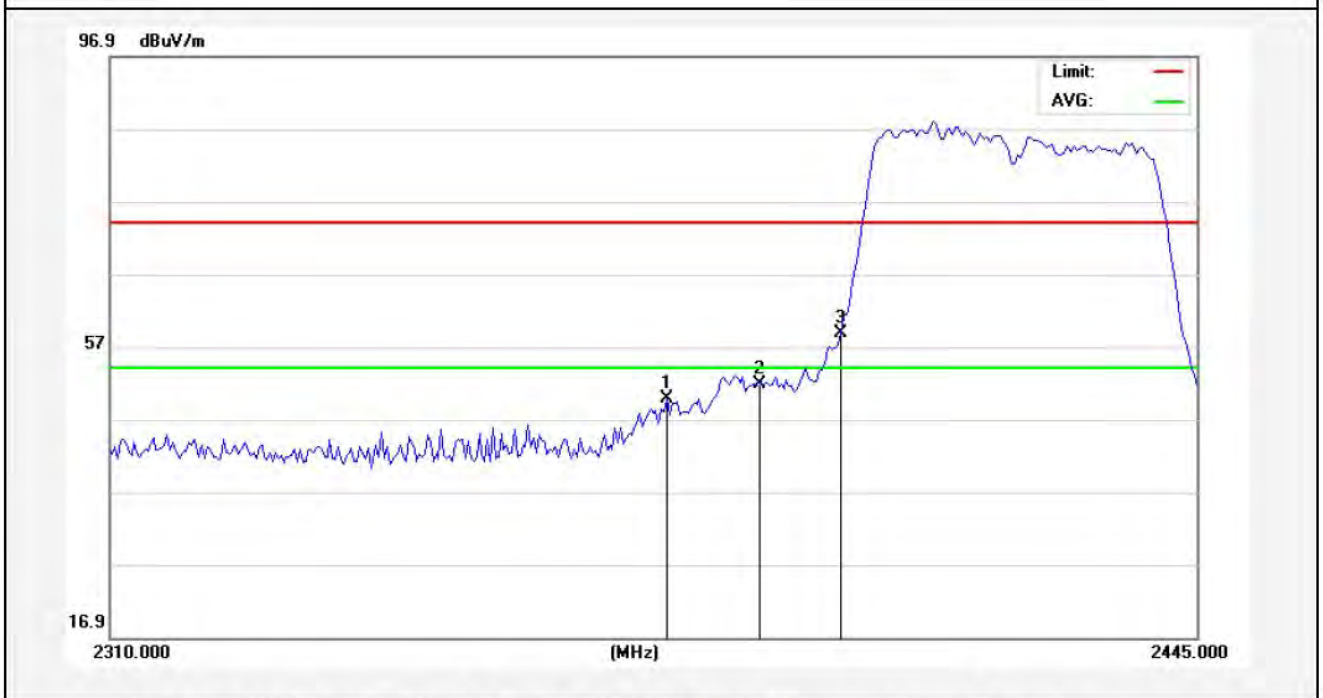

No.	Freq. (MHz)	Reading (dBuV/m)	Factor (dB/m)	Result (dBuV/m)	Limit (dBuV/)	Over Limit (dB)	Detector	Height (cm)	degree (deg)	Remark
1	2378.512	52.35	-2.54	49.81	74.00	-24.19	peak			
2	2390.000	54.39	-2.51	51.88	74.00	-22.12	peak			
3	2400.000	61.35	-2.49	58.86	74.00	-15.14	peak			

AMB

Vertical-AV:

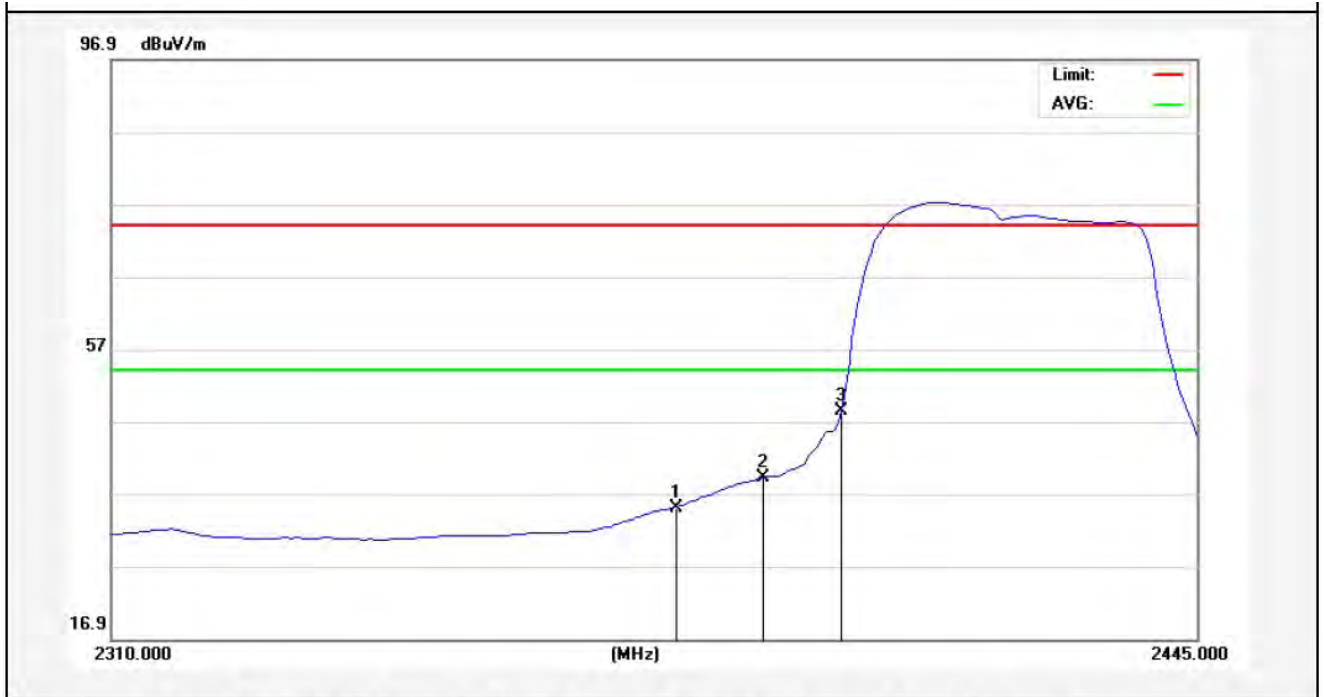

No.	Freq. (MHz)	Reading (dBuV/m)	Factor (dB/m)	Result (dBuV/m)	Limit (dBuV/)	Over Limit (dB)	Detector	Height (cm)	degree (deg)	Remark
1	2379.188	37.62	-2.54	35.08	54.00	-18.92	AVG			
2	2390.000	41.72	-2.51	39.21	54.00	-14.79	AVG			
3	2400.000	50.93	-2.49	48.44	54.00	-5.56	AVG			

Anbotek

Test Mode: 802.11n (HT40)
2452MHz
Horizontal-PEAK:

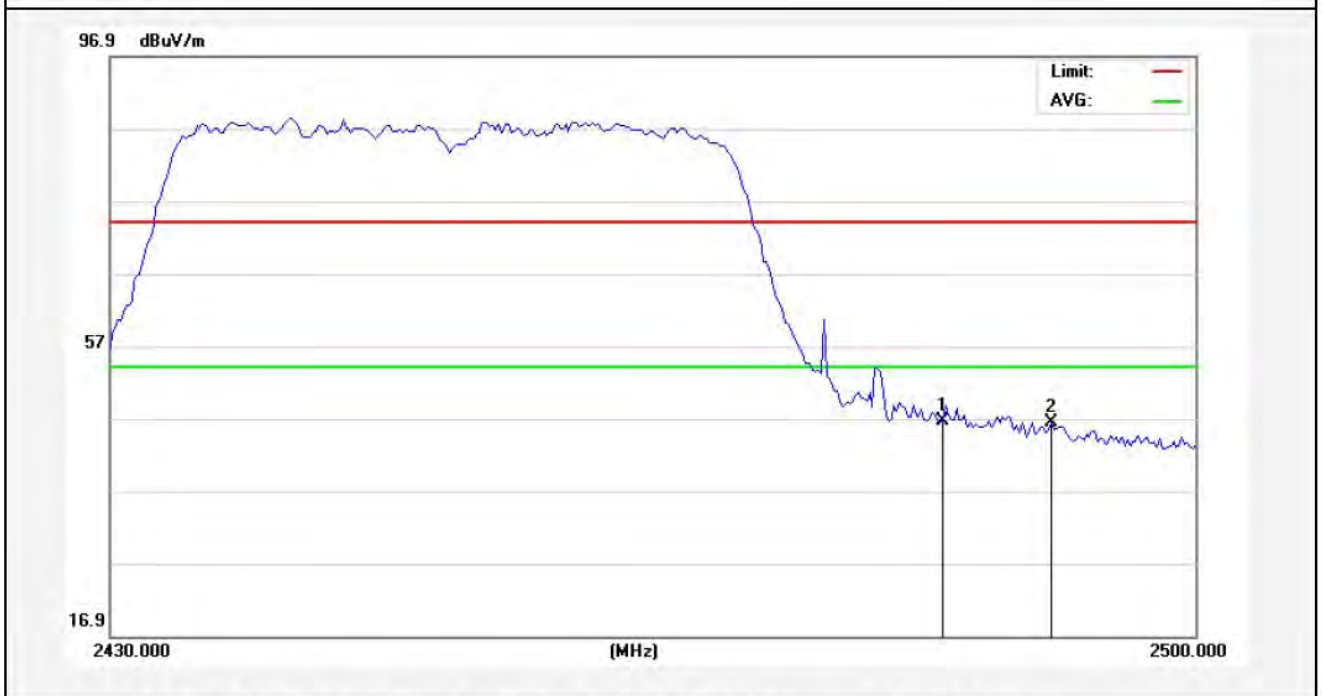

No.	Freq. (MHz)	Reading (dBuV/m)	Factor (dB/m)	Result (dBuV/m)	Limit (dBuV/)	Over Limit (dB)	Detector	Height (cm)	degree (deg)	Remark
1	2483.500	48.98	-2.31	46.67	74.00	-27.33	peak			
2	2490.725	48.60	-2.29	46.31	74.00	-27.69	peak			

Anbotek

Horizontal-AV:

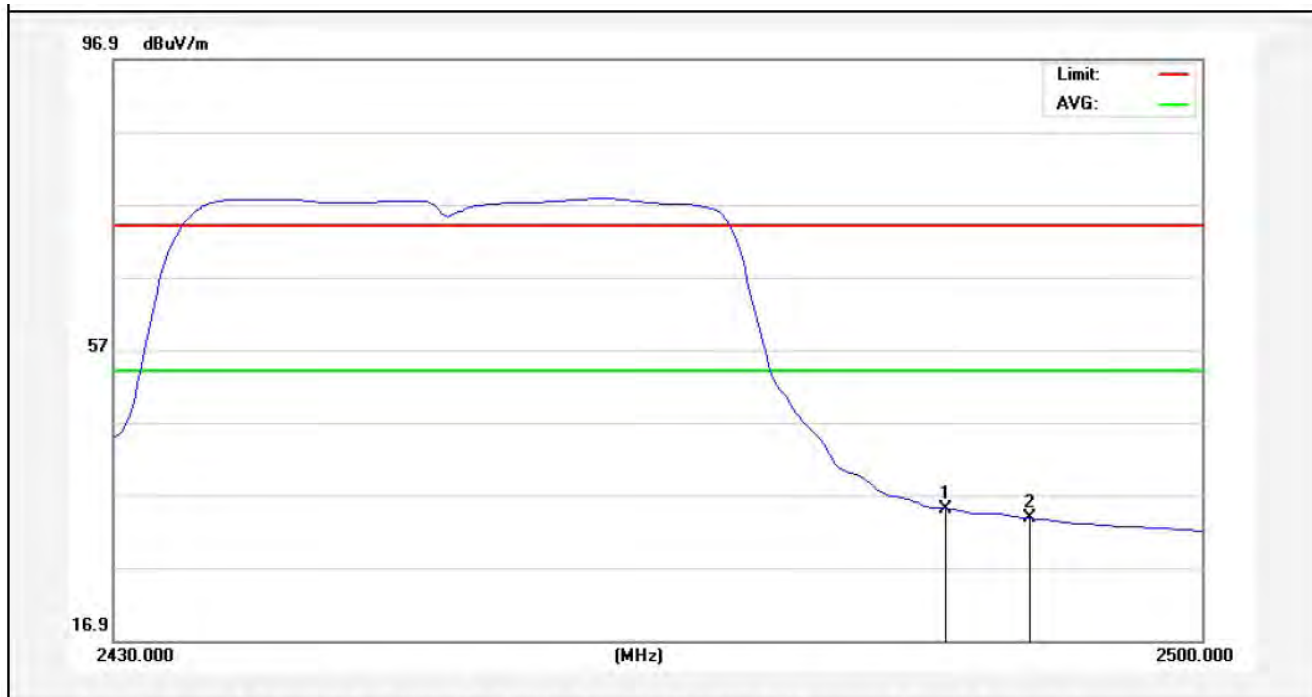

No.	Freq. (MHz)	Reading (dBuV/m)	Factor (dB/m)	Result (dBuV/m)	Limit (dBuV)	Over Limit (dB)	Detector	Height (cm)	degree (deg)	Remark
1	2483.500	37.40	-2.31	35.09	54.00	-18.91	AVG			
2	2488.975	36.01	-2.29	33.72	54.00	-20.28	AVG			

Anbotek

Test Mode: 802.11n (HT40)
2452MHz
Vertical-PEAK:

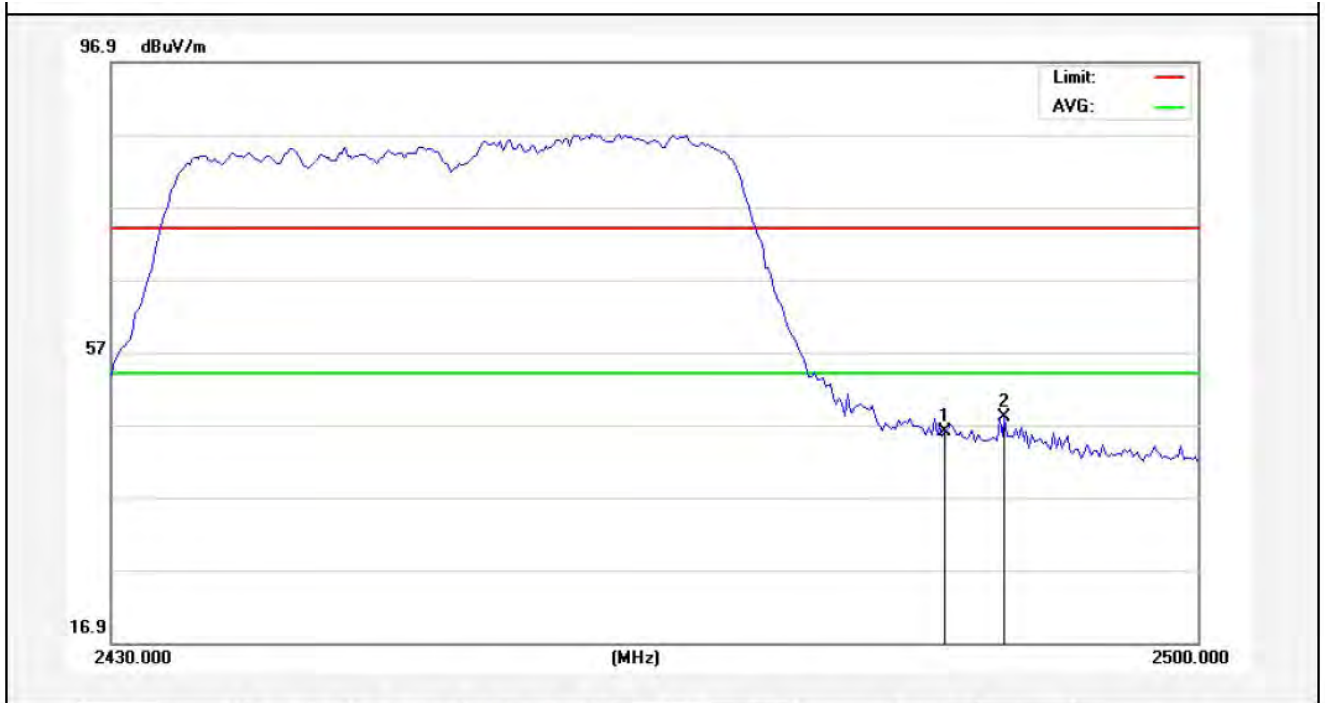

No.	Freq. (MHz)	Reading (dBuV/m)	Factor (dB/m)	Result (dBuV/m)	Limit (dBuV/)	Over Limit (dB)	Detector	Height (cm)	degree (deg)	Remark
1	2483.500	48.27	-2.31	45.96	74.00	-28.04	peak			
2	2487.575	50.29	-2.30	47.99	74.00	-26.01	peak			

Anbotek

Vertical-AV:

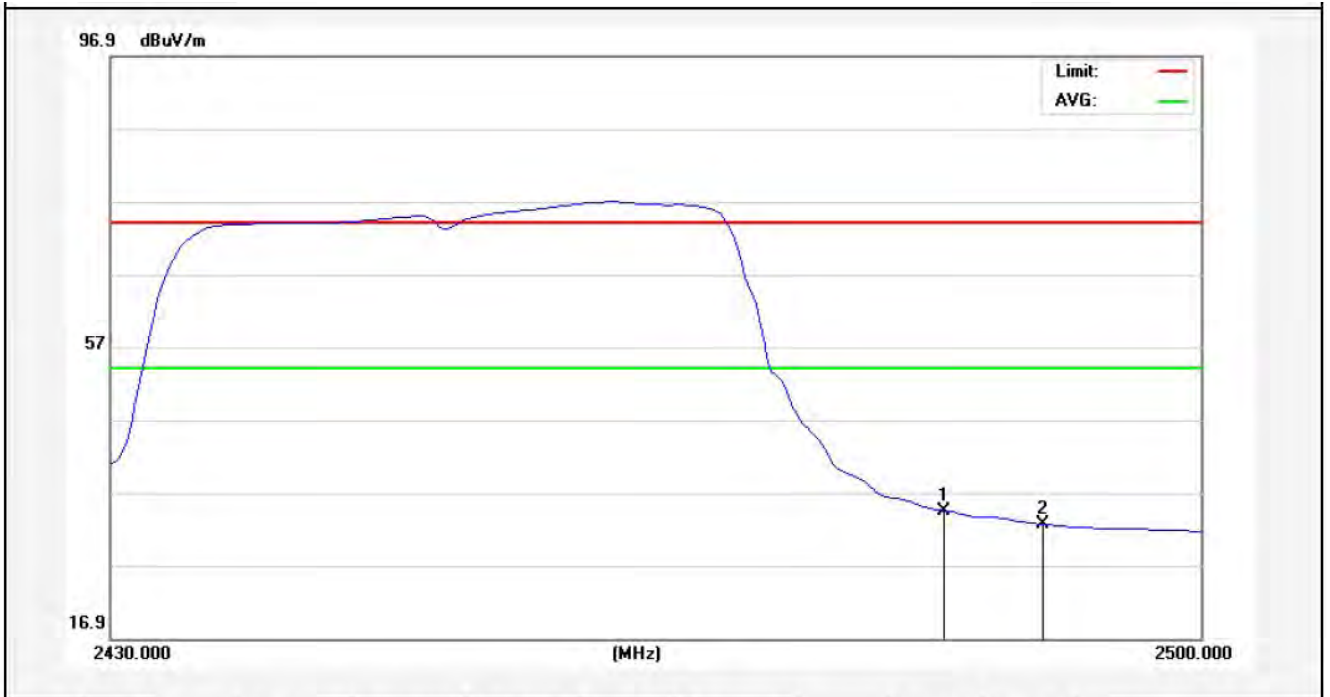

No.	Freq. (MHz)	Reading (dBuV/m)	Factor (dB/m)	Result (dBuV/m)	Limit (dBuV/)	Over Limit (dB)	Detector	Height (cm)	degree (deg)	Remark
1	2483.500	36.74	-2.31	34.43	54.00	-19.57	AVG			
2	2489.850	34.96	-2.29	32.67	54.00	-21.33	AVG			

Anbotek

4.5. Peak Power Spectral Density

a. Limit

1. For direct sequence systems, the peak power spectral density conducted from the intentional radiator to the antenna shall not be greater than 8dBm in any 3kHz band during any time interval of continuous transmission.
2. The direct sequence operating of the hybrid system, with the frequency hopping operation turned off, shall comply with the power density requirements of paragraph (d) of this section.

b. Test Procedure

1. Place the EUT on the table and set it in transmitting mode. Remove the antenna from the EUT and then connect a low loss RF cable from the antenna port to the spectrum analyzer.
2. Set the spectrum analyzer as RBW = 3kHz, VBW = 10kHz, Span = 1.5 times DTS BW, Sweep=500s
3. Record the max. reading.
4. Repeat the above procedure until the measurements for all frequencies are completed.

c. Test Equipment

Same as the equipment listed in 4.2.

d. Test Setup

See 4.1

e. Test Results

Pass

f. Test Data

Please refer to the following data.

g. Test Plot See the following pages

Test mode: IEEE 802.11b

Channel	Frequency (MHz)	PPSD (dBm/3KHz)	Σ PPSD (dBm/3KHz)	Limit (dBm)	Result
Low	2412	-12.51	-	8.00	Pass
Mid	2437	-12.02	-		Pass
High	2462	-12.13	-		Pass

Test mode: IEEE 802.11g

Channel	Frequency (MHz)	PPSD (dBm)	Σ PPSD (dBm)	Limit (dBm)	Result
Low	2412	-18.96	-	8.00	Pass
Mid	2437	-18.18	-		Pass
High	2462	-17.85	-		Pass

Test mode: IEEE 802.11n (HT20)

Channel	Frequency (MHz)	PPSD (dBm/3KHz)	Σ PPSD (dBm/3KHz)	Limit (dBm)	Result
Low	2412	-19.48	-	8.00	Pass
Mid	2437	-18.93	-		Pass
High	2462	-18.39	-		Pass

Test mode: IEEE 802.11n (HT40)

Channel	Frequency (MHz)	PPSD (dBm/3KHz)	Σ PPSD (dBm/3KHz)	Limit (dBm)	Result
Low	2422	-20.77	-	8.00	Pass
Mid	2437	-21.17	-		Pass
High	2452	-20.65	-		Pass

802.11 b CH--Low



*RBW 3 kHz Marker 1 [T1]
*VBW 10 kHz -12.51 dBm
Ref 25 dBm *Att 40 dB SWT 2 s 2.413517040 GHz

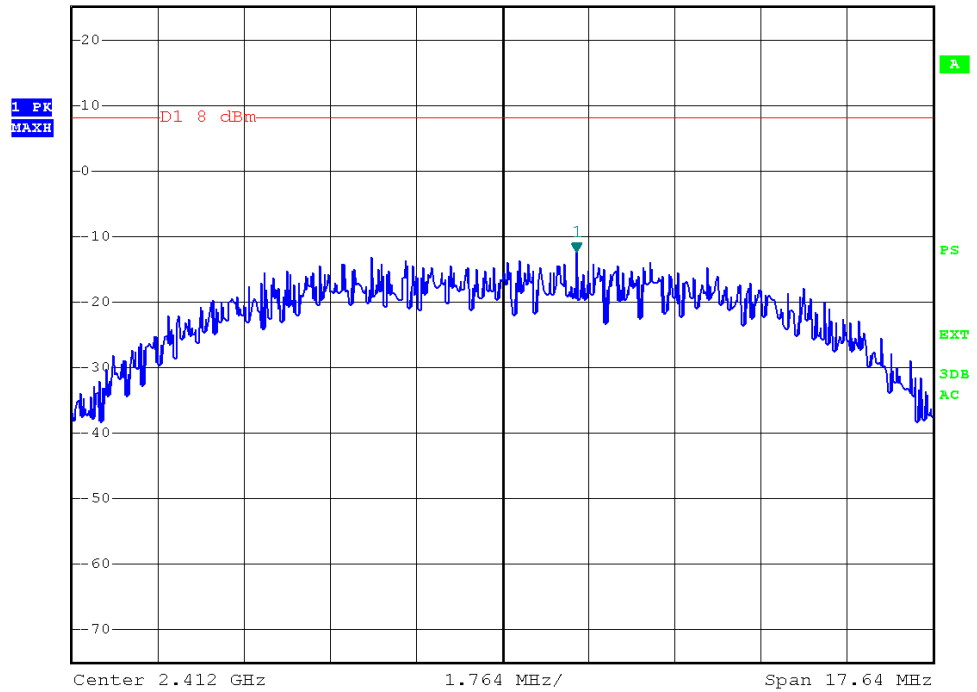

802.11 b CH--Mid



*RBW 3 kHz Marker 1 [T1]
*VBW 10 kHz -12.02 dBm
Ref 25 dBm *Att 40 dB SWT 2 s 2.438517040 GHz

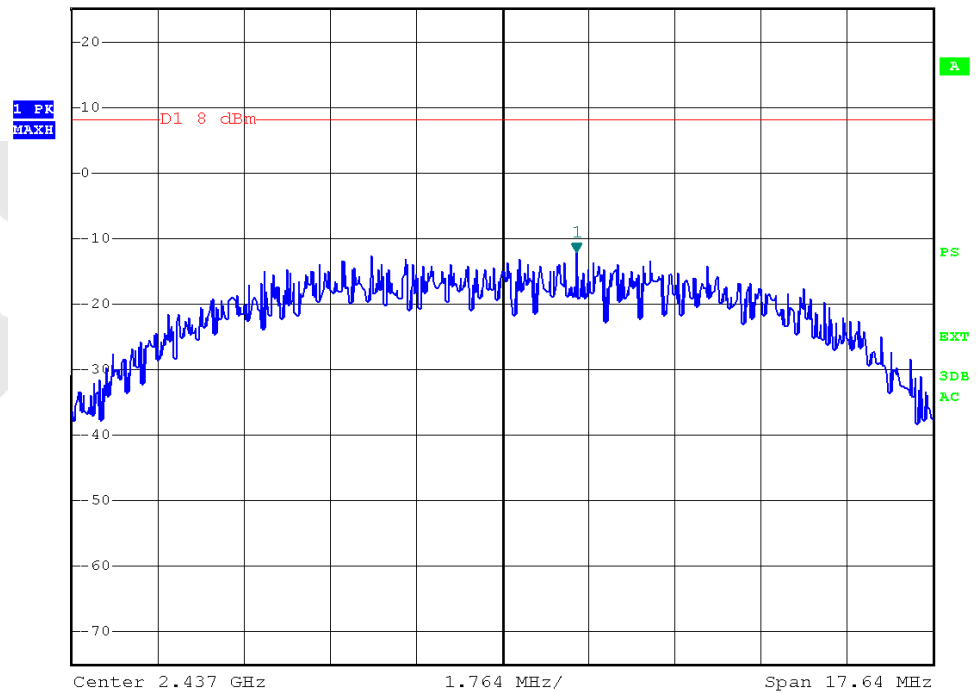

802.11 b CH--High

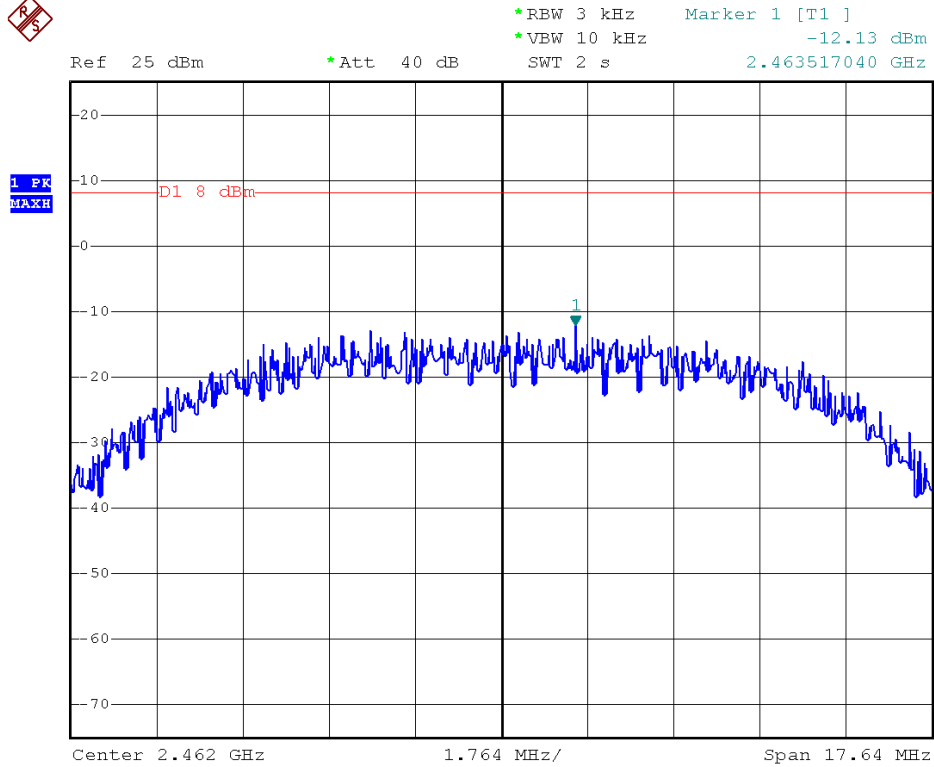

802.11g CH--Low

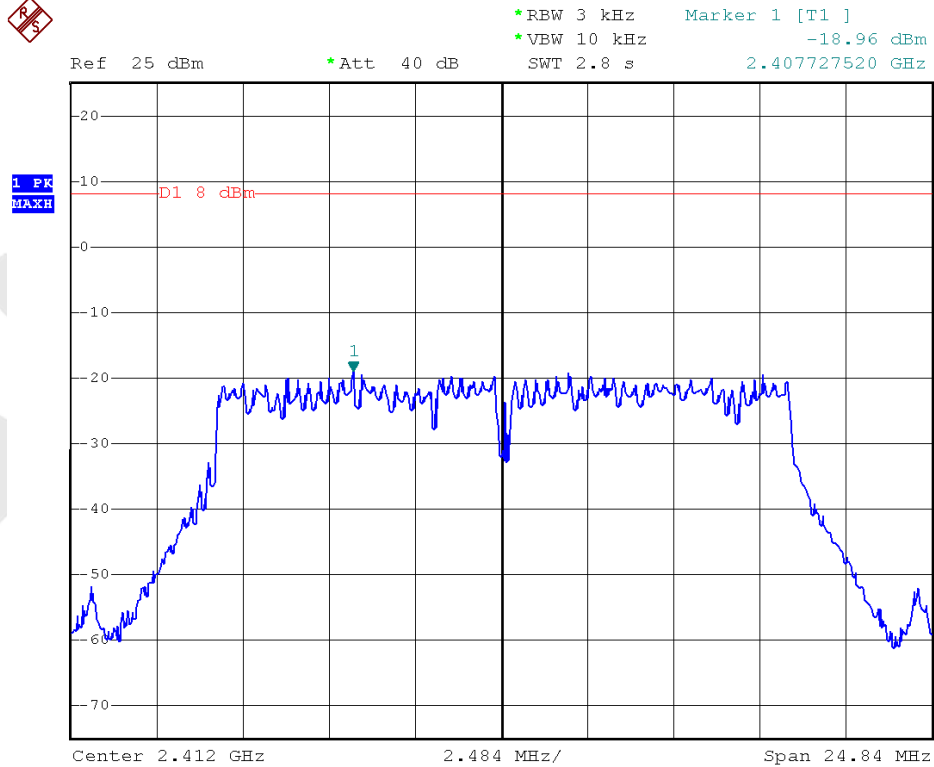

802.11g CH--Mid



*RBW 3 kHz Marker 1 [T1]
*VBW 10 kHz -18.18 dBm
SWT 2.8 s 2.432727520 GHz

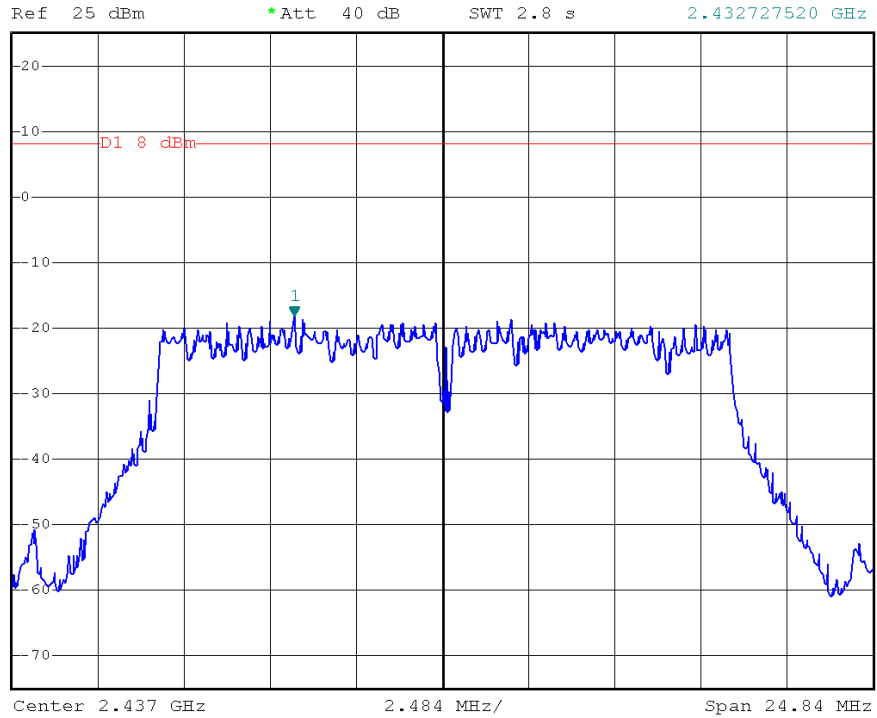

802.11g CH--High



*RBW 3 kHz Marker 1 [T1]
*VBW 10 kHz -17.85 dBm
SWT 2.8 s 2.457727520 GHz

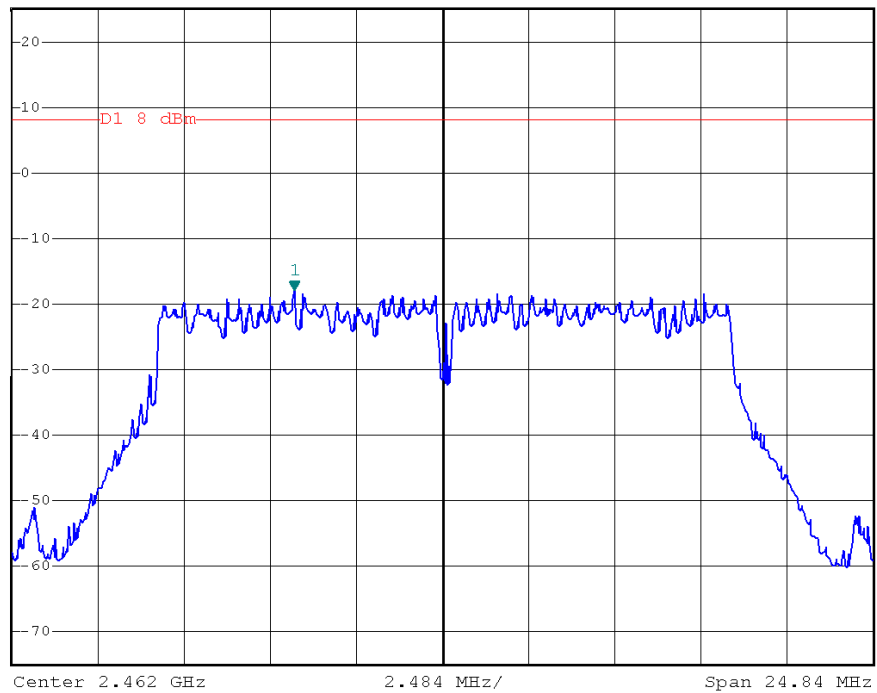

802.11n (HT20) CH—Low

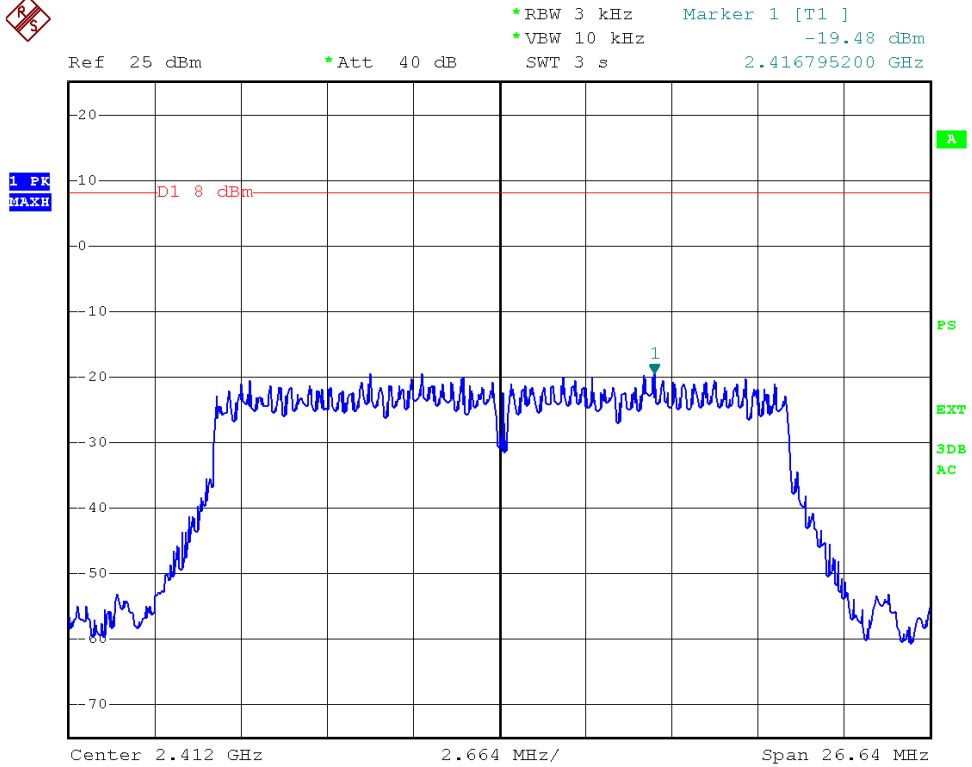

802.11n (HT20) CH—Mid

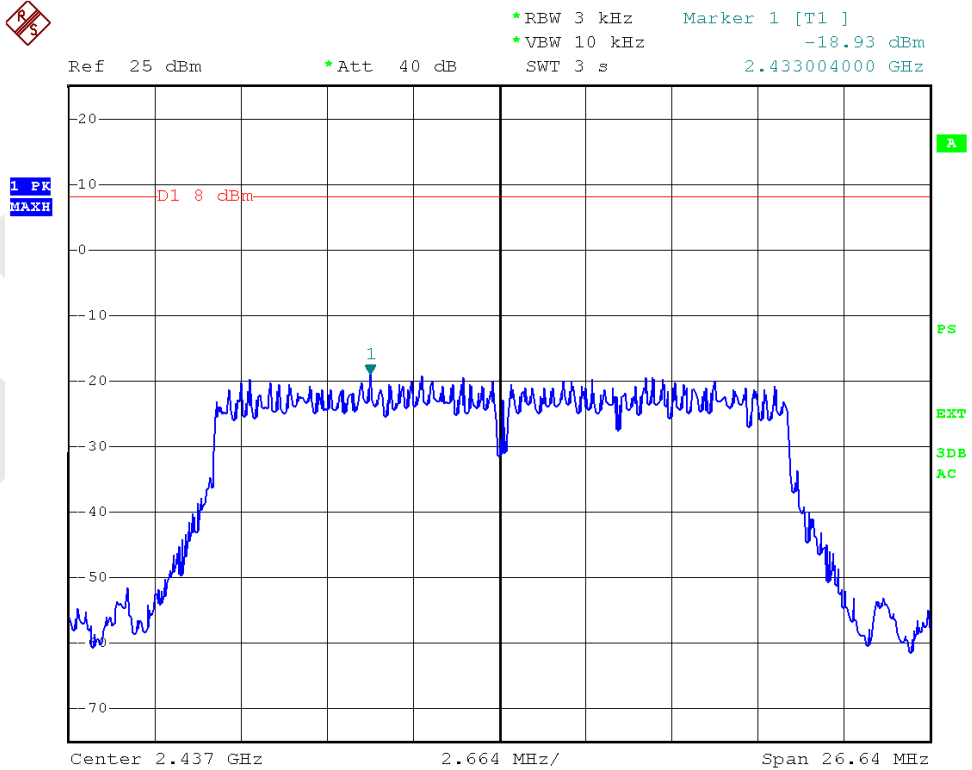

802.11n (HT20) CH—High



*RBW 3 kHz Marker 1 [T1]
*VBW 10 kHz -18.39 dBm
SWT 3 s 2.459602400 GHz

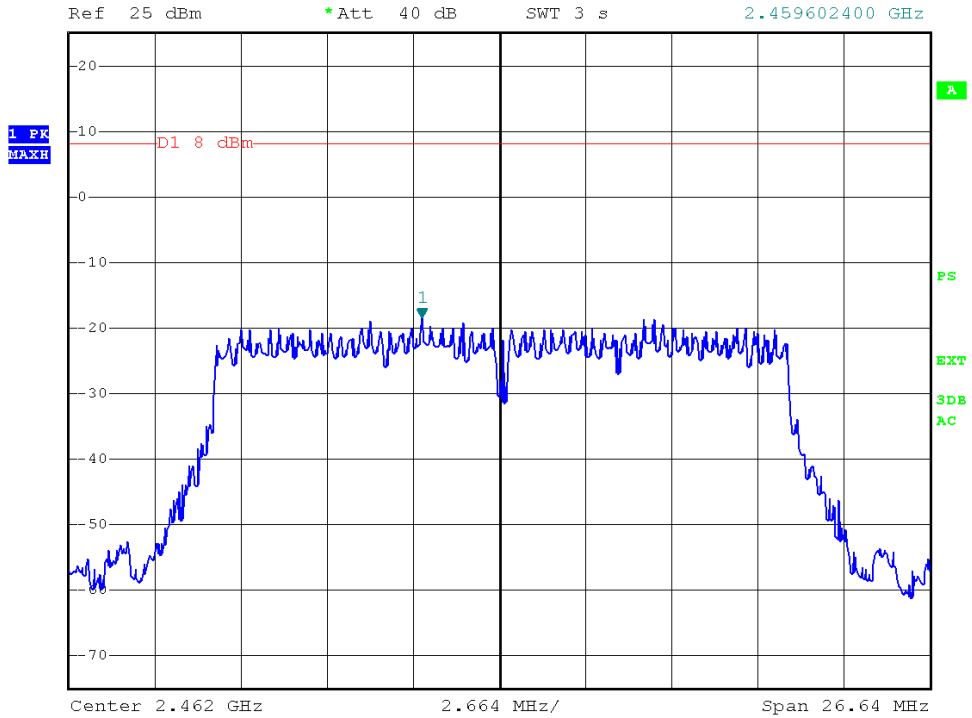

802.11n (HT40) CH—Low



*RBW 3 kHz Marker 1 [T1]
*VBW 10 kHz -20.77 dBm
SWT 4.5 s 2.433680000 GHz

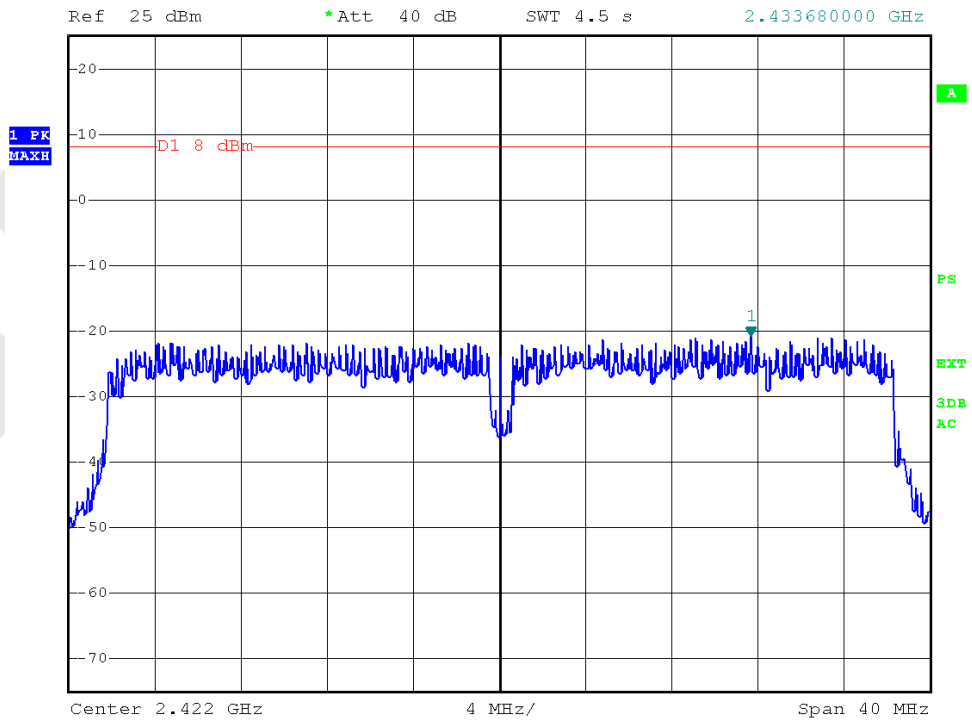

802.11n (HT40) CH—Mid

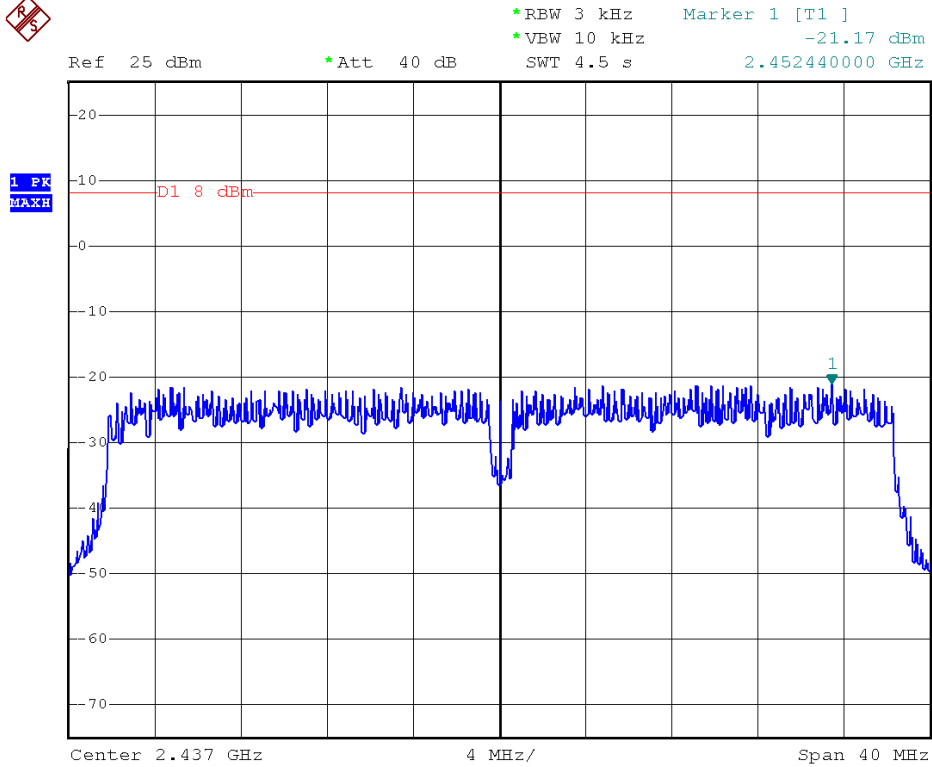

802.11n (HT40) CH—High

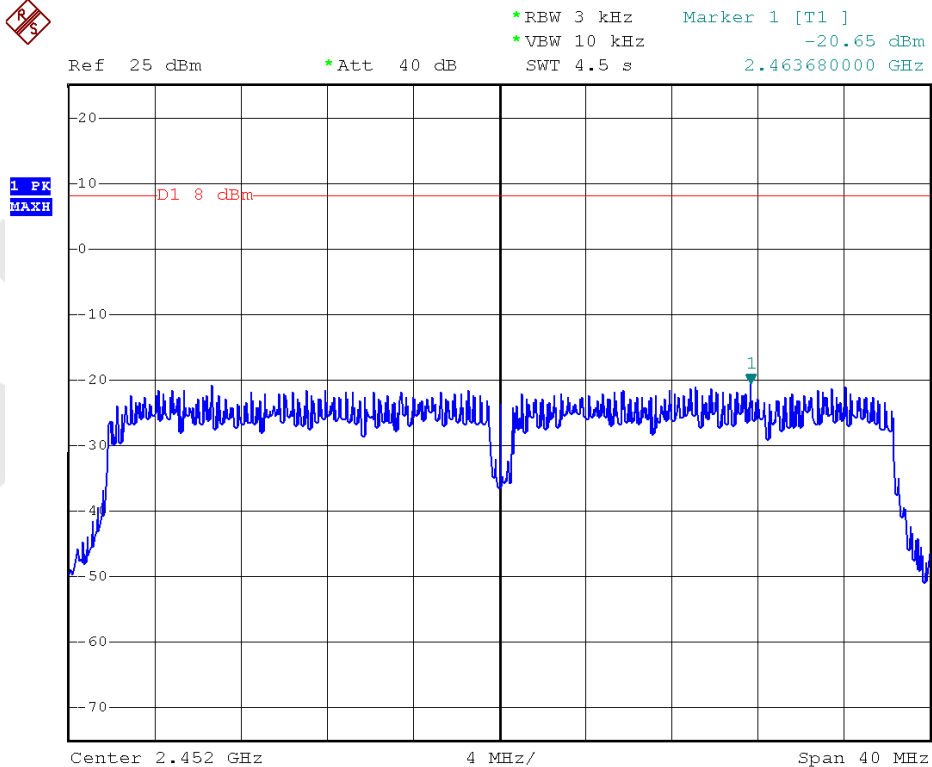

4.6. Radiated Emissions

4.6.1.1. Test Limits (< 30 MHz)

Frequency (MHz)	Field Strength (microvolts/meter)	Measurement Distance (meter)
0.009-0.490	2400/F(kHz)	300
0.490-1.705	24000/F(kHz)	30
1.705-30.0	30	30

4.6.1.2. Test Limits (≥ 30 MHz)

FIELD STRENGTH of Fundamental: @3M	FIELD STRENGTH of Harmonics	S15.209	
902-928 MHz		30 - 88 MHz	40 dBuV/m
2.4-2.4835 GHz		88 - 216 MHz	43.5
94 dBμV/m @3m	54 dBμV/m @3m	216 - 960 MHz	46
		ABOVE 960 MHz	54dBuV/m

In any 100 kHz bandwidth outside the frequency band in which the spread spectrum or digitally modulated intentional radiator is operating, the radio frequency power that is produced by the intentional radiator shall be at least 20 dB below that in the 100 kHz bandwidth within the band that contains the highest level of the desired power, based on either an RF conducted or a radiated measurement. Attenuation below the general limits specified in Section 15.209(a) is not required. In addition, radiated emissions which fall in the restricted bands, as defined in Section 15.205(a), must also comply with the radiated emission limits specified in Section 15.209(a) (see Section 15.205(c)).

Test Equipment

Item	Equipment	Manufacturer	Model No.	Serial No.	Last Cal.	Cal. Interval
1.	Spectrum Analysis	Agilent	E4407B	US39390582	Apr. 17, 2015	1 Year
2.	Preamplifier	Instruments corporation	EMC011830	980100	Apr. 17, 2015	1 Year
3.	EMI Test Receiver	Rohde & Schwarz	ESPI	101604	Apr. 17, 2015	1 Year
4.	Double Ridged Horn Antenna	Instruments corporation	GTH-0118	351600	Apr. 20, 2015	1 Year
5.	Bilog Broadband Antenna	Schwarzbeck	VULB9163	VULB 9163-289	Apr. 20, 2015	1 Year
6.	Pre-amplifier	SONOMA	310N	186860	Apr. 17, 2015	1 Year
7.	EMI Test Software EZ-EMC	SHURPLE	N/A	N/A	N/A	N/A

4.6.2. Test Configuration:

4.6.2.1. 9k to 30MHz emissions:

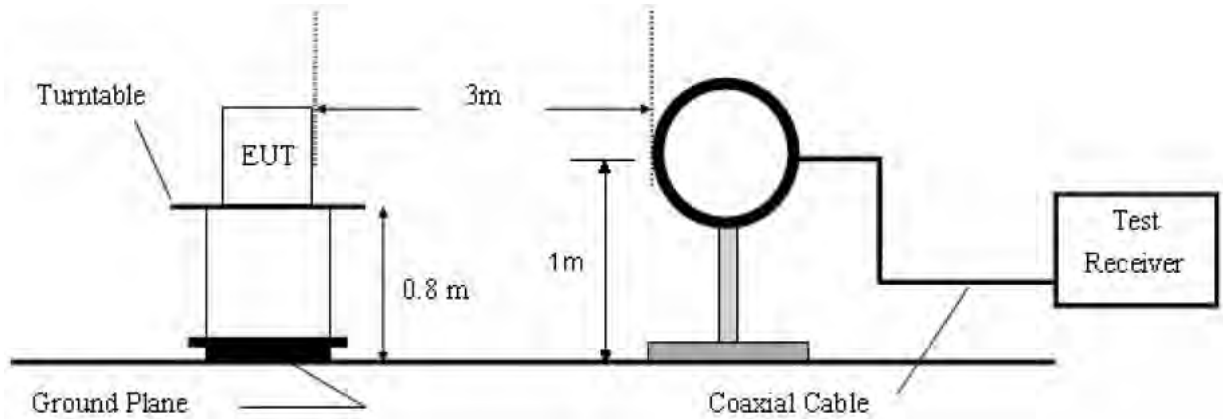

4.6.2.2. 30M to 1G emissions:

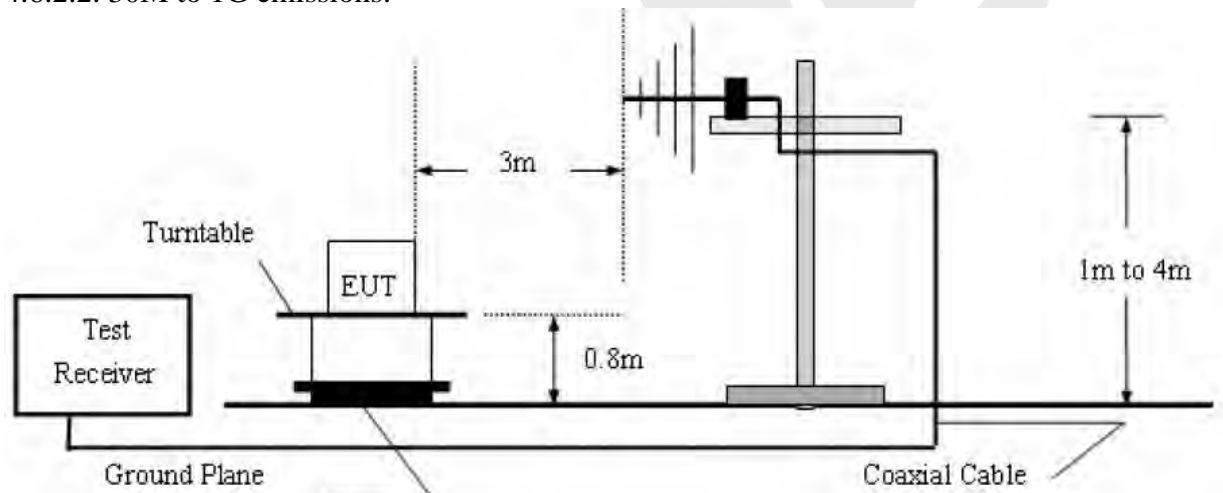

4.6.2.3. 1G to 40G emissions:

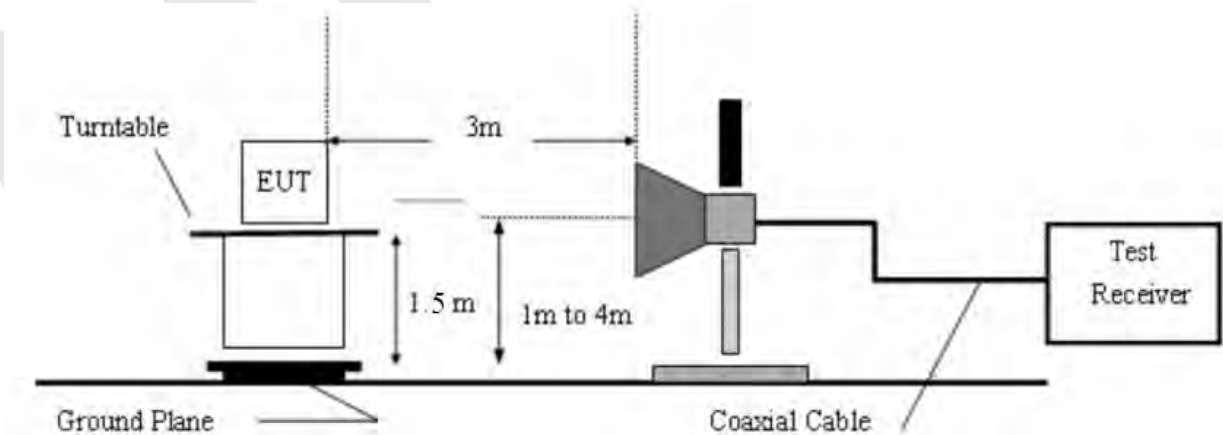

4.6.3. Test Procedure

The EUT is placed on a turn table which is 0.8 meter high above the ground. The turn table can rotate 360 degrees to determine the position of the maximum emission level. The EUT is set 3 meters away from the receiving antenna which is mounted on a antenna tower. The antenna can be moved up and down from 1 to 4 meters to find out the maximum emission level. Both horizontal and vertical polarization of the antenna are set on test.

Measurements are made on 9KHz to 30MHz and 30MHz to 26GHz range with the transmitter set to the lowest, middle, and highest channels.

All readings from 30MHz to 1GHz are quasi-peak values with a resolution bandwidth of 120kHz. All reading are above 1GHz, peak & average values with a resolution bandwidth of 1MHz.

The EUT is tested in 9*6*6 Chamber.

The test results are listed in Section 4.6.4.

4.6.4. Test Results

Please refer to the following pages.

Job No.:	011503627E	Polarization:	Horizontal
Standard:	(RE)FCC PART15 C_3m	Power Source:	AC 120V, 60Hz for adapter
Test item:	Radiation Test	Temp.(C)/Hum.(%RH):	24.3(C)/55%RH
Test Mode:	On	Distance:	3m

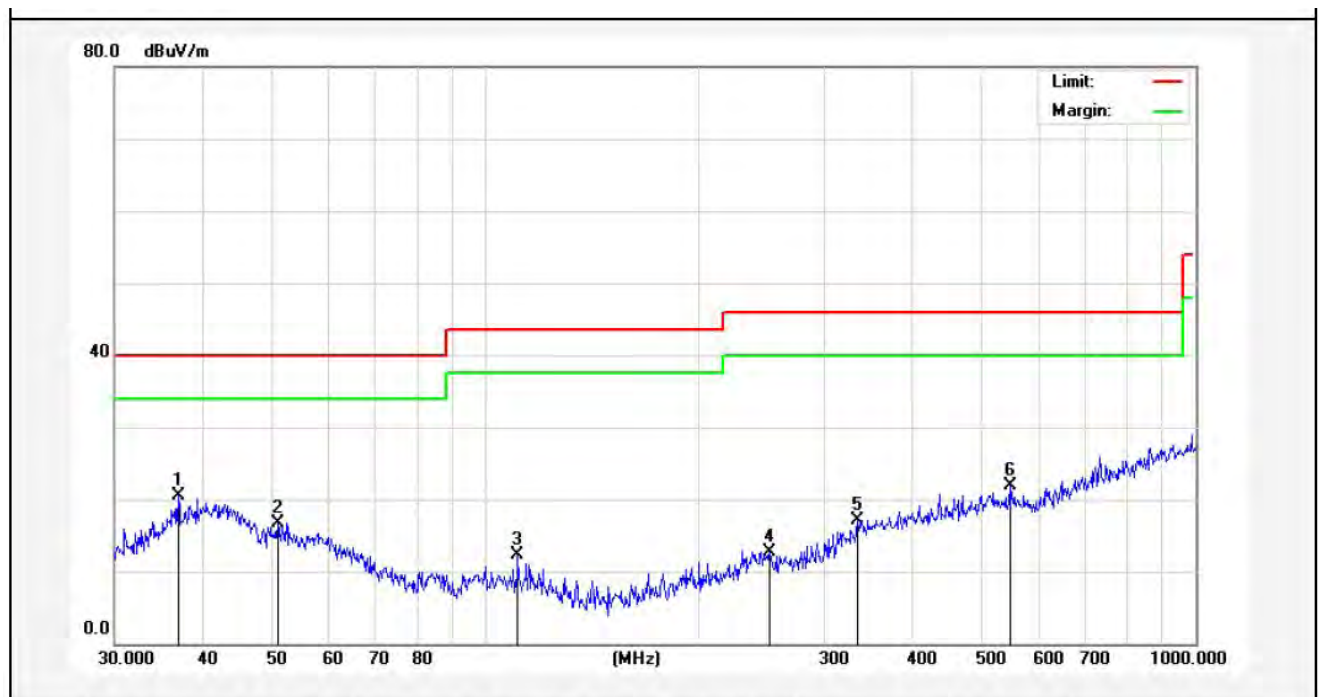

No.	Freq. (MHz)	Reading (dBuV/m)	Factor (dB/m)	Result (dBuV/m)	Limit (dBuV/)	Over Limit (dB)	Detector	Height (cm)	degree (deg)	Remark
1	36.8953	33.21	-12.79	20.42	40.00	-19.58	peak			
2	50.9420	31.33	-14.63	16.70	40.00	-23.30	peak			
3	110.9571	33.06	-20.69	12.37	43.50	-31.13	peak			
4	251.1804	31.36	-18.59	12.77	46.00	-33.23	peak			
5	333.6867	31.77	-14.61	17.16	46.00	-28.84	peak			
6	547.0977	32.97	-11.08	21.89	46.00	-24.11	peak			

Job No.:	011503627E	Polarization:	Vertical
Standard:	(RE)FCC PART15 C_3m	Power Source:	AC 120V, 60Hz for adapter
Test item:	Radiation Test	Temp.(C)/Hum.(%RH):	24.3(C)/55%RH
Test Mode:	On	Distance:	3m

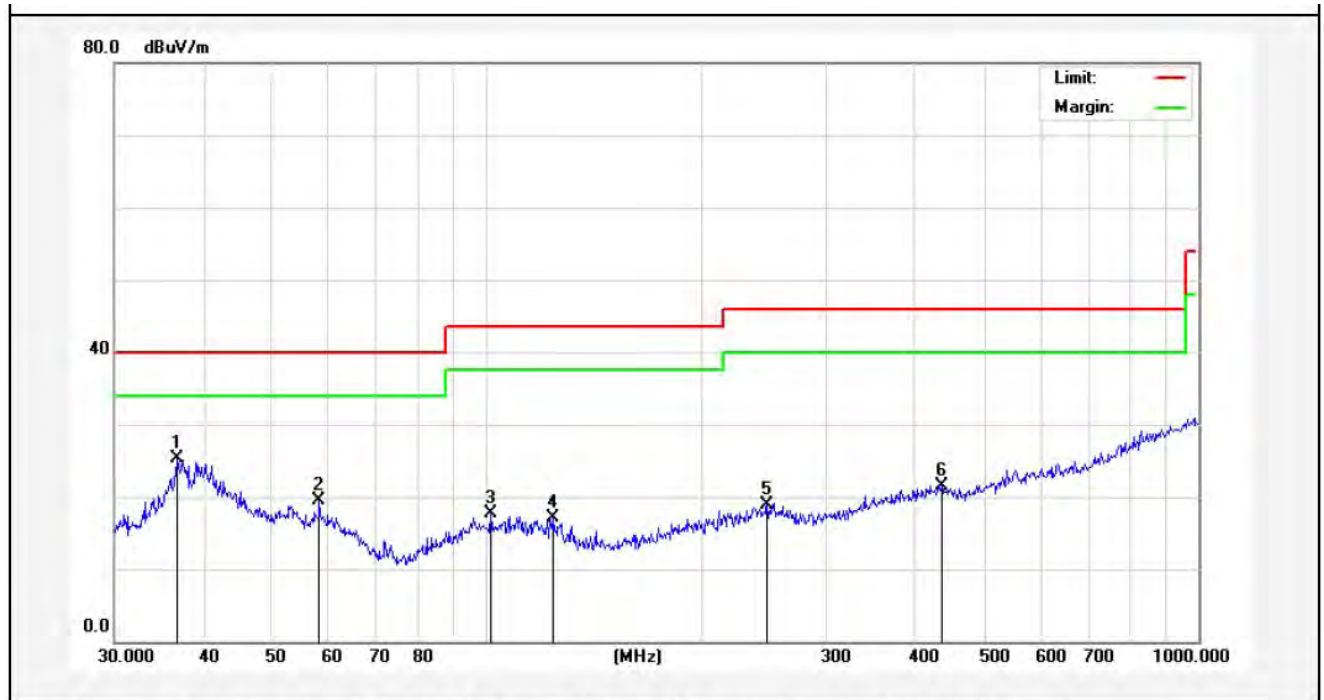

No.	Freq. (MHz)	Reading (dBuV/m)	Factor (dB/m)	Result (dBuV/m)	Limit (dBuV/)	Over Limit (dB)	Detector	Height (cm)	degree (deg)	Remark
1	36.7662	38.13	-12.91	25.22	40.00	-14.78	peak			
2	58.2030	34.69	-15.23	19.46	40.00	-20.54	peak			
3	101.2885	33.50	-15.75	17.75	43.50	-25.75	peak			
4	124.1330	33.97	-16.95	17.02	43.50	-26.48	peak			
5	247.6819	32.92	-14.06	18.86	46.00	-27.14	peak			
6	435.5898	32.68	-11.22	21.46	46.00	-24.54	peak			

Job No.:	011503627E	Polarization:	Horizontal
Standard:	(RE)FCC PART15 C _3m	Power Source:	AC 120V, 60Hz for adapter
Test item:	Radiation Test	Temp.(C)/Hum.(%RH):	24.3(C)/55%RH
Note:	802.11b(2412MHz)	Distance:	3m

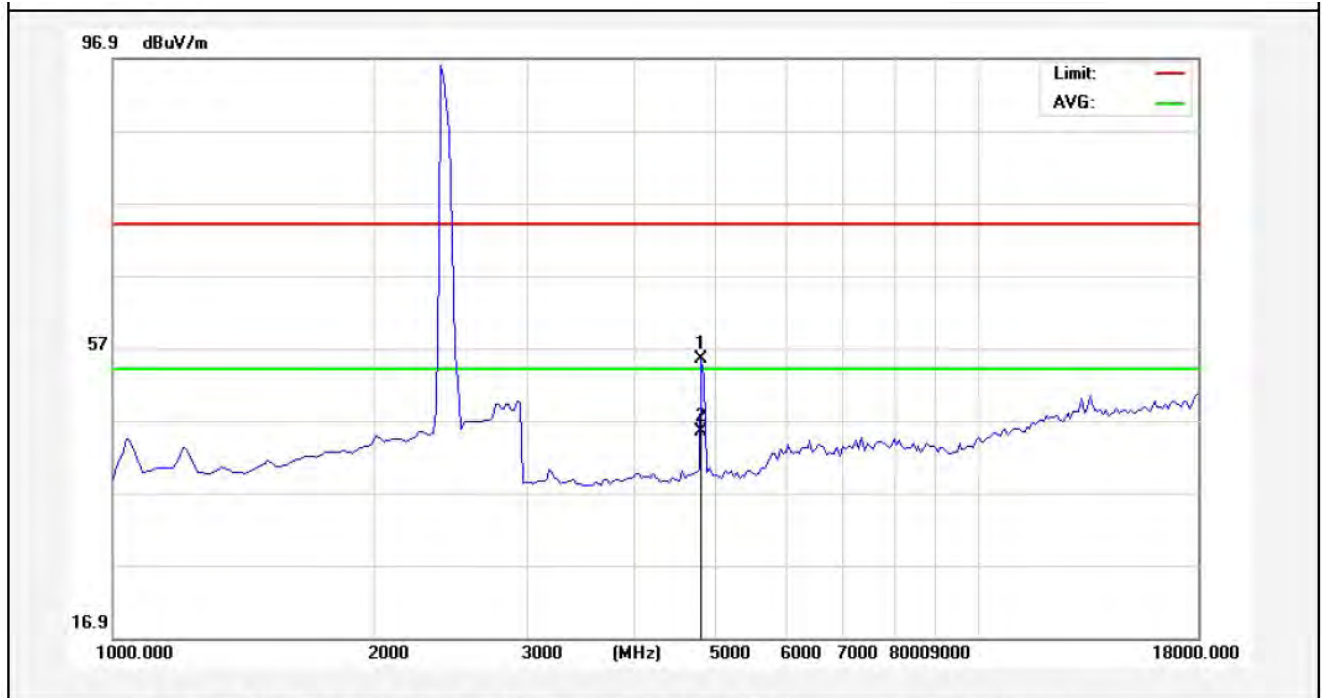

No.	Freq. (MHz)	Reading (dBuV/m)	Factor (dB/m)	Result (dBuV/m)	Limit (dBuV/)	Over Limit (dB)	Detector	Height (cm)	degree (deg)	Remark
1	4825.000	52.10	3.34	55.44	74.00	-18.56	peak			
2	4825.000	42.02	3.34	45.36	54.00	-8.64	AVG			



Job No.:	011503627E	Polarization:	Vertical
Standard:	(RE)FCC PART15 C _3m	Power Source:	AC 120V, 60Hz for adapter
Test item:	Radiation Test	Temp.(C)/Hum.(%RH):	24.3(C)/55%RH
Note:	802.11b(2412MHz)	Distance:	3m

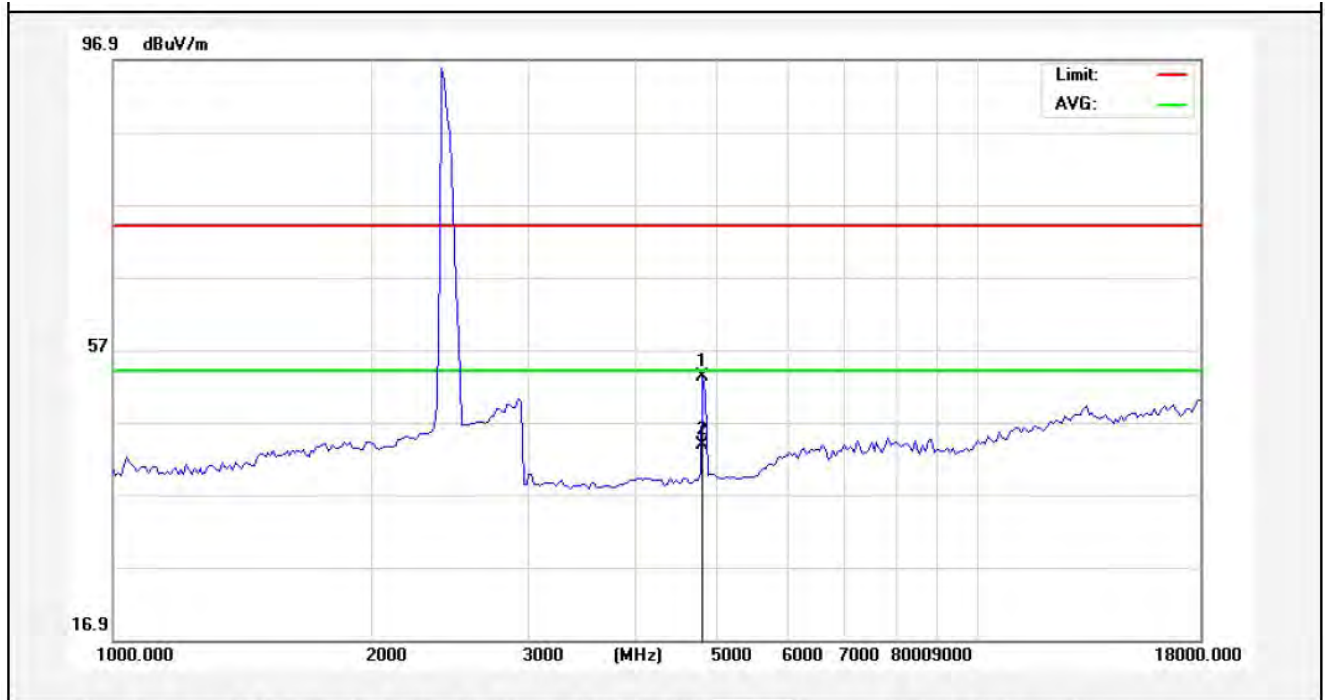

No.	Freq. (MHz)	Reading (dBuV/m)	Factor (dB/m)	Result (dBuV/m)	Limit (dBuV/)	Over Limit (dB)	Detector	Height (cm)	degree (deg)	Remark
1	4825.000	49.87	3.34	53.21	74.00	-20.79	peak			
2	4825.000	40.40	3.34	43.74	54.00	-10.26	AVG			

AM

Job No.:	011503627E	Polarization:	Horizontal
Standard:	(RE)FCC PART15 C_3m	Power Source:	AC 120V, 60Hz for adapter
Test item:	Radiation Test	Temp.(C)/Hum.(%RH):	24.3(C)/55%RH
Note:	802.11b(2437MHz)	Distance:	3m

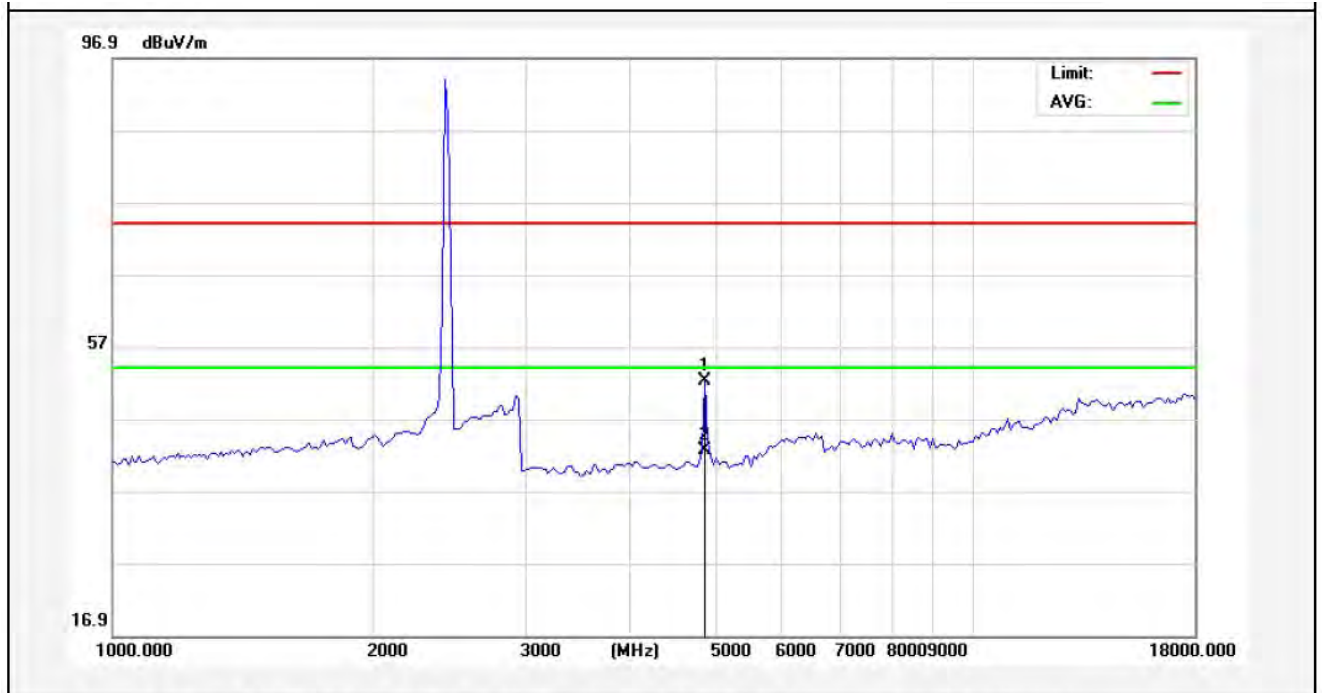

No.	Freq. (MHz)	Reading (dBuV/m)	Factor (dB/m)	Result (dBuV/m)	Limit (dBuV/)	Over Limit (dB)	Detector	Height (cm)	degree (deg)	Remark
1	4867.500	48.89	3.41	52.30	74.00	-21.70	peak			
2	4867.500	39.24	3.41	42.65	54.00	-11.35	AVG			

AEM

Job No.:	011503627E	Polarization:	Vertical
Standard:	(RE)FCC PART15 C _3m	Power Source:	AC 120V, 60Hz for adapter
Test item:	Radiation Test	Temp.(C)/Hum.(%RH):	24.3(C)/55%RH
Note:	802.11b(2437MHz)	Distance:	3m

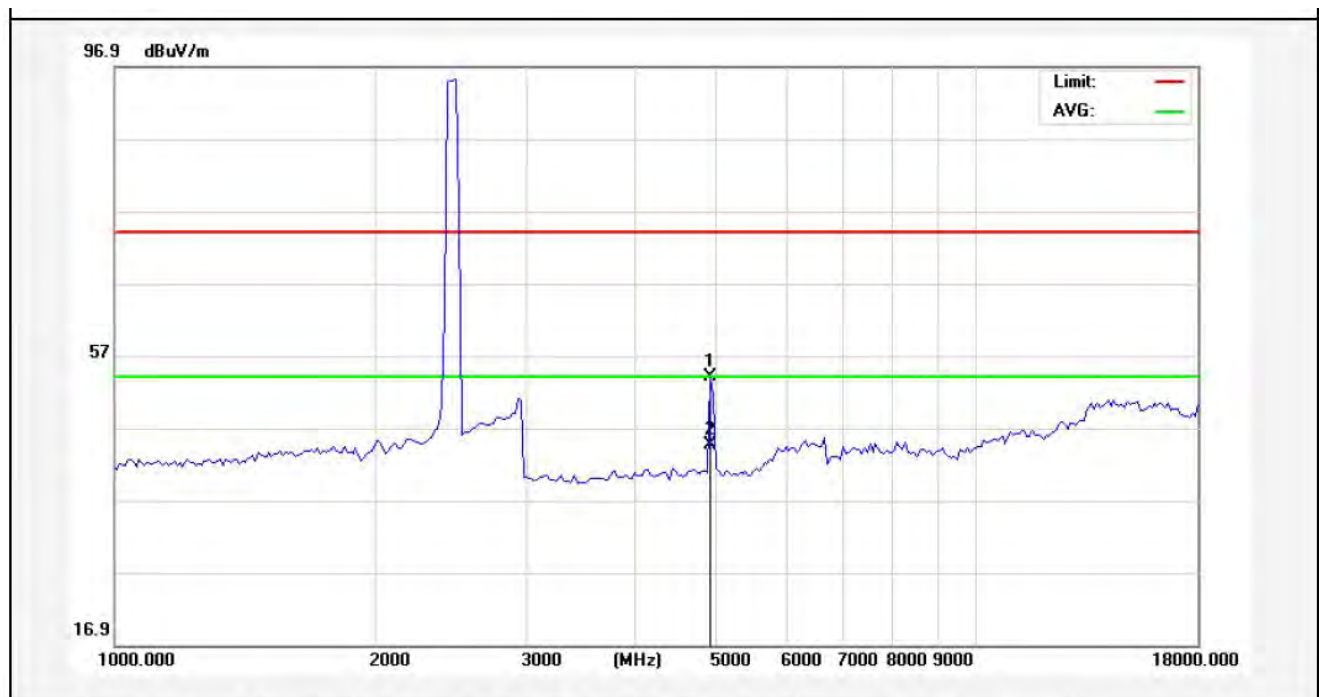

No.	Freq. (MHz)	Reading (dBuV/m)	Factor (dB/m)	Result (dBuV/m)	Limit (dBuV/)	Over Limit (dB)	Detector	Height (cm)	degree (deg)	Remark
1	4910.000	50.53	3.49	54.02	74.00	-19.98	peak			
2	4910.000	41.19	3.49	44.68	54.00	-9.32	AVG			



Job No.:	011503627E	Polarization:	Horizontal
Standard:	(RE)FCC PART15 C_3m	Power Source:	AC 120V, 60Hz for adapter
Test item:	Radiation Test	Temp.(C)/Hum.(%RH):	24.3(C)/55%RH
Note:	802.11b(2462MHz)	Distance:	3m

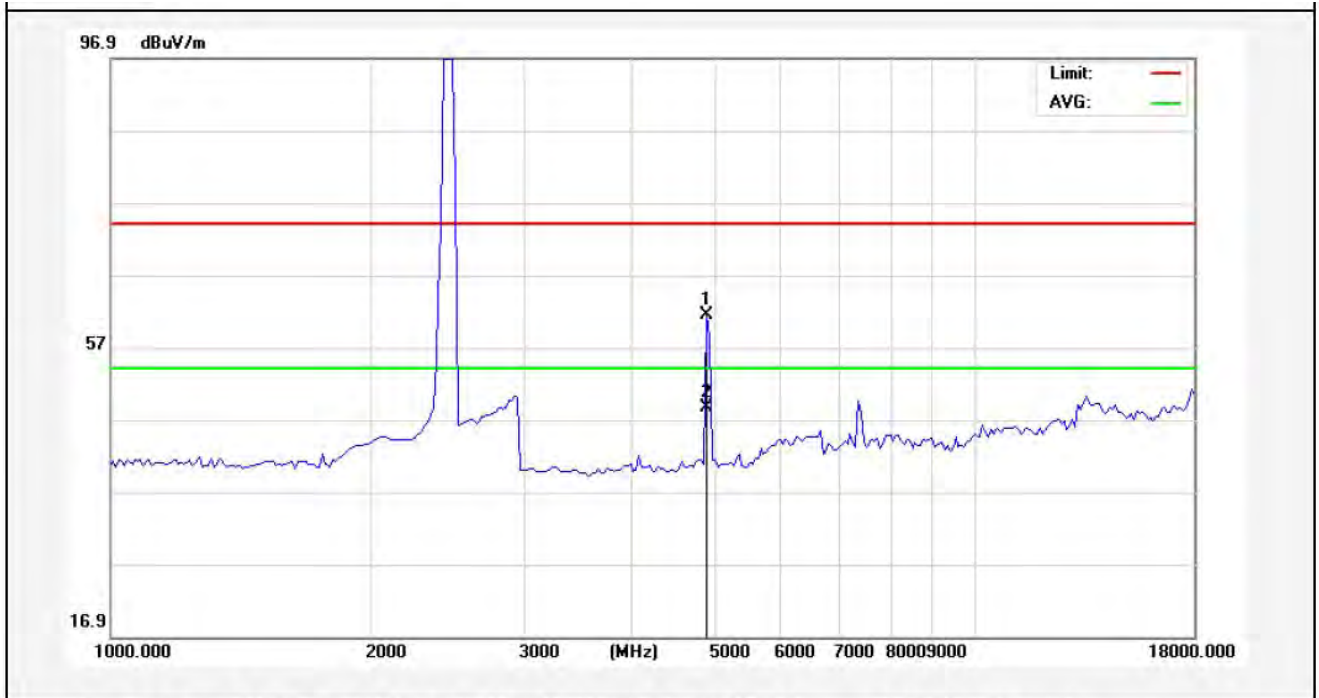

No.	Freq. (MHz)	Reading (dBuV/m)	Factor (dB/m)	Result (dBuV/m)	Limit (dBuV/)	Over Limit (dB)	Detector	Height (cm)	degree (deg)	Remark
1	4910.000	57.87	3.49	61.36	74.00	-12.64	peak			
2	4910.000	45.16	3.49	48.65	54.00	-5.35	AVG			

AEM

Job No.:	011503627E	Polarization:	Vertical
Standard:	(RE)FCC PART15 C_3m	Power Source:	AC 120V, 60Hz for adapter
Test item:	Radiation Test	Temp.(C)/Hum.(%RH):	24.3(C)/55%RH
Note:	802.11b(2462MHz)	Distance:	3m

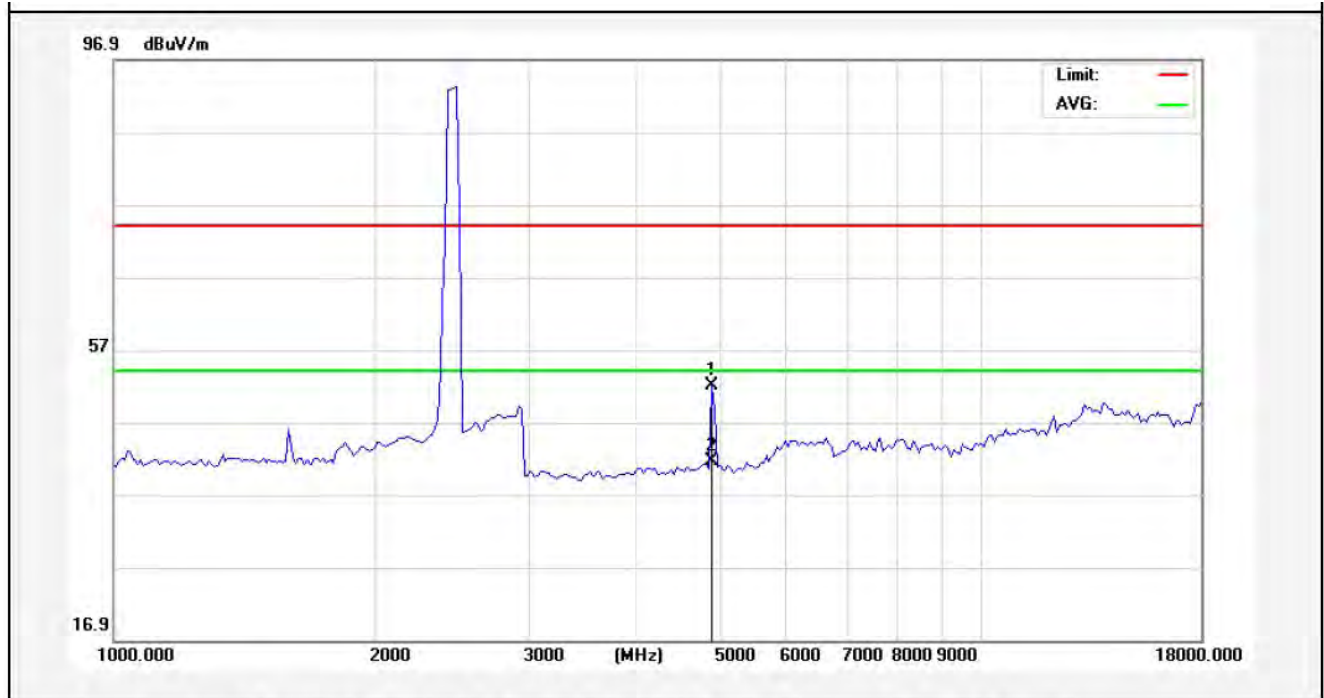

No.	Freq. (MHz)	Reading (dBuV/m)	Factor (dB/m)	Result (dBuV/m)	Limit (dBuV/)	Over Limit (dB)	Detector	Height (cm)	degree (deg)	Remark
1	4902.300	48.46	3.48	51.94	74.00	-22.06	peak			
2	4902.300	38.17	3.48	41.65	54.00	-12.35	AVG			

AEM

5. ANTENNA APPLICATION

5.1. Antenna requirement

The EUT'S antenna is met the requirement of FCC part 15C section 15.203.

An intentional radiator shall be designed to ensure that no antenna other than that furnished by the responsible party shall be used with the device. The use of a permanently attached antenna or of an antenna that uses a unique coupling to the intentional radiator shall be considered sufficient to comply with the provisions of this section. The manufacturer may design the unit so that a broken antenna can be replaced by the user, but the use of a standard antenna jack or electrical connector is prohibited. This requirement does not apply to carrier current devices or to devices operated under the provisions of §15.211, §15.213, §15.217, §15.219, or §15.221. Further, this requirement does not apply to intentional radiators that must be professionally installed, such as perimeter protection systems and some field disturbance sensors, or to other intentional radiators which, in accordance with §15.31(d), must be measured at the installation site. However, the installer shall be responsible for ensuring that the proper antenna is employed so that the limits in this part are not exceeded.

5.2. Result

The EUT's antenna used a chip antenna which is permanently attached, The antenna's gain is 2dBi and meets the requirement.

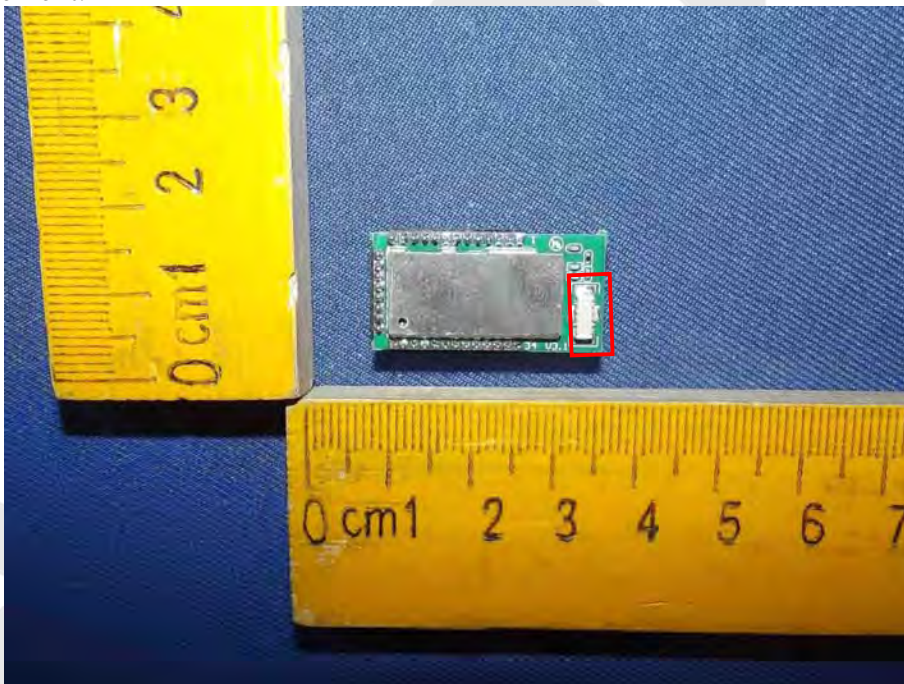

6. PHOTOGRAPH

6.1. Photo of Conducted Emission Measurement



6.2. Photo of Radiation Emission Test

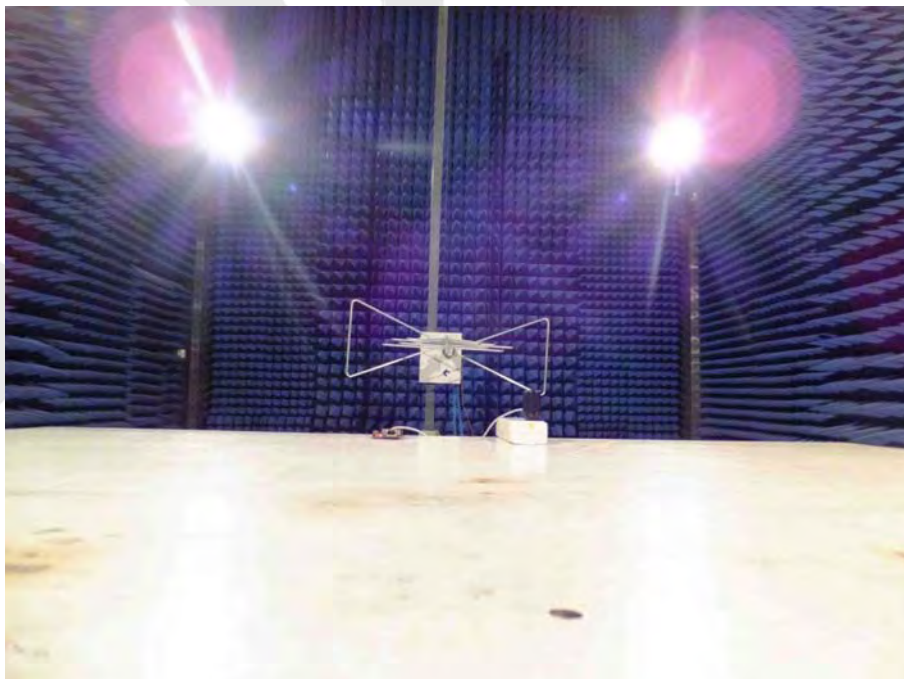

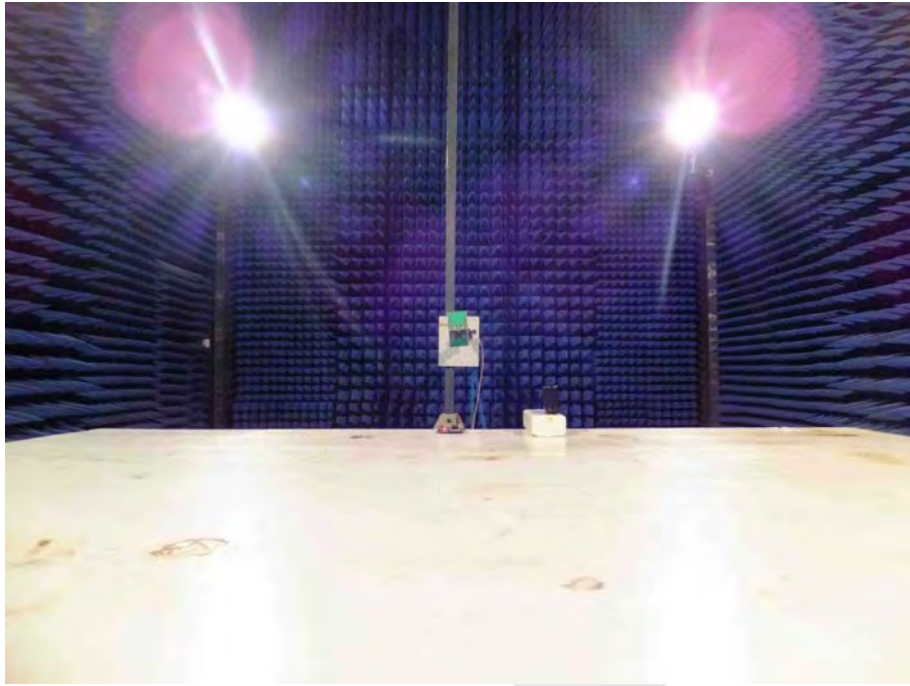

Anbotek

APPENDIX I (EXTERNAL PHOTOS)

Figure 1
The EUT-Front View

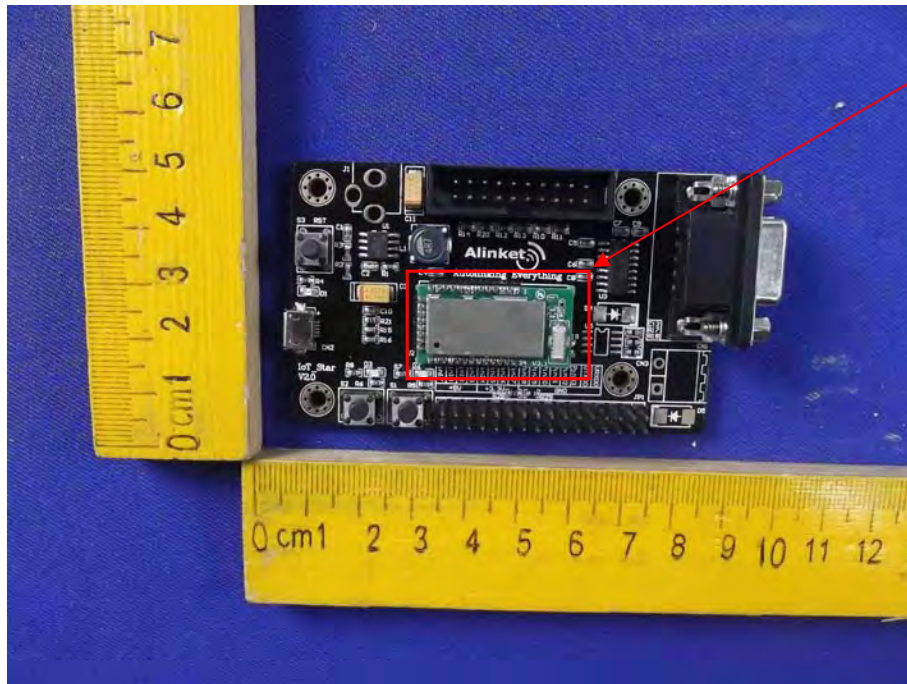

Figure 2
The EUT-Back View

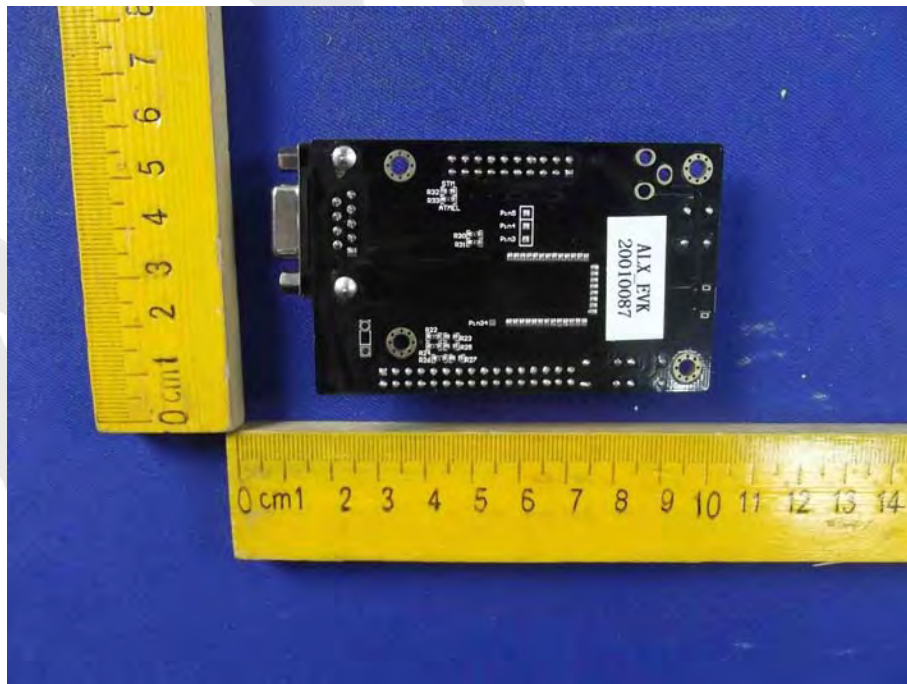
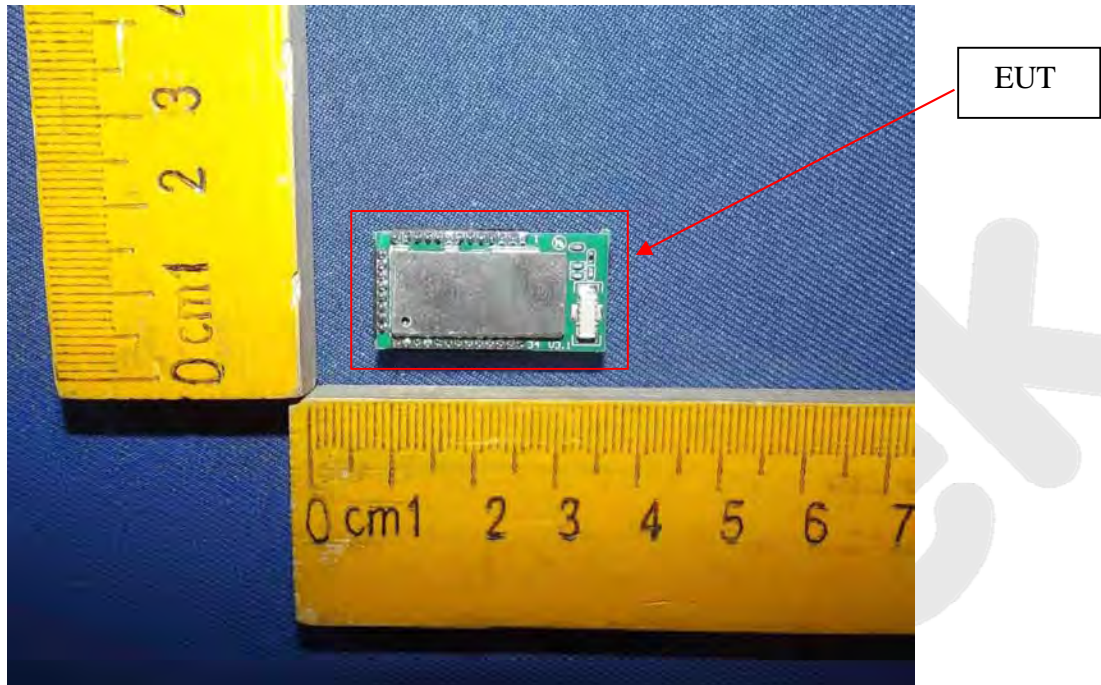

Figure 3
The EUT-Front View



APPENDIX II (INTERNAL PHOTOS)

Figure 4
The EUT-Inside View



Figure 5
The EUT-Inside View

