

**ELECTROMAGNETIC EMISSIONS COMPLIANCE REPORT
INTENTIONAL RADIATOR CERTIFICATION TO
FCC PART 15 SUBPART C REQUIREMENT**

OF

Micro Home Music System

Model No.: IHB248, RC7091

Trademark: N/A

FCC ID: 2AEKZ-IHB248

Report No.: ES171220963E2

Issue Date: January 03, 2018

Prepared for

**RICH FIELD ELECTRONICS COMPANY LIMITED.
2/F.No.10, Lingxia Road, Tian Tou Jiao Village, Qiaotou Town, Dong Guan,
Guangdong.**

Prepared by

EMTEK(SHENZHEN) CO., LTD.

**Bldg 69, Majialong Industry Zone, Nanshan District, Shenzhen,
Guangdong, China.**

TEL: 86-755-26954280

FAX: 86-755-26954282

**This report shall not be reproduced, except in full, without the written approval of
EMTEK(SHENZHEN) CO., LTD.**

VERIFICATION OF COMPLIANCE

Applicant:	RICH FIELD ELECTRONICS COMPANY LIMITED. 2/F.No.10, Lingxia Road, Tian Tou Jiao Village, Qiaotou Town, Dong Guan, Guangdong.
Manufacturer:	RICH FIELD ELECTRONICS COMPANY LIMITED. 2/F.No.10, Lingxia Road, Tian Tou Jiao Village, Qiaotou Town, Dong Guan, Guangdong.
Product Description:	Micro Home Music System
Trade Mark:	N/A
Model Number:	IHB248, RC7091 (note: The models are the same except model number, Here we prepare IHB248 for the EMC test)

We hereby certify that:

The above equipment was tested by EMTEK(SHENZHEN) CO., LTD. The test data, data evaluation, test procedures, and equipment configurations shown in this report were made in accordance with the procedures given in ANSI C63.10-2013 and the energy emitted by the sample EUT tested as described in this report is in compliance with conducted and radiated emission limits of FCC Rules Part 15.247(2017).

Date of Test : December 20, 2017 to December 26, 2017

Prepared by : 

Yaping Shen/Editor

Reviewer : 

Joe Xia/Supervisor

Approved & Authorized Signer : 

Lisa Wang/Manager

Modified Information

Version	Summary	Revision Date	Report No.
Ver.1.0	Original Report	/	ES171220963E2

Table of Contents

1. GENERAL INFORMATION	6
1.1 PRODUCT DESCRIPTION.....	6
1.2 TEST METHODOLOGY.....	6
2. TEST FACILITY.....	7
3. DESCRIPTION OF TEST MODES.....	8
4. TEST SYSTEM UNCERTAINTY.....	10
5. CONDUCTED EMISSIONS TEST.....	11
5.1 MEASUREMENT PROCEDURE:	11
5.2 TEST SET-UP (BLOCK DIAGRAM OF CONFIGURATION).....	11
5.3 MEASUREMENT EQUIPMENT USED:	11
5.4 CONDUCTED EMISSION LIMIT	11
5.5 MEASUREMENT RESULT:.....	12
5.6 CONDUCTED MEASUREMENT PHOTOS:	15
6. RADIATED EMISSION TEST	16
6.1 MEASUREMENT PROCEDURE	16
6.2 TEST SET-UP (BLOCK DIAGRAM OF CONFIGURATION).....	18
6.3 MEASUREMENT EQUIPMENT USED:	19
6.4 RADIATED EMISSION LIMIT	20
6.5 MEASUREMENT RESULT	21
6.6 RADIATED MEASUREMENT PHOTOS:	27
7. 6DB BANDWIDTH MEASUREMENT.....	28
7.1 MEASUREMENT PROCEDURE	28
7.2 TEST SET-UP (BLOCK DIAGRAM OF CONFIGURATION).....	28
7.3 MEASUREMENT EQUIPMENT USED:	28
7.4 LIMIT.....	28
7.5 MEASUREMENT RESULTS:.....	28
8. MAXIMUM PEAK OUTPUT POWER TEST	31
8.1 MEASUREMENT PROCEDURE	31
8.2 TEST SET-UP (BLOCK DIAGRAM OF CONFIGURATION).....	31
8.3 MEASUREMENT EQUIPMENT USED:	31
8.4 PEAK POWER OUTPUT LIMIT	31
8.5 MEASUREMENT RESULTS:.....	31
9. POWER SPECTRAL DENSITY MEASUREMENT.....	34
9.1 MEASUREMENT PROCEDURE	34
9.2 TEST SET-UP (BLOCK DIAGRAM OF CONFIGURATION).....	34
9.3 MEASUREMENT EQUIPMENT USED:	34

9.4 MEASUREMENT PROCEDURE 34

9.5 MEASUREMENT RESULTS:..... 35

10. BAND EDGE TEST..... 39

10.1 MEASUREMENT PROCEDURE 39

10.2 TEST SET-UP (BLOCK DIAGRAM OF CONFIGURATION)..... 40

10.3 MEASUREMENT EQUIPMENT USED: 40

10.4 MEASUREMENT RESULTS:..... 41

11. ANTENNA APPLICATION 47

11.1 ANTENNA REQUIREMENT 47

11.2 RESULT 47

1. GENERAL INFORMATION

1.1 Product Description

Characteristics	Description
Product Name	Micro Home Music System
Model number	IHB248
Input rating	AC 120V/60Hz
Power Supply	AC 120V/60Hz
Kind of Device	Bluetooth Ver.4.2 BLE
Modulation	GFSK
Operating Frequency Range	2402-2480MHz
Number of Channels	40
Transmit Power Max(PK)	-5.1dBm(0.000309W)
Antenna Type	Internal PCB antenna
Antenna Gain	4dBi

1.2 Test Methodology

All the test program has follow FCC new test procedure KDB 558074 D01 DTS Meas Guidance v04, April 5, 2017 and in accordance with the procedures given in ANSI C63.10-2013.

2. Test Facility

Site Description

EMC Lab. : Accredited by CNAS, 2016.10.24
The certificate is valid until 2022.10.28
The Laboratory has been assessed and proved to be in compliance with CNAS-CL01:2006 (identical to ISO/IEC 17025:2005)
The Certificate Registration Number is L2291.

Accredited by TUV Rheinland Shenzhen 2016.5.19
The Laboratory has been assessed according to the requirements ISO/IEC 17025.

Accredited by FCC, August 03, 2017
Designation Number: CN1204
Test Firm Registration Number: 882943

Accredited by Industry Canada, November 24, 2015
The Certificate Registration Number is 4480A.

Accredited by A2LA, July 31, 2017
The Certificate Number is 4321.01.

Name of Firm : EMTEK(SHENZHEN) CO., LTD.
Site Location : Bldg 69, Majialong Industry Zone, Nanshan District, Shenzhen, Guangdong, China.

3. Description of test modes

The EUT has been tested under its typical operating condition for EUT tested alone. Pre-defined engineering program for regulatory testing used to control the EUT for staying in continuous transmitting. Only the worst case data were reported.

The EUT has been associated with peripherals pursuant to ANSI C63.10-2013 and configuration operated in a manner tended to maximize its emission characteristics in a typical application. Frequency range investigated: radiation (9 KHz to the 10th harmonics of the highest fundamental frequency or to 40 GHz, whichever is lower).

The EUT has been tested under TX operating condition.

Channel List:

Channel	Frequency (MHz)	Channel	Frequency (MHz)	Channel	Frequency (MHz)
00	2402	14	2430	28	2458
01	2404	15	2432	29	2460
02	2406	16	2434	30	2462
03	2408	17	2436	31	2464
04	2410	18	2438	32	2466
05	2412	19	2440	33	2468
06	2414	20	2442	34	2470
07	2416	21	2444	35	2472
08	2418	22	2446	36	2474
09	2420	23	2448	37	2476
10	2422	24	2450	38	2478
11	2424	25	2452	39	2480
12	2426	26	2454		
13	2428	27	2456		

Note:

1. Test of channel was included the lowest 2402MHz, middle 2440MHz and highest frequency 2480MHz in highest data rate and to perform the test, then record on this report.

4. TEST SYSTEM UNCERTAINTY

The following measurement uncertainty levels have been estimated for tests performed on the apparatus:

Parameter	Uncertainty
Radio Frequency	$\pm 1 \times 10^{-5}$
Maximum Peak Output Power Test	$\pm 1.0\text{dB}$
Conducted Emissions Test	$\pm 2.0\text{dB}$
Radiated Emission Test	$\pm 2.0\text{dB}$
Power Density	$\pm 2.0\text{dB}$
Occupied Bandwidth Test	$\pm 1.0\text{dB}$
Band Edge Test	$\pm 3\text{dB}$
All emission, radiated	$\pm 3\text{dB}$
Antenna Port Emission	$\pm 3\text{dB}$
Temperature	$\pm 0.5^\circ\text{C}$
Humidity	$\pm 3\%$

Remark: The coverage Factor (k=2), and measurement Uncertainty for a level of Confidence of 95%

5. Conducted Emissions Test

5.1 Measurement Procedure:

1. The EUT was placed on a table, which is 0.8m above ground plane.
2. Maximum procedure was performed on the six highest emissions to ensure EUT compliance.
3. Repeat above procedures until all frequency measured was complete.

5.2 Test SET-UP (Block Diagram of Configuration)

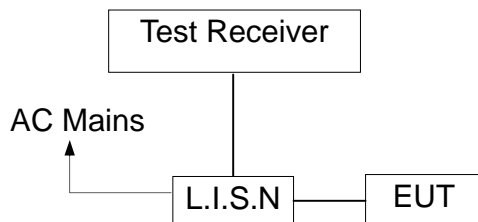

5.3 Measurement Equipment Used:

Conducted Emission Test Site						
EQUIPMENT TYPE	MFR	MODEL NUMBER	SERIAL NUMBER	Characteristics	Last Cal.	Due date
Test Receiver	Rohde & Schwarz	ESCS30	100018	9kHz~3GHz	05/16/2017	05/15/2018
L.I.S.N	Rohde & Schwarz	ENV216	100017	9KHz-300MHz	05/16/2017	05/15/2018
RF Switching Unit	CDS	RSU-M2	38401	9KHz-300MHz	05/16/2017	05/15/2018
Coaxial Cable	CDS	79254	46107086	9kHz~3GHz	05/16/2017	05/15/2018

5.4 Conducted Emission Limit

(7) Conducted Emission Frequency(MHz)

0.15-0.5
0.5-5.0
5.0-30.0

Quasi-peak
66-56
56
60

Average
56-46
46
50

Note:

1. The lower limit shall apply at the transition frequencies
2. The limit decreases in line with the logarithm of the frequency in the range of 0.15 to 0.50MHz.

5.5 Measurement Result:

Pass.

The data of the worst mode (GFSK TX 2441MHz) are recorded.

Please refer to the following data.

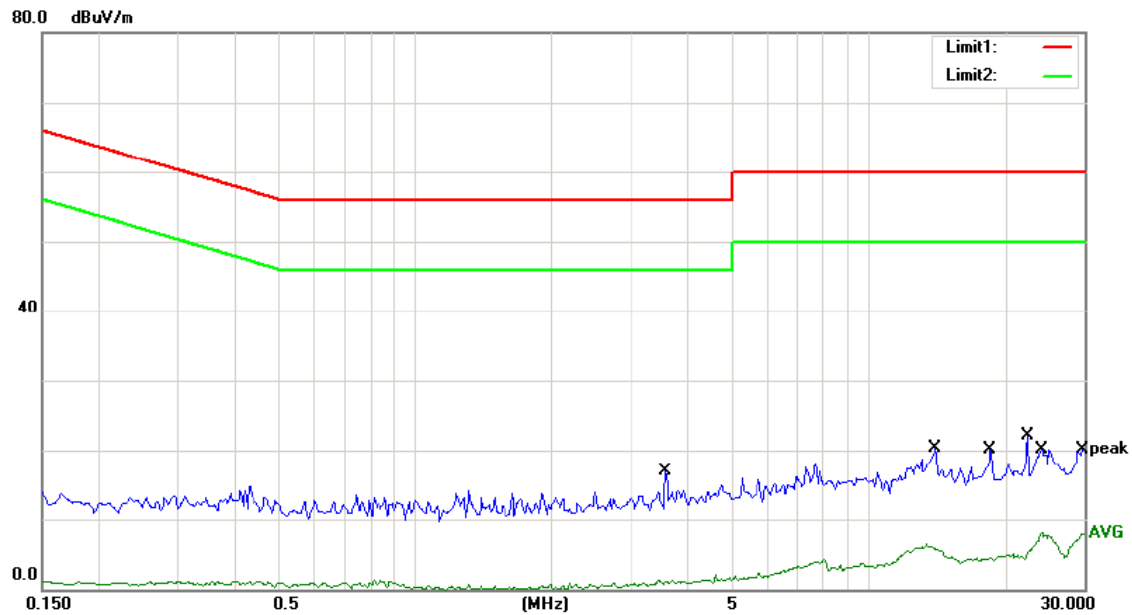

Site site #1
 Limit: (CE)FCC PART 15C_QP
 Mode: DTS(TX2441)
 Note:

Phase: **L1** Temperature: 26
 Power: AC 120V/60Hz Humidity: 60 %

No.	Mk.	Freq. MHz	Reading Level dBuV/m	Correct Factor dB	Measure- ment dBuV/m	Limit dBuV/m	Over dB	Detector	Comment
1		3.5800	16.92	0.00	16.92	56.00	-39.08	QP	
2		3.5800	1.28	0.00	1.28	46.00	-44.72	AVG	
3		14.1000	20.32	0.00	20.32	60.00	-39.68	QP	
4		14.1000	5.78	0.00	5.78	50.00	-44.22	AVG	
5		18.6000	20.13	0.00	20.13	60.00	-39.87	QP	
6		18.6000	4.49	0.00	4.49	50.00	-45.51	AVG	
7	*	22.5500	22.20	0.00	22.20	60.00	-37.80	QP	
8		22.5500	5.77	0.00	5.77	50.00	-44.23	AVG	
9		24.2500	20.12	0.00	20.12	60.00	-39.88	QP	
10		24.2500	8.18	0.00	8.18	50.00	-41.82	AVG	
11		30.0000	20.20	0.00	20.20	60.00	-39.80	QP	
12		30.0000	7.98	0.00	7.98	50.00	-42.02	AVG	

*:Maximum data x:Over limit !:over margin Comment: Factor build in receiver. Operator: Lin

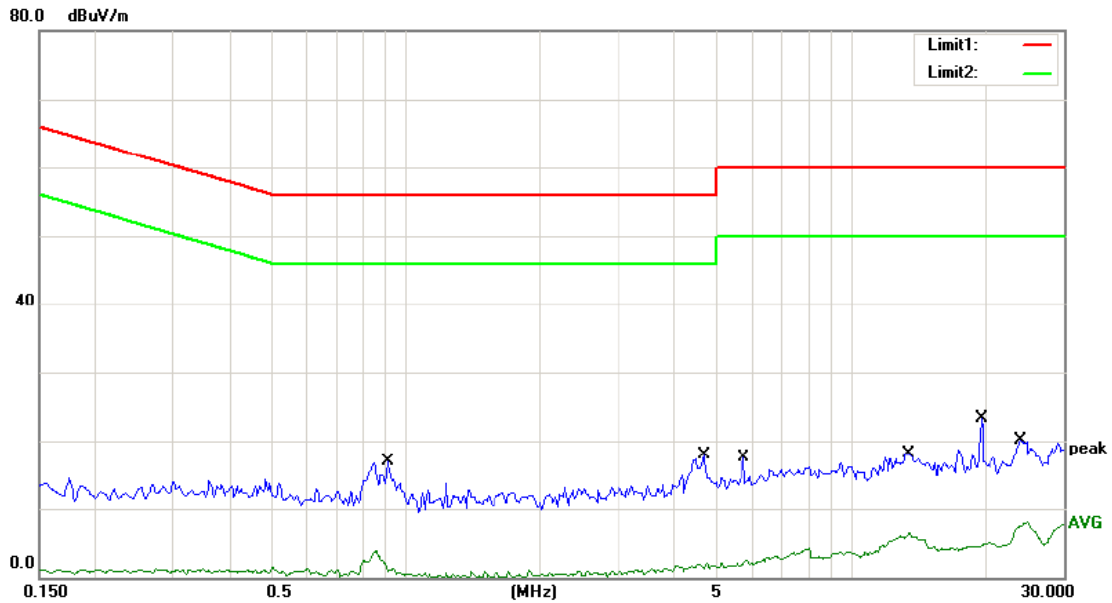

Site site #1 Phase: **N** Temperature: 26
 Limit: (CE)FCC PART 15C_QP Power: AC 120V/60Hz Humidity: 60 %
 Mode: DTS(TX2441)
 Note:

No.	Mk.	Freq.	Reading Level	Correct Factor	Measurement	Limit	Over	Detector	Comment
		MHz	dBuV/m	dB	dBuV/m	dBuV/m	dB		
1		0.9100	16.83	0.00	16.83	56.00	-39.17	QP	
2		0.9100	3.96	0.00	3.96	46.00	-42.04	AVG	
3		4.6500	17.94	0.00	17.94	56.00	-38.06	QP	
4		4.6500	2.07	0.00	2.07	46.00	-43.93	AVG	
5		5.7200	17.49	0.00	17.49	60.00	-42.51	QP	
6		5.7200	2.52	0.00	2.52	50.00	-47.48	AVG	
7		13.5500	18.12	0.00	18.12	60.00	-41.88	QP	
8		13.5500	6.50	0.00	6.50	50.00	-43.50	AVG	
9	*	19.6000	23.21	0.00	23.21	60.00	-36.79	QP	
10		19.6000	5.09	0.00	5.09	50.00	-44.91	AVG	
11		24.1000	20.04	0.00	20.04	60.00	-39.96	QP	
12		24.1000	8.15	0.00	8.15	50.00	-41.85	AVG	

*:Maximum data x:Over limit !:over margin Comment: Factor build in receiver. Operator: Lin

5.6 Conducted Measurement Photos:



6. Radiated Emission Test

6.1 Measurement Procedure

1. The testing follows the guidelines in ANSI C63.10-2013.
2. Below 1000MHz, The EUT was placed on a turn table which is 0.8m above ground plane. And above 1000MHz, The EUT was placed on a styrofoam table which is 1.5m above ground plane.
3. The EUT was set 3 meters from the interference receiving antenna, which was mounted on the top of a variable height antenna tower.
4. The EUT was arranged to its worst case and then tune the Antenna tower (From 1m to 4m) and turntable (from 0 degree to 360 degrees) to find the maximum reading. A pre-amp and a high pass filter are used for the test in order to get better signal level.
5. For measurement below 1GHz, if the emission level of the EUT measured by the peak detector is 3dB lower than the applicable limit, the peak emission level will be reported. Otherwise, the emission measurement will be repeated using the quasi-peak detector and reported.
6. Final measurement (Above 1GHz): The frequency range will be divided into different sub ranges depending of the frequency range of the used horn antenna. The EMI Receiver set to peak and average mode and a resolution bandwidth of 1MHz. The measurement will be performed in horizontal and vertical polarization of the measuring antenna and while rotating the EUT in its vertical axis in the range of 0 degree to 360 degree in order to have the antenna inside the cone of radiation.
7. Test Procedure of measurement (For Above 1GHz):
 - 1) Monitor the frequency range at horizontal polarization and move the antenna over all sides of the EUT(if necessary move the EUT to another orthogonal axis).
 - 2) Change the antenna polarization and repeat 1) with vertical polarization.
 - 3) Make a hardcopy of the spectrum.
 - 4) Measure the frequency of the detected emissions with a lower span and resolution bandwidth to increase the accuracy and note the frequency value.
 - 5) Change the analyser mode to Clear/ Write and found the cone of emission.
 - 6) Rotate and move the EUT, so that the measuring distance can be enlarged to 3m and the antenna will be still inside the cone of emission.
 - 7) Measure the level of the detected frequency with the correct resolution bandwidth, with the antenna polarization and azimuth and the peak and average detector, which causes the maximum emission.
 - 8) Repeat steps 1) to 7) for the next antenna spot if the EUT is larger than the antenna beamwidth.

Use the following spectrum analyzer settings:

When spectrum scanned from 30MHz to 1GHz setting resolution bandwidth 120KHz and video bandwidth 300KHz:

EMI Test Receiver	Setting
Attenuation	Auto
RB	120KHz
VB	300KHz
Detector	QP
Trace	Max hold

When spectrum scanned above 1GHz setting resolution bandwidth 1MHz, video bandwidth 3MHz:

EMI Test Receiver	Setting
Attenuation	Auto
RB	1MHz
VB	3MHz
Detector	Peak
Trace	Max hold

When spectrum scanned above 1GHz setting resolution bandwidth 1MHz, video bandwidth 10Hz:

EMI Test Receiver	Setting
Attenuation	Auto
RB	1MHz
VB	10Hz
Detector	Peak
Trace	Max hold

For Average Measurement:

VBW=10Hz, when duty cycle is no less than 98 percent.

$VBW \geq 1/T$, when duty cycle is less than 98 percent where T is the minimum transmission duration over which the transmitter is on and is transmitting at its maximum power control level for the tested mode of operation.

Band	Duty Cycle(%)	T(μ s)	1/T(KHz)	Average Correction Factor	VBW Setting
2402-2480	100	-	-	0	10Hz

6.2 Test SET-UP (Block Diagram of Configuration)

(A) Radiated Emission Test Set-Up, Frequency Below 30MHz

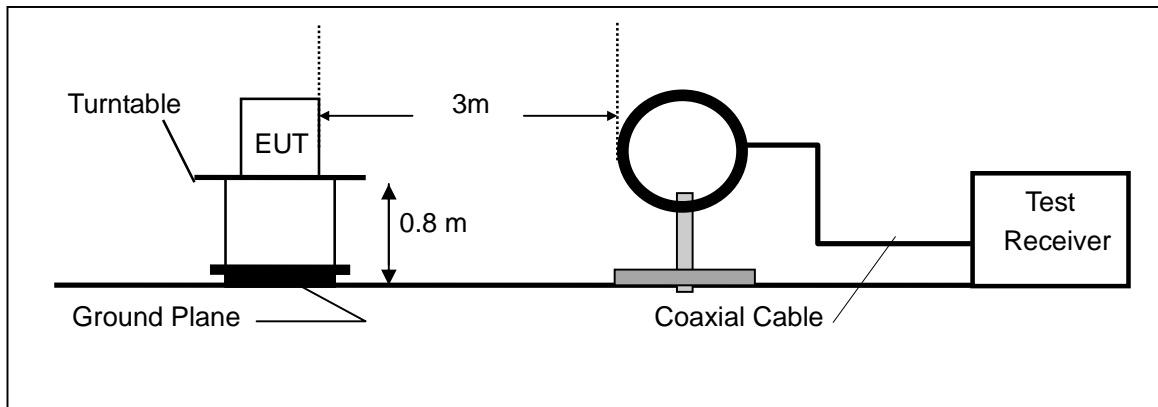

(B) Radiated Emission Test Set-Up, Frequency Below 1000MHz

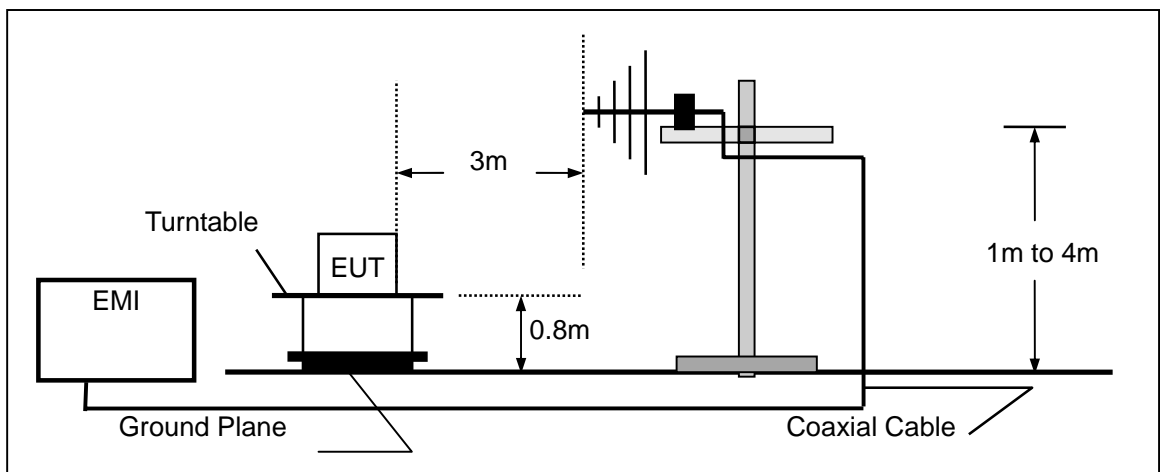

(C) Radiated Emission Test Set-Up, Frequency above 1000MHz

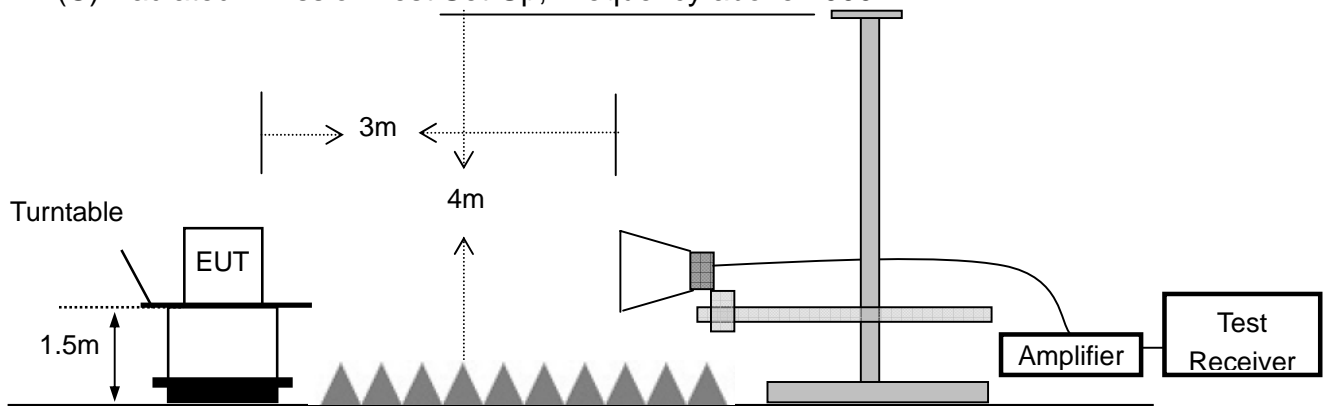

6.3 Measurement Equipment Used:

Item	Equipment	Manufacturer	Model No.	Serial No.	Characteristics	Last Cal.	Cal. Interval
1.	Test Receiver	Rohde & Schwarz	ESCI	1166.5950.03	9KHz-3GHz	05/16/2017	1 Year
2.	Loop Antenna	Schwarzbeck	FMZB 1519	012	9 KHz -30MHz	05/16/2017	1 Year
3.	Bilog Antenna	Schwarzbeck	VULB9163	000141	25MHz-2GHz	05/16/2017	1 Year
4.	Power Amplifier	CDS	RSU-M352	818	1MHz-1GHz	05/16/2017	1 Year
5.	Power Amplifier	HP	8447F	OPT H64	1GHz-26.5GHz	05/16/2017	1 Year
6.	Color Monitor	SUNSP0	SP-140A	N/A	--	05/16/2017	1 Year
7.	Single Line Filter	JIANLI	XL-3	N/A	--	05/16/2017	1 Year
8.	Single Phase Power Line Filter	JIANLI	DL-2X100B	N/A	--	05/16/2017	1 Year
9.	3 Phase Power Line Filter	JIANLI	DL-4X100B	N/A	--	05/16/2017	1 Year
10.	DC Power Filter	JIANLI	DL-2X50B	N/A	--	05/16/2017	1 Year
11.	Cable	Schwarzbeck	PLF-100	549489	9KHz-3GHz	05/16/2017	1 Year
12.	Cable	Rosenberger	CIL02	A0783566	9KHz-3GHz	05/16/2017	1 Year
13.	Cable	Rosenberger	RG 233/U	525178	9KHz-3GHz	05/16/2017	1 Year
14.	Signal Analyzer	Rohde & Schwarz	FSV30	103040	9KHz-40GHz	05/16/2017	1 Year
15.	Horn Antenna	Schwarzbeck	BBHA9120D	9120D-1272	1GHz-18GHz	05/16/2017	1 Year
16.	Horn Antenna	Schwarzbeck	BBHA 9170	BBHA9170399	14GHz -26.5GHz	05/16/2017	1 Year
17.	Power Amplifier	LUNAR EM	LNA1G18-40	J10100000081	1GHz-26.5GHz	05/16/2017	1 Year
18.	Cable	H+S	CBL-26	N/A	1GHz-26.5GHz	05/16/2017	1 Year
19.	Cable	H+S	CBL-26	N/A	1GHz-26.5GHz	05/16/2017	1 Year
20.	Cable	H+S	CBL-26	N/A	1GHz-26.5GHz	05/16/2017	1 Year

6.4 Radiated emission limit

The emissions from an intentional radiator shall not exceed the field strength levels specified in the following table 15.209(a):

Frequencies (MHz)	Field Strength (micровolts/meter)	Measurement Distance (meters)
0.009~0.490	2400/F(KHz)	300
0.490~1.705	24000/F(KHz)	30
1.705~30.0	30	30
30~88	100	3
88~216	150	3
216~960	200	3
Above 960	500	3

15.205 Restricted bands of operation

MHz	MHz	MHz	GHz
0.090 - 0.110	16.42 - 16.423	399.9 - 410	4.5 - 5.15
¹ 0.495 - 0.505	16.69475 - 16.69525	608 - 614	5.35 - 5.46
2.1735 - 2.1905	16.80425 - 16.80475	960 - 1240	7.25 - 7.75
4.125 - 4.128	25.5 - 25.67	1300 - 1427	8.025 - 8.5
4.17725 - 4.17775	37.5 - 38.25	1435 - 1626.5	9.0 - 9.2
4.20725 - 4.20775	73 - 74.6	1645.5 - 1646.5	9.3 - 9.5
6.215 - 6.218	74.8 - 75.2	1660 - 1710	10.6 - 12.7
6.26775 - 6.26825	108 - 121.94	1718.8 - 1722.2	13.25 - 13.4
6.31175 - 6.31225	123 - 138	2200 - 2300	14.47 - 14.5
8.291 - 8.294	149.9 - 150.05	2310 - 2390	15.35 - 16.2
8.362 - 8.366	156.52475 - 156.52525	2483.5 - 2500	17.7 - 21.4
8.37625 - 8.38675	156.7 - 156.9	2690 - 2900	22.01 - 23.12
8.41425 - 8.41475	162.0125 - 167.17	3260 - 3267	23.6 - 24.0
12.29 - 12.293	167.72 - 173.2	3332 - 3339	31.2 - 31.8
12.51975 - 12.52025	240 - 285	3345.8 - 3358	36.43 - 36.5
12.57675 - 12.57725	322 - 335.4	3600 - 4400	(²)

- Remark 1. Emission level in dBuV/m=20 log (uV/m)
 : 2. Measurement was performed at an antenna to the closed point of EUT distance of meters.
 3. Only spurious frequency is permitted to locate within the Restricted Bands specified in provision of § 15.205, and the emissions located in restricted bands also comply with 15.209 limit.

6.5 Measurement Result

Below 30MHz:

Operation Mode:	TX	Test Date :	December 20, 2017
Frequency Range:	9KHz~30MHz	Temperature :	28°C
Test Result:	PASS	Humidity :	65 %
Measured Distance:	3m	Test By:	W

Freq. (MHz)	Ant.Pol. H/V	Emission Level (dBuV/m)	Limit 3m (dBuV/m)	Over (dB)
--	--	--	--	--

Note: The low frequency, which started from 9KHz-30MHz, was pre-scanned and the result which was 20dB lower than the limit line per 15.31(o) was not reported.

Below 1000MHz:

Pass.

The data of the mode (GFSK 2441MHz) are recorded in the following pages.

Above 1000MHz~10th Harmonics:

Operation Mode: TX Mode (CH00: 2402MHz) Test Date : December 20, 2017
 Frequency Range: 1-25GHz Temperature : 25 °C
 Test Result: PASS Humidity : 50 %
 Measured Distance: 3m Test By: W

Freq. (MHz)	Ant. Pol. H/V	Emission Level(dBuV/m)		Limit 3m(dBuV/m)		Margin(dB)	
		PK	AV	PK	AV	PK	AV
4804	V	64.29	44.79	74	54	-9.71	-9.21
7206	V	63.28	43.28	74	54	-10.72	-10.72
9608	V	62.14	42.18	74	54	-11.86	-11.82
12010	V	61.28	41.23	74	54	-12.72	-12.77
14412	V	60.48	40.35	74	54	-13.52	-13.65
16814	V	59.28	39.24	74	54	-14.72	-14.76
4804	H	65.47	45.28	74	54	-8.53	-8.72
7206	H	64.29	44.15	74	54	-9.71	-9.85
9608	H	63.28	43.29	74	54	-10.72	-10.71
12010	H	62.18	42.36	74	54	-11.82	-11.64
14412	H	61.41	41.24	74	54	-12.59	-12.76
16814	H	60.19	40.28	74	54	-13.81	-13.72

Other harmonics emissions are lower than 20dB below the allowable limit.

- Note:**
- (1) All Readings are Peak Value and AV.
 - (2) Emission Level= Reading Level+ Probe Factor +Cable Loss.
 - (3) The average measurement was not performed when the peak measured data under the limit of average detection.
 - (4) Measuring frequencies from 1GHz to 25GHz.

Operation Mode: TX Mode (CH19: 2440MHz) Test Date : December 20, 2017
 Frequency Range: 1-25GHz Temperature : 25 °C
 Test Result: PASS Humidity : 50 %
 Measured Distance: 3m Test By: W

Freq. (MHz)	Ant. Pol. H/V	Emission Level(dBuV/m)		Limit 3m(dBuV/m)		Margin(dB)	
		PK	AV	PK	AV	PK	AV
4880	V	63.42	43.18	74	54	-10.58	-10.82
7320	V	62.19	42.17	74	54	-11.81	-11.83
9760	V	61.28	41.29	74	54	-12.72	-12.71
12200	V	60.18	40.28	74	54	-13.82	-13.72
14640	V	59.24	39.62	74	54	-14.76	-14.38
17080	V	58.64	38.64	74	54	-15.36	-15.36
4880	H	64.24	44.15	74	54	-9.76	-9.85
7320	H	63.18	43.28	74	54	-10.82	-10.72
9760	H	62.14	42.14	74	54	-11.86	-11.86
12200	H	61.25	42.14	74	54	-12.75	-11.86
14640	H	60.59	41.74	74	54	-13.41	-12.26
17080	H	59.55	39.28	74	54	-14.45	-14.72

Other harmonics emissions are lower than 20dB below the allowable limit.

- Note:**
- (1) All Readings are Peak Value and AV.
 - (2) Emission Level= Reading Level+ Probe Factor +Cable Loss.
 - (3) The average measurement was not performed when the peak measured data under the limit of average detection.
 - (4) Measuring frequencies from 1GHz to 25GHz.

Operation Mode: TX Mode (CH39: 2480MHz) Test Date : December 20, 2017
 Frequency Range: 1-25GHz Temperature : 25 °C
 Test Result: PASS Humidity : 50 %
 Measured Distance: 3m Test By: W

Freq. (MHz)	Ant. Pol. H/V	Emission Level(dBuV/m)		Limit 3m(dBuV/m)		Margin(dB)	
		PK	AV	PK	AV	PK	AV
4960	V	64.19	44.42	74	54	-9.81	-9.58
7440	V	63.25	43.24	74	54	-10.75	-10.76
9920	V	62.48	42.95	74	54	-11.52	-11.05
12400	V	61.42	41.28	74	54	-12.58	-12.72
14880	V	60.28	40.24	74	54	-13.72	-13.76
17360	V	59.28	39.28	74	54	-14.72	-14.72
4960	H	64.74	44.14	74	54	-9.26	-9.86
7440	H	63.25	43.25	74	54	-10.75	-10.75
9920	H	62.18	42.94	74	54	-11.82	-11.06
12400	H	61.84	41.28	74	54	-12.16	-12.72
14880	H	60.49	40.23	74	54	-13.51	-13.77
17360	H	59.28	39.28	74	54	-14.72	-14.72

Other harmonics emissions are lower than 20dB below the allowable limit.

- Note:**
- (1) All Readings are Peak Value and AV.
 - (2) Emission Level= Reading Level+ Probe Factor +Cable Loss.
 - (3) The average measurement was not performed when the peak measured data under the limit of average detection.
 - (4) Measuring frequencies from 1GHz to 25GHz.

6.6 Radiated Measurement Photos:

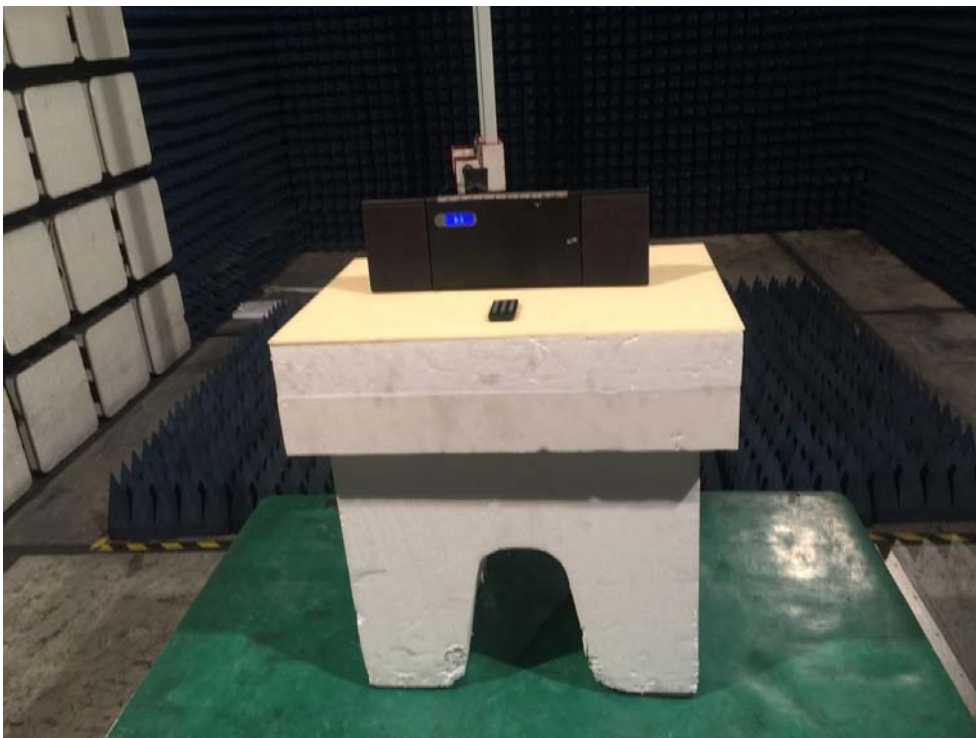
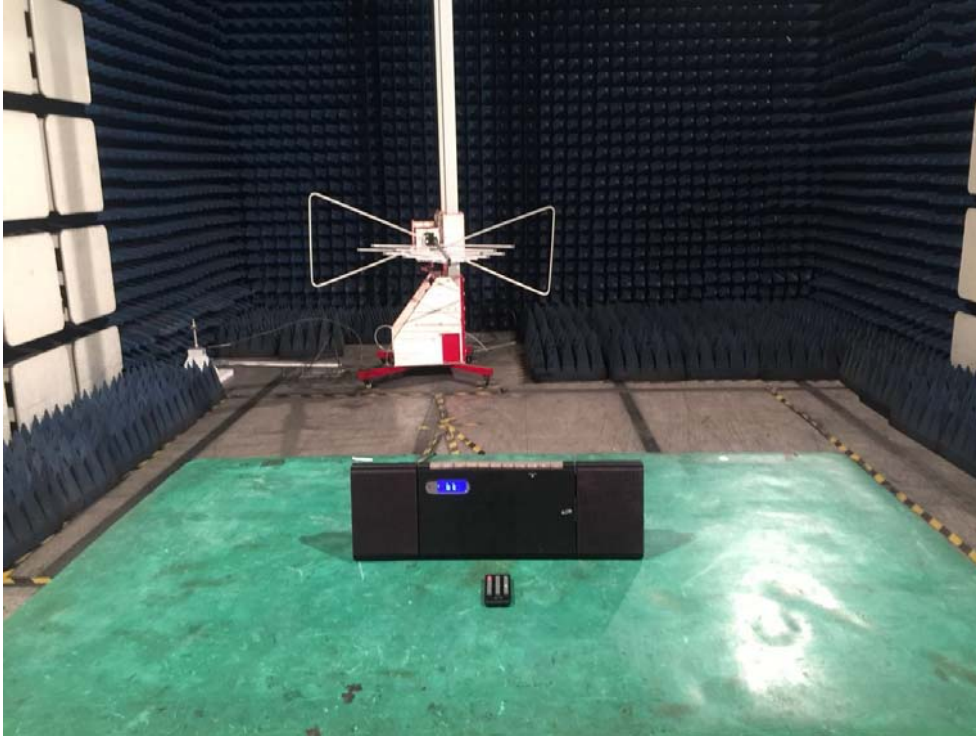

7. 6dB Bandwidth Measurement

7.1 Measurement Procedure

The EUT was operating in Bluetooth mode or could be controlled its channel. Printed out the test result from the spectrum by hard copy function.

7.2 Test SET-UP (Block Diagram of Configuration)

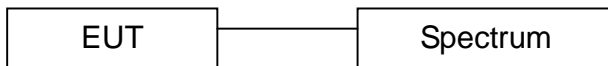

7.3 Measurement Equipment Used:

EQUIPMENT TYPE	MFR	MODEL NUMBER	SERIAL NUMBER	Characteristics	LAST CAL.	CAL DUE.
Spectrum Analyzer	Rohde & Schwarz	FSV30	1321.3008K	10Hz-30GHz	05/16/2017	05/15/2018
Coaxial Cable	CDS	79254	46107086	10Hz-30GHz	05/16/2017	05/15/2018
Antenna Connector	ARTHUR-YANG	2244-N1TG1	N/A	10Hz-30GHz	05/16/2017	05/15/2018

Remark: The temporary antenna connector is soldered on the PCB board in order to perform conducted tests and this temporary antenna connector is listed in the equipment list.

7.4 Limit

The minimum 6dB bandwidth shall be at least 500kHz.

7.5 Measurement Results:

Refer to attached data chart.

Spectrum Detector:	PK	Test Date :	December 20, 2017
Test By:	W	Temperature :	25 °C
Test Result:	PASS	Humidity :	50 %

Channel number	Channel frequency (MHz)	Measurement level (KHz)	Required Limit (KHz)
00	2402	689	>500
19	2440	695	>500
39	2480	689	>500

Channel 00:

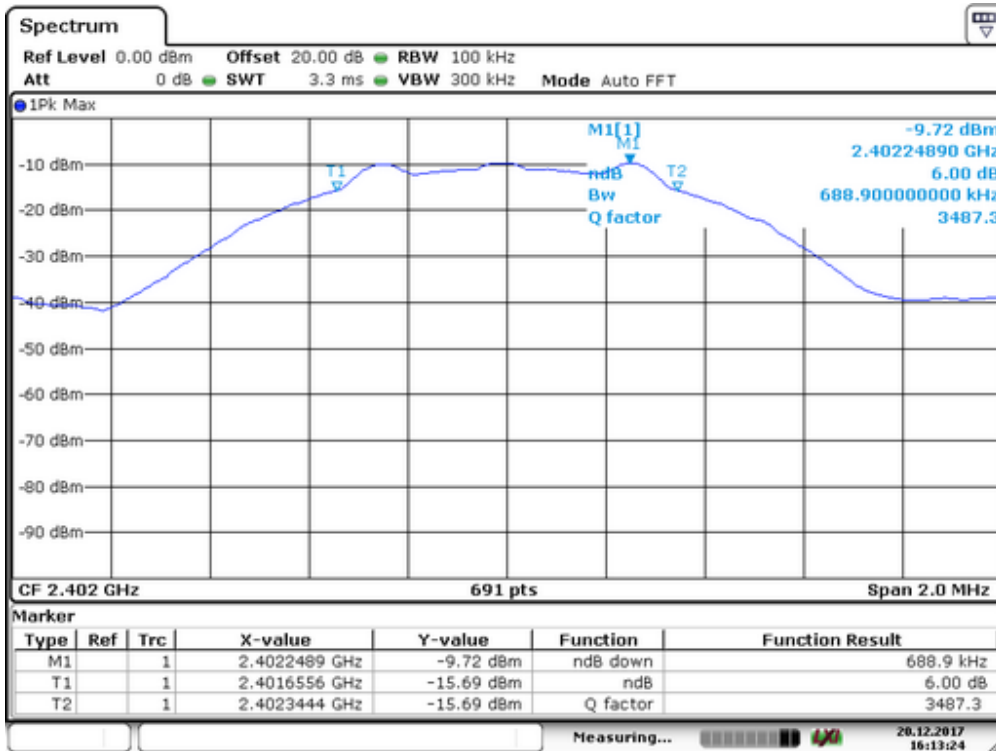

Channel 19:

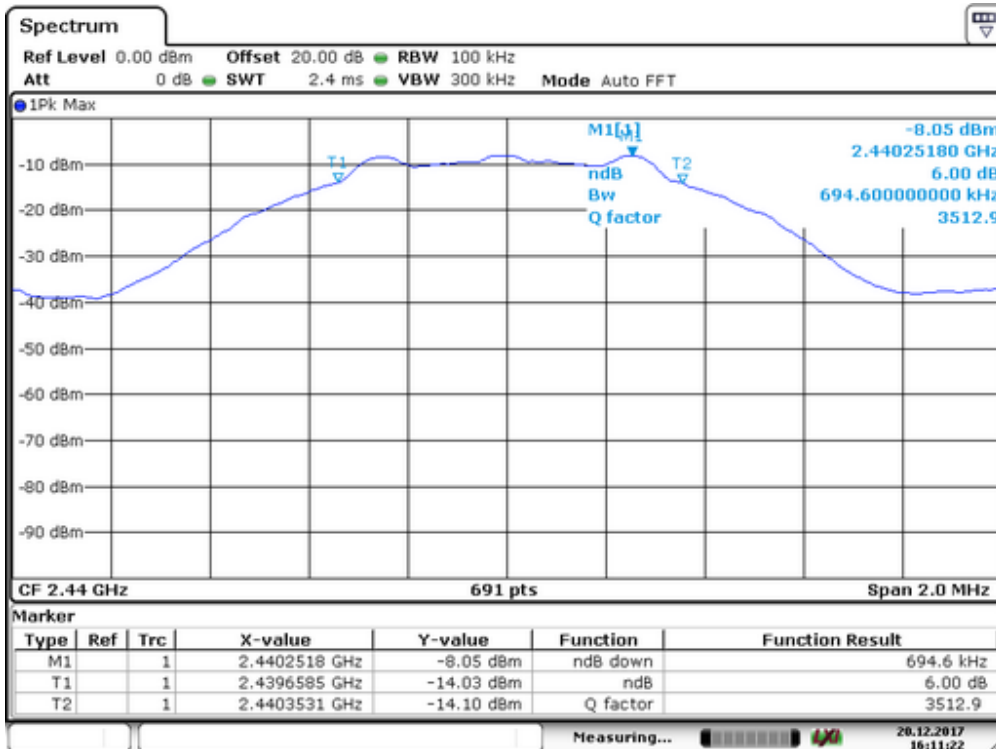

Channel 39:

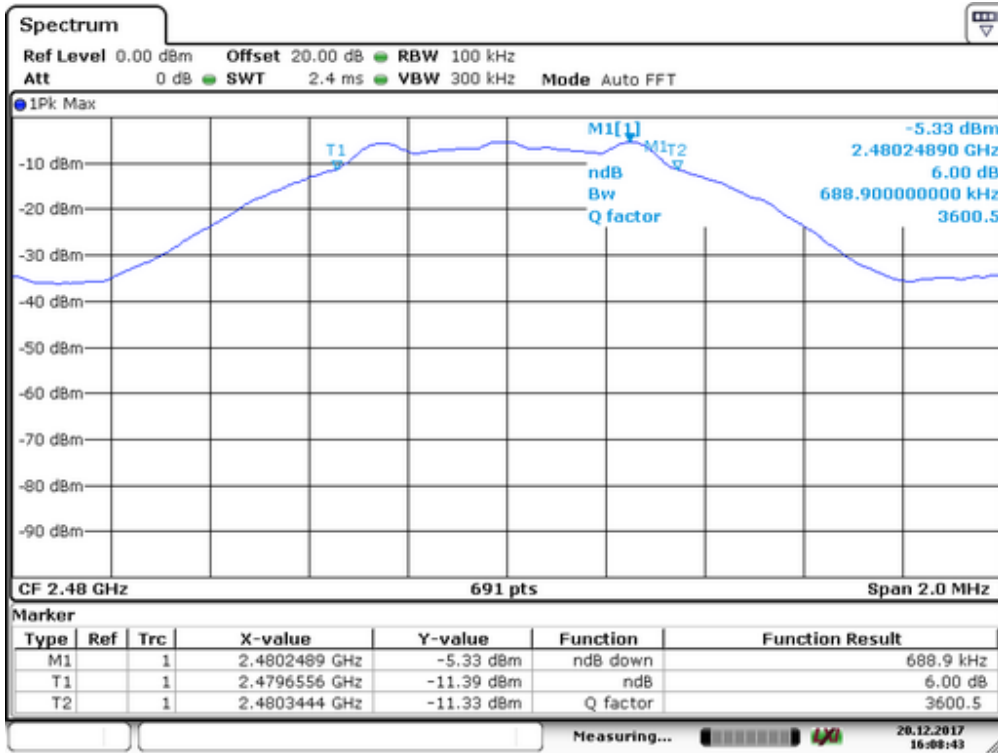

8. MAXIMUM PEAK OUTPUT POWER TEST

8.1 Measurement Procedure

- The Transmitter output (antenna port) was connected to the spectrum Analyzer.
- Turn on the EUT and then record the peak power value.
- Repeat above procedures on all channels needed to be tested.

8.2 Test SET-UP (Block Diagram of Configuration)

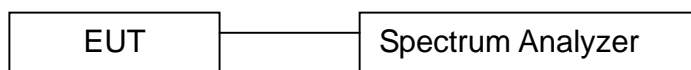

8.3 Measurement Equipment Used:

EQUIPMENT TYPE	MFR	MODEL NUMBER	SERIAL NUMBER	Characteristics	LAST CAL.	CAL DUE.
Spectrum Analyzer	Rohde & Schwarz	FSV30	1321.3008K	10Hz-30GHz	05/16/2017	05/15/2018
Coaxial Cable	CDS	79254	46107086	10Hz-30GHz	05/16/2017	05/15/2018
Antenna Connector	ARTHUR-YANG	2244-N1TG1	N/A	10Hz-30GHz	05/16/2017	05/15/2018

Remark: The temporary antenna connector is soldered on the PCB board in order to perform conducted tests and this temporary antenna connector is listed in the equipment list.

8.4 Peak Power output limit

The maximum peak power shall be less 1Watt.

8.5 Measurement Results:

Refer to attached data chart.

Spectrum Detector:	PK	Test Date :	December 20, 2017
Test By:	W	Temperature :	25 °C
Test Result:	PASS	Humidity :	50 %

Channel number	Channel Frequency (MHz)	Peak Power output(dBm)	Peak Power output(mW)	Peak Power Limit(W)	Pass/Fail
0	2402	-9.57	0.110	1W(30dBm)	PASS
19	2440	-7.92	0.161	1W(30dBm)	PASS
39	2480	-5.1	0.309	1W(30dBm)	PASS

Channel 00:

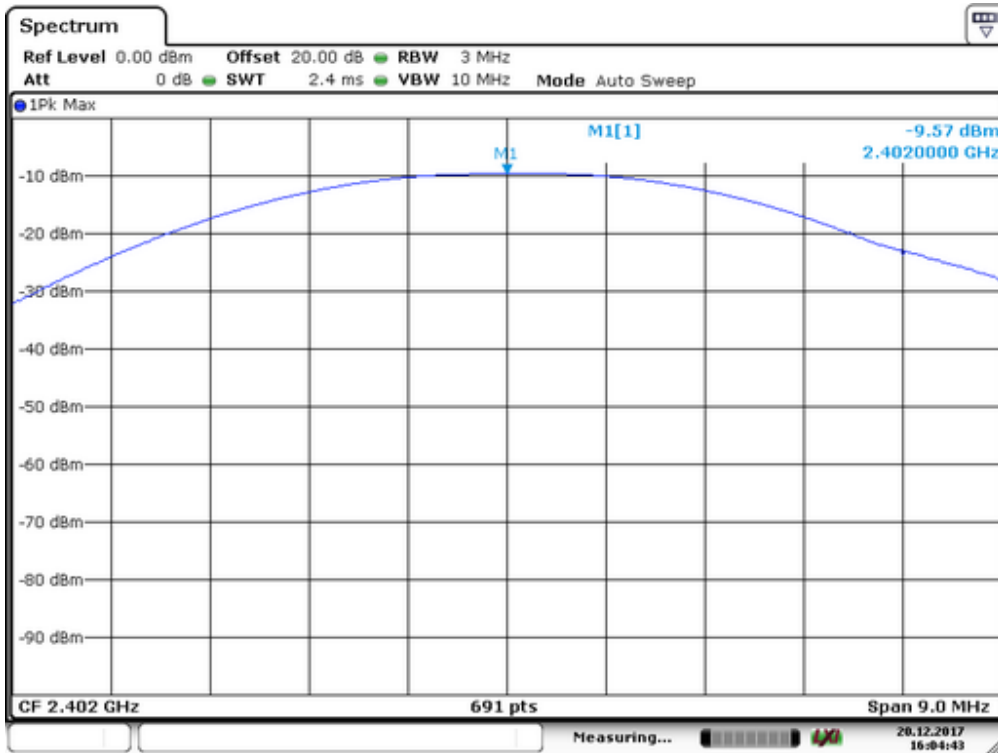

Channel 19:

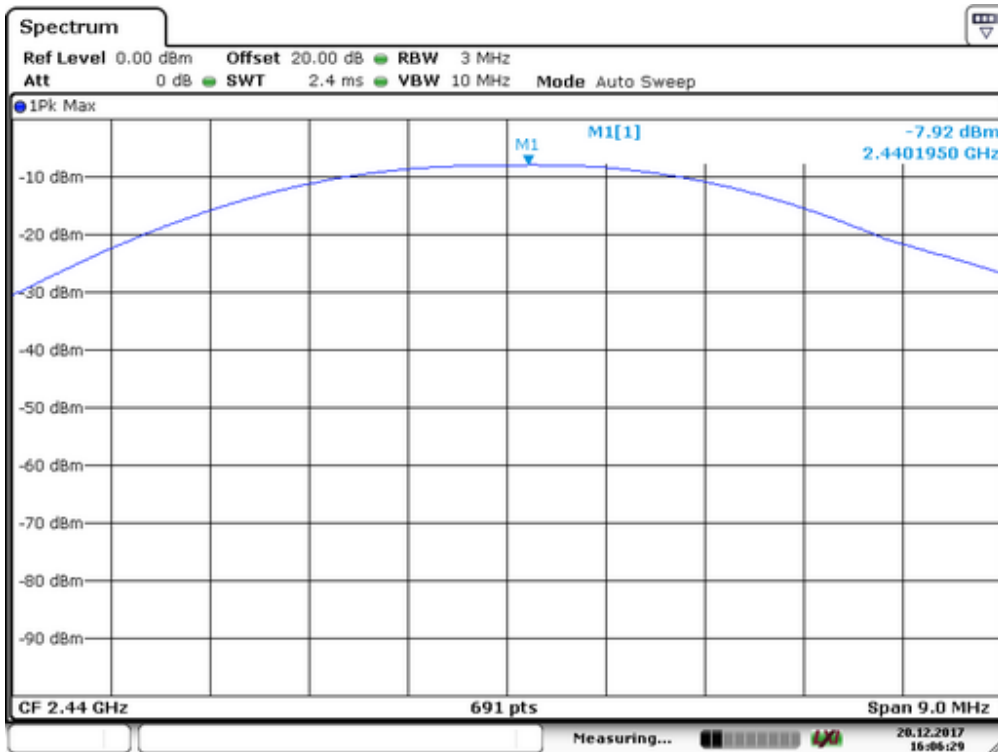

Channel 39:

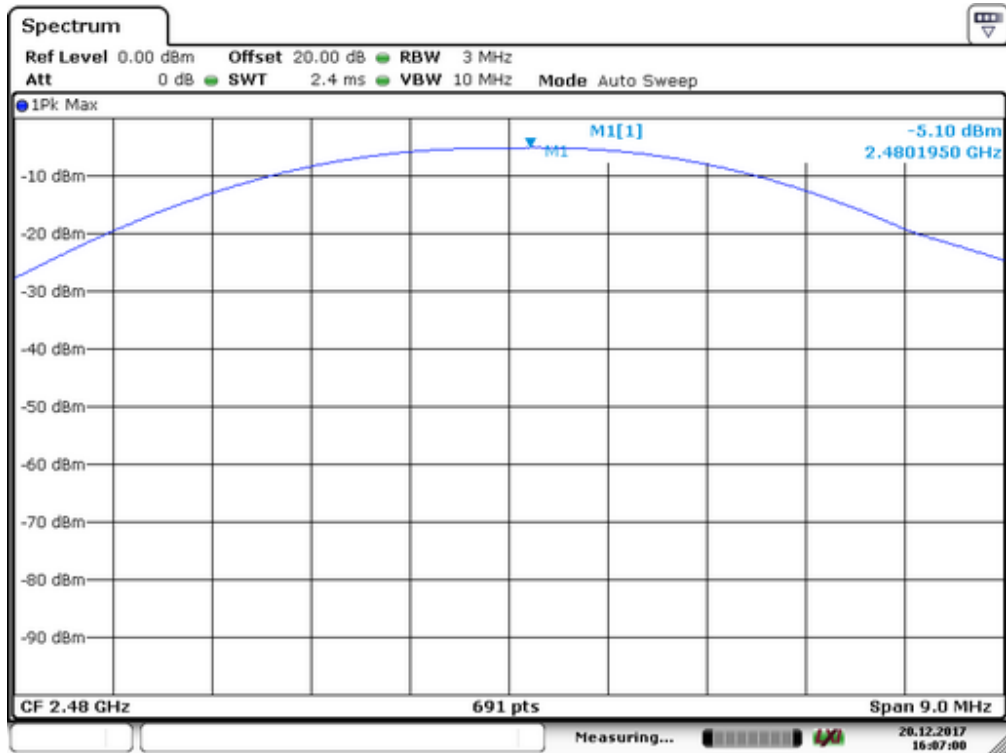

9. Power Spectral Density Measurement

9.1 Measurement Procedure

The EUT was operating in Bluetooth mode or could be controlled its channel. Printed out the test result from the spectrum by hard copy function.

9.2 Test SET-UP (Block Diagram of Configuration)

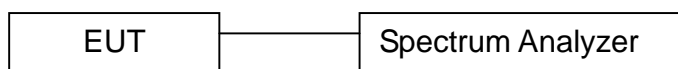

9.3 Measurement Equipment Used:

EQUIPMENT TYPE	MFR	MODEL NUMBER	SERIAL NUMBER	Characteristics	LAST CAL.	CAL DUE.
Spectrum Analyzer	Rohde & Schwarz	FSV30	1321.3008K	10Hz-30GHz	05/16/2017	05/15/2018
Coaxial Cable	CDS	79254	46107086	10Hz-30GHz	05/16/2017	05/15/2018
Antenna Connector	ARTHUR-YANG	2244-N1TG1	N/A	10Hz-30GHz	05/16/2017	05/15/2018

Remark: The temporary antenna connector is soldered on the PCB board in order to perform conducted tests and this temporary antenna connector is listed in the equipment list.

9.4 Measurement Procedure

9.4.1 The RF output of EUT was connected to the spectrum analyzer by RF cable and attenuator. The path loss was compensated to the results for each measurement.

9.4.2. Set to the maximum power setting and enable the EUT transmit continuously.

9.4.3. Make the measurement with the spectrum analyzer's resolution bandwidth (RBW) = 3 kHz. Video bandwidth VBW = 10 kHz In order to make an accurate measurement, set the span to 1.5 times DTS Channel Bandwidth. (6dB BW)

9.4.4. Detector = peak, Sweep time = auto couple, Trace mode = max hold, Allow trace to fully stabilize. Use the peak marker function to determine the maximum power level.

9.4.5. Measure and record the results in the test report.

9.4.6. The Measured power density (dBm)/ 100KHz is a reference level and used as 20dBc down limit line for Conducted Band Edges and Conducted Spurious Emission.

9.5 Measurement Results:

The following table is the setting of spectrum analyzer.

Spectrum analyzer	Setting
Attenuation	Auto
Span Frequency	Set the span to 1.5 times the DTS bandwidth.
RB	3KHz
VB	10KHz
Detector	Peak
Trace	Max hold
Sweep Time	Automatic

Refer to attached data chart.

Spectrum Detector:	PK	Test Date :	December 20, 2017
Test By:	W	Temperature :	25 °C
Test Result:	PASS	Humidity :	50 %

Channel number	Channel frequency (MHz)	Measurement level (dBm)		Required Limit (dBm/3kHz)	Pass/Fail
		PSD/100kHz	PSD/3kHz		
00	2402	-9.69	-23.19	8	PASS
19	2440	-8.02	-21.67	8	PASS
39	2480	-5.26	-19.07	8	PASS

Note:

1. Measured power density(dBm) has offset with cable loss.
2. The measured power density(dBm)/100KHz is reference level and used as 20dBc down for Conducted Band Edges and Conducted Spurious Emission limit line.

PSD 100kHz Plot:
Channel 00

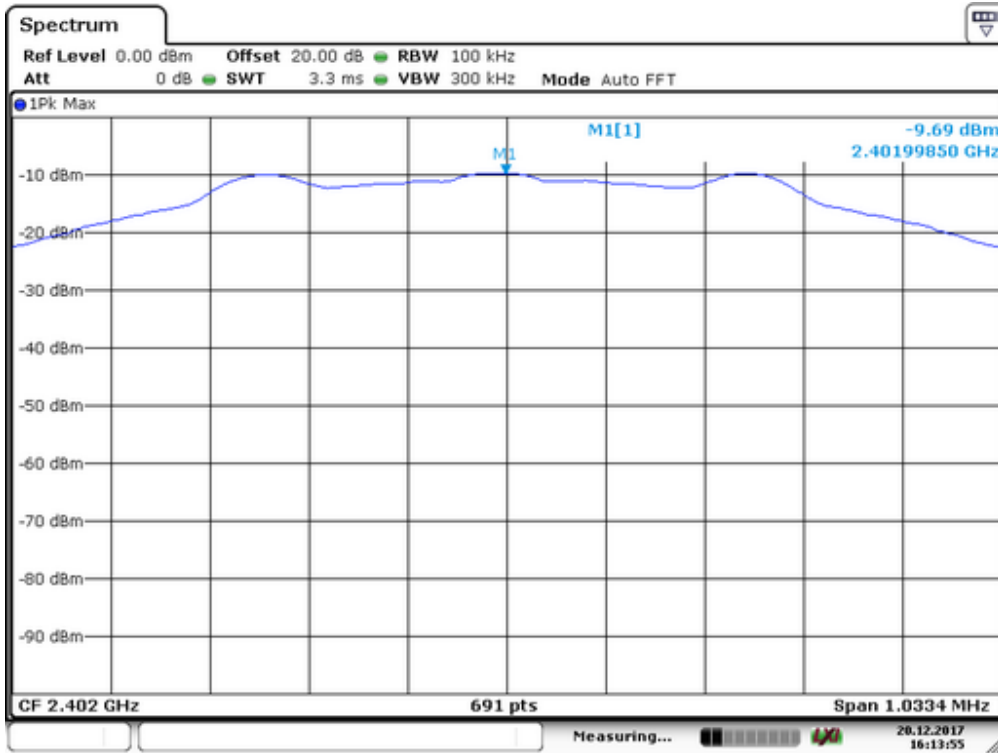

Channel 19

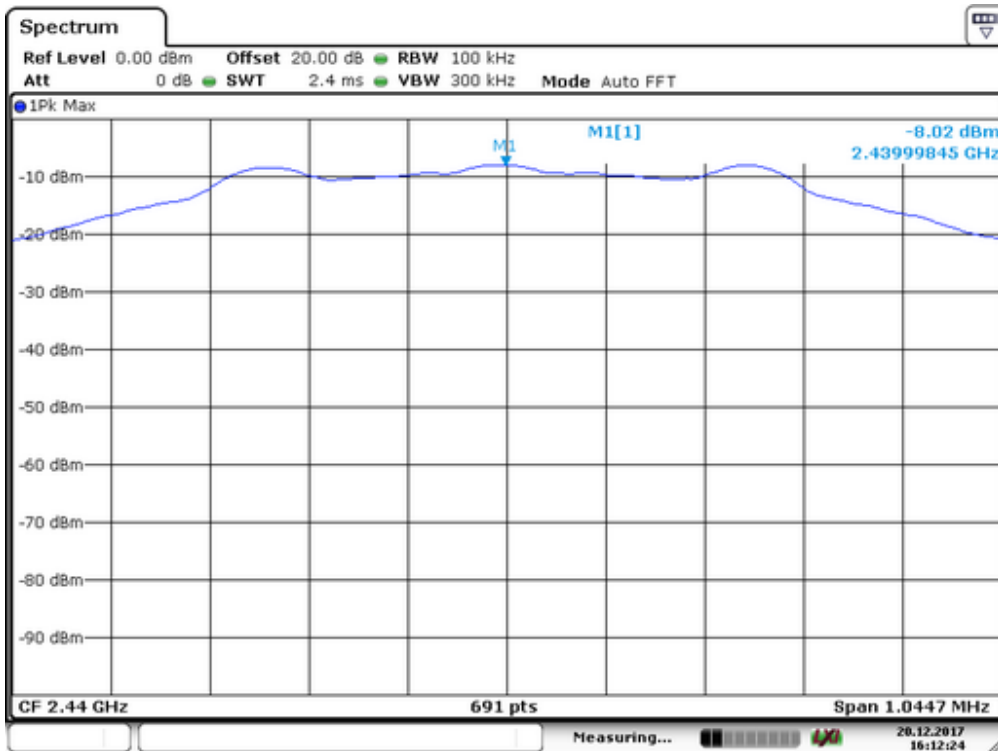

Channel 39

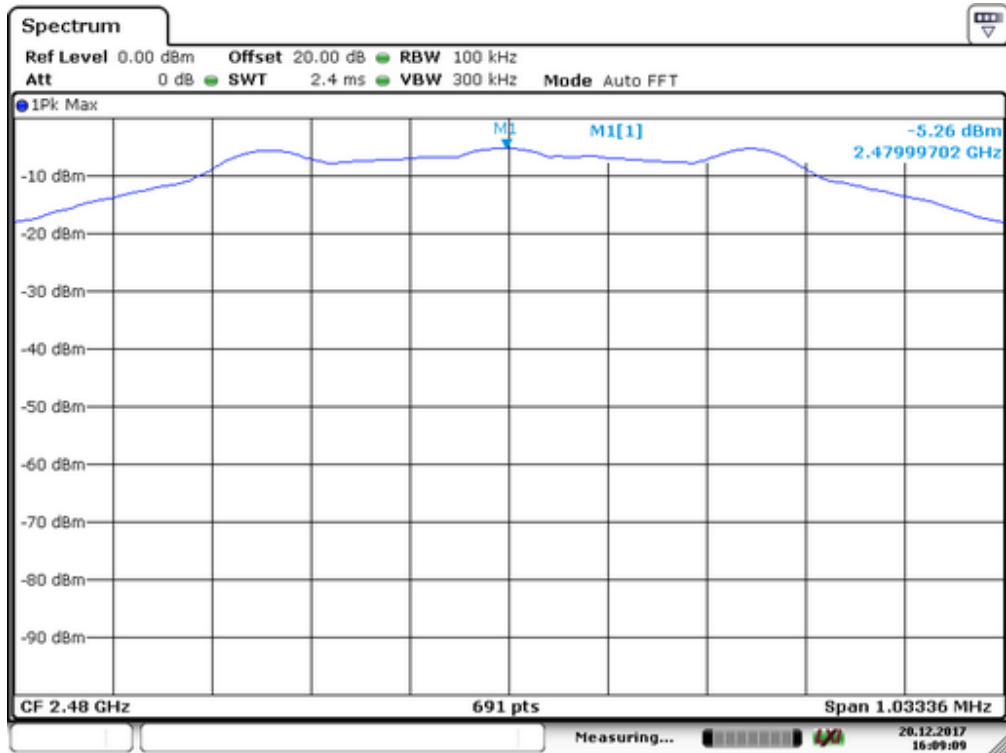

PSD 3KHz Plot:
Channel 00

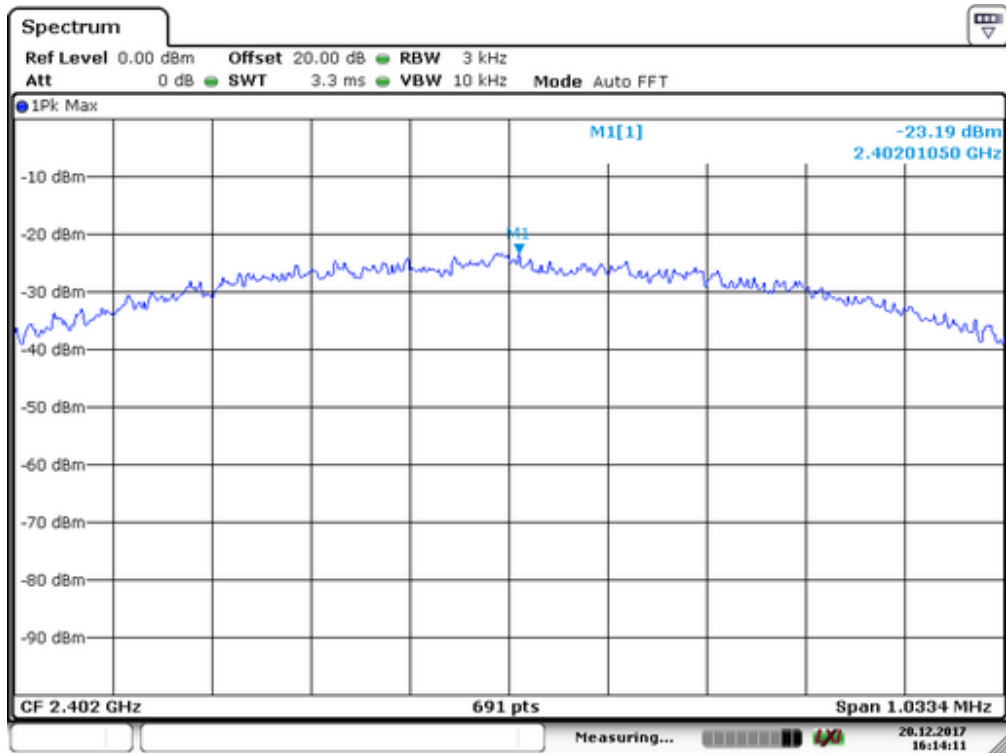

Channel 19

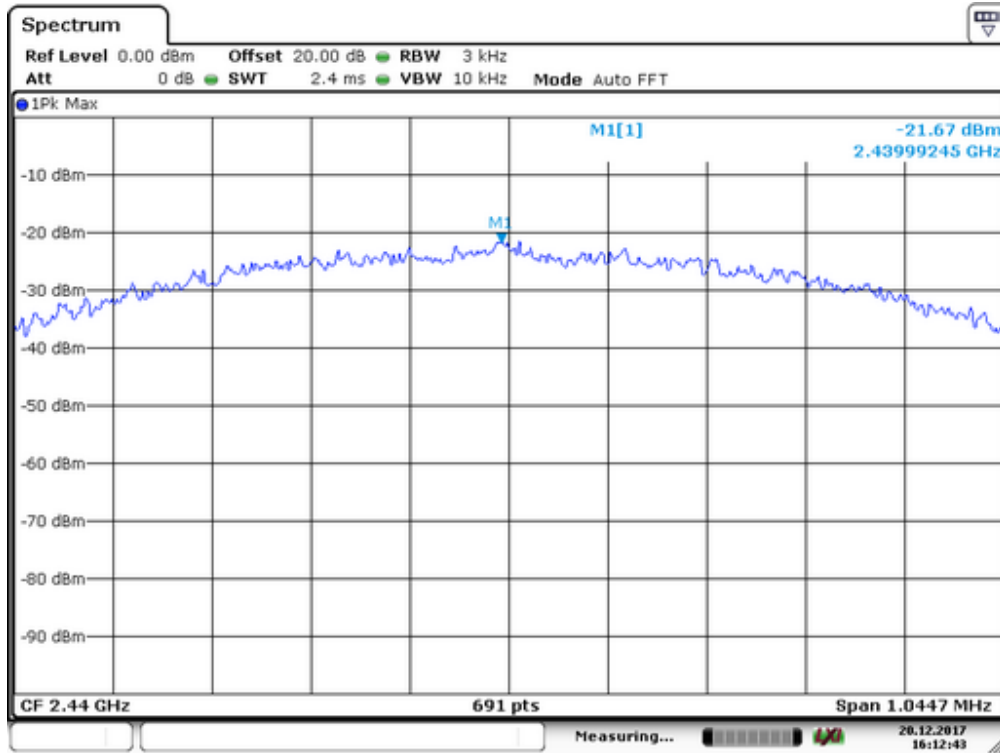

Channel 39

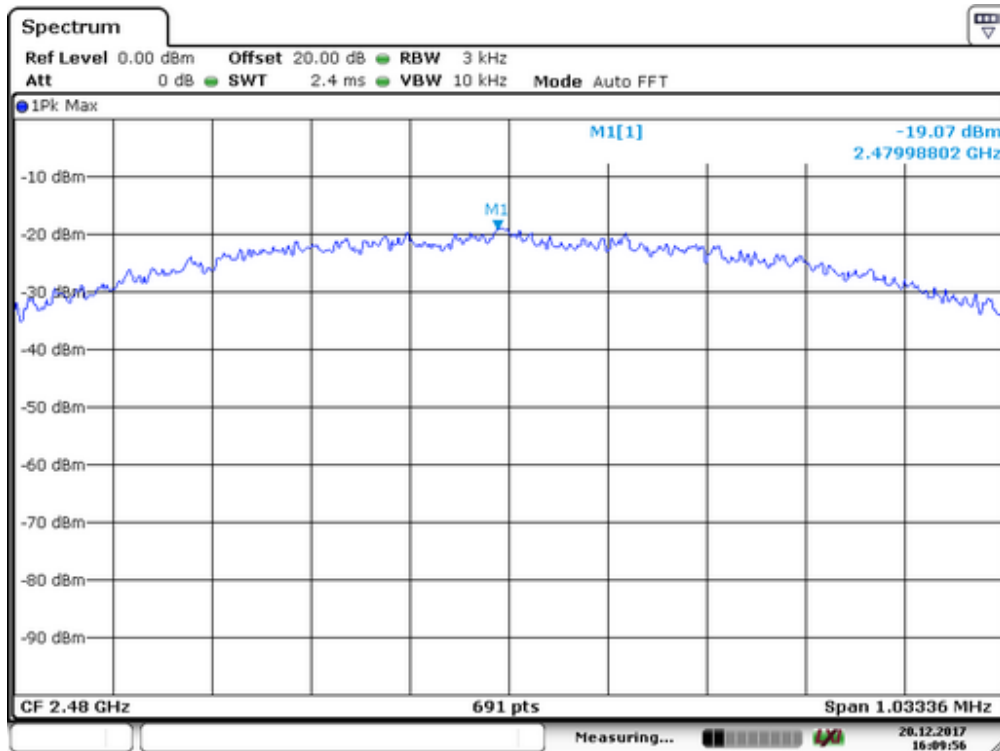

10. Band EDGE test

10.1 Measurement Procedure

For Conducted Test

1. The transmitter output is connected to a spectrum analyzer. The resolution bandwidth is set to 100KHz. The video bandwidth is set to 300KHz.
2. The spectrum from 30MHz to 26 GHz is investigated with the transmitter set to the lowest, middle, and highest channels.

EMI Test Receiver	Setting
Attenuation	Auto
RBW	100KHz
VBW	300KHz
Detector	Peak
Trace	Max hold

For Radiated emission Test

The EUT was placed on a styrofoam table which is 1.5m above ground plane.

The measurement procedure at the ban edges was simplified by performing the measurement in just one plot. Both, the in-band-emission and the unwanted emission were be encompassed by the span. After trace stabilization, the maximum peak was be determined by a peak detector and the value was marked by an appropriate limit line. The second limit line, which is 20dB below the first, marks the limit for the emissions in the unrestricted band. A maximum-peak-detector marks the highest emission in the unrestricted band next to the band edge.

The measurements were performed at the lower end of the 2.4GHz band.

Use the following spectrum analyzer settings:

For Restricted Band, When spectrum scanned above 1GHz setting resolution bandwidth 1MHz, video bandwidth 3MHz:

EMI Test Receiver	Setting
Attenuation	Auto
RBW	1MHz
VBW	3MHz
Detector	Peak
Trace	Max hold

For Non-Restricted Band, When spectrum scanned above 1GHz setting resolution bandwidth 100KHz, video bandwidth 300KHz:

EMI Test Receiver	Setting
Attenuation	Auto
RBW	100KHz
VBW	300KHz
Detector	Peak
Trace	Max hold

10.2 Test SET-UP (Block Diagram of Configuration)

For Conducted Test

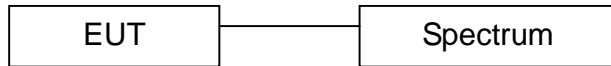

For Radiated emission Test

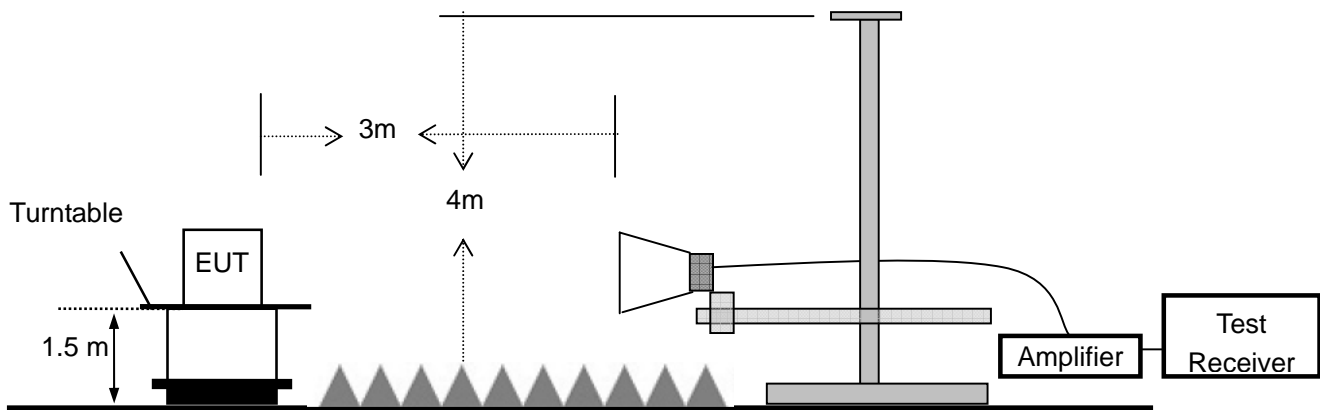

10.3 Measurement Equipment Used:

For Conducted Test

EQUIPMENT TYPE	MFR	MODEL NUMBER	SERIAL NUMBER	Characteristics	LAST CAL.	CAL DUE.
Spectrum Analyzer	Rohde & Schwarz	FSV30	1321.3008K	10Hz-30GHz	05/16/2017	05/15/2018
Coaxial Cable	CDS	79254	46107086	10Hz-30GHz	05/16/2017	05/15/2018
Antenna Connector	ARTHUR-YANG	2244-N1TG1	N/A	10Hz-30GHz	05/16/2017	05/15/2018

Remark: The temporary antenna connector is soldered on the PCB board in order to perform conducted tests and this temporary antenna connector is listed in the equipment list.

For Radiated emission Test

Item	Equipment	Manufacturer	Model No.	Serial No.	Characteristics	Last Cal.	Cal. Interval
1	Signal Analyzer	Rohde & Schwarz	FSV30	103040	9KHz-40GHz	05/16/2017	1 Year
2	Horn Antenna	Schwarzbeck	BBHA9120D	9120D-1272	1GHz-18GHz	05/16/2017	1 Year
3	Power Amplifier	LUNAR EM	LNA1G18-40	J10100000081	1GHz-26.5GHz	05/16/2017	1 Year
4	Cable	H+S	CBL-26	N/A	1GHz-26.5GHz	05/16/2017	1 Year
5	Cable	H+S	CBL-26	N/A	1GHz-26.5GHz	05/16/2017	1 Year
6	Cable	H+S	CBL-26	N/A	1GHz-26.5GHz	05/16/2017	1 Year

10.4 Measurement Results:

Refer to attached data chart.

Spectrum Detector: PK Test Date : December 20, 2017
 Test By: W Temperature : 25 °C
 Test Result: PASS Humidity : 50 %

1. Conducted Test

Frequency (MHz)	Peak Power Output(dBm)	Result of Band edge(dBc)	Band edge Limit(dBc)
2399.25	-9.77	38.03	>20dBc
2483.6	-5.27	48.66	>20dBc

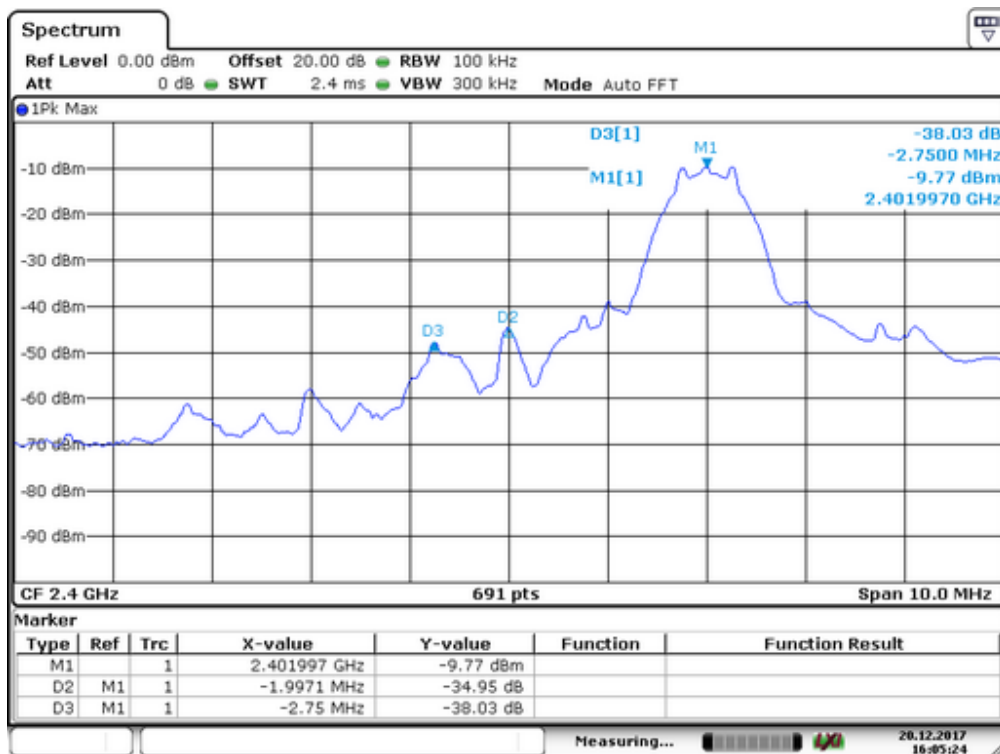

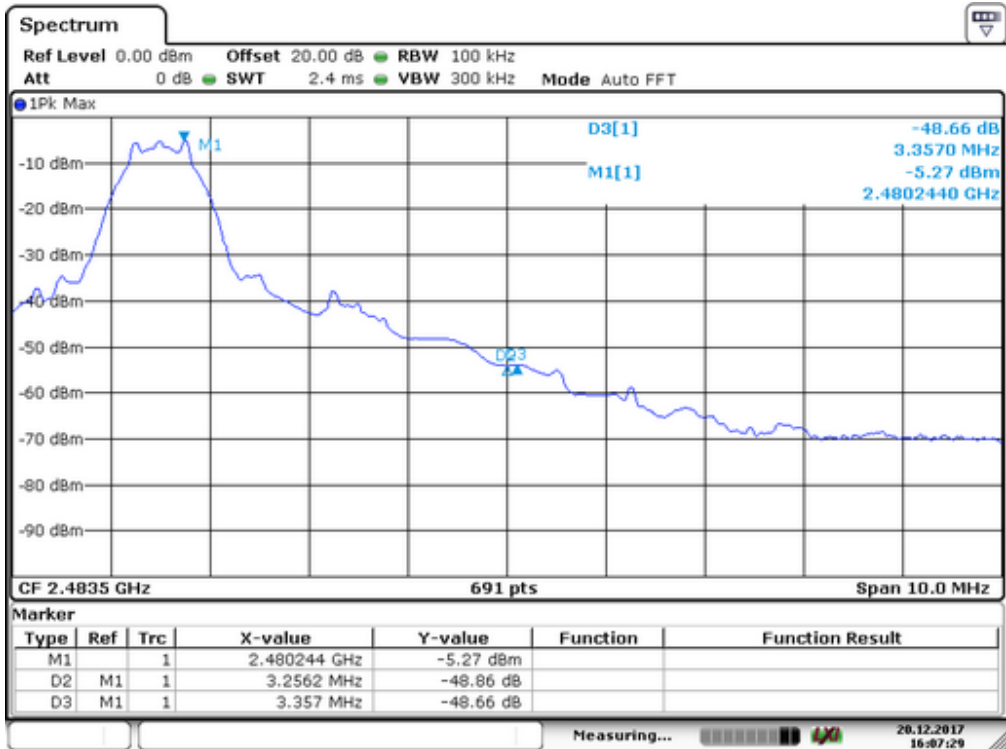

2. Radiated emission Test

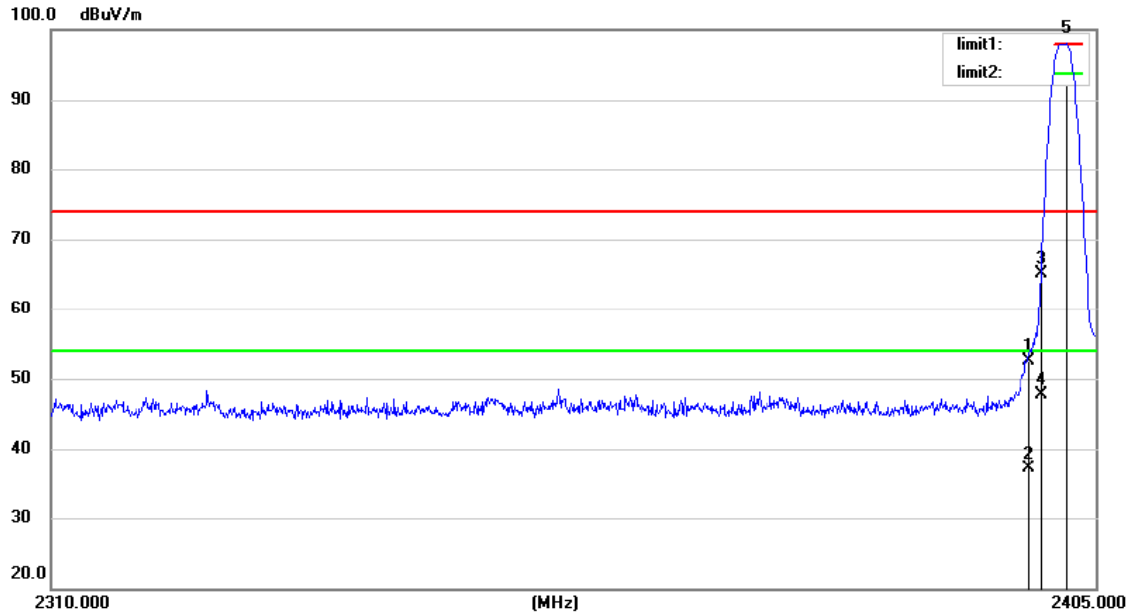

Site Chamber #1 Polarization: **Horizontal** Temperature: 26
 Limit: (RE)FCC PART 15 C 3m_PEAK Power: AC 120V/60Hz Humidity: 55 %
 Mode: DTS(TX2402)
 Note:

No.	Mk.	Freq.	Reading Level	Correct Factor	Measurement	Limit	Over	Antenna Height	Table Degree	Comment
		MHz	dBuV	dB	dBuV/m	dBuV/m	dB	cm	degree	
1		2398.730	58.31	-5.76	52.55	74.00	-21.45	peak	0	
2		2398.730	42.89	-5.76	37.13	54.00	-16.87	AVG	0	
3		2400.000	70.83	-5.75	65.08	74.00	-8.92	peak	0	
4		2400.000	53.47	-5.75	47.72	54.00	-6.28	AVG	0	
5	*	2402.340	103.75	-5.73	98.02	74.00	24.02	peak	0	

*:Maximum data x:Over limit !:over margin

Operator: Lin

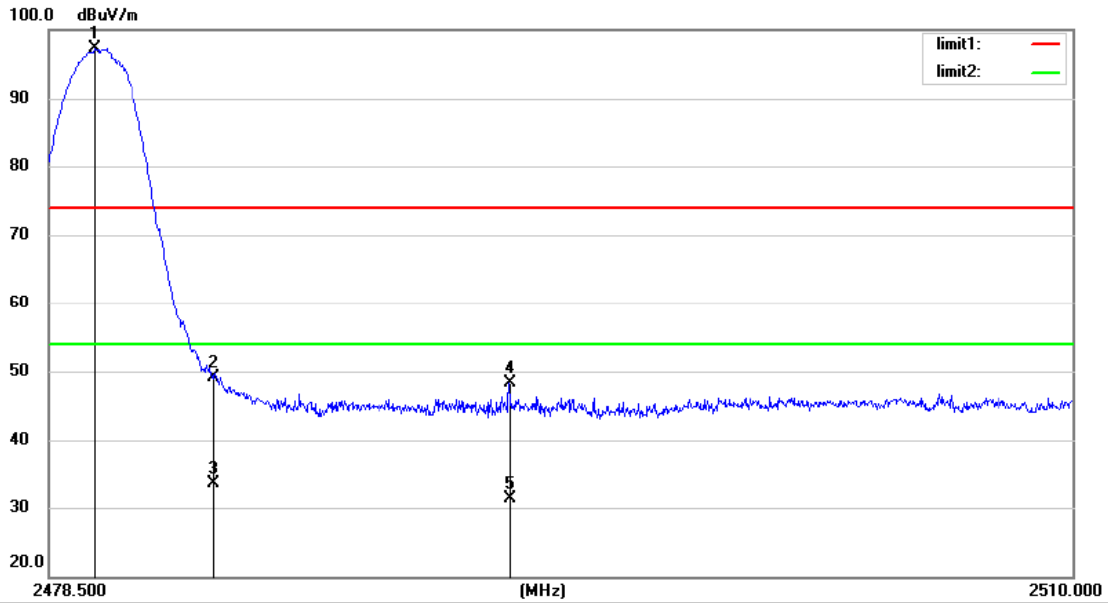

Site Chamber #1 Polarization: **Horizontal** Temperature: 26
 Limit: (RE)FCC PART 15 C 3m_PEAK Power: AC 120V/60Hz Humidity: 55 %
 Mode: DTS(TX2480)
 Note:

No.	Mk.	Freq.	Reading Level	Correct Factor	Measurement	Limit	Over	Antenna Height	Table Degree		
		MHz	dBuV	dB	dBuV/m	dBuV/m	dB	Detector	cm	degree	Comment
1	*	2479.886	102.44	-5.20	97.24	74.00	23.24	peak		0	
2		2483.500	54.28	-5.18	49.10	74.00	-24.90	peak		0	
3		2483.500	38.69	-5.18	33.51	54.00	-20.49	AVG		0	
4		2492.644	53.47	-5.12	48.35	74.00	-25.65	peak		0	
5		2492.644	36.41	-5.12	31.29	54.00	-22.71	AVG		0	

*:Maximum data x:Over limit !:over margin

Operator: Lin

11 Antenna Application

11.1 Antenna requirement

The EUT'S antenna is met the requirement of FCC part 15C section 15.203 and 15.247.

FCC part 15C section 15.247 requirements:

Systems operating in the 2402-2480MHz band that are used exclusively for fixed, point-to-point operations may employ transmitting antennas with directional gain greater than 6dBi provided the maximum peak output power of the intentional radiator is reduced by 1dB for every 3dB that the directional gain of the antenna exceeds 6dBi.

11.2 Result

The EUT's antenna, permanent attached antenna, used a PCB antenna and integrated on PCB, The antenna's gain is 4dBi and meets the requirement.

APPENDIX
(Photos of EUT)





