

APPLICATION CERTIFICATION
On Behalf of
Questyle Audio Technology Co.,Ltd

Super Hub

Model No.: SHB2

FCC ID: 2AEKH-S2

Prepared for : Questyle Audio Technology Co.,Ltd
Address : Room No. 13A, Floor 13, Yunsong Building, Tairan 8th
Road, Chegongmiao, Futian District, Shenzhen, China
518040

Prepared by : Shenzhen Accurate Technology Co., Ltd.
Address : 1/F., Building A, Changyuan New Material Port, Science
& Industry Park, Nanshan District, Shenzhen, Guangdong,
P.R. China

Tel: (0755) 26503290
Fax: (0755) 26503396

Report Number : ATE20181773
Date of Test : Oct. 08, 2018--Oct. 25, 2018
Date of Report : Oct. 26, 2018

TABLE OF CONTENTS

Description	Page
Test Report Certification	
1. GENERAL INFORMATION	5
1.1. Description of Device (EUT).....	5
1.2. Accessory and Auxiliary Equipment	5
1.3. Description of Test Facility	6
1.4. Measurement Uncertainty	6
2. MEASURING DEVICE AND TEST EQUIPMENT	7
3. OPERATION OF EUT DURING TESTING.....	8
3.1. Operating Mode	8
3.2. Configuration and peripherals	8
4. TEST PROCEDURES AND RESULTS	9
5. 6DB OCCUPIED BANDWIDTH TEST	10
5.1. Block Diagram of Test Setup.....	10
5.2. The Requirement For Section 15.247(a)(1).....	10
5.3. EUT Configuration on Measurement	10
5.4. Operating Condition of EUT	10
5.5. Test Procedure	10
5.6. Test Result	11
6. POWER SPECTRAL DENSITY TEST.....	15
6.1. Block Diagram of Test Setup.....	15
6.2. The Requirement For Section 15.247(e).....	15
6.3. EUT Configuration on Measurement	15
6.4. Operating Condition of EUT	15
6.5. Test Procedure	15
6.6. Test Result	16
7. 99% OCCUPIED BANDWIDTH TEST	20
7.1. Block Diagram of Test Setup.....	20
7.2. EUT Configuration on Measurement	20
7.3. Operating Condition of EUT	20
7.4. Test Procedure	20
7.5. Test Result	21
8. DUTY CYCLE MEASUREMENT.....	25
8.1. Block Diagram of Test Setup.....	25
8.2. EUT Configuration on Measurement	25
8.3. Operating Condition of EUT	25
8.4. Test Procedure	25
8.5. Test Result	26
9. MAXIMUM CONDUCTED (AVERAGE) OUTPUT POWER	28
9.1. Block Diagram of Test Setup.....	28
9.2. The Requirement For Section 15.247(b)(3).....	28
9.3. EUT Configuration on Measurement	28
9.4. Operating Condition of EUT	28
9.5. Test Procedure	29
9.6. Test Result	29
10. RADIATED EMISSION TEST	33

10.1.	Block Diagram of Test Setup.....	33
10.2.	The Limit For Section 15.247(d)	34
10.3.	Restricted bands of operation	35
10.4.	Configuration of EUT on Measurement	35
10.5.	Test Procedure	36
10.6.	Data Sample.....	36
10.7.	The Field Strength of Radiation Emission Measurement Results	37
11.	BAND EDGE COMPLIANCE TEST	59
11.1.	Block Diagram of Test Setup.....	59
11.2.	The Requirement For Section 15.247(d)	59
11.3.	EUT Configuration on Measurement	59
11.4.	Operating Condition of EUT	59
11.5.	Test Procedure	60
11.6.	Test Result	60
12.	AC POWER LINE CONDUCTED EMISSION FOR FCC PART 15 SECTION 15.207(A) ..	68
12.1.	Block Diagram of Test Setup.....	68
12.2.	The Emission Limit	68
12.3.	Configuration of EUT on Measurement	68
12.4.	Operating Condition of EUT	69
12.5.	Test Procedure	69
12.6.	DATA SAMPLE	69
12.7.	Power Line Conducted Emission Measurement Results	69
13.	ANTENNA REQUIREMENT.....	73
13.1.	The Requirement	73
13.2.	Antenna Construction	73

Test Report Certification

Applicant& address : Questyle Audio Technology Co.,Ltd
Room No. 13A, Floor 13, Yunsong Building, Tairan 8th Road,
Chegongmiao, Futian District, Shenzhen, China 518040

Manufacturer& address : Questyle Audio Technology Co.,Ltd
Room No. 13A, Floor 13, Yunsong Building, Tairan 8th Road,
Chegongmiao, Futian District, Shenzhen, China 518040

Product : Super Hub

Model No. : SHB2

Trade name : Questyle

Measurement Procedure Used:

FCC Rules and Regulations Part 15 Subpart C Section 15.247
ANSI C63.10-2013

The EUT was tested according to DTS test procedure of Aug. 24, 2018 KDB558074 D01 DTS Meas Guidance v05 for compliance to FCC 47CFR 15.247 requirements

The device described above is tested by SHENZHEN ACCURATE TECHNOLOGY CO., LTD to determine the maximum emission levels emanating from the device. The maximum emission levels are compared to the FCC Part 15 Subpart C Section 15.247. The measurement results are contained in this test report and SHENZHEN ACCURATE TECHNOLOGY CO., LTD is assumed full responsibility for the accuracy and completeness of these measurements. Also, this report shows that the Equipment Under Test (EUT) is to be technically compliant with the FCC requirements.

This report applies to above tested sample only. This report shall not be reproduced in part without written approval of SHENZHEN ACCURATE TECHNOLOGY CO., LTD.

Date of Test : Oct. 08, 2018--Oct. 25, 2018

Date of Report: Oct. 26, 2018

Prepared by :

(Tim Wang, Engineer)

Approved &
Authorized Signer :

(Sean Liu, Manager)

1. GENERAL INFORMATION

1.1. Description of Device (EUT)

EUT	:	Super Hub
Model Number	:	SHB2
Operation Frequency	:	5736MHz, 5762MHz, 5814MHz
Number of Channels	:	3
Modulation type	:	QPSK
Antenna Gain	:	3dBi
Antenna type	:	PCB Antenna
Power Supply	:	AC 120V/60Hz
Applicant	:	Questyle Audio Technology Co.,Ltd
Address	:	Room No. 13A, Floor 13, Yunsong Building, Tairan 8th Road, Chegongmiao, Futian District, Shenzhen, China 518040
Manufacturer	:	Questyle Audio Technology Co.,Ltd
Address	:	Room No. 13A, Floor 13, Yunsong Building, Tairan 8th Road, Chegongmiao, Futian District, Shenzhen, China 518040
Date of sample received	:	Oct 08, 2018
Date of Test	:	Oct. 08, 2018--Oct. 25, 2018

1.2. Accessory and Auxiliary Equipment

N/A

1.3. Description of Test Facility

EMC Lab : Recognition of accreditation by Federal Communications Commission (FCC)
The Designation Number is CN1189
The Registration Number is 708358

Listed by Innovation, Science and Economic Development Canada (ISED)
The Registration Number is 5077A-2

Accredited by China National Accreditation Service for Conformity Assessment (CNAS)
The Registration Number is CNAS L3193

Accredited by American Association for Laboratory Accreditation (A2LA)
The Certificate Number is 4297.01

Name of Firm : Shenzhen Accurate Technology Co., Ltd.

Site Location : 1/F., Building A, Changyuan New Material Port, Science & Industry Park, Nanshan District, Shenzhen, Guangdong, P.R. China

1.4. Measurement Uncertainty

Conducted Emission Expanded Uncertainty = 2.23dB, k=2

Radiated emission expanded uncertainty = 3.08dB, k=2
(9kHz-30MHz)

Radiated emission expanded uncertainty = 4.42dB, k=2
(30MHz-1000MHz)

Radiated emission expanded uncertainty = 4.06dB, k=2
(Above 1GHz)

2. MEASURING DEVICE AND TEST EQUIPMENT

Table 1: List of Test and Measurement Equipment

Kind of equipment	Manufacturer	Type	S/N	Calibrated dates	Calibrated until
EMI Test Receiver	Rohde&Schwarz	ESCS30	100307	Jan. 06, 2018	Jan. 05, 2019
EMI Test Receiver	Rohde&Schwarz	ESPI3	101526/003	Jan. 06, 2018	Jan. 05, 2019
Spectrum Analyzer	Rohde&Schwarz	FSV-40	101495	Jan. 06, 2018	Jan. 05, 2019
Spectrum Analyzer	Agilent	E7405A	MY45115511	Jan. 06, 2018	Jan. 05, 2019
Pre-Amplifier	Rohde&Schwarz	CBLU1183540-01	3791	Jan. 06, 2018	Jan. 05, 2019
Loop Antenna	Schwarzbeck	FMZB1516	1516131	Jan. 06, 2018	Jan. 05, 2019
Bilog Antenna	Schwarzbeck	VULB9163	9163-323	Jan. 06, 2018	Jan. 05, 2019
Horn Antenna	Schwarzbeck	BBHA9120D	9120D-655	Jan. 06, 2018	Jan. 05, 2019
Horn Antenna	Schwarzbeck	BBHA9170	9170-359	Jan. 06, 2018	Jan. 05, 2019
Open Switch and Control Unit	Rohde&Schwarz	OSP120 + OSP-B157	101244 + 100866	Jan. 06, 2018	Jan. 05, 2019
LISN	Rohde&Schwarz	ESH3-Z5	100305	Jan. 06, 2018	Jan. 05, 2019
LISN	Schwarzbeck	NSLK8126	8126431	Jan. 06, 2018	Jan. 05, 2019
Highpass Filter	Wainwright Instruments	WHKX3.6/18G-10SS	N/A	Jan. 06, 2018	Jan. 05, 2019
Band Reject Filter	Wainwright Instruments	WRCG2400/2485-2375/2510-60/11SS	N/A	Jan. 06, 2018	Jan. 05, 2019
Test Receiver	Rohde & Schwarz	ESCS30	100307	Jan. 06, 2018	Jan. 05, 2019
L.I.S.N.	Schwarzbeck	NLSK8126	8126431	Jan. 06, 2018	Jan. 05, 2019
Pulse Limiter	Rohde & Schwarz	ESH3-Z2	100815	Jan. 06, 2018	Jan. 05, 2019
50Ω Coaxial Switch	Anritsu Corp	MP59B	6200283933	Jan. 06, 2018	Jan. 05, 2019

3. OPERATION OF EUT DURING TESTING

3.1. Operating Mode

The mode is used: Transmitting mode

Low Channel: 5736MHz

Middle Channel: 5762MHz

High Channel: 5814MHz

3.2. Configuration and peripherals

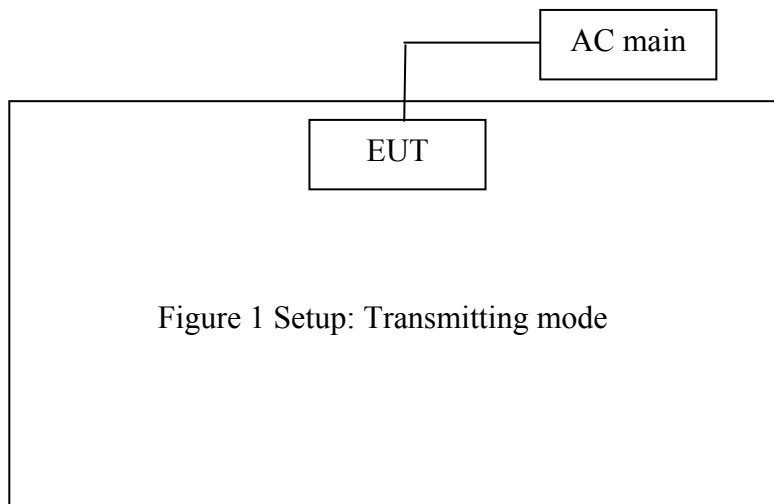

(EUT: Super Hub)

Note: The EUT have two antenna(A and B), They can not transmit simultaneously, The EUT select a antenna to transmit according to signal strength automatically, One Antenna of EUT does not work when Another antenna is transmitting

4. TEST PROCEDURES AND RESULTS

FCC Rules	Description of Test	Result
Section 15.207	AC power Line Conducted Emission Test	Compliant
Section 15.247(a)(2)	6dB Occupied Bandwidth Test	Compliant
KDB 558074	99% Occupied Bandwidth Test	Compliant
Section 15.247(b)(3)	Maximum conducted (average) output power	Compliant
Section 15.247(e)	Power Spectral Density Test	Compliant
Section 15.205 Section 15.209	Radiated Spurious Emissions Test	Compliant
Section 15.247(d)	Band Edge Compliance Test	Compliant
Section 15.203	Antenna Requirement	Compliant

5. 6DB OCCUPIED BANDWIDTH TEST

5.1. Block Diagram of Test Setup

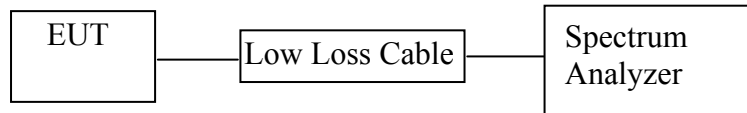

(EUT: Super Hub)

5.2. The Requirement For Section 15.247(a)(1)

Section 15.247(a)(2): Systems using digital modulation techniques may operate in the 902–928 MHz, 2400–2483.5 MHz, and 5725–5850 MHz bands. The minimum 6 dB band-width shall be at least 500 kHz

5.3. EUT Configuration on Measurement

The equipment are installed on the emission measurement to meet the commission requirements and operating regulations in a manner which tends to maximize its emission characteristics in normal application.

5.4. Operating Condition of EUT

5.4.1. Setup the EUT and simulator as shown as Section 5.1.

5.4.2. Turn on the power of all equipment.

5.4.3. Let the EUT work in TX modes measure it. The transmit frequency are 5736MHz, 5762MHz, 5814MHz, We select these frequency to transmit.

5.5. Test Procedure

5.5.1. The transmitter output was connected to the spectrum analyzer through a low loss cable.

5.5.2. Set RBW of spectrum analyzer to 100 kHz and VBW to 300 kHz.

5.5.3. The 6dB bandwidth is defined as the total spectrum the power of which is higher than peak power minus 6dB.

5.6. Test Result

Antenna A test data

Channel	Frequency (MHz)	6dB Bandwidth (MHz)	Limit (MHz)	Result
Low	5736	12.330	≥ 0.5	Pass
Middle	5762	12.321	≥ 0.5	Pass
High	5814	12.330	≥ 0.5	Pass

Antenna B test data

Channel	Frequency (MHz)	6dB Bandwidth (MHz)	Limit (MHz)	Result
Low	5736	12.272	≥ 0.5	Pass
Middle	5762	12.322	≥ 0.5	Pass
High	5814	12.330	≥ 0.5	Pass

The spectrum analyzer plots are attached as below.

Low channel(Antenna A)

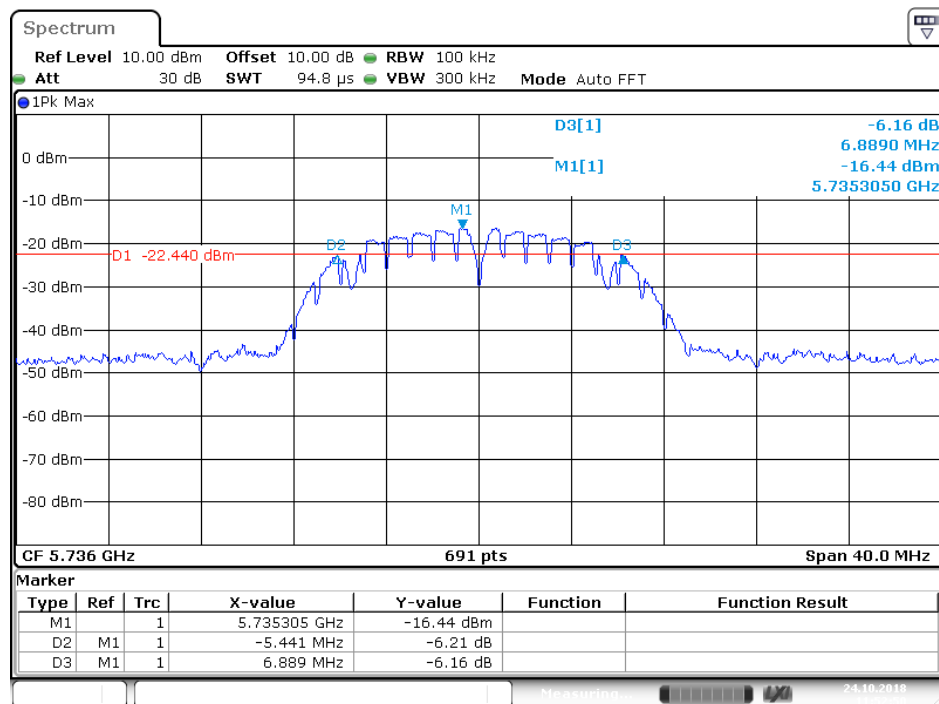

Date: 24.OCT.2018 11:52:50

Middle channel(Antenna A)

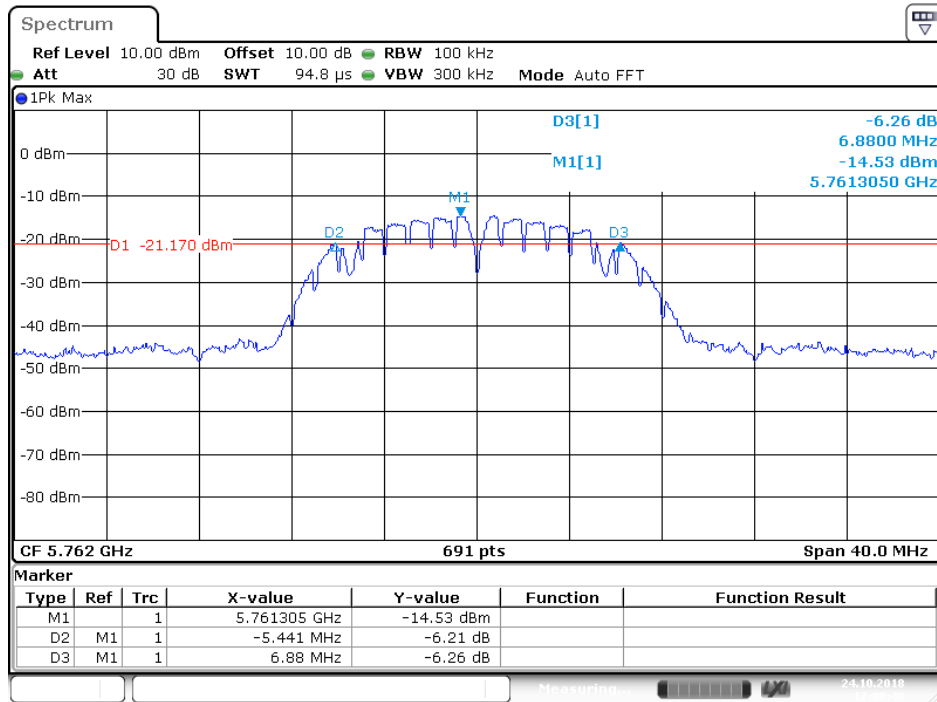

Date: 24.OCT.2018 12:00:48

High channel(Antenna A)

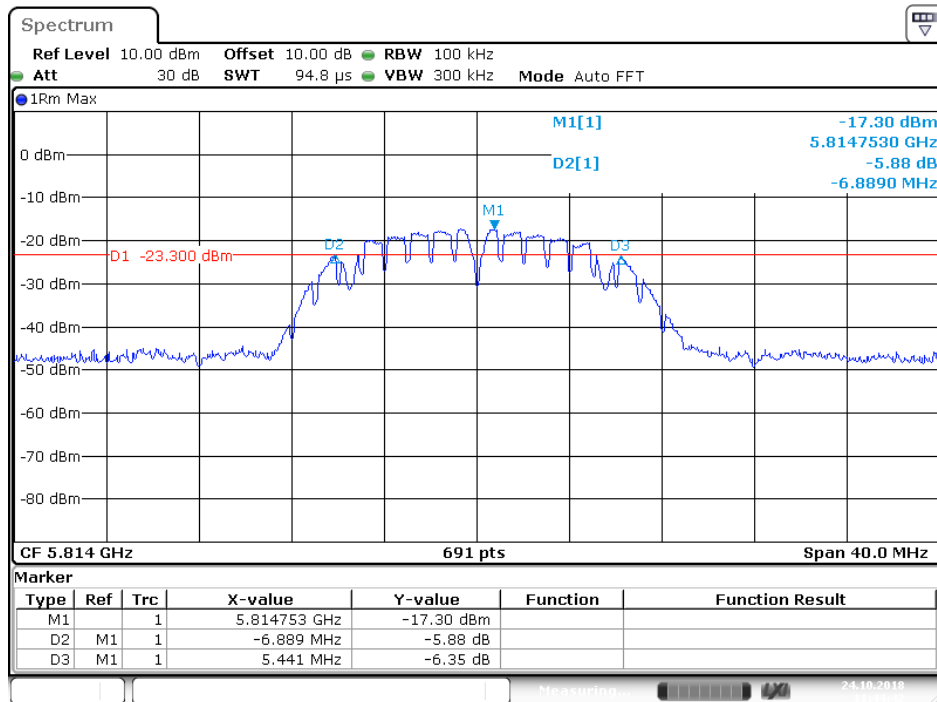

Date: 24.OCT.2018 11:44:42

Low channel(Antenna B)

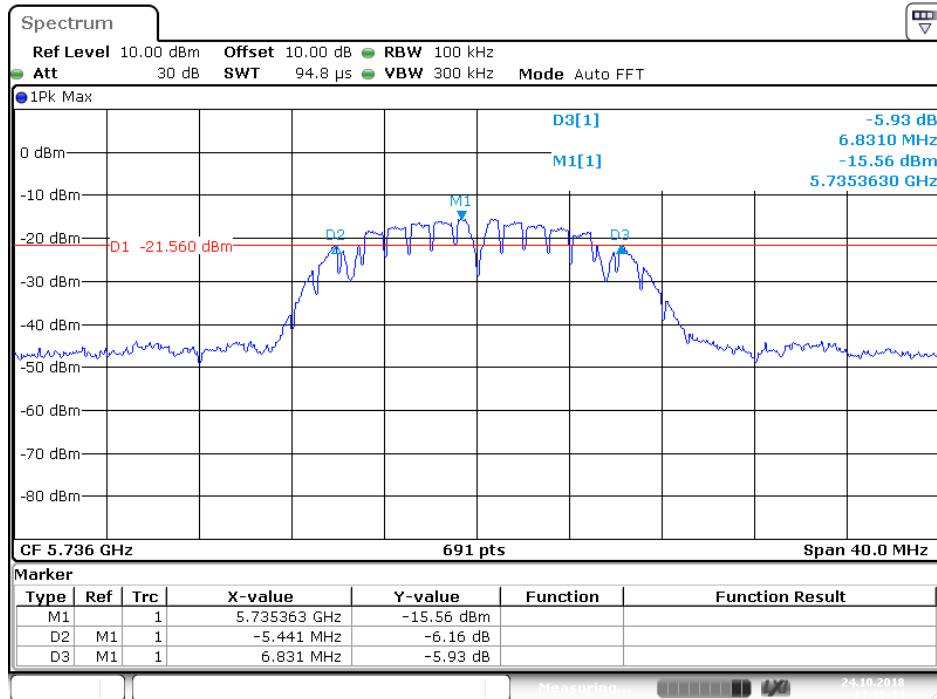

Date: 24.OCT.2018 13:38:44

Middle channel(Antenna B)

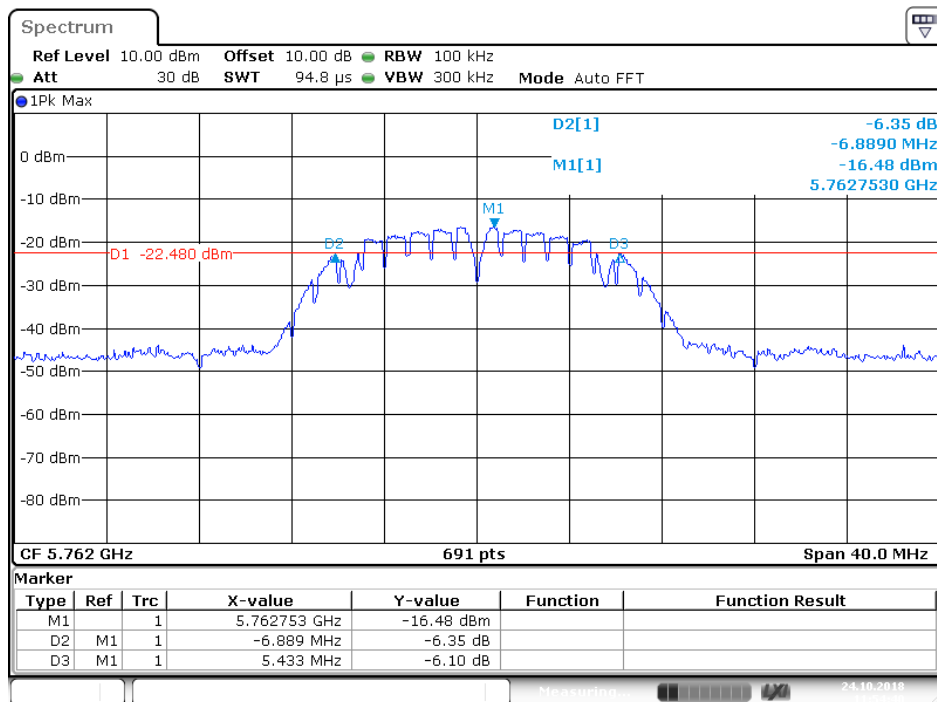

Date: 24.OCT.2018 11:54:40

High channel(Antenna B)

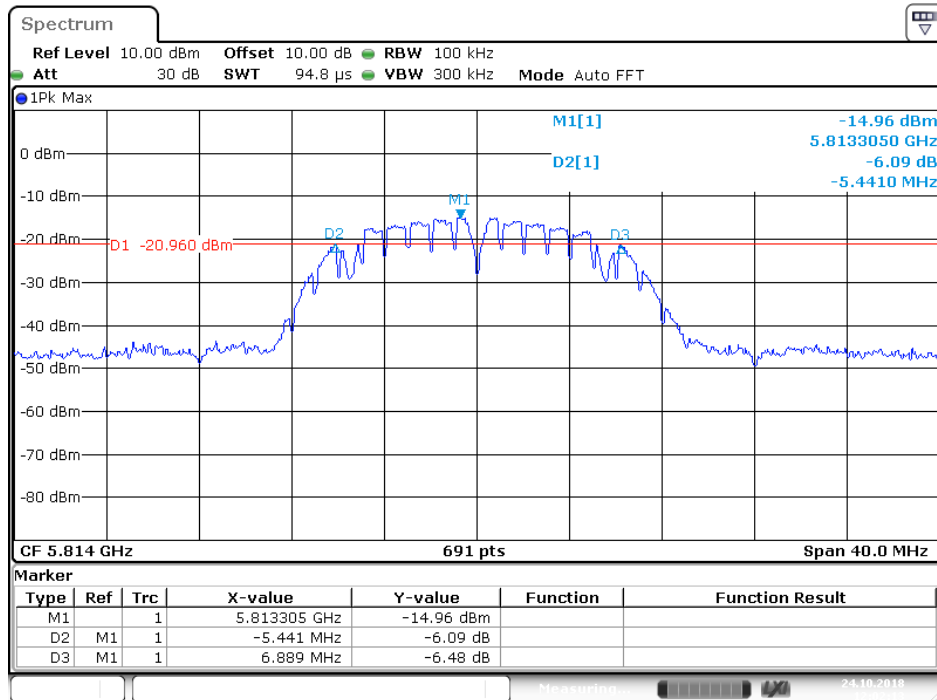

Date: 24.OCT.2018 12:02:13

6. POWER SPECTRAL DENSITY TEST

6.1. Block Diagram of Test Setup

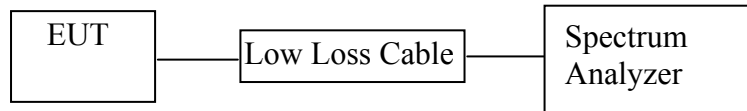

(EUT: Super Hub)

6.2. The Requirement For Section 15.247(e)

Section 15.247(e): For digitally modulated systems, the power spectral density conducted from the intentional radiator to the antenna shall not be greater than 8dBm in any 3 kHz band during any time interval of continuous transmission. This power spectral density shall be determined in accordance with the provisions of paragraph (b) of this section. The same method of determining the conducted output power shall be used to determine the power spectral density.

6.3. EUT Configuration on Measurement

The equipment are installed on the emission measurement to meet the commission requirements and operating regulations in a manner which tends to maximize its emission characteristics in normal application.

6.4. Operating Condition of EUT

6.4.1. Setup the EUT and simulator as shown as Section 6.1.

6.4.2. Turn on the power of all equipment.

6.4.3. Let the EUT work in TX modes and measure it. The transmit frequency are 5736MHz, 5762MHz, 5814MHz. We select these frequency to transmit.

6.5. Test Procedure

Refer to Subclause 11.10 of ANSI C63.10

6.5.1. Set analyzer center frequency to DTS channel center frequency.

6.5.2. Set the span to 1.5 times the DTS bandwidth.

6.5.3. Set the RBW to: $3 \text{ kHz} \leq \text{RBW} \leq 100 \text{ kHz}$. Set the VBW $\geq 3 \times \text{RBW}$.

6.5.4. Detector = peak.

6.5.5.Sweep time = auto couple.

6.5.6.Trace mode = max hold. Allow trace to fully stabilize.

6.5.7.Use the peak marker function to determine the maximum amplitude level within the RBW.

6.6. Test Result

Antenna A test result

Channel	Frequency (MHz)	Power Spectral Density (dBm)	Limit (dBm)	Result
Low	5736MHz	-15.96	≤8.00	PASS
Middle	5762MHz	-16.40	≤8.00	PASS
High	5814MHz	-18.67	≤8.00	PASS

Antenna B test result

Channel	Frequency (MHz)	Power Spectral Density (dBm)	Limit (dBm)	Result
Low	5736MHz	-16.19	≤8.00	PASS
Middle	5762MHz	-15.57	≤8.00	PASS
High	5814MHz	-13.80	≤8.00	PASS

The spectrum analyzer plots are attached as below.

Low channel(Antenna A)

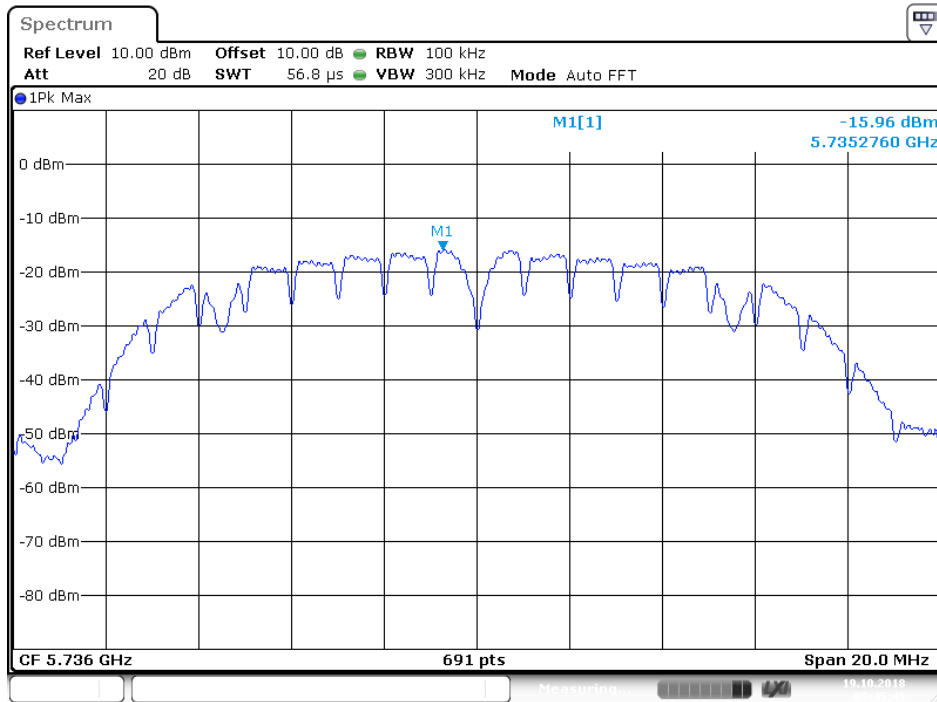

Date: 19.OCT.2018 09:45:49

Middle channel(Antenna A)

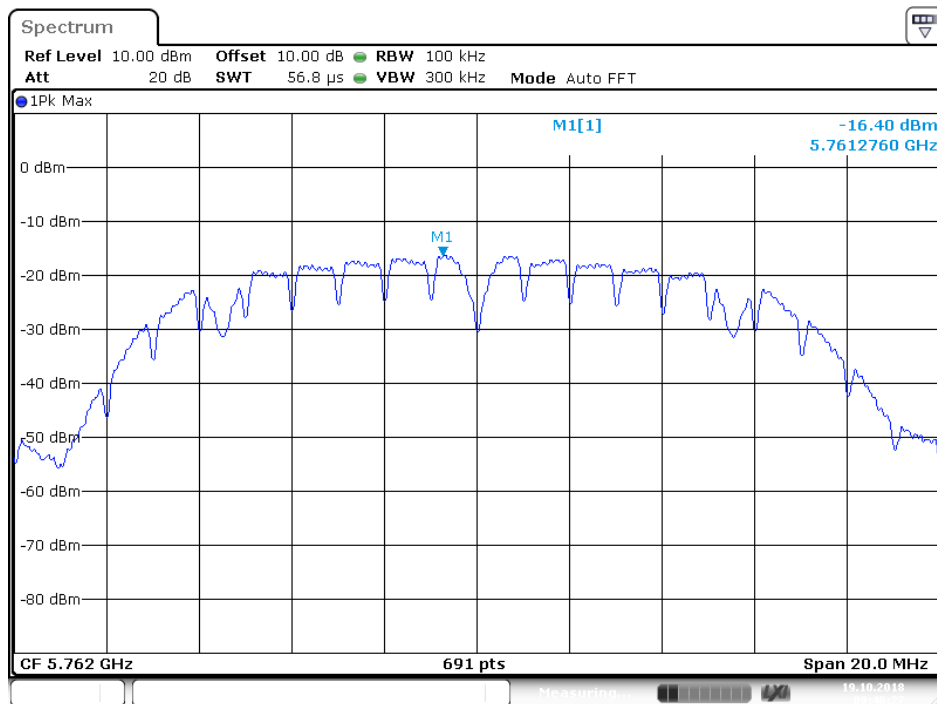

Date: 19.OCT.2018 09:46:27

High channel(Antenna A)

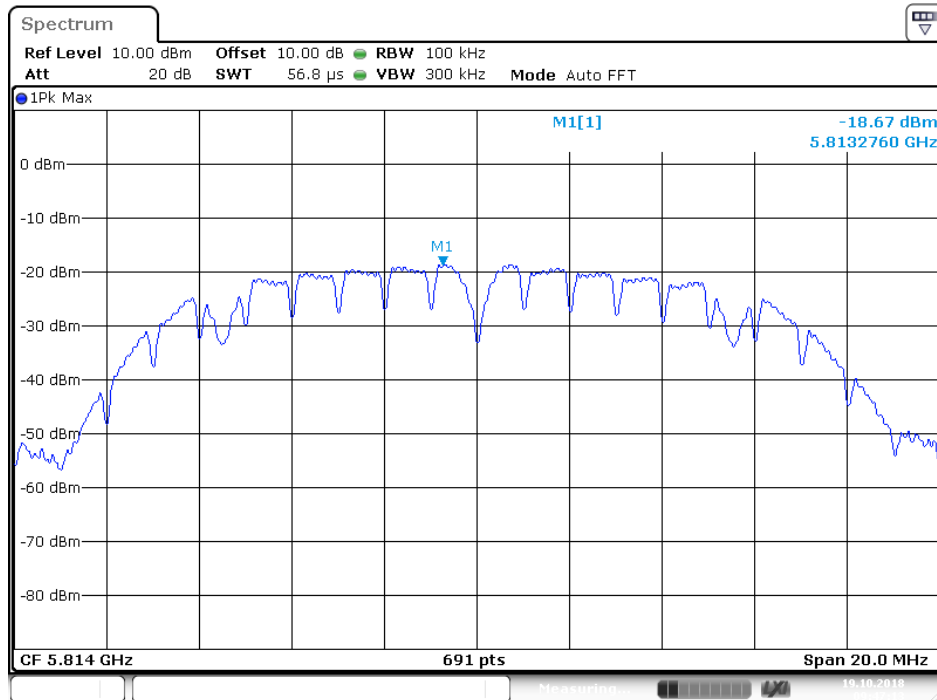

Date: 19.OCT.2018 09:47:14

Low channel(Antenna B)

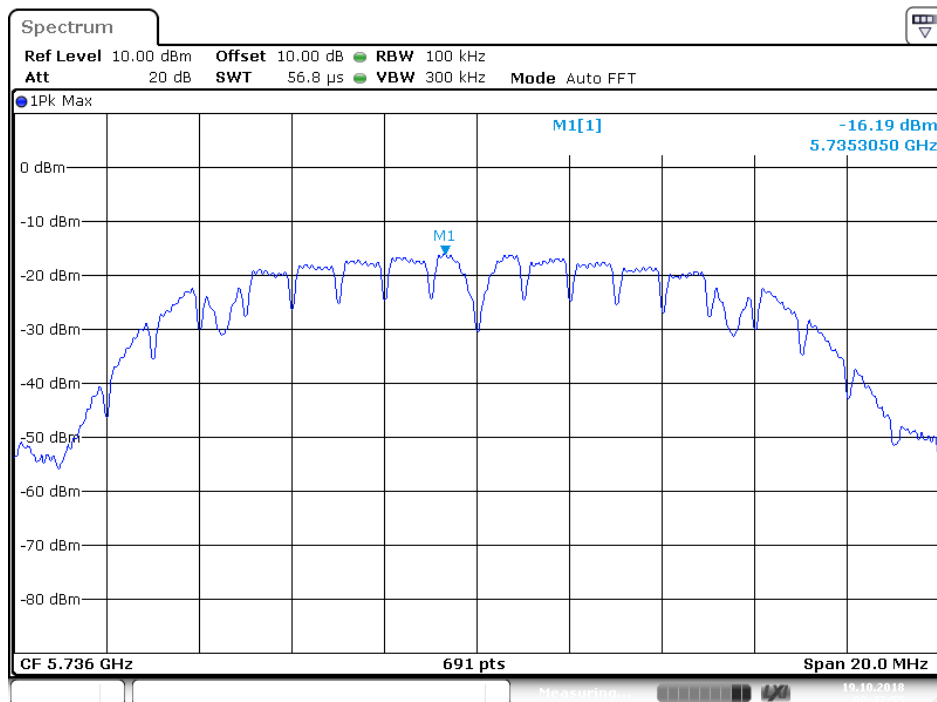

Date: 19.OCT.2018 09:47:55

Middle channel(Antenna B)

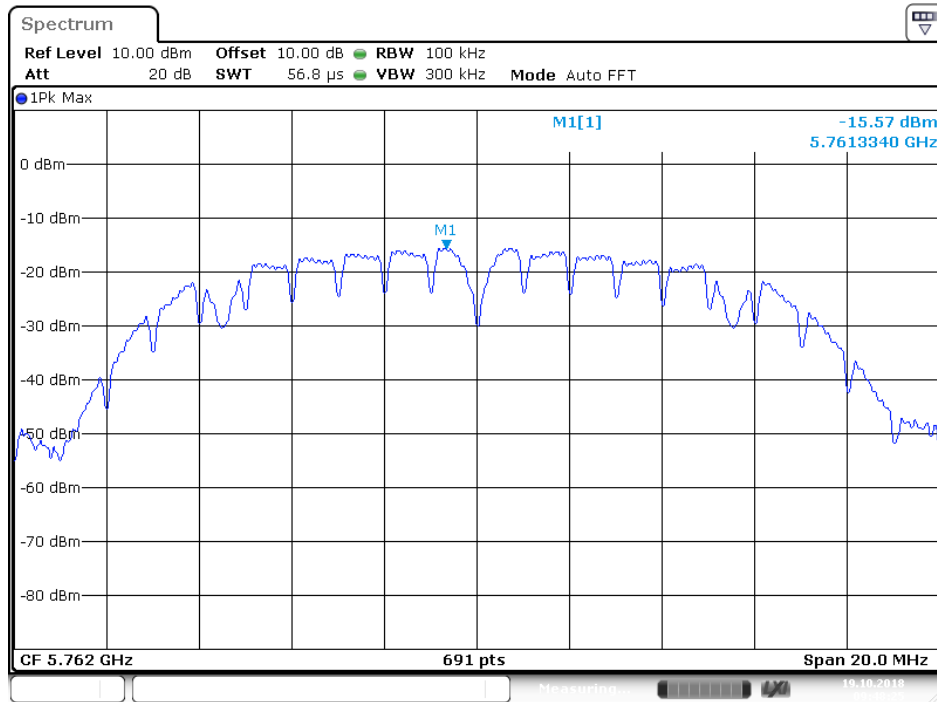

Date: 19.OCT.2018 09:48:25

High channel(Antenna B)

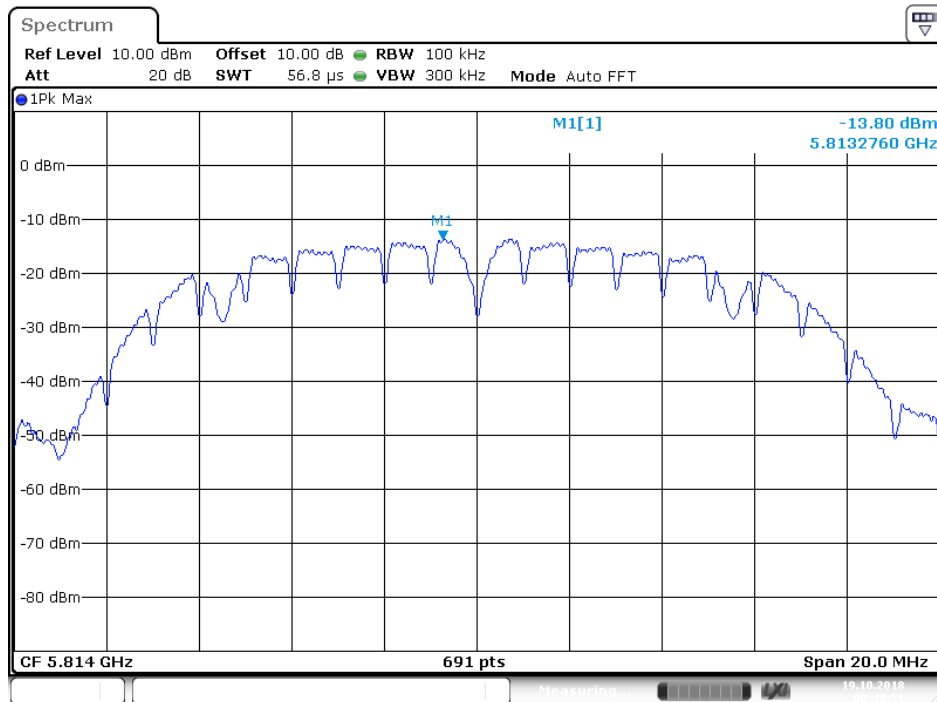

Date: 19.OCT.2018 09:48:52

7. 99% OCCUPIED BANDWIDTH TEST

7.1. Block Diagram of Test Setup

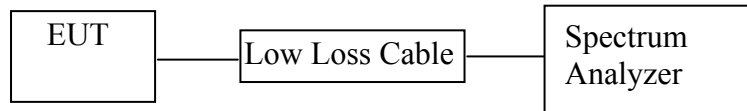

(EUT: Super Hub)

7.2. EUT Configuration on Measurement

The equipment are installed on the emission measurement to meet the commission requirements and operating regulations in a manner which tends to maximize its emission characteristics in normal application.

7.3. Operating Condition of EUT

7.3.1. Setup the EUT and simulator as shown as Section 7.1.

7.3.2. Turn on the power of all equipment.

7.3.3. Let the EUT work in TX modes measure it. The transmit frequency are 5736MHz, 5762MHz, 5814MHz, We select these frequency to transmit.

7.4. Test Procedure

7.4.1. The transmitter output was connected to the spectrum analyzer through a low loss cable.

7.4.2. Set RBW of spectrum analyzer to 300 kHz and VBW to 1000 kHz (The nominal IF filter bandwidth (3 dB RBW) shall be in the range of 1% to 5% of the OBW, and VBW shall be approximately three times the RBW, unless otherwise specified by the applicable requirement).

7.4.3. The frequency span for the spectrum analyzer shall be between 1.5 times and 5.0 times the OBW

7.4.4. Set SPA "Meas" function, Select "Occupied Bandwidth" function, Select "99% Power Bandwidth". The frequency of the upper and lower markers indicating the edges of the transmitters "99% Power" emission bandwidth shall be recorded to automate by SPA.

7.5. Test Result

Antenna A test data

Channel	Frequency (MHz)	99% Bandwidth (MHz)	Result
Low	5736	13.929	Pass
Middle	5762	13.929	Pass
High	5814	13.965	Pass

Antenna B test data

Channel	Frequency (MHz)	99% Bandwidth (MHz)	Result
Low	5736	13.965	Pass
Middle	5762	13.965	Pass
High	5814	13.965	Pass

The spectrum analyzer plots are attached as below.

Low channel(Antenna A)

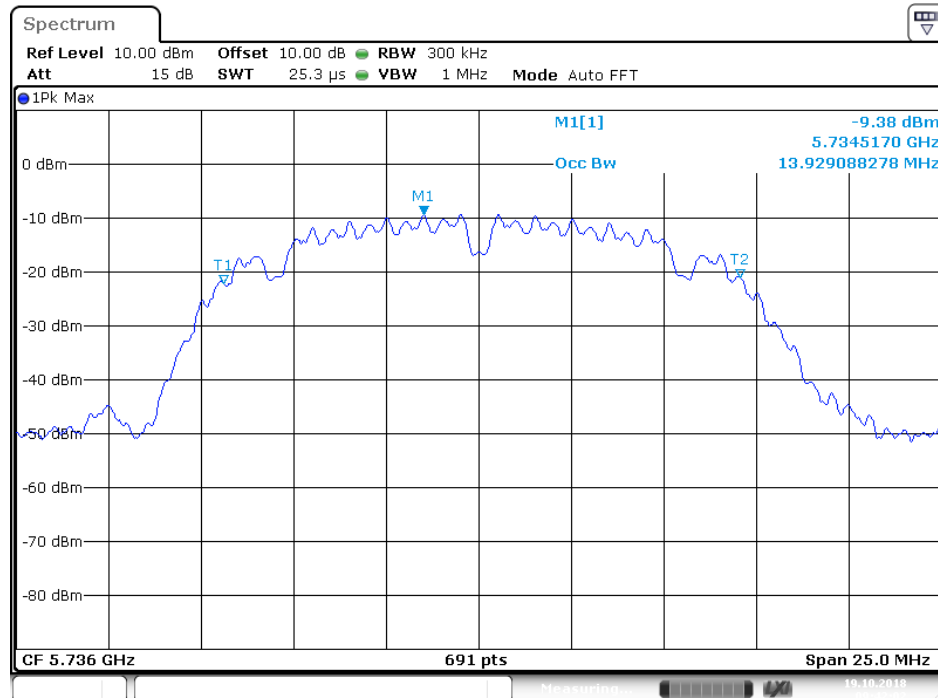

Date: 19.OCT.2018 09:42:02

Middle channel(Antenna A)

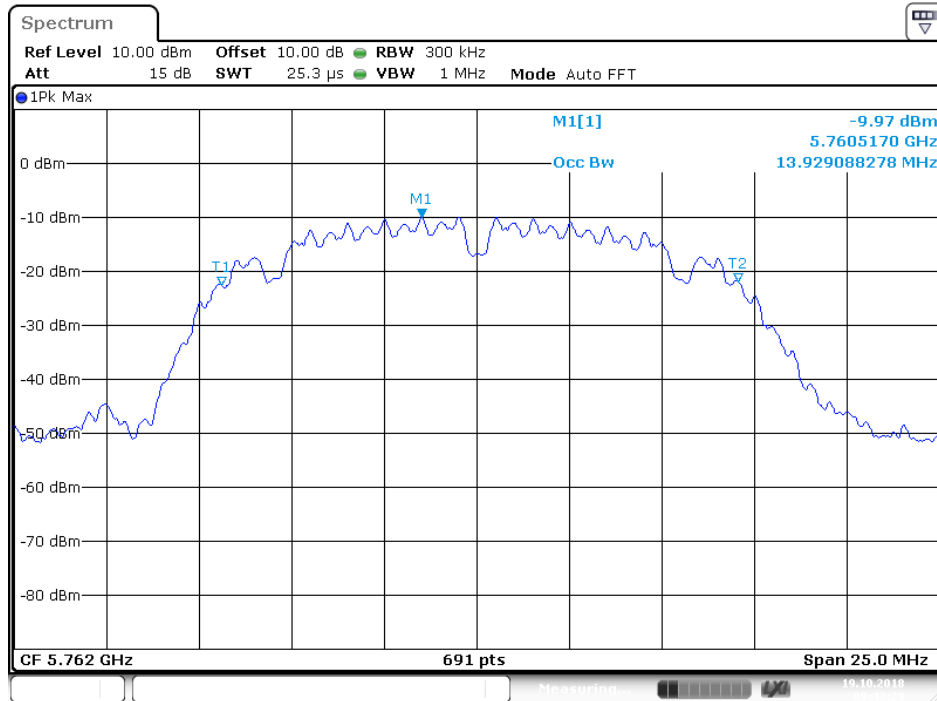

Date: 19.OCT.2018 09:42:29

High channel(Antenna A)

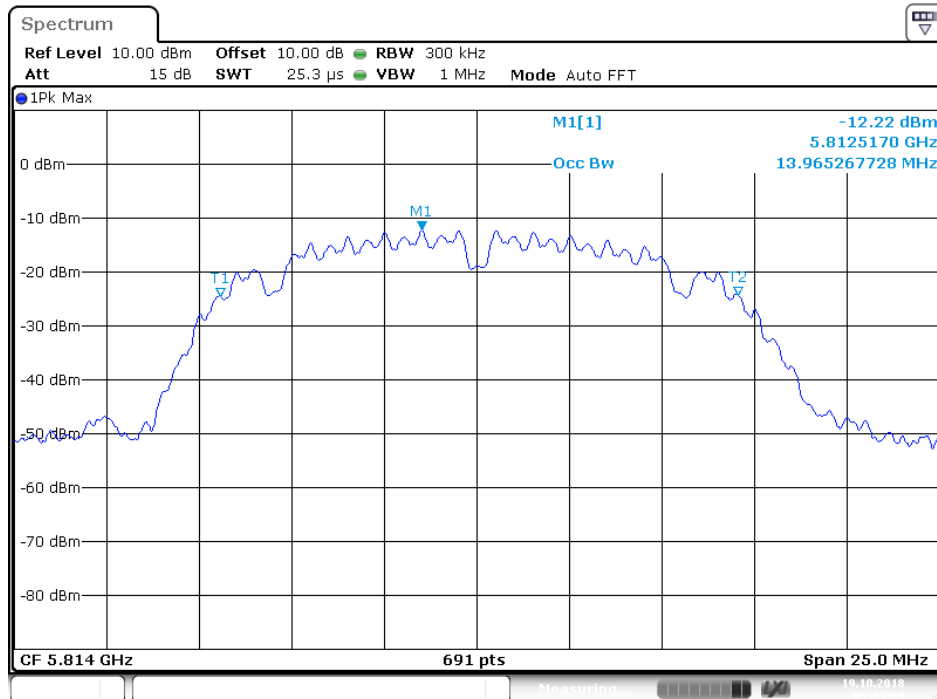

Date: 19.OCT.2018 09:43:04

Low channel(Antenna B)

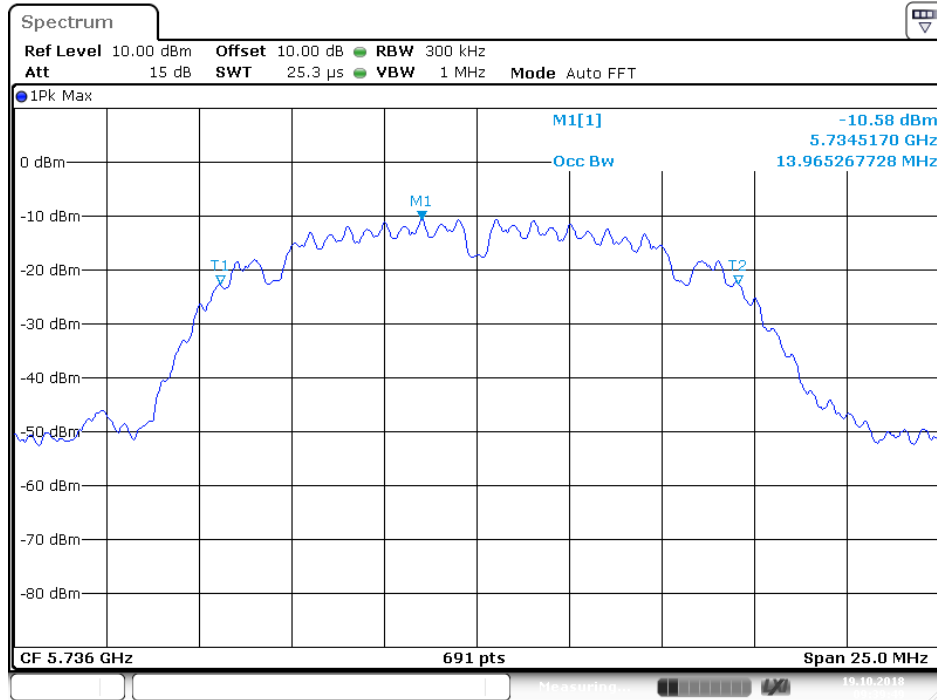

Date: 19.OCT.2018 09:39:49

Middle channel(Antenna B)

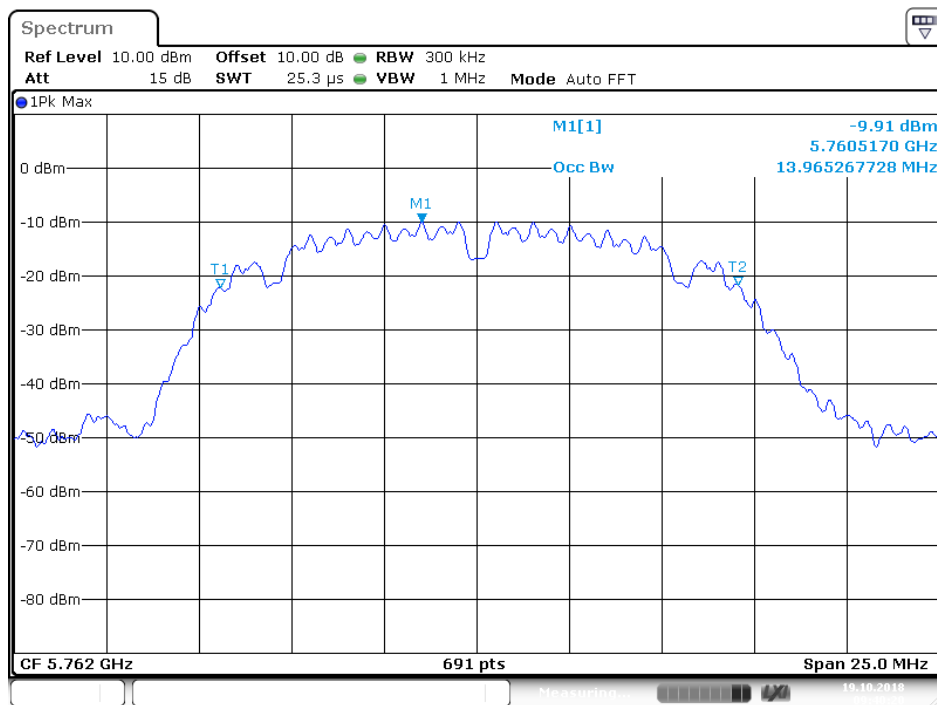

Date: 19.OCT.2018 09:40:20

High channel(Antenna B)

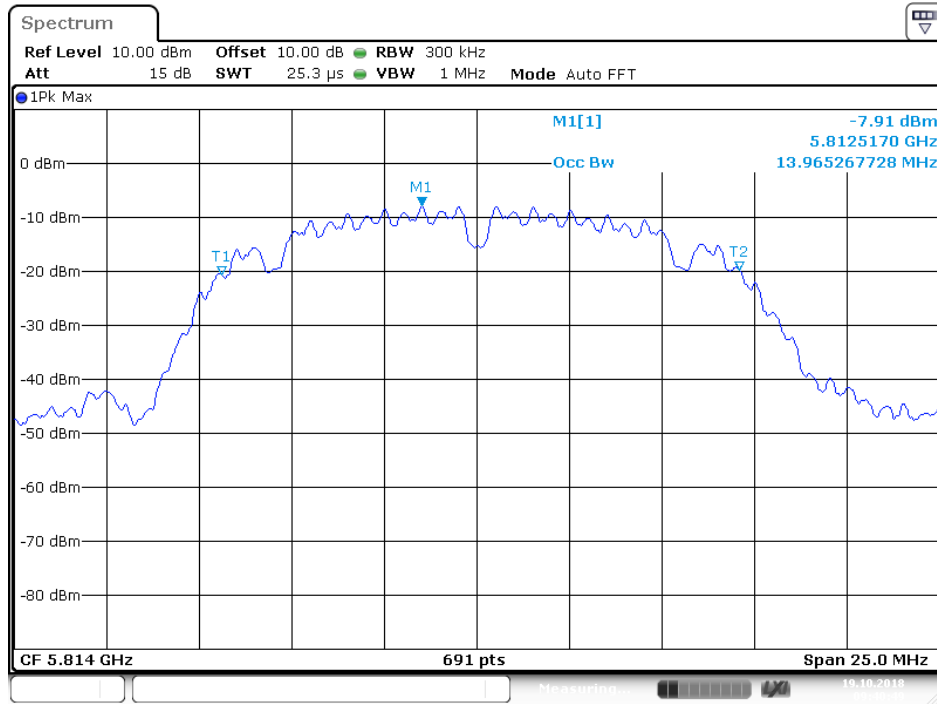

Date: 19.OCT.2018 09:40:49

8. DUTY CYCLE MEASUREMENT

8.1. Block Diagram of Test Setup

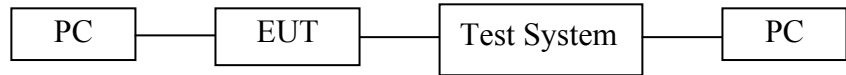

8.2. EUT Configuration on Measurement

The equipment are installed on the emission measurement to meet the commission requirements and operating regulations in a manner which tends to maximize its emission characteristics in normal application.

8.3. Operating Condition of EUT

8.3.1. Setup the EUT and simulator as shown as Section 8.1.

8.3.2. Turn on the power of all equipment.

8.3.3. Let the EUT work in TX modes measure it. The transmit frequency are 5736-5814MHz. We select 5736MHz TX frequency to transmit.

8.4. Test Procedure

Measurements of duty cycle and transmission duration shall be performed using one of the following techniques:

1. A diode detector and an oscilloscope that together have sufficiently short response time to permit accurate measurements of the on- and off-times of the transmitted signal.
2. The zero-span mode on a spectrum analyzer or EMI receiver if the response time and spacing between bins on the sweep are sufficient to permit accurate measurements of the on- and off-times of the transmitted signal
 - a. Set the center frequency of the instrument to the centre frequency of the transmission
 - b. Set $RBW \geq OBW$ if possible; otherwise, set RBW to the largest available value(10MHz).
 - c. Set detector = Peak or average.
 - d. The zero-span measurement method shall not be used unless both RBW and VBW are $> 50/T$ and the number of sweep points across duration T exceeds 100.
(For example, if VBW and/or RBW are limited to 3MHz, then the zero-span method of measuring duty cycle shall not be used if $T \leq 16.7$ microseconds.)

8.5. Test Result

Channel	Frequency (MHz)	duty cycle(x) ANT A	10log(1/x) ANT A	duty cycle(x) ANT B	10log(1/x) ANT B
Middle	5762	100%	0.0	100%	0.0

Note: The duty cycle's parameter settings for each mode are the same, Therefore, other channels can refer to the test data of the middle channel.

The spectrum analyzer plots are attached as below.

Duty cycle
5762MHz (ANT A)

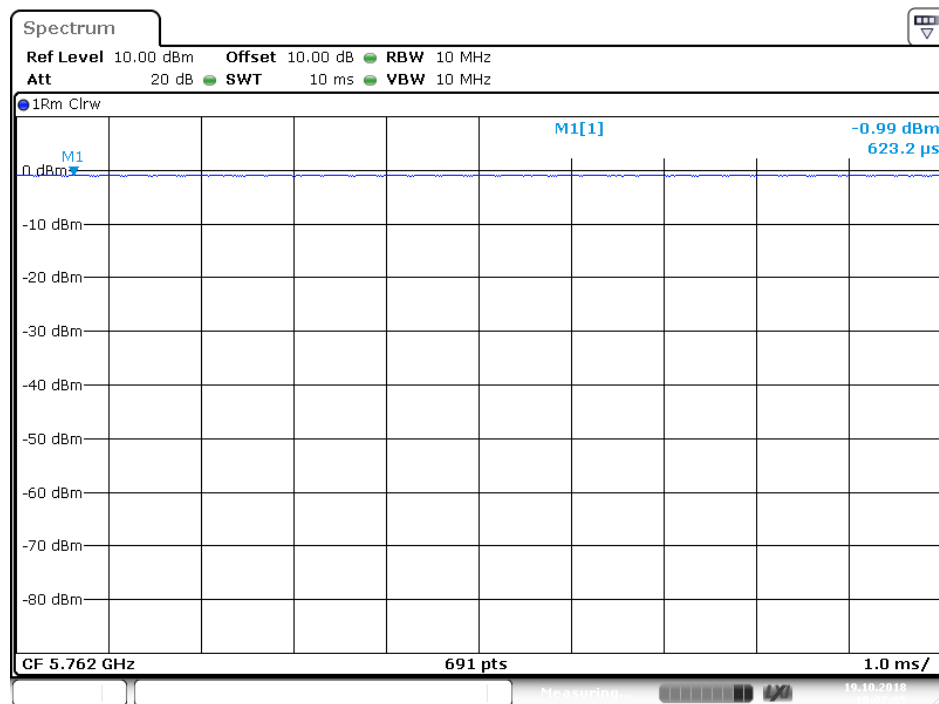

Date: 19.OCT.2018 10:07:05

Duty cycle 5762MHz (ANT B)

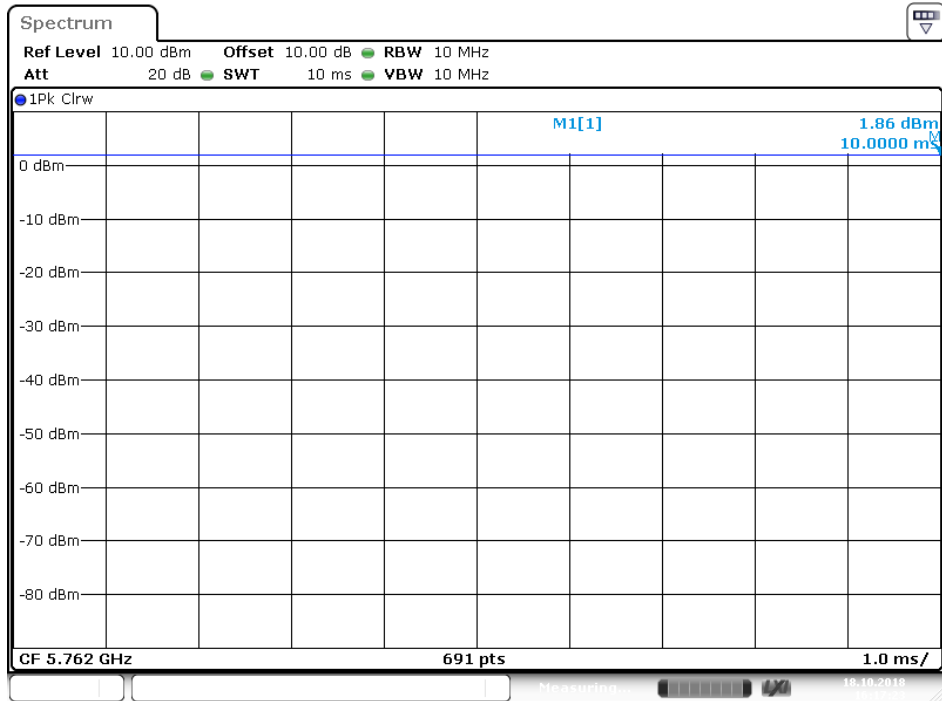

Date: 18.OCT.2018 16:17:24

9. MAXIMUM CONDUCTED (AVERAGE) OUTPUT POWER

9.1. Block Diagram of Test Setup

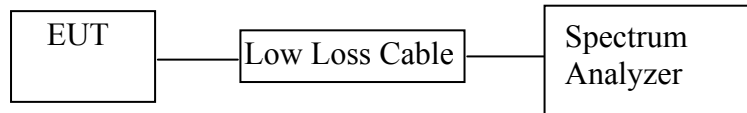

(EUT: Super Hub)

9.2. The Requirement For Section 15.247(b)(3)

Section 15.247(b)(3): For systems using digital modulation in the 902-928 MHz, 2400-2483.5 MHz, and 5725-5850 MHz bands: 1 Watt. As an alternative to a peak power measurement, compliance with the one Watt limit can be based on a measurement of the maximum conducted output power. Maximum Conducted Output Power is defined as the total transmit power delivered to all antennas and antenna elements averaged across all symbols in the signaling alphabet when the transmitter is operating at its maximum power control level. Power must be summed across all antennas and antenna elements. The average must not include any time intervals during which the transmitter is off or is transmitting at a reduced power level. If multiple modes of operation are possible (e.g., alternative modulation methods), the maximum conducted output power is the highest total transmit power occurring in any mode.

9.3. EUT Configuration on Measurement

The equipment are installed on the emission Measurement to meet the commission requirements and operating regulations in a manner which tends to maximize its emission characteristics in normal application.

9.4. Operating Condition of EUT

9.4.1. Setup the EUT and simulator as shown as Section 9.1.

9.4.2. Turn on the power of all equipment.

9.4.3. Let the EUT work in TX modes and measure it. The transmit frequency are 5736MHz, 5762MHz, 5814MHz.

9.5. Test Procedure

Refer to section 8.3.2 of KDB 558074 D01 DTS Meas Guidance v05

9.5.1. The transmitter output was connected to the spectrum analyzer through a low loss cable.

9.5.2. Set span to at least 1.5 times the OBW.

9.5.3. Set RBW = 1-5% of the OBW, not to exceed 1 MHz.

9.5.4. Set RBW of spectrum analyzer to 1MHz and VBW to 3MHz for test mode. Set detector = RMS. Set span to at least 1.5 times the OBW. The EUT shall be operated at $\geq 98\%$ duty cycle

9.5.5. Sweep time = auto.

9.5.6. Measurement the maximum conducted(Average) output power.

9.6. Test Result

Antenna A test result

Channel	Frequency (MHz)	Max conducted (average)Output Power (dBm)	Limits dBm
Low	5736	3.57	30
Middle	5762	2.40	30
High	5814	2.93	30

Antenna B test result

Channel	Frequency (MHz)	Max conducted (average)Output Power (dBm)	Limits dBm
Low	5736	2.20	30
Middle	5762	2.86	30
High	5814	2.70	30

The spectrum analyzer plots are attached as below.

Low channel (Antenna A)

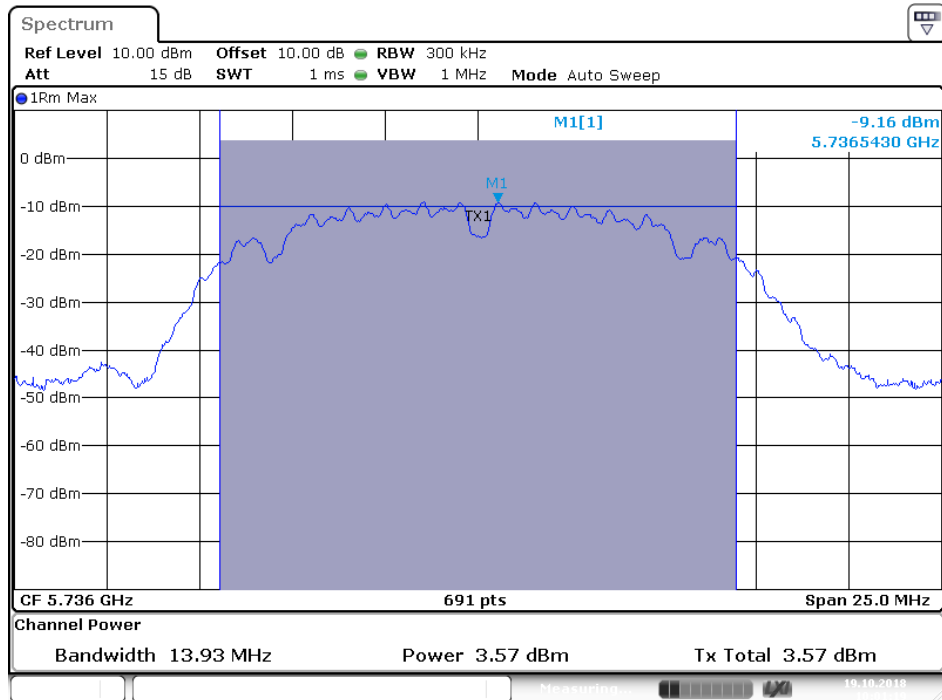

Date: 19.OCT.2018 10:01:19

Middle channel (Antenna A)

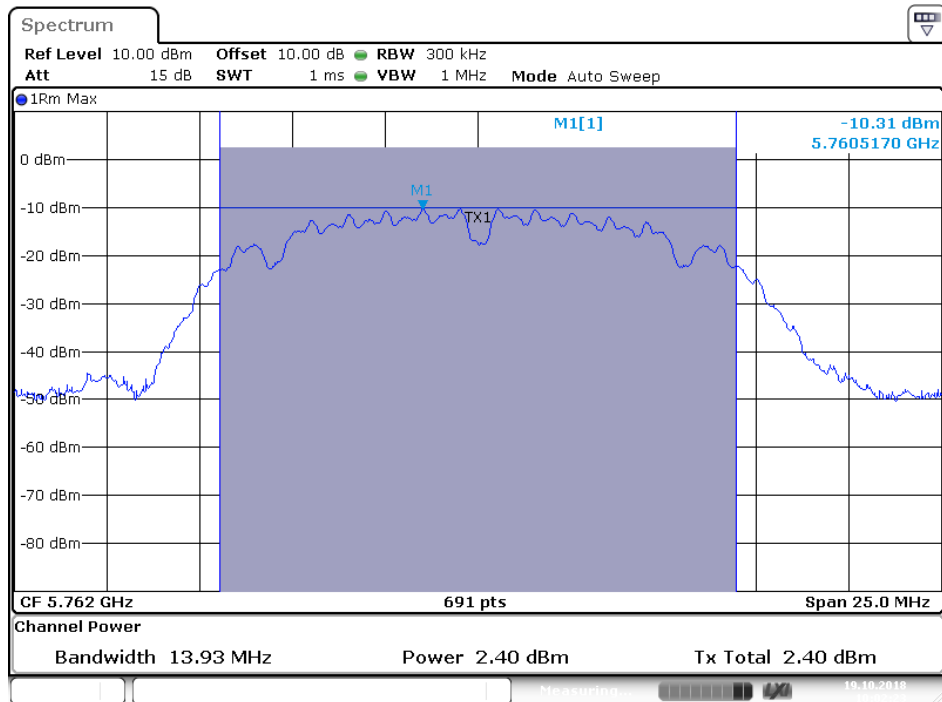

Date: 19.OCT.2018 10:02:23

High channel (Antenna A)

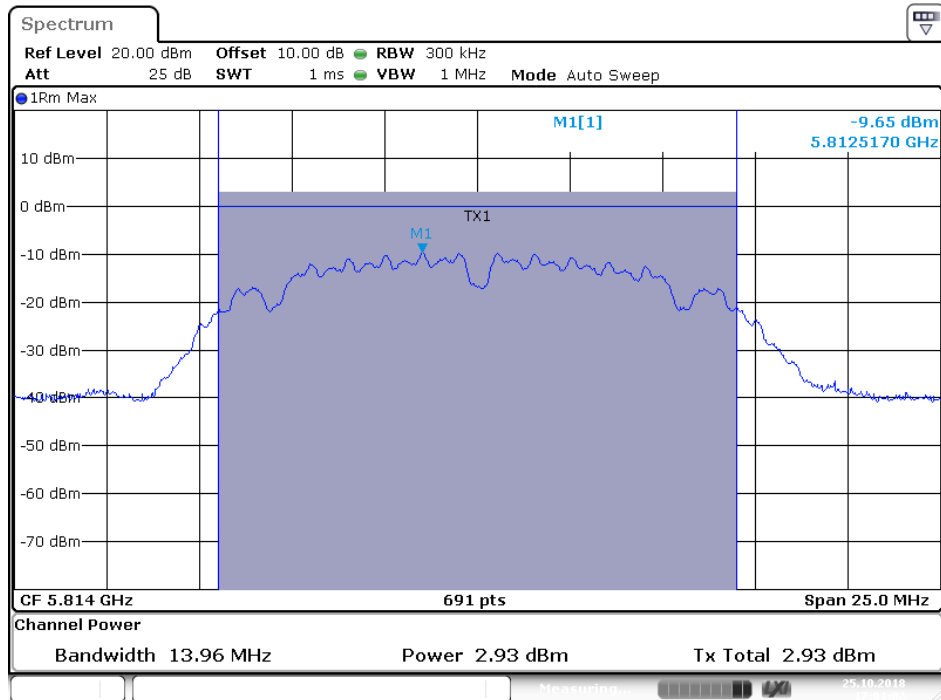

Date: 25.OCT.2018 17:01:02

Low channel (Antenna B)

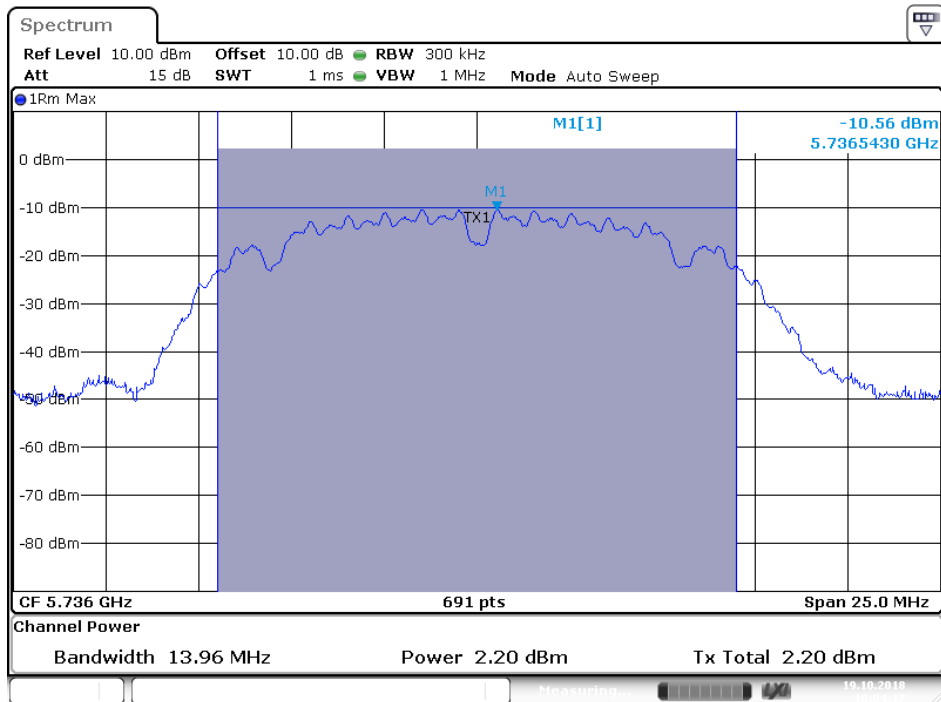

Date: 19.OCT.2018 10:04:17

Middle channel (Antenna B)

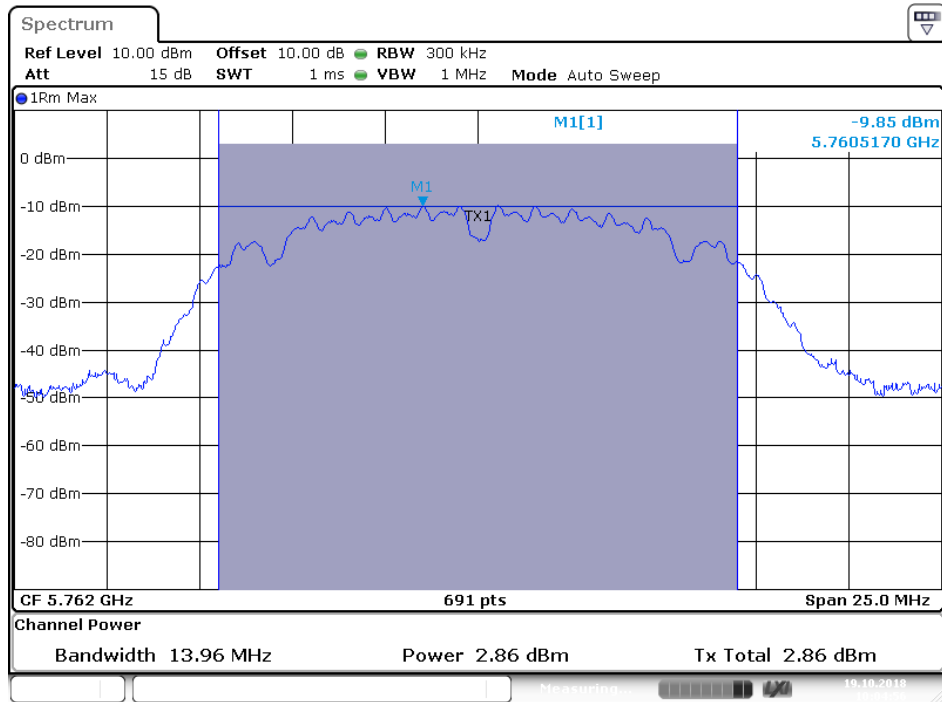

Date: 19.OCT.2018 10:04:56

High channel (Antenna B)

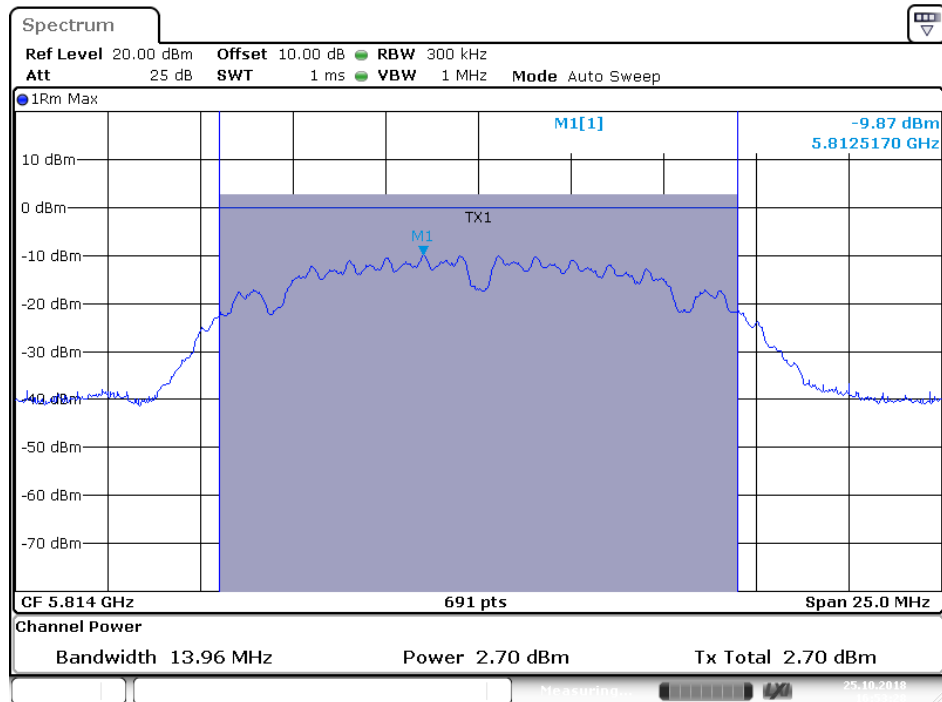

Date: 25.OCT.2018 16:53:28

10.RADIATED EMISSION TEST

10.1.Block Diagram of Test Setup

10.1.1.Block diagram of connection between the EUT and simulators

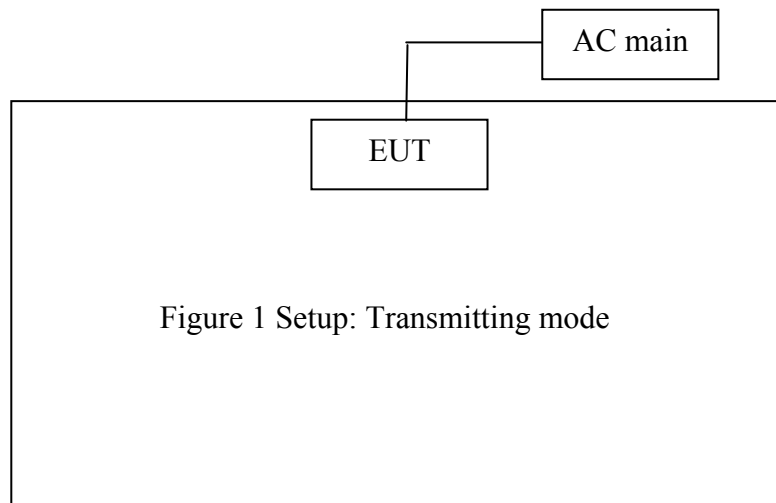

(EUT: Super Hub)

10.1.1.Semi-Anechoic Chamber Test Setup Diagram

(A) Radiated Emission Test Set-Up, Frequency below 30MHz

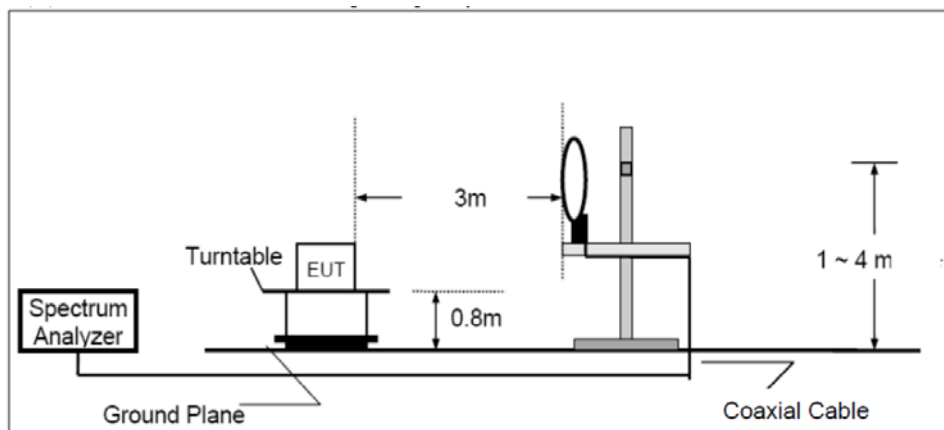

(B) Radiated Emission Test Set-Up, Frequency below 1GHz

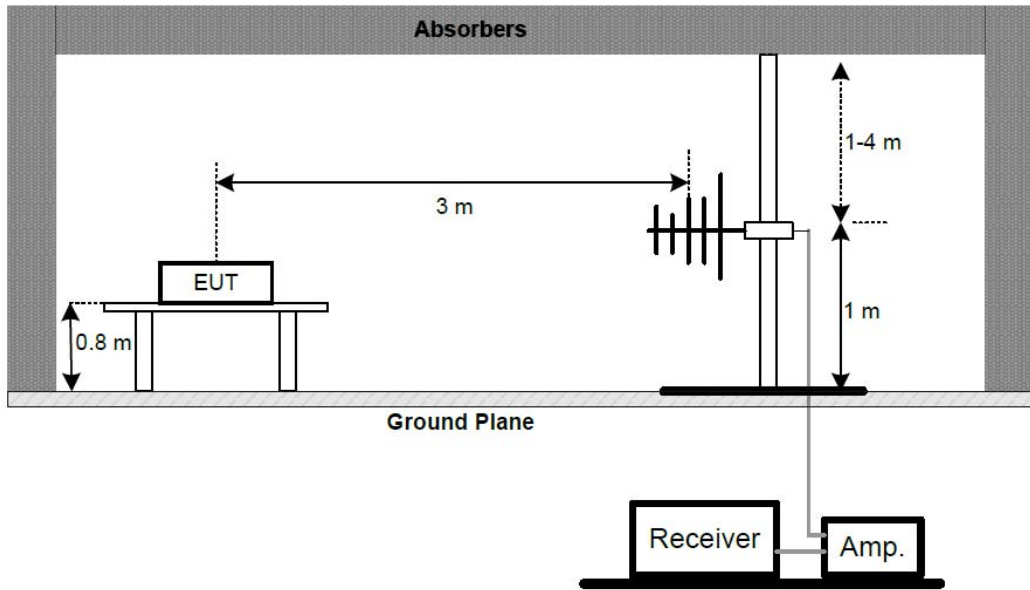

(C) Radiated Emission Test Set-Up, Frequency Above 1GHz

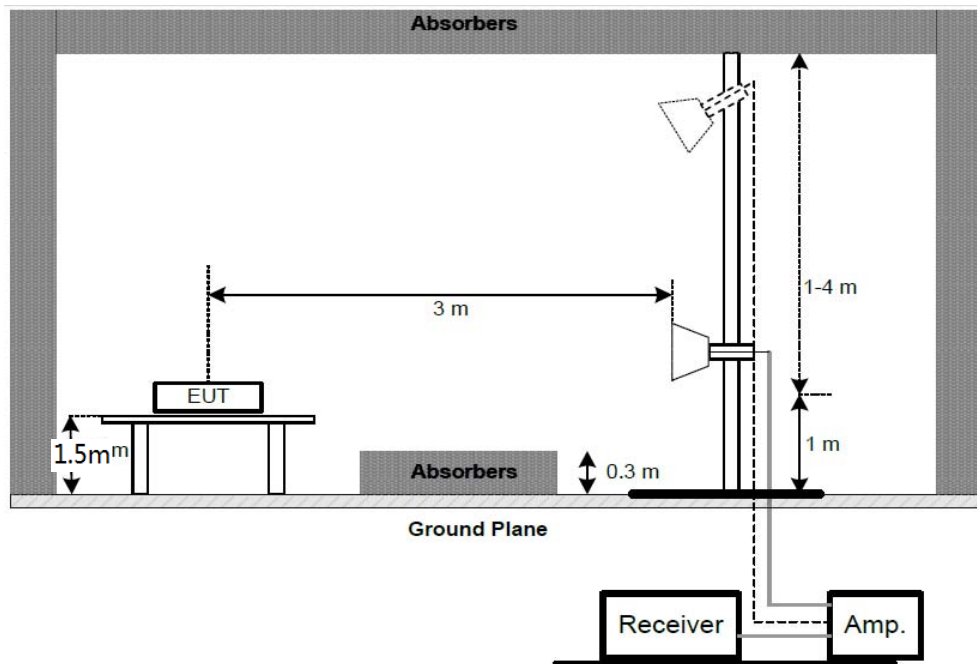

10.2. The Limit For Section 15.247(d)

Section 15.247(d): In any 100 kHz bandwidth outside the frequency band in which the spread spectrum or digitally modulated intentional radiator is operating, the radio frequency power that is produced by the intentional radiator shall be at least 20 dB below that in the 100 kHz bandwidth within the band that contains the highest level of the desired power, based on either an RF conducted or a radiated measurement, provided the transmitter demonstrates compliance with the peak conducted power limits. If the

transmitter complies with the conducted power limits based on the use of RMS averaging over a time interval, as permitted under paragraph (b)(3) of this section, the attenuation required under this paragraph shall be 30 dB instead of 20 dB. Attenuation below the general limits specified in Section 15.209(a) is not required. In addition, radiated emissions which fall in the restricted bands, as defined in Section 15.205(a), must also comply with the radiated emission limits specified in Section 15.209(a).

10.3.Restricted bands of operation

10.3.1.FCC Part 15.205 Restricted bands of operation

(a) Except as shown in paragraph (d) of this section, Only spurious emissions are permitted in any of the frequency bands listed below:

MHz	MHz	MHz	GHz
0.090-0.110	16.42-16.423	399.9-410	4.5-5.15
¹ 0.495-0.505	16.69475-16.69525	608-614	5.35-5.46
2.1735-2.1905	16.80425-16.80475	960-1240	7.25-7.75
4.125-4.128	25.5-25.67	1300-1427	8.025-8.5
4.17725-4.17775	37.5-38.25	1435-1626.5	9.0-9.2
4.20725-4.20775	73-74.6	1645.5-1646.5	9.3-9.5
6.215-6.218	74.8-75.2	1660-1710	10.6-12.7
6.26775-6.26825	108-121.94	1718.8-1722.2	13.25-13.4
6.31175-6.31225	123-138	2200-2300	14.47-14.5
8.291-8.294	149.9-150.05	2310-2390	15.35-16.2
8.362-8.366	156.52475-156.52525	2483.5-2500	17.7-21.4
8.37625-8.38675	156.7-156.9	2690-2900	22.01-23.12
8.41425-8.41475	162.0125-167.17	3260-3267	23.6-24.0
12.29-12.293	167.72-173.2	3332-3339	31.2-31.8
12.51975-12.52025	240-285	3345.8-3358	36.43-36.5
12.57675-12.57725	322-335.4	3600-4400	(²)
13.36-13.41			

¹Until February 1, 1999, this restricted band shall be 0.490-0.510

²Above 38.6

(b) Except as provided in paragraphs (d) and (e), the field strength of emission appearing within these frequency bands shall not exceed the limits shown in Section 15.209. At frequencies equal to or less than 1000MHz, Compliance with the limits in Section 15.209 shall be demonstrated using measurement instrumentation employing a CISPR quasi-peak detector. Above 1000MHz, compliance with the emission limits in Section 15.209 shall be demonstrated based on the average value of the measured emissions. The provisions in Section 15.35 apply to these measurements.

10.4.Configuration of EUT on Measurement

The equipment are installed on Radiated Emission Measurement to meet the commission requirements and operating regulations in a manner which tends to maximize its emission characteristics in normal application.

10.5. Test Procedure

The EUT and its simulators are placed on a turntable, which is 0.8 meter high above ground (Below 1GHz). The EUT and its simulators are placed on a turntable, which is 1.5 meter high above ground (Above 1GHz). The turntable can rotate 360 degrees to determine the position of the maximum emission level. EUT is set 3.0 meters away from the receiving antenna, which is mounted on an antenna tower. The antenna can be moved up and down between 1.0 meter and 4 meters to find out the maximum emission level. Broadband antenna (calibrated bilog antenna) is used as receiving antenna. Both horizontal and vertical polarizations of the antenna are set on measurement. In order to find the maximum emission levels, all of the interface cables must be manipulated according to ANSI C63.10:2013 on radiated emission measurement.

The bandwidth of test receiver (R&S ESI26) is set at 120 KHz in 30-1000MHz. and set at 1MHz in above 1000MHz.

The frequency range from 30MHz to 40000MHz is checked.

The final measurement in band 9-90 kHz, 110-490 kHz and above 1000MHz is performed with Average detector. Except those frequency bands mention above, the final measurement for frequencies below 1000MHz is performed with Quasi Peak detector.

The field strength is calculated by adding the antenna factor, and cable loss, and subtracting the amplifier gain from the measured reading. The basic equation calculation is as follows:

Result = Reading + Corrected Factor

Where Corrected Factor = Antenna Factor + Cable Loss – Amplifier Gain

10.6. Data Sample

Frequency (MHz)	Reading (dB μ v)	Factor (dB/m)	Result (dB μ v/m)	Limit (dB μ v/m)	Margin (dB)	Remark
X.XX	28.66	-15.19	13.47	40.0	-26.53	QP

Frequency(MHz) = Emission frequency in MHz

Reading(dB μ v) = Uncorrected Analyzer/Receiver reading

Factor (dB/m) = Antenna factor + Cable Loss – Amplifier gain

Result(dB μ v/m) = Reading(dB μ v) + Factor(dB/m)

Limit (dB μ v/m) = Limit stated in standard

Margin (dB) = Result(dB μ v/m) - Limit (dB μ v/m)

QP = Quasi-peak Reading

Calculation Formula:

Margin(dB) = Result (dB μ V/m)–Limit(dB μ V/m)

Result(dB μ V/m)= Reading(dB μ V)+ Factor(dB/m)

The “Margin” column of the following data tables indicates the degree of compliance with the applicable limit. For example, a margin of -7dB means the emission is 7dB below the limit.

10.7. The Field Strength of Radiation Emission Measurement Results

Note:

- 1. The radiation emissions in the frequency band of 9kHz-30MHz are not reported, because the test values are too low against the limit.**
- 2. we tested radiation emission of Antenna A and Antenna B, The following test data is the worst case(Antenna A) data which I have recorded**
- 3. The average measurement was not performed when peak measured data under the limit of average detection.**

30MHz -1GHz test data

ACCURATE TECHNOLOGY CO., LTD.

 F1,Bldg,A,Changyuan New Material Port Keyuan Rd,
 Science & Industry Park,Nanshan Shenzhen,P.R.China

Site: 1# Chamber

Tel:+86-0755-26503290

Fax:+86-0755-26503396

Job No.: frank2018 #1870

Standard: FCC Class B 3M Radiated

Test item: Radiation Test

Temp.(C)/Hum.(%) 25 C / 55 %

EUT: Super Hub

Mode: TX 5736MHz

Model: SHB2

Manufacturer: Questyle Audio Technology Co.,Ltd

Polarization: Horizontal

Power Source: AC 120V/60Hz

Date: 2018/10/19

Time: 17:06:21

Engineer Signature:

Distance:

Note: Report NO.:ATE20181773

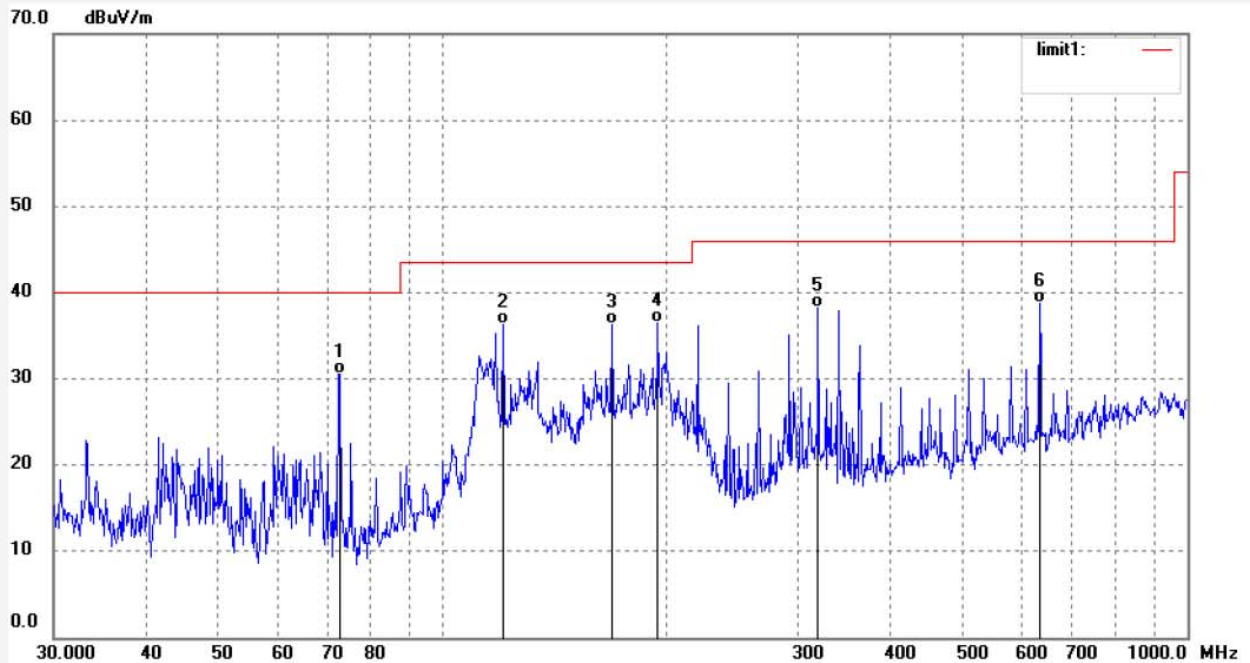

No.	Freq. (MHz)	Reading (dBuV/m)	Factor (dB)	Result (dBuV/m)	Limit (dBuV/m)	Margin (dB)	Detector	Height (cm)	Degree (deg.)	Remark
1	72.7202	55.24	-24.62	30.62	40.00	-9.38	QP	200	234	
2	120.6118	55.88	-19.59	36.29	43.50	-7.21	QP	200	160	
3	168.9970	56.65	-20.25	36.40	43.50	-7.10	QP	200	64	
4	194.4985	55.51	-19.09	36.42	43.50	-7.08	QP	200	198	
5	319.2071	54.26	-16.06	38.20	46.00	-7.80	QP	200	210	
6	633.3283	48.51	-9.78	38.73	46.00	-7.27	QP	200	303	

Job No.: frank2018 #1869

Standard: FCC Class B 3M Radiated

Test item: Radiation Test

Temp.(C)/Hum.(%) 25 C / 55 %

EUT: Super Hub

Mode: TX 5736MHz

Model: SHB2

Manufacturer: Questyle Audio Technology Co.,Ltd

Polarization: Vertical

Power Source: AC 120V/60Hz

Date: 2018/10/19

Time: 17:03:12

Engineer Signature:

Distance:

Note: Report NO.:ATE20181773

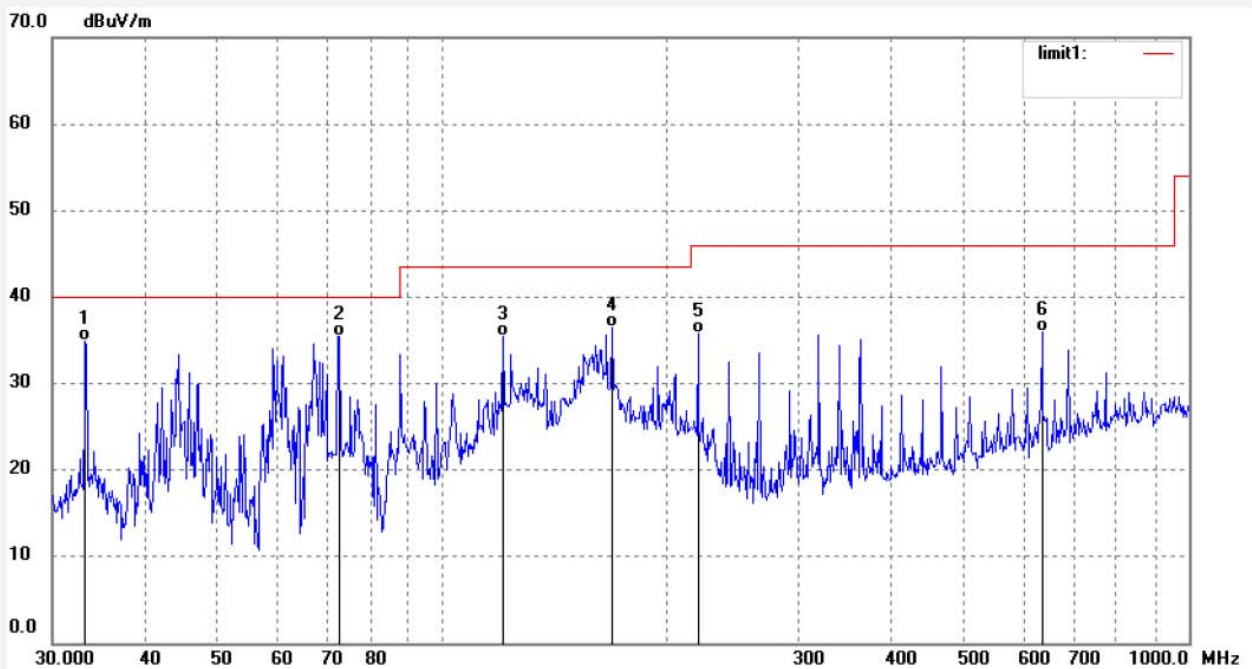

No.	Freq. (MHz)	Reading (dBuV/m)	Factor (dB)	Result (dBuV/m)	Limit (dBuV/m)	Margin (dB)	Detector	Height (cm)	Degree (deg.)	Remark
1	33.2180	53.02	-18.12	34.90	40.00	-5.10	QP	100	165	
2	72.7202	61.13	-25.62	35.51	40.00	-4.49	QP	100	52	
3	120.6118	55.02	-19.59	35.43	43.50	-8.07	QP	100	133	
4	168.9970	56.80	-20.25	36.55	43.50	-6.95	QP	100	95	
5	219.9499	54.31	-18.52	35.79	46.00	-10.21	QP	100	165	
6	635.5575	45.64	-9.76	35.88	46.00	-10.12	QP	100	302	

Job No.: frank2018 #1871
 Standard: FCC Class B 3M Radiated
 Test item: Radiation Test
 Temp.(C)/Hum.(%) 25 C / 55 %
 EUT: Super Hub
 Mode: TX 5762MHz
 Model: SHB2
 Manufacturer: Questyle Audio Technology Co.,Ltd

Polarization: Horizontal
 Power Source: AC 120V/60Hz
 Date: 2018/10/19
 Time: 17:10:54
 Engineer Signature:
 Distance:

Note: Report NO.:ATE20181773

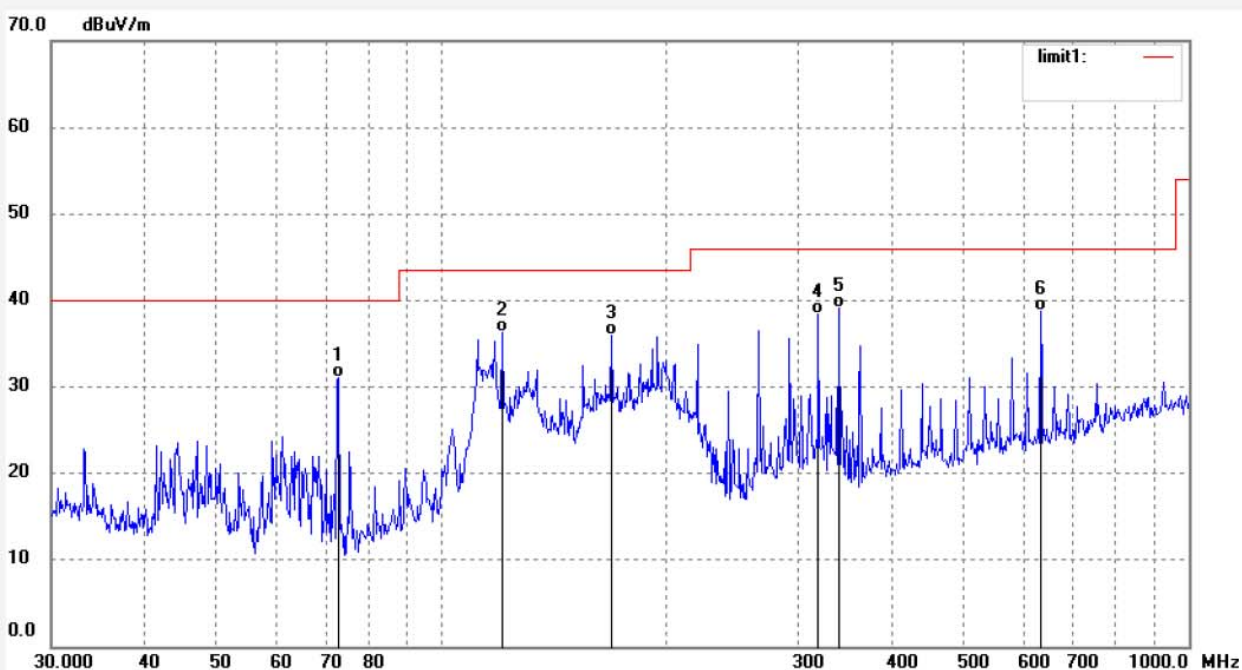

No.	Freq. (MHz)	Reading (dBuV/m)	Factor (dB)	Result (dBuV/m)	Limit (dBuV/m)	Margin (dB)	Detector	Height (cm)	Degree (deg.)	Remark
1	72.7202	55.61	-24.62	30.99	40.00	-9.01	QP	200	195	
2	120.6118	55.88	-19.59	36.29	43.50	-7.21	QP	200	230	
3	168.9970	56.19	-20.25	35.94	43.50	-7.56	QP	200	72	
4	319.2071	54.41	-16.06	38.35	46.00	-7.65	QP	200	49	
5	340.0473	54.51	-15.32	39.19	46.00	-6.81	QP	200	115	
6	633.3283	48.62	-9.78	38.84	46.00	-7.16	QP	200	103	

Job No.: frank2018 #1872

Standard: FCC Class B 3M Radiated

Test item: Radiation Test

Temp.(C)/Hum.(%) 25 C / 55 %

EUT: Super Hub

Mode: TX 5762MHz

Model: SHB2

Manufacturer: Questyle Audio Technology Co.,Ltd

Polarization: Vertical

Power Source: AC 120V/60Hz

Date: 2018/10/19

Time: 17:13:05

Engineer Signature:

Distance:

Note: Report NO.:ATE20181773

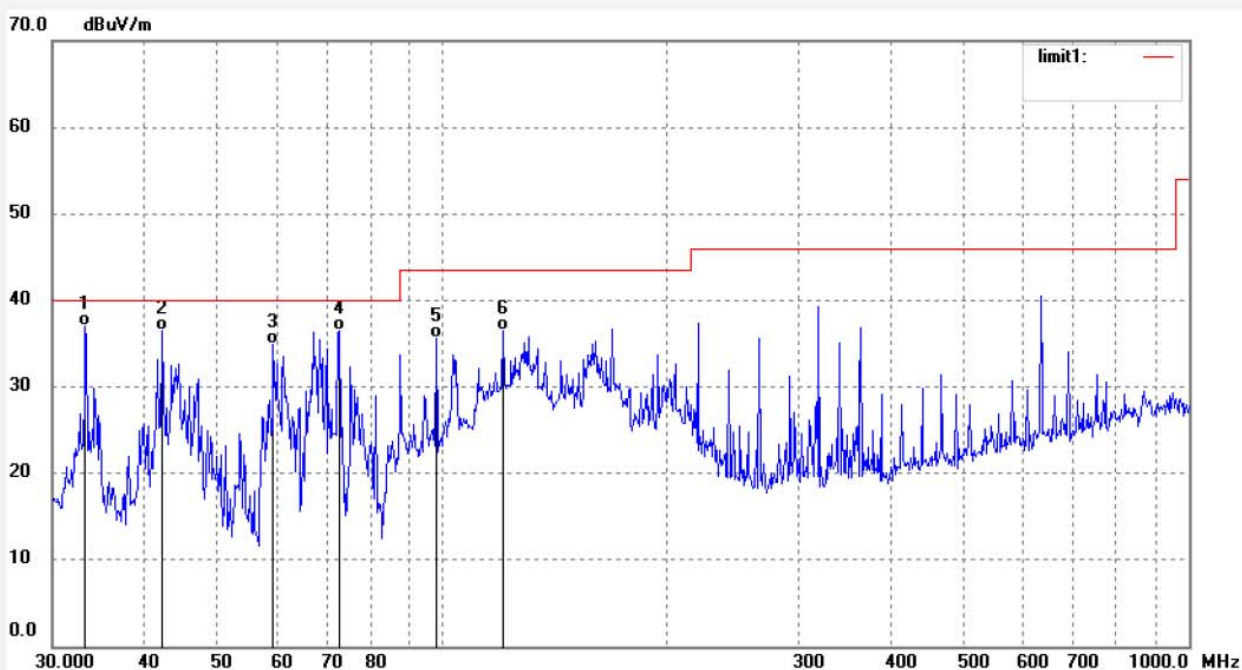

No.	Freq. (MHz)	Reading (dBuV/m)	Factor (dB)	Result (dBuV/m)	Limit (dBuV/m)	Margin (dB)	Detector	Height (cm)	Degree (deg.)	Remark
1	33.2180	55.13	-18.12	37.01	40.00	-2.99	QP	100	210	
2	42.1828	56.10	-19.57	36.53	40.00	-3.47	QP	100	71	
3	59.3132	58.23	-23.29	34.94	40.00	-5.06	QP	100	49	
4	72.7202	62.13	-25.62	36.51	40.00	-3.49	QP	100	55	
5	98.0301	54.61	-19.05	35.56	43.50	-7.94	QP	100	246	
6	120.6118	56.13	-19.59	36.54	43.50	-6.96	QP	100	103	

Job No.: frank2018 #1874

Standard: FCC Class B 3M Radiated

Test item: Radiation Test

Temp.(C)/Hum.(%) 25 C / 55 %

EUT: Super Hub

Mode: TX 5814MHz

Model: SHB2

Manufacturer: Questyle Audio Technology Co.,Ltd

Polarization: Horizontal

Power Source: AC 120V/60Hz

Date: 2018/10/19

Time: 17:20:17

Engineer Signature:

Distance:

Note: Report NO.:ATE20181773

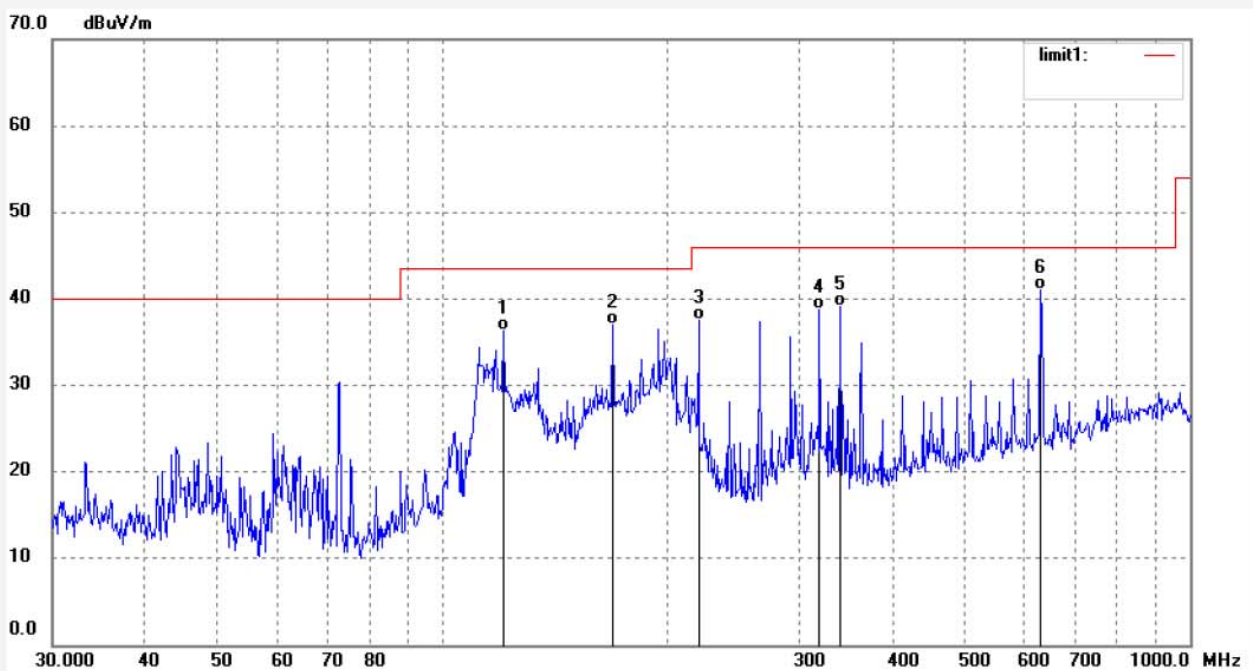

No.	Freq. (MHz)	Reading (dBuV/m)	Factor (dB)	Result (dBuV/m)	Limit (dBuV/m)	Margin (dB)	Detector	Height (cm)	Degree (deg.)	Remark
1	120.6118	55.89	-19.59	36.30	43.50	-7.20	QP	200	59	
2	168.9970	57.35	-20.25	37.10	43.50	-6.40	QP	200	110	
3	219.9499	56.07	-18.52	37.55	46.00	-8.45	QP	200	44	
4	319.2071	54.78	-16.06	38.72	46.00	-7.28	QP	200	59	
5	340.0473	54.48	-15.32	39.16	46.00	-6.84	QP	200	126	
6	631.1068	50.89	-9.79	41.10	46.00	-4.90	QP	200	103	

Job No.: frank2018 #1873

Standard: FCC Class B 3M Radiated

Test item: Radiation Test

Temp.(C)/Hum.(%) 25 C / 55 %

EUT: Super Hub

Mode: TX 5814MHz

Model: SHB2

Manufacturer: Questyle Audio Technology Co.,Ltd

Polarization: Vertical

Power Source: AC 120V/60Hz

Date: 2018/10/19

Time: 17:16:04

Engineer Signature:

Distance:

Note: Report NO.:ATE20181773

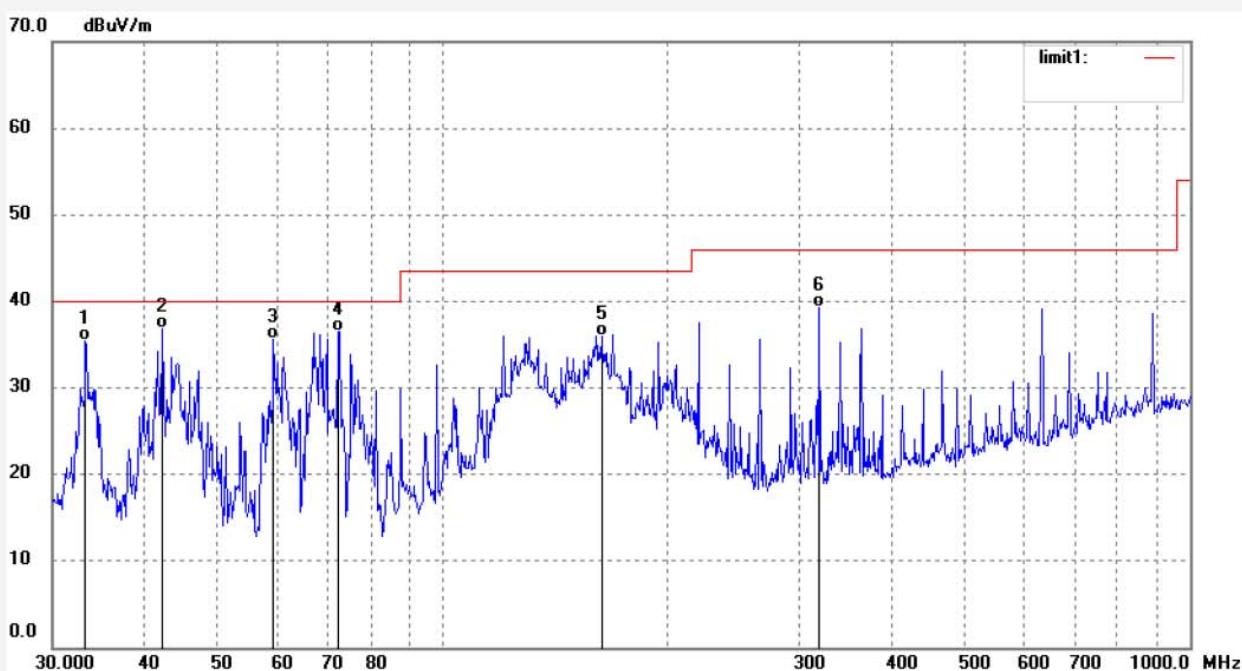

No.	Freq. (MHz)	Reading (dBuV/m)	Factor (dB)	Result (dBuV/m)	Limit (dBuV/m)	Margin (dB)	Detector	Height (cm)	Degree (deg.)	Remark
1	33.2180	53.63	-18.12	35.51	40.00	-4.49	QP	100	201	
2	42.1828	56.39	-19.57	36.82	40.00	-3.18	QP	100	314	
3	59.3132	58.82	-23.29	35.53	40.00	-4.47	QP	100	197	
4	72.4651	62.16	-25.63	36.53	40.00	-3.47	QP	100	52	
5	163.1622	56.77	-20.84	35.93	43.50	-7.57	QP	100	163	
6	319.2071	55.32	-16.06	39.26	46.00	-6.74	QP	100	139	

1GHz -18GHz test data



ACCURATE TECHNOLOGY CO., LTD.

F1,Bldg,A,Changyuan New Material Port Keyuan Rd,
Science & Industry Park,Nanshan Shenzhen,P.R.China

Site: 1# Chamber

Tel:+86-0755-26503290

Fax:+86-0755-26503396

Job No.: frank2018 #1945	Polarization: Horizontal
Standard: FCC PK	Power Source: AC 120V/60Hz
Test item: Radiation Test	Date: 2018/10/22
Temp.(C)/Hum.(%) 25 C / 55 %	Time: 16:07:39
EUT: Super Hub	Engineer Signature:
Mode: TX 5736MHz	Distance:
Model: SHB2	
Manufacturer: Questyle Audio Technology Co.,Ltd	

Note: Report NO.:ATE20181773

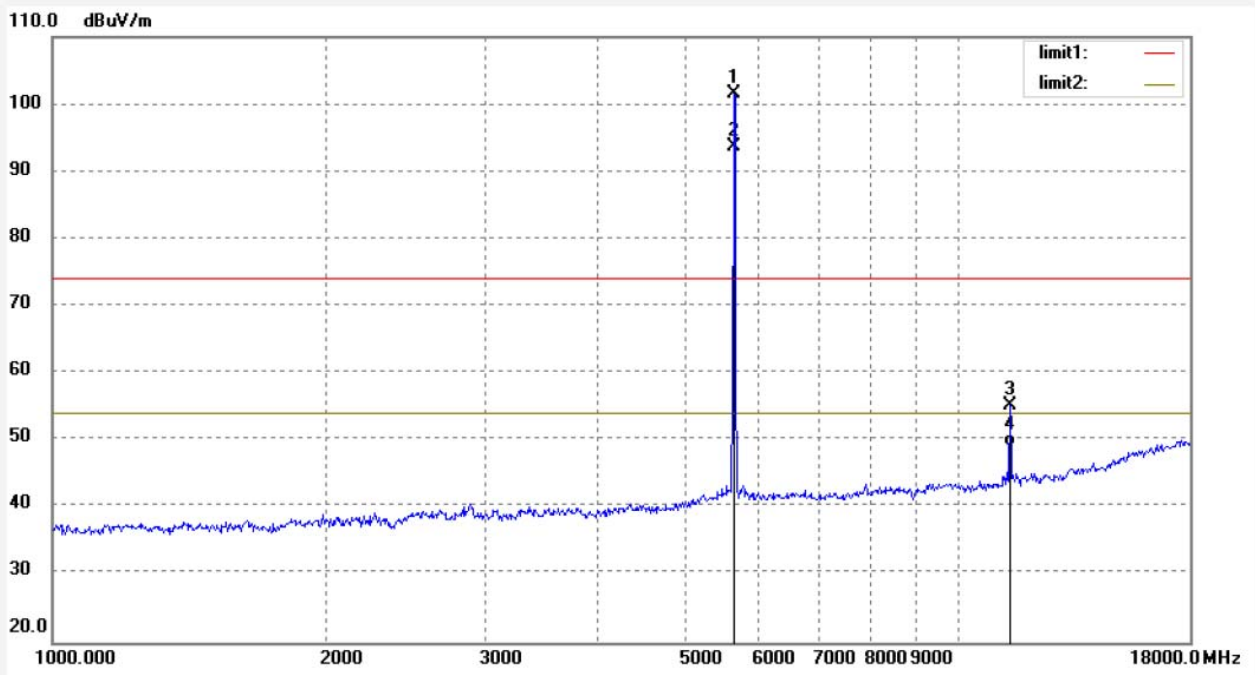

No.	Freq. (MHz)	Reading (dBuV/m)	Factor (dB)	Result (dBuV/m)	Limit (dBuV/m)	Margin (dB)	Detector	Height (cm)	Degree (deg.)	Remark
1	5736.350	102.13	-0.52	101.61			peak	250	171	
2	5736.350	94.32	-0.52	93.80			peak	250	59	
3	11472.691	48.85	6.41	55.26	74.00	-18.74	peak	250	122	
4	11472.691	42.64	6.41	49.05	54.00	-4.95	AVG	250	130	

Job No.: frank2018 #1946

Standard: FCC PK

Test item: Radiation Test

Temp.(C)/Hum.(%) 25 C / 55 %

EUT: Super Hub

Mode: TX 5736MHz

Model: SHB2

Manufacturer: Questyle Audio Technology Co.,Ltd

Polarization: Vertical

Power Source: AC 120V/60Hz

Date: 2018/10/22

Time: 16:08:43

Engineer Signature:

Distance:

Note: Report NO.:ATE20181773

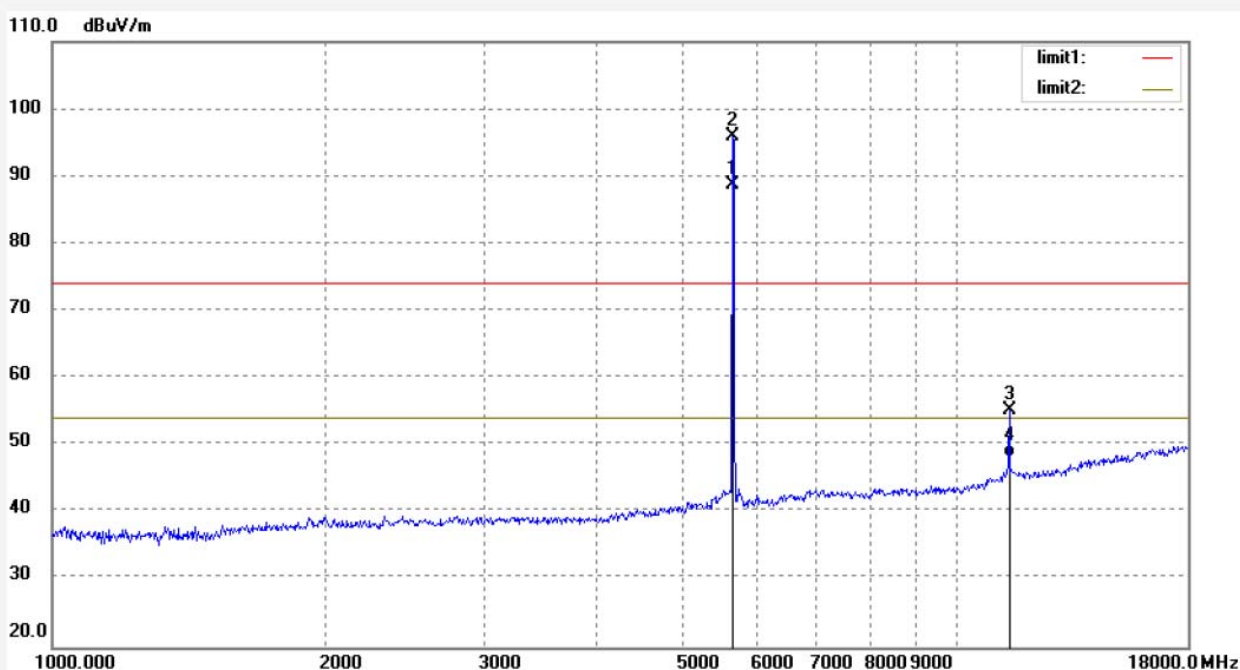

No.	Freq. (MHz)	Reading (dBuV/m)	Factor (dB)	Result (dBuV/m)	Limit (dBuV/m)	Margin (dB)	Detector	Height (cm)	Degree (deg.)	Remark
1	5736.350	96.53	-0.52	96.01			peak	150	88	
2	5736.350	89.15	-0.52	88.63			AVG	150	95	
3	11472.691	48.84	6.45	55.29	74.00	-18.71	peak	150	145	
4	11472.691	41.75	6.45	48.20	54.00	-5.80	AVG	150	302	

Job No.: frank2018 #1948

Standard: FCC PK

Test item: Radiation Test

Temp.(C)/Hum.(%) 25 C / 55 %

EUT: Super Hub

Mode: TX 5762MHz

Model: SHB2

Manufacturer: Questyle Audio Technology Co.,Ltd

Polarization: Horizontal

Power Source: AC 120V/60Hz

Date: 2018/10/22

Time: 16:12:30

Engineer Signature:

Distance:

Note: Report NO.:ATE20181773

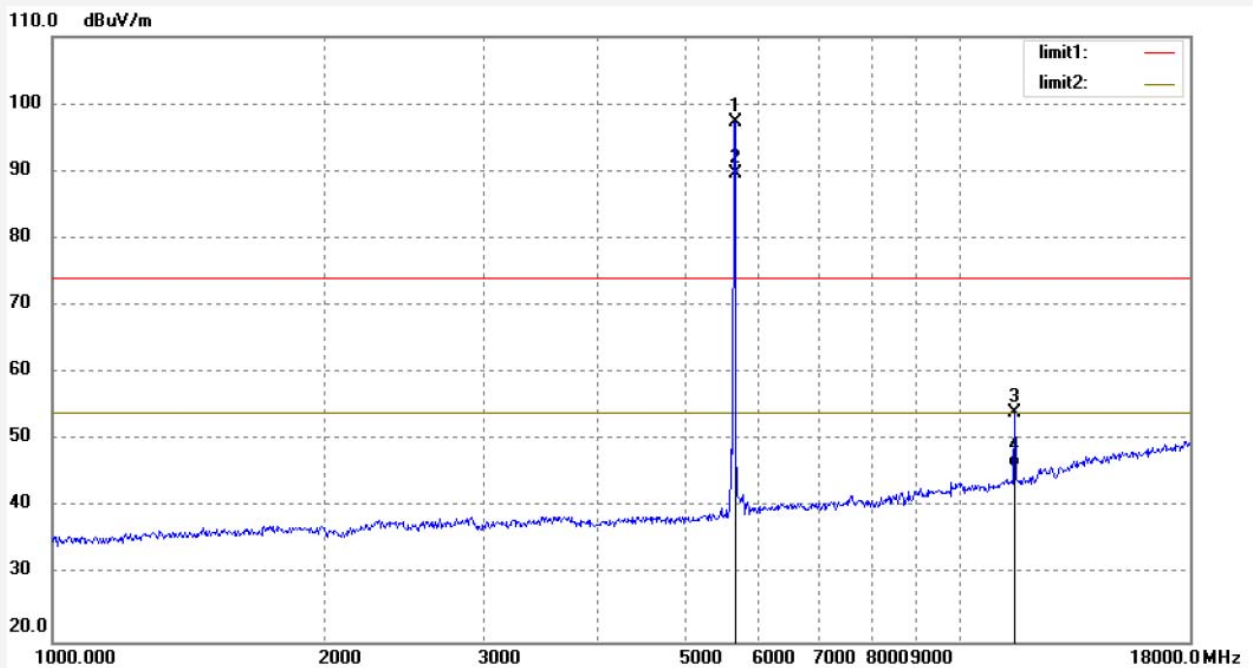

No.	Freq. (MHz)	Reading (dBuV/m)	Factor (dB)	Result (dBuV/m)	Limit (dBuV/m)	Margin (dB)	Detector	Height (cm)	Degree (deg.)	Remark
1	5762.424	97.70	-0.49	97.21			peak	250	48	
2	5762.424	90.15	-0.49	89.66			AVG	250	201	
3	11524.866	47.58	6.59	54.17	74.00	-19.83	peak	250	256	
4	11524.866	39.45	6.59	46.04	54.00	-7.96	AVG	250	198	

Job No.: frank2018 #1947	Polarization: Vertical
Standard: FCC PK	Power Source: AC 120V/60Hz
Test item: Radiation Test	Date: 2018/10/22
Temp.(C)/Hum.(%) 25 C / 55 %	Time: 16:11:04
EUT: Super Hub	Engineer Signature:
Mode: TX 5762MHz	Distance:
Model: SHB2	
Manufacturer: Questyle Audio Technology Co.,Ltd	

Note: Report NO.:ATE20181773

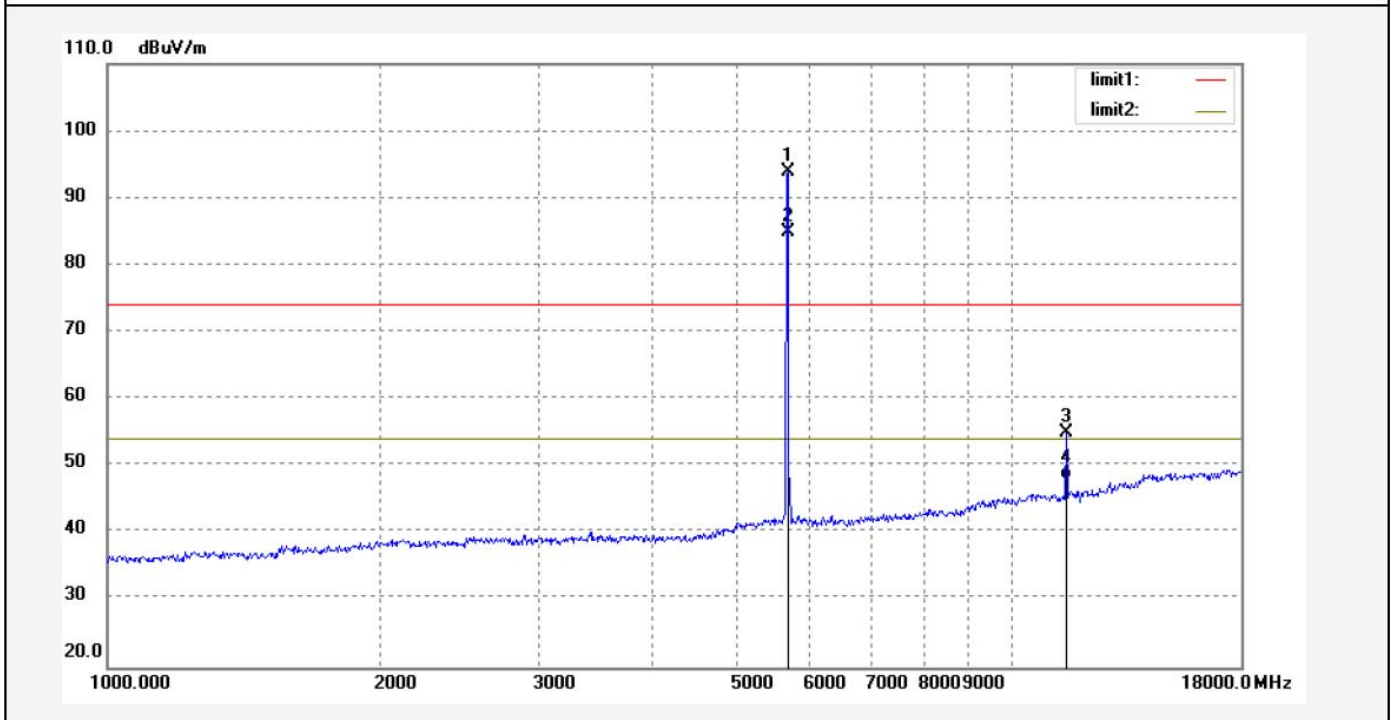

No.	Freq. (MHz)	Reading (dBuV/m)	Factor (dB)	Result (dBuV/m)	Limit (dBuV/m)	Margin (dB)	Detector	Height (cm)	Degree (deg.)	Remark
1	5762.424	94.39	-0.49	93.90			peak	150	87	
2	5762.424	85.48	-0.49	84.99			AVG	150	68	
3	11524.866	48.45	6.59	55.04	74.00	-18.96	peak	150	155	
4	11524.866	41.48	6.59	48.07	54.00	-5.93	AVG	150	302	



ACCURATE TECHNOLOGY CO., LTD.

F1,Bldg,A,Changyuan New Material Port Keyuan Rd,
Science & Industry Park,Nanshan Shenzhen,P.R.China

Site: 1# Chamber
Tel:+86-0755-26503290
Fax:+86-0755-26503396

Job No.: frank2018 #1949

Standard: FCC PK

Test item: Radiation Test

Temp.(C)/Hum.(%) 25 C / 55 %

EUT: Super Hub

Mode: TX 5814MHz

Model: SHB2

Manufacturer: Questyle Audio Technology Co.,Ltd

Polarization: Horizontal

Power Source: AC 120V/60Hz

Date: 2018/10/22

Time: 16:16:30

Engineer Signature:

Distance:

Note: Report NO.:ATE20181773

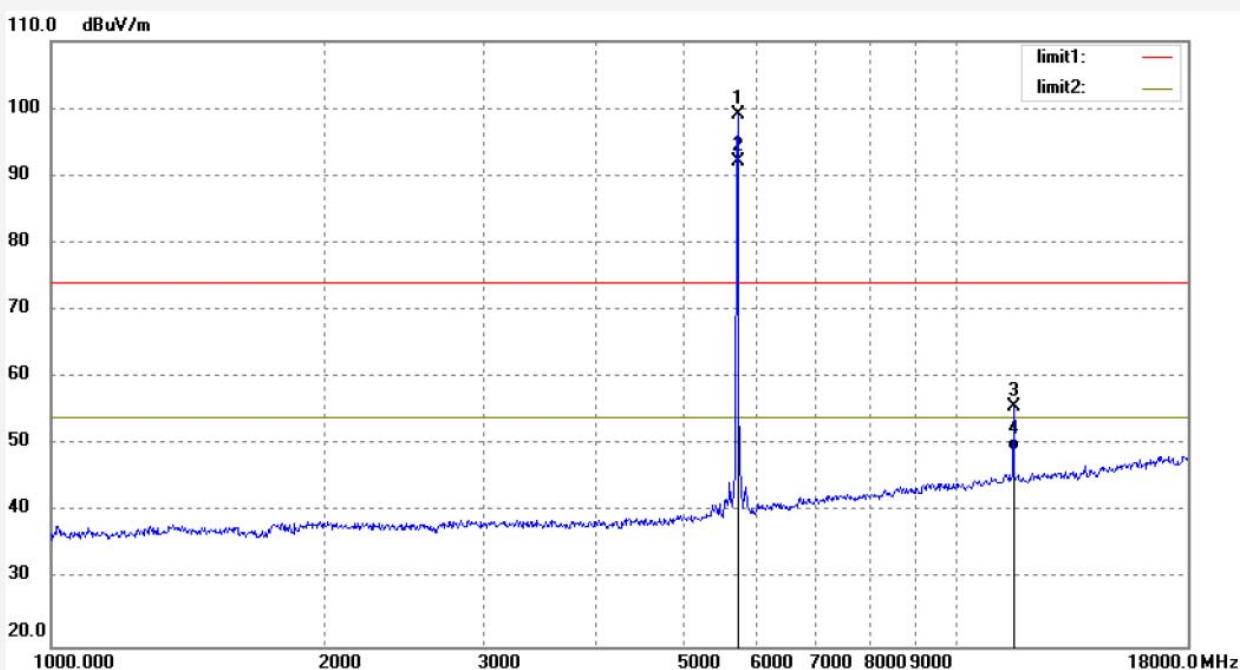

No.	Freq. (MHz)	Reading (dBuV/m)	Factor (dB)	Result (dBuV/m)	Limit (dBuV/m)	Margin (dB)	Detector	Height (cm)	Degree (deg.)	Remark
1	5814.200	99.48	-0.37	99.11			peak	250	110	
2	5814.200	92.45	-0.37	92.08			AVG	250	56	
3	11628.479	49.08	6.64	55.72	74.00	-18.28	peak	250	112	
4	11628.479	42.48	6.64	49.12	54.00	-4.88	AVG	250	320	

Job No.: frank2018 #1950

Standard: FCC PK

Test item: Radiation Test

Temp.(C)/Hum.(%) 25 C / 55 %

EUT: Super Hub

Mode: TX 5814MHz

Model: SHB2

Manufacturer: Questyle Audio Technology Co.,Ltd

Polarization: Vertical

Power Source: AC 120V/60Hz

Date: 2018/10/22

Time: 16:17:38

Engineer Signature:

Distance:

Note: Report NO.:ATE20181773

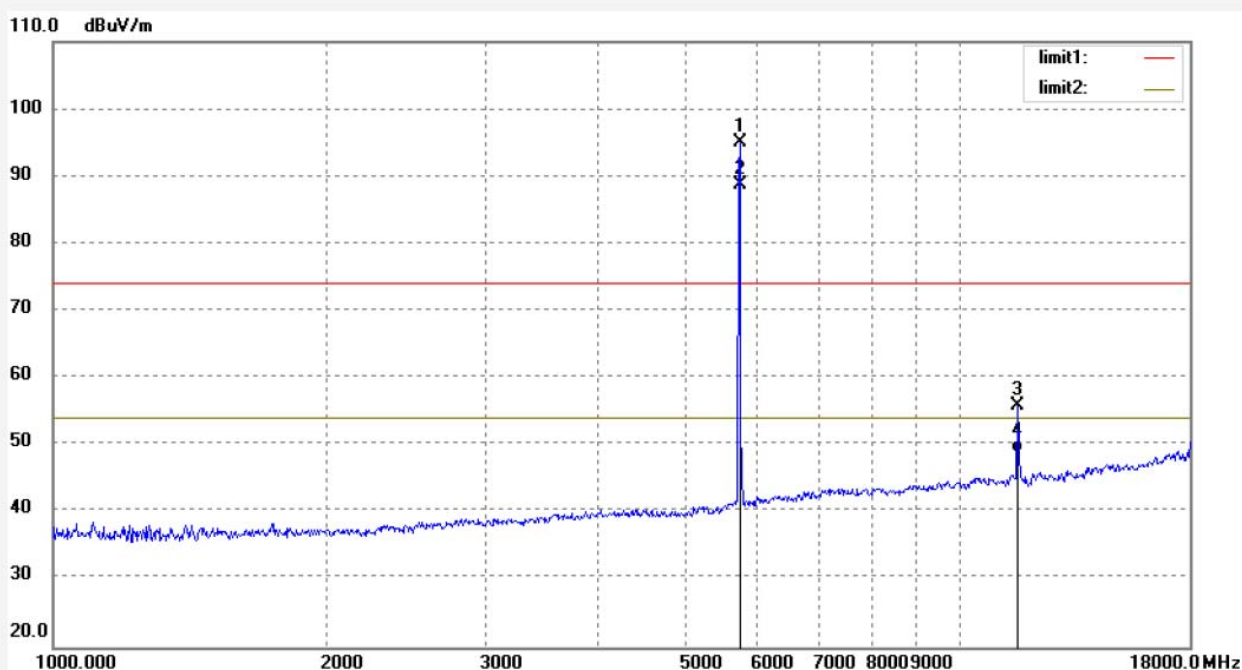

No.	Freq. (MHz)	Reading (dBuV/m)	Factor (dB)	Result (dBuV/m)	Limit (dBuV/m)	Margin (dB)	Detector	Height (cm)	Degree (deg.)	Remark
1	5814.200	95.30	-0.37	94.93			peak	150	85	
2	5814.200	89.15	-0.37	88.78			AVG	150	48	
3	11628.479	49.26	6.71	55.97	74.00	-18.03	peak	150	112	
4	11628.479	42.12	6.71	48.83	54.00	-5.17	AVG	150	106	

18GHz -26.5GHz test data

ACCURATE TECHNOLOGY CO., LTD.

 F1,Bldg,A,Changyuan New Material Port Keyuan Rd,
 Science & Industry Park,Nanshan Shenzhen,P.R.China

Site: 2# Chamber

Tel:+86-0755-26503290

Fax:+86-0755-26503396

Job No.: LGW2018 #1846

Standard: FCC 15.247 3M Radiated

Test item: Radiation Test

Temp.(C)/Hum.(%) 23 C / 48 %

EUT: Super Hub

Mode: TX 5736MHz

Model: SHB2

Manufacturer: Questyle Audio Technology Co.,Ltd.

Polarization: Horizontal

Power Source: AC 120V/60Hz

Date: 2018/10/22

Time: 16:20:38

Engineer Signature: WADE

Distance: 3m

Note: Report NO.:ATE20181773

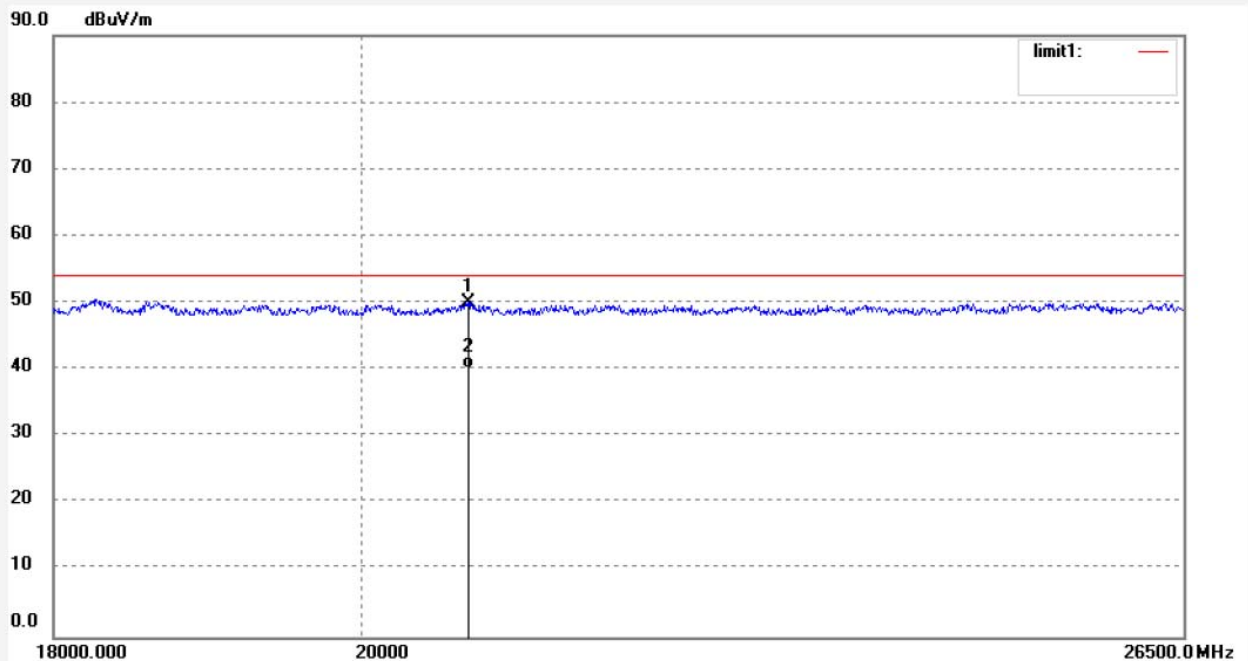

No.	Freq. (MHz)	Reading (dBuV/m)	Factor (dB)	Result (dBuV/m)	Limit (dBuV/m)	Margin (dB)	Detector	Height (cm)	Degree (deg.)	Remark
1	20745.253	11.73	38.33	50.06	54.00	-3.94	peak			
2	20745.253	1.88	38.33	40.21	54.00	-13.79	AVG			



ACCURATE TECHNOLOGY CO., LTD.

F1,Bldg,A,Changyuan New Material Port Keyuan Rd,
Science & Industry Park,Nanshan Shenzhen,P.R.China

Site: 2# Chamber
Tel:+86-0755-26503290
Fax:+86-0755-26503396

Job No.: LGW2018 #1847	Polarization: Vertical
Standard: FCC 15.247 3M Radiated	Power Source: AC 120V/60Hz
Test item: Radiation Test	Date: 2018/10/22
Temp.(C)/Hum.(%) 23 C / 48 %	Time: 16:25:12
EUT: Super Hub	Engineer Signature: WADE
Mode: TX 5736MHz	Distance: 3m
Model: SHB2	
Manufacturer: Questyle Audio Technology Co.,Ltd.	

Note: Report NO.:ATE20181773

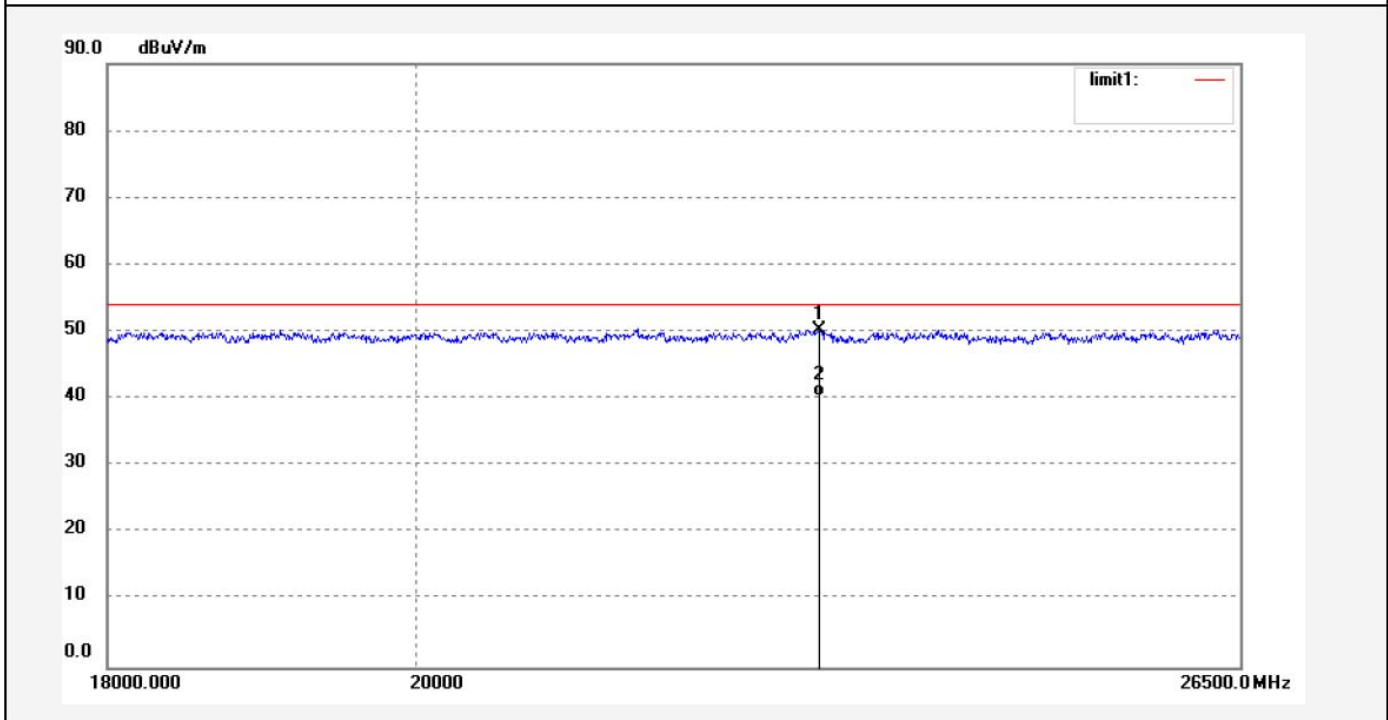

No.	Freq. (MHz)	Reading (dBuV/m)	Factor (dB)	Result (dBuV/m)	Limit (dBuV/m)	Margin (dB)	Detector	Height (cm)	Degree (deg.)	Remark
1	22948.789	10.58	39.78	50.36	54.00	-3.64	peak			
2	22948.789	0.54	39.78	40.32	54.00	-13.68	AVG			



ACCURATE TECHNOLOGY CO., LTD.

F1,Bldg,A,Changyuan New Material Port Keyuan Rd,
Science & Industry Park,Nanshan Shenzhen,P.R.China

Site: 2# Chamber
Tel:+86-0755-26503290
Fax:+86-0755-26503396

Job No.: LGW2018 #1849	Polarization: Horizontal
Standard: FCC 15.247 3M Radiated	Power Source: AC 120V/60Hz
Test item: Radiation Test	Date: 2018/10/22
Temp.(C)/Hum.(%) 23 C / 48 %	Time: 16:34:35
EUT: Super Hub	Engineer Signature: WADE
Mode: TX 5762MHz	Distance: 3m
Model: SHB2	
Manufacturer: Questyle Audio Technology Co.,Ltd.	

Note: Report NO.:ATE20181773

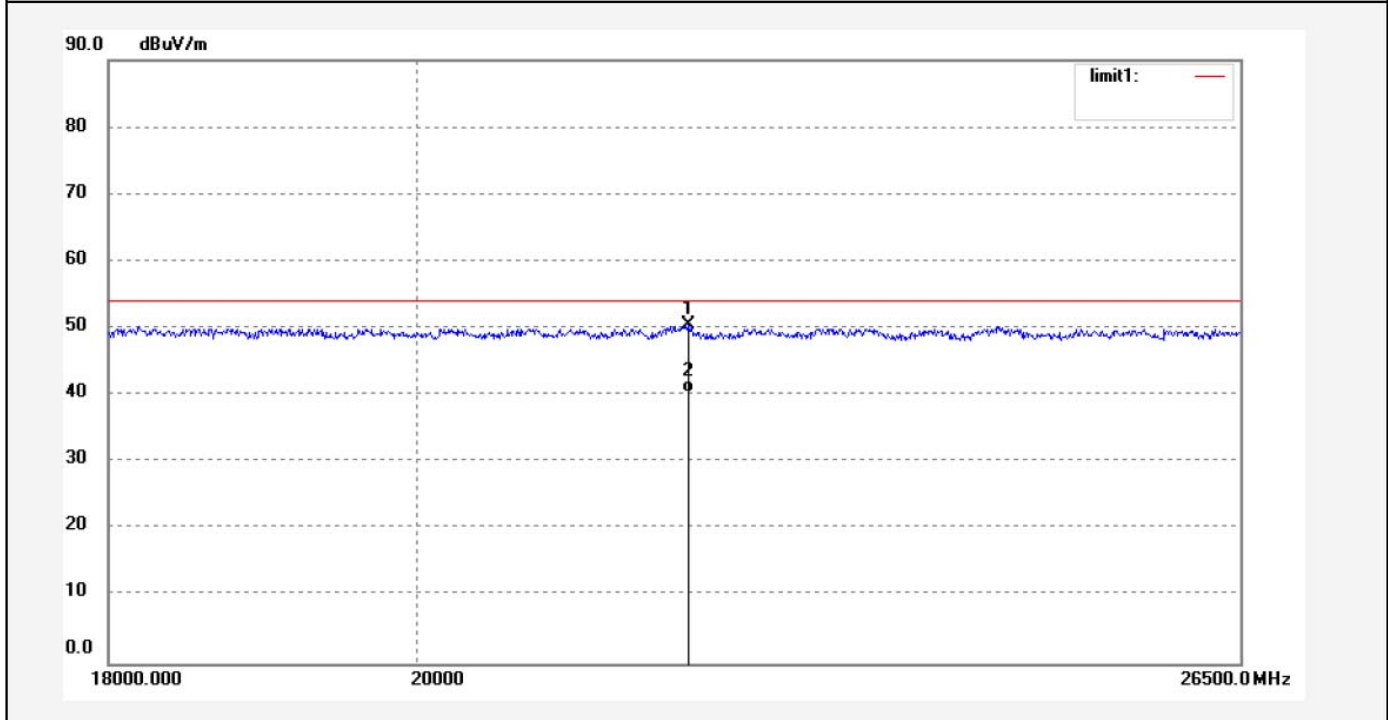

No.	Freq. (MHz)	Reading (dBuV/m)	Factor (dB)	Result (dBuV/m)	Limit (dBuV/m)	Margin (dB)	Detector	Height (cm)	Degree (deg.)	Remark
1	21941.932	11.11	39.30	50.41	54.00	-3.59	peak			
2	21941.932	1.06	39.30	40.36	54.00	-13.64	AVG			

Job No.: LGW2018 #1848

Standard: FCC 15.247 3M Radiated

Test item: Radiation Test

Temp.(C)/Hum.(%) 23 C / 48 %

EUT: Super Hub

Mode: TX 5762MHz

Model: SHB2

Manufacturer: Questyle Audio Technology Co.,Ltd.

Polarization: Vertical

Power Source: AC 120V/60Hz

Date: 2018/10/22

Time: 16:29:17

Engineer Signature: WADE

Distance: 3m

Note: Report NO.:ATE20181773

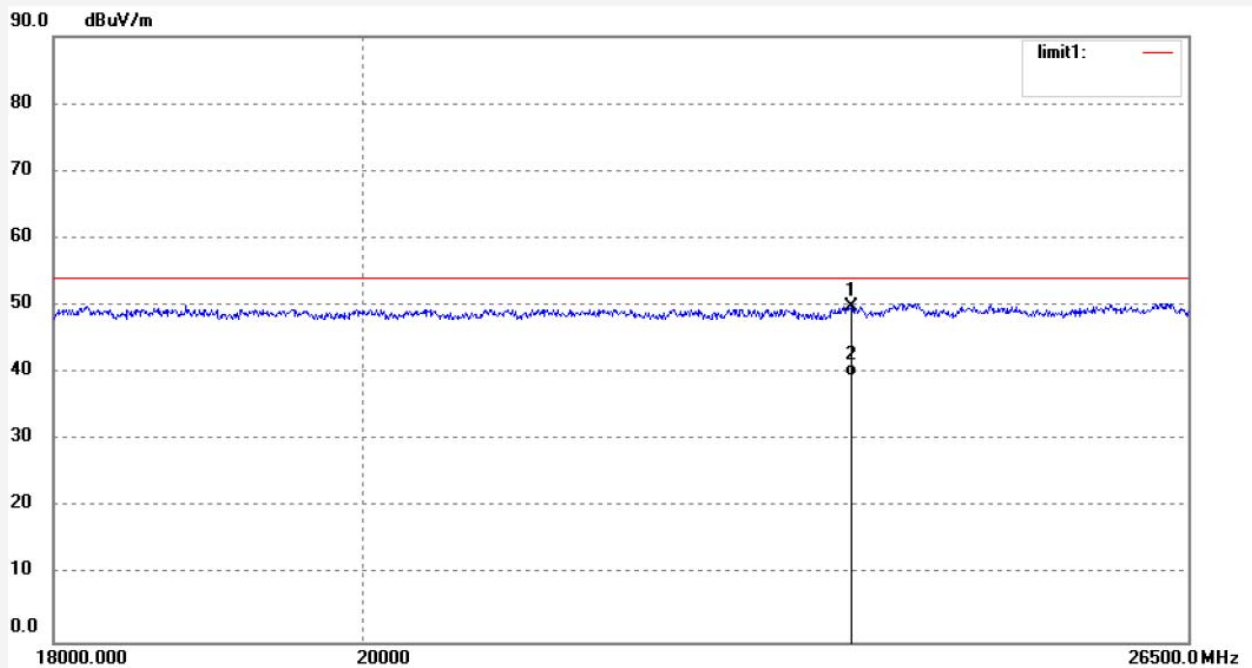

No.	Freq. (MHz)	Reading (dBuV/m)	Factor (dB)	Result (dBuV/m)	Limit (dBuV/m)	Margin (dB)	Detector	Height (cm)	Degree (deg.)	Remark
1	23624.237	10.12	39.69	49.81	54.00	-4.19	peak			
2	23624.237	-0.12	39.69	39.57	54.00	-14.43	AVG			



ACCURATE TECHNOLOGY CO., LTD.

F1,Bldg,A,Changyuan New Material Port Keyuan Rd,
Science & Industry Park,Nanshan Shenzhen,P.R.China

Site: 2# Chamber
Tel:+86-0755-26503290
Fax:+86-0755-26503396

Job No.: LGW2018 #1850	Polarization: Horizontal
Standard: FCC 15.247 3M Radiated	Power Source: AC 120V/60Hz
Test item: Radiation Test	Date: 2018/10/22
Temp.(C)/Hum.(%) 23 C / 48 %	Time: 16:42:41
EUT: Super Hub	Engineer Signature: WADE
Mode: TX 5814MHz	Distance: 3m
Model: SHB2	
Manufacturer: Questyle Audio Technology Co.,Ltd.	

Note: Report NO.:ATE20181773

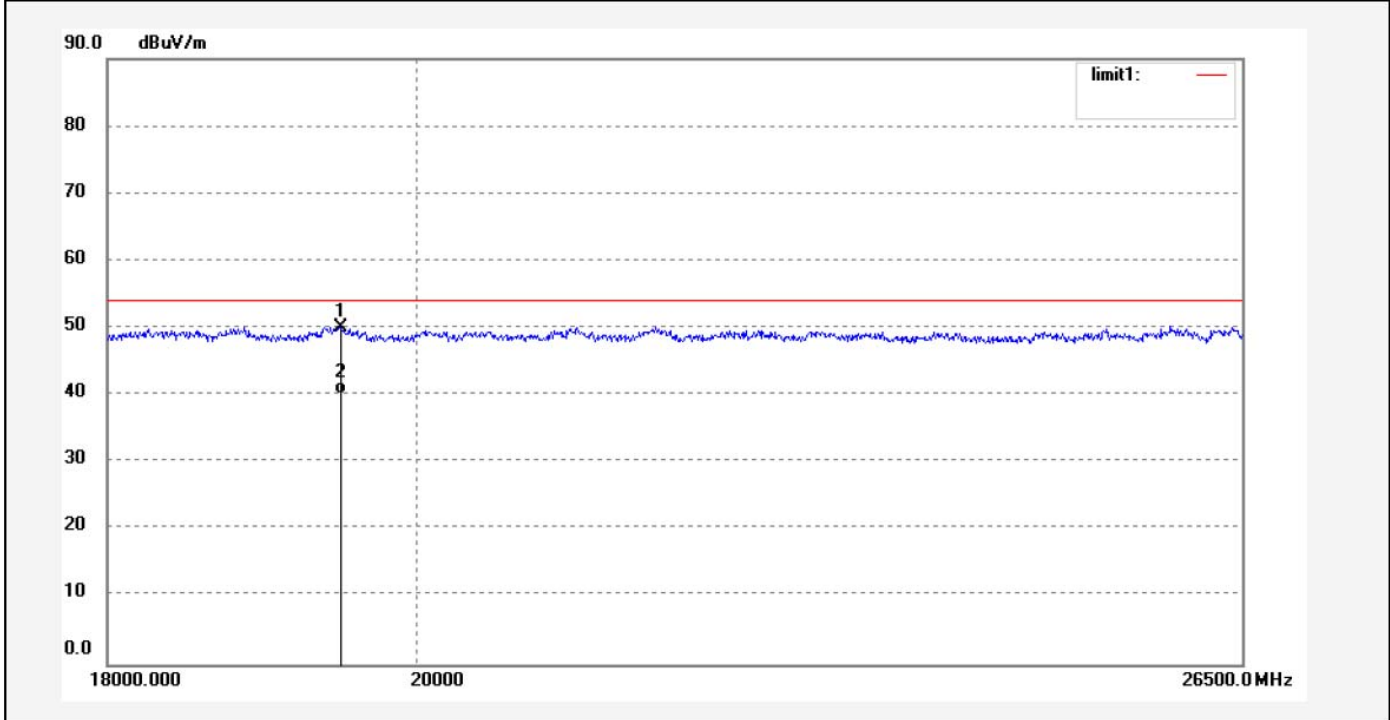

No.	Freq. (MHz)	Reading (dBuV/m)	Factor (dB)	Result (dBuV/m)	Limit (dBuV/m)	Margin (dB)	Detector	Height (cm)	Degree (deg.)	Remark
1	19492.836	12.33	37.69	50.02	54.00	-3.98	peak			
2	19492.836	2.52	37.69	40.21	54.00	-13.79	AVG			



ACCURATE TECHNOLOGY CO., LTD.

F1,Bldg.A,Changyuan New Material Port Keyuan Rd,
Science & Industry Park,Nanshan Shenzhen,P.R.China

Site: 2# Chamber
Tel:+86-0755-26503290
Fax:+86-0755-26503396

Job No.: LGW2018 #1851	Polarization: Vertical
Standard: FCC 15.247 3M Radiated	Power Source: AC 120V/60Hz
Test item: Radiation Test	Date: 2018/10/22
Temp.(C)/Hum.(%) 23 C / 48 %	Time: 16:47:13
EUT: Super Hub	Engineer Signature: WADE
Mode: TX 5814MHz	Distance: 3m
Model: SHB2	
Manufacturer: Questyle Audio Technology Co.,Ltd.	

Note: Report NO.:ATE20181773

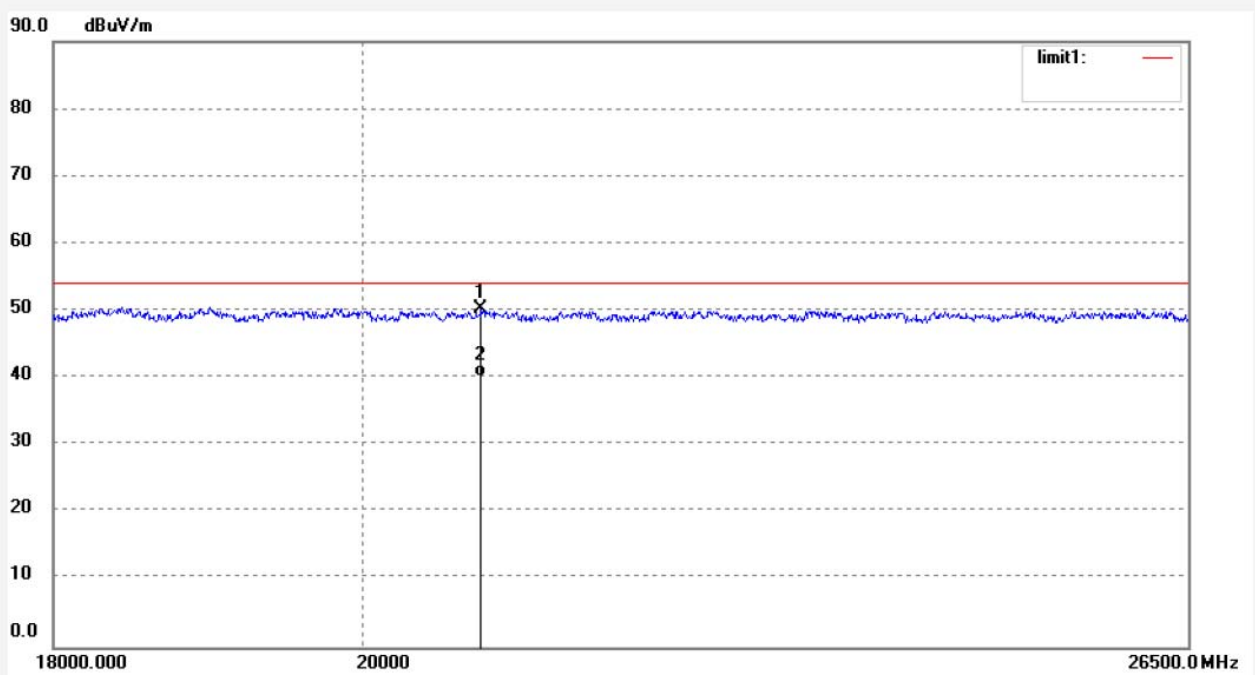

No.	Freq. (MHz)	Reading (dBuV/m)	Factor (dB)	Result (dBuV/m)	Limit (dBuV/m)	Margin (dB)	Detector	Height (cm)	Degree (deg.)	Remark
1	20825.645	11.29	39.01	50.30	54.00	-3.70	peak			
2	20825.645	1.24	39.01	40.25	54.00	-13.75	AVG			

18GHz -26.5GHz test data

Test mode: 5736MHz TX

The EUT is tested radiation emission at each test mode in three axes. Besides, I tested the state of the two antennas being launched separately. The worst emissions are reflected in the following plots

Common Information

Test Site:

Environment Conditions:

Antenna Polarization: Horizontal

Operator Name:

Comment:

Copy of FCC Electric Field Strength 26.5-40GHz

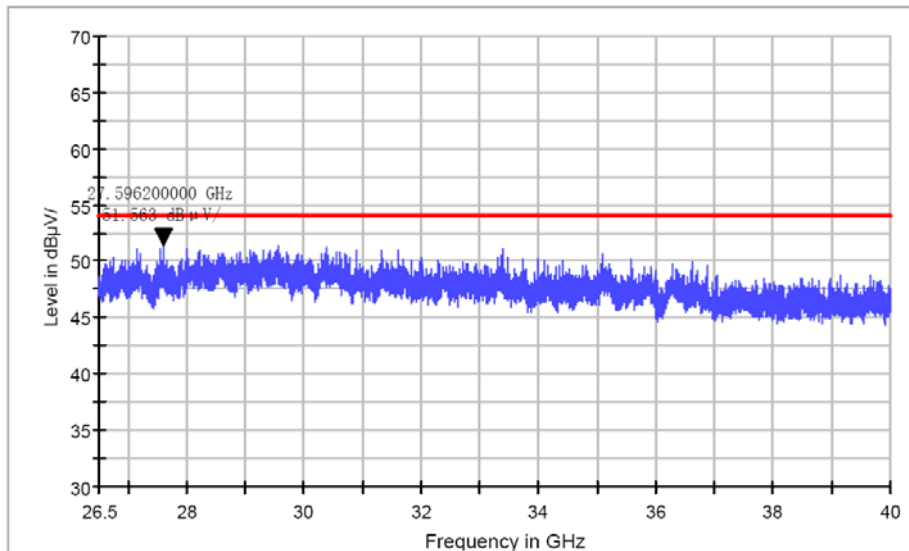

Common Information

Test Site:

Environment Conditions:

Antenna Polarization: Vertical

Operator Name:

Comment:

Copy of FCC Electric Field Strength 26.5-40GHz

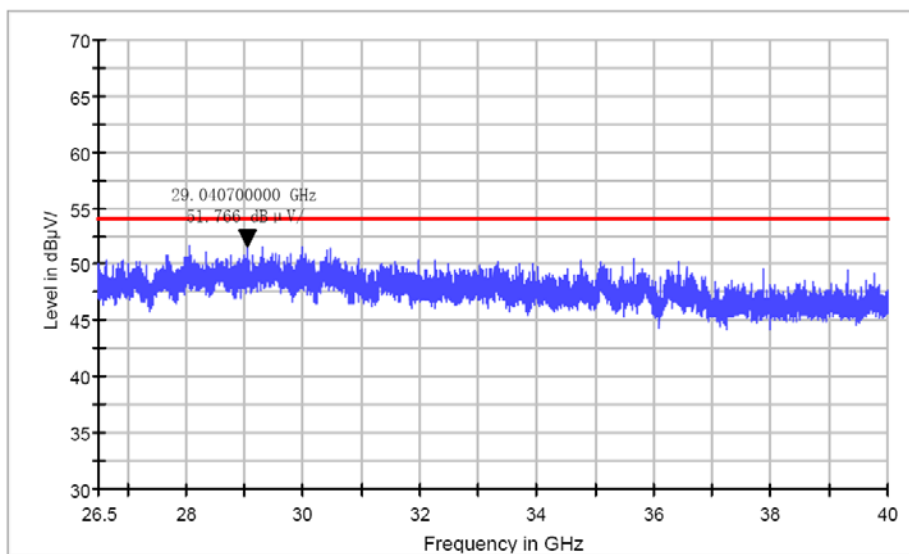

Test mode: 5762MHz TX

The EUT is tested radiation emission at each test mode in three axes. Besides, I tested the state of the two antennas being launched separately. The worst emissions are reflected in the following plots

Common Information

Test Site:
Environment Conditions:
Antenna Polarization: Horizontal
Operator Name:
Comment:

Copy of FCC Electric Field Strength 26.5-40GHz

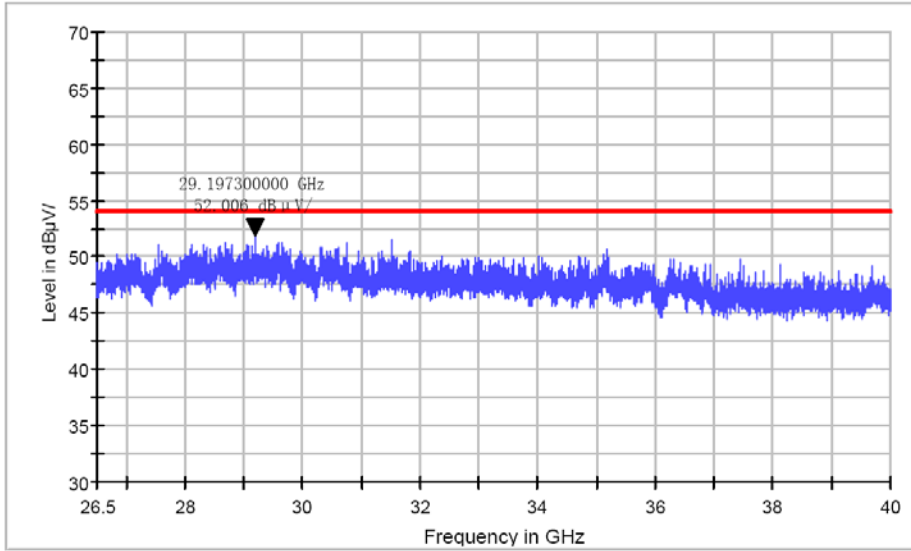

Common Information

Test Site:
Environment Conditions:
Antenna Polarization: Vertical
Operator Name:
Comment:

Copy of FCC Electric Field Strength 26.5-40GHz

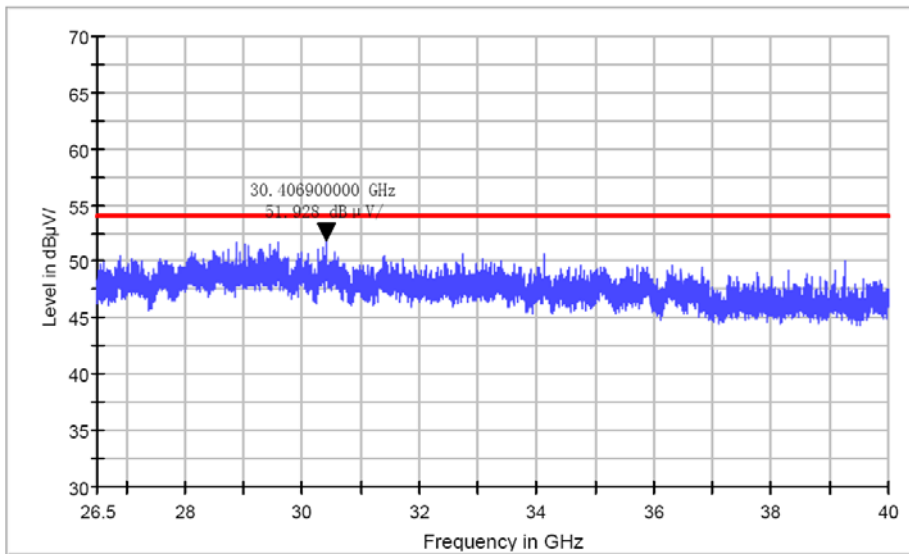

Test mode: 5814MHz TX

The EUT is tested radiation emission at each test mode in three axes. Besides, I tested the state of the two antennas being launched separately. The worst emissions are reflected in the following plots

Common Information

Test Site:
Environment Conditions:
Antenna Polarization: Horizontal
Operator Name:
Comment:

Copy of FCC Electric Field Strength 26.5-40GHz

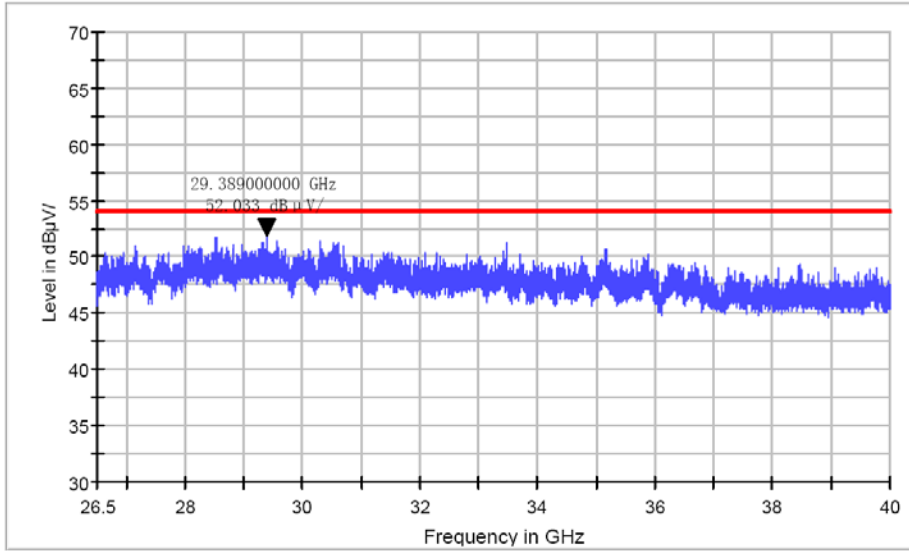
**Common Information**

Test Site:
Environment Conditions:
Antenna Polarization: Vertical
Operator Name:
Comment:

Copy of FCC Electric Field Strength 26.5-40GHz

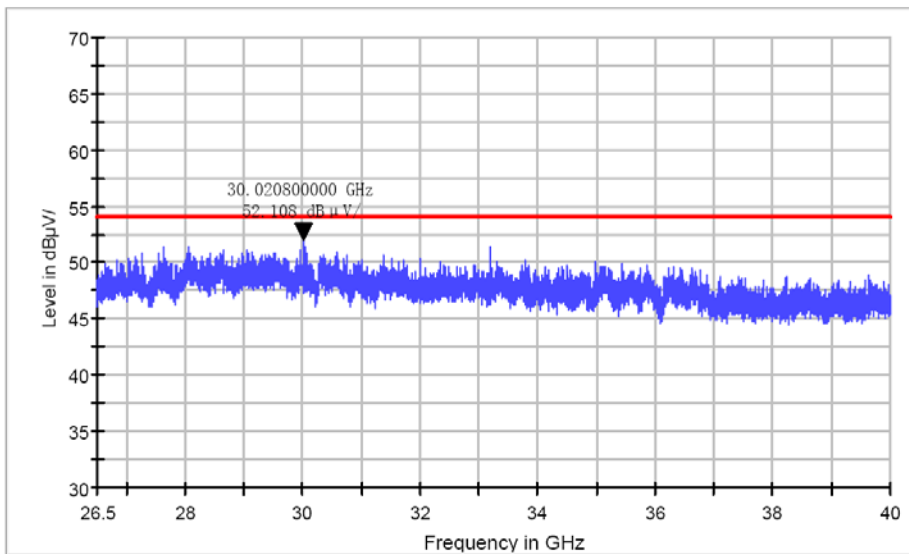

11. BAND EDGE COMPLIANCE TEST

11.1. Block Diagram of Test Setup

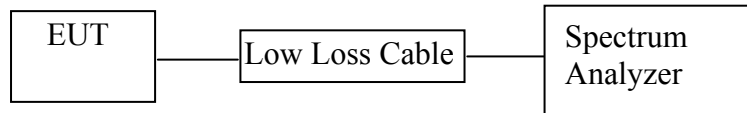

(EUT: Super Hub)

11.2. The Requirement For Section 15.247(d)

Section 15.247(d): In any 100 kHz bandwidth outside the frequency band in which the spread spectrum or digitally modulated intentional radiator is operating, the radio frequency power that is produced by the intentional radiator shall be at least 20 dB below that in the 100 kHz bandwidth within the band that contains the highest level of the desired power, based on either an RF conducted or a radiated measurement, provided the transmitter demonstrates compliance with the peak conducted power limits. If the transmitter complies with the conducted power limits based on the use of RMS averaging over a time interval, as permitted under paragraph (b)(3) of this section, the attenuation required under this paragraph shall be 30 dB instead of 20 dB. Attenuation below the general limits specified in Section 15.209(a) is not required. In addition, radiated emissions which fall in the restricted bands, as defined in Section 15.205(a), must also comply with the radiated emission limits specified in Section 15.209(a).

11.3. EUT Configuration on Measurement

The equipment are installed on the emission Measurement to meet the commission requirements and operating regulations in a manner which tends to maximize its emission characteristics in normal application.

11.4. Operating Condition of EUT

11.4.1. Setup the EUT and simulator as shown as Section 11.1.

11.4.2. Turn on the power of all equipment.

11.4.3. Let the EUT work in TX modes measure it. The transmit frequency are 5736-5814MHz. We select 5736MHz, 5814MHz TX frequency to transmit.

11.5. Test Procedure

Conducted Band Edge:

11.5.1. The transmitter output was connected to the spectrum analyzer via a low loss cable.

11.5.2. Set RBW of spectrum analyzer to 1000kHz and VBW to 3000kHz.

Radiate Band Edge:

11.5.3. The EUT is placed on a turntable, which is 0.8m above the ground plane and worked at highest radiated power.

11.5.4. The turntable was rotated for 360 degrees to determine the position of maximum emission level.

11.5.5. EUT is set 3m away from the receiving antenna, which is varied from 1m to 4m to find out the highest emission.

11.5.6. Set the spectrum analyzer in the following setting in order to capture the lower and upper band-edges of the emission:

11.5.7. RBW=1MHz, VBW=3MHz

11.5.8. The band edges was measured and recorded.

11.6. Test Result

PASS

Antenna A test plot

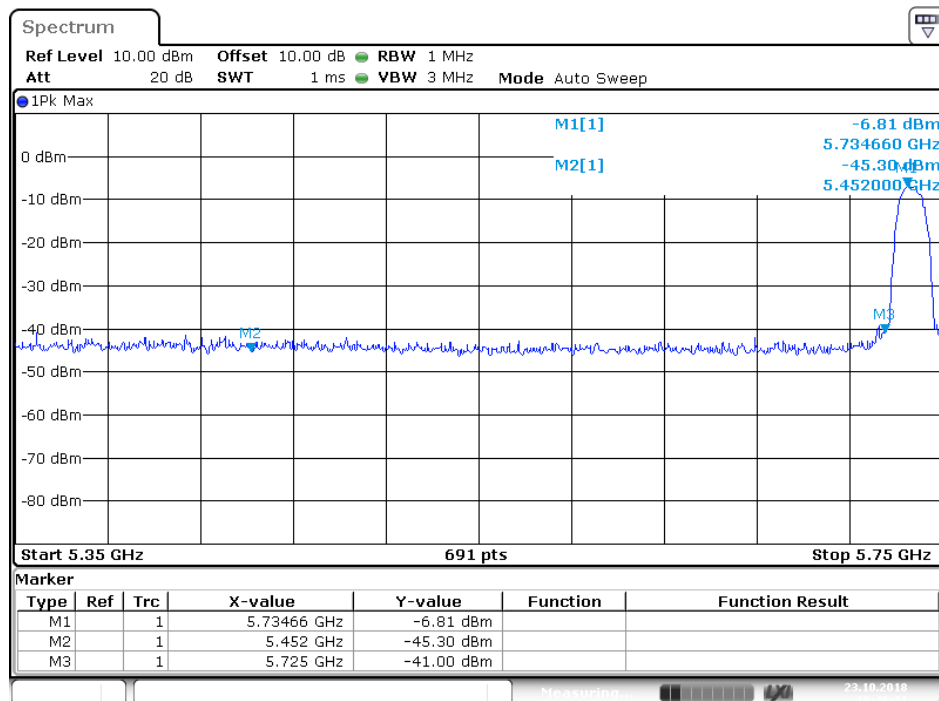
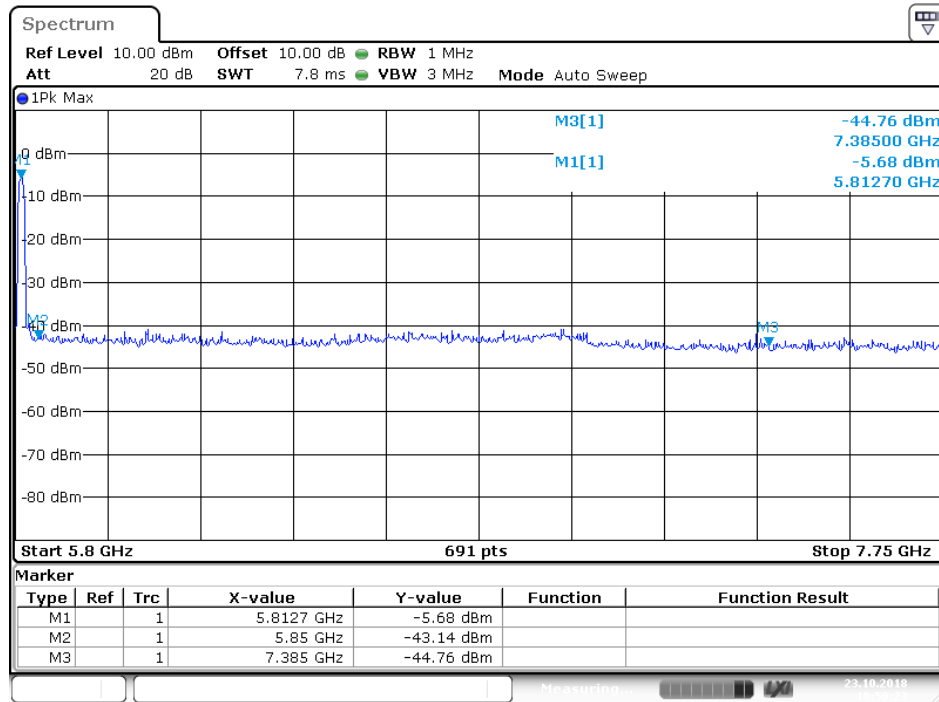

Antenna B test plot

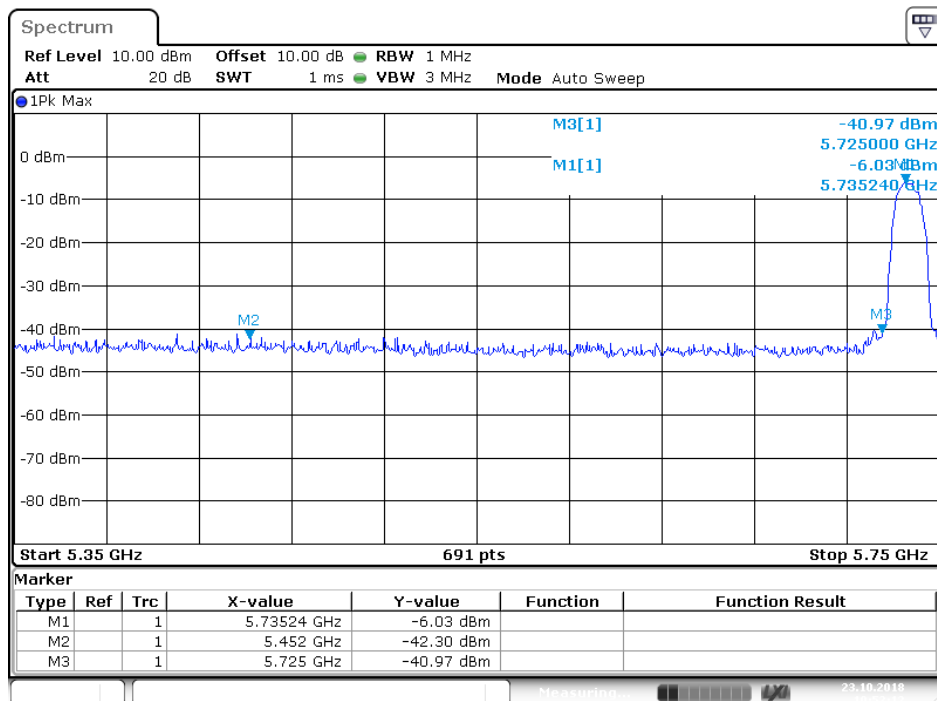
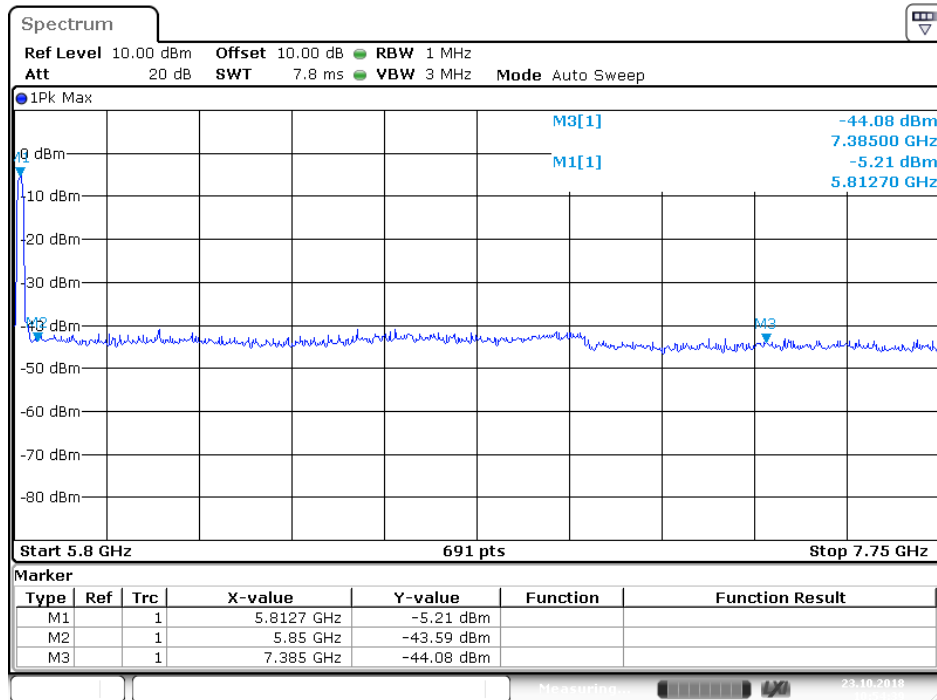

Radiated Band Edge Result

Note:

1. Emissions attenuated more than 20 dB below the permissible value are not reported.
2. we tested radiated band edge of Antenna A and Antenna B, The following test data is the worst case(Antenna B) data which I have recorded
2. The field strength is calculated by adding the antenna factor, high pass filter loss(if used) and cable loss, and subtracting the amplifier gain(if any)from the measured reading. The basic equation calculation is as follows:

Result = Reading + Corrected Factor



ACCURATE TECHNOLOGY CO., LTD.

F1,Bldg,A,Changyuan New Material Port Keyuan Rd,
Science & Industry Park,Nanshan Shenzhen,P.R.China

Site: 1# Chamber

Tel:+86-0755-26503290

Fax:+86-0755-26503396

Job No.: frank2018 #1952	Polarization: Horizontal
Standard: FCC PK	Power Source: AC 120V/60Hz
Test item: Radiation Test	Date: 2018/10/22
Temp.(C)/Hum.(%) 25 C / 55 %	Time: 16:21:54
EUT: Super Hub	Engineer Signature:
Mode: TX 5736MHz	Distance: 3m
Model: SHB2	
Manufacturer: Questyle Audio Technology Co.,Ltd	

Note: Report NO.:ATE20181773

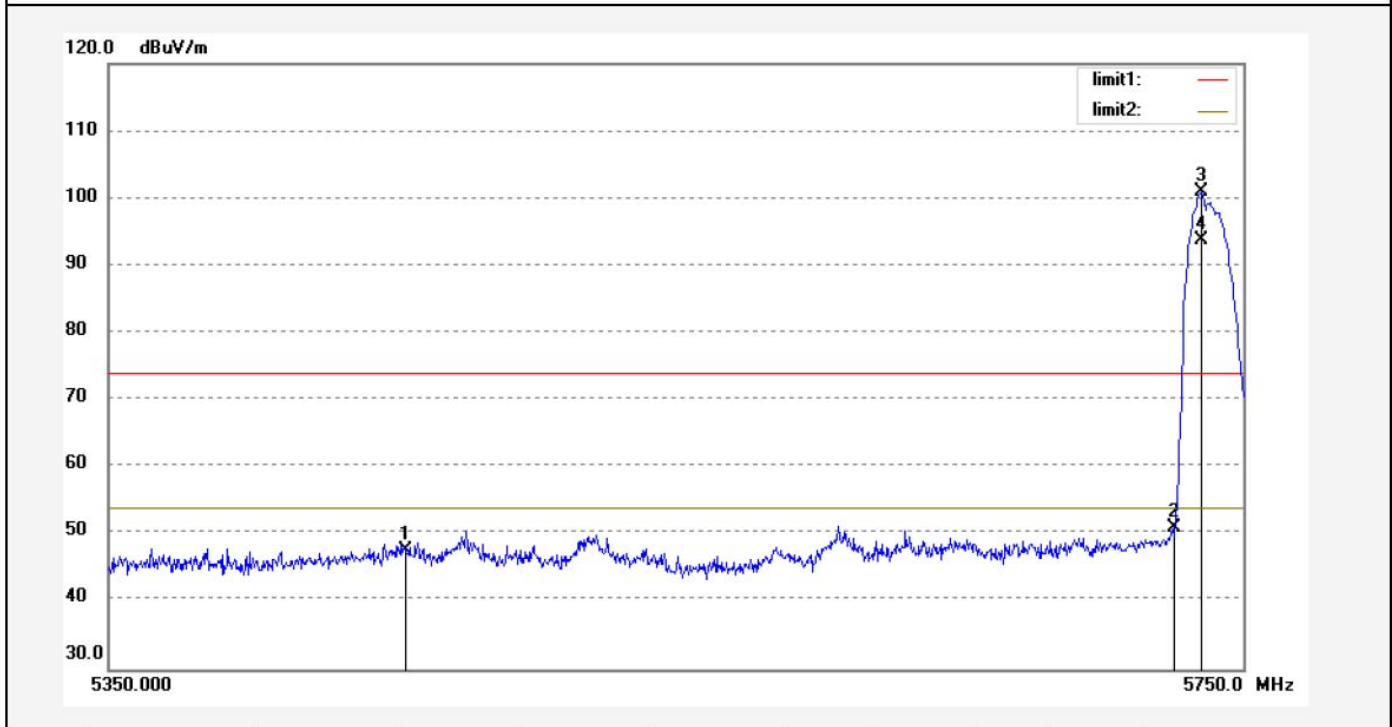

No.	Freq. (MHz)	Reading (dBuV/m)	Factor (dB)	Result (dBuV/m)	Limit (dBuV/m)	Margin (dB)	Detector	Height (cm)	Degree (deg.)	Remark
1	5452.000	48.64	-0.88	47.76	74.00	-26.24	peak	250	251	
2	5725.000	51.32	-0.38	50.94	74.00	-23.06	peak	250	201	
3	5736.064	101.32	-0.36	100.96	74.00	26.96	peak	250	330	
4	5736.064	94.15	-0.36	93.79	74.00	19.79	AVG	250	195	

Note: Average measurement with peak detection at No.4

Job No.: frank2018 #1951	Polarization: Vertical
Standard: FCC PK	Power Source: AC 120V/60Hz
Test item: Radiation Test	Date: 2018/10/22
Temp.(C)/Hum.(%) 25 C / 55 %	Time: 16:19:54
EUT: Super Hub	Engineer Signature:
Mode: TX 5736MHz	Distance: 3m
Model: SHB2	
Manufacturer: Questyle Audio Technology Co.,Ltd	

Note: Report NO.:ATE20181773

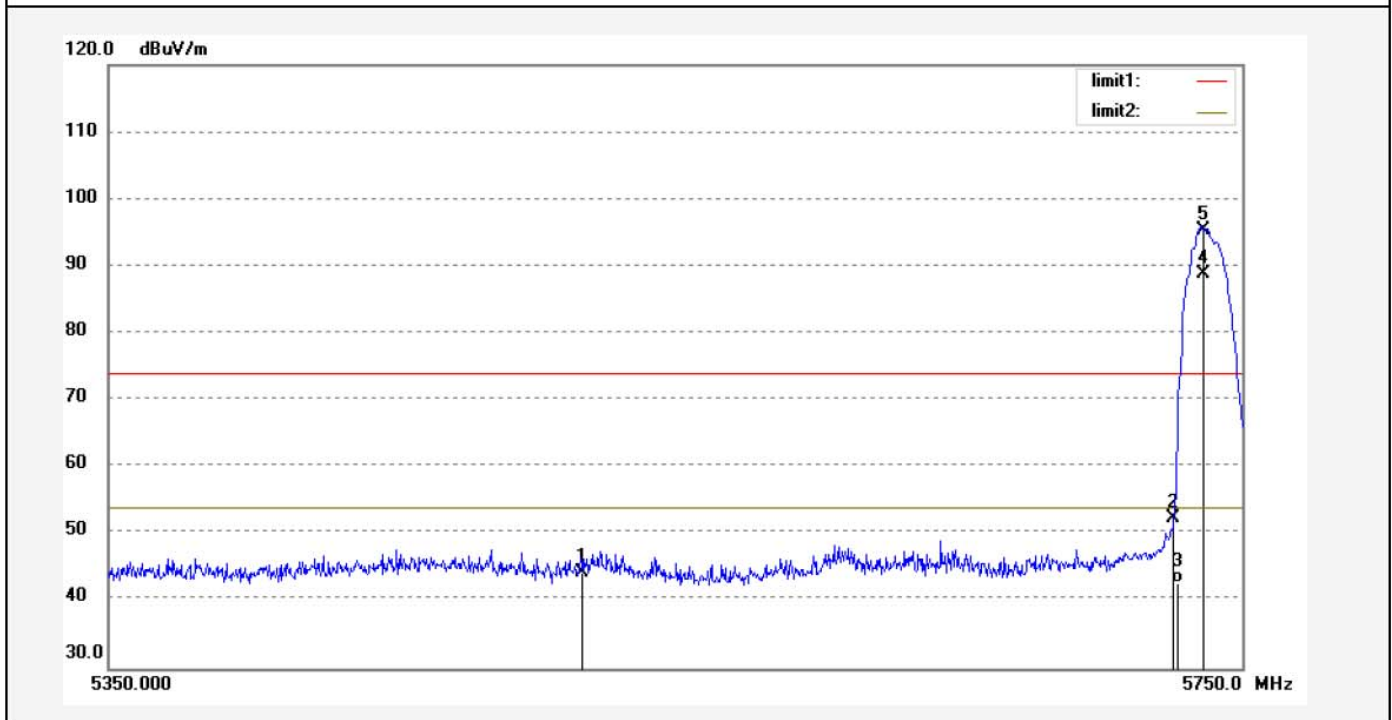

No.	Freq. (MHz)	Reading (dBuV/m)	Factor (dB)	Result (dBuV/m)	Limit (dBuV/m)	Margin (dB)	Detector	Height (cm)	Degree (deg.)	Remark
1	5514.000	45.18	-0.78	44.40	74.00	-29.60	peak	150	201	
2	5725.000	52.70	-0.38	52.32	74.00	-21.68	peak	150	189	
3	5725.000	43.15	-0.38	42.77	54.00	-11.23	AVG	150	52	
4	5736.000	89.15	-0.36	88.79			AVG	150	154	
5	5736.000	95.69	-0.36	95.33			peak	150	103	

Note: Average measurement with peak detection at No.3,4

Job No.: frank2018 #1953

Standard: FCC PK

Test item: Radiation Test

Temp.(C)/Hum.(%) 25 C / 55 %

EUT: Super Hub

Mode: TX 5814MHz

Model: SHB2

Manufacturer: Questyle Audio Technology Co.,Ltd

Polarization: Horizontal

Power Source: AC 120V/60Hz

Date: 2018/10/22

Time: 16:24:42

Engineer Signature:

Distance: 3m

Note: Report NO.:ATE20181773

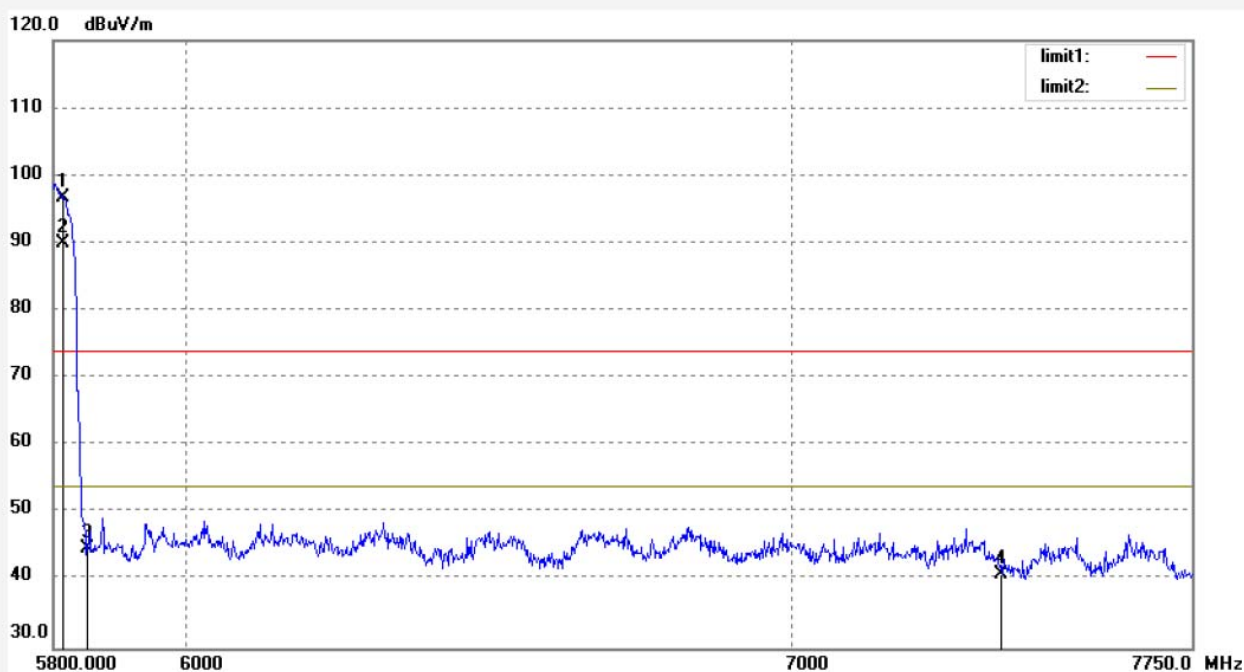

No.	Freq. (MHz)	Reading (dBuV/m)	Factor (dB)	Result (dBuV/m)	Limit (dBuV/m)	Margin (dB)	Detector	Height (cm)	Degree (deg.)	Remark
1	5814.000	97.01	-0.22	96.79			peak	250	302	
2	5814.000	90.15	-0.22	89.93			AVG	250	249	
3	5850.000	44.86	-0.15	44.71	74.00	-29.29	peak	250	208	
4	7385.000	38.53	2.35	40.88	74.00	-33.12	peak	250	69	

Note: Average measurement with peak detection at No.2

Job No.: frank2018 #1954

Standard: FCC PK

Test item: Radiation Test

Temp.(C)/Hum.(%) 25 C / 55 %

EUT: Super Hub

Mode: TX 5814MHz

Model: SHB2

Manufacturer: Questyle Audio Technology Co.,Ltd

Polarization: Vertical

Power Source: AC 120V/60Hz

Date: 2018/10/22

Time: 16:26:04

Engineer Signature:

Distance: 3m

Note: Report NO.:ATE20181773

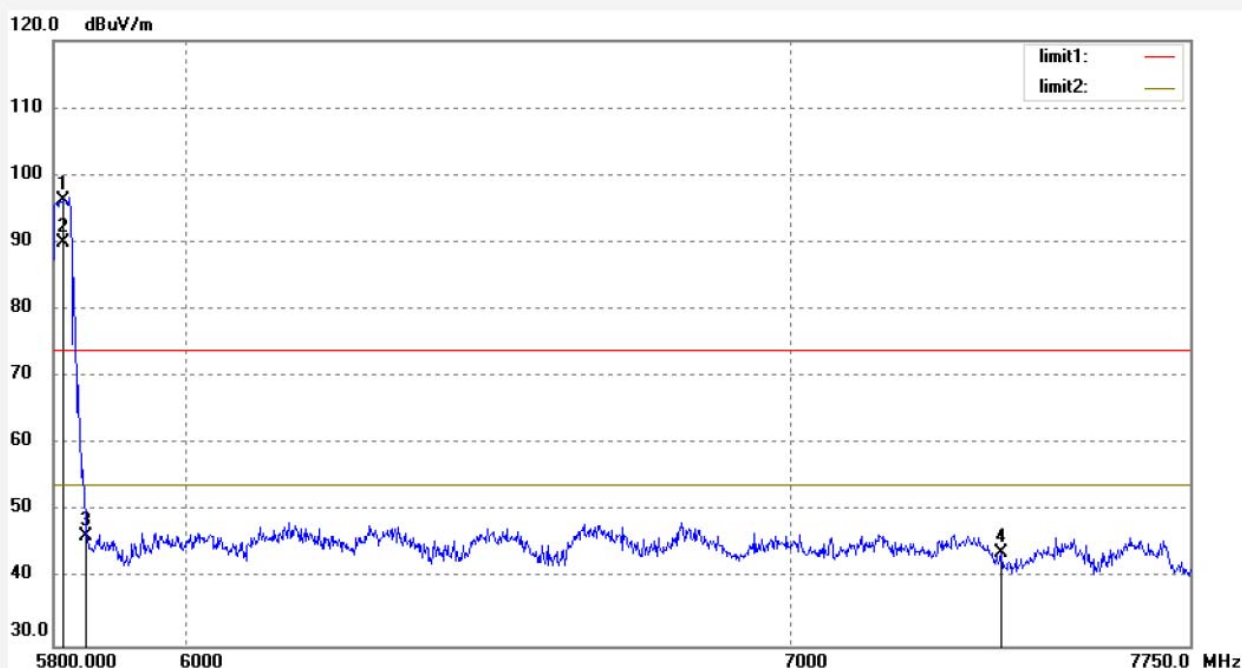

No.	Freq. (MHz)	Reading (dBuV/m)	Factor (dB)	Result (dBuV/m)	Limit (dBuV/m)	Margin (dB)	Detector	Height (cm)	Degree (deg.)	Remark
1	5814.000	96.37	-0.22	96.15			peak	150	344	
2	5814.000	90.12	-0.22	89.90			AVG	150	42	
3	5850.000	46.44	-0.15	46.29	74.00	-27.71	peak	150	88	
4	7385.000	41.47	2.35	43.82	74.00	-30.18	peak	150	109	

Note: Average measurement with peak detection at No.2

12.AC POWER LINE CONDUCTED EMISSION FOR FCC PART

15 SECTION 15.207(A)

12.1.Block Diagram of Test Setup

12.1.1.Shielding Room Test Setup Diagram

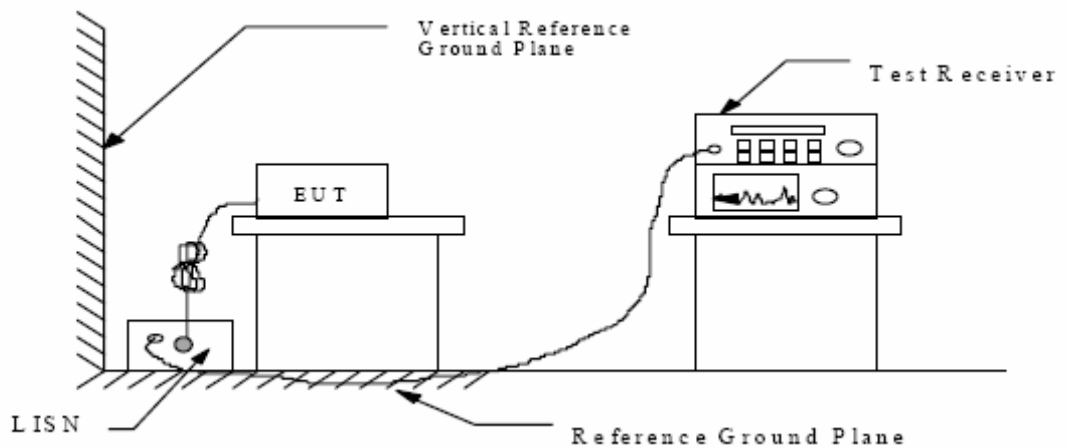

12.2.The Emission Limit

12.2.1.Conducted Emission Measurement Limits According to Section 15.207(a)

Frequency (MHz)	Limit dB(μ V)	
	Quasi-peak Level	Average Level
0.15 - 0.50	66.0 – 56.0 *	56.0 – 46.0 *
0.50 - 5.00	56.0	46.0
5.00 - 30.00	60.0	50.0

* Decreases with the logarithm of the frequency.

12.3.Configuration of EUT on Measurement

The equipment is installed on the Conducted Emission Measurement to meet the commission requirements and operating regulations in a manner which tends to maximize its emission characteristics in normal application.

12.4. Operating Condition of EUT

12.4.1. Setup the EUT and simulator as shown as Section 12.1.

12.4.2. Turn on the power of all equipment.

12.4.3. Let the EUT work in Test mode measure it.

12.5. Test Procedure

The EUT is put on the plane 0.8m high above the ground by insulating support and is connected to the power mains through a line impedance stabilization network (L.I.S.N.). This provides a 50ohm coupling impedance for the EUT system. Please refer the block diagram of the test setup and photographs. Both sides of AC lines are checked to find out the maximum conducted emission. In order to find the maximum emission levels, the relative positions of equipment and all of the interface cables shall be changed according to ANSI C63.4- 2013 on Conducted Emission Measurement.

The bandwidth of test receiver (R & S ESCS30) is set at 9 kHz.

The frequency range from 150 kHz to 30MHz is checked.

12.6. DATA SAMPLE

Frequency (MHz)	Quasi Peak Level (dB μ v)	Average Level (dB μ v)	Transducer value (dB)	QuasiPeak Result (dB μ v)	Average Result (dB μ v)	Quasi Peak Limit (dB μ v)	Average Limit (dB μ v)	QuasiPeak Margin (dB)	Average Margin (dB)	Remark (Pass/Fail)
X.XX	29.4	18.3	11.1	40.5	29.4	56.0	56.0	15.5	16.6	Pass

Transducer value = Insertion loss of LISN + Cable Loss

Result = Quasi-peak Level/Average Level + Transducer value

Limit = Limit stated in standard

Calculation Formula:

Margin = Limit – Reading level value – Transducer value

12.7. Power Line Conducted Emission Measurement Results

PASS.

The frequency range from 150kHz to 30MHz is checked.

Test mode : 5.8G Operation Test voltage: 120V /60Hz								
MEASUREMENT RESULT: "F-1773-12_fin"								
2018-10-17 14:14								
Frequency	Level	Transd	Limit	Margin	Detector	Line	PE	
MHz	dBuV	dB	dBuV	dB				
0.303000	36.70	10.9	60	23.5	QP	L1	GND	
0.550500	37.70	11.0	56	18.3	QP	L1	GND	
1.927500	30.70	11.3	56	25.3	QP	L1	GND	
2.179500	30.50	11.3	56	25.5	QP	L1	GND	
12.354000	29.00	11.6	60	31.0	QP	L1	GND	
18.253500	37.00	11.7	60	23.0	QP	L1	GND	
MEASUREMENT RESULT: "F-1773-12_fin2"								
2018-10-17 14:14								
Frequency	Level	Transd	Limit	Margin	Detector	Line	PE	
MHz	dBuV	dB	dBuV	dB				
0.330000	30.70	10.9	50	18.8	AV	L1	GND	
0.523500	34.70	11.0	46	11.3	AV	L1	GND	
1.396500	27.20	11.2	46	18.8	AV	L1	GND	
2.481000	23.50	11.3	46	22.5	AV	L1	GND	
11.778000	22.80	11.6	50	27.2	AV	L1	GND	
18.379500	30.40	11.7	50	19.6	AV	L1	GND	
MEASUREMENT RESULT: "F-1773-11_fin"								
2018-10-17 14:10								
Frequency	Level	Transd	Limit	Margin	Detector	Line	PE	
MHz	dBuV	dB	dBuV	dB				
0.181500	40.70	10.8	64	23.7	QP	N	GND	
0.699000	41.80	11.1	56	14.2	QP	N	GND	
0.883500	42.20	11.1	56	13.8	QP	N	GND	
2.719500	34.30	11.3	56	21.7	QP	N	GND	
5.536500	31.10	11.5	60	28.9	QP	N	GND	
19.068000	41.20	11.7	60	18.8	QP	N	GND	
MEASUREMENT RESULT: "F-1773-11_fin2"								
2018-10-17 14:10								
Frequency	Level	Transd	Limit	Margin	Detector	Line	PE	
MHz	dBuV	dB	dBuV	dB				
0.361500	28.30	10.9	49	20.4	AV	N	GND	
0.820500	32.30	11.1	46	13.7	AV	N	GND	
0.879000	31.00	11.1	46	15.0	AV	N	GND	
2.188500	24.50	11.3	46	21.5	AV	N	GND	
12.354000	21.80	11.6	50	28.2	AV	N	GND	
18.307500	31.90	11.7	50	18.1	AV	N	GND	

Emissions attenuated more than 20 dB below the permissible value are not reported.

The spectral diagrams are attached as below.

ACCURATE TECHNOLOGY CO., LTD

CONDUCTED EMISSION STANDARD FCC PART 15B

EUT: Super Hub M/N:SHB2
 Manufacturer: Questyle Audio Technology Co.,Ltd
 Operating Condition: 5.8G OPERATION
 Test Site: 2#Shielding Room
 Operator: Frank
 Test Specification: N 120V /60Hz
 Comment: Report NO.:ATE20181773
 Start of Test: 2018-10-17 / 14:07:52

SCAN TABLE: "V 150K-30MHz fin"

Short Description: SUB STD VTERM2 1.70
 Start Stop Step Detector Meas. IF Transducer
 Frequency Frequency Width Time Bandw.
 150.0 kHz 30.0 MHz 4.5 kHz QuasiPeak 1.0 s 9 kHz NSLK8126 2008
 Average

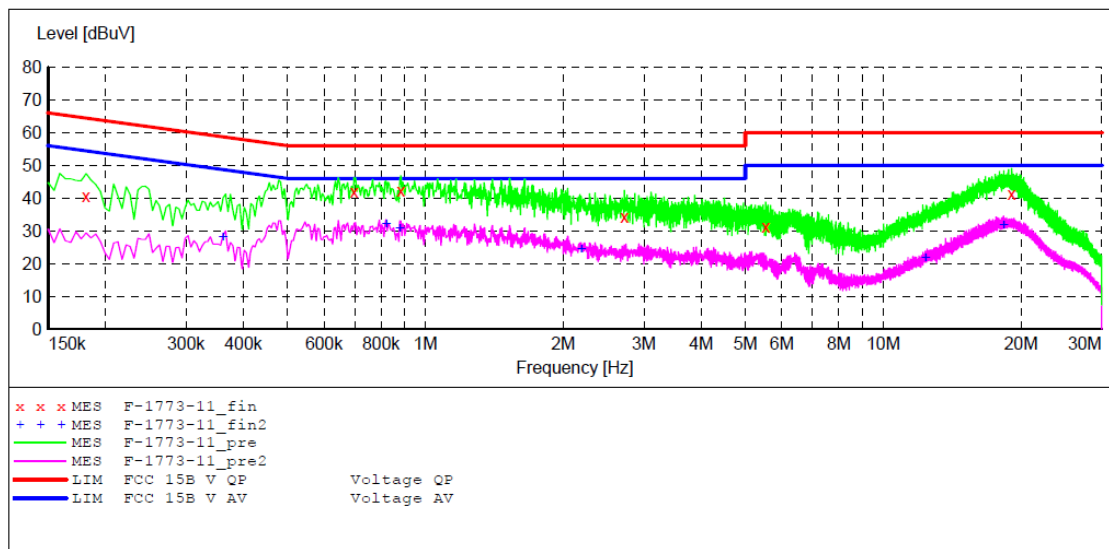

MEASUREMENT RESULT: "F-1773-11_fin"

2018-10-17 14:10

Frequency MHz	Level dBuV	Transd dB	Limit dBuV	Margin dB	Detector	Line	PE
0.181500	40.70	10.8	64	23.7	QP	N	GND
0.699000	41.80	11.1	56	14.2	QP	N	GND
0.883500	42.20	11.1	56	13.8	QP	N	GND
2.719500	34.30	11.3	56	21.7	QP	N	GND
5.536500	31.10	11.5	60	28.9	QP	N	GND
19.068000	41.20	11.7	60	18.8	QP	N	GND

MEASUREMENT RESULT: "F-1773-11_fin2"

2018-10-17 14:10

Frequency MHz	Level dBuV	Transd dB	Limit dBuV	Margin dB	Detector	Line	PE
0.361500	28.30	10.9	49	20.4	AV	N	GND
0.820500	32.30	11.1	46	13.7	AV	N	GND
0.879000	31.00	11.1	46	15.0	AV	N	GND
2.188500	24.50	11.3	46	21.5	AV	N	GND
12.354000	21.80	11.6	50	28.2	AV	N	GND
18.307500	31.90	11.7	50	18.1	AV	N	GND

ACCURATE TECHNOLOGY CO.,LTD

CONDUCTED EMISSION STANDARD FCC PART 15B

EUT: Super Hub M/N:SHB2
 Manufacturer: Questyle Audio Technology Co.,Ltd
 Operating Condition: 5.8G OPERATION
 Test Site: 2#Shielding Room
 Operator: Frank
 Test Specification: L 120V /60Hz
 Comment: Report NO.:ATE20181773
 Start of Test: 2018-10-17 / 14:11:10

SCAN TABLE: "V 150K-30MHz fin"

Short Description: SUB STD VTERM2 1.70
 Start Stop Step Detector Meas. IF Transducer
 Frequency Frequency Width Time Bandw.
 150.0 kHz 30.0 MHz 4.5 kHz QuasiPeak 1.0 s 9 kHz NSLK8126 2008
 Average

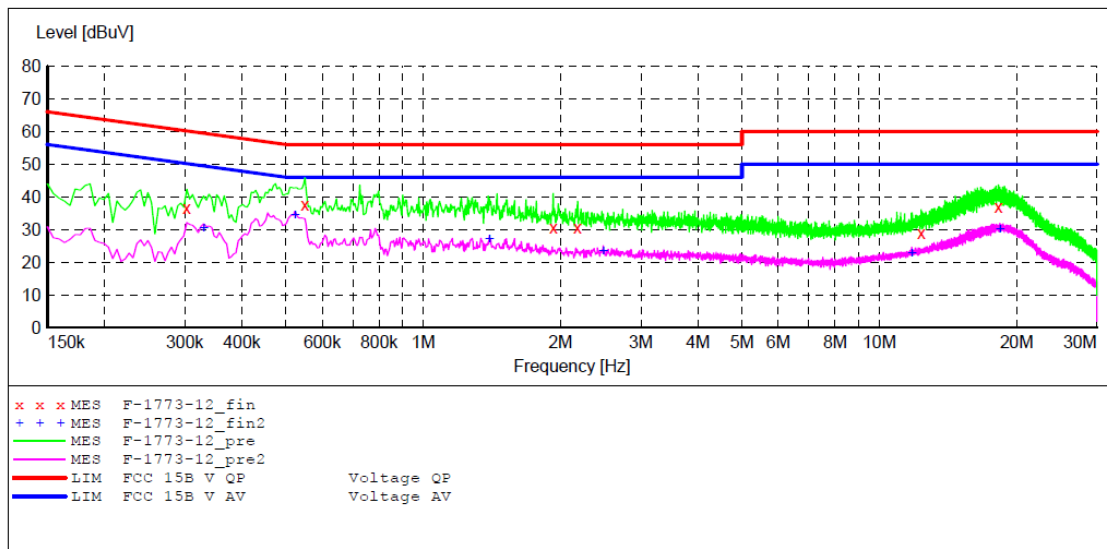

MEASUREMENT RESULT: "F-1773-12_fin"

2018-10-17 14:14

Frequency MHz	Level dBuV	Transd dB	Limit dBuV	Margin dB	Detector	Line	PE
0.303000	36.70	10.9	60	23.5	QP	L1	GND
0.550500	37.70	11.0	56	18.3	QP	L1	GND
1.927500	30.70	11.3	56	25.3	QP	L1	GND
2.179500	30.50	11.3	56	25.5	QP	L1	GND
12.354000	29.00	11.6	60	31.0	QP	L1	GND
18.253500	37.00	11.7	60	23.0	QP	L1	GND

MEASUREMENT RESULT: "F-1773-12_fin2"

2018-10-17 14:14

Frequency MHz	Level dBuV	Transd dB	Limit dBuV	Margin dB	Detector	Line	PE
0.330000	30.70	10.9	50	18.8	AV	L1	GND
0.523500	34.70	11.0	46	11.3	AV	L1	GND
1.396500	27.20	11.2	46	18.8	AV	L1	GND
2.481000	23.50	11.3	46	22.5	AV	L1	GND
11.778000	22.80	11.6	50	27.2	AV	L1	GND
18.379500	30.40	11.7	50	19.6	AV	L1	GND

13.ANTENNA REQUIREMENT

13.1.The Requirement

According to Section 15.203, an intentional radiator shall be designed to ensure that no antenna other than that furnished by the responsible party shall be used with the device.

13.2.Antenna Construction

Device is equipped with permanent attached antenna, which isn't displaced by other antenna. The Antenna gain of EUT is 3dBi. Therefore, the equipment complies with the antenna requirement of Section 15.203.

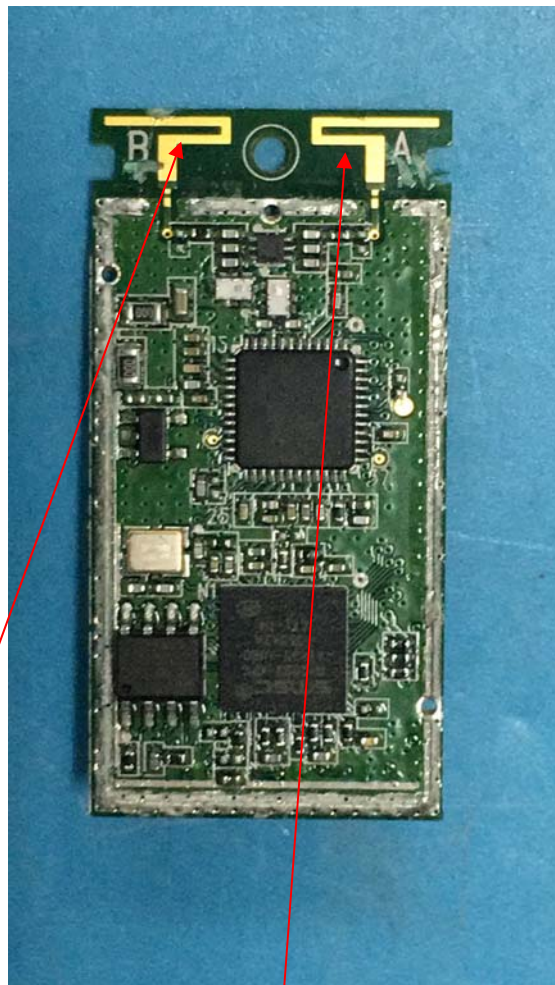

Antenna B

Antenna A