

APPLICATION CERTIFICATION
On Behalf of
Questyle Audio Technology Co.,Ltd

DAC with headphone amplifier

Model No.: CMA Twelve

FCC ID: 2AEKH-C12

Prepared for : Questyle Audio Technology Co.,Ltd
Address : Room No. 13A, Floor 13, Yunsong Building, Tairan 8th
Road, Chegongmiao, Futian District, Shenzhen, China
518040

Prepared by : Shenzhen Accurate Technology Co., Ltd.
Address : 1/F., Building A, Changyuan New Material Port, Science
& Industry Park, Nanshan District, Shenzhen, Guangdong,
P.R. China

Tel: (0755) 26503290
Fax: (0755) 26503396

Report Number : ATE20181770
Date of Test : Oct. 08, 2018--Oct. 25, 2018
Date of Report : Oct. 26, 2018

TABLE OF CONTENTS

Description	Page
Test Report Certification	
1. GENERAL INFORMATION	5
1.1. Description of Device (EUT).....	5
1.2. Accessory and Auxiliary Equipment	5
1.3. Description of Test Facility	6
1.4. Measurement Uncertainty	6
2. MEASURING DEVICE AND TEST EQUIPMENT	7
3. OPERATION OF EUT DURING TESTING.....	8
3.1. Operating Mode	8
3.2. Configuration and peripherals	8
4. TEST PROCEDURES AND RESULTS	9
5. 6DB OCCUPIED BANDWIDTH TEST	10
5.1. Block Diagram of Test Setup.....	10
5.2. The Requirement For Section 15.247(a)(1).....	10
5.3. EUT Configuration on Measurement	10
5.4. Operating Condition of EUT	10
5.5. Test Procedure	10
5.6. Test Result	11
6. POWER SPECTRAL DENSITY TEST.....	15
6.1. Block Diagram of Test Setup.....	15
6.2. The Requirement For Section 15.247(e).....	15
6.3. EUT Configuration on Measurement	15
6.4. Operating Condition of EUT	15
6.5. Test Procedure	15
6.6. Test Result	16
7. 99% OCCUPIED BANDWIDTH TEST	20
7.1. Block Diagram of Test Setup.....	20
7.2. EUT Configuration on Measurement	20
7.3. Operating Condition of EUT	20
7.4. Test Procedure	20
7.5. Test Result	21
8. DUTY CYCLE MEASUREMENT.....	25
8.1. Block Diagram of Test Setup.....	25
8.2. EUT Configuration on Measurement	25
8.3. Operating Condition of EUT	25
8.4. Test Procedure	25
8.5. Test Result	26
9. MAXIMUM CONDUCTED (AVERAGE) OUTPUT POWER	28
9.1. Block Diagram of Test Setup.....	28
9.2. The Requirement For Section 15.247(b)(3).....	28
9.3. EUT Configuration on Measurement	28
9.4. Operating Condition of EUT	28
9.5. Test Procedure	29
9.6. Test Result	29
10. RADIATED EMISSION TEST	33

10.1.	Block Diagram of Test Setup.....	33
10.2.	The Limit For Section 15.247(d)	34
10.3.	Restricted bands of operation	35
10.4.	Configuration of EUT on Measurement	35
10.5.	Test Procedure	36
10.6.	Data Sample.....	36
10.7.	The Field Strength of Radiation Emission Measurement Results	37
11.	BAND EDGE COMPLIANCE TEST	59
11.1.	Block Diagram of Test Setup.....	59
11.2.	The Requirement For Section 15.247(d)	59
11.3.	EUT Configuration on Measurement	59
11.4.	Operating Condition of EUT	59
11.5.	Test Procedure	60
11.6.	Test Result	60
12.	AC POWER LINE CONDUCTED EMISSION FOR FCC PART 15 SECTION 15.207(A) ..	68
12.1.	Block Diagram of Test Setup.....	68
12.2.	The Emission Limit	68
12.3.	Configuration of EUT on Measurement	68
12.4.	Operating Condition of EUT	69
12.5.	Test Procedure	69
12.6.	DATA SAMPLE	69
12.7.	Power Line Conducted Emission Measurement Results	69
13.	ANTENNA REQUIREMENT.....	73
13.1.	The Requirement	73
13.2.	Antenna Construction	73

Test Report Certification

Applicant& address : Questyle Audio Technology Co.,Ltd
Room No. 13A, Floor 13, Yunsong Building, Tairan 8th Road,
Chegongmiao, Futian District, Shenzhen, China 518040

Manufacturer& address : Questyle Audio Technology Co.,Ltd
Room No. 13A, Floor 13, Yunsong Building, Tairan 8th Road,
Chegongmiao, Futian District, Shenzhen, China 518040

Product : DAC with headphone amplifier

Model No. : CMA Twelve

Trade name : Questyle

Measurement Procedure Used:

FCC Rules and Regulations Part 15 Subpart C Section 15.247
ANSI C63.10-2013

The EUT was tested according to DTS test procedure of Aug. 24, 2018 KDB558074 D01 DTS Meas Guidance v05 for compliance to FCC 47CFR 15.247 requirements

The device described above is tested by SHENZHEN ACCURATE TECHNOLOGY CO., LTD to determine the maximum emission levels emanating from the device. The maximum emission levels are compared to the FCC Part 15 Subpart C Section 15.247. The measurement results are contained in this test report and SHENZHEN ACCURATE TECHNOLOGY CO., LTD is assumed full responsibility for the accuracy and completeness of these measurements. Also, this report shows that the Equipment Under Test (EUT) is to be technically compliant with the FCC requirements.

This report applies to above tested sample only. This report shall not be reproduced in part without written approval of SHENZHEN ACCURATE TECHNOLOGY CO., LTD.

Date of Test : Oct. 08, 2018--Oct. 25, 2018

Date of Report: Oct. 26, 2018

Prepared by :

(Tim Wang, Engineer)

Approved &
Authorized Signer :

(Sean Liu, Manager)

1. GENERAL INFORMATION

1.1. Description of Device (EUT)

EUT	:	DAC with headphone amplifier
Model Number	:	CMA Twelve
Operation Frequency	:	5736MHz, 5762MHz, 5814MHz
Number of Channels	:	3
Modulation type	:	QPSK
Antenna Gain	:	3dBi
Antenna type	:	PCB Antenna
Power Supply	:	AC 120V/60Hz
Applicant	:	Questyle Audio Technology Co.,Ltd
Address	:	Room No. 13A, Floor 13, Yunsong Building, Tairan 8th Road, Chegongmiao, Futian District, Shenzhen, China 518040
Manufacturer	:	Questyle Audio Technology Co.,Ltd
Address	:	Room No. 13A, Floor 13, Yunsong Building, Tairan 8th Road, Chegongmiao, Futian District, Shenzhen, China 518040
Date of sample received	:	Oct 08, 2018
Date of Test	:	Oct. 08, 2018--Oct. 25, 2018

1.2. Accessory and Auxiliary Equipment

N/A

1.3. Description of Test Facility

- EMC Lab : Recognition of accreditation by Federal Communications Commission (FCC)
The Designation Number is CN1189
The Registration Number is 708358
- Listed by Innovation, Science and Economic Development Canada (ISED)
The Registration Number is 5077A-2
- Accredited by China National Accreditation Service for Conformity Assessment (CNAS)
The Registration Number is CNAS L3193
- Accredited by American Association for Laboratory Accreditation (A2LA)
The Certificate Number is 4297.01
- Name of Firm : Shenzhen Accurate Technology Co., Ltd.
- Site Location : 1/F., Building A, Changyuan New Material Port, Science & Industry Park, Nanshan District, Shenzhen, Guangdong, P.R. China
- Subcontracted Items: : RF Strength Susceptibility Test
- Subcontractor : Shenzhen Academy Of Metrology And Quality Inspection
- Site Location : Bldg. Of Shenzhen Academy Of Metrology And Quality Inspection, Longzhu Road, Nanshan, Shenzhen, Guangdong P. R. China

1.4. Measurement Uncertainty

- Conducted Emission Expanded Uncertainty = 2.23dB, k=2
- Radiated emission expanded uncertainty = 3.08dB, k=2
(9kHz-30MHz)
- Radiated emission expanded uncertainty = 4.42dB, k=2
(30MHz-1000MHz)
- Radiated emission expanded uncertainty = 4.06dB, k=2
(Above 1GHz)

2. MEASURING DEVICE AND TEST EQUIPMENT

Table 1: List of Test and Measurement Equipment

Kind of equipment	Manufacturer	Type	S/N	Calibrated dates	Calibrated until
EMI Test Receiver	Rohde&Schwarz	ESCS30	100307	Jan. 06, 2018	Jan. 05, 2019
EMI Test Receiver	Rohde&Schwarz	ESPI3	101526/003	Jan. 06, 2018	Jan. 05, 2019
Spectrum Analyzer	Rohde&Schwarz	FSV-40	101495	Jan. 06, 2018	Jan. 05, 2019
Spectrum Analyzer	Agilent	E7405A	MY45115511	Jan. 06, 2018	Jan. 05, 2019
Pre-Amplifier	Rohde&Schwarz	CBLU1183540-01	3791	Jan. 06, 2018	Jan. 05, 2019
Loop Antenna	Schwarzbeck	FMZB1516	1516131	Jan. 06, 2018	Jan. 05, 2019
Bilog Antenna	Schwarzbeck	VULB9163	9163-323	Jan. 06, 2018	Jan. 05, 2019
Horn Antenna	Schwarzbeck	BBHA9120D	9120D-655	Jan. 06, 2018	Jan. 05, 2019
Horn Antenna	Schwarzbeck	BBHA9170	9170-359	Jan. 06, 2018	Jan. 05, 2019
Open Switch and Control Unit	Rohde&Schwarz	OSP120 + OSP-B157	101244 + 100866	Jan. 06, 2018	Jan. 05, 2019
LISN	Rohde&Schwarz	ESH3-Z5	100305	Jan. 06, 2018	Jan. 05, 2019
LISN	Schwarzbeck	NSLK8126	8126431	Jan. 06, 2018	Jan. 05, 2019
Highpass Filter	Wainwright Instruments	WHKX3.6/18G-10SS	N/A	Jan. 06, 2018	Jan. 05, 2019
Band Reject Filter	Wainwright Instruments	WRCG2400/2485-2375/2510-60/11SS	N/A	Jan. 06, 2018	Jan. 05, 2019
Test Receiver	Rohde & Schwarz	ESCS30	100307	Jan. 06, 2018	Jan. 05, 2019
L.I.S.N.	Schwarzbeck	NLSK8126	8126431	Jan. 06, 2018	Jan. 05, 2019
Pulse Limiter	Rohde & Schwarz	ESH3-Z2	100815	Jan. 06, 2018	Jan. 05, 2019
50Ω Coaxial Switch	Anritsu Corp	MP59B	6200283933	Jan. 06, 2018	Jan. 05, 2019

3. OPERATION OF EUT DURING TESTING

3.1. Operating Mode

The mode is used: Transmitting mode

Low Channel: 5736MHz

Middle Channel: 5762MHz

High Channel: 5814MHz

3.2. Configuration and peripherals

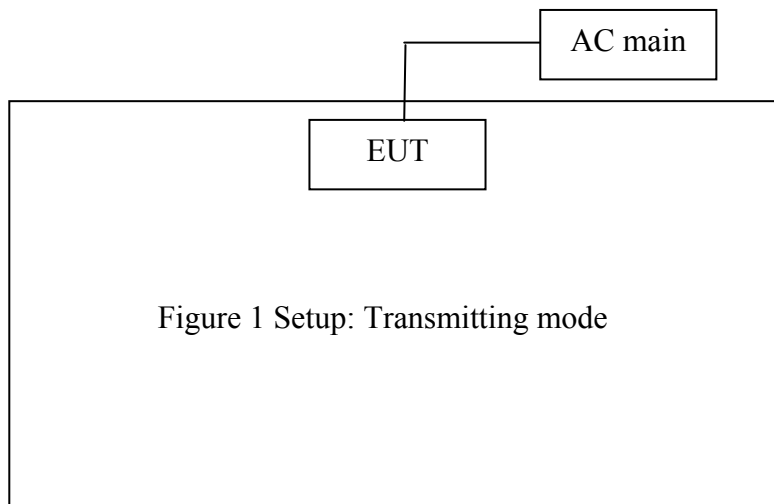

(EUT: DAC with headphone amplifier)

Note: The EUT have two antenna(A and B), They can not transmit simultaneously, The EUT select a antenna to transmit according to signal strength automatically, One Antenna of EUT does not work when Another antenna is transmitting

4. TEST PROCEDURES AND RESULTS

FCC Rules	Description of Test	Result
Section 15.207	AC power Line Conducted Emission Test	Compliant
Section 15.247(a)(2)	6dB Occupied Bandwidth Test	Compliant
KDB 558074	99% Occupied Bandwidth Test	Compliant
Section 15.247(b)(3)	Maximum conducted (average) output power	Compliant
Section 15.247(e)	Power Spectral Density Test	Compliant
Section 15.205 Section 15.209	Radiated Spurious Emissions Test	Compliant
Section 15.247(d)	Band Edge Compliance Test	Compliant
Section 15.203	Antenna Requirement	Compliant

5. 6DB OCCUPIED BANDWIDTH TEST

5.1. Block Diagram of Test Setup

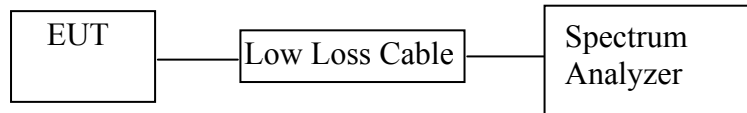

(EUT: DAC with headphone amplifier)

5.2. The Requirement For Section 15.247(a)(1)

Section 15.247(a)(2): Systems using digital modulation techniques may operate in the 902–928 MHz, 2400–2483.5 MHz, and 5725–5850 MHz bands. The minimum 6 dB band-width shall be at least 500 kHz

5.3. EUT Configuration on Measurement

The equipment are installed on the emission measurement to meet the commission requirements and operating regulations in a manner which tends to maximize its emission characteristics in normal application.

5.4. Operating Condition of EUT

5.4.1. Setup the EUT and simulator as shown as Section 5.1.

5.4.2. Turn on the power of all equipment.

5.4.3. Let the EUT work in TX modes measure it. The transmit frequency are 5736MHz, 5762MHz, 5814MHz, We select these frequency to transmit.

5.5. Test Procedure

5.5.1. The transmitter output was connected to the spectrum analyzer through a low loss cable.

5.5.2. Set RBW of spectrum analyzer to 100 kHz and VBW to 300 kHz.

5.5.3. The 6dB bandwidth is defined as the total spectrum the power of which is higher than peak power minus 6dB.

5.6. Test Result

Antenna A test data

Channel	Frequency (MHz)	6dB Bandwidth (MHz)	Limit (MHz)	Result
Low	5736	12.330	≥ 0.5	Pass
Middle	5762	12.321	≥ 0.5	Pass
High	5814	12.330	≥ 0.5	Pass

Antenna B test data

Channel	Frequency (MHz)	6dB Bandwidth (MHz)	Limit (MHz)	Result
Low	5736	12.272	≥ 0.5	Pass
Middle	5762	12.322	≥ 0.5	Pass
High	5814	12.330	≥ 0.5	Pass

The spectrum analyzer plots are attached as below.

Low channel(Antenna A)

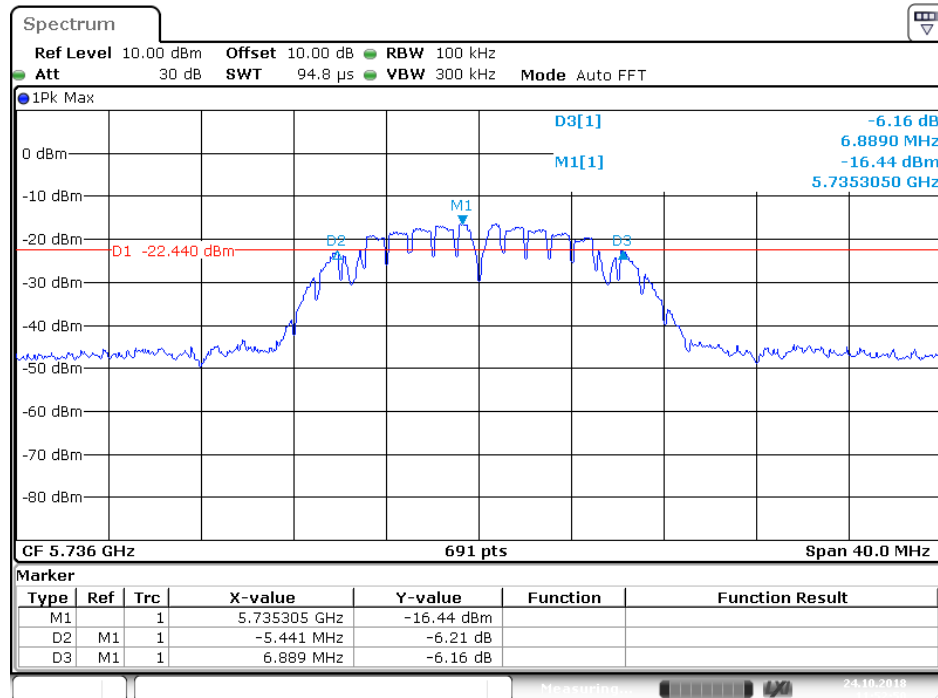

Date: 24.OCT.2018 11:52:50

Middle channel(Antenna A)

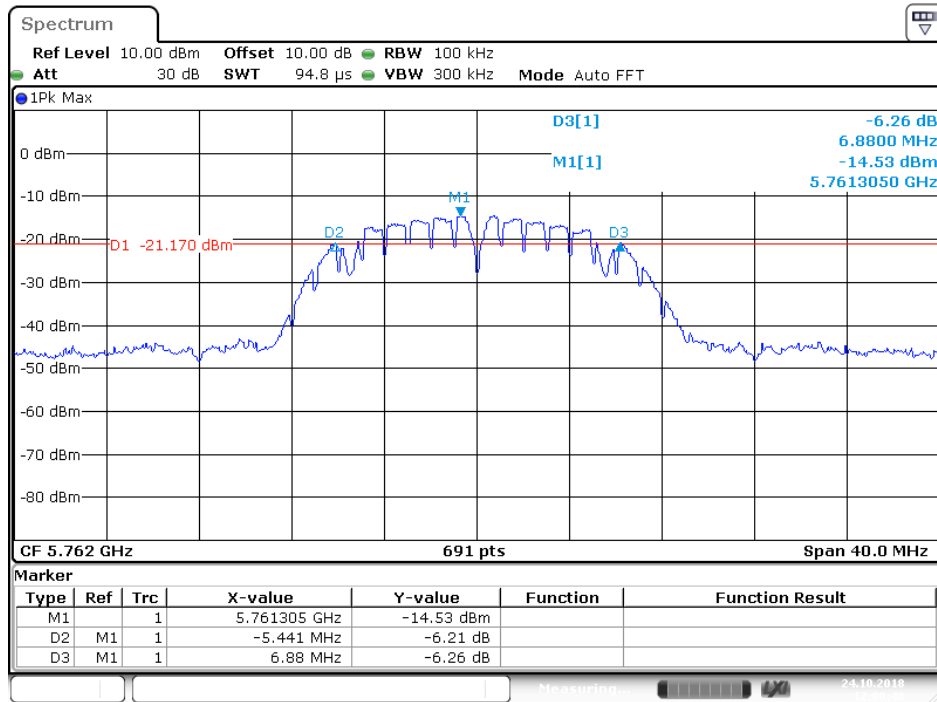

Date: 24.OCT.2018 12:00:48

High channel(Antenna A)

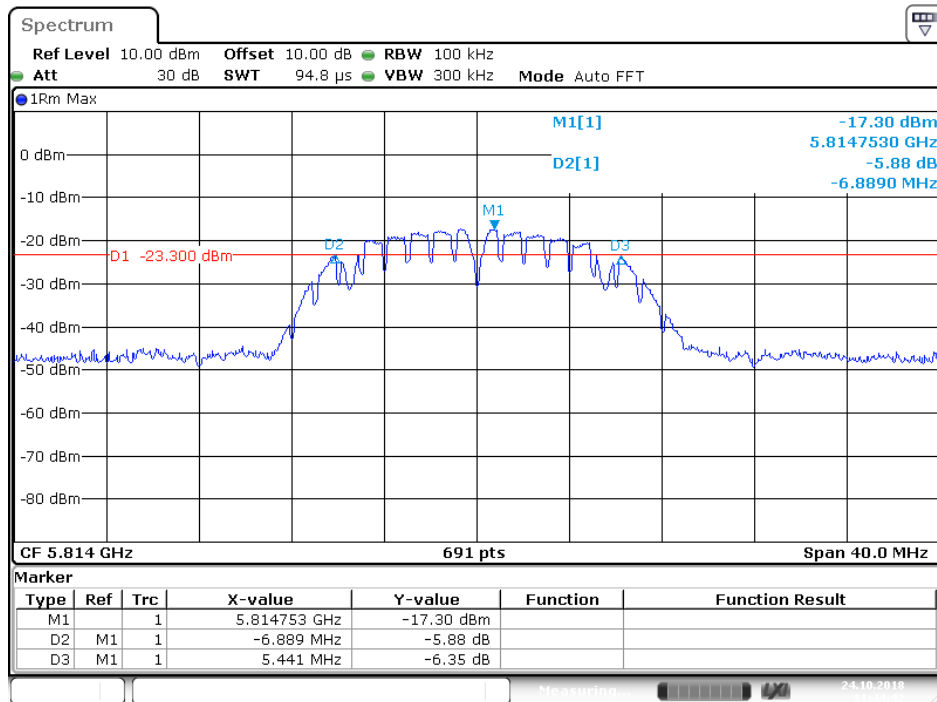

Date: 24.OCT.2018 11:44:42

Low channel(Antenna B)

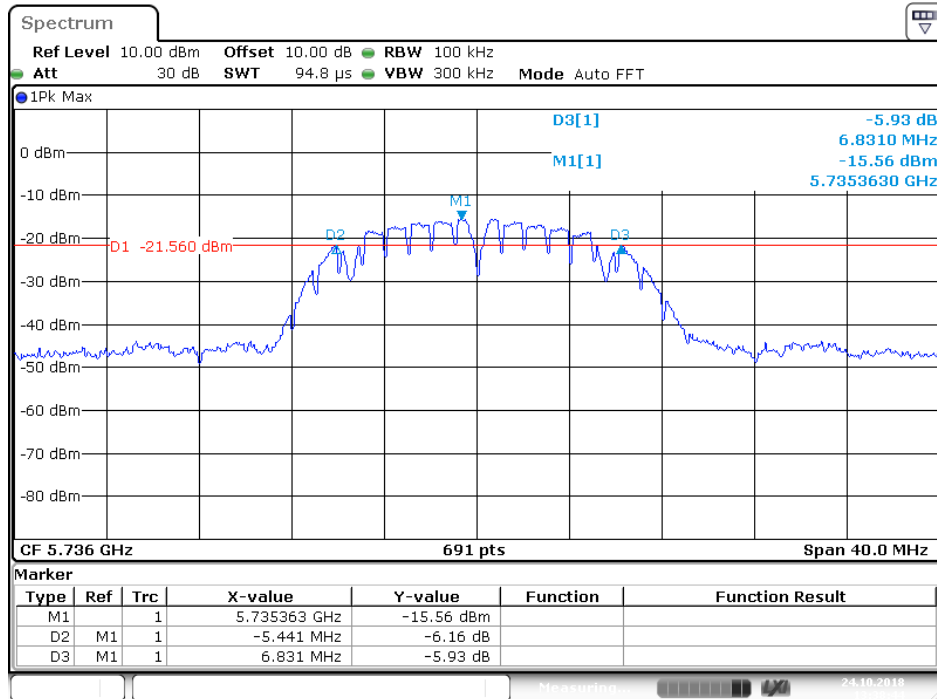

Date: 24.OCT.2018 13:38:44

Middle channel(Antenna B)

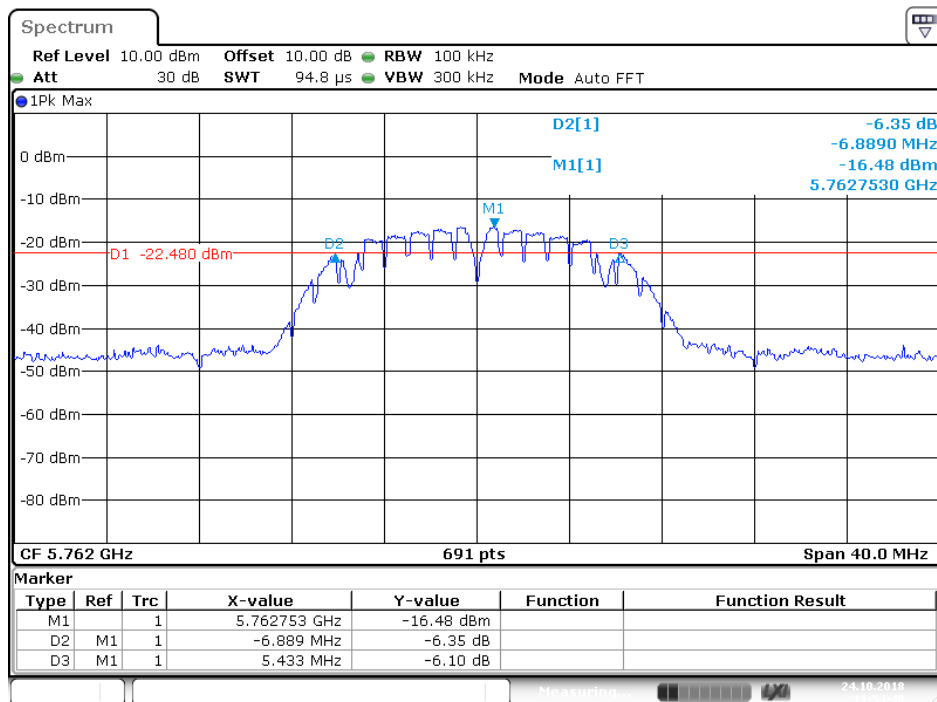

Date: 24.OCT.2018 11:54:40

High channel(Antenna B)

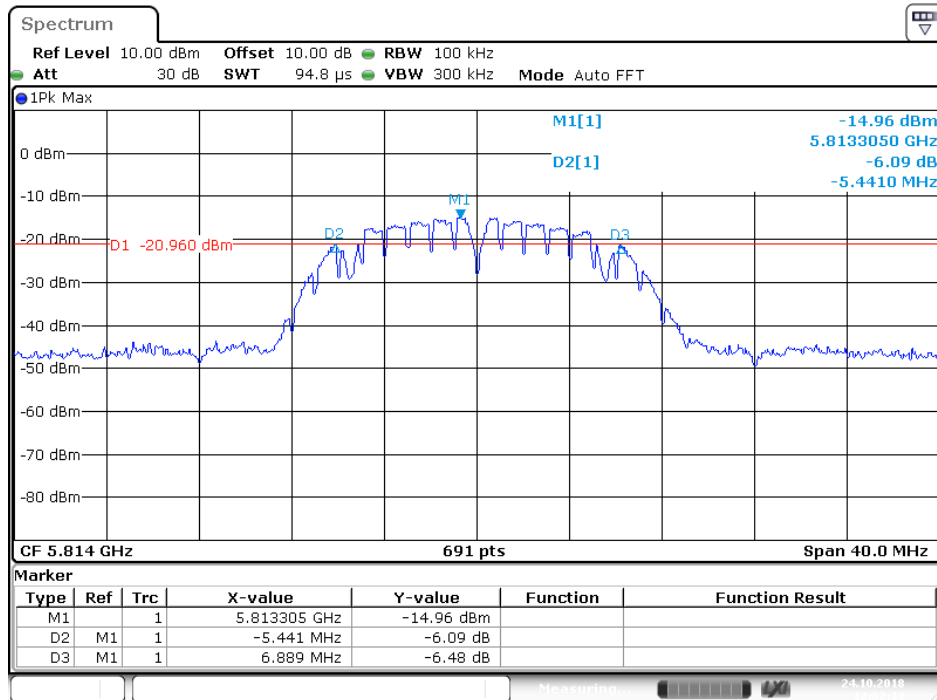

Date: 24.OCT.2018 12:02:13

6. POWER SPECTRAL DENSITY TEST

6.1. Block Diagram of Test Setup

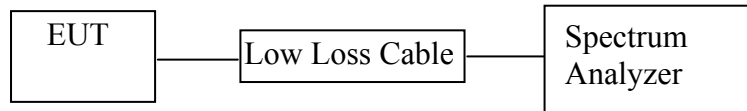

(EUT: DAC with headphone amplifier)

6.2. The Requirement For Section 15.247(e)

Section 15.247(e): For digitally modulated systems, the power spectral density conducted from the intentional radiator to the antenna shall not be greater than 8dBm in any 3 kHz band during any time interval of continuous transmission. This power spectral density shall be determined in accordance with the provisions of paragraph (b) of this section. The same method of determining the conducted output power shall be used to determine the power spectral density.

6.3. EUT Configuration on Measurement

The equipment are installed on the emission measurement to meet the commission requirements and operating regulations in a manner which tends to maximize its emission characteristics in normal application.

6.4. Operating Condition of EUT

6.4.1. Setup the EUT and simulator as shown as Section 6.1.

6.4.2. Turn on the power of all equipment.

6.4.3. Let the EUT work in TX modes and measure it. The transmit frequency are 5736MHz, 5762MHz, 5814MHz. We select these frequency to transmit.

6.5. Test Procedure

Refer to Subclause 11.10 of ANSI C63.10

6.5.1. Set analyzer center frequency to DTS channel center frequency.

6.5.2. Set the span to 1.5 times the DTS bandwidth.

6.5.3. Set the RBW to: $3 \text{ kHz} \leq \text{RBW} \leq 100 \text{ kHz}$. Set the VBW $\geq 3 \times \text{RBW}$.

6.5.4. Detector = peak.

6.5.5.Sweep time = auto couple.

6.5.6.Trace mode = max hold. Allow trace to fully stabilize.

6.5.7.Use the peak marker function to determine the maximum amplitude level within the RBW.

6.6. Test Result

Antenna A test result

Channel	Frequency (MHz)	Power Spectral Density (dBm)	Limit (dBm)	Result
Low	5736MHz	-15.96	≤8.00	PASS
Middle	5762MHz	-16.40	≤8.00	PASS
High	5814MHz	-18.67	≤8.00	PASS

Antenna B test result

Channel	Frequency (MHz)	Power Spectral Density (dBm)	Limit (dBm)	Result
Low	5736MHz	-16.19	≤8.00	PASS
Middle	5762MHz	-15.57	≤8.00	PASS
High	5814MHz	-13.80	≤8.00	PASS

The spectrum analyzer plots are attached as below.

Low channel(Antenna A)

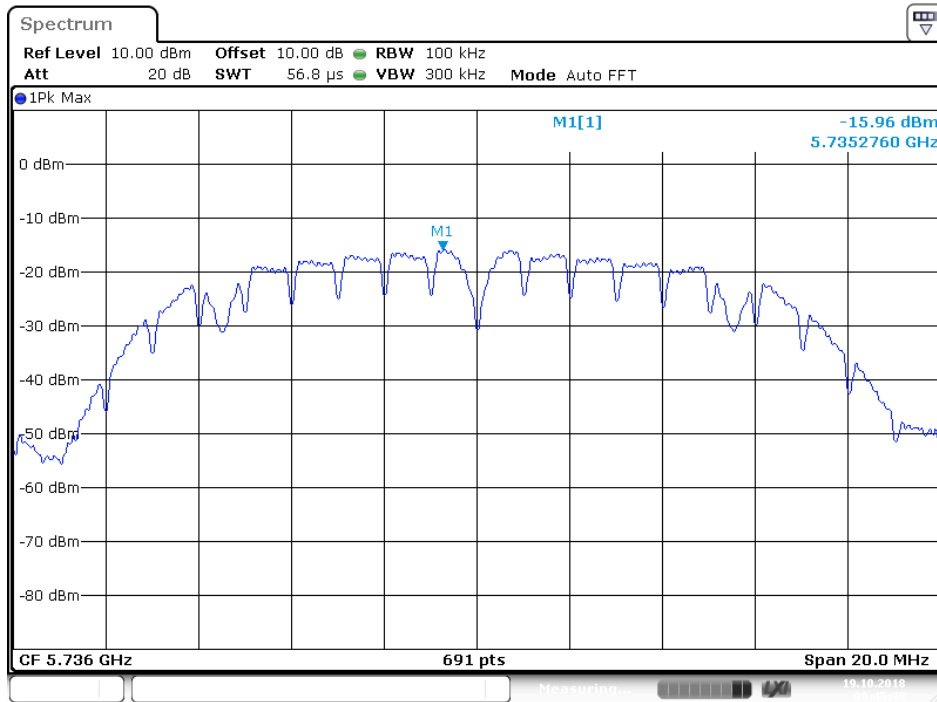

Date: 19.OCT.2018 09:45:49

Middle channel(Antenna A)

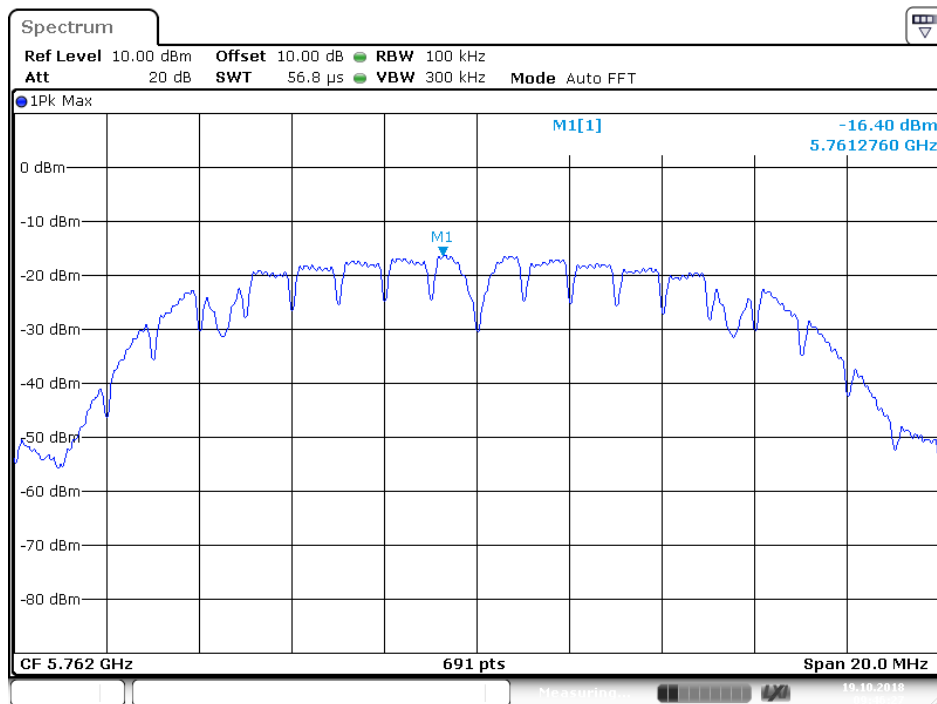

Date: 19.OCT.2018 09:46:27

High channel(Antenna A)

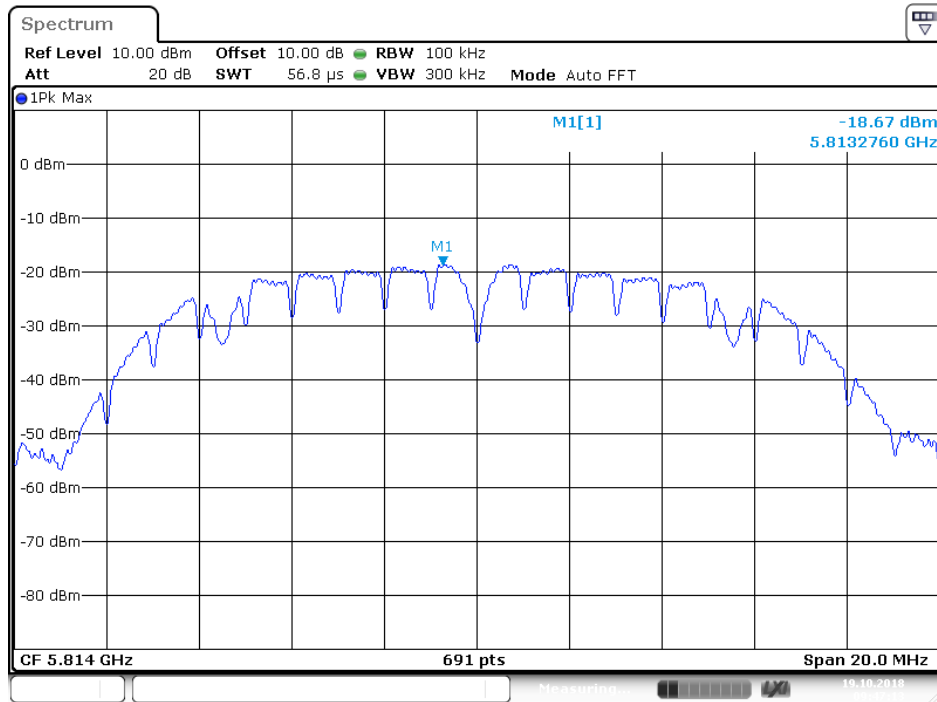

Date: 19.OCT.2018 09:47:14

Low channel(Antenna B)

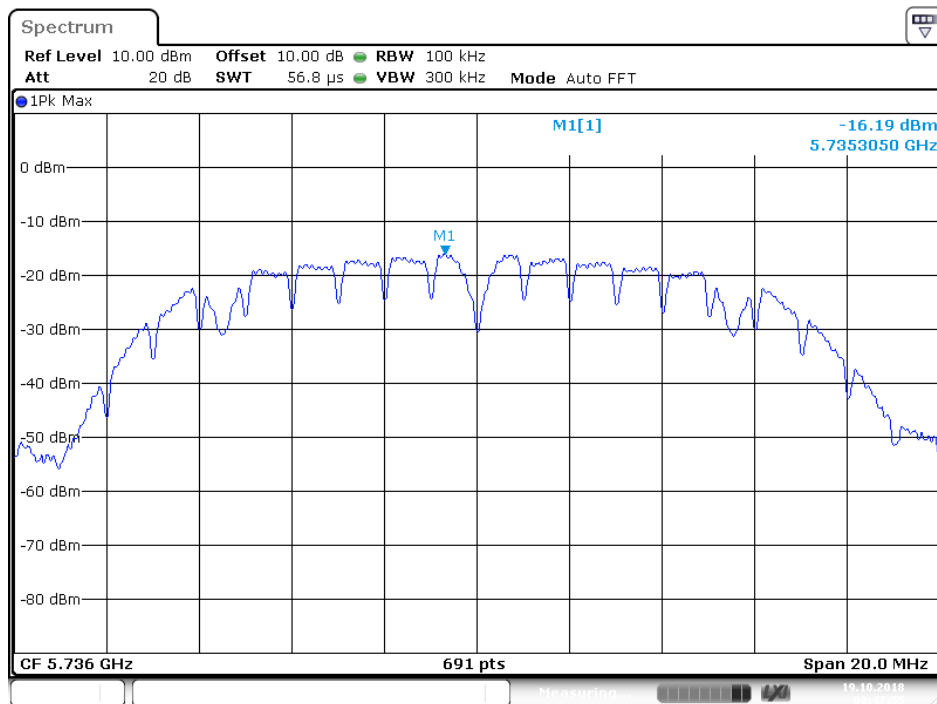

Date: 19.OCT.2018 09:47:55

7. 99% OCCUPIED BANDWIDTH TEST

7.1. Block Diagram of Test Setup

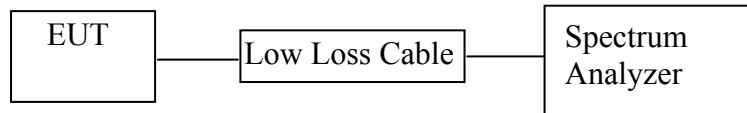

(EUT: DAC with headphone amplifier)

7.2. EUT Configuration on Measurement

The equipment are installed on the emission measurement to meet the commission requirements and operating regulations in a manner which tends to maximize its emission characteristics in normal application.

7.3. Operating Condition of EUT

7.3.1. Setup the EUT and simulator as shown as Section 7.1.

7.3.2. Turn on the power of all equipment.

7.3.3. Let the EUT work in TX modes measure it. The transmit frequency are 5736MHz, 5762MHz, 5814MHz, We select these frequency to transmit.

7.4. Test Procedure

7.4.1. The transmitter output was connected to the spectrum analyzer through a low loss cable.

7.4.2. Set RBW of spectrum analyzer to 300 kHz and VBW to 1000 kHz (The nominal IF filter bandwidth (3 dB RBW) shall be in the range of 1% to 5% of the OBW, and VBW shall be approximately three times the RBW, unless otherwise specified by the applicable requirement).

7.4.3. The frequency span for the spectrum analyzer shall be between 1.5 times and 5.0 times the OBW

7.4.4. Set SPA "Meas" function, Select "Occupied Bandwidth" function, Select "99% Power Bandwidth". The frequency of the upper and lower markers indicating the edges of the transmitters "99% Power" emission bandwidth shall be recorded to automate by SPA.

7.5. Test Result

Antenna A test data

Channel	Frequency (MHz)	99% Bandwidth (MHz)	Result
Low	5736	13.929	Pass
Middle	5762	13.929	Pass
High	5814	13.965	Pass

Antenna B test data

Channel	Frequency (MHz)	99% Bandwidth (MHz)	Result
Low	5736	13.965	Pass
Middle	5762	13.965	Pass
High	5814	13.965	Pass

The spectrum analyzer plots are attached as below.

Low channel(Antenna A)

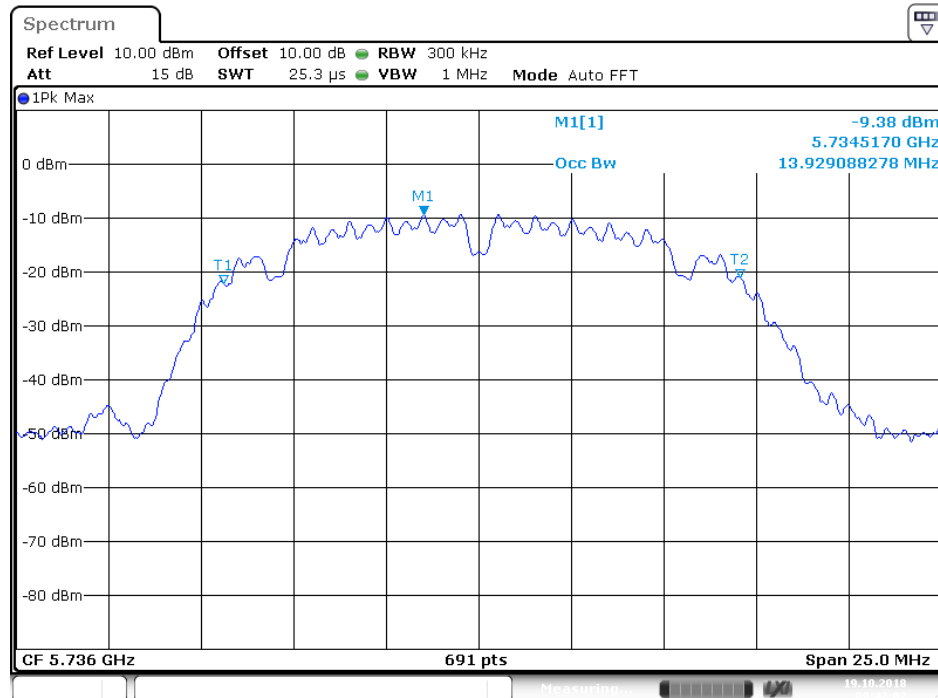

Date: 19.OCT.2018 09:42:02

Middle channel(Antenna A)

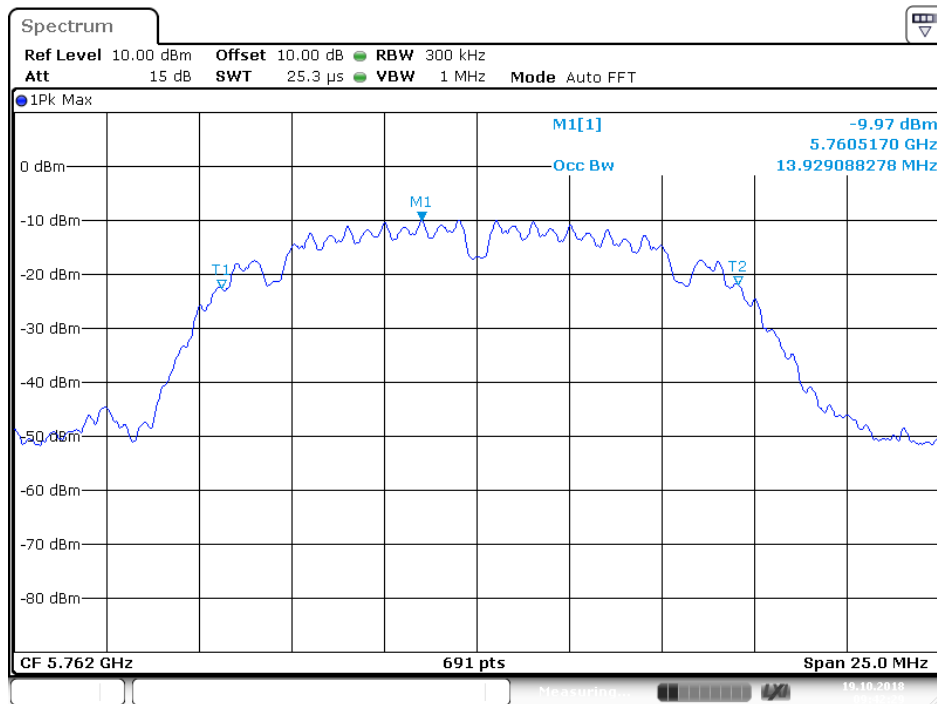

Date: 19.OCT.2018 09:42:29

High channel(Antenna A)

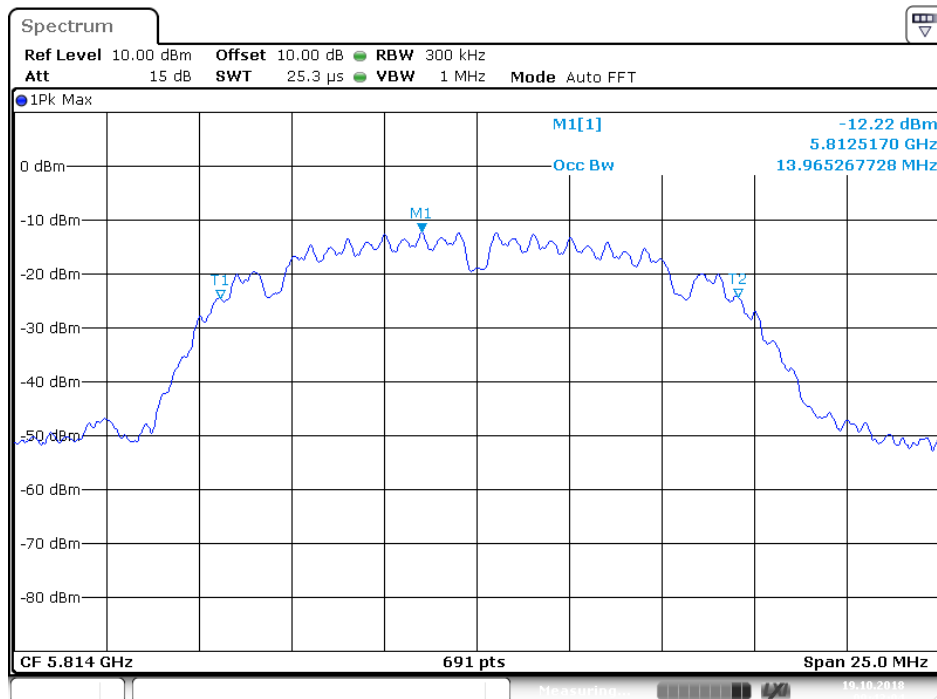

Date: 19.OCT.2018 09:43:04

Low channel(Antenna B)

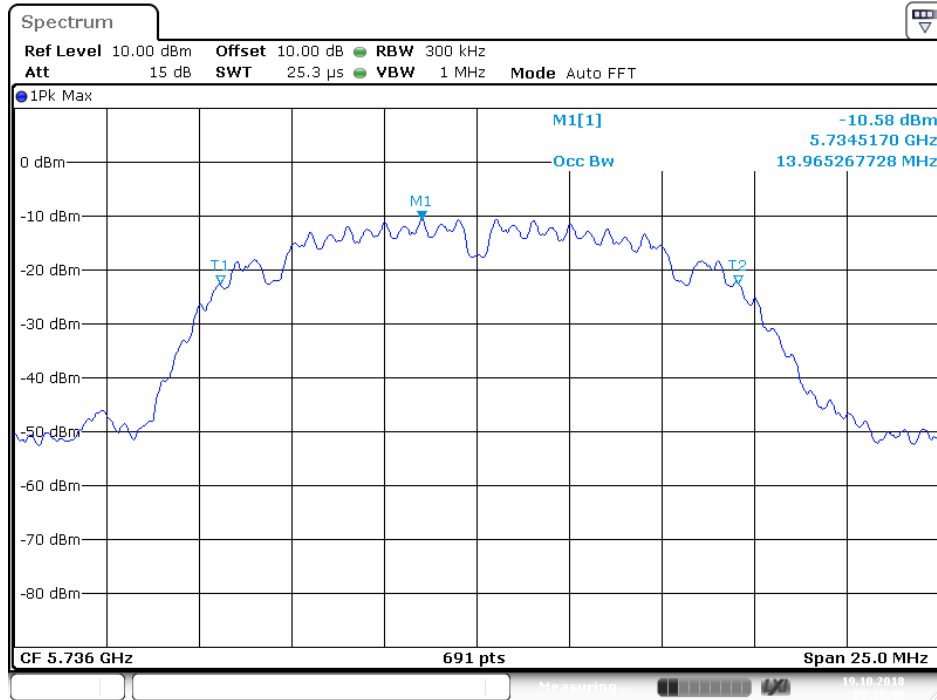

Date: 19.OCT.2018 09:39:49

Middle channel(Antenna B)

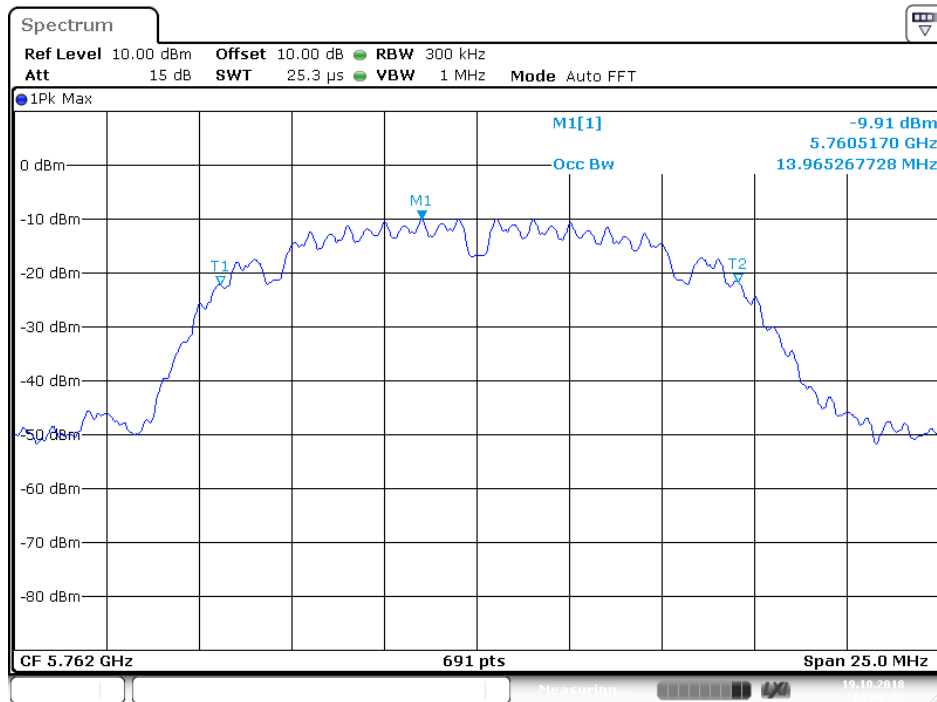

Date: 19.OCT.2018 09:40:20

High channel(Antenna B)

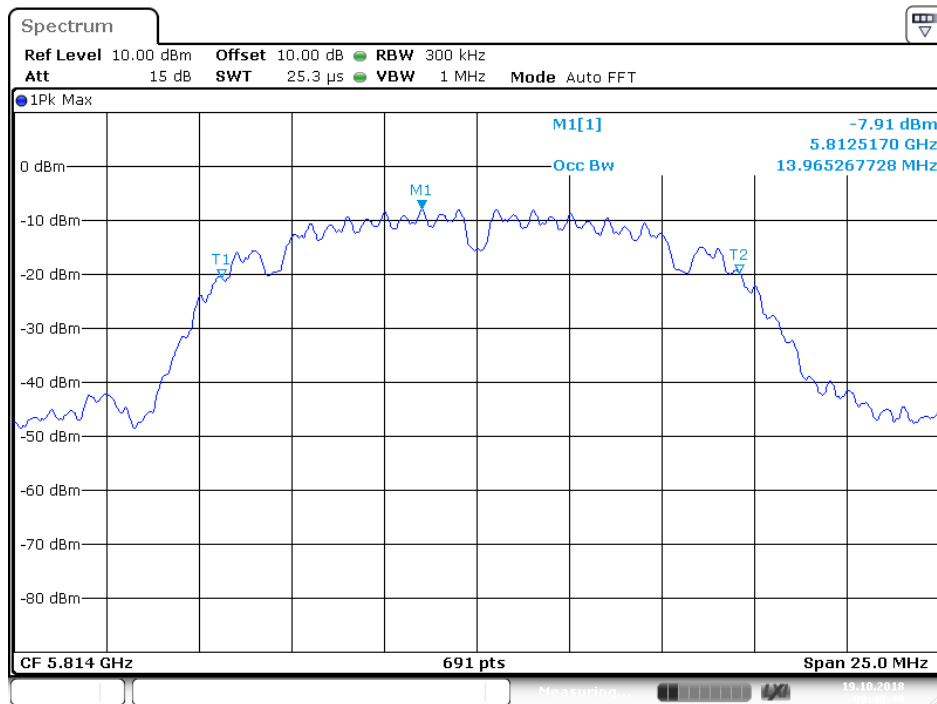

Date: 19.OCT.2018 09:40:49

8. DUTY CYCLE MEASUREMENT

8.1. Block Diagram of Test Setup

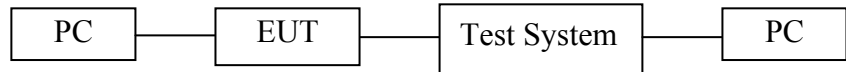

8.2. EUT Configuration on Measurement

The equipment are installed on the emission measurement to meet the commission requirements and operating regulations in a manner which tends to maximize its emission characteristics in normal application.

8.3. Operating Condition of EUT

8.3.1. Setup the EUT and simulator as shown as Section 8.1.

8.3.2. Turn on the power of all equipment.

8.3.3. Let the EUT work in TX modes measure it. The transmit frequency are 5736-5814MHz. We select 5736MHz TX frequency to transmit.

8.4. Test Procedure

Measurements of duty cycle and transmission duration shall be performed using one of the following techniques:

1. A diode detector and an oscilloscope that together have sufficiently short response time to permit accurate measurements of the on- and off-times of the transmitted signal.
2. The zero-span mode on a spectrum analyzer or EMI receiver if the response time and spacing between bins on the sweep are sufficient to permit accurate measurements of the on- and off-times of the transmitted signal
 - a. Set the center frequency of the instrument to the centre frequency of the transmission
 - b. Set $RBW \geq OBW$ if possible; otherwise, set RBW to the largest available value(10MHz).
 - c. Set detector = Peak or average.
 - d. The zero-span measurement method shall not be used unless both RBW and VBW are $> 50/T$ and the number of sweep points across duration T exceeds 100.
(For example, if VBW and/or RBW are limited to 3MHz, then the zero-span method of measuring duty cycle shall not be used if $T \leq 16.7$ microseconds.)

8.5. Test Result

Channel	Frequency (MHz)	duty cycle(x) ANT A	10log(1/x) ANT A	duty cycle(x) ANT B	10log(1/x) ANT B
Middle	5762	100%	0.0	100%	0.0

Note: The duty cycle's parameter settings for each mode are the same, Therefore, other channels can refer to the test data of the middle channel.

The spectrum analyzer plots are attached as below.

Duty cycle
5762MHz (ANT A)

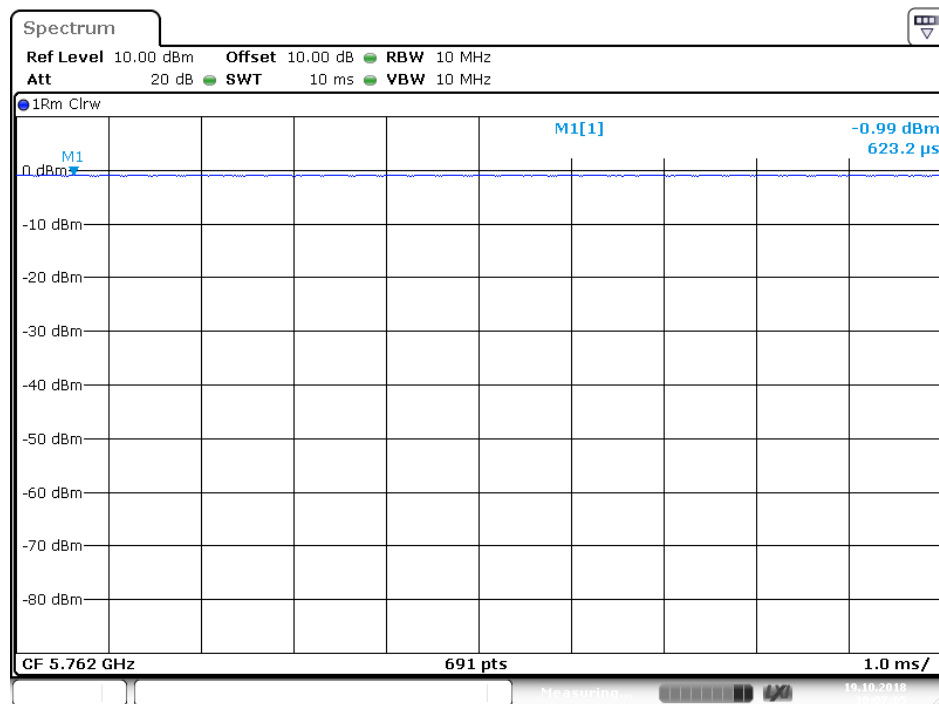

Date: 19.OCT.2018 10:07:05

Duty cycle
5762MHz (ANT B)

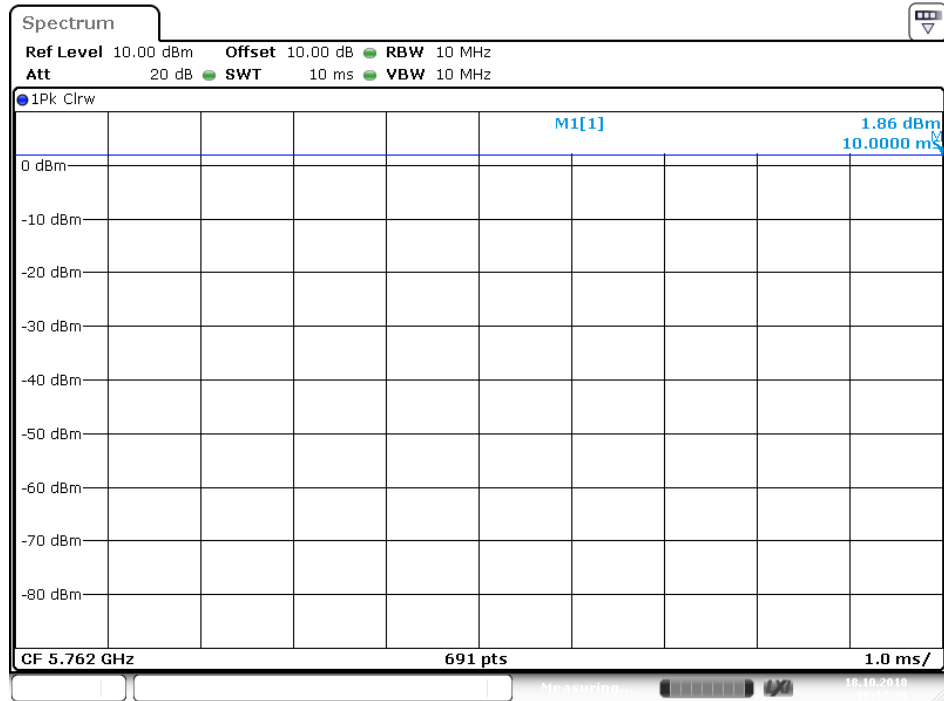

Date: 18.OCT.2018 16:17:24

9. MAXIMUM CONDUCTED (AVERAGE) OUTPUT POWER

9.1. Block Diagram of Test Setup

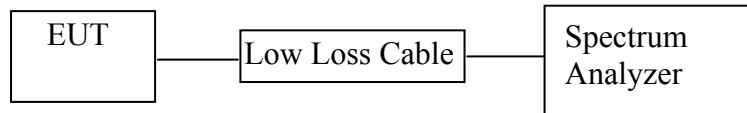

(EUT: DAC with headphone amplifier)

9.2. The Requirement For Section 15.247(b)(3)

Section 15.247(b)(3): For systems using digital modulation in the 902-928 MHz, 2400-2483.5 MHz, and 5725-5850 MHz bands: 1 Watt. As an alternative to a peak power measurement, compliance with the one Watt limit can be based on a measurement of the maximum conducted output power. Maximum Conducted Output Power is defined as the total transmit power delivered to all antennas and antenna elements averaged across all symbols in the signaling alphabet when the transmitter is operating at its maximum power control level. Power must be summed across all antennas and antenna elements. The average must not include any time intervals during which the transmitter is off or is transmitting at a reduced power level. If multiple modes of operation are possible (e.g., alternative modulation methods), the maximum conducted output power is the highest total transmit power occurring in any mode.

9.3. EUT Configuration on Measurement

The equipment are installed on the emission Measurement to meet the commission requirements and operating regulations in a manner which tends to maximize its emission characteristics in normal application.

9.4. Operating Condition of EUT

9.4.1. Setup the EUT and simulator as shown as Section 9.1.

9.4.2. Turn on the power of all equipment.

9.4.3. Let the EUT work in TX modes and measure it. The transmit frequency are 5736MHz, 5762MHz, 5814MHz.

9.5. Test Procedure

Refer to section 8.3.2 of KDB 558074 D01 DTS Meas Guidance v05

9.5.1. The transmitter output was connected to the spectrum analyzer through a low loss cable.

9.5.2. Set span to at least 1.5 times the OBW.

9.5.3. Set RBW = 1-5% of the OBW, not to exceed 1 MHz.

9.5.4. Set RBW of spectrum analyzer to 1MHz and VBW to 3MHz for test mode. Set detector = RMS. Set span to at least 1.5 times the OBW. The EUT shall be operated at $\geq 98\%$ duty cycle

9.5.5. Sweep time = auto.

9.5.6. Measurement the maximum conducted(Average) output power.

9.6. Test Result

Antenna A test result

Channel	Frequency (MHz)	Max conducted (average)Output Power (dBm)	Limits dBm
Low	5736	3.57	30
Middle	5762	2.40	30
High	5814	2.93	30

Antenna B test result

Channel	Frequency (MHz)	Max conducted (average)Output Power (dBm)	Limits dBm
Low	5736	2.20	30
Middle	5762	2.86	30
High	5814	2.70	30

The spectrum analyzer plots are attached as below.

Low channel (Antenna A)

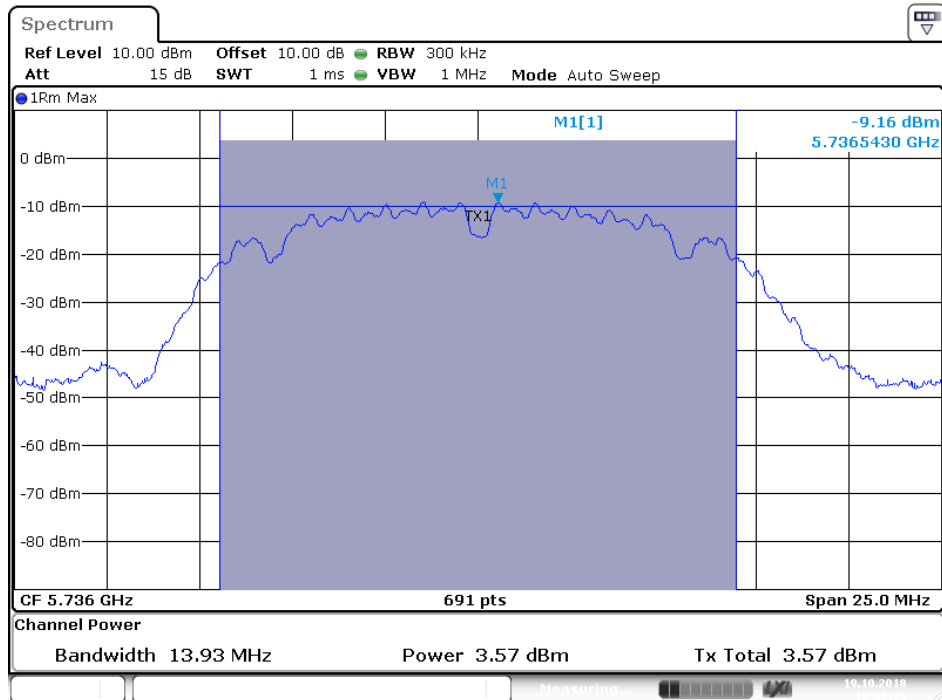

Date: 19.OCT.2018 10:01:19

Middle channel (Antenna A)

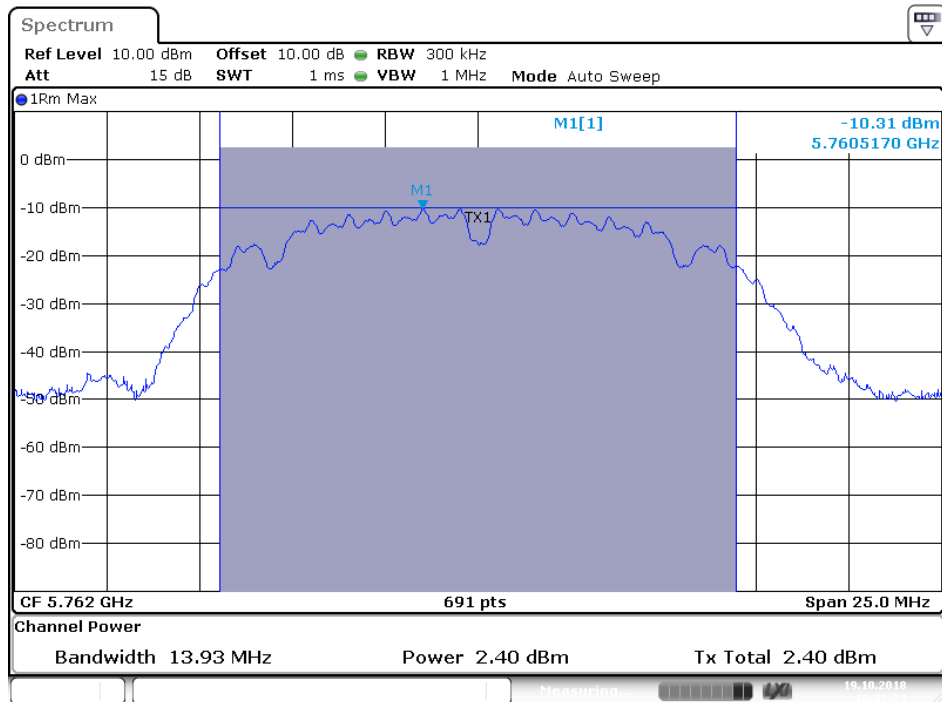

Date: 19.OCT.2018 10:02:23

High channel (Antenna A)

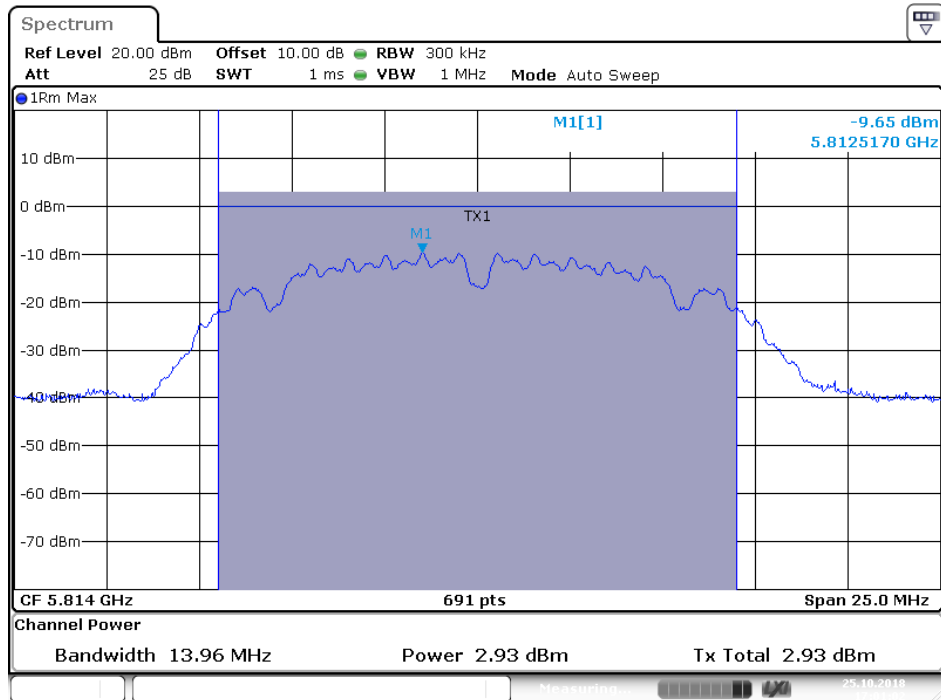

Date: 25.OCT.2018 17:01:02

Low channel (Antenna B)

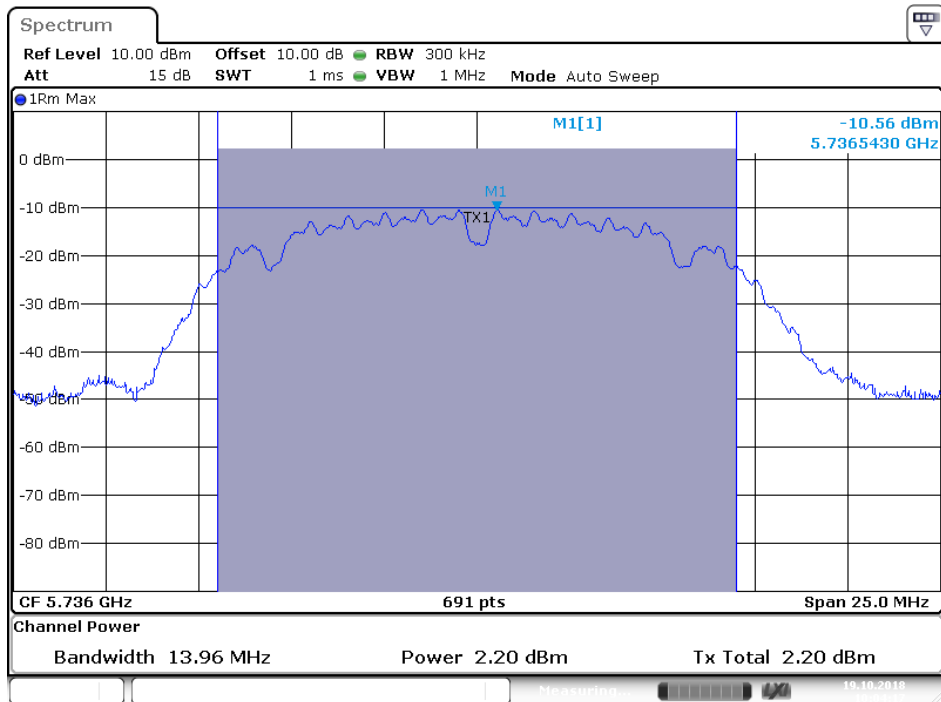

Date: 19.OCT.2018 10:04:17

Middle channel (Antenna B)

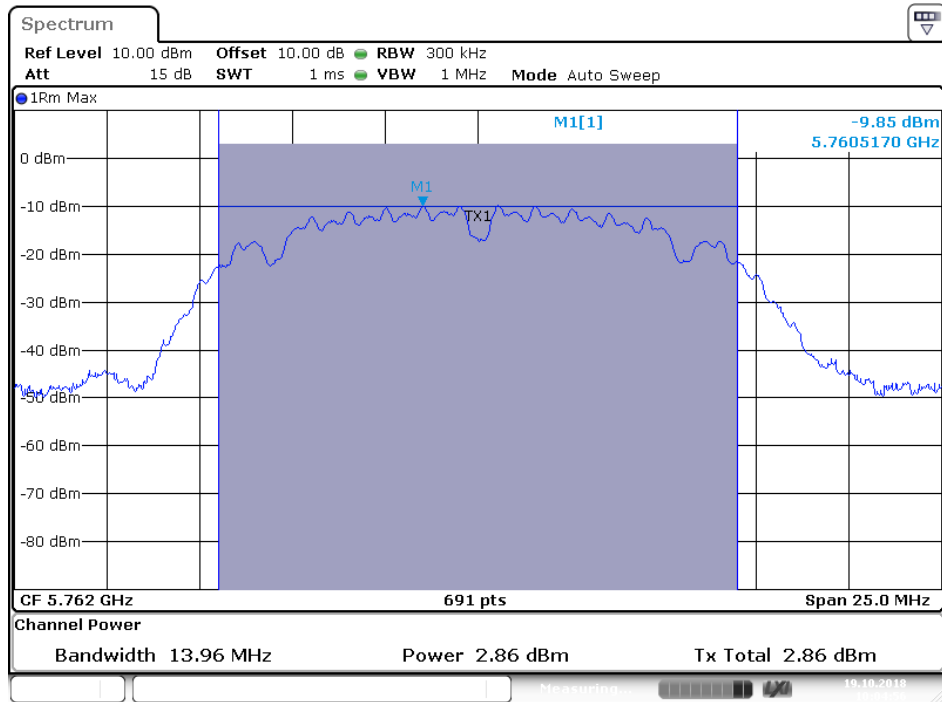

Date: 19.OCT.2018 10:04:56

High channel (Antenna B)

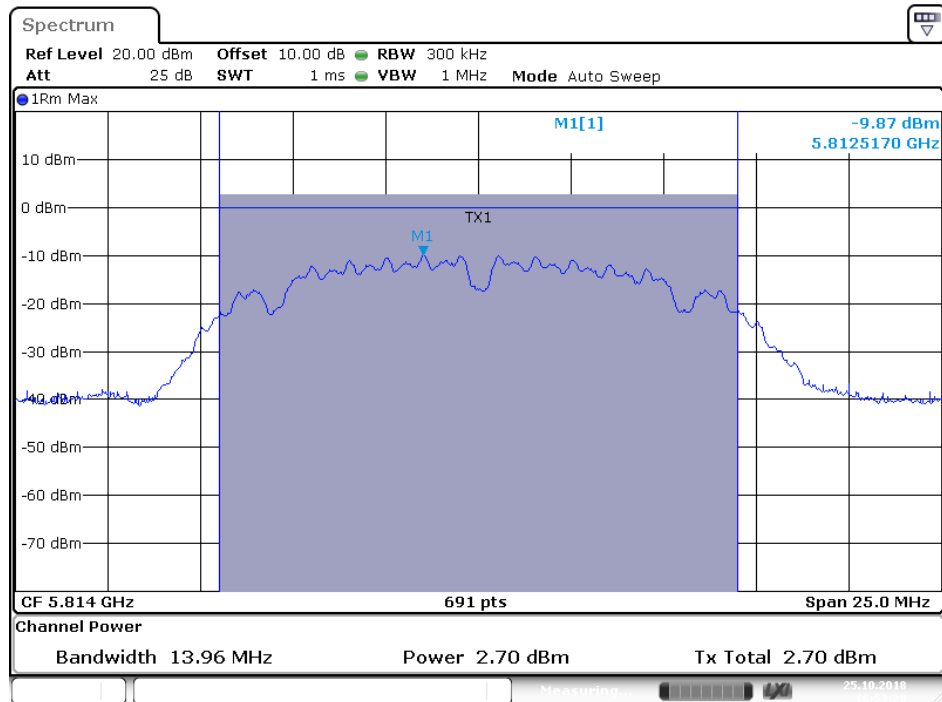

Date: 25.OCT.2018 16:53:28

10.RADIATED EMISSION TEST

10.1.Block Diagram of Test Setup

10.1.1.Block diagram of connection between the EUT and simulators

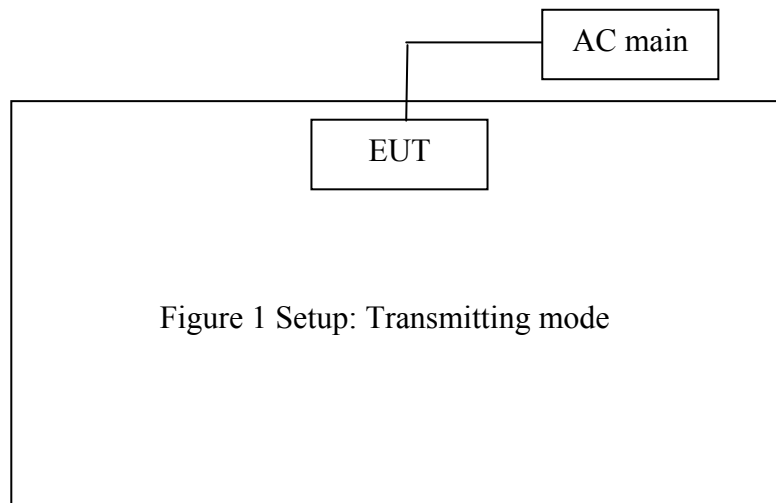

(EUT: DAC with headphone amplifier)

10.1.1.Semi-Anechoic Chamber Test Setup Diagram

(A) Radiated Emission Test Set-Up, Frequency below 30MHz

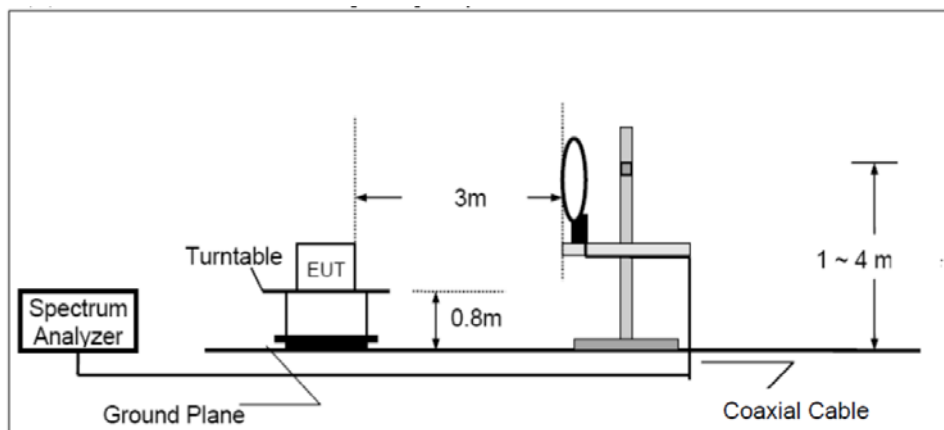

(B) Radiated Emission Test Set-Up, Frequency below 1GHz

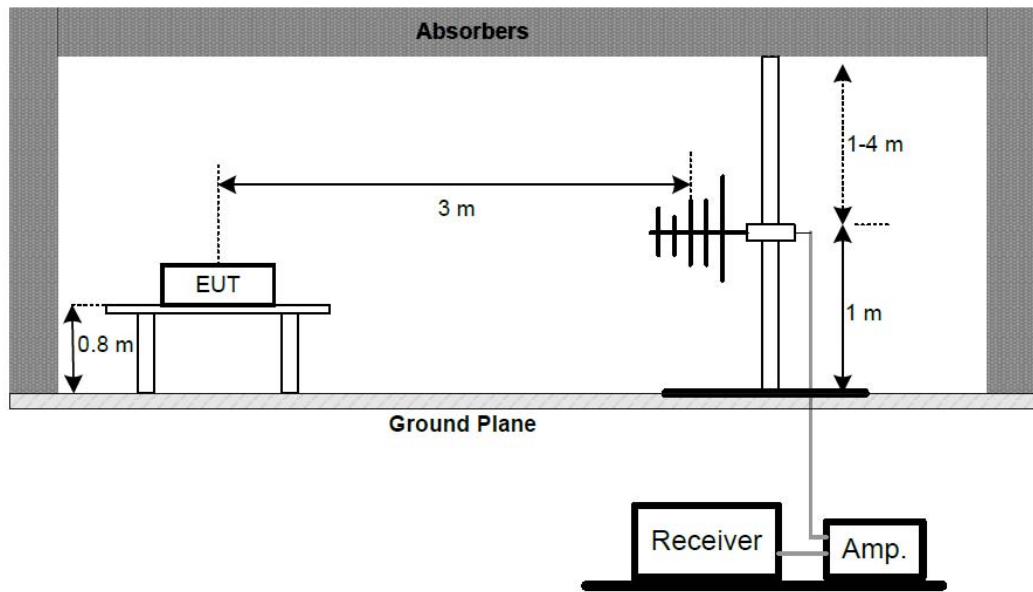

(C) Radiated Emission Test Set-Up, Frequency Above 1GHz

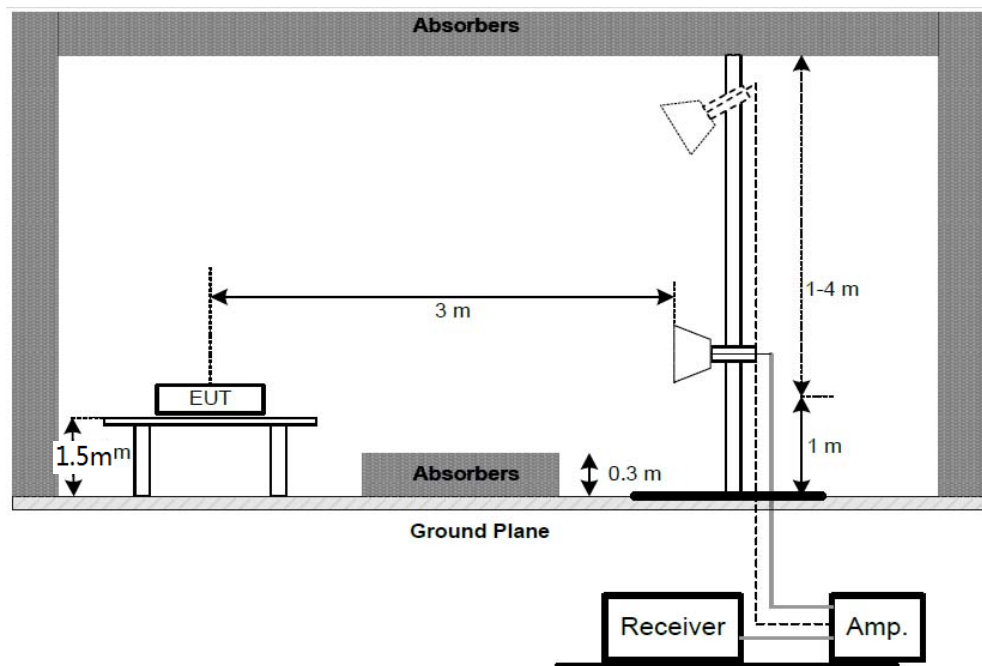

10.2. The Limit For Section 15.247(d)

Section 15.247(d): In any 100 kHz bandwidth outside the frequency band in which the spread spectrum or digitally modulated intentional radiator is operating, the radio frequency power that is produced by the intentional radiator shall be at least 20 dB below that in the 100 kHz bandwidth within the band that contains the highest level of the desired power, based on either an RF conducted or a radiated measurement, provided the

transmitter demonstrates compliance with the peak conducted power limits. If the transmitter complies with the conducted power limits based on the use of RMS averaging over a time interval, as permitted under paragraph (b)(3) of this section, the attenuation required under this paragraph shall be 30 dB instead of 20 dB. Attenuation below the general limits specified in Section 15.209(a) is not required. In addition, radiated emissions which fall in the restricted bands, as defined in Section 15.205(a), must also comply with the radiated emission limits specified in Section 15.209(a).

10.3.Restricted bands of operation

10.3.1.FCC Part 15.205 Restricted bands of operation

(a) Except as shown in paragraph (d) of this section, Only spurious emissions are permitted in any of the frequency bands listed below:

MHz	MHz	MHz	GHz
0.090-0.110	16.42-16.423	399.9-410	4.5-5.15
¹ 0.495-0.505	16.69475-16.69525	608-614	5.35-5.46
2.1735-2.1905	16.80425-16.80475	960-1240	7.25-7.75
4.125-4.128	25.5-25.67	1300-1427	8.025-8.5
4.17725-4.17775	37.5-38.25	1435-1626.5	9.0-9.2
4.20725-4.20775	73-74.6	1645.5-1646.5	9.3-9.5
6.215-6.218	74.8-75.2	1660-1710	10.6-12.7
6.26775-6.26825	108-121.94	1718.8-1722.2	13.25-13.4
6.31175-6.31225	123-138	2200-2300	14.47-14.5
8.291-8.294	149.9-150.05	2310-2390	15.35-16.2
8.362-8.366	156.52475-156.52525	2483.5-2500	17.7-21.4
8.37625-8.38675	156.7-156.9	2690-2900	22.01-23.12
8.41425-8.41475	162.0125-167.17	3260-3267	23.6-24.0
12.29-12.293	167.72-173.2	3332-3339	31.2-31.8
12.51975-12.52025	240-285	3345.8-3358	36.43-36.5
12.57675-12.57725	322-335.4	3600-4400	(²)
13.36-13.41			

¹Until February 1, 1999, this restricted band shall be 0.490-0.510

²Above 38.6

(b) Except as provided in paragraphs (d) and (e), the field strength of emission appearing within these frequency bands shall not exceed the limits shown in Section 15.209. At frequencies equal to or less than 1000MHz, Compliance with the limits in Section 15.209 shall be demonstrated using measurement instrumentation employing a CISPR quasi-peak detector. Above 1000MHz, compliance with the emission limits in Section 15.209 shall be demonstrated based on the average value of the measured emissions. The provisions in Section 15.35 apply to these measurements.

10.4.Configuration of EUT on Measurement

The equipment are installed on Radiated Emission Measurement to meet the commission requirements and operating regulations in a manner which tends to maximize its emission characteristics in normal application.

10.5. Test Procedure

The EUT and its simulators are placed on a turntable, which is 0.8 meter high above ground (Below 1GHz). The EUT and its simulators are placed on a turntable, which is 1.5 meter high above ground (Above 1GHz). The turntable can rotate 360 degrees to determine the position of the maximum emission level. EUT is set 3.0 meters away from the receiving antenna, which is mounted on an antenna tower. The antenna can be moved up and down between 1.0 meter and 4 meters to find out the maximum emission level. Broadband antenna (calibrated bilog antenna) is used as receiving antenna. Both horizontal and vertical polarizations of the antenna are set on measurement. In order to find the maximum emission levels, all of the interface cables must be manipulated according to ANSI C63.10:2013 on radiated emission measurement.

The bandwidth of test receiver (R&S ESI26) is set at 120 KHz in 30-1000MHz. and set at 1MHz in above 1000MHz.

The frequency range from 30MHz to 40000MHz is checked.

The final measurement in band 9-90 kHz, 110-490 kHz and above 1000MHz is performed with Average detector. Except those frequency bands mention above, the final measurement for frequencies below 1000MHz is performed with Quasi Peak detector.

The field strength is calculated by adding the antenna factor, and cable loss, and subtracting the amplifier gain from the measured reading. The basic equation calculation is as follows:

Result = Reading + Corrected Factor

Where Corrected Factor = Antenna Factor + Cable Loss – Amplifier Gain

10.6. Data Sample

Frequency (MHz)	Reading (dB μ v)	Factor (dB/m)	Result (dB μ v/m)	Limit (dB μ v/m)	Margin (dB)	Remark
X.XX	28.66	-15.19	13.47	40.0	-26.53	QP

Frequency(MHz) = Emission frequency in MHz

Reading(dB μ v) = Uncorrected Analyzer/Receiver reading

Factor (dB/m) = Antenna factor + Cable Loss – Amplifier gain

Result(dB μ v/m) = Reading(dB μ v) + Factor(dB/m)

Limit (dB μ v/m) = Limit stated in standard

Margin (dB) = Result(dB μ v/m) - Limit (dB μ v/m)

QP = Quasi-peak Reading

Calculation Formula:

Margin(dB) = Result (dB μ V/m)–Limit(dB μ V/m)

Result(dB μ V/m)= Reading(dB μ V)+ Factor(dB/m)

The “Margin” column of the following data tables indicates the degree of compliance with the applicable limit. For example, a margin of -7dB means the emission is 7dB below the limit.

10.7. The Field Strength of Radiation Emission Measurement Results

Note:

- 1. The radiation emissions in the frequency band of 9kHz-30MHz are not reported, because the test values are too low against the limit.**
- 2. we tested radiation emission of Antenna A and Antenna B, The following test data is the worst case(Antenna A) data which I have recorded**
- 3. The average measurement was not performed when peak measured data under the limit of average detection.**

30MHz -1GHz test data

ACCURATE TECHNOLOGY CO., LTD.

 F1,Bldg,A,Changyuan New Material Port Keyuan Rd,
 Science & Industry Park,Nanshan Shenzhen,P.R.China

Site: 1# Chamber

Tel:+86-0755-26503290

Fax:+86-0755-26503396

Job No.: frank2018 #1906

Standard: FCC Class B 3M Radiated

Test item: Radiation Test

Temp.(C)/Hum.(%) 25 C / 55 %

EUT: DAC with headphone amplifier

Mode: TX 5736MHz

Model: CMA Twelve

Manufacturer: Questyle Audio Technology Co.,Ltd

Polarization: Horizontal

Power Source: AC 120V/60Hz

Date: 2018/10/22

Time: 14:18:59

Engineer Signature:

Distance:

Note: Report NO.:ATE20181770

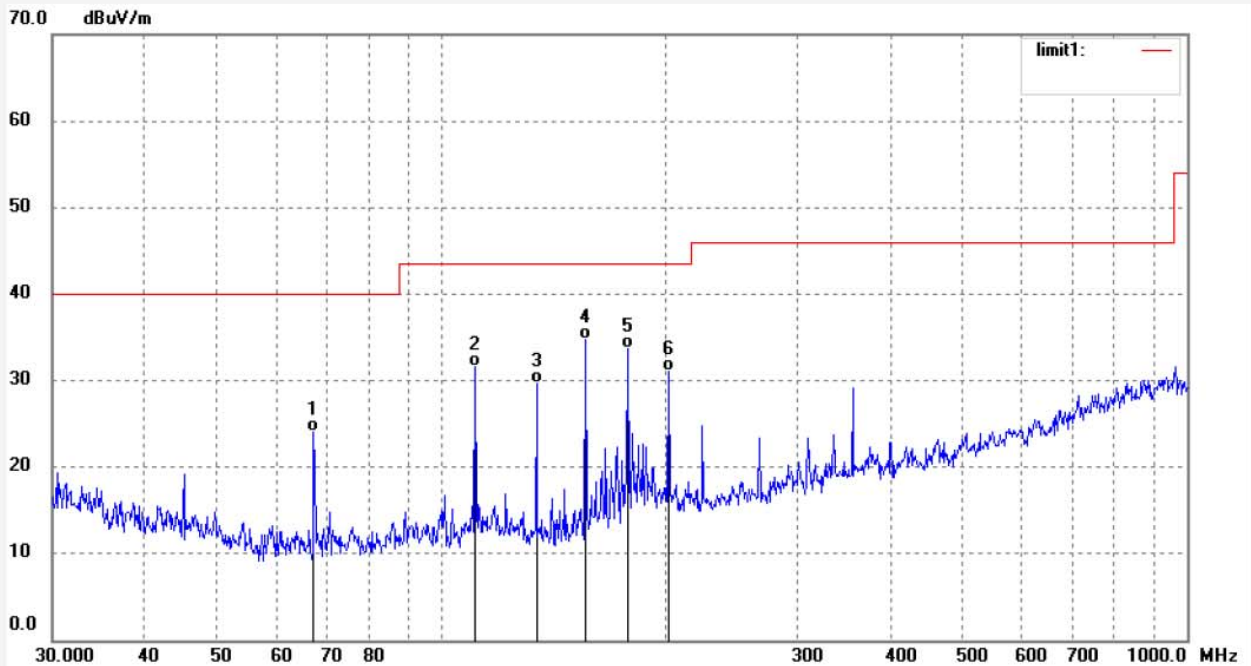

No.	Freq. (MHz)	Reading (dBuV/m)	Factor (dB)	Result (dBuV/m)	Limit (dBuV/m)	Margin (dB)	Detector	Height (cm)	Degree (deg.)	Remark
1	67.3109	46.90	-22.76	24.14	40.00	-15.86	QP	200	91	
2	110.8580	52.61	-21.08	31.53	43.50	-11.97	QP	200	69	
3	134.0192	51.56	-21.88	29.68	43.50	-13.82	QP	200	201	
4	155.8771	56.58	-21.79	34.79	43.50	-8.71	QP	200	212	
5	177.5178	54.28	-20.56	33.72	43.50	-9.78	QP	200	32	
6	201.4539	49.68	-18.65	31.03	43.50	-12.47	QP	200	210	

Job No.: frank2018 #1905

Standard: FCC Class B 3M Radiated

Test item: Radiation Test

Temp.(C)/Hum.(%) 25 C / 55 %

EUT: DAC with headphone amplifier

Mode: TX 5736MHz

Model: CMA Twelve

Manufacturer: Questyle Audio Technology Co.,Ltd

Polarization: Vertical

Power Source: AC 120V/60Hz

Date: 2018/10/22

Time: 14:18:19

Engineer Signature:

Distance:

Note: Report NO.:ATE20181770

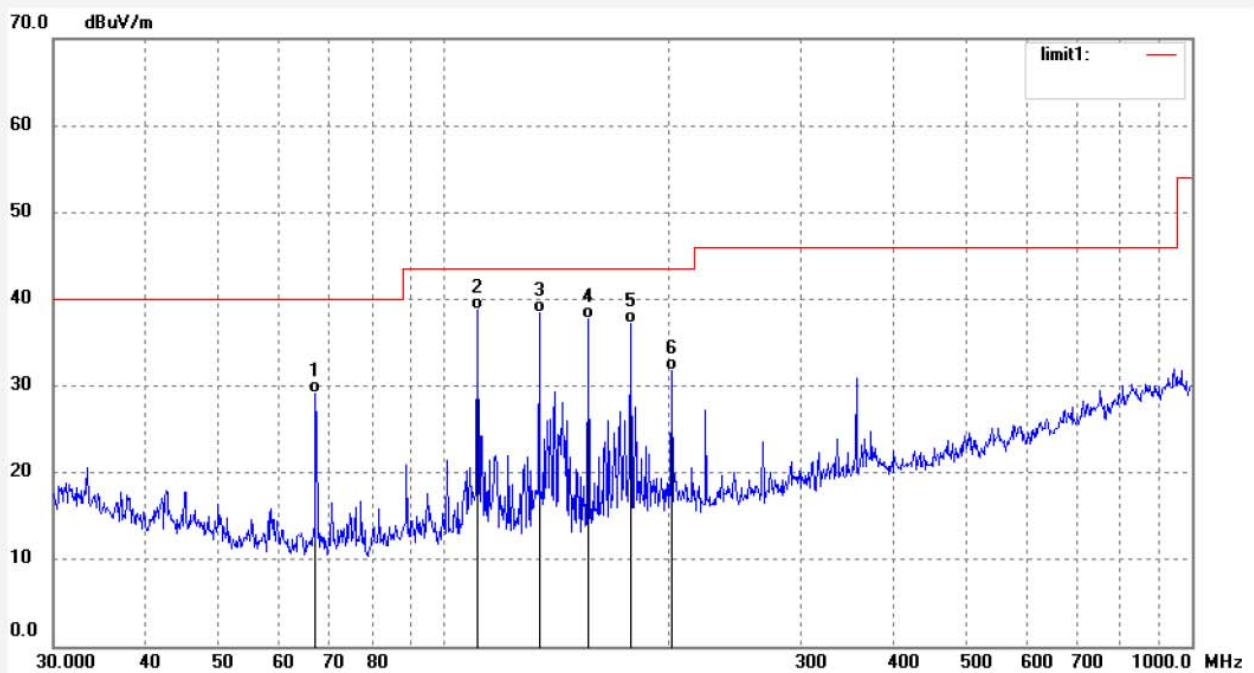

No.	Freq. (MHz)	Reading (dBuV/m)	Factor (dB)	Result (dBuV/m)	Limit (dBuV/m)	Margin (dB)	Detector	Height (cm)	Degree (deg.)	Remark
1	67.3109	51.96	-22.76	29.20	40.00	-10.80	QP	100	201	
2	110.8580	59.90	-21.08	38.82	43.50	-4.68	QP	100	121	
3	134.0192	60.34	-21.88	38.46	43.50	-5.04	QP	100	211	
4	155.8771	59.51	-21.79	37.72	43.50	-5.78	QP	100	84	
5	177.5176	57.72	-20.56	37.16	43.50	-6.34	QP	100	33	
6	201.4539	50.48	-18.65	31.83	43.50	-11.67	QP	100	201	

Job No.: frank2018 #1907
 Standard: FCC Class B 3M Radiated
 Test item: Radiation Test
 Temp.(C)/Hum.(%) 25 C / 55 %
 EUT: DAC with headphone amplifier
 Mode: TX 5762MHz
 Model: CMA Twelve
 Manufacturer: Questyle Audio Technology Co.,Ltd

Polarization: Horizontal
 Power Source: AC 120V/60Hz
 Date: 2018/10/22
 Time: 14:19:09
 Engineer Signature:
 Distance:

Note: Report NO.:ATE20181770

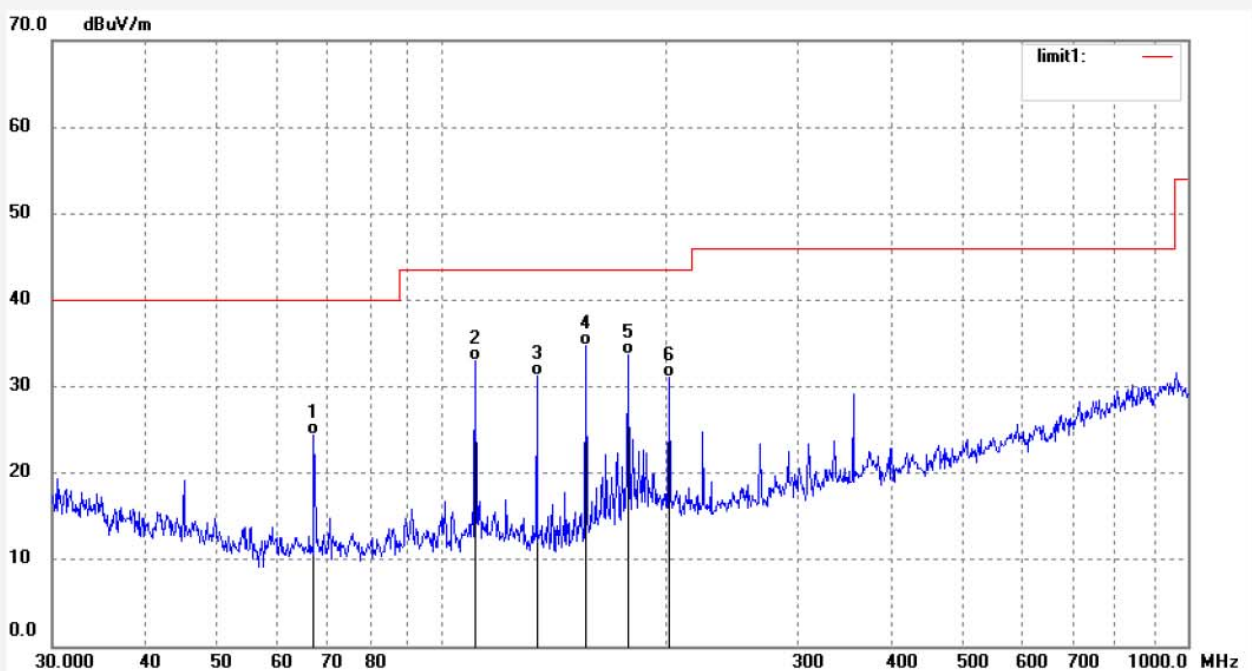

No.	Freq. (MHz)	Reading (dBuV/m)	Factor (dB)	Result (dBuV/m)	Limit (dBuV/m)	Margin (dB)	Detector	Height (cm)	Degree (deg.)	Remark
1	67.3109	47.21	-22.76	24.45	40.00	-15.55	QP	200	69	
2	110.8580	54.14	-21.08	33.06	43.50	-10.44	QP	200	201	
3	134.0192	53.07	-21.88	31.19	43.50	-12.31	QP	200	211	
4	155.8771	56.58	-21.79	34.79	43.50	-8.71	QP	200	63	
5	177.5178	54.28	-20.56	33.72	43.50	-9.78	QP	200	122	
6	201.4539	49.68	-18.65	31.03	43.50	-12.47	QP	200	320	

Job No.: frank2018 #1908
 Standard: FCC Class B 3M Radiated
 Test item: Radiation Test
 Temp.(C)/Hum.(%) 25 C / 55 %
 EUT: DAC with headphone amplifier
 Mode: TX 5762MHz
 Model: CMA Twelve
 Manufacturer: Questyle Audio Technology Co.,Ltd

Polarization: Vertical
 Power Source: AC 120V/60Hz
 Date: 2018/10/22
 Time: 14:19:39
 Engineer Signature:
 Distance:

Note: Report NO.:ATE20181770

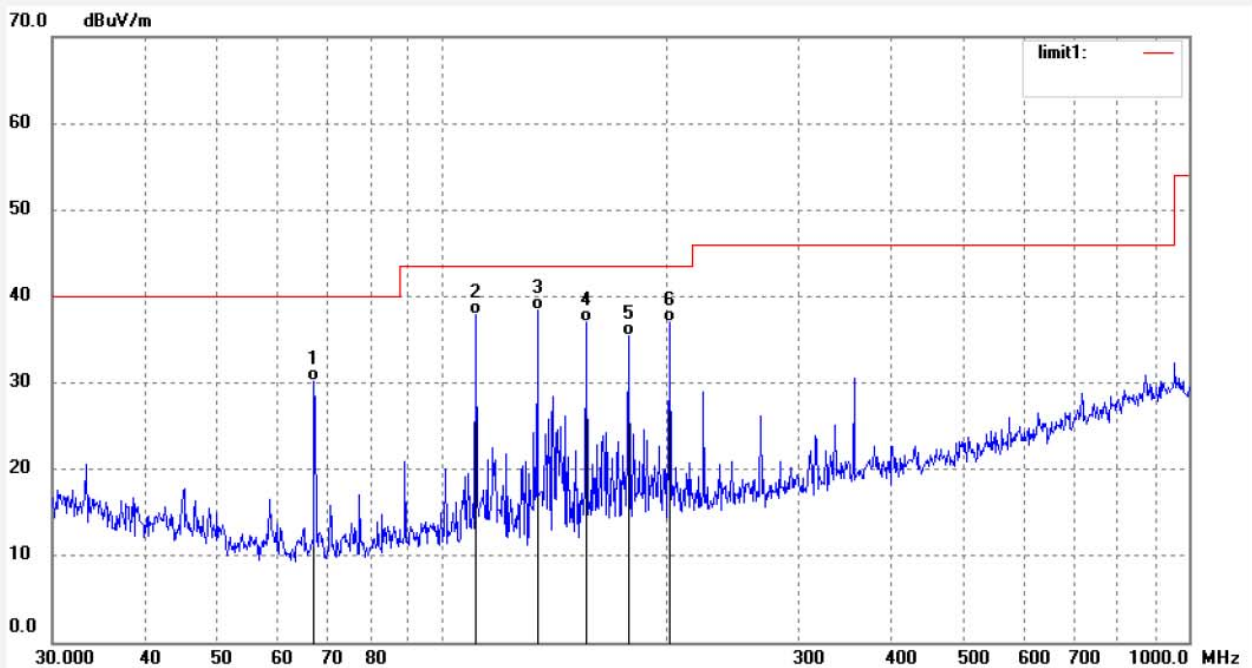

No.	Freq. (MHz)	Reading (dBuV/m)	Factor (dB)	Result (dBuV/m)	Limit (dBuV/m)	Margin (dB)	Detector	Height (cm)	Degree (deg.)	Remark
1	67.3109	52.89	-22.76	30.13	40.00	-9.87	QP	100	230	
2	110.8580	59.03	-21.08	37.95	43.50	-5.55	QP	100	112	
3	134.0192	60.36	-21.88	38.48	43.50	-5.02	QP	100	52	
4	155.8771	58.73	-21.79	36.94	43.50	-6.56	QP	100	48	
5	177.5176	56.04	-20.56	35.48	43.50	-8.02	QP	100	156	
6	201.4539	55.69	-18.65	37.04	43.50	-6.46	QP	100	302	

Job No.: frank2018 #1910
 Standard: FCC Class B 3M Radiated
 Test item: Radiation Test
 Temp.(C)/Hum.(%) 25 C / 55 %
 EUT: DAC with headphone amplifier
 Mode: TX 5814MHz
 Model: CMA Twelve
 Manufacturer: Questyle Audio Technology Co.,Ltd

Polarization: Horizontal
 Power Source: AC 120V/60Hz
 Date: 2018/10/22
 Time: 14:20:34
 Engineer Signature:
 Distance:

Note: Report NO.:ATE20181770

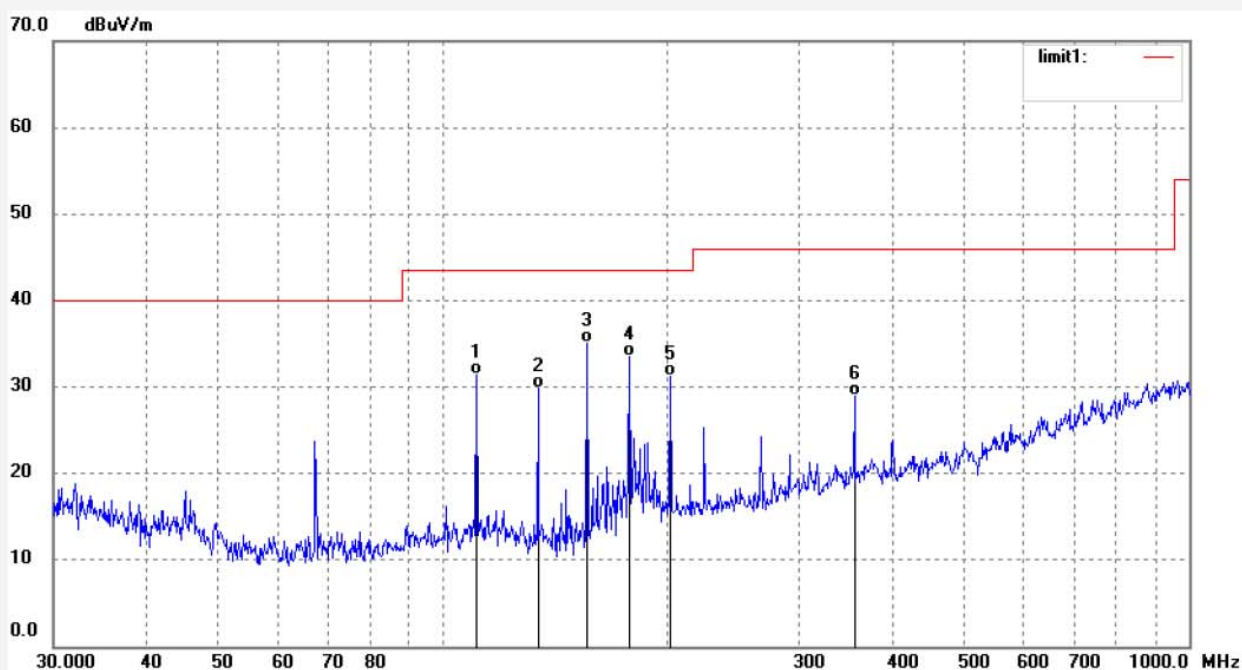

No.	Freq. (MHz)	Reading (dBuV/m)	Factor (dB)	Result (dBuV/m)	Limit (dBuV/m)	Margin (dB)	Detector	Height (cm)	Degree (deg.)	Remark
1	110.8580	52.46	-21.08	31.38	43.50	-12.12	QP	200	201	
2	134.0192	51.68	-21.88	29.80	43.50	-13.70	QP	200	323	
3	155.8771	56.95	-21.79	35.16	43.50	-8.34	QP	200	148	
4	177.5176	54.03	-20.56	33.47	43.50	-10.03	QP	200	49	
5	201.4539	49.88	-18.65	31.23	43.50	-12.27	QP	200	225	
6	355.9397	43.32	-14.44	28.88	46.00	-17.12	QP	200	103	

Job No.: frank2018 #1909
 Standard: FCC Class B 3M Radiated
 Test item: Radiation Test
 Temp.(C)/Hum.(%) 25 C / 55 %
 EUT: DAC with headphone amplifier
 Mode: TX 5814MHz
 Model: CMA Twelve
 Manufacturer: Questyle Audio Technology Co.,Ltd

Polarization: Vertical
 Power Source: AC 120V/60Hz
 Date: 2018/10/22
 Time: 14:19:51
 Engineer Signature:
 Distance:

Note: Report NO.:ATE20181770

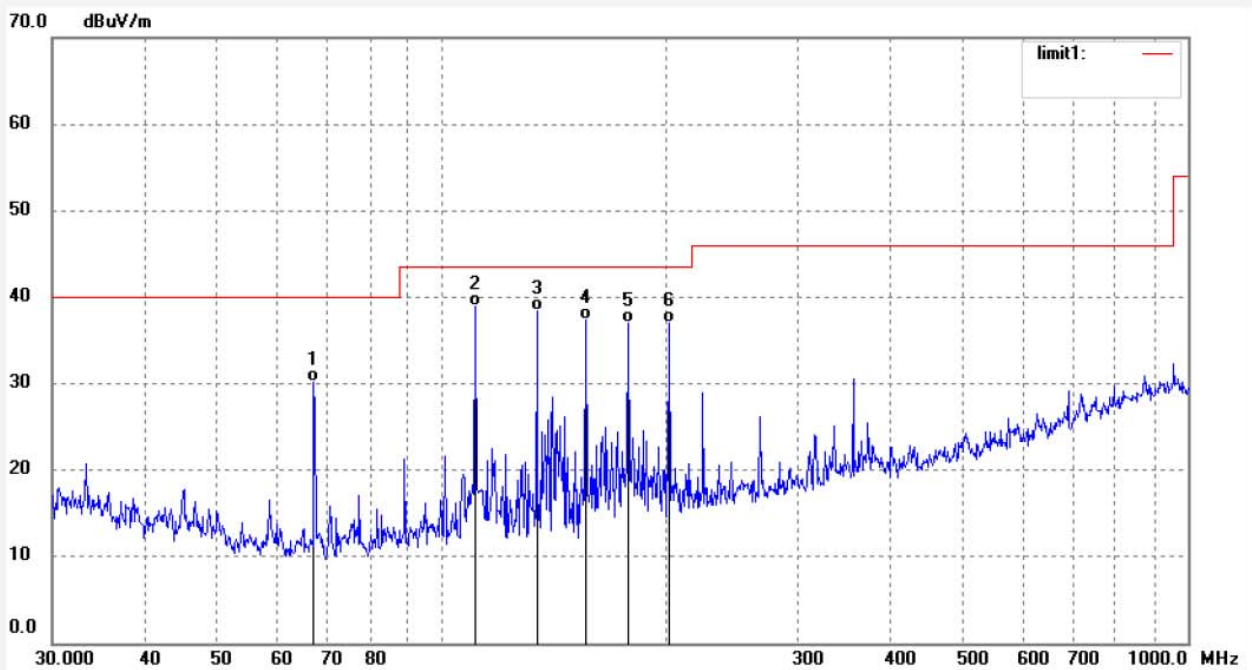

No.	Freq. (MHz)	Reading (dBuV/m)	Factor (dB)	Result (dBuV/m)	Limit (dBuV/m)	Margin (dB)	Detector	Height (cm)	Degree (deg.)	Remark
1	67.3109	52.94	-22.76	30.18	40.00	-9.82	QP	100	323	
2	110.8580	60.03	-21.08	38.95	43.50	-4.55	QP	100	310	
3	134.0192	60.36	-21.88	38.48	43.50	-5.02	QP	100	211	
4	155.8771	59.23	-21.79	37.44	43.50	-6.06	QP	100	59	
5	177.5176	57.54	-20.56	36.98	43.50	-6.52	QP	100	125	
6	201.4539	55.69	-18.65	37.04	43.50	-6.46	QP	100	301	

1GHz -18GHz test data



ACCURATE TECHNOLOGY CO., LTD.

F1,Bldg,A,Changyuan New Material Port Keyuan Rd,
Science & Industry Park,Nanshan Shenzhen,P.R.China

Site: 1# Chamber

Tel:+86-0755-26503290

Fax:+86-0755-26503396

Job No.: frank2018 #1923	Polarization: Horizontal
Standard: FCC PK	Power Source: AC 120V/60Hz
Test item: Radiation Test	Date: 2018/10/22
Temp.(C)/Hum.(%) 25 C / 55 %	Time: 16:07:39
EUT: DAC with headphone amplifier	Engineer Signature:
Mode: TX 5736MHz	Distance:
Model: CMA Twelve	
Manufacturer: Questyle Audio Technology Co.,Ltd	

Note: Report NO.:ATE20181770

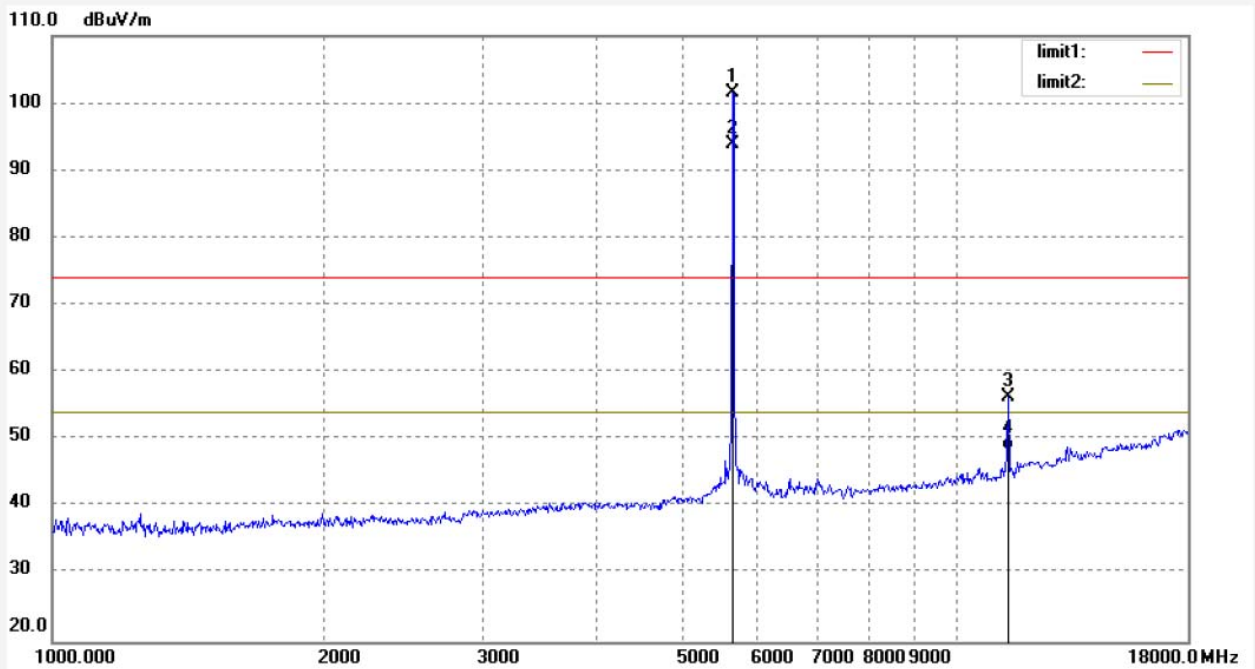

No.	Freq. (MHz)	Reading (dBuV/m)	Factor (dB)	Result (dBuV/m)	Limit (dBuV/m)	Margin (dB)	Detector	Height (cm)	Degree (deg.)	Remark
1	5736.350	102.13	-0.52	101.61			peak	250	50	
2	5736.350	94.45	-0.52	93.93			AVG	250	266	
3	11472.391	49.85	6.41	56.26	74.00	-17.74	peak	250	218	
4	11472.391	42.12	6.41	48.53	54.00	-5.47	AVG	250	94	

Job No.: frank2018 #1924
 Standard: FCC PK
 Test item: Radiation Test
 Temp.(C)/Hum.(%) 25 C / 55 %
 EUT: DAC with headphone amplifier
 Mode: TX 5736MHz
 Model: CMA Twelve
 Manufacturer: Questyle Audio Technology Co.,Ltd

Polarization: Vertical
 Power Source: AC 120V/60Hz
 Date: 2018/10/22
 Time: 16:08:43
 Engineer Signature:
 Distance:

Note: Report NO.:ATE20181770

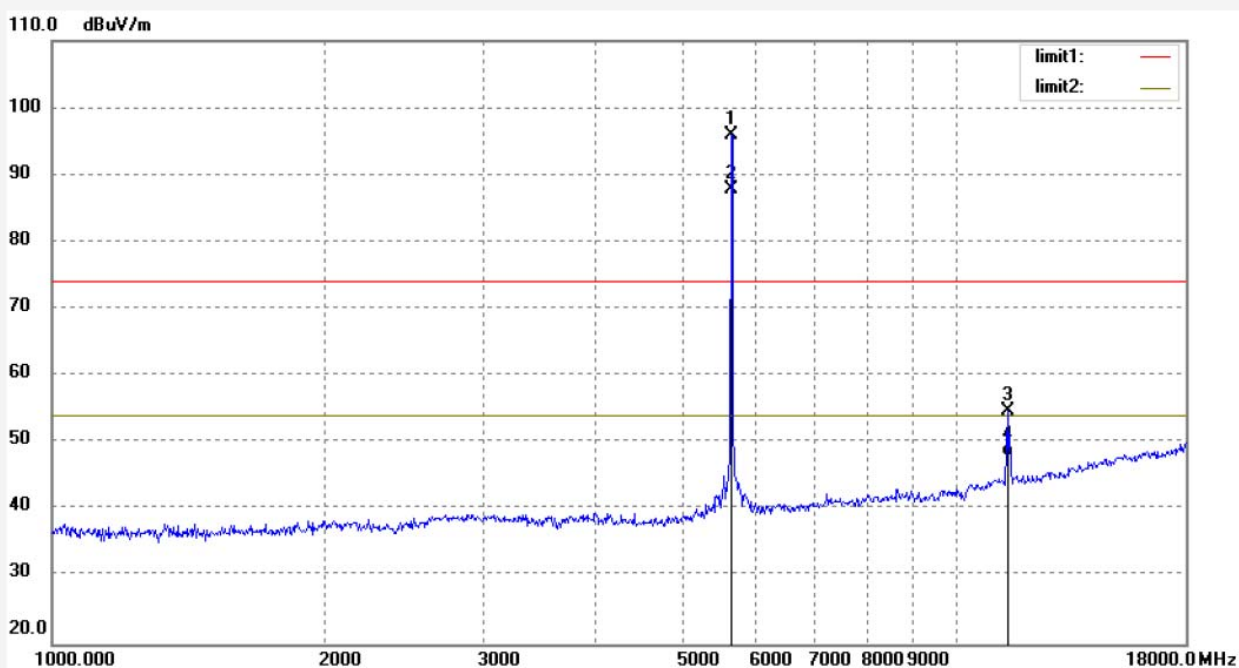

No.	Freq. (MHz)	Reading (dBuV/m)	Factor (dB)	Result (dBuV/m)	Limit (dBuV/m)	Margin (dB)	Detector	Height (cm)	Degree (deg.)	Remark
1	5736.350	96.53	-0.52	96.01			peak	150	201	
2	5736.350	88.45	-0.52	87.93			AVG	150	47	
3	11472.614	48.34	6.45	54.79	74.00	-19.21	peak	150	218	
4	11472.614	41.48	6.45	47.93	54.00	-6.07	AVG	150	106	

Job No.: frank2018 #1926
Standard: FCC PK
Test item: Radiation Test
Temp.(C)/Hum.(%) 25 C / 55 %
EUT: DAC with headphone amplifier
Mode: TX 5762MHz
Model: CMA Twelve
Manufacturer: Questyle Audio Technology Co.,Ltd

Polarization: Horizontal
Power Source: AC 120V/60Hz
Date: 2018/10/22
Time: 16:12:30
Engineer Signature:
Distance:

Note: Report NO.:ATE20181770

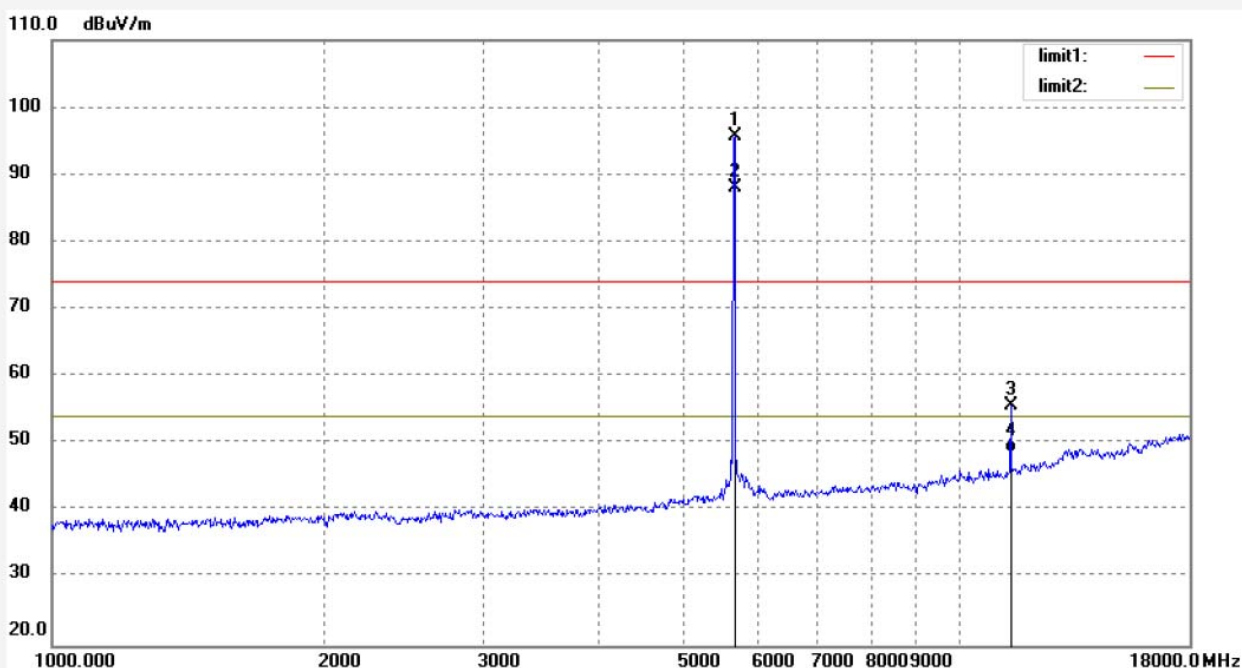

No.	Freq. (MHz)	Reading (dBuV/m)	Factor (dB)	Result (dBuV/m)	Limit (dBuV/m)	Margin (dB)	Detector	Height (cm)	Degree (deg.)	Remark
1	5762.424	96.20	-0.49	95.71			peak	250	141	
2	5762.424	88.49	-0.49	88.00			AVG	250	48	
3	11524.866	49.25	6.45	55.70	74.00	-18.30	peak	250	156	
4	11524.866	42.17	6.45	48.62	54.00	-5.38	AVG	250	302	



ACCURATE TECHNOLOGY CO., LTD.

F1,Bldg,A,Changyuan New Material Port Keyuan Rd,
Science & Industry Park,Nanshan Shenzhen,P.R.China

Site: 1# Chamber

Tel:+86-0755-26503290

Fax:+86-0755-26503396

Job No.: frank2018 #1925	Polarization: Vertical
Standard: FCC PK	Power Source: AC 120V/60Hz
Test item: Radiation Test	Date: 2018/10/22
Temp.(C)/Hum.(%) 25 C / 55 %	Time: 16:11:04
EUT: DAC with headphone amplifier	Engineer Signature:
Mode: TX 5762MHz	Distance:
Model: CMA Twelve	
Manufacturer: Questyle Audio Technology Co.,Ltd	

Note: Report NO.:ATE20181770

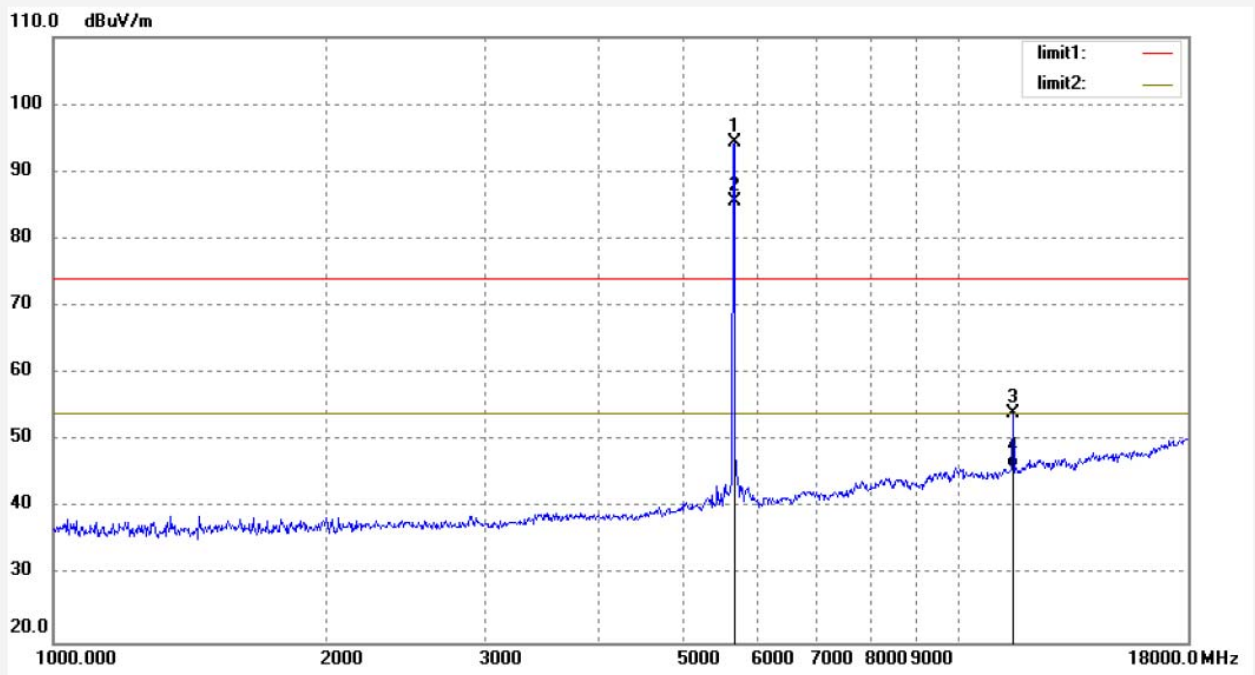

No.	Freq. (MHz)	Reading (dBuV/m)	Factor (dB)	Result (dBuV/m)	Limit (dBuV/m)	Margin (dB)	Detector	Height (cm)	Degree (deg.)	Remark
1	5762.424	94.89	-0.49	94.40			peak	150	201	
2	5762.424	86.15	-0.49	85.66			AVG	150	62	
3	11524.866	47.45	6.59	54.04	74.00	-19.96	peak	150	154	
4	11524.866	39.45	6.59	46.04	54.00	-7.96	AVG	150	302	

Job No.: frank2018 #1927	Polarization: Horizontal
Standard: FCC PK	Power Source: AC 120V/60Hz
Test item: Radiation Test	Date: 2018/10/22
Temp.(C)/Hum.(%) 25 C / 55 %	Time: 16:16:30
EUT: DAC with headphone amplifier	Engineer Signature:
Mode: TX 5814MHz	Distance:
Model: CMA Twelve	
Manufacturer: Questyle Audio Technology Co.,Ltd	

Note: Report NO.:ATE20181770

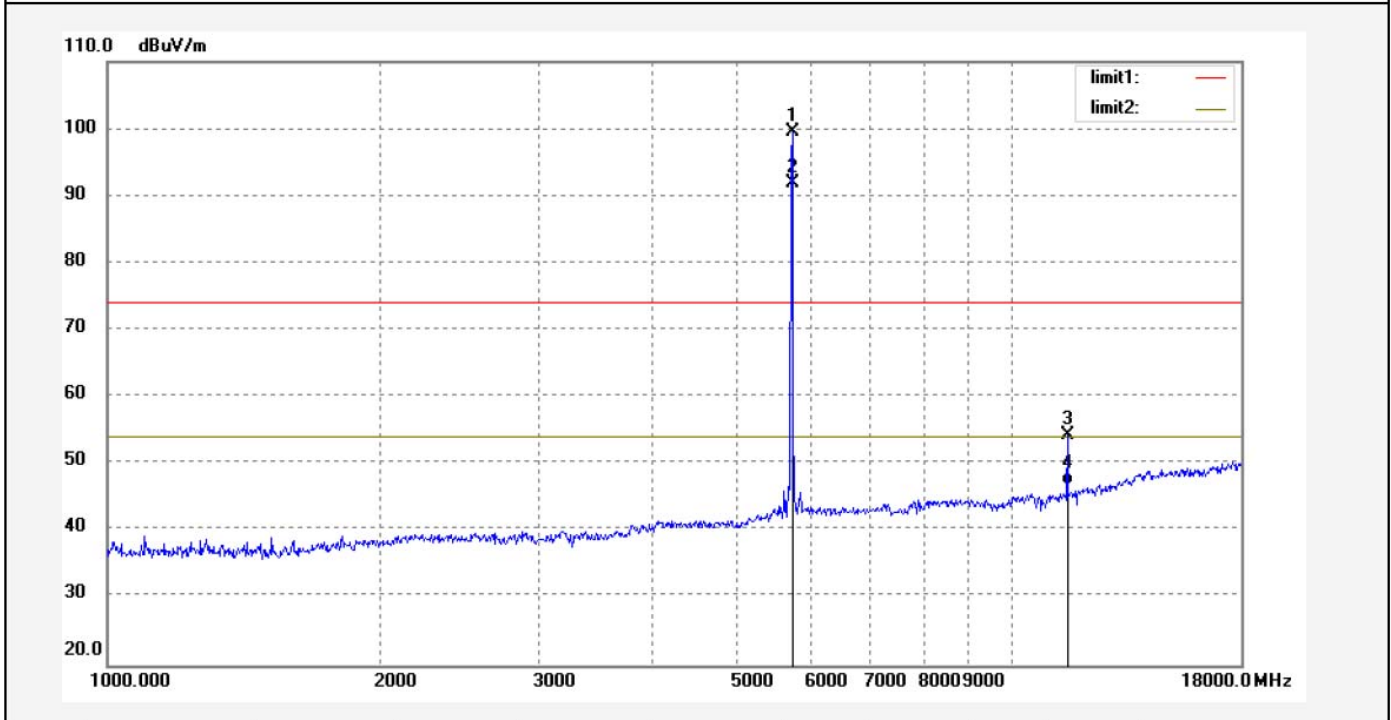

No.	Freq. (MHz)	Reading (dBuV/m)	Factor (dB)	Result (dBuV/m)	Limit (dBuV/m)	Margin (dB)	Detector	Height (cm)	Degree (deg.)	Remark
1	5814.200	99.98	-0.37	99.61			peak	250	58	
2	5814.200	92.31	-0.37	91.94			AVG	250	259	
3	11628.479	47.58	6.64	54.22	74.00	-19.78	peak	250	123	
4	11628.479	40.14	6.64	46.78	54.00	-7.22	AVG	250	102	

Job No.: frank2018 #1928
 Standard: FCC PK
 Test item: Radiation Test
 Temp.(C)/Hum.(%) 25 C / 55 %
 EUT: DAC with headphone amplifier
 Mode: TX 5814MHz
 Model: CMA Twelve
 Manufacturer: Questyle Audio Technology Co.,Ltd

Polarization: Vertical
 Power Source: AC 120V/60Hz
 Date: 2018/10/22
 Time: 16:17:38
 Engineer Signature:
 Distance:

Note: Report NO.:ATE20181770

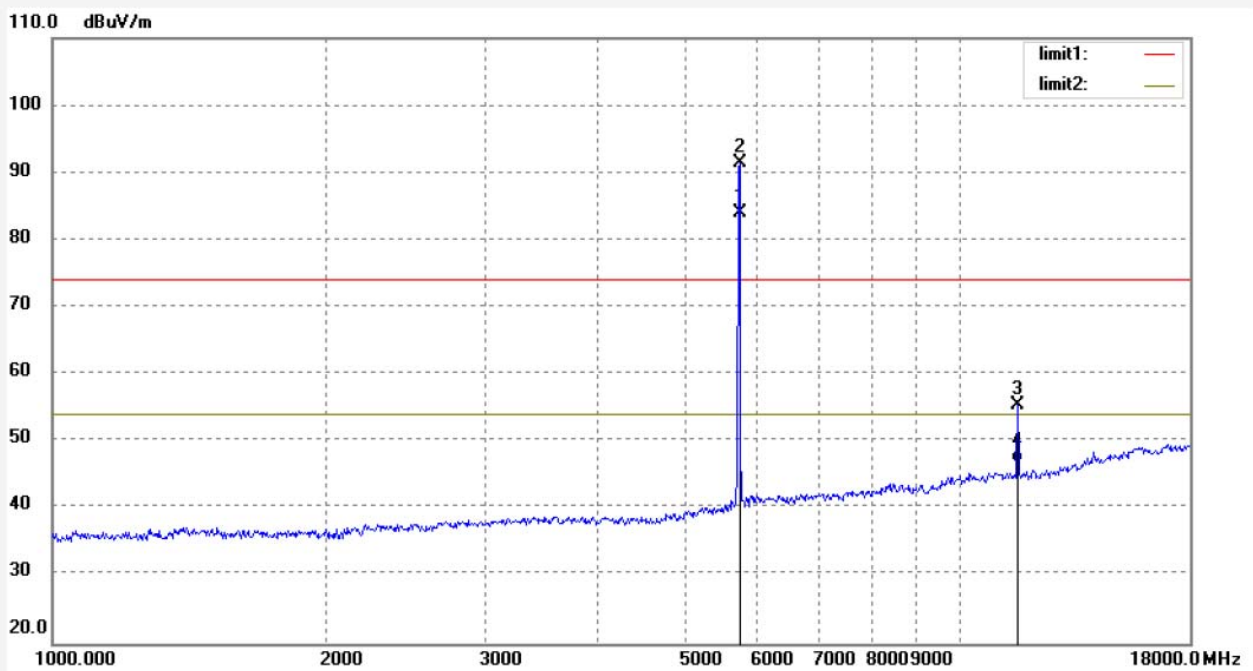

No.	Freq. (MHz)	Reading (dBuV/m)	Factor (dB)	Result (dBuV/m)	Limit (dBuV/m)	Margin (dB)	Detector	Height (cm)	Degree (deg.)	Remark
1	5814.200	91.80	-0.37	91.43			peak	150	69	
2	5814.200	84.45	-0.37	84.08			AVG	150	70	
3	11628.479	48.76	6.71	55.47	74.00	-18.53	peak	150	103	
4	11628.479	40.15	6.71	46.86	54.00	-7.14	AVG	150	91	

18GHz -26.5GHz test data

ACCURATE TECHNOLOGY CO., LTD.

 F1,Bldg,A,Changyuan New Material Port Keyuan Rd,
 Science & Industry Park,Nanshan Shenzhen,P.R.China

Site: 2# Chamber

Tel:+86-0755-26503290

Fax:+86-0755-26503396

Job No.: LGW2018 #2466

Standard: FCC 15.247 3M Radiated

Test item: Radiation Test

Temp.(C)/Hum.(%) 23 C / 48 %

EUT: DAC with headphone amplifier

Mode: TX 5736MHz

Model: CMA Twelve

Manufacturer: Questyle Audio Technology Co.,Ltd

Polarization: Horizontal

Power Source: AC 120V/60Hz

Date: 2018/10/22

Time: 16:39:41

Engineer Signature: WADE

Distance: 3m

Note: Report NO.:ATE20181770

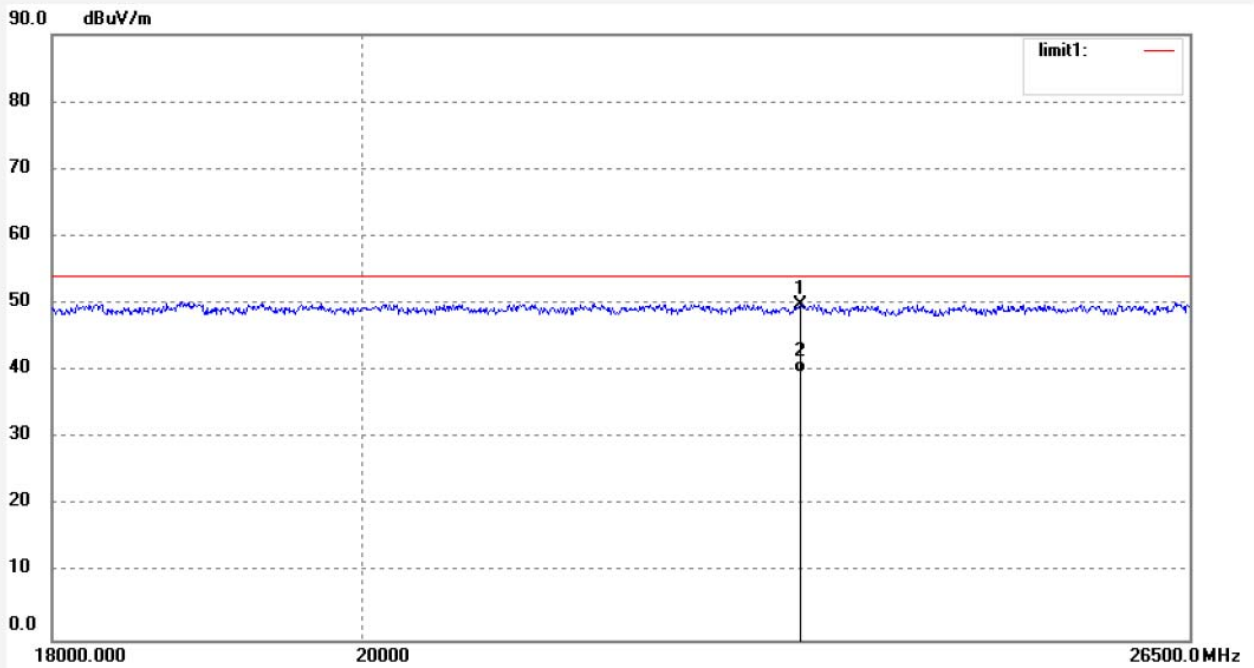

No.	Freq. (MHz)	Reading (dBuV/m)	Factor (dB)	Result (dBuV/m)	Limit (dBuV/m)	Margin (dB)	Detector	Height (cm)	Degree (deg.)	Remark
1	23216.619	10.13	39.78	49.91	74.00	-24.09	peak	150	218	
2	23216.619	-0.10	39.78	39.68	54.00	-14.32	AVG	150	47	



ACCURATE TECHNOLOGY CO., LTD.

F1,Bldg,A,Changyuan New Material Port Keyuan Rd,
Science & Industry Park,Nanshan Shenzhen,P.R.China

Site: 2# Chamber

Tel:+86-0755-26503290

Fax:+86-0755-26503396

Job No.: LGW2018 #2467	Polarization: Vertical
Standard: FCC 15.247 3M Radiated	Power Source: AC 120V/60Hz
Test item: Radiation Test	Date: 2018/10/22
Temp.(C)/Hum.(%) 23 C / 48 %	Time: 16:41:45
EUT: DAC with headphone amplifier	Engineer Signature: WADE
Mode: TX 5736MHz	Distance: 3m
Model: CMA Twelve	
Manufacturer: Questyle Audio Technology Co.,Ltd	

Note: Report NO.:ATE20181770

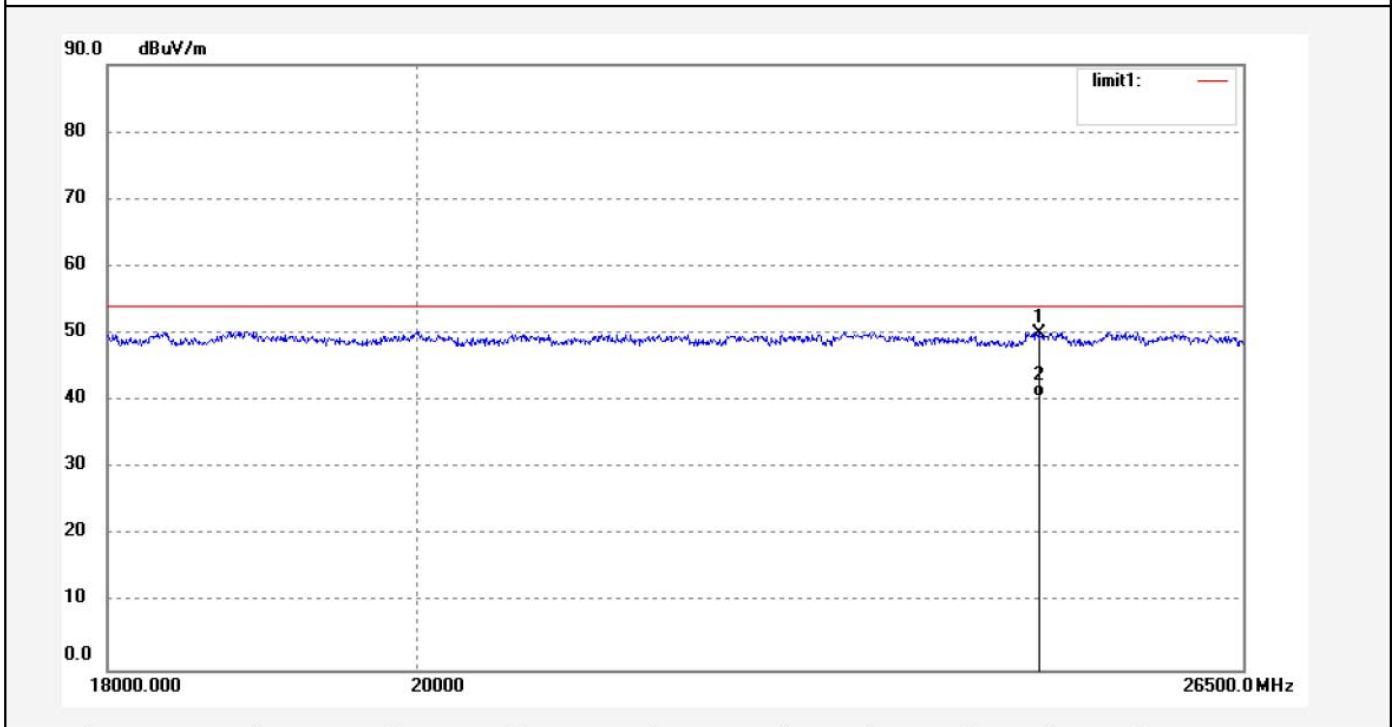

No.	Freq. (MHz)	Reading (dBuV/m)	Factor (dB)	Result (dBuV/m)	Limit (dBuV/m)	Margin (dB)	Detector	Height (cm)	Degree (deg.)	Remark
1	24717.849	9.47	40.60	50.07	74.00	-23.93	peak	200	218	
2	24717.849	-0.03	40.60	40.57	54.00	-13.43	AVG	200	317	



ACCURATE TECHNOLOGY CO., LTD.

F1,Bldg,A,Changyuan New Material Port Keyuan Rd,
Science & Industry Park,Nanshan Shenzhen,P.R.China

Site: 2# Chamber

Tel:+86-0755-26503290

Fax:+86-0755-26503396

Job No.: LGW2018 #2469	Polarization: Horizontal
Standard: FCC 15.247 3M Radiated	Power Source: AC 120V/60Hz
Test item: Radiation Test	Date: 2018/10/22
Temp.(C)/Hum.(%) 23 C / 48 %	Time: 16:46:13
EUT: DAC with headphone amplifier	Engineer Signature: WADE
Mode: TX 5762MHz	Distance: 3m
Model: CMA Twelve	
Manufacturer: Questyle Audio Technology Co.,Ltd	

Note: Report NO.:ATE20181770

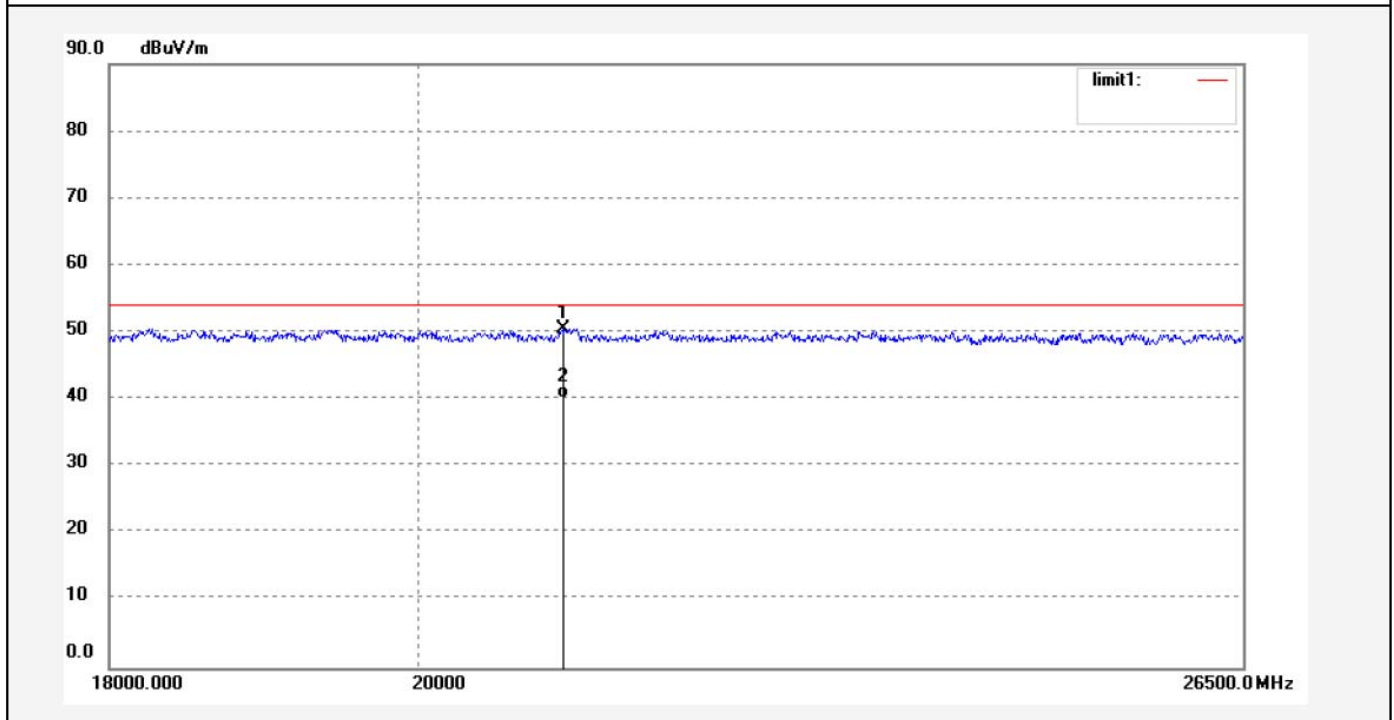

No.	Freq. (MHz)	Reading (dBuV/m)	Factor (dB)	Result (dBuV/m)	Limit (dBuV/m)	Margin (dB)	Detector	Height (cm)	Degree (deg.)	Remark
1	21011.732	12.11	38.42	50.53	74.00	-23.47	peak	150	126	
2	21011.732	1.83	38.42	40.25	54.00	-13.75	AVG	150	179	



ACCURATE TECHNOLOGY CO., LTD.

F1,Bldg,A,Changyuan New Material Port Keyuan Rd,
Science & Industry Park,Nanshan Shenzhen,P.R.China

Site: 2# Chamber
Tel:+86-0755-26503290
Fax:+86-0755-26503396

Job No.: LGW2018 #2468	Polarization: Vertical
Standard: FCC 15.247 3M Radiated	Power Source: AC 120V/60Hz
Test item: Radiation Test	Date: 2018/10/22
Temp.(C)/Hum.(%) 23 C / 48 %	Time: 16:43:28
EUT: DAC with headphone amplifier	Engineer Signature: WADE
Mode: TX 5762MHz	Distance: 3m
Model: CMA Twelve	
Manufacturer: Questyle Audio Technology Co.,Ltd	

Note: Report NO.:ATE20181770

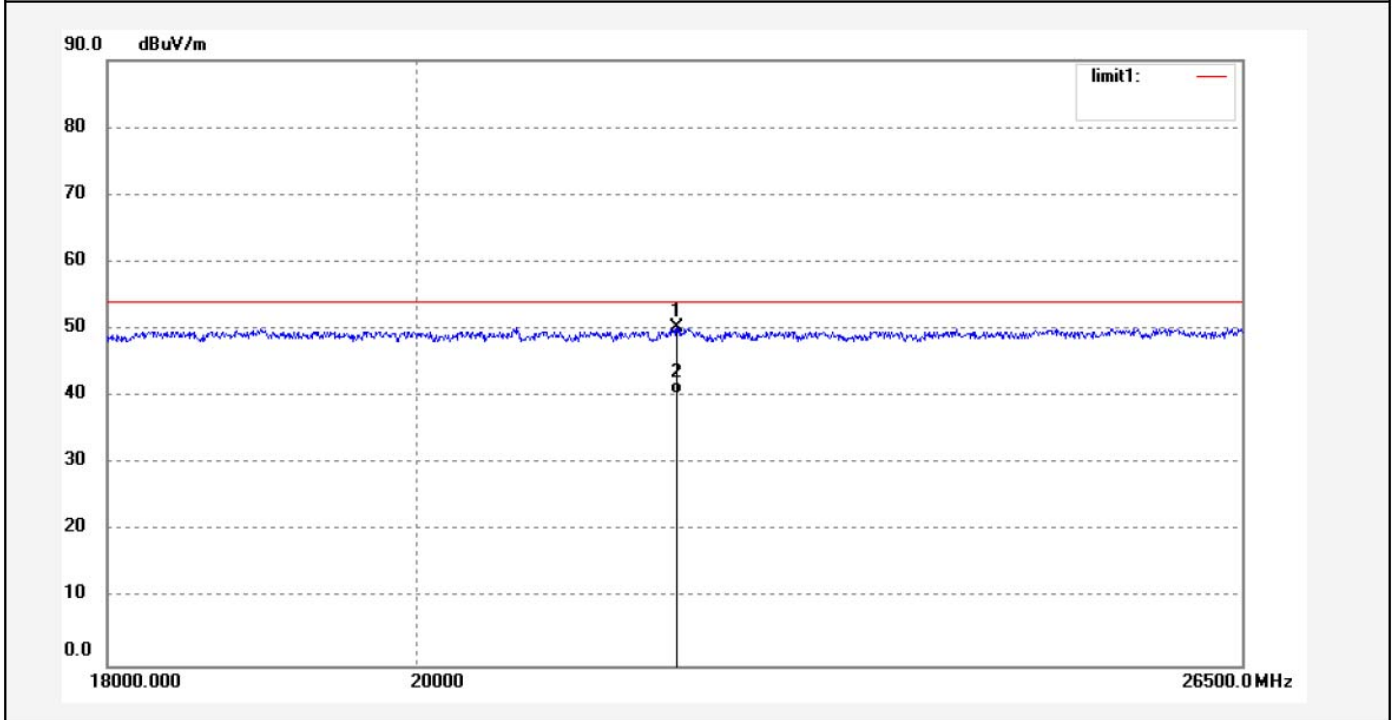

No.	Freq. (MHz)	Reading (dBuV/m)	Factor (dB)	Result (dBuV/m)	Limit (dBuV/m)	Margin (dB)	Detector	Height (cm)	Degree (deg.)	Remark
1	21857.231	10.96	39.24	50.20	74.00	-23.80	peak	200	215	
2	21857.231	1.11	39.24	40.35	54.00	-13.65	AVG	200	316	

Job No.: LGW2018 #2470	Polarization: Horizontal
Standard: FCC 15.247 3M Radiated	Power Source: AC 120V/60Hz
Test item: Radiation Test	Date: 2018/10/22
Temp.(C)/Hum.(%) 23 C / 48 %	Time: 16:50:17
EUT: DAC with headphone amplifier	Engineer Signature: WADE
Mode: TX 5814MHz	Distance: 3m
Model: CMA Twelve	
Manufacturer: Questyle Audio Technology Co.,Ltd	

Note: Report NO.:ATE20181770

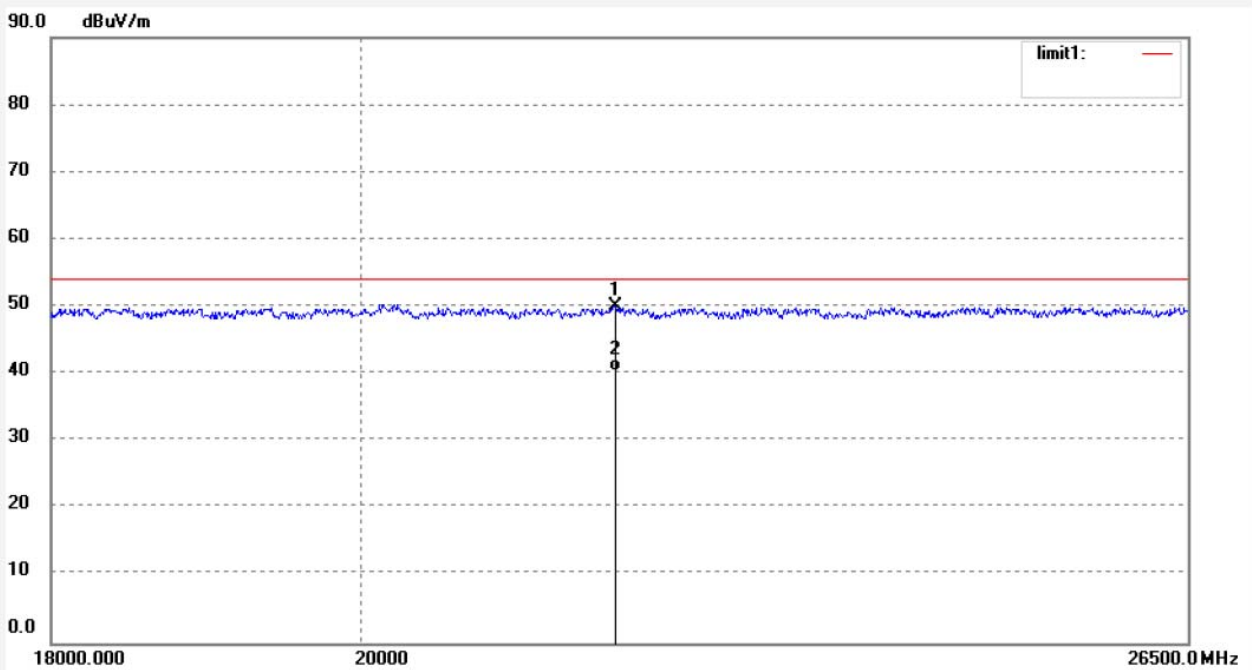

No.	Freq. (MHz)	Reading (dBuV/m)	Factor (dB)	Result (dBuV/m)	Limit (dBuV/m)	Margin (dB)	Detector	Height (cm)	Degree (deg.)	Remark
1	21815.002	11.09	39.08	50.17	74.00	-23.83	peak	150	323	
2	21815.002	1.28	39.08	40.36	54.00	-13.64	AVG	150	139	

Job No.: LGW2018 #2471	Polarization: Vertical
Standard: FCC 15.247 3M Radiated	Power Source: AC 120V/60Hz
Test item: Radiation Test	Date: 2018/10/22
Temp.(C)/Hum.(%) 23 C / 48 %	Time: 16:54:28
EUT: DAC with headphone amplifier	Engineer Signature: WADE
Mode: TX 5814MHz	Distance: 3m
Model: CMA Twelve	
Manufacturer: Questyle Audio Technology Co.,Ltd	

Note: Report NO.:ATE20181770

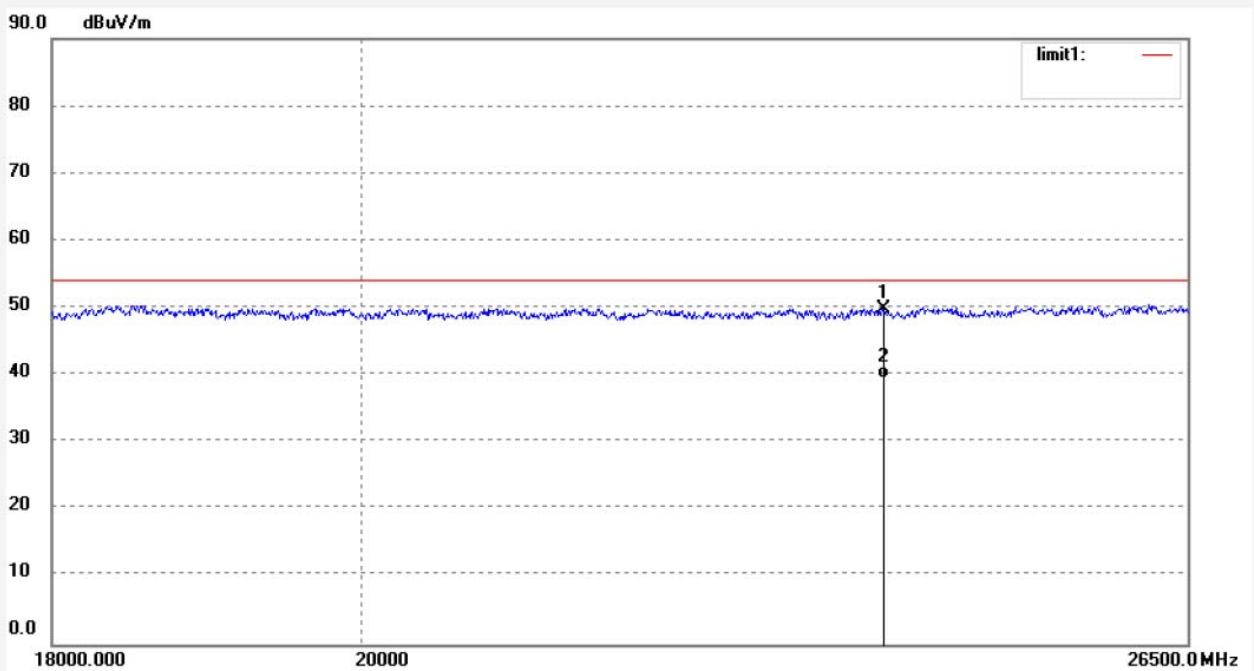

No.	Freq. (MHz)	Reading (dBuV/m)	Factor (dB)	Result (dBuV/m)	Limit (dBuV/m)	Margin (dB)	Detector	Height (cm)	Degree (deg.)	Remark
1	23890.708	10.10	39.72	49.82	74.00	-24.18	peak			
2	23890.708	-0.18	39.72	39.54	54.00	-14.46	AVG			

18GHz -26.5GHz test data

Test mode: 5736MHz TX

The EUT is tested radiation emission at each test mode in three axes. Besides, I tested the state of the two antennas being launched separately. The worst emissions are reflected in the following plots

Common Information

Test Site: SMQ EMC Lab.
Environment Conditions:
Antenna Polarization: Horizontal
Operator Name:
Comment:

Copy of FCC Electric Field Strength 26.5-40GHz

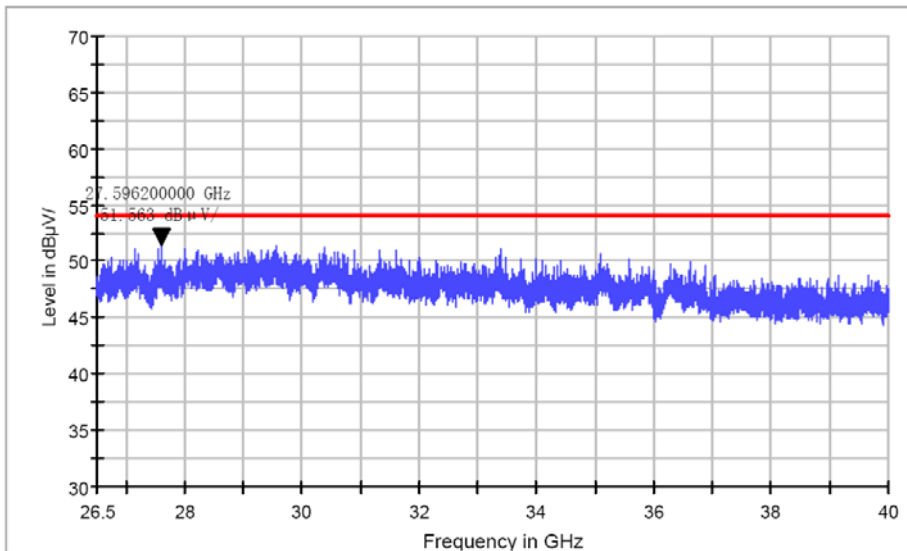

Common Information

Test Site: SMQ EMC Lab.
Environment Conditions:
Antenna Polarization: Vertical
Operator Name:
Comment:

Copy of FCC Electric Field Strength 26.5-40GHz

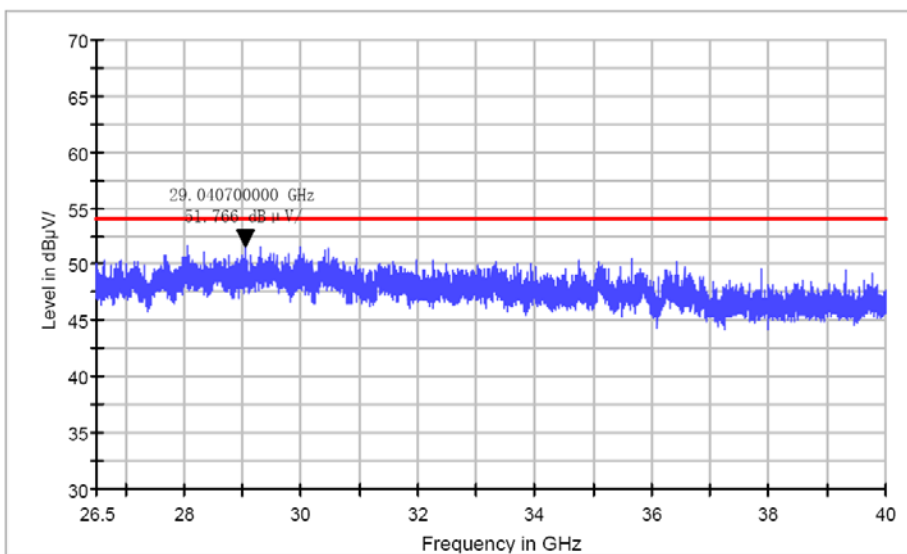

Test mode: 5762MHz TX

The EUT is tested radiation emission at each test mode in three axes. Besides, I tested the state of the two antennas being launched separately. The worst emissions are reflected in the following plots

Common Information

Test Site: SMQ EMC Lab.
Environment Conditions:
Antenna Polarization: Horizontal
Operator Name:
Comment:

Copy of FCC Electric Field Strength 26.5-40GHz

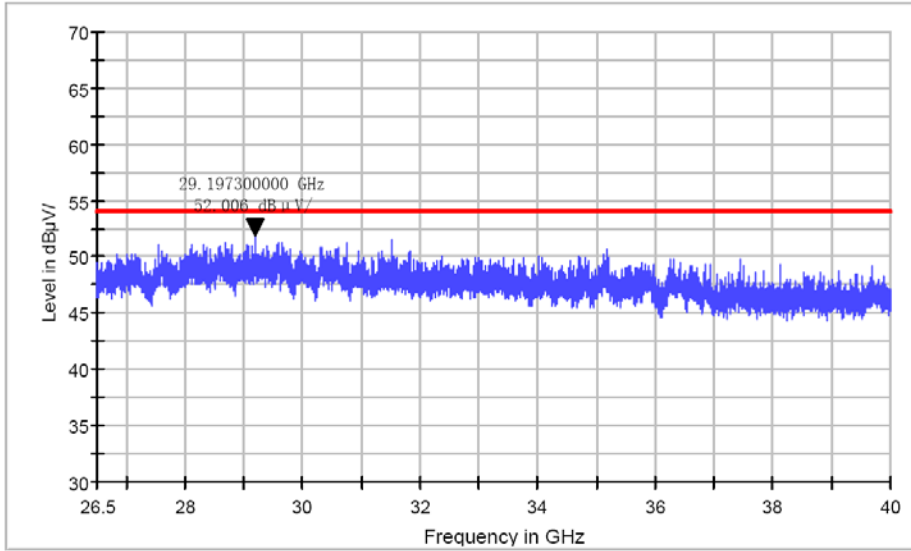

Common Information

Test Site: SMQ EMC Lab.
Environment Conditions:
Antenna Polarization: Vertical
Operator Name:
Comment:

Copy of FCC Electric Field Strength 26.5-40GHz

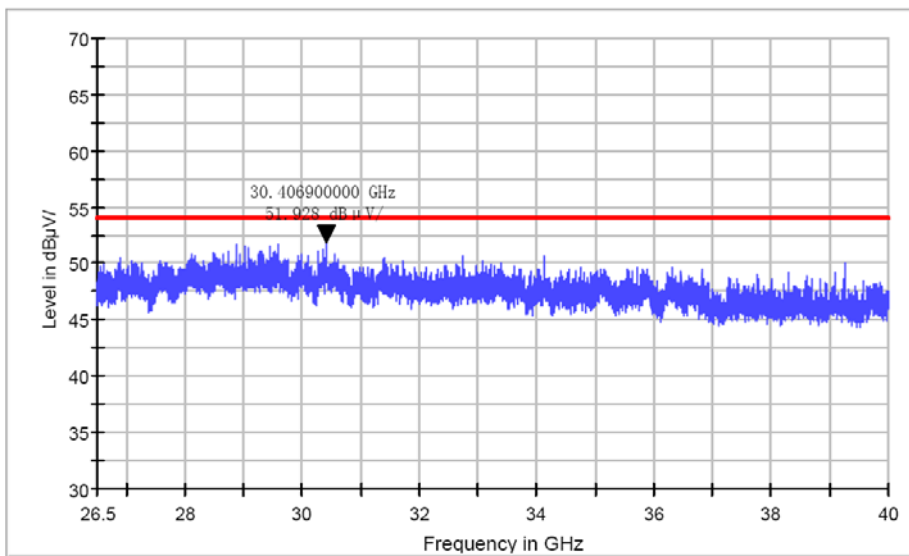

Test mode: 5814MHz TX

The EUT is tested radiation emission at each test mode in three axes. Besides, I tested the state of the two antennas being launched separately. The worst emissions are reflected in the following plots

Common Information

Test Site: SMQ EMC Lab.
Environment Conditions:
Antenna Polarization: Horizontal
Operator Name:
Comment:

Copy of FCC Electric Field Strength 26.5-40GHz

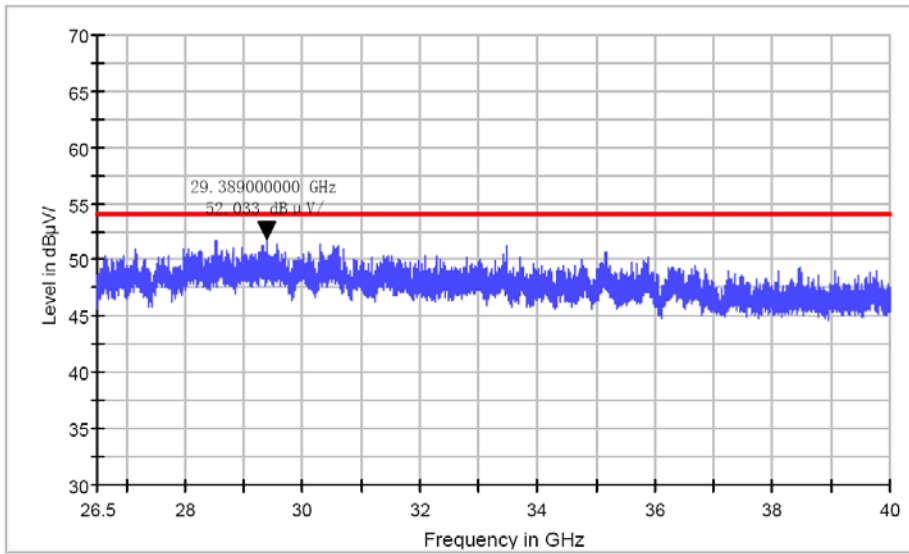

Common Information

Test Site: SMQ EMC Lab.
Environment Conditions:
Antenna Polarization: Vertical
Operator Name:
Comment:

Copy of FCC Electric Field Strength 26.5-40GHz

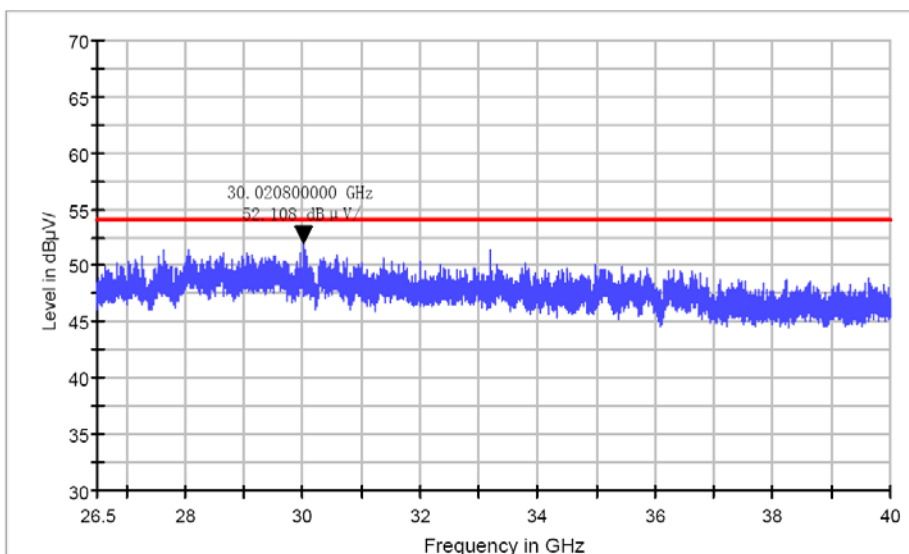

11. BAND EDGE COMPLIANCE TEST

11.1. Block Diagram of Test Setup

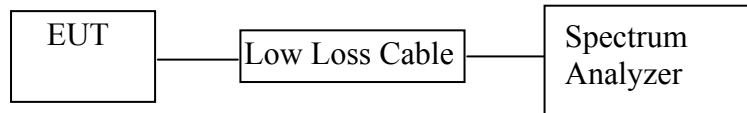

(EUT: DAC with headphone amplifier)

11.2. The Requirement For Section 15.247(d)

Section 15.247(d): In any 100 kHz bandwidth outside the frequency band in which the spread spectrum or digitally modulated intentional radiator is operating, the radio frequency power that is produced by the intentional radiator shall be at least 20 dB below that in the 100 kHz bandwidth within the band that contains the highest level of the desired power, based on either an RF conducted or a radiated measurement, provided the transmitter demonstrates compliance with the peak conducted power limits. If the transmitter complies with the conducted power limits based on the use of RMS averaging over a time interval, as permitted under paragraph (b)(3) of this section, the attenuation required under this paragraph shall be 30 dB instead of 20 dB. Attenuation below the general limits specified in Section 15.209(a) is not required. In addition, radiated emissions which fall in the restricted bands, as defined in Section 15.205(a), must also comply with the radiated emission limits specified in Section 15.209(a).

11.3. EUT Configuration on Measurement

The equipment are installed on the emission Measurement to meet the commission requirements and operating regulations in a manner which tends to maximize its emission characteristics in normal application.

11.4. Operating Condition of EUT

11.4.1. Setup the EUT and simulator as shown as Section 11.1.

11.4.2. Turn on the power of all equipment.

11.4.3. Let the EUT work in TX modes measure it. The transmit frequency are 5736-5814MHz. We select 5736MHz, 5814MHz TX frequency to transmit.

11.5. Test Procedure

Conducted Band Edge:

11.5.1. The transmitter output was connected to the spectrum analyzer via a low loss cable.

11.5.2. Set RBW of spectrum analyzer to 1000kHz and VBW to 3000kHz.

Radiate Band Edge:

11.5.3. The EUT is placed on a turntable, which is 0.8m above the ground plane and worked at highest radiated power.

11.5.4. The turntable was rotated for 360 degrees to determine the position of maximum emission level.

11.5.5. EUT is set 3m away from the receiving antenna, which is varied from 1m to 4m to find out the highest emission.

11.5.6. Set the spectrum analyzer in the following setting in order to capture the lower and upper band-edges of the emission:

11.5.7. RBW=1MHz, VBW=3MHz

11.5.8. The band edges was measured and recorded.

11.6. Test Result

PASS

Antenna A test plot

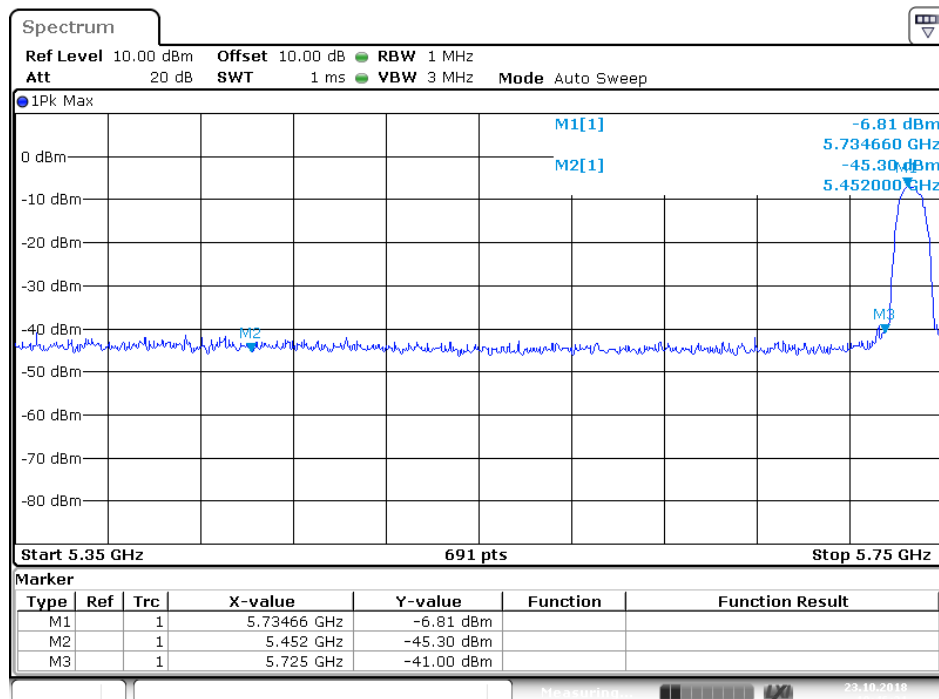
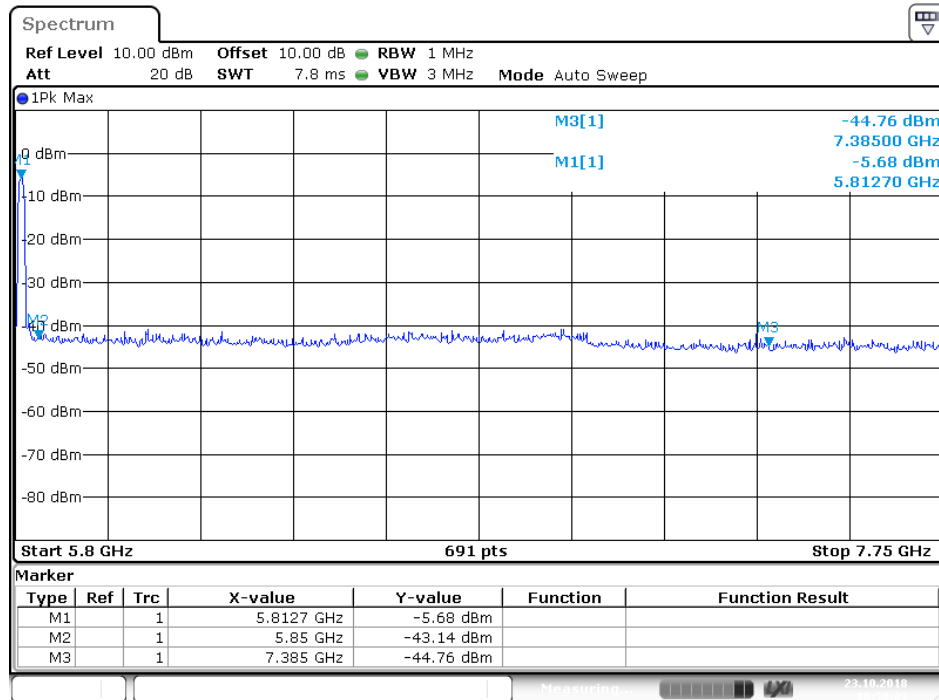

Antenna B test plot

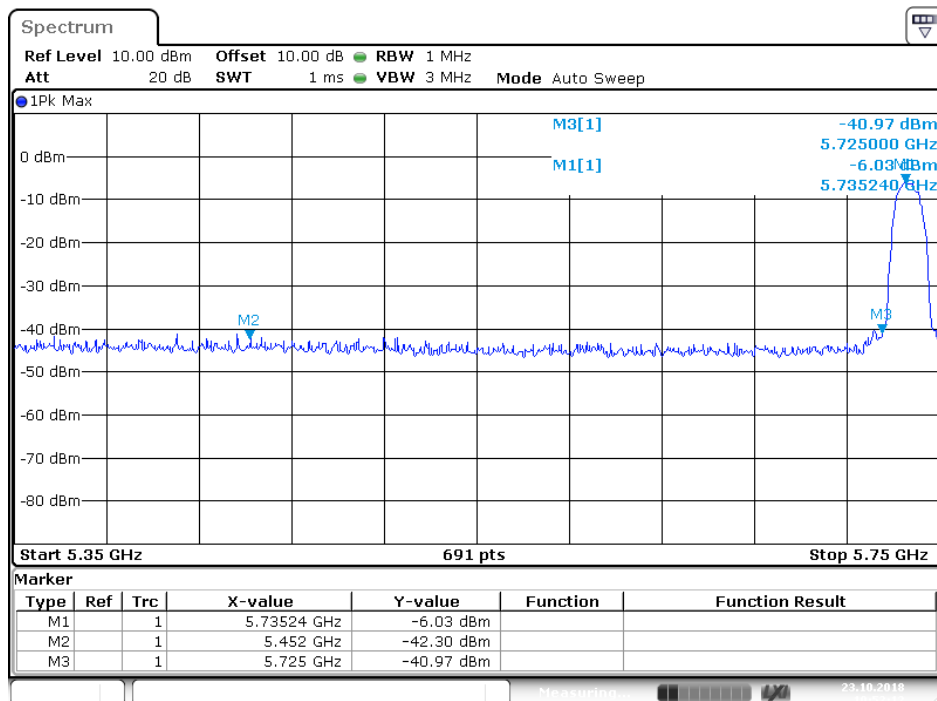
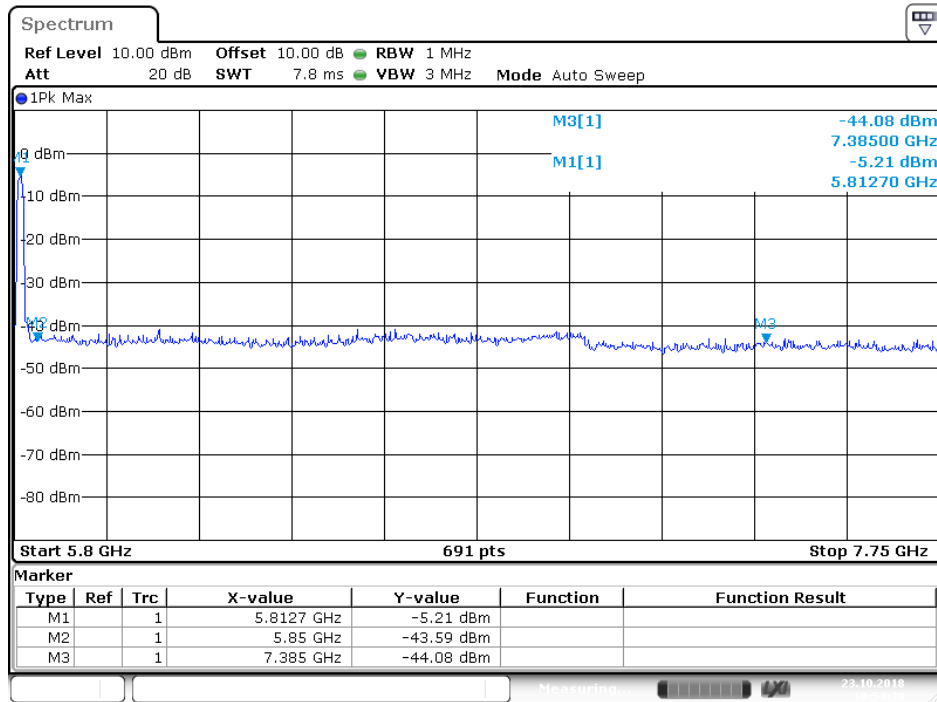

Radiated Band Edge Result

Note:

1. Emissions attenuated more than 20 dB below the permissible value are not reported.
2. we tested radiated band edge of Antenna A and Antenna B, The following test data is the worst case(Antenna B) data which I have recorded
2. The field strength is calculated by adding the antenna factor, high pass filter loss(if used) and cable loss, and subtracting the amplifier gain(if any)from the measured reading. The basic equation calculation is as follows:

Result = Reading + Corrected Factor

Job No.: frank2018 #1930	Polarization: Horizontal
Standard: FCC PK	Power Source: AC 120V/60Hz
Test item: Radiation Test	Date: 2018/10/22
Temp.(C)/Hum.(%) 25 C / 55 %	Time: 16:21:54
EUT: DAC with headphone amplifier	Engineer Signature:
Mode: TX 5736MHz	Distance: 3m
Model: CMA Twelve	
Manufacturer: Questyle Audio Technology Co.,Ltd	

Note: Report NO.:ATE20181770

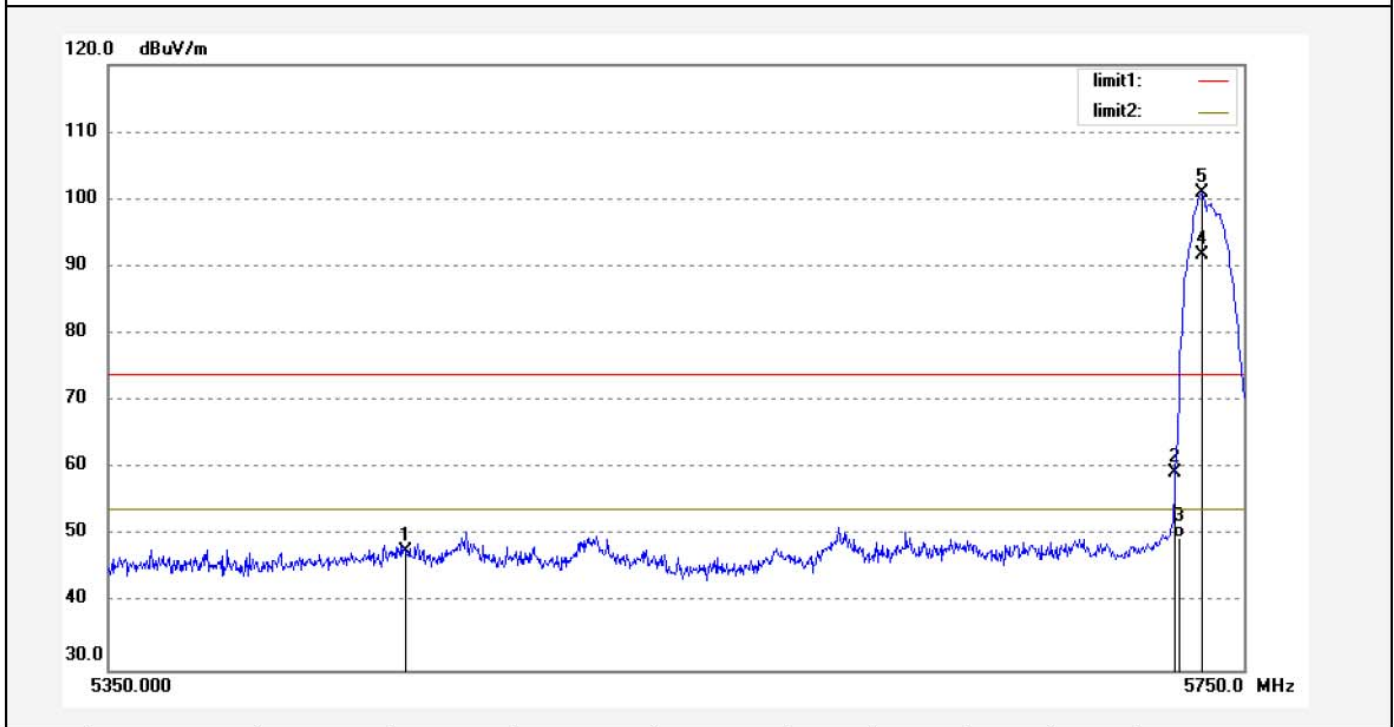

No.	Freq. (MHz)	Reading (dBuV/m)	Factor (dB)	Result (dBuV/m)	Limit (dBuV/m)	Margin (dB)	Detector	Height (cm)	Degree (deg.)	Remark
1	5452.000	48.64	-0.88	47.76	74.00	-26.24	peak	250	302	
2	5725.000	59.82	-0.38	59.44	74.00	-14.56	peak	250	141	
3	5725.000	50.15	-0.38	49.77	54.00	-4.23	AVG	250	68	
4	5736.000	101.32	-0.36	100.96			peak	250	145	
5	5736.000	92.15	-0.36	91.79			AVG	250	302	

Note: Average measurement with peak detection at No.3,5

Job No.: frank2018 #1929	Polarization: Vertical
Standard: FCC PK	Power Source: AC 120V/60Hz
Test item: Radiation Test	Date: 2018/10/22
Temp.(C)/Hum.(%) 25 C / 55 %	Time: 16:19:54
EUT: DAC with headphone amplifier	Engineer Signature:
Mode: TX 5736MHz	Distance: 3m
Model: CMA Twelve	
Manufacturer: Questyle Audio Technology Co.,Ltd	

Note: Report NO.:ATE20181770

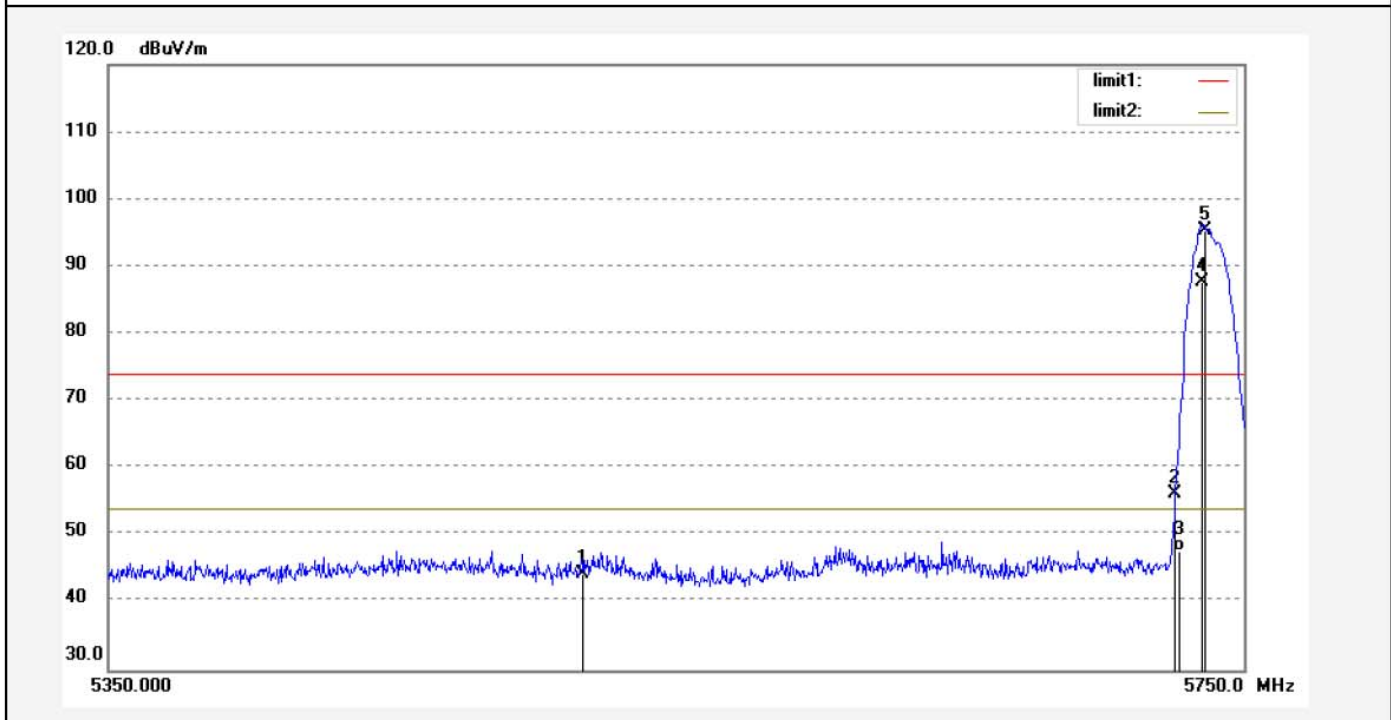

No.	Freq. (MHz)	Reading (dBuV/m)	Factor (dB)	Result (dBuV/m)	Limit (dBuV/m)	Margin (dB)	Detector	Height (cm)	Degree (deg.)	Remark
1	5514.000	45.18	-0.78	44.40	74.00	-29.60	peak	150	103	
2	5725.000	56.70	-0.38	56.32	74.00	-17.68	peak	150	124	
3	5725.000	48.15	-0.38	47.77	54.00	-6.23	AVG	150	69	
4	5736.000	95.69	-0.36	95.33			peak	150	211	
5	5736.000	88.16	-0.36	87.80			AVG	150	133	

Note: Average measurement with peak detection at No.3,5

Job No.: frank2018 #1931
 Standard: FCC PK
 Test item: Radiation Test
 Temp.(C)/Hum.(%) 25 C / 55 %
 EUT: DAC with headphone amplifier
 Mode: TX 5814MHz
 Model: CMA Twelve
 Manufacturer: Questyle Audio Technology Co.,Ltd

Polarization: Horizontal
 Power Source: AC 120V/60Hz
 Date: 2018/10/22
 Time: 16:24:42
 Engineer Signature:
 Distance: 3m

Note: Report NO.:ATE20181770

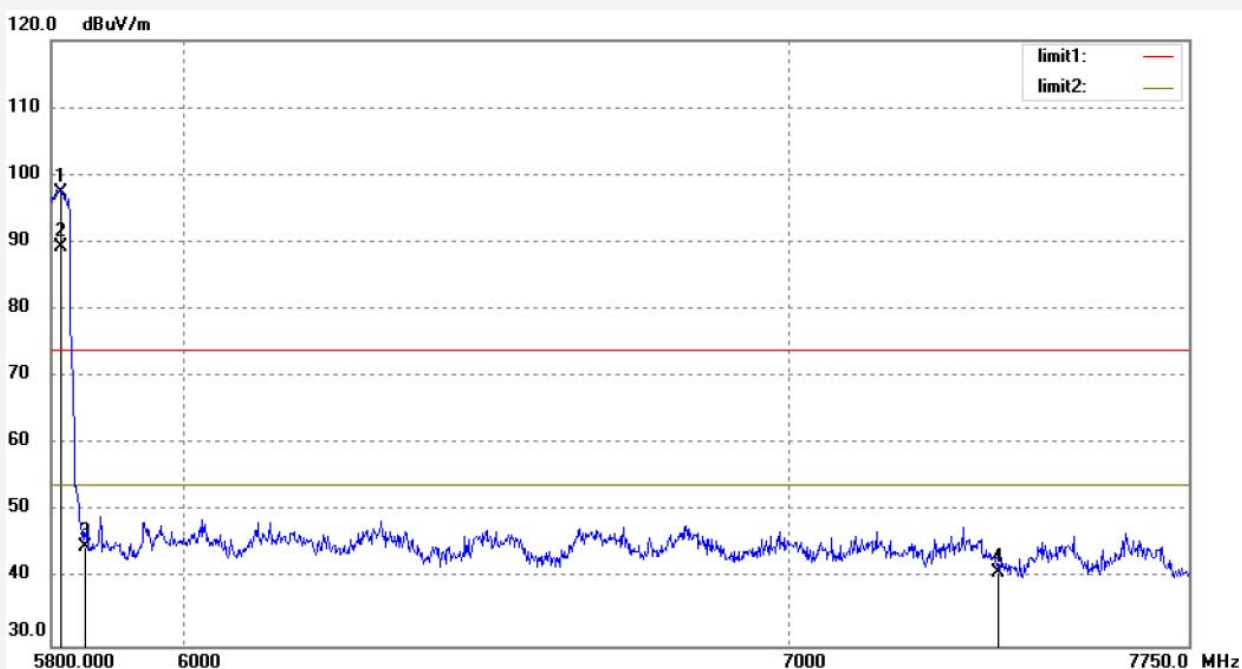

No.	Freq. (MHz)	Reading (dBuV/m)	Factor (dB)	Result (dBuV/m)	Limit (dBuV/m)	Margin (dB)	Detector	Height (cm)	Degree (deg.)	Remark
1	5814.000	97.51	-0.22	97.29			peak	250	103	
2	5814.000	89.45	-0.22	89.23			AVG	250	269	
3	5850.000	44.86	-0.15	44.71	74.00	-29.29	peak	250	321	
4	7385.000	38.53	2.35	40.88	74.00	-33.12	AVG	250	201	

Note: Average measurement with peak detection at No.2,4

Job No.: frank2018 #1932
 Standard: FCC PK
 Test item: Radiation Test
 Temp.(C)/Hum.(%) 25 C / 55 %
 EUT: DAC with headphone amplifier
 Mode: TX 5814MHz
 Model: CMA Twelve
 Manufacturer: Questyle Audio Technology Co.,Ltd

Polarization: Vertical
 Power Source: AC 120V/60Hz
 Date: 2018/10/22
 Time: 16:26:04
 Engineer Signature:
 Distance: 3m

Note: Report NO.:ATE20181770

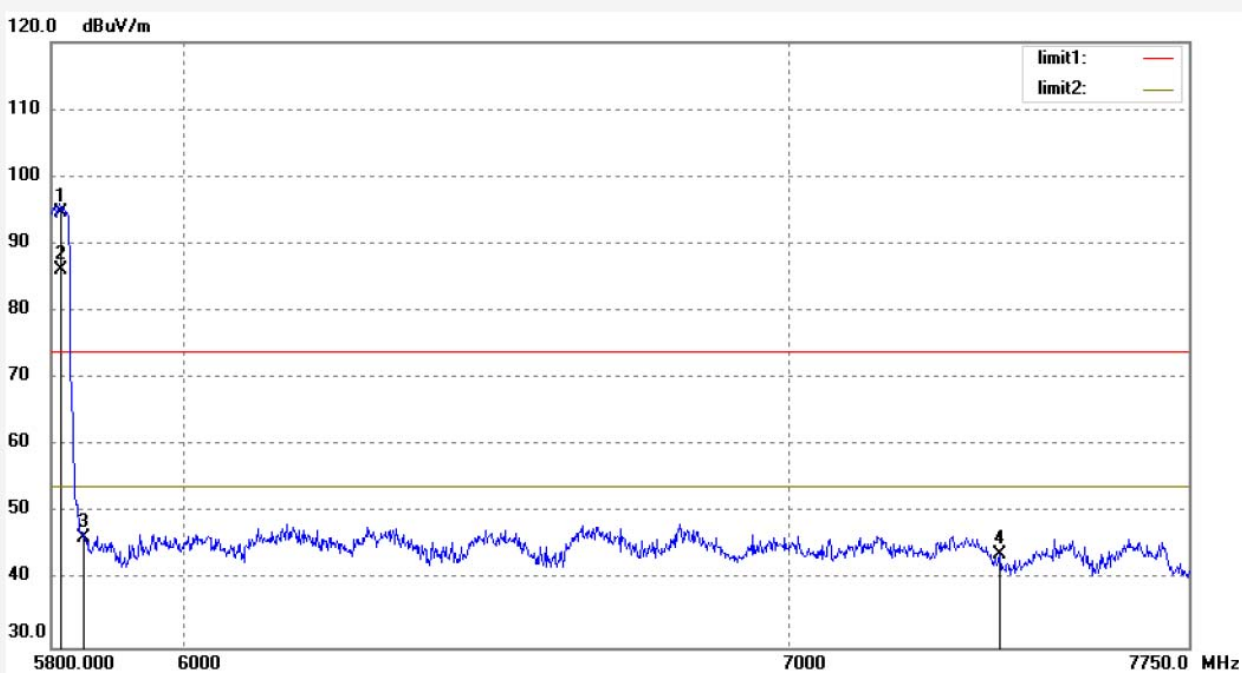

No.	Freq. (MHz)	Reading (dBuV/m)	Factor (dB)	Result (dBuV/m)	Limit (dBuV/m)	Margin (dB)	Detector	Height (cm)	Degree (deg.)	Remark
1	5814.000	94.87	-0.22	94.65	74.00	20.65	peak	250	56	
2	5814.000	86.45	-0.22	86.23	74.00	12.23	AVG	250	103	
3	5850.000	46.44	-0.15	46.29	74.00	-27.71	peak	250	62	
4	7385.000	41.47	2.35	43.82	74.00	-30.18	AVG	250	304	

Note: Average measurement with peak detection at No.2,4

12.AC POWER LINE CONDUCTED EMISSION FOR FCC PART

15 SECTION 15.207(A)

12.1.Block Diagram of Test Setup

12.1.1.Shielding Room Test Setup Diagram

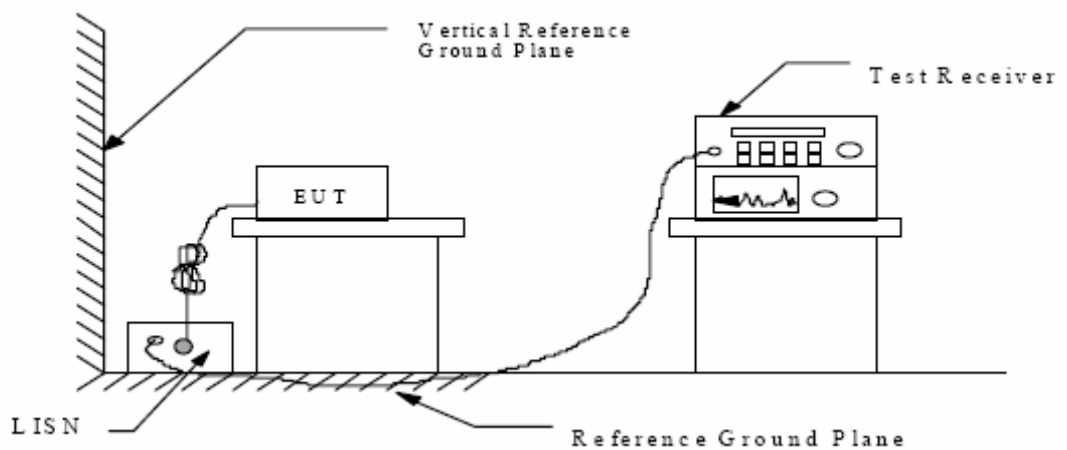

12.2.The Emission Limit

12.2.1.Conducted Emission Measurement Limits According to Section 15.207(a)

Frequency (MHz)	Limit dB(μ V)	
	Quasi-peak Level	Average Level
0.15 - 0.50	66.0 – 56.0 *	56.0 – 46.0 *
0.50 - 5.00	56.0	46.0
5.00 - 30.00	60.0	50.0

* Decreases with the logarithm of the frequency.

12.3.Configuration of EUT on Measurement

The equipment is installed on the Conducted Emission Measurement to meet the commission requirements and operating regulations in a manner which tends to maximize its emission characteristics in normal application.

12.4. Operating Condition of EUT

12.4.1. Setup the EUT and simulator as shown as Section 12.1.

12.4.2. Turn on the power of all equipment.

12.4.3. Let the EUT work in Test mode measure it.

12.5. Test Procedure

The EUT is put on the plane 0.8m high above the ground by insulating support and is connected to the power mains through a line impedance stabilization network (L.I.S.N.). This provides a 50ohm coupling impedance for the EUT system. Please refer the block diagram of the test setup and photographs. Both sides of AC lines are checked to find out the maximum conducted emission. In order to find the maximum emission levels, the relative positions of equipment and all of the interface cables shall be changed according to ANSI C63.4- 2013 on Conducted Emission Measurement.

The bandwidth of test receiver (R & S ESCS30) is set at 9 kHz.

The frequency range from 150 kHz to 30MHz is checked.

12.6. DATA SAMPLE

Frequency (MHz)	Quasi Peak Level (dB μ v)	Average Level (dB μ v)	Transducer value (dB)	QuasiPeak Result (dB μ v)	Average Result (dB μ v)	Quasi Peak Limit (dB μ v)	Average Limit (dB μ v)	QuasiPeak Margin (dB)	Average Margin (dB)	Remark (Pass/Fail)
X.XX	29.4	18.3	11.1	40.5	29.4	56.0	56.0	15.5	16.6	Pass

Transducer value = Insertion loss of LISN + Cable Loss

Result = Quasi-peak Level/Average Level + Transducer value

Limit = Limit stated in standard

Calculation Formula:

Margin = Limit – Reading level value – Transducer value

12.7. Power Line Conducted Emission Measurement Results

PASS.

The frequency range from 150kHz to 30MHz is checked.

Test mode : 5.8G Operation Test voltage: 120V /60Hz								
MEASUREMENT RESULT: "F-1770-07_fin"								
2018-10-16 15:28								
Frequency	Level	Transd	Limit	Margin	Detector	Line	PE	
MHz	dBuV	dB	dBuV	dB				
0.294000	28.90	10.9	60	31.5	QP	L1	GND	
0.460500	33.60	11.0	57	23.1	QP	L1	GND	
0.883500	25.80	11.1	56	30.2	QP	L1	GND	
4.933500	32.80	11.4	56	23.2	QP	L1	GND	
5.199000	33.50	11.4	60	26.5	QP	L1	GND	
17.443500	33.70	11.7	60	26.3	QP	L1	GND	
MEASUREMENT RESULT: "F-1770-07_fin2"								
2018-10-16 15:28								
Frequency	Level	Transd	Limit	Margin	Detector	Line	PE	
MHz	dBuV	dB	dBuV	dB				
0.150000	36.10	10.8	56	19.9	AV	L1	GND	
0.456000	26.40	11.0	47	20.4	AV	L1	GND	
1.068000	20.30	11.1	46	25.7	AV	L1	GND	
4.924500	21.90	11.4	46	24.1	AV	L1	GND	
5.226000	22.50	11.4	50	27.5	AV	L1	GND	
16.588500	21.90	11.7	50	28.1	AV	L1	GND	
MEASUREMENT RESULT: "F-1770-08_fin"								
2018-10-16 15:30								
Frequency	Level	Transd	Limit	Margin	Detector	Line	PE	
MHz	dBuV	dB	dBuV	dB				
0.262500	28.90	10.9	61	32.5	QP	N	GND	
0.451500	33.20	11.0	57	23.6	QP	N	GND	
0.942000	25.10	11.1	56	30.9	QP	N	GND	
4.852500	32.00	11.4	56	24.0	QP	N	GND	
5.397000	32.80	11.5	60	27.2	QP	N	GND	
17.160000	33.80	11.7	60	26.2	QP	N	GND	
MEASUREMENT RESULT: "F-1770-08_fin2"								
2018-10-16 15:30								
Frequency	Level	Transd	Limit	Margin	Detector	Line	PE	
MHz	dBuV	dB	dBuV	dB				
0.150000	36.00	10.8	56	20.0	AV	N	GND	
0.456000	26.30	11.0	47	20.5	AV	N	GND	
1.072500	20.20	11.1	46	25.8	AV	N	GND	
4.992000	21.90	11.4	46	24.1	AV	N	GND	
5.550000	22.40	11.5	50	27.6	AV	N	GND	
17.322000	21.80	11.7	50	28.2	AV	N	GND	

Emissions attenuated more than 20 dB below the permissible value are not reported.

The spectral diagrams are attached as below.

ACCURATE TECHNOLOGY CO.,LTD

CONDUCTED EMISSION STANDARD FCC PART 15B

EUT: DAC with headphone amplifier M/N:CMA Twelve
 Manufacturer: Questyle Audio Technology Co.,Ltd
 Operating Condition: 5.8G OPERATION
 Test Site: 2#Shielding Room
 Operator: Frank
 Test Specification: L 120V /60Hz
 Comment: Report NO.:ATE20181770
 Start of Test: 2018-10-16 / 15:25:53

SCAN TABLE: "V 150K-30MHz fin"

Start Frequency	Stop Frequency	Step Width	Detector	Meas. Time	IF Bandw.	Transducer
150.0 kHz	30.0 MHz	4.5 kHz	QuasiPeak	1.0 s	9 kHz	NSLK8126 2008
Average						

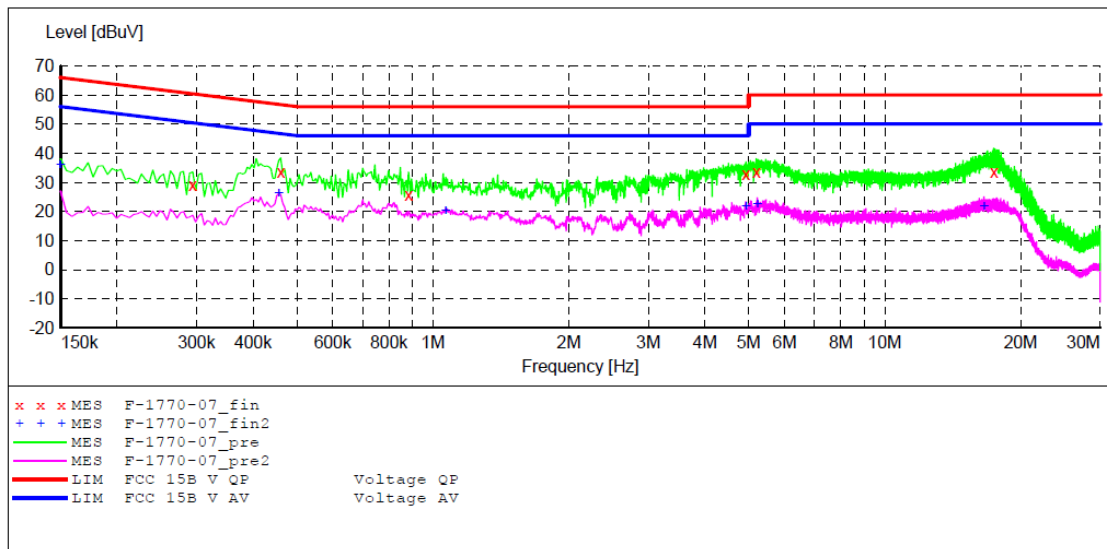

MEASUREMENT RESULT: "F-1770-07_fin"

2018-10-16 15:28

Frequency MHz	Level dBuV	Transd dB	Limit dBuV	Margin dB	Detector	Line	PE
0.294000	28.90	10.9	60	31.5	QP	L1	GND
0.460500	33.60	11.0	57	23.1	QP	L1	GND
0.883500	25.80	11.1	56	30.2	QP	L1	GND
4.933500	32.80	11.4	56	23.2	QP	L1	GND
5.199000	33.50	11.4	60	26.5	QP	L1	GND
17.443500	33.70	11.7	60	26.3	QP	L1	GND

MEASUREMENT RESULT: "F-1770-07_fin2"

2018-10-16 15:28

Frequency MHz	Level dBuV	Transd dB	Limit dBuV	Margin dB	Detector	Line	PE
0.150000	36.10	10.8	56	19.9	AV	L1	GND
0.456000	26.40	11.0	47	20.4	AV	L1	GND
1.068000	20.30	11.1	46	25.7	AV	L1	GND
4.924500	21.90	11.4	46	24.1	AV	L1	GND
5.226000	22.50	11.4	50	27.5	AV	L1	GND
16.588500	21.90	11.7	50	28.1	AV	L1	GND

ACCURATE TECHNOLOGY CO.,LTD

CONDUCTED EMISSION STANDARD FCC PART 15B

EUT: DAC with headphone amplifier M/N:CMA Twelve
 Manufacturer: Questyle Audio Technology Co.,Ltd
 Operating Condition: 5.8G OPERATION
 Test Site: 2#Shielding Room
 Operator: Frank
 Test Specification: N 120V /60Hz
 Comment: Report NO.:ATE20181770
 Start of Test: 2018-10-16 / 15:28:32

SCAN TABLE: "V 150K-30MHz fin"

Short Description: SUB STD VTERM2 1.70
 Start Stop Step Detector Meas. IF Transducer
 Frequency Frequency Width Time Bandw.
 150.0 kHz 30.0 MHz 4.5 kHz QuasiPeak 1.0 s 9 kHz NSLK8126 2008
 Average

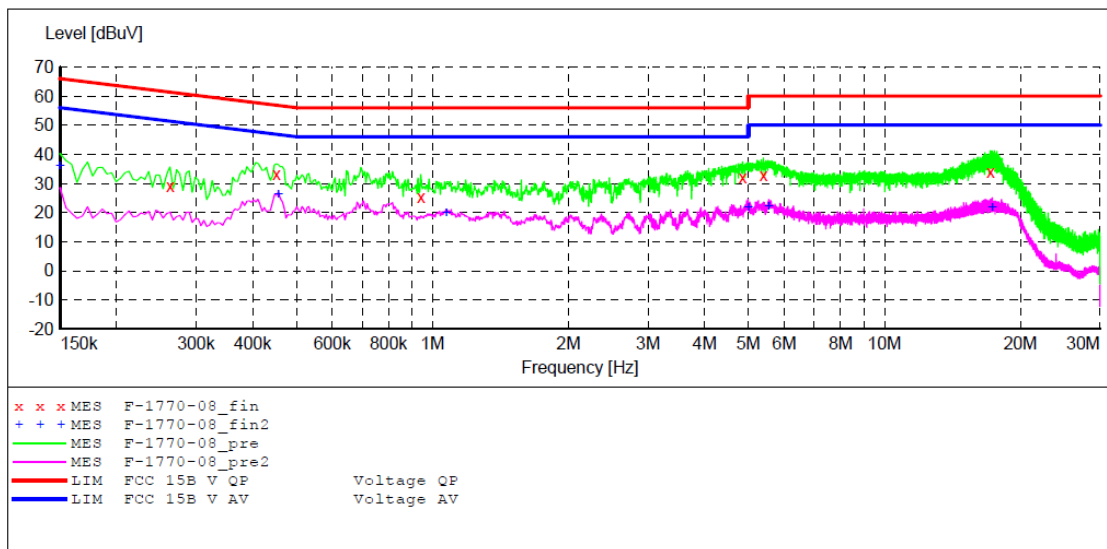

MEASUREMENT RESULT: "F-1770-08_fin"

2018-10-16 15:30

Frequency MHz	Level dBuV	Transd dB	Limit dBuV	Margin dB	Detector	Line	PE
0.262500	28.90	10.9	61	32.5	QP	N	GND
0.451500	33.20	11.0	57	23.6	QP	N	GND
0.942000	25.10	11.1	56	30.9	QP	N	GND
4.852500	32.00	11.4	56	24.0	QP	N	GND
5.397000	32.80	11.5	60	27.2	QP	N	GND
17.160000	33.80	11.7	60	26.2	QP	N	GND

MEASUREMENT RESULT: "F-1770-08_fin2"

2018-10-16 15:30

Frequency MHz	Level dBuV	Transd dB	Limit dBuV	Margin dB	Detector	Line	PE
0.150000	36.00	10.8	56	20.0	AV	N	GND
0.456000	26.30	11.0	47	20.5	AV	N	GND
1.072500	20.20	11.1	46	25.8	AV	N	GND
4.992000	21.90	11.4	46	24.1	AV	N	GND
5.550000	22.40	11.5	50	27.6	AV	N	GND
17.322000	21.80	11.7	50	28.2	AV	N	GND

13.ANTENNA REQUIREMENT

13.1.The Requirement

According to Section 15.203, an intentional radiator shall be designed to ensure that no antenna other than that furnished by the responsible party shall be used with the device.

13.2.Antenna Construction

Device is equipped with permanent attached antenna, which isn't displaced by other antenna. The Antenna gain of EUT is 3dBi. Therefore, the equipment complies with the antenna requirement of Section 15.203.

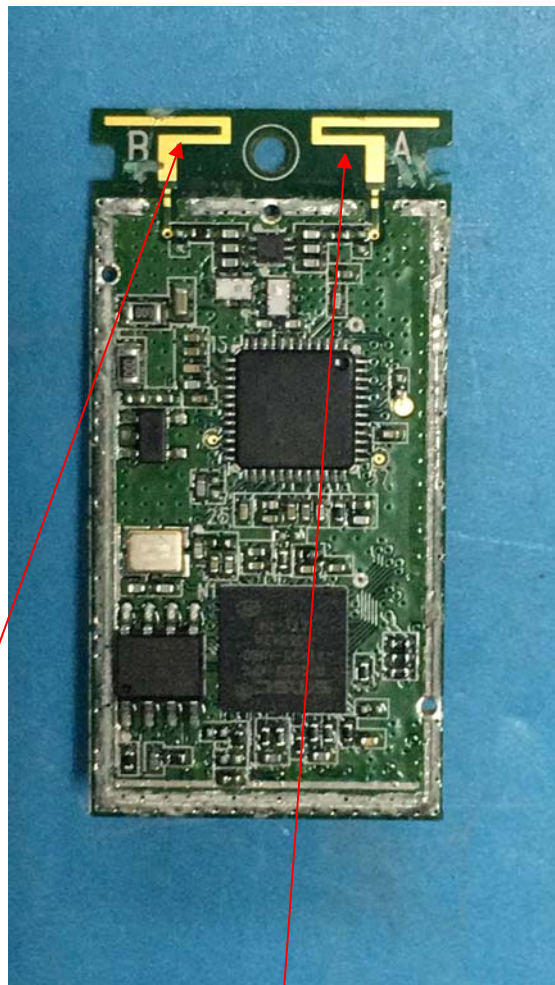

Antenna B

Antenna A