

**LIVALL**<sup>®</sup>  
Redefine Your Safety

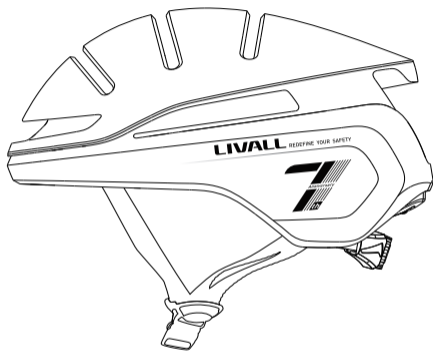

## Smart Helmet EVO21

Quick Start Guide  
& Warranty Information

EN

中

[www.livall.com](http://www.livall.com)

## I. Introduction

Welcome to the User Guide for LIVALL smart helmets. This Guide will help you better use this product. With continuous improvements of our products, this Guide will be updated from time to time. You can access the latest version and learn more about the helmet on [www.livall.com](http://www.livall.com).

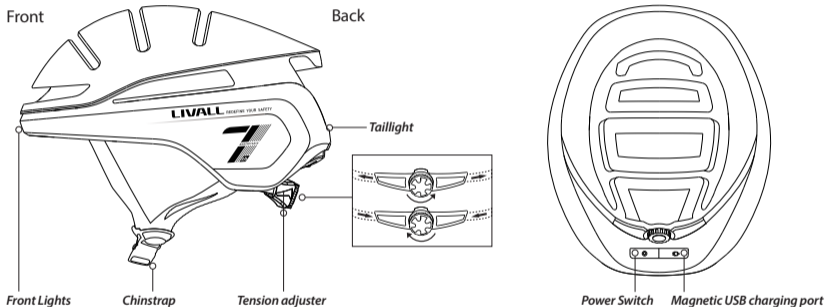

*Note: The picture is for reference only. If the actual product appears different from the picture, the real product shall prevail.*

## II. Packing List

Smart Helmet x 1

Quick Start Guide & Warranty Information x 1

Bling Remote Controller BR80 x 1

Magnetic USB charging cable x 1

### III. Wearing Instructions



*Incorrect*



*Incorrect*



*Correct*



*Adjust the length of the chinstrap*



*Leave a gap as thick as one finger*



*Correctly position the helmet*



*Check whether the buckle is properly fastened*

## IV. Operation Instructions

### Turn On Your Helmet

For the first time to use, press the power on button located at the back of the helmet, once the tail lights illuminate the smart helmet is on.

*Note: If it cannot be activated successfully, please charge it and try again.*

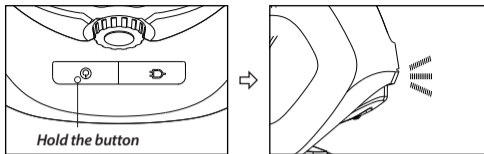

### Battery Status

Remaining battery level is shown by the number of light beads in the middle of the tail, that is displayed when a helmet is initially turned on. Full battery is indicated when all of the light beads are on.

### Connect the Remote Control BR80 (Control the Turning Signals)

#### 1) First connection

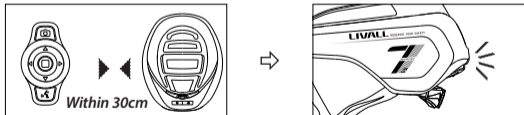

Turn on the BR80. Within the distance of 30cm between the BR80 and the helmet

It will automatically connect to the helmet.

## 2) Replacing device (When the original BR80 lost or damaged)

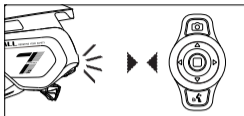

Put the power-on BR80 close to the main control of the helmet, and the warning light flashes three times per second, indicating that there is a BR80 that needs to be connected to the helmet.

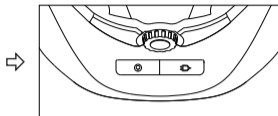

Press the power button of the helmet within 10s to confirm the connection of the BR80.



Then the tail light of the helmet will continue to flash in the light mode before connection. After connected successfully, the left turn signal or right turn signal can be realized by the BR80.

### Note:

- A. The left and right turn signal of the helmet can be controlled by the BR80's left (L) and right (R) buttons;
- B. Except for the left (L) and right (R) buttons of BR80 and the red confirmation button in the middle of BR80, other keys are not needed for the time being.

## Automatic Standby

After the helmet powers on and stays stationary for a while, it will automatically begin saving power by going into sleep mode. When the tail light is off, without user interaction, the helmet is in sleep mode.

## Automatic Wake Up

To wake up the helmet, shake it several times until the tail lights illuminate.

*Note: If the helmet does not wake up, make sure the battery levels are adequate.*

## Adaptive lighting(The feature is enabled by default and can be closed by the app.)

When the helmet is powered on during the day or in a bright environment, only the central LED light will keep flashing, other LED lights will turn off automatically. During the night, or in a dark environment, the whole taillight will keep flashing.

## Lighting Mode

After the helmet is turned on, press the power button for a second to switch between the three lighting modes.

## Brake warning light

When the helmet detects a smooth deceleration, the whole taillight will light up for several seconds to warn the vehicles behind.

*Note: When the helmet shakes too heavy, the built-in sensor detects obvious deceleration to trigger the warning light always on, which is normal.*

## Connect With Your Phone



1) Download the LIVALL Riding App on your smartphone app store;



2) Turn on the Bluetooth on your phone and turn on the helmet;

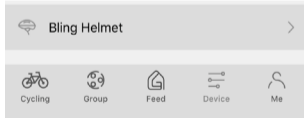

3) Click "Device" in the LIVALL Riding app, then pair the helmet with your phone through the app by clicking "Helmet." After a successful connection, "Helmet" will display "EVO21".

*Tips: In order to ensure a stable Bluetooth connection whilst riding, use a smartphone holder and place the phone on your handlebars.*

## SOS Alert(need to be connected to LIVALL Riding APP)

The helmet has a fall detection sensor which sends a signal to the LIVALL Riding APP via Bluetooth technology when a fall is detected. Then the APP will send an SOS message to a pre-arranged emergency contact.

## Power off

Hold the power  button at the back of the helmet for several seconds until all the LED taillight turns off.

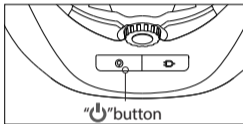

## Charge

When the soft rubber lid with "" image is opened, the Magnetic charging port will be seen. Insert a USB cable into the USB Charging cable interface of the helmet. Charging starts when the middle area LEDs light up. During charging, when the middle area LEDs stop blinking and turns off, charging is completed.

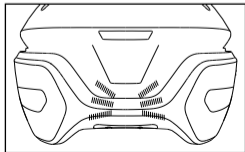
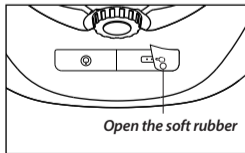

## EVO21 Product Feature List

NO	Function	NO	Function
1	Automatic Standby	6	Lighting Mode
2	Automatic Wake Up	7	Turn light
3	Battery Status	8	Brake warning light
4	Adaptive Lighting	9	SOS Alert
5	Front light		

*Kind Reminder: Please refer to the Quick Start Guide for more details about the functions.*

## V.Considerations

1. The helmet contains electronic parts inside. Please do not take a long ride in the rain although the helmet can prevent the rain from splashing.
2. After the helmet gets wet in the rain, the water droplets might occur in the chimney of tail LED lights. The water droplets will disappear when you put the helmet under the ventilation environment for 1-2 days.
3. The helmet contains the battery .The battery capacity varies with temperature change. The battery life can decay when the helmet is used at low temperatures or below Zero degrees Celsius.
4. If the electronic functions do not work, please charge the helmet for 3 hours and then check if it works normally.
5. ★The helmet contains impact detection devices. Only if you connect your helmet with LIVALL Riding App and start ride mode on the App, when your helmet suffers from the heavy impact, SOS alert feature can be triggered. Your emergency contacts set on LIVALL Riding App can accordingly receive your SOS messages.



6. Trying to clean the golden colour contacts of the charging plug sheet with metal or hard tools such as blades or tweezers is strictly forbidden. Please use cotton swabs with clean water or alcohol in case of cleaning. Please make sure the charging plug is clean and try while charging the helmet.
7. The built-in battery is forbidden to be disassembled, squeezed, heated or burned. It is also forbidden to use screwdrivers and other sharp devices breaking down or prying apart the battery. The above operations may make the battery caught fire.
8. Please do not place the helmet with sharp objects, avoiding to damage the helmet.

**Note:** 1. Problems such as network anomalies, may result in the failure to successfully send or receive SOS messages.  
2. To maintain efficient battery life, it is recommended that the helmet be fully charged before any long-term storage (six months to one year).

## **VI. Technical Specifications**

Charging port : Magnetic USB

Electricity parameter : DC 5V/1A

Battery : 3.7V/600mAh

Charging time : About 3hours

Waterproof class : IPX5

Battery life : about 10 hrs in the default Light Mode

Temperature: Storage Temperature: -20°C ~45°C. Temperature for use: 0°C~40°C. Temperature while charging: 0°C~40°C.

**Notes:** The above data is measured by LIVALL in a controlled environment, with room temperature at 25°C and specific light patterns. The actual data might be different according to the environment.

## VII. Electronic functions troubleshooting

During the usage, if the following troubles occur, please charge the product according to quick guide of the model(the helmet can be reset during the charging). If the problems still can not be solved, please contact the after-sales service center. (After-sales email: riding@livall.com)

Faults:

1. Can not be charged or turn-off normally;
2. The helmet is turn on, but the lights and other functions can not work normally.
3. After power on, it turns off automatically in a short time without reason.

Note: Please refer to the quick guide of the specific model for function details.

**Performance standards:**

**USA:** CPSC1203:1998, FCC Part 15 Rules

**Europe:** EN 1078: 2012+A1:2012

## VIII. Instructions for Use and Care

1. That the helmet can only protect if it fits well and that the buyer should try different sizes and choose the size which feels secure and comfortable on the head.
2. That the helmet should be adjusted to fit the user e.g. the straps positioned so that they do not cover the ears, the buckle positioned away from the jawbone and the straps and buckle adjusted to be both comfortable and firm.
3. How the helmet should be position on the head to ensure the intended protection is provided (e.g. that it should be placed so as to protect the forehead and not be pushed too far over the back of the head.)
4. That a helmet cannot always protect against injury.
5. That a helmet subjected to a severe impact should be discarded and destroyed.
6. A statement of the danger of modifying or removing any of the original component parts of the helmet other than as recommended by the manufacturer, and that helmets should not be adapted for the purpose of fitting

accessories in a way not recommended by the manufacturer.

7. This device complies with part 15 of the FCC Rules. Operation is subject to the following two conditions:(1) This device may not cause harmful interference, and (2) this device must accept any interference received, including interference that may cause undesired operation.

8. Take good care of the product, do not wash the surface of the helmet with corrosive solvent, do not strike the helmet;

9. Validity: Valid for 3 years without impact and under normal use.

This helmet is in conformity with the regulation (EU) 2016/425;

This helmet is in conformity with the Personal Protective Equipment (Enforcement) Regulations 2018;



LIVALL Tech Co., Ltd. declare that the full EU Declaration of conformity and UK Declaration of conformity are available on the Internet at <http://www.livall.com/tech/product.html>

NOTE: This equipment has been tested and found to comply with the limits for a Class B digital device, pursuant to part 15 of the FCC Rules. These limits are designed to provide reasonable protection against harmful interference in a residential installation. This equipment generates uses and can radiate radio frequency energy and, if not installed and used in accordance with the instructions, may cause harmful interference to radio communications. However, there is no guarantee that interference will not occur in a particular installation. If this equipment does cause harmful interference to radio or television reception, which can be determined by turning the equipment off and on, the user is encouraged to try to correct the interference by one or more of the following measures:

- Reorient or relocate the receiving antenna.
- Increase the separation between the equipment and receiver.
- Connect the equipment into an outlet on a circuit different from that to which the receiver is connected.
- Consult the dealer or an experienced radio/TV technician for help

Changes or modifications not expressly approved by the party responsible for compliance could void the user's authority to operate the equipment.

## 一. 简介

欢迎使用 LIVALL 智能头盔，本指南会指引您如何更好地使用本产品。随着本公司产品的持续完善，本指南将会不定期更新，您可以在 LIVALL 官方网站 ([www.livall.com](http://www.livall.com)) 上获取最新版本及了解头盔的更多信息。

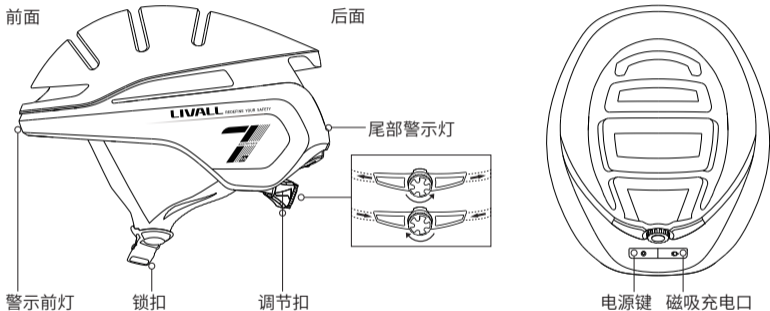

温馨提示：本图片仅供参考，如实物外形与图片不同，请以实物为准。

## 二、包装清单

智能头盔：1个    闪控：1个    快速入门指南与保修细则：1份    磁吸式 USB 充电线：1条

### 三. 佩戴说明



错误



错误



正确



调节好拉带的长度



留有一指间的空隙



把头盔扶正



检查扣具是否完好

## 四. 操作说明

### 激活头盔

初次使用，需先激活头盔，按尾部电源键即可激活，尾灯亮起表示激活成功。

注：若无法成功激活，请充电后再尝试。

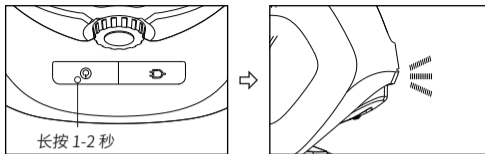

### 电量显示

开机时可通过尾部中间灯珠的点亮数量查看头盔剩余电量，灯珠全亮表示满电。

### 连接闪控（控制左右转向灯）

#### 1、首次连接

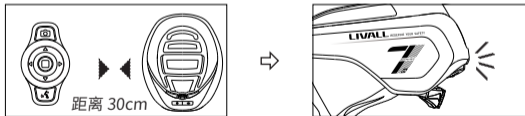

开启闪控，闪控与头盔距离在 30cm 范围内，会自动连接到头盔。

连接成功后，头盔尾灯按默认灯光模式闪烁。

## 2、连接新闪控：（原闪控丢失或损坏后，需要连接新闪控时）

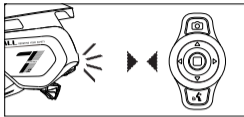

将开机的闪控靠近主控，预警灯出现 3 次 /S 的闪烁，表示有闪控需要接入头盔。

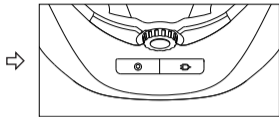

10s 内按头盔的电源键，确认连接该闪控。



此时头盔尾灯继续按之前设置的灯光模式闪烁，连接成功后，即可控制左右转向灯。

注：A、闪控连接成功后，可通过操作闪控左（L）、右（R）按键控制头盔左右转向灯；

B、除去闪控左（L）、右（R）按键外、中间红色确认按键外，其他键暂时不需使用。

### 自动休眠

头盔开机后，静止一会儿无晃动，即可进入自动休眠（省电）模式，尾灯熄灭表示休眠成功。

### 自动唤醒

佩戴前轻轻摇晃几下，即可自动唤醒头盔，尾灯亮起表示唤醒成功。

### 自适应预警灯光（默认开启，可通过 APP 关闭）

即在光线良好情况下，只有中间的一颗尾灯不停闪烁，其余的尾灯将自动关闭。在夜间或昏暗环境下，整排尾灯将自动开启，进入闪烁状态。



## 多种灯光模式

可通过短按尾部电源键切循环切换尾部警示灯 3 种闪烁模式。

## 刹车警示灯

当头盔检测到明显减速时，尾灯将会全部亮起并停留几秒，以警示后方车辆。

注：头盔晃动过大时，内置传感器也会检测到明显减速，可能会触发警示灯常亮，属于正常现象。

## 连接手机



1、下载“来啊”骑行APP；

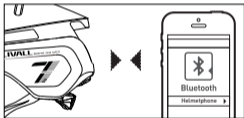

2、打开手机蓝牙，将头盔靠近手机；



3、在APP中点击“装备”，点击“头盔”，头盔即可与手机连接，连接成功后“头盔”显示“EVO21”。

温馨提示：为保障连接信号的稳定性，请尽量将手机放在身体前方。

## 摔倒求救（需连接“来啊骑行”APP）

头盔内含摔倒检测传感器，当检测到摔倒时，可将摔倒信号通过蓝牙技术发送到“来啊骑行”APP，由“来啊骑行”APP发出求救信息给事先设置好的紧急联系人。

## 关机

长按尾部电源键即可强制关机头盔，尾灯熄灭关机成功。

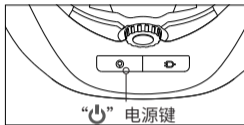

## 充电

掀开带有“⏻”字符的软胶，可见充电接口。使用磁吸 USB 充电口连接头盔充电口，中间区域尾灯亮起表示正在充电，熄灭表示充电完成。

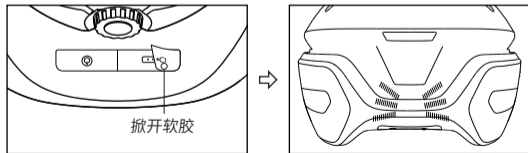

EVO21 功能列表

序号	功能	序号	功能
1	自动休眠	6	多灯光模式
2	自动唤醒	7	左右转向灯
3	开机电量显示	8	刹车警示灯
4	光感警示灯	9	SOS 功能
5	前警示灯		

注：具体功能描述详见快速指南对应内容。

## 五、注意事项

- 1、头盔内含电子功能，有短时间防淋溅雨水的功能，请不要长期在下雨环境骑行；
- 2、头盔淋雨后，尾部警示灯罩内可能会出现水珠，请将头盔放在通风环境下 1-2 天，水珠会自动消除；
- 3、头盔内含电池，电池的容量会随温度变化而改变，在低温或低于 0 摄氏度环境使用时，产品的续航时间可能会不同程度衰减；
- 4、如果出现电子功能无法使用或异常，请充电 3 小时后再继续尝试；
- 5、★头盔内含撞击检测装置，只有提前连接到“来啊骑行”App 并且开启骑行，头盔受到严重撞击后，您在“来啊骑行”App 中设置的“紧急联系人”才会收到求救信息；
- 6、禁止用金属或坚硬工具清洁充电接口金色触点，如刀片、镊子等。如果需清洁请用棉签加清水或酒精擦拭。

充电时，请保持充电口清洁，干燥；

7、产品内置的电池，严禁拆卸、挤压、加热或燃烧电池，严禁使用尖锐物、螺丝刀等刺破、撬电池，以上操作可能会引起电池起火或燃烧；

8、请不要将头盔与尖锐物品一起放置，以免损坏头盔。

注：1、可能因网络异常等问题导致无法成功发送或接收 SOS 信息；

2、为了维持电池的使用寿命，建议头盔每次长期（半年到一年）储存前需充满电。

## 六、技术规格

充电接口：磁吸式充电口

电气参数：DC 5V/1A

电池：3.7V/600mAh

充电时间：约 3 小时

防水等级：IPX5

续航时间：默认灯光模式 10 小时

温度：储存温度 -20°C ~45°C，使用温度 0°C ~40°C，充电温度 0°C ~40°C

注：以上数据由 LIVALL 实验室在室温 25°C、特定灯光模式下测得，实际使用时因客观环境的变化或有误差。为了维持电池的使用寿命，建议头盔每次长期（半年到一年）储存前需充满电。

## 七、电子功能故障排除

在使用过程中，如果出现以下功能异常，请按各型号快速指南的充电时长进行充电操作（充电时可对头盔进行复位）。如果还是无法排除，请联系售后服务中心。（售后邮箱：[riding@livall.com](mailto:riding@livall.com)）

故障现象：

- 1、无法正常充电和开机；
- 2、开机时，灯光等功能异常或无法使用；
- 3、开机后，使用较短时间出现无故关机。

注：各型号具体功能请参考对应的快速指南。

## 八、佩戴警示及说明

- 1、购买者挑选适合自己头型尺寸的合格头盔；
- 2、使用时必须系紧系带；
- 3、头盔如果发生较大撞击应停止使用或鉴定是否可继续使用；
- 4、注意保管，禁止用腐蚀性溶剂擦洗头盔，不要撞击头盔；
- 5、不得更改头盔的结构；
- 6、正确佩戴运动头盔能有效降低运动伤害，但不能完全避免伤害；
- 7、产品在运输和贮存时要注明防止碰撞、受潮和有机化学物品的侵蚀。
- 8、头盔正常的使用期限为3年。







Designed and Manufactured  
in Shenzhen, China

Approved body:

ITS Testing Services(UK) Ltd., Centre Court, Meridian Business Park, Leicester LE19 1WD. UKCA AB0362

Notified Body:

Telefication B.V. with its office located at Wilmersdorf 50, 7327 AC Apeldoorn, The Netherlands. Notified Body No. 0560

**Original Design Manufacturer:**

LIVALL Tech Co., Ltd.

**Address:**

904, R&D Building Tsinghua Hi-Tech Park, NanShan, Shenzhen, China

**Postal Code:**

518057

**Website:**

[www.livall.com](http://www.livall.com)

**Support & Service E-mail:**

[support@livall.com](mailto:support@livall.com)

**EVO21-QO-V1.0**