



TEST REPORT

FCC ID :	2AEJARAYOX1PLUS	
Test Report No :	TCT230403E025	
Date of issue :	Apr. 17, 2023	
Testing laboratory	SHENZHEN TONGCE TESTING LAB	
Testing location/ address:	2101 & 2201, Zhenchang Factory Renshan Industrial Zone, Fuhai Subdistrict, Bao'an District, Shenzhen, Guangdong, 518103, People's Republic of China	
Applicant's name :	GSM GLOBE.COM INC	
Address :	10286 SW 22nd pl. Davie, Florida 33324 United States	
Manufacturer's name ... :	GSM GLOBE.COM INC	
Address :	10286 SW 22nd pl. Davie, Florida 33324 United States	
Standard(s)	FCC CFR Title 47 Part 2 FCC CFR Title 47 Part22 FCC CFR Title 47 Part24	
Product Name :	MOBILE PHONE	
Trade Mark	RAYO MOVIL	
Model/Type reference :	X1 Plus	
Rating(s) :	Refer to EUT description of page 3	
Date of receipt of test item	Apr. 03, 2023	
Date (s) of performance of test :	Apr. 03, 2023 - Apr. 17, 2023	
Tested by (+signature) ... :	Rleo LIU	
Check by (+signature) :	Beryl ZHAO	
Approved by (+signature):	Tomsin	



General disclaimer:

This report shall not be reproduced except in full, without the written approval of SHENZHEN TONGCE TESTING LAB. This document may be altered or revised by SHENZHEN TONGCE TESTING LAB personnel only, and shall be noted in the revision section of the document. The test results in the report only apply to the tested sample.

Table of Contents

1. General Product Information	3
1.1. EUT description	3
1.2. Model(s) list.....	4
1.3. Operation Frequency	4
2. Test Result Summary	5
3. General Information.....	6
3.1. Test environment and mode.....	6
3.2. Description of Support Units.....	7
3.3. Configuration of Tested System	8
3.4. Measurement Results Explanation Example.....	8
4. Facilities and Accreditations	9
4.1. Facilities	9
4.2. Location	9
4.3. Measurement Uncertainty.....	9
5. Test Results and Measurement Data	10
5.1. Conducted Output Power Measurement	10
5.2. Peak to Average Ratio.....	12
5.3. 99% Occupied Bandwidth and 26dB Bandwidth Measurement	18
5.4. Band Edge and Conducted Spurious Emission Measurement	26
5.5. Effective Radiated Power and Effective Isotropic Radiated Power Measurement	37
5.6. Field Strength of Spurious Radiation Measurement	44
5.7. Frequency Stability Measurement	52
Appendix B: Photographs of Test Setup	
Appendix C: Photographs of EUT	

1. General Product Information

1.1. EUT description

Product Name:	MOBILE PHONE
Model/Type reference:	X1 Plus
Sample Number:	TCT230403E011-0101
3G Version	WCDMA: R99 HSDPA: Release 5 HSUPA: Release 6
Tx Frequency	GSM/GPRS/EGPRS 850: 824.2MHz ~ 848.8MHz GSM/GPRS/EGPRS 1900: 1850.2MHz ~ 1909.8MHz WCDMA Band V: 826.4MHz ~ 846.6MHz WCDMA Band II: 1852.4MHz ~ 1907.6MHz
Rx Frequency	GSM/GPRS/EGPRS 850: 869.2MHz ~ 893.8MHz GSM/GPRS/EGPRS 1900: 1930.2MHz ~ 1989.8MHz WCDMA Band V: 871.4MHz ~ 891.6MHz WCDMA Band II: 1932.4MHz ~ 1987.6MHz
Maximum Output Power to Antenna:	GSM850: 32.57dBm GSM1900: 29.81Bm GPRS850: 32.48dBm GPRS1900: 29.76dBm EGPRS850: 28.32dBm EGPRS1900: 26.28dBm WCDMA Band V: 22.75dBm WCDMA Band II: 22.65dBm
99% Occupied Bandwidth:	GSM850: 248KGXW GSM1900: 249KGXW GPRS850 Class 8: 248KGXW GPRS1900 Class 8: 249KGXW EGPRS850 Class 8: 248KG7W EGPRS1900 Class 8: 249KG7W WCDMA Band V RMC 12.2Kbps: 4M14F9W WCDMA Band II RMC 12.2Kbps: 4M16F9W
Type of Modulation:	GSM/GPRS/EGPRS: GMSK WCDMA/HSDPA/HSUPA: QPSK
Antenna Type:	Internal Antenna
Antenna Gain:	GSM/GPRS/EGPRS 850: 0.5dBi GSM/GPRS/EGPRS 1900: 0.8dBi WCDMA Band V: 1.0dBi WCDMA Band II: 2.4dBi
Rating(s):	Adapter Information: Input: AC 100-240V, 50/60Hz, 0.3A Output: DC 5V,1000mA, 5W Rechargeable Li-ion Battery DC 3.8V

Note: The antenna gain listed in this report is provided by applicant, and the test laboratory is not responsible for this parameter.

1.2. Model(s) list

None.

1.3. Operation Frequency

GSM 850		PCS1900	
Channel:	Frequency (MHz)	Channel:	Frequency (MHz)
128	824.20	512	1850.20
129	824.40	513	1850.40
....
189	836.40	660	1879.80
190	836.60	661	1880.00
191	836.80	662	1880.20
...
250	848.60	809	1909.60
251	848.80	810	1909.80

WCDMA Band V		WCDMA Band II	
Channel:	Frequency (MHz)	Channel:	Frequency (MHz)
4132	826.40	9262	1852.40
4133	826.60	9263	1852.60
....
4182	836.40	9399	1879.80
4183	836.60	9400	1880.00
4184	836.80	9401	1880.20
...
4233	846.60	9538	1907.60

2. Test Result Summary

Requirement	CFR 47 Section	Result
Conducted Output Power	§22.913; §2.1046 §24.232	PASS
Peak-to-Average Ratio	§2.1046; §24.232(d) §22.913	PASS
Effective Radiated Power	§2.1046; §22.913(a) §24.232	PASS
Equivalent Isotropic Radiated Power	§2.1046; §22.913(a) §24.232	PASS
Occupied Bandwidth	§2.1049	PASS
Band Edge	§2.1051 §22.917(a) §24.238(a)	PASS
Conducted Spurious Emission	§2.1051; §22.917 §24.238	PASS
Field Strength of Spurious Radiation	§2.1053; §22.917(a) §24.238	PASS
Frequency Stability for Temperature & Voltage	§2.1055; §22.355 §24.235	PASS

Note:

1. PASS: Test item meets the requirement.
2. Fail: Test item does not meet the requirement.
3. N/A: Test case does not apply to the test object.
4. The test result judgment is decided by the limit of test standard.

3. General Information

3.1. Test environment and mode

Operating Environment:	
Temperature:	23.5 °C
Humidity:	52 % RH
Atmospheric Pressure:	1010 mbar

Keep the EUT in communication with CMU200 and select channel with modulation
All modes and data rates and positions were investigated.
Test modes are chosen to be reported as the worst case configuration below:

Test Mode		
Band	Radiated TCs	Conducted TCs
GSM 850	GSM Link GPRS class 12 Link EGPRS class 12 Link	GSM Link GPRS class 12 Link EGPRS class 12 Link
PCS 1900	GSM Link GPRS class 12 Link EGPRS class 12 Link	GSM Link GPRS class 12 Link EGPRS class 12 Link
WCDMA Band V	RMC 12.2Kbps Link	RMC 12.2Kbps Link
WCDM Band II	RMC 12.2Kbps Link	RMC 12.2Kbps Link

Antenna port conducted and radiated test items were performed according to KDB 971168 D01 Power Meas. License Digital Systems v03r01 with maximum output power. Radiated measurements were performed with rotating EUT in different three orthogonal test planes to find the maximum emission. The sample was placed (0.8m below 1GHz, 1.5m above 1GHz) above the ground plane of 3m chamber. Measurements in both horizontal and vertical polarities were performed. During the test, each emission was maximized by: having the EUT continuously working, investigated all operating modes, rotated about all 3 axis (X, Y & Z) and considered typical configuration to obtain worst position, manipulating interconnecting cables, rotating the turntable, varying antenna height from 1m to 4m in both horizontal and vertical polarization. The emissions worst-case (Z axis) are shown in Test Results of the following pages.

3.2. Description of Support Units

The EUT has been tested as an independent unit together with other necessary accessories or support units. The following support units or accessories were used to form a representative test configuration during the tests.

Equipment	Model No.	Serial No.	FCC ID	Trade Name
/	/	/	/	/

Note:

1. All the equipment/cables were placed in the worst-case configuration to maximize the emission during the test.
2. Grounding was established in accordance with the manufacturer's requirements and conditions for the intended use.

3.3. Configuration of Tested System

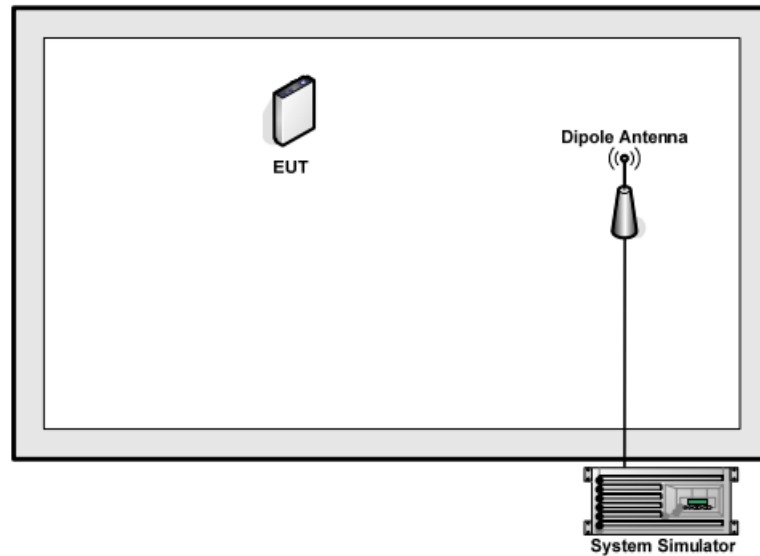

3.4. Measurement Results Explanation Example

For all conducted test items:

The offset level is set in the spectrum analyzer to compensate the RF cable loss and attenuator factor between RF conducted output port and spectrum analyzer. With the offset compensation, the spectrum analyzer reading level will be exactly the RF output level. The spectrum analyzer offset is derived from RF cable loss and attenuator factor.

Offset = RF cable loss + attenuator factor.

The following shows an offset computation example with RF cable loss 3 dB and a 5dB attenuator.

Example: $Offset (dB) = RF\ cable\ loss (dB) + attenuator\ factor (dB)$
 $= 8(dB)$

4. Facilities and Accreditations

4.1. Facilities

The test facility is recognized, certified, or accredited by the following organizations:

- FCC - Registration No.: 645098

SHENZHEN TONGCE TESTING LAB

Designation Number: CN1205

The testing lab has been registered and fully described in a report with the (FCC) Federal Communications Commission. The acceptance letter from the FCC is maintained in our files.

- IC - Registration No.: 10668A-1

SHENZHEN TONGCE TESTING LAB

CAB identifier: CN0031

The testing lab has been registered by Certification and Engineering Bureau of Industry Canada for radio equipment testing.

4.2. Location

SHENZHEN TONGCE TESTING LAB

Address: 2101 & 2201, Zhenchang Factory Renshan Industrial Zone, Fuhai Subdistrict, Bao'an District, Shenzhen, Guangdong, 518103, People's Republic of China

TEL: +86-755-27673339

4.3. Measurement Uncertainty

The reported uncertainty of measurement $y \pm U$, where expanded uncertainty U is based on a standard uncertainty multiplied by a coverage factor of $k=2$, providing a level of confidence of approximately 95 %.

No.	Item	MU
1	Conducted Emission	± 3.10 dB
2	RF power, conducted	± 0.12 dB
3	Spurious emissions, conducted	± 0.11 dB
4	All emissions, radiated(<1 GHz)	± 4.56 dB
5	All emissions, radiated(1 GHz - 18 GHz)	± 4.22 dB
6	All emissions, radiated(18 GHz- 40 GHz)	± 4.36 dB
7	Temperature	± 0.1 °C
8	Humidity	± 1.0 %

5. Test Results and Measurement Data

5.1. Conducted Output Power Measurement

5.1.1. Test Specification

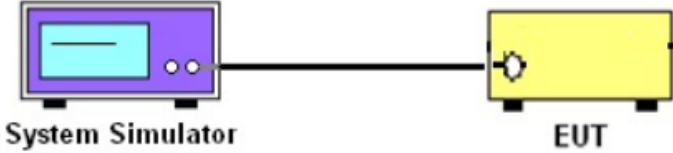
Test Requirement:	FCC part 22.913(a) and FCC part 24.232(b)
Test Method:	FCC KDB 971168 D01 v03r01
Operation mode:	Refer to item 3.1
Limits:	GSM 850: 7W PCS 1900: 2W WCDMA Band V:7W WCDMA Band II: 2W
Test Setup:	 <p>The diagram illustrates the test setup. On the left is a purple box labeled 'System Simulator' with a screen and two buttons. A black line representing a cable connects it to a yellow box on the right labeled 'EUT' (Equipment Under Test), which has a circular port on its side.</p>
Test Procedure:	<ol style="list-style-type: none"> 1. The transmitter output port was connected to the system simulator. 2. Set EUT at maximum power through system simulator. 3. Select lowest, middle, and highest channels for each band and different modulation. 4. Measure the maximum burst average power for GSM and maximum average power for other modulation signal.
Test Result:	PASS

5.1.2. Test Instruments

Equipment	Manufacturer	Model	Serial Number	Calibration Due
System simulator	R&S	CMU200	110188	Jul. 04, 2023
Combiner Box	Ascentest	AT890-RFB	/	/

5.1.3. Test data

Conducted Power Measurement Results:

Average Conducted Power (*Unit: dBm)						
Band	GSM850			PCS 1900		
Channel	128	190	251	512	661	810
Frequency(MHz)	824.2	836.6	848.8	1850.2	1880.0	1909.8
GSM	32.32	32.49	32.57	29.81	29.63	29.63
GPRS class8	32.30	32.48	32.48	29.76	29.56	29.58
GPRS class10	31.79	31.85	31.82	28.58	28.63	28.67
GPRS class11	31.24	31.41	31.39	27.72	27.79	27.62
GPRS class12	30.38	30.44	30.36	26.61	26.72	26.58
EGPRS class8	28.27	28.29	28.32	26.28	26.17	26.14
EGPRS class10	27.45	27.53	27.57	24.63	24.54	24.51
EGPRS class11	26.52	26.57	26.64	23.57	23.42	23.46
EGPRS class12	25.61	25.63	25.67	22.49	22.45	22.38
Average Conducted Power (*Unit: dBm)						
Band	WCDMA Band V			WCDMA Band II		
Channel	4132	4182	4233	9262	9400	9538
Frequency(MHz)	826.4	836.4	846.6	1852.4	1880.0	1907.6
WCDMA RMC 12.2K	22.43	22.36	22.75	22.65	21.95	22.04
HSDPA Subtest-1	22.29	22.34	22.52	22.62	21.91	22.03
HSDPA Subtest-2	21.82	21.87	22.08	22.17	21.35	21.60
HSDPA Subtest-3	21.35	21.44	21.59	21.74	20.93	21.24
HSDPA Subtest-4	21.07	21.10	21.27	21.38	20.50	20.81
HSUPA Subtest-1	22.03	22.16	22.06	21.78	21.82	21.92
HSUPA Subtest-2	21.90	22.06	21.98	21.34	21.50	21.63
HSUPA Subtest-3	21.35	21.79	21.54	20.96	21.14	21.25
HSUPA Subtest-4	20.97	21.33	21.16	20.73	20.84	21.08
HSUPA Subtest-5	20.53	20.82	20.79	20.41	20.56	20.64

5.2. Peak to Average Ratio

5.2.1. Test Specification

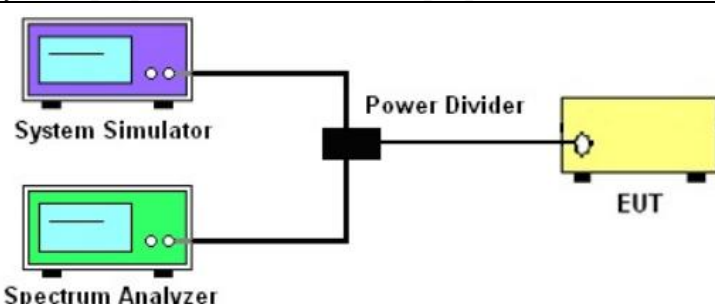
Test Requirement:	FCC part 24.232(d) ; FCC part 22.913;
Test Method:	ANSI C63.26:2013
Operation mode:	Refer to item 3.1
Limit:	The peak-to-average ratio (PAR) of the transmission may not exceed 13 dB.
Test Setup:	 <p>The diagram illustrates the test setup. On the left, there are two computer monitors: a purple one labeled 'System Simulator' and a green one labeled 'Spectrum Analyzer'. Both are connected to a central black box labeled 'Power Divider'. From the 'Power Divider', a single line connects to a yellow rectangular device labeled 'EUT' (Equipment Under Test).</p>
Test Procedure:	<ol style="list-style-type: none"> 1. The testing follows FCC KDB 971168 D01v03r01 Section 5.7.1. 2. The EUT was connected to spectrum analyzer and system simulator via a power divider. 3. Set EUT to transmit at maximum output power. 4. For GSM/EGPRS operating modes, signal gating is implemented on the spectrum analyzer by triggering from the system simulator. 5. Set the CCDF (Complementary Cumulative Distribution Function) option of the spectrum analyzer. Record the maximum PAPR level associated with a probability of 0.1%.
Test Result:	PASS

5.2.2. Test Instruments

Equipment	Manufacturer	Model	Serial Number	Calibration Due
System simulator	R&S	CMU200	110188	Jul. 04, 2023
Spectrum Analyzer	Agilent	N9020A	MY49100619	Jul. 04, 2023
Combiner Box	Ascentest	AT890-RFB	/	/

5.2.3. Test Data

Cellular Band			
Mode	GSM850		
Channel	128	190	251
Frequency (MHz)	824.2	836.6	848.8
Peak-to-Average Ratio (dB)	9.21	9.21	9.70

PCS Band			
Mode	GSM 1900		
Channel	512	661	810
Frequency (MHz)	1850.2	1880	1909.8
Peak-to-Average Ratio (dB)	9.67	9.74	9.54

Cellular Band						
Mode	WCDMA Band V (RMC 12.2Kbps)			WCDMA Band II (RMC 12.2Kbps)		
Channel	4132	4182	4233	9262	9400	9538
Frequency (MHz)	826.4	836.4	846.6	1852.4	1880	1907.6
Peak-to-Average Ratio (dB)	3.22	3.12	3.15	2.81	2.97	2.79

Note: Measurements were conducted in all GMSK modulation (GSM/GPRS/EGPRS) and the worst case Mode (GSM) was submitted only.

Test plots as follows:

GSM 850

Peak-to-Average Ratio on Channel 128

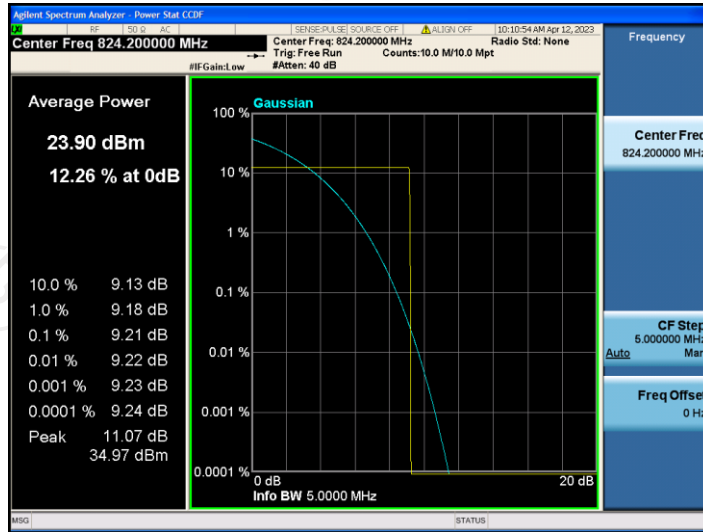

Peak-to-Average Ratio on Channel 190

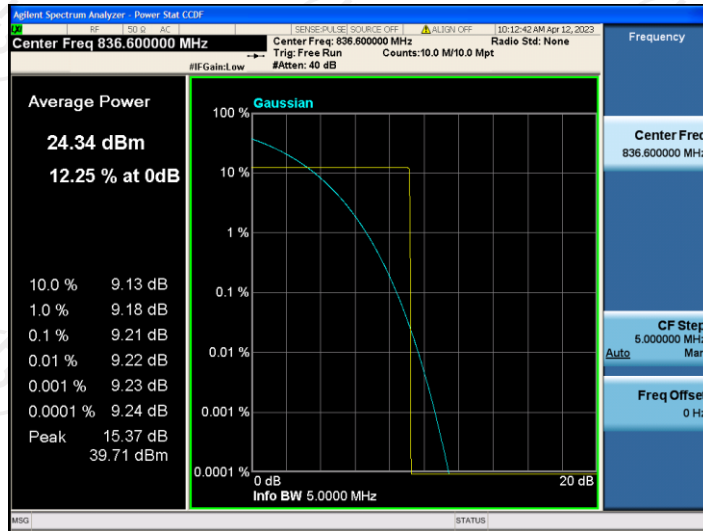

Peak-to-Average Ratio on Channel 251

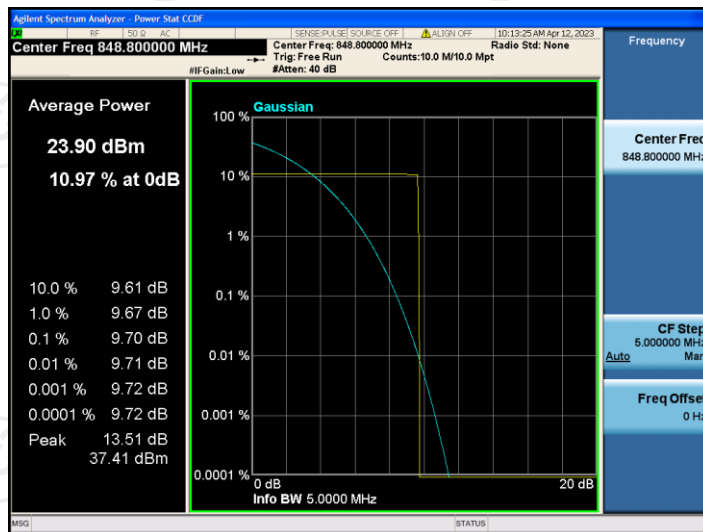

Peak-to-Average Ratio on Channel 512

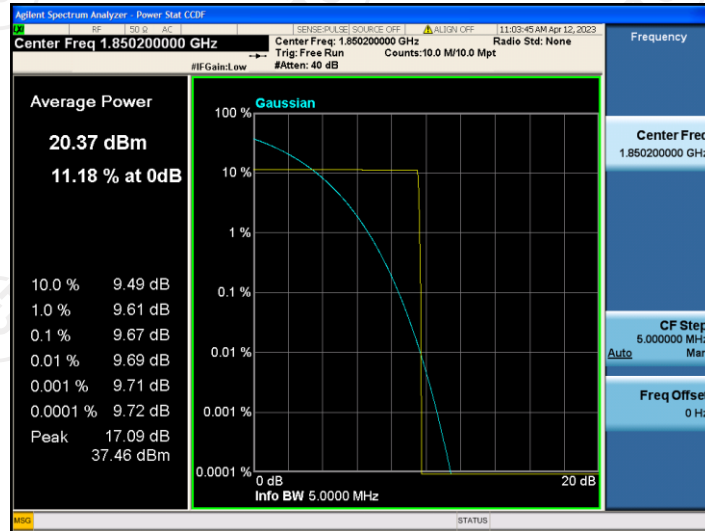

Peak-to-Average Ratio on Channel 661

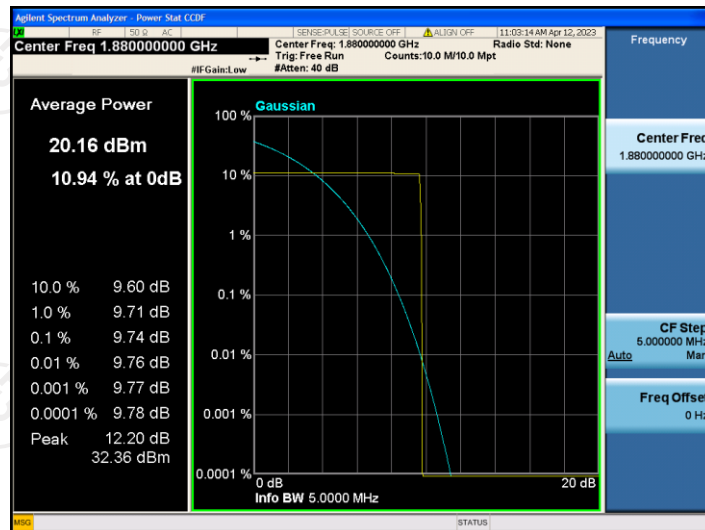

Peak-to-Average Ratio on Channel 810

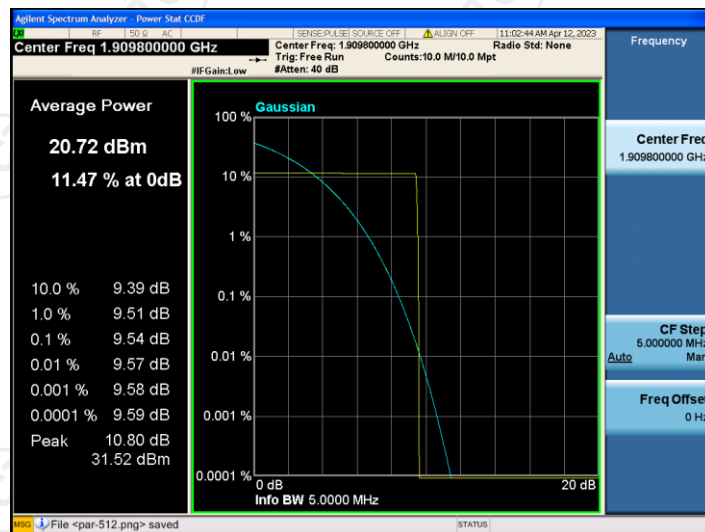

Peak-to-Average Ratio on Channel 4132

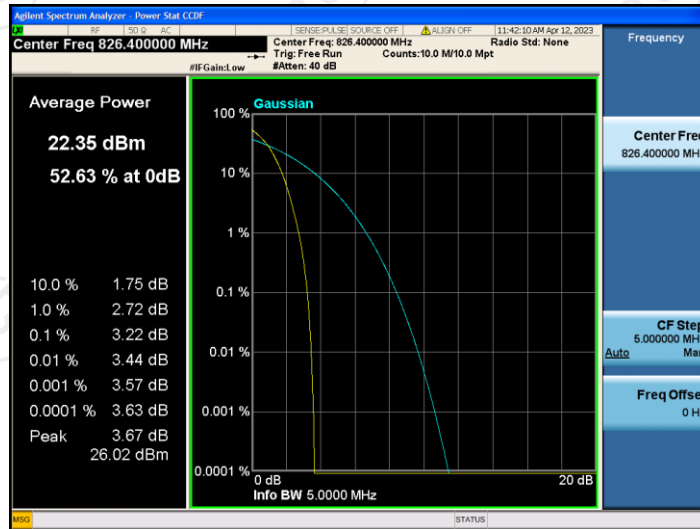

Peak-to-Average Ratio on Channel 4182

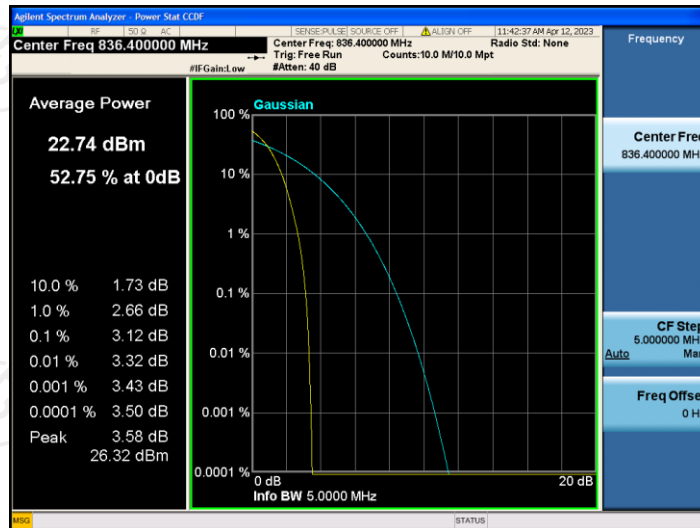

Peak-to-Average Ratio on Channel 4233

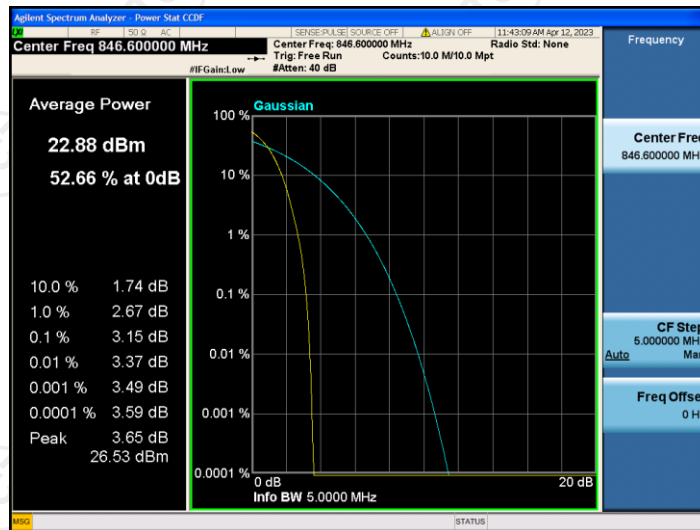

WCDMA Band II 12.2Kbps

Peak-to-Average Ratio on Channel 9262

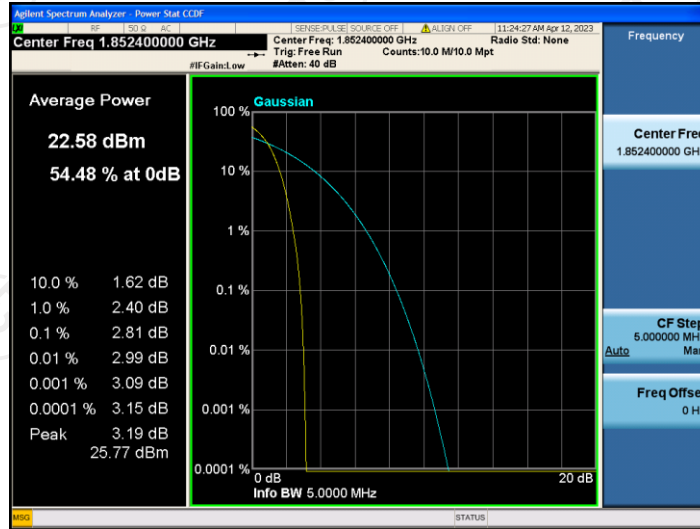

Peak-to-Average Ratio on Channel 9400

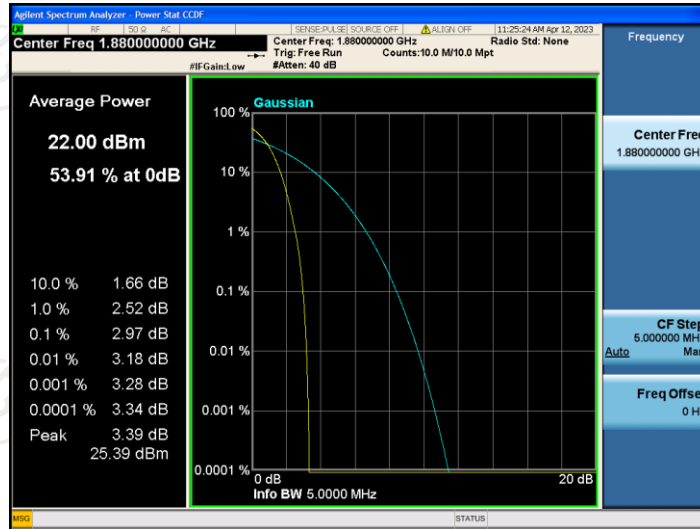

Peak-to-Average Ratio on Channel 9538

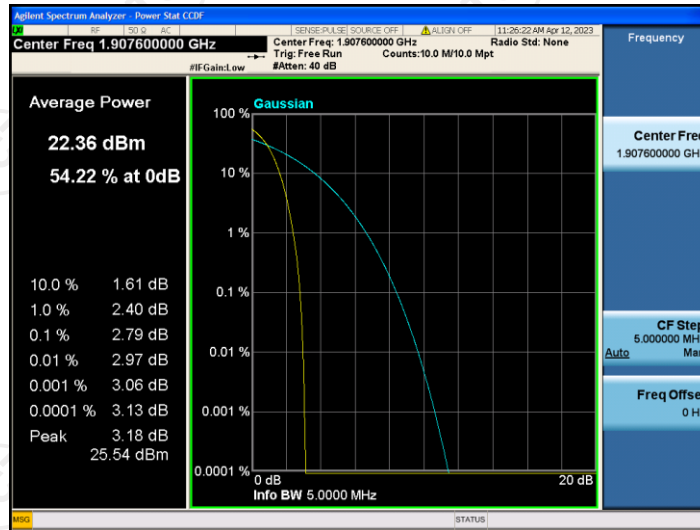

5.3. 99% Occupied Bandwidth and 26dB Bandwidth Measurement

5.3.1. Test Specification

Test Requirement:	FCC part 2.1049
Test Method:	FCC KDB 971168 D01v03r01
Operation mode:	Refer to item 3.1
Limit:	N/A
Test Setup:	<p>The diagram illustrates the test setup. A System Simulator (purple box) and a Spectrum Analyzer (green box) are connected to a Power Divider (black box). The Power Divider is also connected to an EUT (yellow box).</p>
Test Procedure:	<ol style="list-style-type: none"> 1. The testing follows FCC KDB 971168 D01v03r01 Section 4.2. 2. The EUT was connected to the spectrum analyzer and system simulator via a power divider. 3. The RF output of the EUT was connected to the spectrum analyzer by RF cable and attenuator. The path loss was compensated to the results for each measurement. 4. The 99% occupied bandwidth were measured, set RBW= 1% of span, VBW= 3*RBW, sample detector, trace maximum hold. 5. The 26dB bandwidth were measured, set RBW= 1% of EBW, VBW= 3*RBW, peak detector, trace maximum hold.
Test Result:	PASS

5.3.2. Test Instruments

Equipment	Manufacturer	Model	Serial Number	Calibration Due
System simulator	R&S	CMU200	110188	Jul. 04, 2023
Spectrum Analyzer	Agilent	N9020A	MY49100619	Jul. 04, 2023
Combiner Box	Ascentest	AT890-RFB	/	/

5.3.3. Test data

Cellular Band			
Mode	GSM850		
Channel	128	190	251
Frequency (MHz)	824.2	836.6	848.8
99% OBW (kHz)	245.32	248.19	246.99
26dB BW (kHz)	312.90	314.80	317.70

Cellular Band			
Mode	GSM1900		
Channel	512	661	810
Frequency (MHz)	1850.2	1880.0	1909.8
99% OBW (kHz)	246.38	249.06	247.44
26dB BW (kHz)	319.30	319.10	318.70

Cellular Band			
Mode	EGPRS 850		
Channel	128	190	251
Frequency (MHz)	824.2	836.6	848.8
99% OBW (kHz)	238.53	242.45	238.03
26dB BW (kHz)	306.70	312.20	315.50

Cellular Band			
Mode	EGPRS 1900		
Channel	512	661	810
Frequency (MHz)	1850.2	1880.0	1909.8
99% OBW (kHz)	241.87	237.88	243.32
26dB BW (kHz)	313.90	318.10	314.70

Cellular Band			
Mode	WCDMA Band V (RMC 12.2Kbps)		
Channel	4132	4182	4233
Frequency (MHz)	826.4	836.4	846.6
99% OBW (MHz)	4.14	4.13	4.14
26dB BW (MHz)	4.66	4.67	4.66

Cellular Band			
Mode	WCDMA Band II (RMC 12.2Kbps)		
Channel	9262	9400	9538
Frequency (MHz)	1852.4	1880	1907.6
99% OBW (MHz)	4.16	4.15	4.14
26dB BW (MHz)	4.69	4.69	4.68

Test plots as follows:

Band:	GSM 850	Test Mode:	GSM Link (GMSK)
-------	---------	------------	-----------------

26dB&99% Occupied Bandwidth Plot on Channel 128

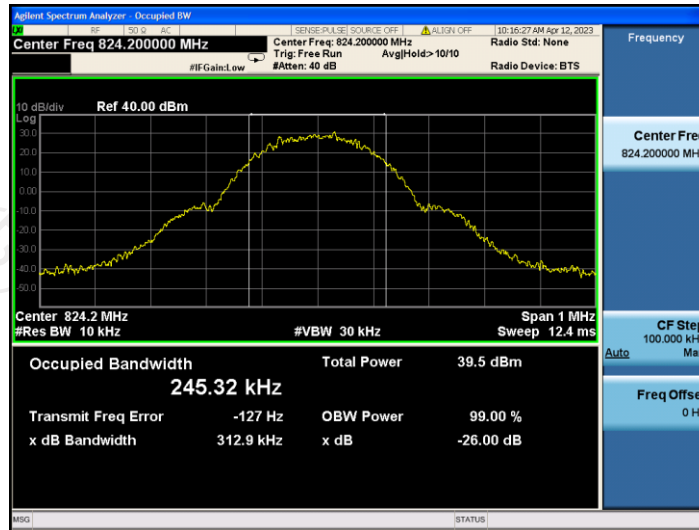

26dB&99% Occupied Bandwidth Plot on Channel 190

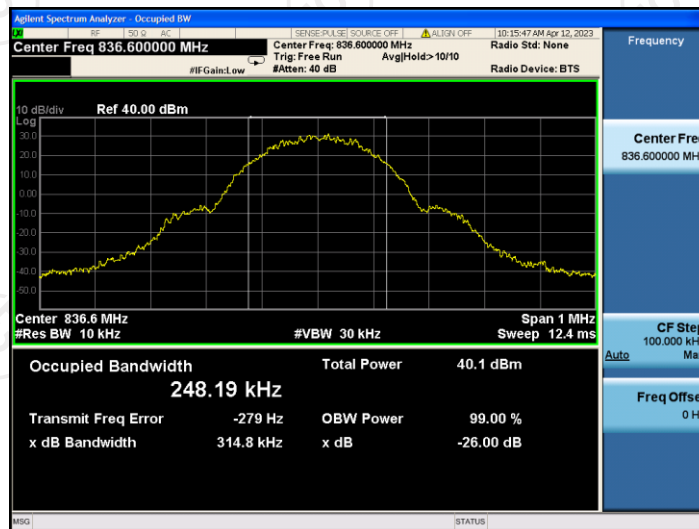

26dB&99% Occupied Bandwidth Plot on Channel 251

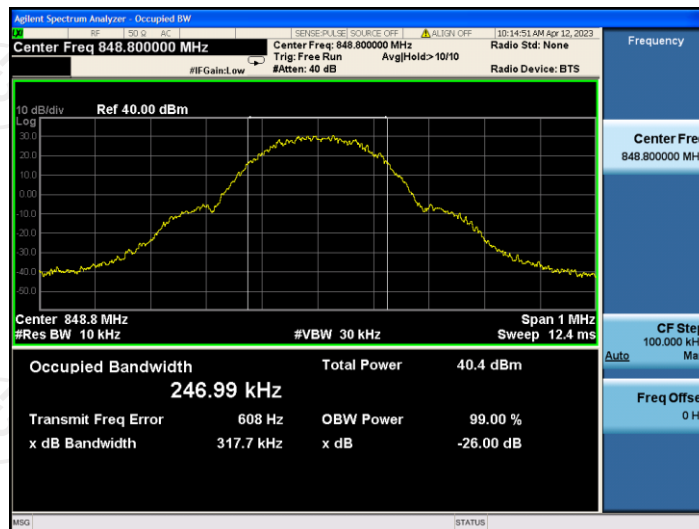

Band:	GSM 1900	Test Mode:	GSM Link (GMSK)
-------	----------	------------	-----------------

26dB&99% Occupied Bandwidth Plot on Channel 512

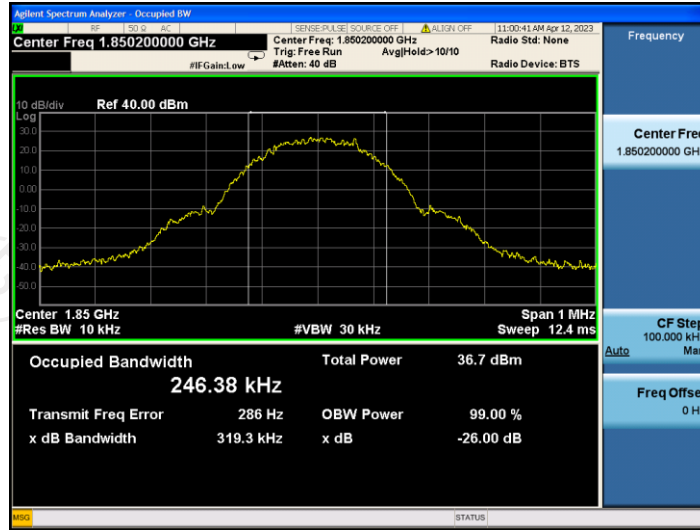

26dB&99% Occupied Bandwidth Plot on Channel 661



26dB&99% Occupied Bandwidth Plot on Channel 810

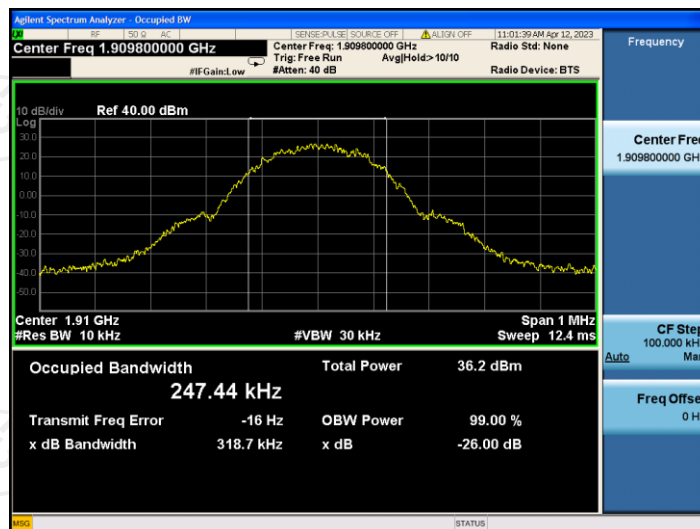

Band:	EGPRS 850	Test Mode:	EGPRS Link (GMSK)
-------	-----------	------------	-------------------

26dB&99% Occupied Bandwidth Plot on Channel 128

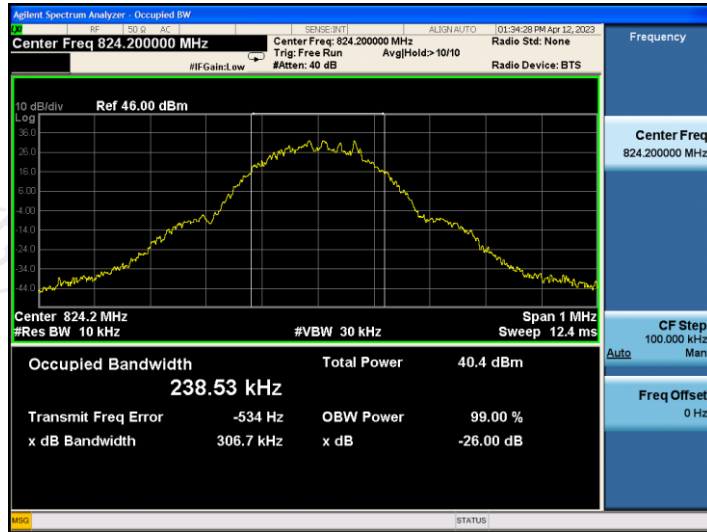

26dB&99% Occupied Bandwidth Plot on Channel 190

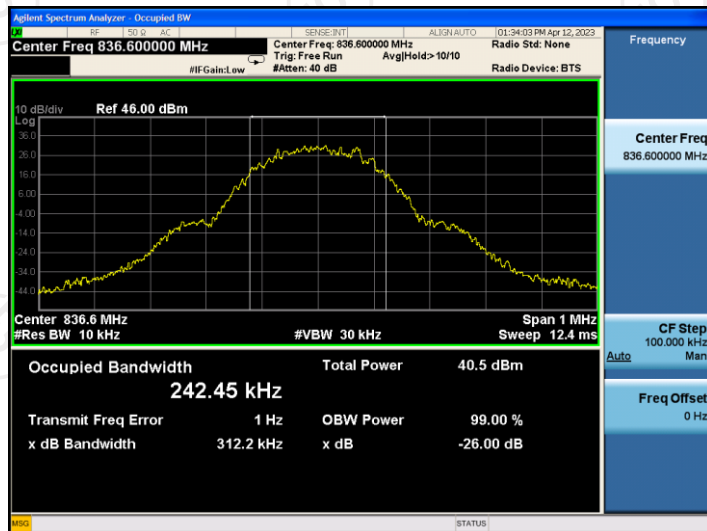

26dB&99% Occupied Bandwidth Plot on Channel 251

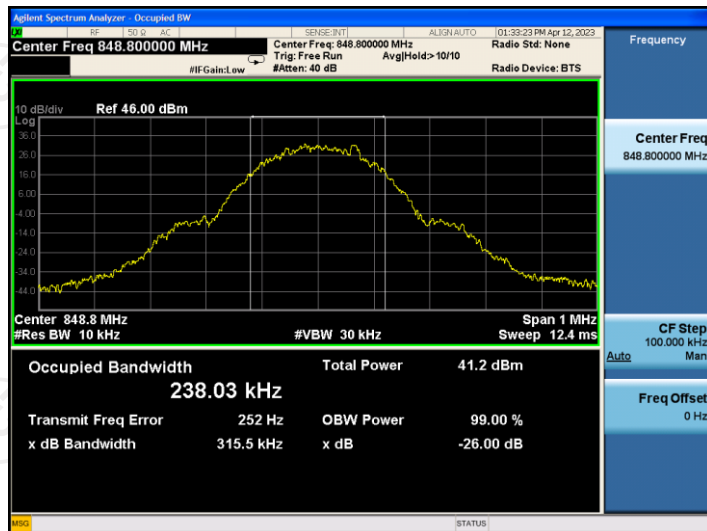

Band:	EGPRS 1900	Test Mode:	EGPRS Link (GMSK)
-------	------------	------------	-------------------

26dB&99% Occupied Bandwidth Plot on Channel 512

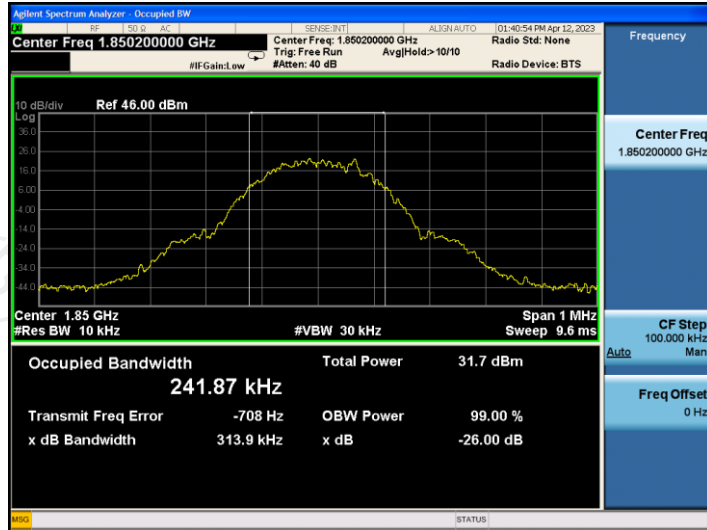

26dB&99% Occupied Bandwidth Plot on Channel 661

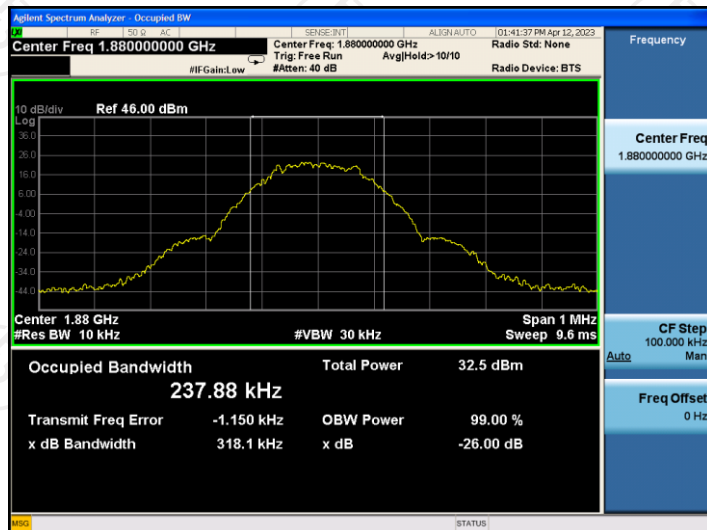

26dB&99% Occupied Bandwidth Plot on Channel 810

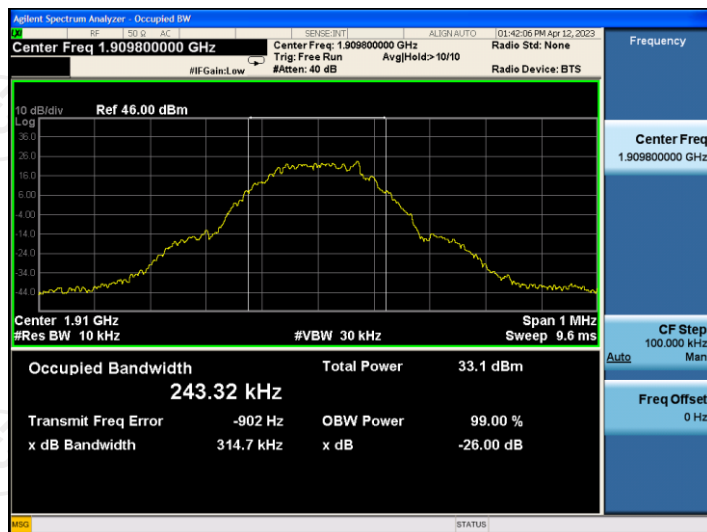

Band:	WCDMA Band V	Test Mode:	RMC 12.2Kbps Link (QPSK)
-------	--------------	------------	--------------------------

26dB&99% Occupied Bandwidth Plot on Channel 4132

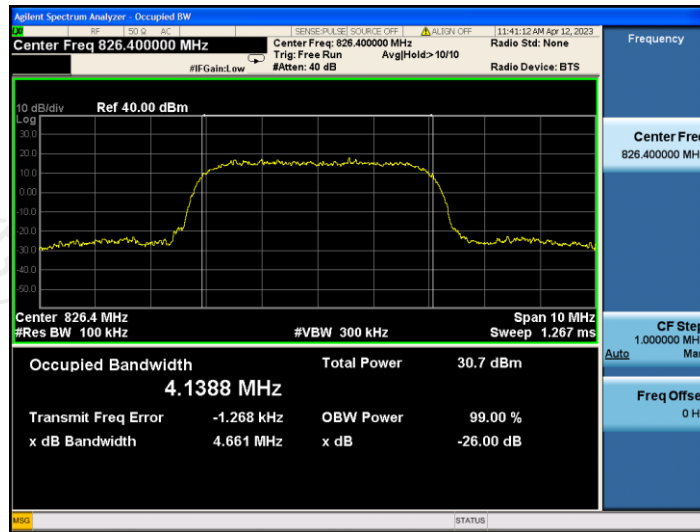

26dB&99% Occupied Bandwidth Plot on Channel 4182

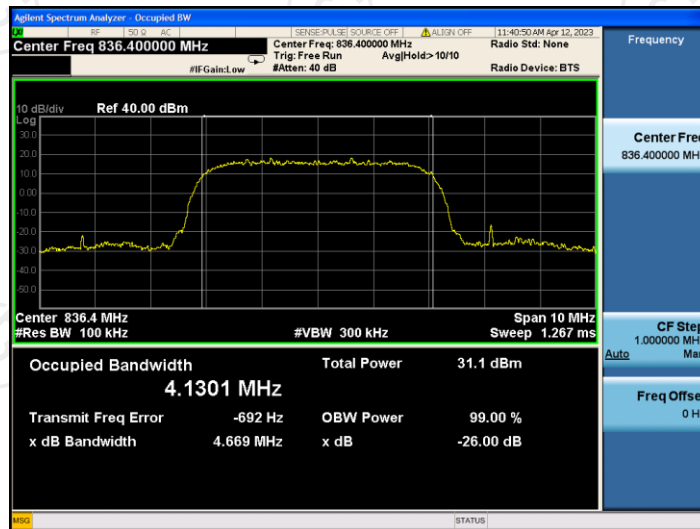

26dB&99% Occupied Bandwidth Plot on Channel 4233

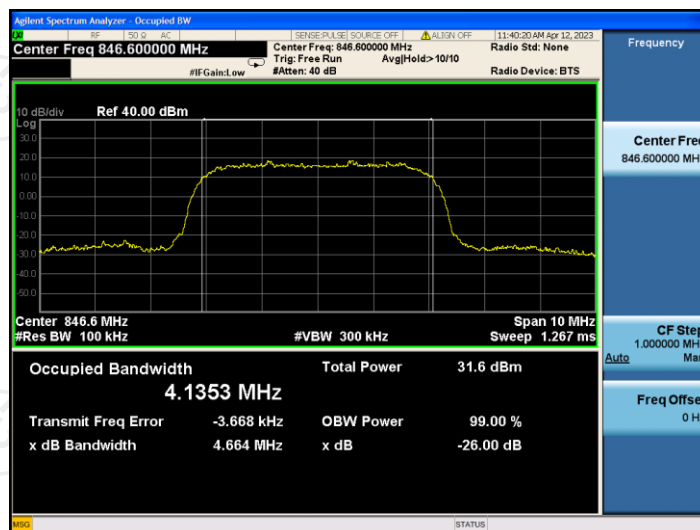

Band:	WCDMA Band II	Test Mode:	RMC 12.2Kbps Link (QPSK)
-------	---------------	------------	--------------------------

26dB&99% Occupied Bandwidth Plot on Channel 9262

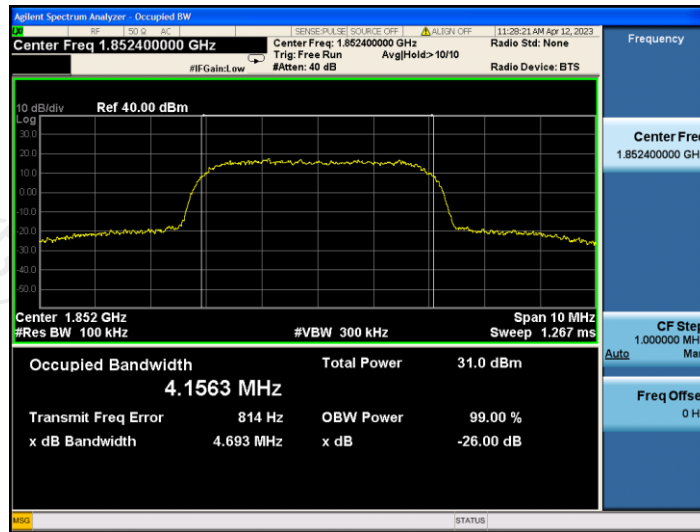

26dB&99% Occupied Bandwidth Plot on Channel 9400

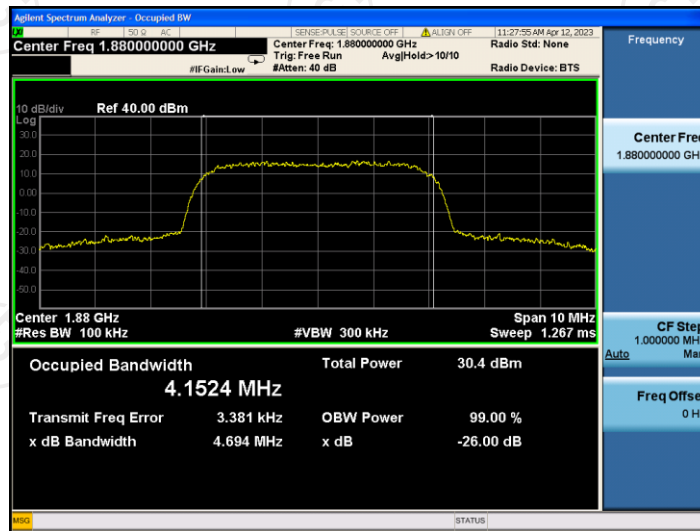

26dB&99% Occupied Bandwidth Plot on Channel 9538

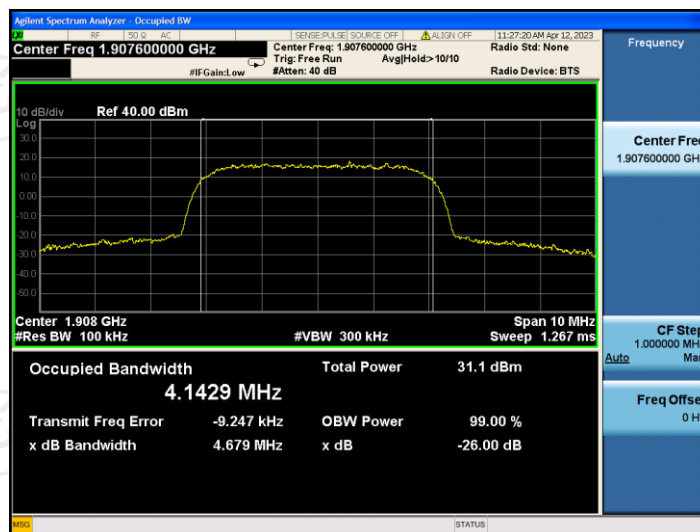

5.4. Band Edge and Conducted Spurious Emission Measurement

5.4.1. Test Specification

Test Requirement:	FCC part22.917(a) and FCC part24.238(a)
Test Method:	FCC KDB 971168 D01v03r01
Operation mode:	Refer to item 3.1
Limit:	-13dBm
Test Setup:	
Test Procedure:	<ol style="list-style-type: none"> 1. The testing follows FCC KDB 971168 D01v03r01 Section 6.0. 2. The EUT was connected to the spectrum analyzer and system simulator via a power divider. 3. The RF output of EUT was connected to the spectrum analyzer by an RF cable and attenuator. The path loss was compensated to the results for each measurement. 4. The band edges of low and high channels for the highest RF powers were measured. 5. The conducted spurious emission for the whole frequency range was taken. 6. The RF fundamental frequency should be excluded against the limit line in the operating frequency band. 7. The limit line is derived from $43 + 10\log(P)$ dB below the transmitter power $P(\text{Watts}) = P(\text{W}) - [43 + 10\log(P)] (\text{dB}) = [30 + 10\log(P)] (\text{dBm}) - [43 + 10\log(P)] (\text{dB}) = -13\text{dBm}$.
Test Result:	PASS

5.4.2. Test Instruments

Equipment	Manufacturer	Model	Serial Number	Calibration Due
System simulator	R&S	CMU200	110188	Jul. 04, 2023
Spectrum Analyzer	Agilent	N9020A	MY49100619	Jul. 04, 2023
Combiner Box	Ascentest	AT890-RFB	/	/

5.4.3. Test data

Test plots as follows:

Band:	GSM 850	Test Mode:	GSM Link (GMSK)
-------	---------	------------	-----------------

Lower Band Edge Plot on Channel 128

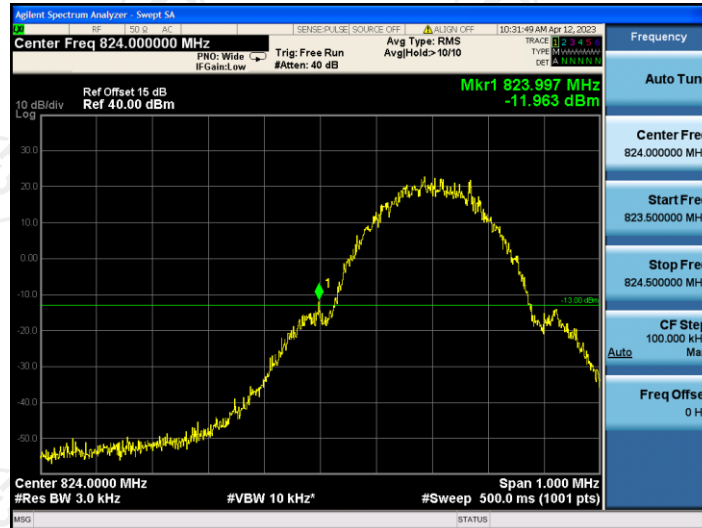

Higher Band Edge Plot on Channel 251

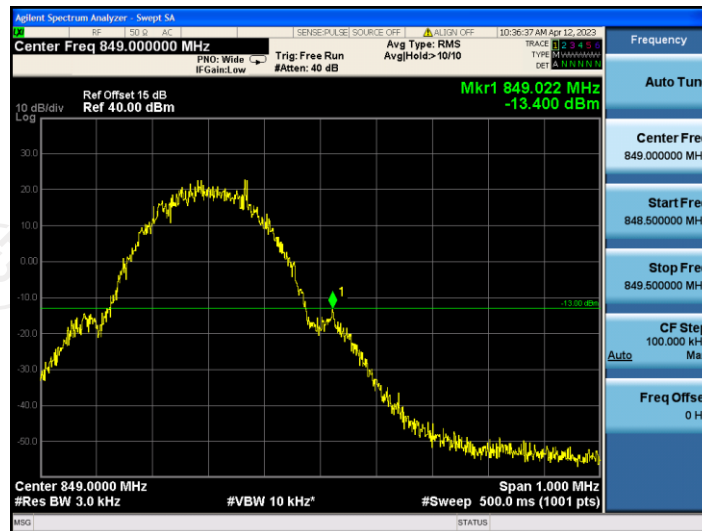

Band:	GSM 1900	Test Mode:	GSM Link (GMSK)
-------	----------	------------	-----------------

Lower Band Edge Plot on Channel 512

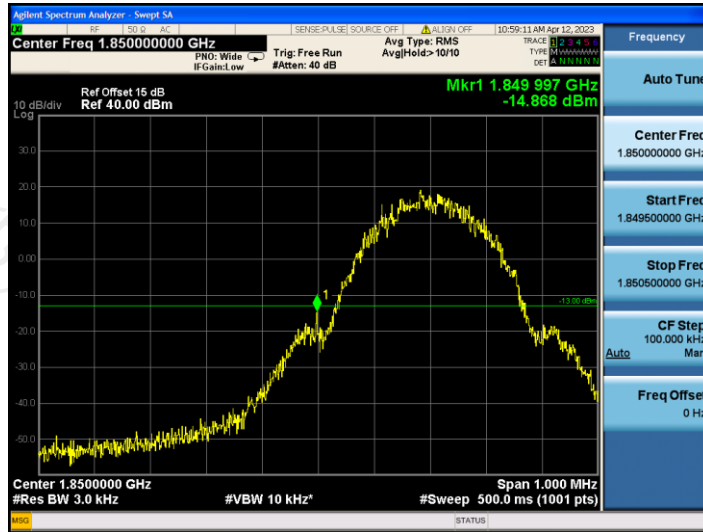

Higher Band Edge Plot on Channel 810

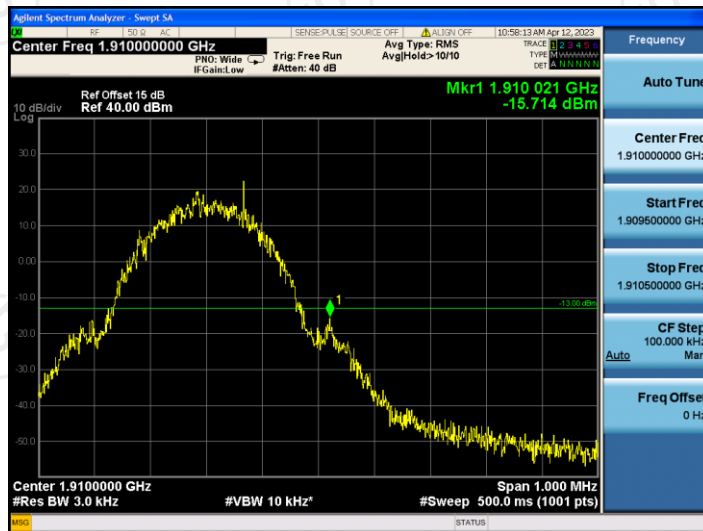

Band:	WCDMA Band V	Test Mode:	RMC 12.2Kbps Link (QPSK)
-------	--------------	------------	--------------------------

Lower Band Edge Plot on Channel 4132

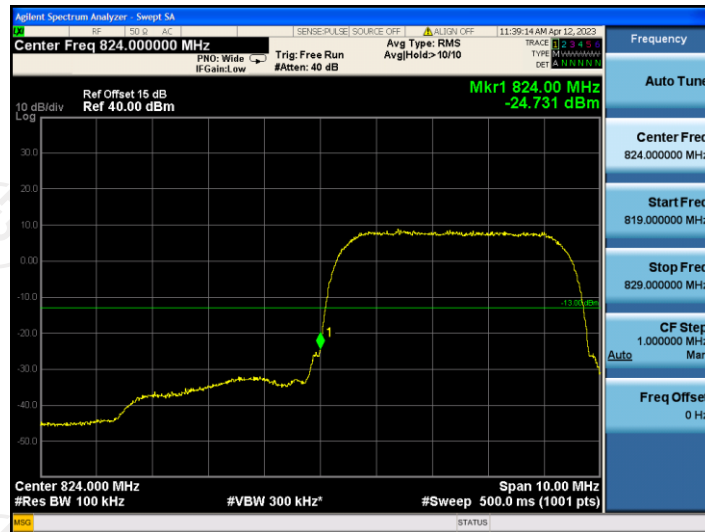

Higher Band Edge Plot on Channel 4233

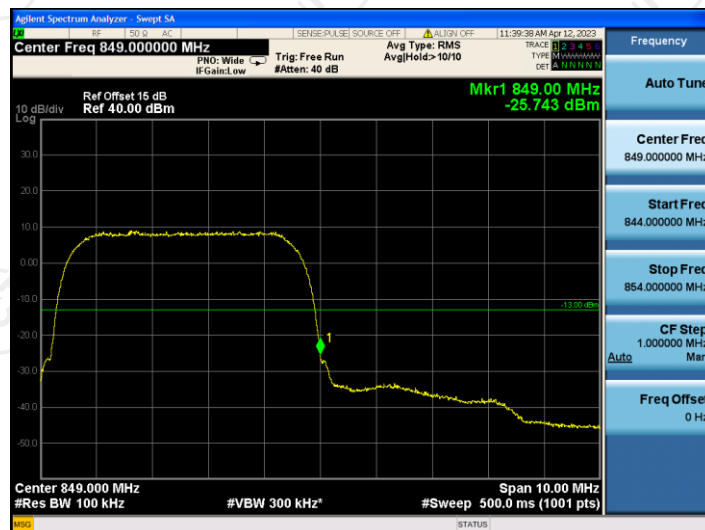

Band:	WCDMA Band II	Test Mode:	RMC 12.2Kbps Link (QPSK)
-------	---------------	------------	--------------------------

Lower Band Edge Plot on Channel 9262

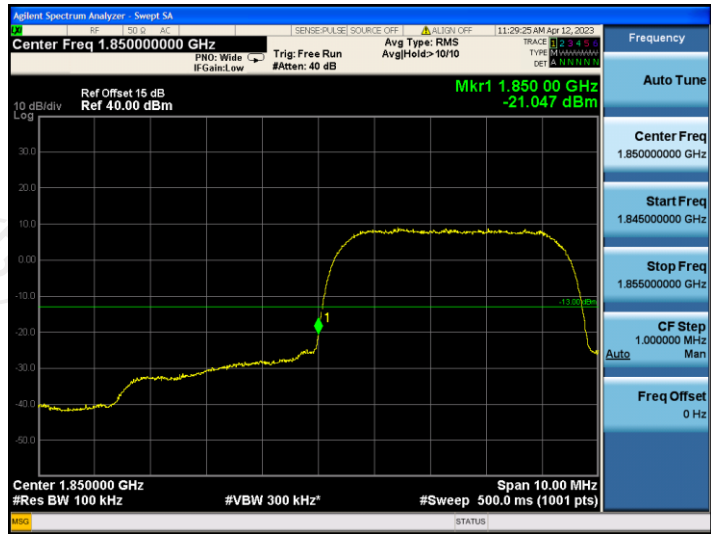

Higher Band Edge Plot on Channel 9538



Band: GSM 850 Test Mode: GSM Link (GMSK)

Conducted Spurious Emission on Channel 128

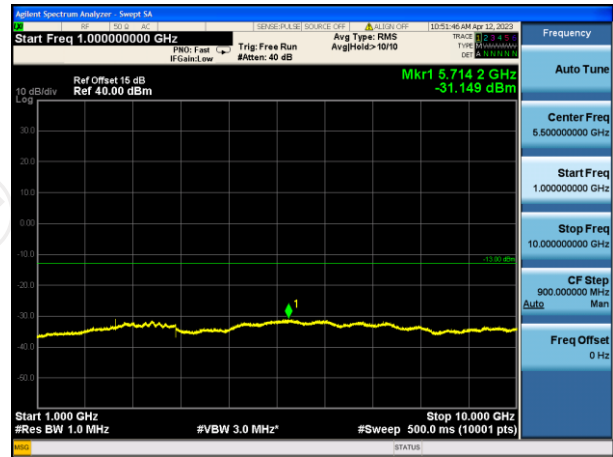
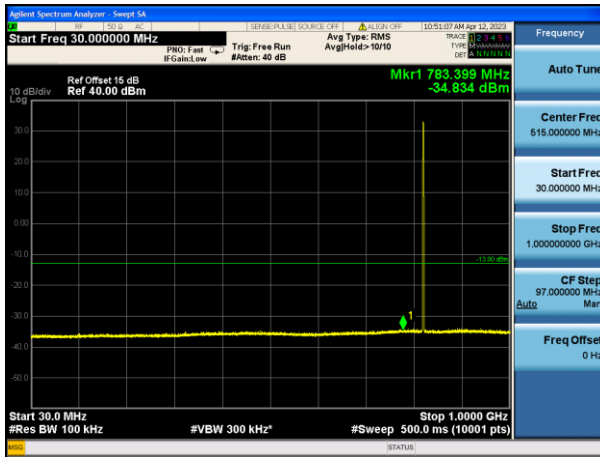

Conducted Spurious Emission on Channel 190

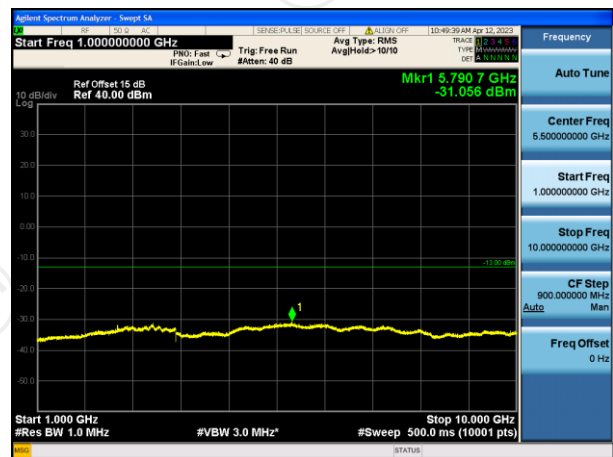
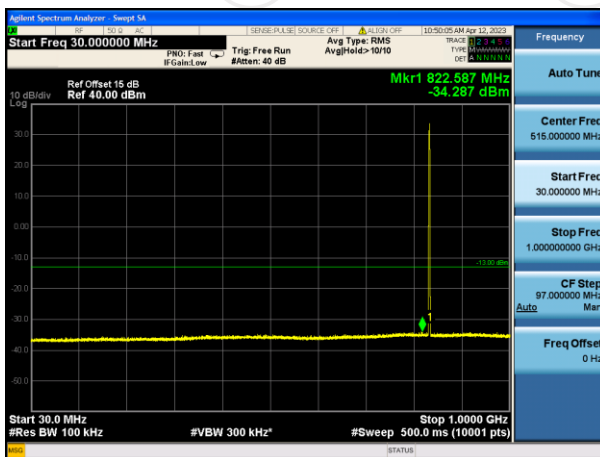

Conducted Spurious Emission on Channel 251

