



**In accordance with the requirements of
FCC 47 CFR Part 2(2.1093), ANSI/IEEE C95.1-1992 and
IEEE Std 1528-2013**

FCC SAR EVALUATION REPORT

Product Name : Mobile phone

Trademark : GOL

Model Name : M6

Serial Model : M1, S4

Report No. : NTEK-2015NT09242741HF

FCC ID : 2AEJAGOLM6

Prepared for

GSM GLOBE.COM INC

134 N.E 1 Street, Miami FL 33132, USA

Prepared by

Shenzhen NTEK Testing Technology Co., Ltd.

1/F, Building E, Fenda Science Park, Sanwei Community, Xixiang Street

Bao'an District, Shenzhen P.R. China

Tel.: +86-0755-61156588 Fax.: +86-0755-61156599

Website: www.ntek.org.cn

TEST RESULT CERTIFICATION

Applicant's name..... GSM GLOBE.COM INC
Address 134 N.E 1 Street, Miami FL 33132, USA
Manufacturer's Name GSM GLOBE.COM INC
Address 134 N.E 1 Street, Miami FL 33132, USA

Product description

Product name..... Mobile phone
Trademark GOL
Model and/or type reference M6
Serial Model M1, S4

Standards..... FCC 47 CFR Part 2(2.1093)
ANSI/IEEE C95.1-1992
IEEE Std 1528-2013
Published RF exposure KDB procedures

This device described above has been tested by Shenzhen NTEK. In accordance with the measurement methods and procedures specified in IEEE Std 1528-2013 and KDB 865664 D01. Testing has shown that this device is capable of compliance with localized specific absorption rate (SAR) specified in FCC 47 CFR Part 2(2.1093) and ANSI/IEEE C95.1-1992. The test results in this report apply only to the tested sample of the stated device/equipment. Other similar device/equipment will not necessarily produce the same results due to production tolerance and measurement uncertainties.

This report shall not be reproduced except in full, without the written approval of Shenzhen NTEK, this document may be altered or revised by Shenzhen NTEK, personal only, and shall be noted in the revision of the document.

Date of Test

Date (s) of performance of tests..... Sep 23, 2015 ~ Oct 13, 2015
Date of Issue Oct 21, 2015
Test Result **Pass**

Testing Engineer : Cheng Jiawen
(Cheng Jiawen)

Technical Manager : Brown Lu
(Brown Lu)

Authorized Signatory : Sam. Chen
(Sam Chen)

※ ※ Revision History ※ ※

REV.	DESCRIPTION	ISSUED DATE	REMARK
Rev.1.0	Initial Test Report Release	Oct 21, 2015	Cheng Jiawen

TABLE OF CONTENTS

1. General Information	6
1.1. RF exposure limits.....	6
1.2. Statement of Compliance	7
1.3. EUT Description	8
1.4. Test specification(s)	9
1.5. Ambient Condition.....	9
2. SAR Measurement System	10
2.1. SATIMO SAR Measurement Set-up Diagram	10
2.2. Robot	11
2.3. E-Field Probe.....	12
2.3.1. E-Field Probe Calibration	12
2.4. SAM phantoms	13
2.4.1. Technical Data	13
2.5. Device Holder	15
2.6. Test Equipment List	16
3. SAR Measurement Procedures	18
3.1. Power Reference	18
3.2. Area scan & Zoom scan.....	18
3.3. Description of interpolation/extrapolation scheme	20
3.4. Volumetric Scan	20
3.5. Power Drift	20
4. System Verification Procedure	21
4.1. Tissue Verification	21
4.1.1. Tissue Dielectric Parameter Check Results	21
4.2. System Verification Procedure	23
4.2.1. System Verification Results	24
5. SAR Measurement variability and uncertainty	25
5.1. SAR measurement variability	25
5.2. SAR measurement uncertainty	25
6. Uncertainty for system performance check	26
7. RF Exposure Positions	27
7.1. Ear and handset reference point	27
7.2. Definition of the cheek position	27
6.3. Definition of the tilt position	29
6.4. Body Worn Accessory	29
8. Conducted RF Output Power	31
8.1. Maximum Tune-up Limit.....	31
8.2. GSM Conducted Power	31
8.3. BT Output Power.....	33

8.3.1. Output Power Results Of BT.....	33
9. Antenna Location.....	34
10. Stand-alone SAR test exclusion	35
11. SAR Measurement Results.....	36
11.1. SAR measurement results	36
11.1.1. SAR measurement Result of GSM850	37
11.1.2. SAR measurement Result of GSM1900.....	38
12. Appendix A. Photo documentation	39
13. Appendix B. System Check Plots.....	44
14. Appendix C. SAR Measurement Plots	49
15. Appendix D. Calibration Certificate	54

1. General Information

1.1. RF exposure limits

(A).Limits for Occupational/Controlled Exposure (W/kg)

Whole-Body	Partial-Body	Hands, Wrists, Feet and Ankles
0.4	8.0	20.0

(B).Limits for General Population/Uncontrolled Exposure (W/kg)

Whole-Body	Partial-Body	Hands, Wrists, Feet and Ankles
0.08	1.6	4.0

NOTE: **Whole-Body SAR** is averaged over the entire body, **partial-body SAR** is averaged over any 1 gram of tissue defined as a tissue volume in the shape of a cube. **SAR for hands, wrists, feet and ankles** is averaged over any 10 grams of tissue defined as a tissue volume in the shape of a cube.

Occupational/Controlled Environments:

Are defined as locations where there is exposure that may be incurred by people who are aware of the potential for exposure, (i.e. as a result of employment or occupation).

General Population/Uncontrolled Environments:

Are defined as locations where there is the exposure of individuals who have no knowledge or control of their exposure.

NOTE
 HEAD AND TRUNK LIMIT
 1.6 W/kg
 APPLIED TO THIS EUT

1.2. Statement of Compliance

The maximum results of Specific Absorption Rate (SAR) found during testing for M6 are as follows.

Band	Max Reported SAR(W/kg)	
	1-g Head	1-g Body-worn(5mm)
GSM 850	0.532	1.195
GSM 1900	1.053	1.187

This device is in compliance with Specific Absorption Rate (SAR) for general population/uncontrolled exposure limits (1.6 W/kg) specified in FCC 47 CFR Part 2(2.1093) and ANSI/IEEE C95.1-1992, and had been tested in accordance with the measurement methods and procedures specified in EN IEEE Std 1528-2013 & KDB 865664 D01.

1.3. EUT Description

Device Information			
Product Name	Mobile phone		
Trade Name	GOL		
Model Name	M6		
Serial Model	M1, S4		
FCC ID	2AEJAGOLM6		
Device Phase	Identical Prototype		
Exposure Category	General population / Uncontrolled environment		
Hardware Version	XZ56_MB_PCB_REV1.1		
Software Version	MOCOR_12C.W13.04.14_Release		
IMEI	SIM 1: 359154069035352 SIM 2: 359154069035360		
SIM Card	The Phone has dual SIM Card sockets but only one of the dual SIM Card can be transmitting when the two SIM Cards are inserting the phone together		
Model Difference	All the model are the same circuit and RF module, except the model name and colour.		
Device Operating Configurations			
Supporting Mode(s)	Quad-band TX (GSM850/EGSM900/DCS1800/PCS1900) / dual-band RX GSM/GPRS. SIM 1: GSM 850/900/1800/1900 SIM 2: GSM 850/900/1800/1900 BT V2.0+EDR		
Modulation Type	GSM(GMSK), BT(GFSK/ π /4-DQPSK/8-DPSK)		
Hotspot Mode	NO		
Device Class	B		
Operating Frequency Range(s)	Band	Tx (MHz)	Rx (MHz)
	GSM 850	824-849	869-894
	GSM 1900	1850-1910	1930-1990
	BT	2402-2480	
GPRS Multislot Class(12)	Max Number of Timeslots in Uplink		4
	Max Number of Timeslots in Downlink		4
	Max Total Timeslot		5
Power Class	4, tested with power level 5(GSM 850)		
	1, tested with power level 0(GSM 1900)		
Test Channels (low-mid-high)	128-189-251(GSM 850)		
	512-661-810(GSM 1900)		

1.4. Test specification(s)

FCC 47 CFR Part 2(2.1093)
ANSI/IEEE C95.1-1992
IEEE Std 1528-2013
KDB 865664 D01 SAR measurement 100 MHz to 6 GHz v01r04
KDB 865664 D02 RF Exposure Reporting v01r01
KDB 447498 D01 General RF Exposure Guidance v05r02
KDB 648474 D04 Handset SAR v01r02

1.5. Ambient Condition

Ambient temperature	20°C – 24°C
Relative Humidity	30% – 70%

2. SAR Measurement System

2.1. SATIMO SAR Measurement Set-up Diagram

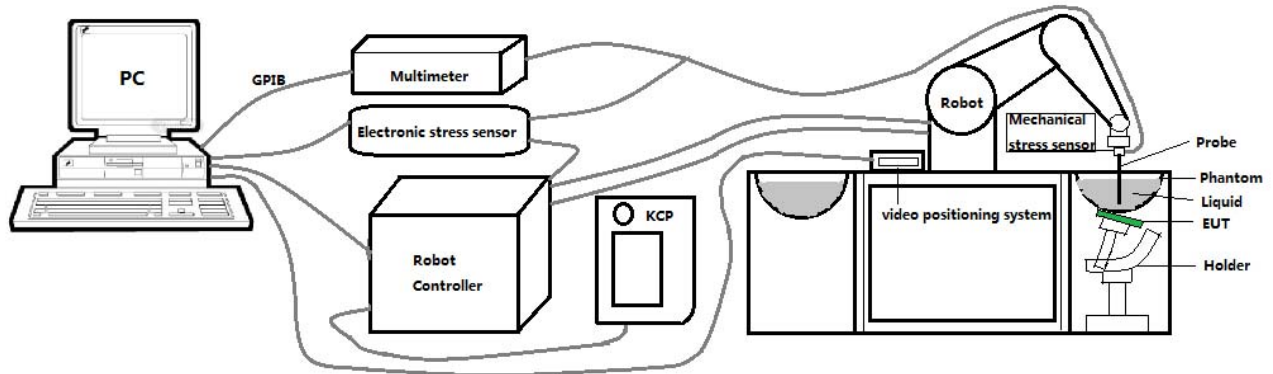

These measurements were performed with the automated near-field scanning system OPENSAR from SATIMO. The system is based on a high precision robot (working range: 901 mm), which positions the probes with a positional repeatability of better than ± 0.03 mm. The SAR measurements were conducted with dosimetric probe (manufactured by SATIMO), designed in the classical triangular configuration and optimized for dosimetric evaluation.

The first step of the field measurement is the evaluation of the voltages induced on the probe by the device under test. Probe diode detectors are nonlinear. Below the diode compression point, the output voltage is proportional to the square of the applied E-field; above the diode compression point, it is linear to the applied E-field. The compression point depends on the diode, and a calibration procedure is necessary for each sensor of the probe.

The Keithley multimeter reads the voltage of each sensor and send these three values to the PC. The corresponding E field value is calculated using the probe calibration factors, which are stored in the working directory. This evaluation includes linearization of the diode characteristics. The field calculation is done separately for each sensor. Each component of the E field is displayed on the "Dipole Area Scan Interface" and the total E field is displayed on the "3D Interface"

2.2. Robot

The SATIMO SAR system uses the high precision robots from KUKA. For the 6-axis controller system, the robot controller version (KUKA) from KUKA is used. The KUKA robot series have many features that are important for our application:



- High precision (repeatability ± 0.03 mm)
- High reliability (industrial design)
- Jerk-free straight movements
- Low ELF interference (the closed metallic construction shields against motor control fields)

2.3. E-Field Probe



This E-field detection probe is composed of three orthogonal dipoles linked to special Schottky diodes with low detection thresholds. The probe allows the measurement of electric fields in liquids such as the one defined in the IEEE and CENELEC standards.

For the measurements the Specific Dosimetric E-Field Probe SN 07/15 EP 247 with following specifications is used

- Dynamic range: 0.01-100 W/kg
- Tip Diameter : 5 mm
- Distance between probe tip and sensor center: 2.7 mm
- Distance between sensor center and the inner phantom surface: 4 mm (repeatability better than ± 1 mm).
- Probe linearity: ± 0.05 dB
- Axial isotropy: < 0.25 dB
- Hemispherical Isotropy: < 0.50 dB
- Calibration range: 450MHz to 2600MHz for head & body simulating liquid.
- Lower detection limit: 8mW/kg

Angle between probe axis (evaluation axis) and surface normal line: less than 30° .

2.3.1. E-Field Probe Calibration

Each probe needs to be calibrated according to a dosimetric assessment procedure with accuracy better than $\pm 10\%$. The spherical isotropy shall be evaluated and within ± 0.25 dB. The sensitivity parameters (Norm X, Norm Y, and Norm Z), the diode compression parameter (DCP) and the conversion factor (Conv F) of the probe are tested. The calibration data can be referred to appendix D of this report.

2.4. SAM phantoms

Photo of SAM phantom SN 16/15 SAM119



The SAM phantom is used to measure the SAR relative to people exposed to electro-magnetic field radiated by mobile phones.

2.4.1. Technical Data

Serial Number	Shell thickness	Filling volume	Dimensions	Positionner Material	Permittivity	Loss Tangent
SN 16/15 SAM119	2 mm \pm 0.2 mm	27 liters	Length:1000 mm Width:500 mm Height:200 mm	Gelcoat with fiberglass	3.4	0.02

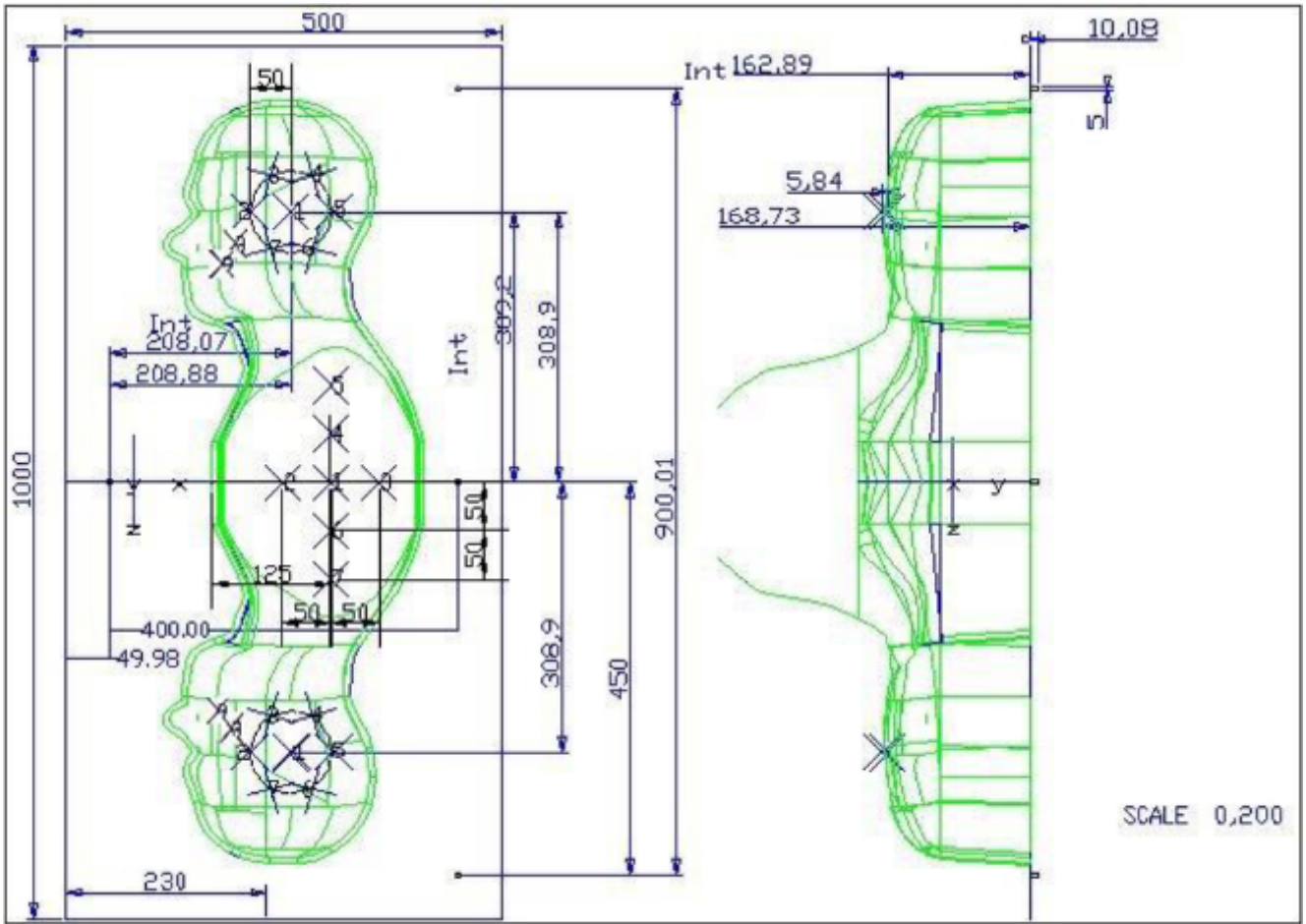

Serial Number	Left Head		Right Head		Flat Part	
SN 16/15 SAM119	2	2.02	2	2.08	1	2.09
	3	2.05	3	2.06	2	2.06
	4	2.07	4	2.07	3	2.08
	5	2.08	5	2.08	4	2.10
	6	2.05	6	2.07	5	2.10
	7	2.05	7	2.05	6	2.07
	8	2.07	8	2.06	7	2.07
	9	2.08	9	2.06	-	-

The test, based on ultrasonic system, allows measuring the thickness with an accuracy of 10 µm.

2.5. Device Holder

The positioning system allows obtaining cheek and tilting position with a very good accuracy. In compliance with CENELEC, the tilt angle uncertainty is lower than 1 degree.

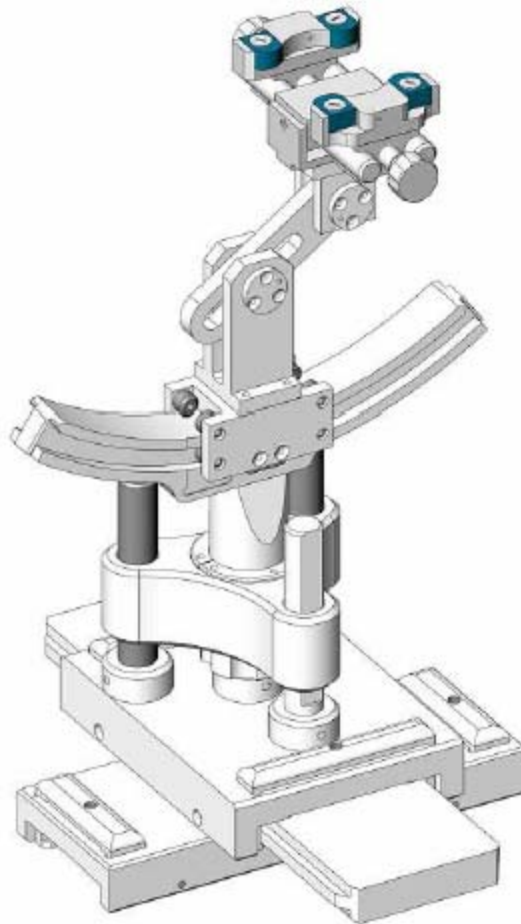

Serial Number	Holder Material	Permittivity	Loss Tangent
SN 16/15 MSH100	Delrin	3.7	0.005

2.6. Test Equipment List

This table gives a complete overview of the SAR measurement equipment.

Devices used during the test described are marked

	Manufacturer	Name of Equipment	Type/Model	Serial Number	Calibration	
					Last Cal.	Due Date
<input checked="" type="checkbox"/>	SATIMO	E FIELD PROBE	SSE5	SN 07/15 EP247	Apr 06, 2015	Apr 05, 2016
<input type="checkbox"/>	SATIMO	450 MHz Dipole	SID450	SN 03/15 DIP 0G450-345	Apr 06, 2015	Apr 05, 2016
<input type="checkbox"/>	SATIMO	750 MHz Dipole	SID750	SN 03/15 DIP 0G750-355	Apr 06, 2015	Apr 05, 2016
<input checked="" type="checkbox"/>	SATIMO	835 MHz Dipole	SID835	SN 03/15 DIP 0G835-347	Apr 06, 2015	Apr 05, 2016
<input type="checkbox"/>	SATIMO	900 MHz Dipole	SID900	SN 03/15 DIP 0G900-348	Apr 06, 2015	Apr 05, 2016
<input type="checkbox"/>	SATIMO	1800 MHz Dipole	SID1800	SN 03/15 DIP 1G800-349	Apr 06, 2015	Apr 05, 2016
<input checked="" type="checkbox"/>	SATIMO	1900 MHz Dipole	SID1900	SN 03/15 DIP 1G900-350	Apr 06, 2015	Apr 05, 2016
<input type="checkbox"/>	SATIMO	2000 MHz Dipole	SID2000	SN 03/15 DIP 2G000-351	Apr 06, 2015	Apr 05, 2016
<input type="checkbox"/>	SATIMO	2450 MHz Dipole	SID2450	SN 03/15 DIP 2G450-352	Apr 06, 2015	Apr 05, 2016
<input type="checkbox"/>	SATIMO	2600 MHz Dipole	SID2600	SN 03/15 DIP 2G600-356	Apr 06, 2015	Apr 05, 2016
<input type="checkbox"/>	SATIMO	5000 MHz Dipole	SWG5500	SN 13/14 WGA 33	Apr 06, 2015	Apr 05, 2016
<input checked="" type="checkbox"/>	SATIMO	Liquid measurement Kit	SCLMP	SN 21/15 OCPG 72	May 08, 2015	May 07, 2016
<input checked="" type="checkbox"/>	SATIMO	Power Amplifier	N.A	AMPLISAR_28/14_003	N.A	N.A
<input checked="" type="checkbox"/>	KEITHLEY	Millivoltmeter	2000	4072790	Jan 05, 2015	Jan 04, 2016
<input checked="" type="checkbox"/>	R&S	Universal radio communication tester	CMU200	117858	Aug 08, 2015	Aug 07, 2016
<input checked="" type="checkbox"/>	Agilent	Network Analyzer	8753D	3410J01136	Aug 08, 2015	Aug 07, 2016
<input checked="" type="checkbox"/>	Agilent	PSG Analog Signal Generator	E8257D	MY51110112	Aug 08, 2015	Aug 07, 2016

<input checked="" type="checkbox"/>	Agilent	Power meter	E4419B	MY45102538	Jul 31, 2015	Jul 30, 2016
<input checked="" type="checkbox"/>	Agilent	Power sensor	E9301A	MY41495644	Jul 31, 2015	Jul 30, 2016
<input checked="" type="checkbox"/>	Agilent	Power sensor	E9301A	US39212148	Jul 31, 2015	Jul 30, 2016
<input checked="" type="checkbox"/>	MCLI/USA	Directional Coupler	CB11-20	0D2L51502	Aug 13, 2015	Aug 12, 2016

3. SAR Measurement Procedures

The measurement procedures are as follows:

<Conducted power measurement>

- (a) For WWAN power measurement, use base station simulator to configure EUT WWAN transmission in conducted connection with RF cable, at maximum power in each supported wireless interface and frequency band.
- (b) Read the WWAN RF power level from the base station simulator.
- (c) For WiFi/BT power measurement, use engineering software to configure EUT WiFi/BT continuously transmission, at maximum RF power in each supported wireless interface and frequency band.
- (d) Connect EUT RF port through RF cable to the power meter, and measure WiFi/BT output power.

<SAR measurement>

- (a) Use base station simulator to configure EUT WWAN transmission in radiated connection, and engineering software to configure EUT WiFi/BT continuously transmission, at maximum RF power, in the highest power channel.
- (b) Place the EUT in the positions as Appendix A demonstrates.
- (c) Set scan area, grid size and other setting on the OPENSAR software.
- (d) Measure SAR results for the highest power channel on each testing position.
- (e) Find out the largest SAR result on these testing positions of each band.
- (f) Measure SAR results for other channels in worst SAR testing position if the reported SAR of highest power channel is larger than 0.8 W/kg.

According to the test standard, the recommended procedure for assessing the peak spatial-average SAR value consists of the following steps:

- (a) Power reference measurement
- (b) Area scan
- (c) Zoom scan
- (d) Power drift measurement

3.1. Power Reference

The Power Reference Measurement and Power Drift Measurements are for monitoring the power drift of the device under test in the batch process. The minimum distance of probe sensors to surface determines the closest measurement point to phantom surface. This distance cannot be smaller than the distance of sensor calibration points to probe tip as defined in the probe properties.

3.2. Area scan & Zoom scan

The area scan is a 2D scan to find the hot spot location on the DUT. The zoom scan is a 3D scan above the hot spot to calculate the 1g and 10g SAR value.

Measurement of the SAR distribution with a grid of 8 to 16 mm * 8 to 16 mm and a constant distance to

the inner surface of the phantom. Since the sensors cannot directly measure at the inner phantom surface, the values between the sensors and the inner phantom surface are extrapolated. With these values the area of the maximum SAR is calculated by an interpolation scheme. Around this point, a cube of 30 * 30 * 30 mm or 32 * 32 * 32 mm is assessed by measuring 5 or 8 * 5 or 8 * 4 or 5 mm. With these data, the peak spatial-average SAR value can be calculated.

From the scanned SAR distribution, identify the position of the maximum SAR value, in addition identify the positions of any local maxima with SAR values within 2 dB of the maximum value that will not be within the zoom scan of other peaks; additional peaks shall be measured only when the primary peak is within 2 dB of the SAR compliance limit (e.g., 1 W/kg for 1,6 W/kg 1 g limit, or 1,26 W/kg for 2 W/kg, 10 g limit).

Area scan & Zoom scan scan parameters extracted from FCC KDB 865664 D01 SAR measurement 100 MHz to 6 GHz.

		≤ 3 GHz	> 3 GHz
Maximum distance from closest measurement point (geometric center of probe sensors) to phantom surface		5 ± 1 mm	$\frac{1}{2} \cdot \delta \cdot \ln(2) \pm 0.5$ mm
Maximum probe angle from probe axis to phantom surface normal at the measurement location		30° ± 1°	20° ± 1°
Maximum area scan spatial resolution: Δx_{Area} , Δy_{Area}		≤ 2 GHz: ≤ 15 mm 2 – 3 GHz: ≤ 12 mm	3 – 4 GHz: ≤ 12 mm 4 – 6 GHz: ≤ 10 mm
		When the x or y dimension of the test device, in the measurement plane orientation, is smaller than the above, the measurement resolution must be ≤ the corresponding x or y dimension of the test device with at least one measurement point on the test device.	
Maximum zoom scan spatial resolution: Δx_{Zoom} , Δy_{Zoom}		≤ 2 GHz: ≤ 8 mm 2 – 3 GHz: ≤ 5 mm*	3 – 4 GHz: ≤ 5 mm* 4 – 6 GHz: ≤ 4 mm*
Maximum zoom scan spatial resolution, normal to phantom surface	uniform grid: $\Delta z_{Zoom}(n)$	≤ 5 mm	3 – 4 GHz: ≤ 4 mm 4 – 5 GHz: ≤ 3 mm 5 – 6 GHz: ≤ 2 mm
	graded grid	$\Delta z_{Zoom}(1)$: between 1 st two points closest to phantom surface	≤ 4 mm 3 – 4 GHz: ≤ 3 mm 4 – 5 GHz: ≤ 2.5 mm 5 – 6 GHz: ≤ 2 mm
		$\Delta z_{Zoom}(n>1)$: between subsequent points	≤ 1.5 · $\Delta z_{Zoom}(n-1)$
Minimum zoom scan volume	x, y, z	≥ 30 mm	3 – 4 GHz: ≥ 28 mm 4 – 5 GHz: ≥ 25 mm 5 – 6 GHz: ≥ 22 mm

Note: δ is the penetration depth of a plane-wave at normal incidence to the tissue medium; see draft standard IEEE P1528-2011 for details.

* When zoom scan is required and the *reported* SAR from the *area scan based 1-g SAR estimation* procedures of KDB 447498 is ≤ 1.4 W/kg, ≤ 8 mm, ≤ 7 mm and ≤ 5 mm zoom scan resolution may be applied, respectively, for 2 GHz to 3 GHz, 3 GHz to 4 GHz and 4 GHz to 6 GHz.

3.3. Description of interpolation/extrapolation scheme

The local SAR inside the phantom is measured using small dipole sensing elements inside a probe body. The probe tip must not be in contact with the phantom surface in order to minimise measurements errors, but the highest local SAR will occur at the surface of the phantom.

An extrapolation is used to determine these highest local SAR values. The extrapolation is based on a fourth-order least-square polynomial fit of measured data. The local SAR value is then extrapolated from the liquid surface with a 1 mm step.

The measurements have to be performed over a limited time (due to the duration of the battery) so the step of measurement is high. It could vary between 5 and 8 mm. To obtain an accurate assessment of the maximum SAR averaged over 10 grams and 1 gram requires a very fine resolution in the three dimensional scanned data array.

3.4. Volumetric Scan

The volumetric scan consists to a full 3D scan over a specific area. This 3D scan is useful for multi Tx SAR measurement. Indeed, it is possible with OpenSAR to add, point by point, several volumetric scans to calculate the SAR value of the combined measurement as it is defined in the standard IEEE1528 and IEC62209.

3.5. Power Drift

All SAR testing is under the EUT install full charged battery and transmit maximum output power. In OpenSAR measurement software, the power reference measurement and power drift measurement procedures are used for monitoring the power drift of EUT during SAR test. Both these procedures measure the field at a specified reference position before and after the SAR testing. The software will calculate the field difference in V/m. If the power drifts more than $\pm 5\%$, the SAR will be retested.

4. System Verification Procedure

4.1. Tissue Verification

The following tissue formulations are provided for reference only as some of the parameters have not been thoroughly verified. The composition of ingredients may be modified accordingly to achieve the desired target tissue parameters required for routine SAR evaluation.

Ingredients (% of weight)	Head Tissue							
Frequency Band (MHz)	750	835	900	1800	1900	2000	2450	2600
Water	34.40	34.40	34.40	55.36	55.36	57.87	57.87	57.87
NaCl	0.79	0.79	0.79	0.35	0.35	0.16	0.16	0.16
1,2-Propanediol	64.81	64.81	64.81	0.00	0.00	0.00	0.00	0.00
Triton X-100	0.00	0.00	0.00	30.45	30.45	19.97	19.97	19.97
DGBE	0.00	0.00	0.00	13.84	13.84	22.00	22.00	22.00
Ingredients (% of weight)	Body Tissue							
Frequency Band (MHz)	750	835	900	1800	1900	2000	2450	2600
Water	50.30	50.30	50.30	69.91	69.91	71.88	71.88	71.88
NaCl	0.60	0.60	0.60	0.13	0.13	0.16	0.16	0.16
1,2-Propanediol	49.10	49.10	49.10	0.00	0.00	0.00	0.00	0.00
Triton X-100	0.00	0.00	0.00	9.99	9.99	19.97	19.97	19.97
DGBE	0.00	0.00	0.00	19.97	19.97	7.99	7.99	7.99

4.1.1. Tissue Dielectric Parameter Check Results

The simulating liquids should be checked at the beginning of a series of SAR measurements to determine if the dielectric parameters are within the tolerances of the specified target values. The measured conductivity and relative permittivity should be within $\pm 5\%$ of the target values.

Tissue Type	Measured Frequency (MHz)	Target Tissue		Measured Tissue		Liquid Temp.	Test Date
		$\epsilon_r (\pm 5\%)$	σ (S/m) ($\pm 5\%$)	ϵ_r	σ (S/m)		
Head 850	824.20	41.60 (39.52~43.68)	0.90 (0.85~0.94)	43.40	0.86	21.3 °C	Sep 23, 2015
	835.00	41.50 (39.43~43.57)	0.90 (0.85~0.94)	43.29	0.87		
	836.40	41.50 (39.43~43.57)	0.90 (0.85~0.94)	43.24	0.87		
	848.80	41.50 (39.43~43.57)	0.91 (0.86~0.95)	43.05	0.89		
Body 850	824.20	55.20 (52.44~57.96)	0.97 (0.92~1.01)	55.41	0.97	21.6 °C	Oct 13, 2015
	835.00	55.20 (52.44~57.96)	0.97 (0.92~1.01)	55.30	0.98		

	836.40	55.20 (52.44~57.96)	0.97 (0.92~1.01)	55.27	0.98		
	848.80	55.20 (52.44~57.96)	0.99 (0.94~1.04)	55.13	1.00		
Head 1900	1850.20	40.00 (38.00~42.00)	1.40 (1.33~1.47)	38.79	1.38	21.3 °C	Sep 23, 2015
	1880.00	40.00 (38.00~42.00)	1.40 (1.33~1.47)	38.63	1.40		
	1900.00	40.00 (38.00~42.00)	1.40 (1.33~1.47)	38.54	1.42		
	1909.80	40.00 (38.00~42.00)	1.40 (1.33~1.47)	38.46	1.43		
Body 1900	1850.20	53.30 (50.64~55.96)	1.52 (1.44~1.59)	53.11	1.48	21.4 °C	Oct 13, 2015
	1880.00	53.30 (50.64~55.96)	1.52 (1.44~1.59)	53.01	1.50		
	1900.00	53.30 (50.64~55.96)	1.52 (1.44~1.59)	52.93	1.51		
	1909.80	53.30 (50.64~55.96)	1.52 (1.44~1.59)	52.93	1.52		

NOTE: The dielectric parameters of the tissue-equivalent liquid should be measured under similar ambient conditions and within 2 °C of the conditions expected during the SAR evaluation to satisfy protocol requirements.

4.2. System Verification Procedure

The system verification is performed for verifying the accuracy of the complete measurement system and performance of the software. The dipole is connected to the signal source consisting of signal generator and amplifier via a directional coupler, N-connector cable and adaption to SMA. It is fed with a power of 100mW (below 5GHz) or 100mW (above 5GHz). To adjust this power a power meter is used. The power sensor is connected to the cable before the system verification to measure the power at this point and do adjustments at the signal generator. At the outputs of the directional coupler both return loss as well as forward power are controlled during the system verification to make sure that emitted power at the dipole is kept constant. This can also be checked by the power drift measurement after the test (result on plot).

The system verification is shown as below picture:

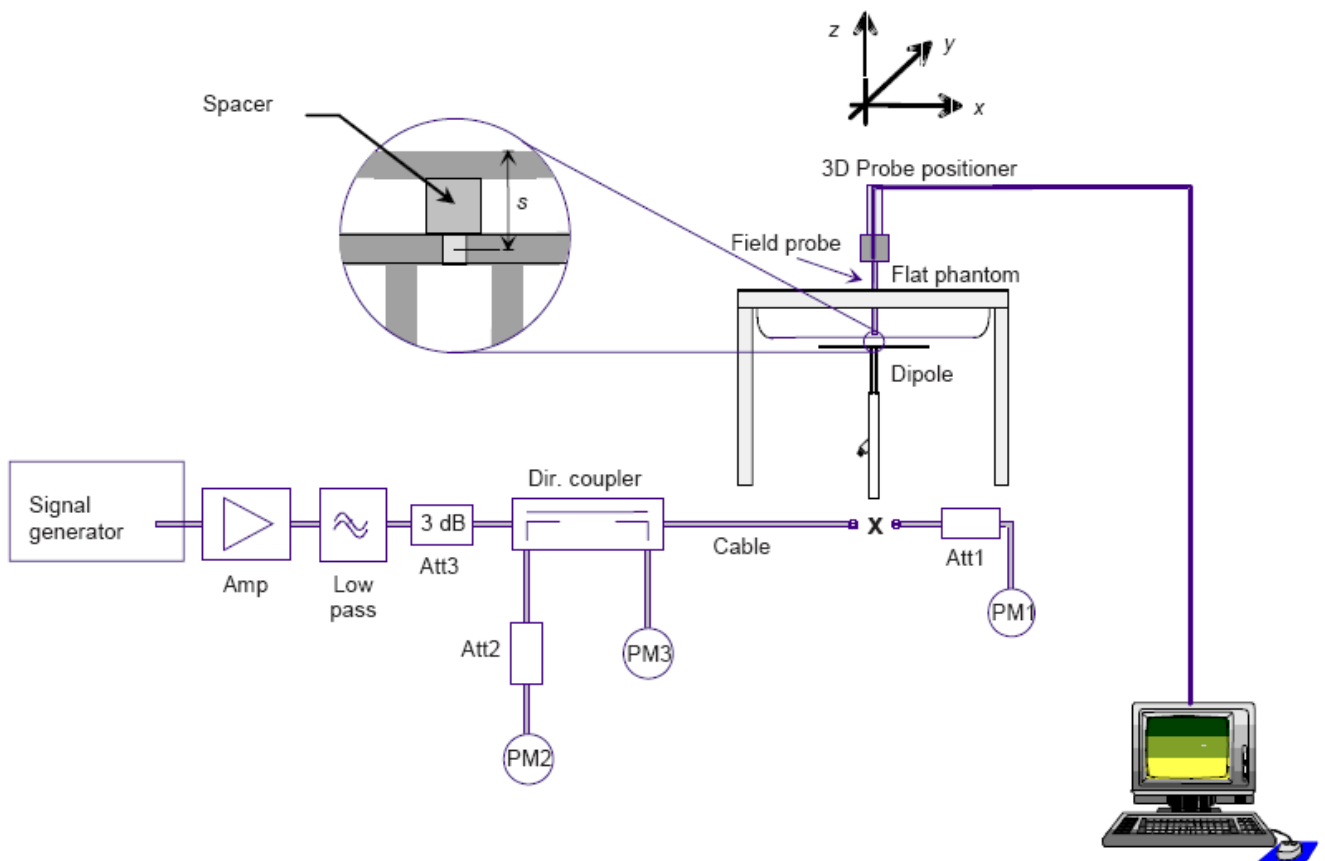

4.2.1. System Verification Results

Comparing to the original SAR value provided by SATIMO, the verification data should be within its specification of $\pm 10\%$. Below table shows the target SAR and measured SAR after normalized to 1W input power. The table below indicates the system performance verification can meet the variation criterion and the plots can be referred to Appendix B of this report.

System Verification	Target SAR (1W) ($\pm 10\%$)		Measured SAR (Normalized to 1W)		Liquid Temp.	Test Date
	1-g (W/Kg)	10-g (W/Kg)	1-g (W/Kg)	10-g (W/Kg)		
835MHz Head	9.56 (8.60~10.51)	6.22 (5.60~6.84)	9.67	6.51	21.3 °C	Sep 23, 2015
835MHz Body	9.48 (8.53~10.42)	6.29 (5.66~6.91)	9.88	6.51	21.6 °C	Oct 13, 2015
1900MHz Head	39.70 (35.73~43.67)	20.50 (18.45~22.55)	39.71	20.68	21.3 °C	Sep 23, 2015
1900MHz Body	38.43 (34.59~42.27)	20.34 (18.31~22.37)	39.62	20.81	21.4 °C	Oct 13, 2015

5. SAR Measurement variability and uncertainty

5.1. SAR measurement variability

Per KDB865664 D01 SAR measurement 100 MHz to 6 GHz, SAR measurement variability must be assessed for each frequency band, which is determined by the SAR probe calibration point and tissue-equivalent medium used for the device measurements. The additional measurements are repeated after the completion of all measurements requiring the same head or body tissue-equivalent medium in a frequency band. The test device should be returned to ambient conditions (normal room temperature) with the battery fully charged before it is re-mounted on the device holder for the repeated measurement(s) to minimize any unexpected variations in the repeated results.

- 1) Repeated measurement is not required when the original highest measured SAR is < 0.80 W/kg; steps 2) through 4) do not apply.
- 2) When the original highest measured SAR is ≥ 0.80 W/kg, repeat that measurement once.
- 3) Perform a second repeated measurement only if the ratio of largest to smallest SAR for the original and first repeated measurements is > 1.20 or when the original or repeated measurement is ≥ 1.45 W/kg (~ 10% from the 1-g SAR limit).
- 4) Perform a third repeated measurement only if the original, first or second repeated measurement is ≥ 1.5 W/kg and the ratio of largest to smallest SAR for the original, first and second repeated measurements is > 1.20 .

5.2. SAR measurement uncertainty

Per KDB865664 D01 SAR Measurement 100 MHz to 6 GHz, when the highest measured 1-g SAR within a frequency band is < 1.5 W/kg, the extensive SAR measurement uncertainty analysis described in IEEE Std 1528-2013 is not required in SAR reports submitted for equipment approval. The equivalent ratio (1.5/1.6) is applied to extremity and occupational exposure conditions.

6. Uncertainty for system performance check

Uncertainty Component	Tol. (±%)	Prob. Dist.	Div.	Ci (1 g)	Ci (10 g)	1 g Ui (±%)	10 g Ui (±%)	Vi
Measurement System								
Probe Calibration	5.8	N	1	1	1	5.80	5.80	∞
Axial Isotropy	3.5	R	√3	0.7	0.7	1.43	1.43	∞
Hemispherical Isotropy	5.9	R	√3	0.7	0.7	2.41	2.41	∞
Boundary Effect	1	R	√3	1	1	0.58	0.58	∞
Linearity	4.7	R	√3	1	1	2.71	2.71	∞
System Detection Limits	1	R	√3	1	1	0.58	0.58	∞
Modulation response	0	N	1	1	1	0.00	3.00	∞
Readout Electronics	0.5	N	1	1	1	0.50	0.50	∞
Response Time	0	R	√3	1	1	0.00	0.00	∞
Integration Time	1.4	R	√3	1	1	0.81	0.81	∞
RF Ambient Conditions – Noise	3	R	√3	1	1	1.73	1.73	∞
RF Ambient Conditions – Reflections	3	R	√3	1	1	1.73	1.73	∞
Probe Positioner Mechanical Tolerance	1.4	R	√3	1	1	0.81	0.81	∞
Probe Positioning with respect to Phantom Shell	1.4	R	√3	1	1	0.81	0.81	∞
Extrapolation, interpolation and Integration Algorithms for Max. SAR Evaluation	2.3	R	√3	1	1	1.33	1.33	∞
Dipole								
Deviation of experimental source from numerical source	4	N	1	1	1	4.00	4.00	11
Input Power and SAR drift measurement	5	R	√3	1	1	2.89	2.89	7
Dipole Axis to Liquid Distance	2	R	√3	1	1			∞
Phantom and Tissue Parameters								
Phantom Uncertainty (shape and thickness tolerances)	4	R	√3	1	1	2.31	2.31	∞
Uncertainty in SAR correction for deviation (in permittivity and conductivity)	2	N	1	1	0.84	2.00	1.68	∞
Liquid Conductivity (temperature uncertainty)	2.5	N	1	0.78	0.71	1.95	1.78	5
Liquid conductivity - measurement uncertainty	4	N	1	0.23	0.26	0.92	1.04	5
Liquid permittivity (temperature uncertainty)	2.5	N	1	0.78	0.71	1.95	1.78	∞
Liquid permittivity - measurement uncertainty	5	N	1	0.23	0.26	1.15	1.30	∞
Combined Standard Uncertainty		RSS				10.15	10.05	
Expanded Uncertainty (95% Confidence interval)		k				20.29	20.10	

7. RF Exposure Positions

7.1. Ear and handset reference point

Figure 6.1.1 shows the front, back, and side views of the SAM phantom. The center-of-mouth reference point is labeled “M”, the left ear reference point (ERP) is marked “LE”, and the right ERP is marked “RE”.



Fig 6.1.1 Front, back, and side views of SAM phantom

7.2. Definition of the cheek position

1. Define two imaginary lines on the handset, the vertical centerline and the horizontal line. The vertical centerline passes through two points on the front side of the handset: the midpoint of the width w_t of the handset at the level of the acoustic output (point A in Figure 6.2.1 and Figure 6.2.2), and the midpoint of the width w_b of the bottom of the handset (point B). The horizontal line is perpendicular to the vertical centerline and passes through the center of the acoustic output (see Figure 6.2.1). The two lines intersect at point A. Note that for many handsets, point A coincides with the center of the acoustic output; however, the acoustic output may be located elsewhere on the horizontal line. Also note that the vertical centerline is not necessarily parallel to the front face of the handset (see Figure 6.2.2), especially for clamshell handsets, handsets with flip covers, and other irregularly-shaped handsets.
2. Position the handset close to the surface of the phantom such that point A is on the (virtual) extension of the line passing through points RE and LE on the phantom (see Figure 6.2.3), such that the plane defined by the vertical centerline and the horizontal line of the handset is approximately parallel to the sagittal plane of the phantom.
3. Translate the handset towards the phantom along the line passing through RE and LE until handset point A touches the pinna at the ERP
4. While maintaining the handset in this plane, rotate it around the LE-RE line until the vertical centerline is in the plane normal to the plane containing B-M and N-F lines, i.e., the Reference Plane.
5. Rotate the handset around the vertical centerline until the handset (horizontal line) is parallel to the N-F line.

6. While maintaining the vertical centerline in the Reference Plane, keeping point A on the line passing through RE and LE, and maintaining the handset contact with the pinna, rotate the handset about the N-F line until any point on the handset is in contact with a phantom point below the pinna on the cheek. See Figure 6.2.3. The actual rotation angles should be documented in the test report.

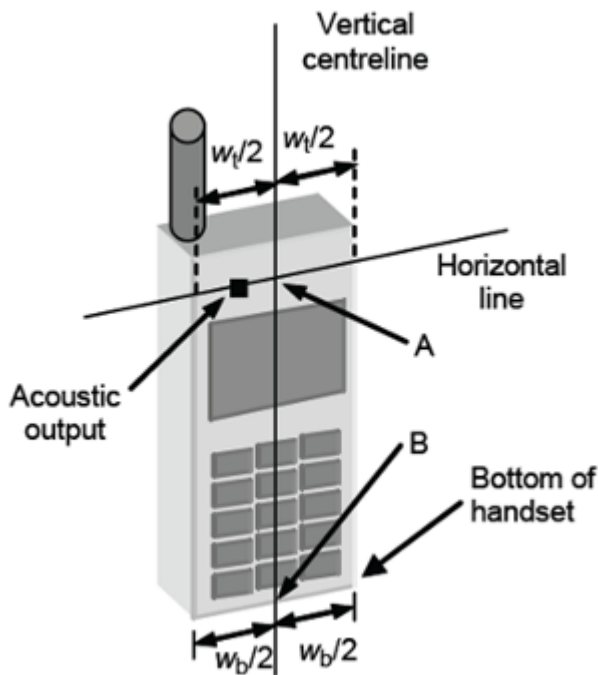

Fig 6.2.1 Handset vertical and horizontal reference lines—"fixed case"

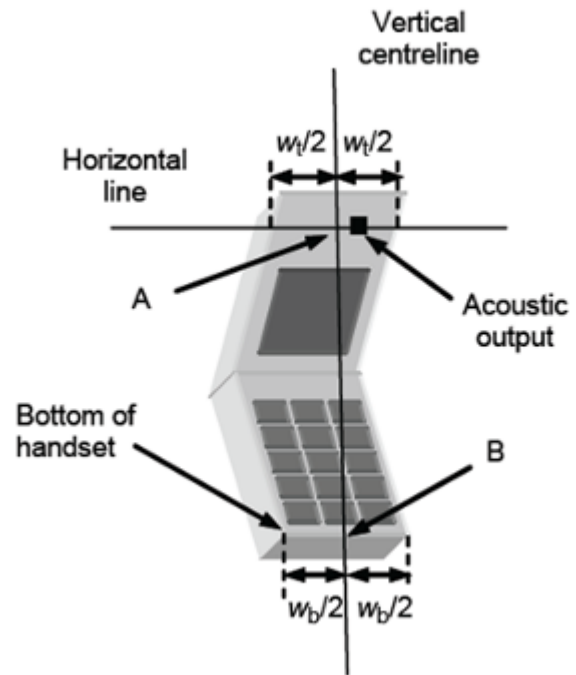

Fig 6.2.2 Handset vertical and horizontal reference lines—"clam-shell case"

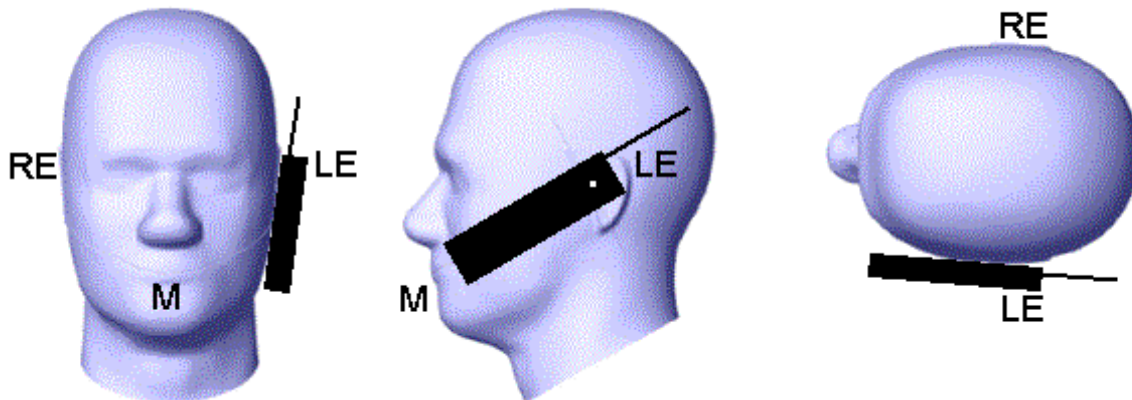

Fig 6.2.3 cheek or touch position. The reference points for the right ear (RE), left ear (LE), and mouth (M), which establish the Reference Plane for handset positioning, are indicated.

6.3. Definition of the tilt position

1. While maintaining the orientation of the handset, retract the handset parallel to the reference plane far enough away from the phantom to enable a rotation of the device by 15 degree.
2. Rotate the Handset around the horizontal line by 15 degree (see Figure 6.3.1).
3. While maintaining the orientation of the handset, move the handset towards the phantom on a line passing through RE and LE until any part of the handset touches the ear. The tilt position is obtained when the contact is on the pinna. If the contact is at any location other than the pinna, e.g., the antenna with the back of the phantom head, the angle of the handset shall be reduced. In this case, the tilt position is obtained if any part of the handset is in contact with the pinna as well as a second part of the handset is in contact with the phantom, e.g., the antenna with the back of the head.

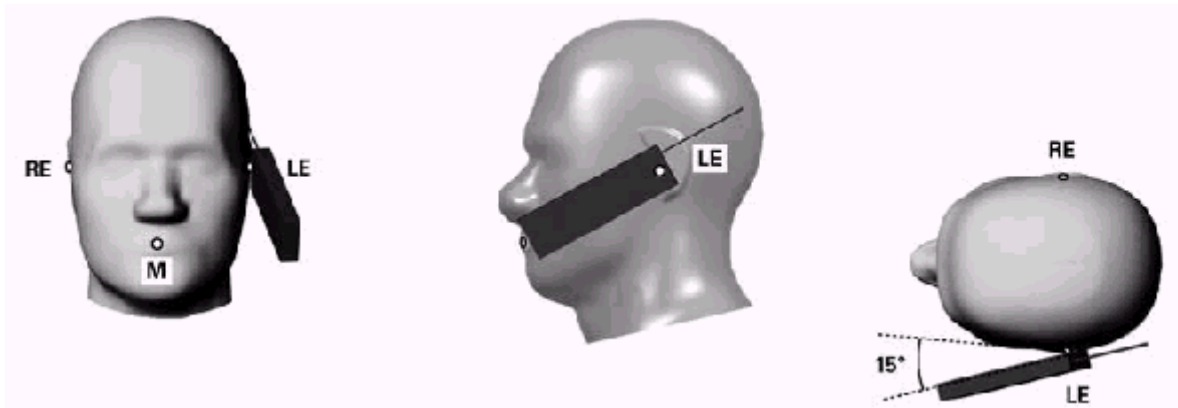

Figure 6.3.1 – Tilt position of the wireless device on the left side of SAM

6.4. Body Worn Accessory

1. Body-worn operating configurations are tested with the belt-clips and holsters attached to the device and positioned against a flat phantom in a normal LE use configuration (see Figure 6.4.1). Per KDB 648474 D04, body-worn accessory exposure is typically related to voice mode operations when handsets are carried in body-worn accessories. The body-worn accessory procedures in FCC KDB 447498 D01 should be used to test for body-worn accessory SAR compliance, without a headset connected to it. This enables the test results for such configuration to be compatible with that required for hotspot mode when the body-worn accessory test separation distance is greater than or equal to that required for hotspot mode, when applicable. When the reported SAR for body-worn accessory, measured without a headset connected to the handset is < 1.2 W/kg, the highest reported SAR configuration for that wireless mode and frequency band should be repeated for that body-worn accessory with a headset attached to the handset.
2. Accessories for body-worn operation configurations are divided into two categories: those that do not contain metallic components and those that do contain metallic components and those that do contain metallic components. When multiple accessories that do not contain metallic components are supplied with the device, the device is tested with only the accessory that dictates the closest spacing to the body. Then multiple accessories that contain metallic components are test with the

device with each accessory. If multiple accessories share an identical metallic component (i.e. the same metallic belt-chip used with different holsters with no other metallic components) only the accessory that dictates the closest spacing to the body is tested.

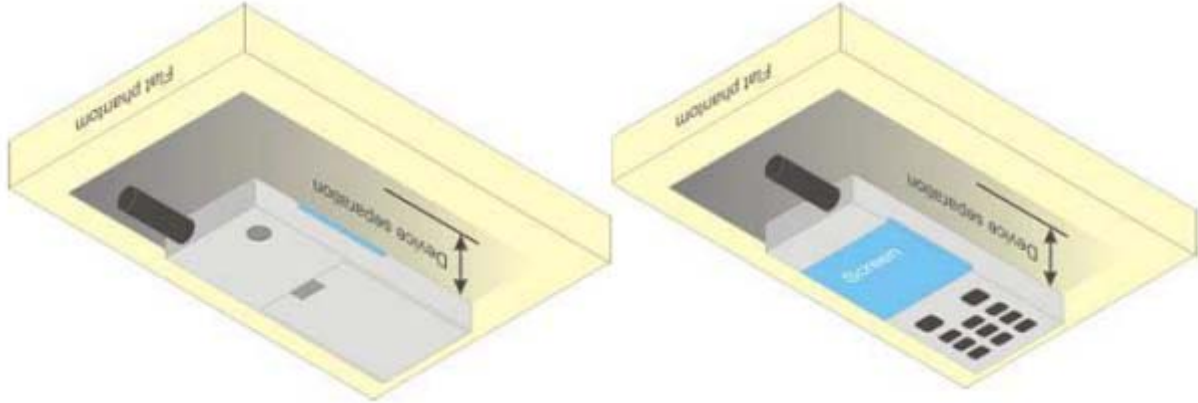

Figure 6.4.1 – Test positions for body-worn devices

8. Conducted RF Output Power

8.1. Maximum Tune-up Limit

Band	Mode	The Tune-up Maximum Power (Customer Declared)(dBm)	Range	Measured Conduct Maximum Power(dBm)
GSM 850	GSM (GMSK)	32±1	31~33	31.63
	GPRS(GMSK, 1 Tx slot)	32±1	31~33	31.61
	GPRS(GMSK, 2 Tx slot)	30±1	29~31	30.09
	GPRS(GMSK, 3 Tx slot)	28±1	27~29	28.21
	GPRS(GMSK, 4 Tx slot)	26±1	25~27	25.78
GSM 1900	GSM (GMSK)	29±1	28~30	29.55
	GPRS(GMSK, 1 Tx slot)	29±1	28~30	29.54
	GPRS(GMSK, 2 Tx slot)	27±1	26~28	27.11
	GPRS(GMSK, 3 Tx slot)	25±1	24~26	25.28
	GPRS(GMSK, 4 Tx slot)	23±1	22~24	23.41
BT 3.0	1M	4±1	3~5	3.88
	2M	3±1	2~4	2.86
	3M	4±1	3~5	3.33

8.2. GSM Conducted Power

1) Per KDB 447498 D01, the maximum output power channel is used for SAR testing and for further SAR test reduction.

SIM 1:

Band GSM850	Burst-Averaged output Power (dBm)				Frame-Averaged output Power (dBm)			
Tx Channel	Tune-up	128	189	251	Tune-up	128	189	251
Frequency (MHz)	(dBm)	824.2	836.4	848.8	(dBm)	824.2	836.4	848.8
GSM (GMSK)	33.00	31.63	31.58	31.48	23.97	22.60	22.55	22.45
GPRS(GMSK, 1 TS)	33.00	31.61	31.54	31.46	23.97	22.58	22.51	22.43
GPRS(GMSK, 2 TS)	31.00	30.09	30.06	30.02	24.98	24.07	24.04	24.00
GPRS(GMSK, 3 TS)	29.00	28.21	28.03	28.00	24.74	23.95	23.77	23.74
GPRS(GMSK, 4 TS)	27.00	25.71	25.69	25.78	23.99	22.70	22.68	22.77
Band GSM1900	Burst-Averaged output Power (dBm)				Frame-Averaged output Power (dBm)			
Tx Channel	Tune-up	512	661	810	Tune-up	512	661	810
Frequency (MHz)	(dBm)	1850.2	1880.0	1909.8	(dBm)	1850.2	1880.0	1909.8
GSM (GMSK)	30.00	29.41	29.19	29.55	20.97	20.38	20.16	20.52
GPRS(GMSK, 1 TS)	30.00	29.39	29.18	29.54	20.97	20.36	20.15	20.51
GPRS(GMSK, 2 TS)	28.00	27.11	27.02	26.93	21.98	21.09	21.00	20.91

GPRS(GMSK, 3 TS)	26.00	25.28	25.19	25.15	21.74	21.02	20.93	20.89
GPRS(GMSK, 4 TS)	24.00	23.41	23.25	23.15	20.99	20.40	20.24	20.14

Note: The frame-averaged power is linearly scaled the maximum burst averaged power over 8 time slots.

The calculated method are shown as below:

Frame-averaged power = Maximum burst averaged power (1 TS) – 9.03 dB

Frame-averaged power = Maximum burst averaged power (2 TS) – 6.02 dB

Frame-averaged power = Maximum burst averaged power (3 TS) - 4.26 dB

Frame-averaged power = Maximum burst averaged power (4 TS) – 3.01 dB

SIM 2:

Band GSM850	Burst-Averaged output Power (dBm)				Frame-Averaged output Power (dBm)			
Tx Channel	Tune-up	128	189	251	Tune-up	128	189	251
Frequency (MHz)	(dBm)	824.2	836.4	848.8	(dBm)	824.2	836.4	848.8
GSM (GMSK)	33.00	31.60	31.52	31.44	23.97	22.57	22.49	22.41
GPRS(GMSK, 1 TS)	33.00	31.57	31.51	31.40	23.97	22.54	22.48	22.37
GPRS(GMSK, 2 TS)	31.00	30.06	30.00	29.98	24.98	24.04	23.98	23.96
GPRS(GMSK, 3 TS)	29.00	28.17	28.00	27.94	24.74	23.91	23.74	23.68
GPRS(GMSK, 4 TS)	27.00	25.68	25.63	25.74	23.99	22.67	22.62	22.73
Band GSM1900	Burst-Averaged output Power (dBm)				Frame-Averaged output Power (dBm)			
Tx Channel	Tune-up	512	661	810	Tune-up	512	661	810
Frequency (MHz)	(dBm)	1850.2	1880.0	1909.8	(dBm)	1850.2	1880.0	1909.8
GSM (GMSK)	30.00	29.37	29.17	29.52	20.97	20.34	20.14	20.49
GPRS(GMSK, 1 TS)	30.00	29.35	29.15	29.48	20.97	20.32	20.12	20.45
GPRS(GMSK, 2 TS)	28.00	27.09	26.98	26.92	21.98	21.07	20.96	20.90
GPRS(GMSK, 3 TS)	26.00	25.24	25.16	25.09	21.74	20.98	20.90	20.83
GPRS(GMSK, 4 TS)	24.00	23.33	23.21	23.14	20.99	20.32	20.20	20.13

Note: The frame-averaged power is linearly scaled the maximum burst averaged power over 8 time slots.

The calculated method are shown as below:

Frame-averaged power = Maximum burst averaged power (1 TS) – 9.03 dB

Frame-averaged power = Maximum burst averaged power (2 TS) – 6.02 dB

Frame-averaged power = Maximum burst averaged power (3 TS) - 4.26 dB

Frame-averaged power = Maximum burst averaged power (4 TS) – 3.01 dB

8.3. BT Output Power

8.3.1. Output Power Results Of BT

The output power of BT is as following:

BT	Output Power (dBm)			
	Tune-up	0CH	39CH	78CH
DH5	5.00	3.88	3.88	3.75
2DH5	4.00	2.47	2.34	2.86
3DH5	5.00	3.20	3.33	3.31

9. Antenna Location

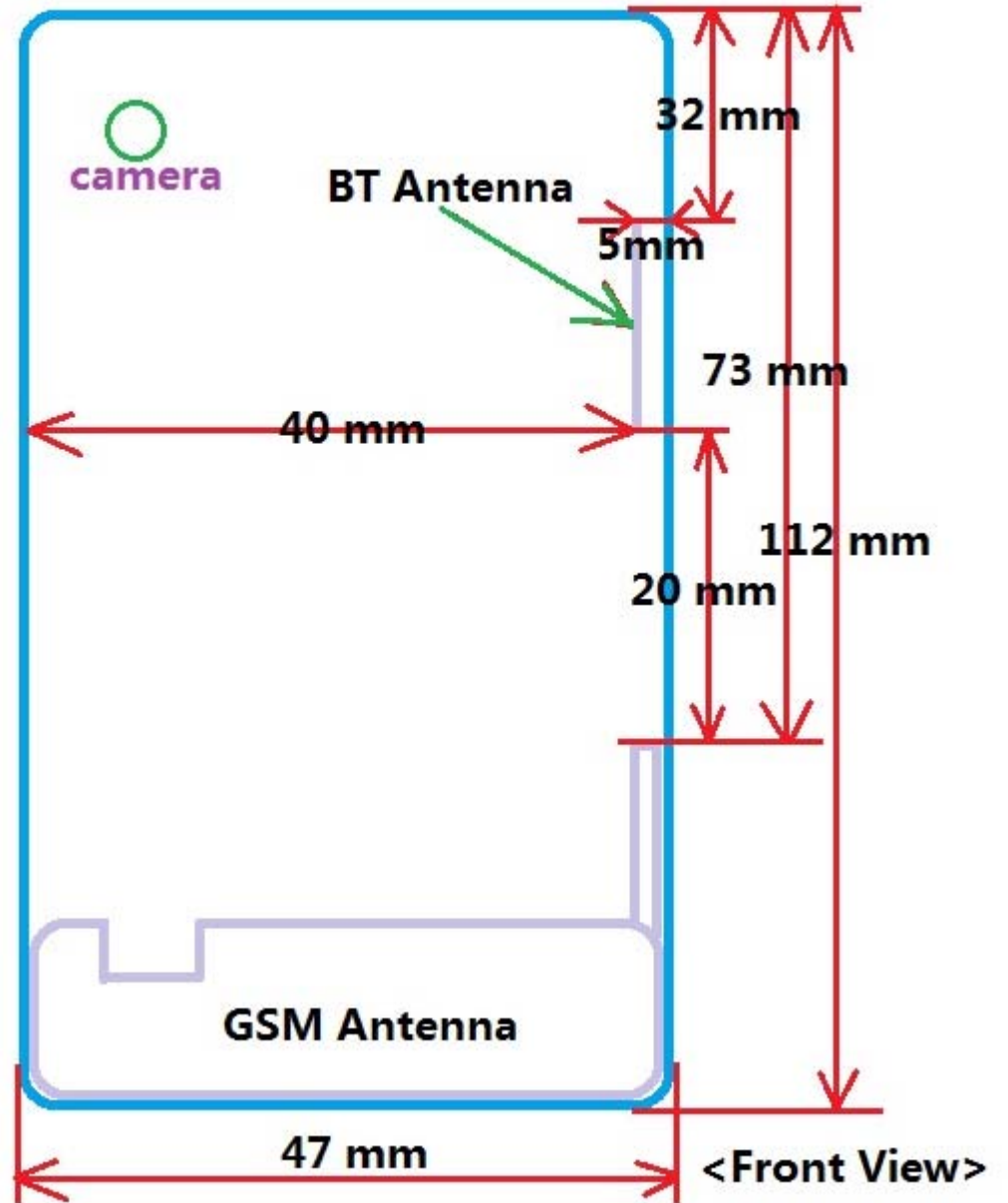

10. Stand-alone SAR test exclusion

Per FCC KDB 447498D01, the 1-g SAR and 10-g SAR test exclusion thresholds for 100 MHz to 6 GHz at test separation distances ≤ 50 mm are determined by:

$[(\text{max. power of channel, including tune-up tolerance, mW})/(\text{min. test separation distance, mm})] \cdot [\sqrt{f_{\text{(GHz)}}}] \leq 3.0$ for 1-g SAR and ≤ 7.5 for 10-g extremity SAR, where:

- $f_{\text{(GHz)}}$ is the RF channel transmit frequency in GHz
- Power and distance are rounded to the nearest mW and mm before calculation
- The result is rounded to one decimal place for comparison

When the minimum test separation distance is < 5 mm, a distance of 5 mm is applied to determine SAR test exclusion.

Mode	P_{max} (dBm)	P_{max} (mW)	Distance (mm)	f (GHz)	Calculation Result	SAR Exclusion threshold	SAR test exclusion
BT	5.00	3.16	<5	2.480	1.00	3.0	Yes

NOTE: Standalone SAR test exclusion for BT

When standalone SAR test exclusion applies to an antenna that transmits simultaneously with other antennas, the standalone SAR must be estimated according to following to determine simultaneous transmission SAR test exclusion:

$[(\text{max. power of channel, including tune-up tolerance, mW})/(\text{min. test separation distance, mm})] \cdot [\sqrt{f_{\text{(GHz)}}/x}] \text{ W/kg}$ for test separation distances $\leq 50\text{mm}$, where $x = 7.5$ for 1-g SAR and $x = 18.75$ for 10-g SAR.

When the minimum test separation distance is < 5 mm, a distance of 5 mm is applied to determine SAR test exclusion.

Mode	Position	P_{max} (dBm)	P_{max} (mW)	Distance (mm)	f (GHz)	x	Estimated SAR (W/Kg)
BT	Head	5.00	3.16	<5	2.480	7.5	0.133
BT	Body-worn	5.00	3.16	<5	2.480	7.5	0.133

NOTE: Estimated SAR calculation for BT

11. SAR Measurement Results

11.1. SAR measurement results

General Notes:

- 1) Per KDB447498 D01, all measurement SAR results are scaled to the maximum tune-up tolerance limit to demonstrate compliant.
- 2) Per KDB447498 D01, testing of other required channels within the operating mode of a frequency band is not required when the reported 1-g or 10-g SAR for the mid-band or highest output power channel is: ≤ 0.8 W/kg or 2.0 W/kg, for 1-g or 10-g respectively, when the transmission band is ≤ 100 MHz. When the maximum output power variation across the required test channels is $> \frac{1}{2}$ dB, instead of the middle channel, the highest output power channel must be used.
- 3) Per KDB865664 D01, for each frequency band, repeated SAR measurement is required only when the measured SAR is ≥ 0.8 W/Kg; if the deviation among the repeated measurement is $\leq 20\%$, and the measured SAR < 1.45 W/Kg, only one repeated measurement is required.
- 5) Per KDB865664 D02, SAR plot is only required for the highest measured SAR in each exposure configuration, wireless mode and frequency band combination; Plots are also required when the measured SAR is > 1.5 W/kg, or > 7.0 W/kg for occupational exposure. The published RF exposure KDB procedures may require additional plots; for example, to support SAR to peak location separation ratio test exclusion and/or volume scan post-processing(Refer to appendix C for details).

11.1.1. SAR measurement Result of GSM850

Test Position of Head	Test channel /Freq.	Test Mode	SAR Value (W/kg)		Power Drift (±5%)	Conducted power (dBm)	Tune-up power (dBm)	Scaled SAR 1g (W/Kg)
			1g	10g				
Test data with SIM 1								
Left Cheek	128/824.2	GSM Voice	0.388	0.114	-1.92	31.63	33.00	0.532
Left Tilt 15 Degree	128/824.2	GSM Voice	0.127	0.055	-0.68	31.63	33.00	0.174
Right Cheek	128/824.2	GSM Voice	0.275	0.151	0.63	31.63	33.00	0.377
Right Tilt 15 Degree	128/824.2	GSM Voice	0.119	0.046	-0.06	31.63	33.00	0.163
Tested at the Worst position with SIM 2								
Left Cheek	128/824.2	GSM Voice	0.381	0.111	0.11	31.63	33.00	0.522

NOTE: Head SAR test results of GSM850.

Test Position of Body-Worn with 5mm	Test channel /Freq.	Test Mode	SAR Value (W/kg)		Power Drift (±5%)	Conducted power (dBm)	Tune-up power (dBm)	Scaled SAR 1g (W/Kg)
			1g	10g				
Test data with SIM 1								
Front Side	128/824.2	GPRS(GMSK 2TS)	0.902	0.653	-3.74	30.09	31.00	1.112
Back Side	128/824.2	GPRS(GMSK 2TS)	0.969	0.712	-0.69	30.09	31.00	1.195
Back Side - Repeated	128/824.2	GPRS(GMSK 2TS)	0.956	0.693	0.09	30.09	31.00	1.179
Front Side	189/836.4	GPRS(GMSK 2TS)	0.876	0.631	0.83	30.06	31.00	1.088
Front Side	251/848.8	GPRS(GMSK 2TS)	0.857	0.664	1.37	30.02	31.00	1.074
Back Side	189/836.4	GPRS(GMSK 2TS)	0.938	0.659	-0.92	30.06	31.00	1.165
Back Side	251/848.8	GPRS(GMSK 2TS)	0.891	0.634	3.77	30.02	31.00	1.117
Tested at the Worst position with SIM 2								
Back Side	128/824.2	GPRS(GMSK 2TS)	0.931	0.688	0.11	30.09	31.00	1.148
Back Side	189/836.4	GPRS(GMSK 2TS)	0.900	0.621	0.01	30.06	31.00	1.117
Back Side	251/848.8	GPRS(GMSK 2TS)	0.853	0.600	-0.12	30.02	31.00	1.069

NOTE: Body-Worn SAR test results of GSM850

11.1.2. SAR measurement Result of GSM1900

Test Position of Head	Test channel /Freq.	Test Mode	SAR Value (W/kg)		Power Drift (±5%)	Conducted power (dBm)	Tune-up power (dBm)	Scaled SAR 1g (W/Kg)
			1g	10g				
Test data with SIM 1								
Left Cheek	810/1909.8	GSM Voice	0.809	0.367	-4.22	29.55	30.00	0.897
Left Tilt 15 Degree	810/1909.8	GSM Voice	0.682	0.303	2.53	29.55	30.00	0.756
Right Cheek	810/1909.8	GSM Voice	0.711	0.351	0.12	29.55	30.00	0.789
Right Tilt 15 Degree	810/1909.8	GSM Voice	0.516	0.281	-0.17	29.55	30.00	0.572
Left Cheek	512/1850.2	GSM Voice	0.897	0.559	0.12	29.41	30.00	1.028
Left Cheek - Repeated	512/1850.2	GSM Voice	0.888	0.548	-0.11	29.41	30.00	1.017
Left Cheek	661/1880	GSM Voice	0.874	0.467	2.08	29.19	30.00	1.053
Tested at the Worst position with SIM 2								
Left Cheek	661/1880	GSM Voice	0.866	0.459	0.01	29.19	30.00	1.044
Left Cheek	512/1850.2	GSM Voice	0.881	0.543	0.03	29.41	30.00	1.009
Left Cheek	810/1909.8	GSM Voice	0.794	0.359	0.22	29.55	30.00	0.881

NOTE: Head SAR test results of GSM1900

Test Position of Body-Worn with 5mm	Test channel /Freq.	Test Mode	SAR Value (W/kg)		Power Drift (±5%)	Conducted power (dBm)	Tune-up power (dBm)	Scaled SAR 1g (W/Kg)
			1g	10g				
Test data with SIM 1								
Front Side	512/1850.2	GPRS(GMSK 2TS)	0.856	0.566	1.81	27.11	28.00	1.051
Back Side	512/1850.2	GPRS(GMSK 2TS)	0.967	0.694	1.31	27.11	28.00	1.187
Back Side - Repeated	512/1850.2	GPRS(GMSK 2TS)	0.959	0.690	-0.09	27.11	28.00	1.177
Front Side	661/1880	GPRS(GMSK 2TS)	0.744	0.464	3.07	27.02	28.00	0.932
Front Side	810/1909.8	GPRS(GMSK 2TS)	0.741	0.459	-0.52	26.93	28.00	0.948
Back Side	661/1880	GPRS(GMSK 2TS)	0.820	0.670	1.82	27.02	28.00	1.028
Back Side	810/1909.8	GPRS(GMSK 2TS)	0.808	0.611	-0.71	26.93	28.00	1.034
Tested at the Worst position with SIM 2								
Back Side	512/1850.2	GPRS(GMSK 2TS)	0.949	0.681	0.13	27.11	28.00	1.165
Back Side	661/1880	GPRS(GMSK 2TS)	0.800	0.663	1.82	27.02	28.00	1.003
Back Side	810/1909.8	GPRS(GMSK 2TS)	0.787	0.601	-0.71	26.93	28.00	1.007

NOTE: Body-Worn SAR test results of GSM1900

12. Appendix A. Photo documentation

Table of contents
Test Facility
Product Photo
Test Positions
Liquid depth

Test Facility

Measurement System SATIMO



Product Photo

Front View



Back View



Overall Dimensions



Reference Line



Battery(Front)



Battery(Back)



Test Positions

Left Cheek



Left Tilt 15 Degree

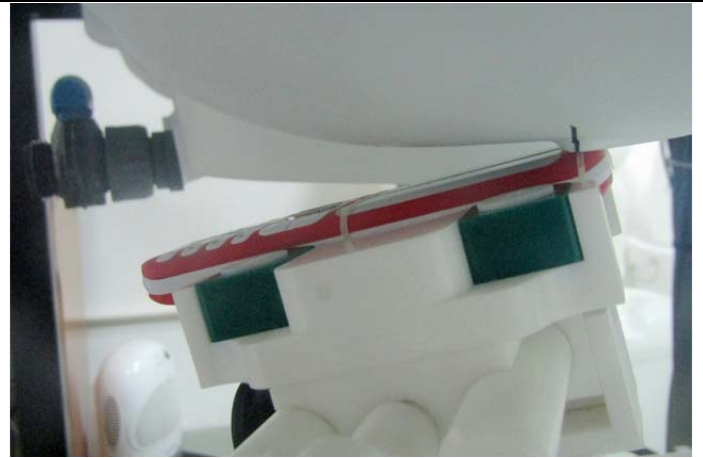

Right Cheek



Right Tilt 15 Degree



Front Side (5mm)

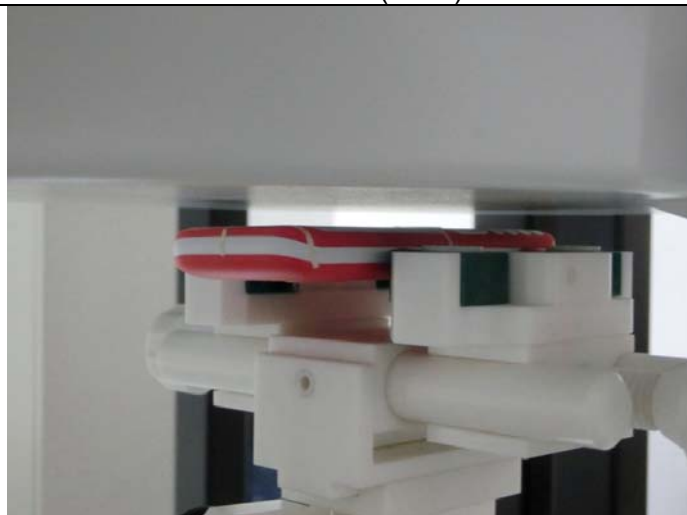

Back Side (5mm)



Liquid depth

Head 850MHz depth (15.2cm)

Body 850MHz depth (15.3cm)



Head 1900MHz depth (15.3cm)

Body 1900MHz depth (15.3cm)



13. Appendix B. System Check Plots

Table of contents
System Performance Check - SID835-Head
System Performance Check - SID835-Body
System Performance Check - SID1900-Head
System Performance Check - SID1900-Body

System Performance Check - SID835-Head

Date of measurement:	Sep 23, 2015
Signal:	Communication System: CW; Frequency: 835.00MHz; Duty Cycle: 1:1.00
ConvF:	4.54
Liquid Parameters:	Relative permittivity (real part): 43.29; Conductivity (S/m): 0.87;
Device Position:	Dipole
Area Scan:	dx=15mm dy=15mm, h=5.00mm
Zoom Scan:	5x5x7, dx=8mm dy=8mm dz=5mm, h=5.00mm

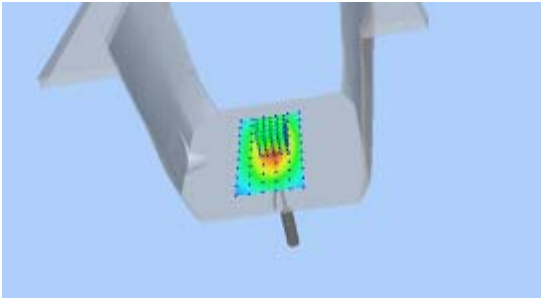
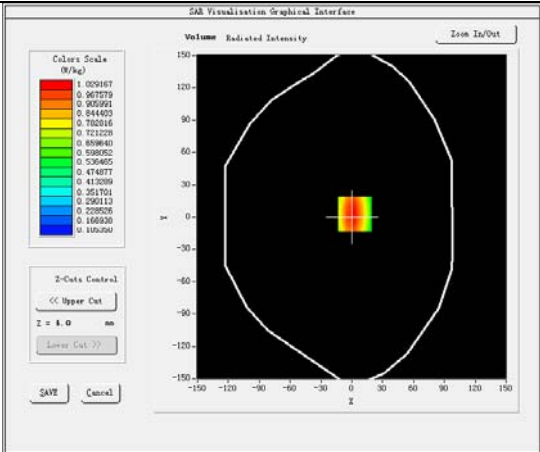
3D screen shot	Volume SAR
	

Maximum location: X=3.00, Y=3.00
SAR Peak: 1.40 W/kg

SAR 1g (W/Kg)		0.967					
SAR 10g (W/Kg)		0.651					
Power Drift (±5%):		0.13					
Z (mm)	0.00	4.00	9.00	14.00	19.00	24.00	29.00
SAR (W/Kg)	1.3995	1.0919	0.7108	0.5038	0.3496	0.2567	0.1869

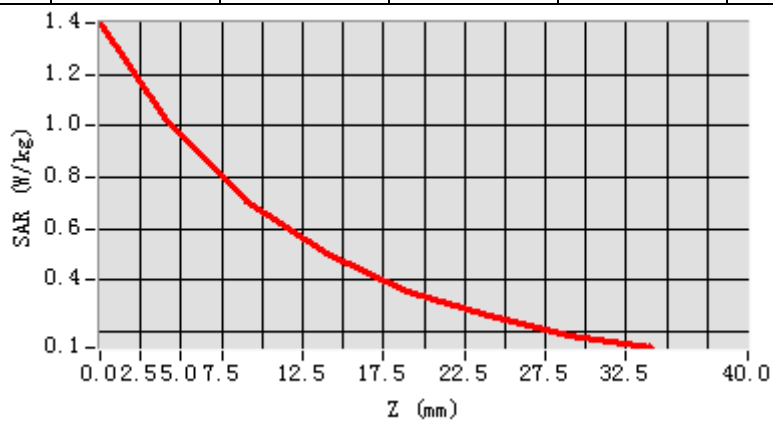

System Performance Check - SID835-Body

Date of measurement:	Oct 13, 2015
Signal:	Communication System: CW; Frequency: 835.00MHz; Duty Cycle: 1:1.00
ConvF:	4.71
Liquid Parameters:	Relative permittivity (real part): 55.30; Conductivity (S/m): 0.98;
Device Position:	Dipole
Area Scan:	dx=15mm dy=15mm, h=5.00mm
Zoom Scan:	5x5x7, dx=8mm dy=8mm dz=5mm, h=5.00mm

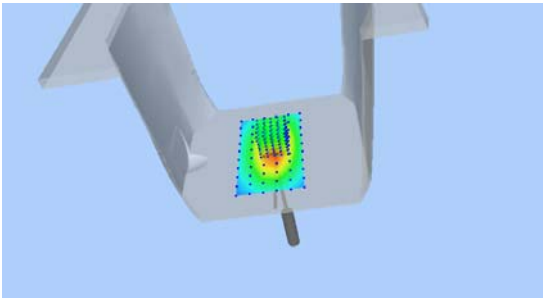
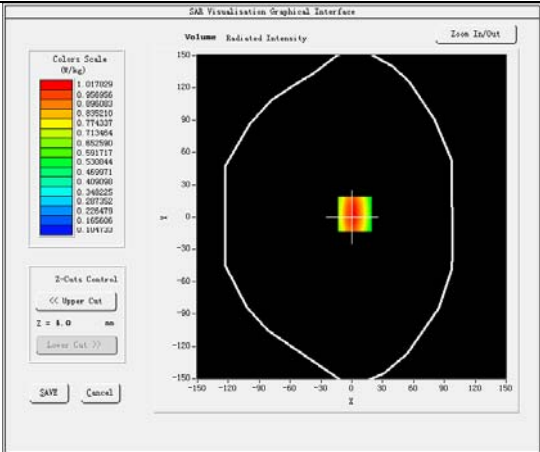
3D screen shot	Volume SAR
	

Maximum location: X=3.00, Y=3.00
SAR Peak: 1.38 W/kg

SAR 1g (W/Kg)	0.988
SAR 10g (W/Kg)	0.651
Power Drift (±5%):	0.31
Z (mm)	0.00 4.00 9.00 14.00 19.00 24.00 29.00
SAR (W/Kg)	1.3755 1.0178 0.7055 0.5021 0.3613 0.2632 0.1915

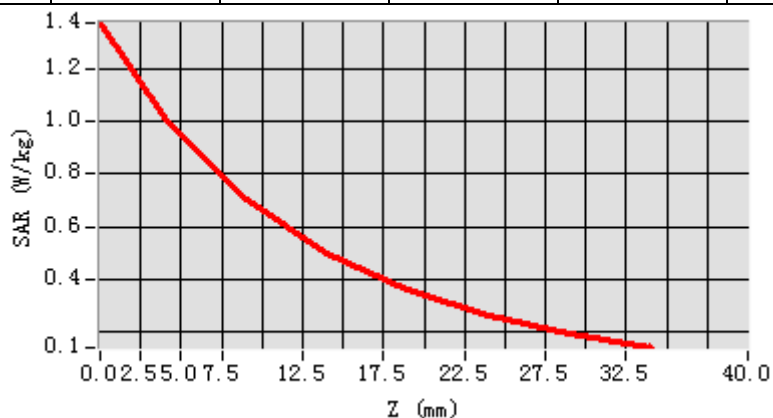

System Performance Check - SID1900-Head

Date of measurement:	Sep 23, 2015
Signal:	Communication System: CW; Frequency: 1900.00MHz; Duty Cycle: 1:1.00
ConvF:	4.27
Liquid Parameters:	Relative permittivity (real part): 38.54; Conductivity (S/m): 1.42;
Device Position:	Dipole
Area Scan:	dx=15mm dy=15mm, h=5.00mm
Zoom Scan:	5x5x7, dx=8mm dy=8mm dz=5mm, h=5.00mm

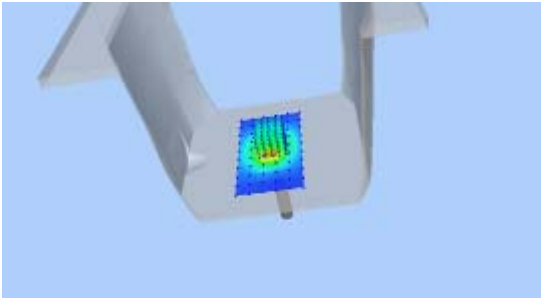
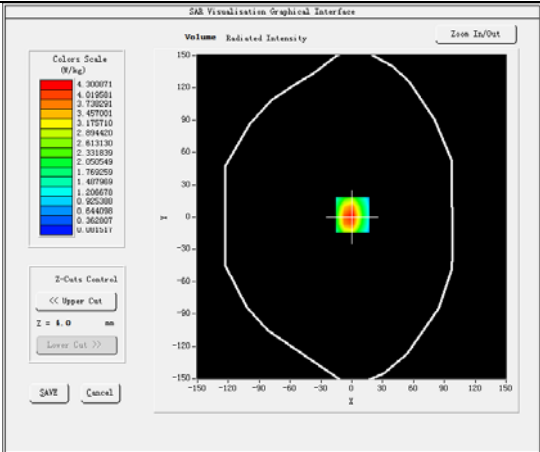
3D screen shot	Volume SAR
	

Maximum location: X=1.00, Y=2.00
SAR Peak: 6.73 W/kg

SAR 1g (W/Kg)		3.971					
SAR 10g (W/Kg)		2.068					
Power Drift (±5%):		0.07					
Z (mm)	0.00	4.00	9.00	14.00	19.00	24.00	29.00
SAR (W/Kg)	6.7301	4.3434	2.4433	1.4488	0.8354	0.5656	0.3838

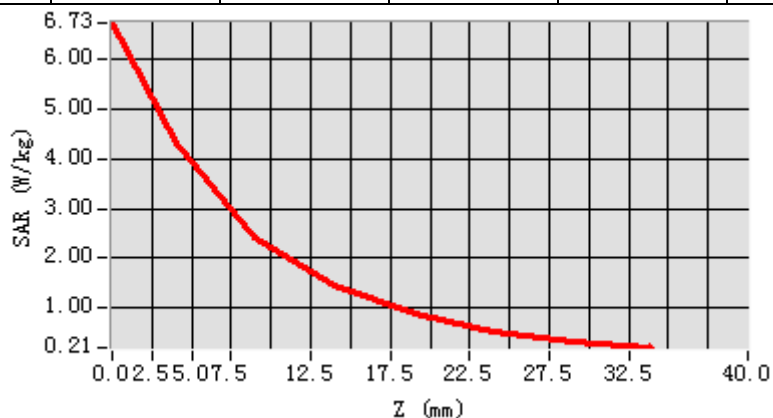

System Performance Check - SID1900-Body

Date of measurement:	Oct 13, 2015
Signal:	Communication System: CW; Frequency: 1900.00MHz; Duty Cycle: 1:1.00
ConvF:	4.39
Liquid Parameters:	Relative permittivity (real part): 52.93; Conductivity (S/m): 1.51;
Device Position:	Dipole
Area Scan:	dx=15mm dy=15mm, h=5.00mm
Zoom Scan:	5x5x7, dx=8mm dy=8mm dz=5mm, h=5.00mm

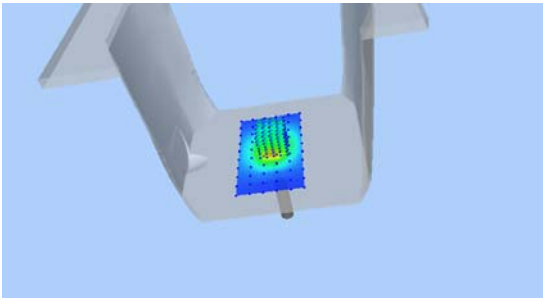
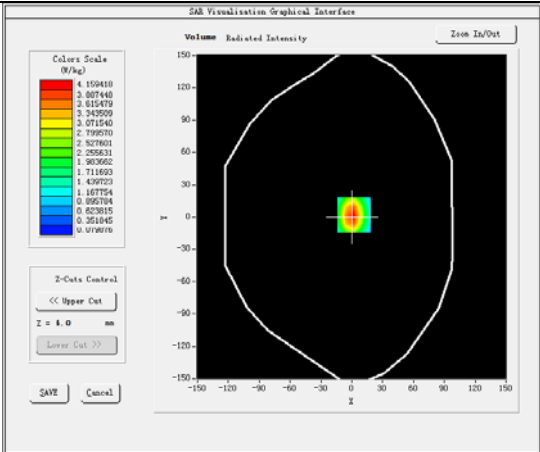
3D screen shot	Volume SAR
	

Maximum location: X=2.00, Y=2.00
SAR Peak: 6.52 W/kg

SAR 1g (W/Kg)	3.962
SAR 10g (W/Kg)	2.081
Power Drift (±5%):	-0.45
Z (mm)	0.00 4.00 9.00 14.00 19.00 24.00 29.00
SAR (W/Kg)	6.4462 4.1594 2.3660 1.4053 0.8361 0.5054 0.3068

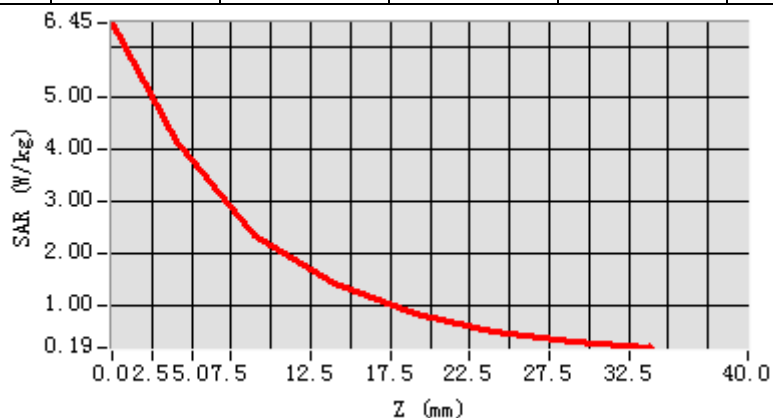

14. Appendix C. SAR Measurement Plots

Table of contents
GSM 850 Head
GSM 850 Body
GSM 1900 Head
GSM 1900 Body

GSM850_GSM Voice_Ch128_Left Cheek

Date of measurement:	Sep 23, 2015
Signal:	Communication System: GSM Voice (GMSK); Frequency: 824.20MHz; Duty Cycle: 1:8.33
ConvF:	4.54
Liquid Parameters:	Relative permittivity (real part): 43.40; Conductivity (S/m): 0.86;
Device Position:	Cheek
Area Scan:	dx=15mm dy=15mm, h=5.00mm
Zoom Scan:	5x5x7, dx=8mm dy=8mm dz=5mm, h=5.00mm

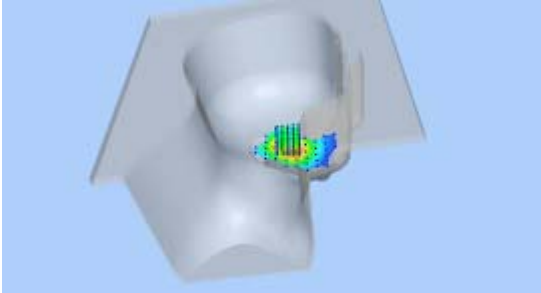
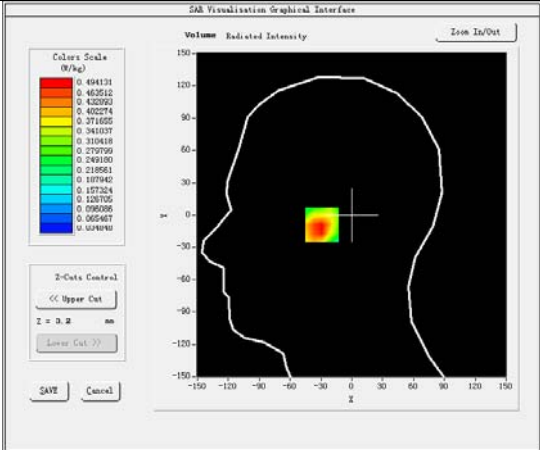
3D screen shot	Volume SAR
	

Maximum location: X=-24.00, Y=-9.00
SAR Peak: 0.71 W/kg

SAR 1g (W/Kg)				0.388			
SAR 10g (W/Kg)				0.114			
Power Drift (±5%):				-1.92			
Z (mm)	0.00	4.00	9.00	14.00	19.00	24.00	29.00
SAR (W/Kg)	0.7129	0.4941	0.3239	0.2641	0.1730	0.1345	0.0869

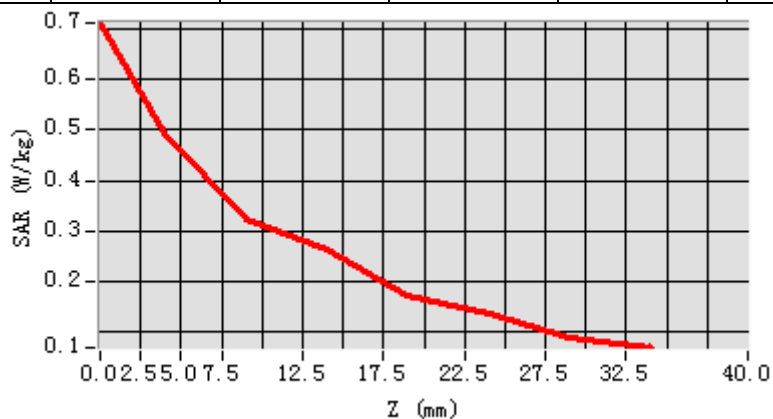

GSM850_ GPRS (GMSK 2TS)_ Ch128_ Back Side_ 5mm

Date of measurement:	Oct 13, 2015
Signal:	Communication System: GPRS (GMSK 2TS); Frequency: 824.20MHz; Duty Cycle: 1:4.17
ConvF:	4.71
Liquid Parameters:	Relative permittivity (real part): 55.41; Conductivity (S/m): 0.97;
Device Position:	Body
Area Scan:	dx=15mm dy=15mm, h=5.00mm
Zoom Scan:	5x5x7, dx=8mm dy=8mm dz=5mm, h=5.00mm

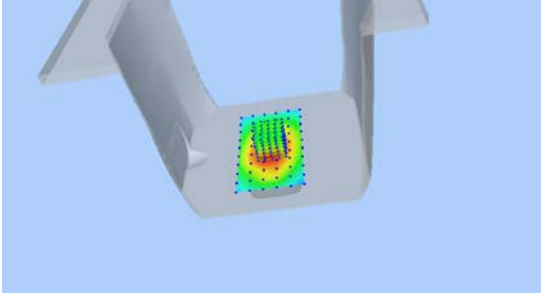
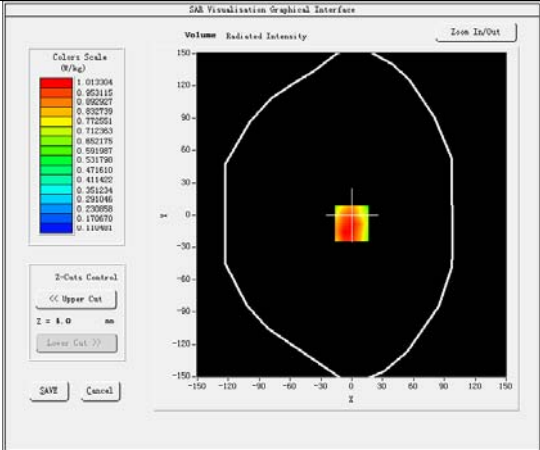
3D screen shot	Volume SAR
	

Maximum location: X=0.00, Y=-8.00
SAR Peak: 1.43 W/kg

SAR 1g (W/Kg)		0.969					
SAR 10g (W/Kg)		0.712					
Power Drift (±5%):		-0.69					
Z (mm)	0.00	4.00	9.00	14.00	19.00	24.00	29.00
SAR (W/Kg)	1.4637	1.0133	0.6677	0.5672	0.4262	0.2953	0.2515

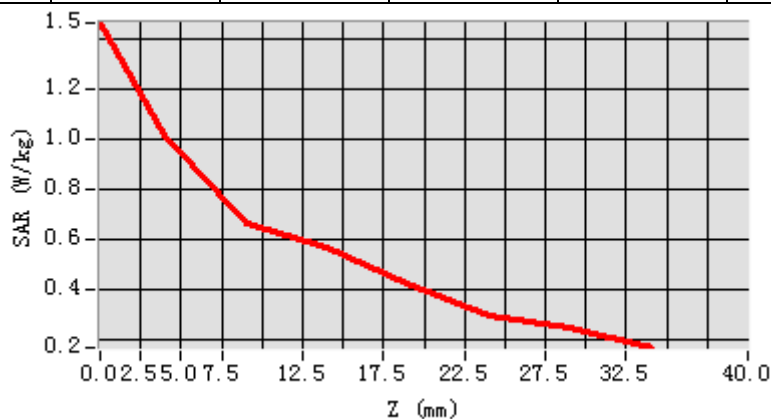

GSM1900_GSM Voice_Ch512_Left Cheek

Date of measurement:	Sep 23, 2015
Signal:	Communication System: GSM Voice (GMSK); Frequency: 1850.20MHz; Duty Cycle: 1:8.33
ConvF:	4.27
Liquid Parameters:	Relative permittivity (real part): 38.79; Conductivity (S/m): 1.38;
Device Position:	Cheek
Area Scan:	dx=15mm dy=15mm, h=5.00mm
Zoom Scan:	5x5x7, dx=8mm dy=8mm dz=5mm, h=5.00mm

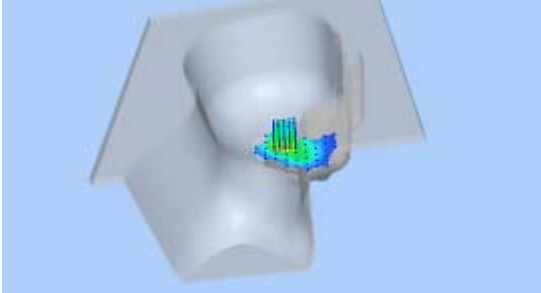
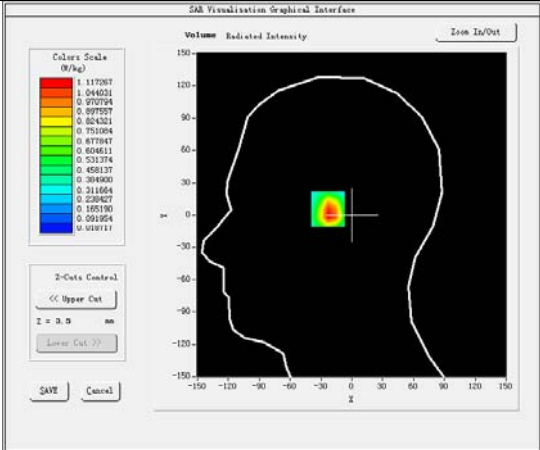
3D screen shot	Volume SAR
	

Maximum location: X=-20.00, Y=6.00
SAR Peak: 1.71 W/kg

SAR 1g (W/Kg)	0.897						
SAR 10g (W/Kg)	0.559						
Power Drift (±5%):	0.12						
Z (mm)	0.00	4.00	9.00	14.00	19.00	24.00	29.00
SAR (W/Kg)	1.9954	1.1173	0.5048	0.4312	0.1641	0.1595	0.0598

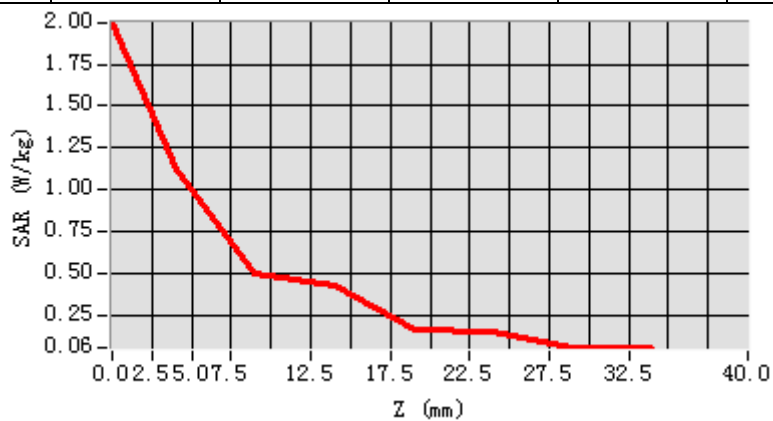

GSM1900_GPRS (GMSK 2TS)_Ch512_Back Side_5mm

Date of measurement:	Oct 13, 2015
Signal:	Communication System: GPRS (GMSK 2TS); Frequency: 1850.20MHz; Duty Cycle: 1:4.17
ConvF:	4.39
Liquid Parameters:	Relative permittivity (real part): 53.11; Conductivity (S/m): 1.48;
Device Position:	Body
Area Scan:	dx=15mm dy=15mm, h=5.00mm
Zoom Scan:	5x5x7, dx=8mm dy=8mm dz=5mm, h=5.00mm

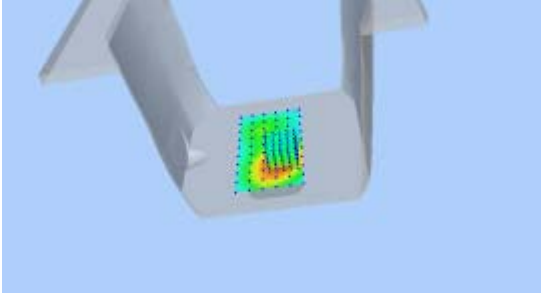
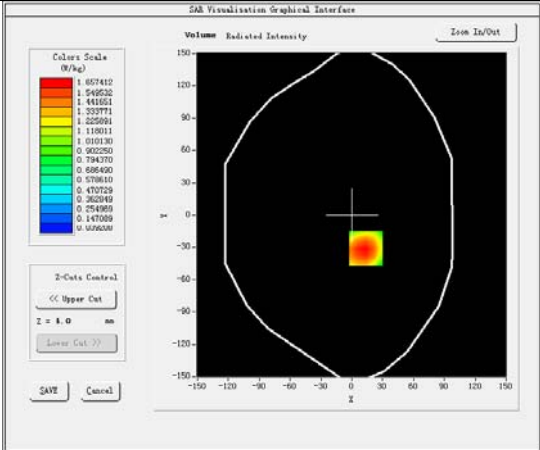
3D screen shot	Volume SAR
	

Maximum location: X=-8.00, Y=-42.00
SAR Peak: 2.06 W/kg

SAR 1g (W/Kg)		0.967					
SAR 10g (W/Kg)		0.694					
Power Drift (±5%):		1.31					
Z (mm)	0.00	4.00	9.00	14.00	19.00	24.00	29.00
SAR (W/Kg)	2.0590	1.3769	0.8235	0.4954	0.3066	0.1844	0.1119

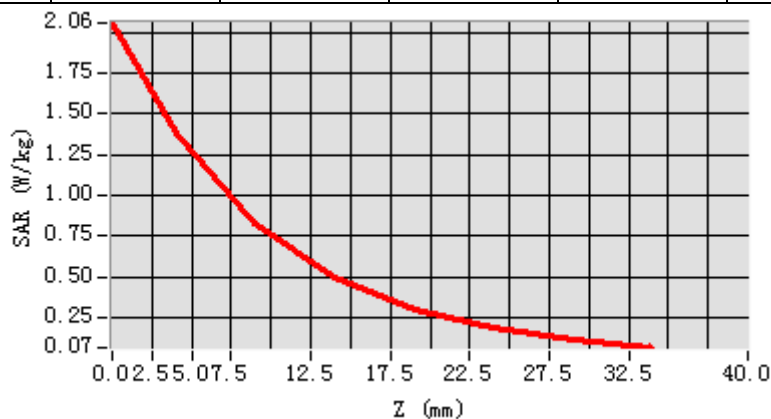

15. Appendix D. Calibration Certificate

Table of contents
E Field Probe - SN 07/15 EP247
835 MHz Dipole - SN 03/15 DIP 0G835-347
1900 MHz Dipole - SN 03/15 DIP 1G900-350



COMOSAR E-Field Probe Calibration Report

Ref : ACR.139.1.15.SATU.A

NTEK TESTING TECHNOLOGY CO., LTD.
BUILDING E, FENDA SCIENCE PARK, SANWEI
COMMUNITY, XIXIANG STREET,
BAO'AN DISTRICT, SHENZHEN GUANGDONG, CHINA
MVG COMOSAR DOSIMETRIC E-FIELD PROBE
SERIAL NO.: SN 07/15 EP247

Calibrated at MVG US
2105 Barrett Park Dr. - Kennesaw, GA 30144



04/06/2015

Summary:

This document presents the method and results from an accredited COMOSAR Dosimetric E-Field Probe calibration performed in MVG USA using the CALISAR / CALIBAIR test bench, for use with a COMOSAR system only. All calibration results are traceable to national metrology institutions.



COMOSAR E-FIELD PROBE CALIBRATION REPORT

Ref: ACR.139.1.15.SATU.A

	<i>Name</i>	<i>Function</i>	<i>Date</i>	<i>Signature</i>
<i>Prepared by :</i>	Jérôme LUC	Product Manager	5/19/2015	<i>JS</i>
<i>Checked by :</i>	Jérôme LUC	Product Manager	5/19/2015	<i>JS</i>
<i>Approved by :</i>	Kim RUTKOWSKI	Quality Manager	5/19/2015	<i>Kim Rutkowski</i>

	<i>Customer Name</i>
<i>Distribution :</i>	NTEK TESTING TECHNOLOGY CO., LTD.

<i>Issue</i>	<i>Date</i>	<i>Modifications</i>
A	5/19/2015	Initial release



COMOSAR E-FIELD PROBE CALIBRATION REPORT

Ref: ACR.139.1.15.SATU.A

TABLE OF CONTENTS

1	Device Under Test	4
2	Product Description	4
2.1	General Information	4
3	Measurement Method	4
3.1	Linearity	4
3.2	Sensitivity	5
3.3	Lower Detection Limit	5
3.4	Isotropy	5
3.5	Boundary Effect	5
4	Measurement Uncertainty	5
5	Calibration Measurement Results	6
5.1	Sensitivity in air	6
5.2	Linearity	7
5.3	Sensitivity in liquid	7
5.4	Isotropy	8
6	List of Equipment	9



COMOSAR E-FIELD PROBE CALIBRATION REPORT

Ref: ACR.139.1.15.SATU.A

1 DEVICE UNDER TEST

Device Under Test	
Device Type	COMOSAR DOSIMETRIC E FIELD PROBE
Manufacturer	MVG
Model	SSE5
Serial Number	SN 07/15 EP247
Product Condition (new / used)	New
Frequency Range of Probe	0.7 GHz-3GHz
Resistance of Three Dipoles at Connector	Dipole 1: R1=0.181 MΩ Dipole 2: R2=0.167 MΩ Dipole 3: R3=0.175 MΩ

A yearly calibration interval is recommended.

2 PRODUCT DESCRIPTION

2.1 GENERAL INFORMATION

MVG’s COMOSAR E field Probes are built in accordance to the IEEE 1528, OET 65 Bulletin C and CEI/IEC 62209 standards.



Figure 1 – MVG COMOSAR Dosimetric E field Dipole

Probe Length	330 mm
Length of Individual Dipoles	4.5 mm
Maximum external diameter	8 mm
Probe Tip External Diameter	5 mm
Distance between dipoles / probe extremity	2.7 mm

3 MEASUREMENT METHOD

The IEEE 1528, OET 65 Bulletin C, CENELEC EN50361 and CEI/IEC 62209 standards provide recommended practices for the probe calibrations, including the performance characteristics of interest and methods by which to assess their affect. All calibrations / measurements performed meet the fore mentioned standards.

3.1 LINEARITY

The evaluation of the linearity was done in free space using the waveguide, performing a power sweep to cover the SAR range 0.01W/kg to 100W/kg.



COMOSAR E-FIELD PROBE CALIBRATION REPORT

Ref. ACR.139.1.15.SATU.A

3.2 SENSITIVITY

The sensitivity factors of the three dipoles were determined using a two step calibration method (air and tissue simulating liquid) using waveguides as outlined in the standards.

3.3 LOWER DETECTION LIMIT

The lower detection limit was assessed using the same measurement set up as used for the linearity measurement. The required lower detection limit is 10 mW/kg.

3.4 ISOTROPY

The axial isotropy was evaluated by exposing the probe to a reference wave from a standard dipole with the dipole mounted under the flat phantom in the test configuration suggested for system validations and checks. The probe was rotated along its main axis from 0 - 360 degrees in 15 degree steps. The hemispherical isotropy is determined by inserting the probe in a thin plastic box filled with tissue-equivalent liquid, with the plastic box illuminated with the fields from a half wave dipole. The dipole is rotated about its axis (0°–180°) in 15° increments. At each step the probe is rotated about its axis (0°–360°).

3.5 BOUNDARY EFFECT

The boundary effect is defined as the deviation between the SAR measured data and the expected exponential decay in the liquid when the probe is oriented normal to the interface. To evaluate this effect, the liquid filled flat phantom is exposed to fields from either a reference dipole or waveguide. With the probe normal to the phantom surface, the peak spatial average SAR is measured and compared to the analytical value at the surface.

4 MEASUREMENT UNCERTAINTY

The guidelines outlined in the IEEE 1528, OET 65 Bulletin C, CENELEC EN50361 and CEI/IEC 62209 standards were followed to generate the measurement uncertainty associated with an E-field probe calibration using the waveguide technique. All uncertainties listed below represent an expanded uncertainty expressed at approximately the 95% confidence level using a coverage factor of k=2, traceable to the Internationally Accepted Guides to Measurement Uncertainty.

Uncertainty analysis of the probe calibration in waveguide					
ERROR SOURCES	Uncertainty value (%)	Probability Distribution	Divisor	ci	Standard Uncertainty (%)
Incident or forward power	3.00%	Rectangular	$\sqrt{3}$	1	1.732%
Reflected power	3.00%	Rectangular	$\sqrt{3}$	1	1.732%
Liquid conductivity	5.00%	Rectangular	$\sqrt{3}$	1	2.887%
Liquid permittivity	4.00%	Rectangular	$\sqrt{3}$	1	2.309%
Field homogeneity	3.00%	Rectangular	$\sqrt{3}$	1	1.732%
Field probe positioning	5.00%	Rectangular	$\sqrt{3}$	1	2.887%



COMOSAR E-FIELD PROBE CALIBRATION REPORT

Ref: ACR.139.1.15.SATU.A

Field probe linearity	3.00%	Rectangular	$\sqrt{3}$	1	1.732%
Combined standard uncertainty					5.831%
Expanded uncertainty 95 % confidence level k = 2					12.0%

5 CALIBRATION MEASUREMENT RESULTS

Calibration Parameters	
Liquid Temperature	21 °C
Lab Temperature	21 °C
Lab Humidity	45 %

5.1 SENSITIVITY IN AIR

Normx dipole 1 ($\mu\text{V}/(\text{V}/\text{m})^2$)	Normy dipole 2 ($\mu\text{V}/(\text{V}/\text{m})^2$)	Normz dipole 3 ($\mu\text{V}/(\text{V}/\text{m})^2$)
6.82	6.16	6.12

DCP dipole 1 (mV)	DCP dipole 2 (mV)	DCP dipole 3 (mV)
95	93	90

Calibration curves $e_i=f(V)$ ($i=1,2,3$) allow to obtain H-field value using the formula:

$$E = \sqrt{E_1^2 + E_2^2 + E_3^2}$$

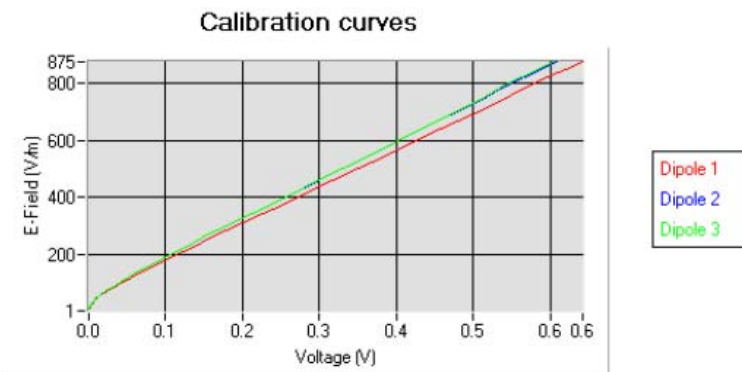



COMOSAR E-FIELD PROBE CALIBRATION REPORT

Ref. ACR.139.1.15.SATU.A

5.2 LINEARITY

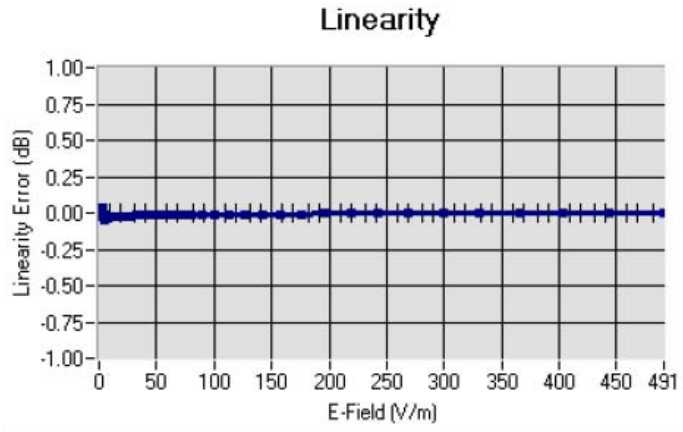

Linearity: $\pm 1.05\%$ ($\pm 0.05\text{dB}$)

5.3 SENSITIVITY IN LIQUID

Liquid	Frequency (MHz +/- 100MHz)	Permittivity	Epsilon (S/m)	ConvF
HL450	450	43.68	0.87	5.01
BL450	450	58.34	0.99	5.35
HL750	750	41.82	0.90	4.23
BL750	750	56.28	0.98	4.39
HL850	835	42.59	0.90	4.54
BL850	835	53.19	0.97	4.71
HL900	900	42.05	0.98	4.25
BL900	900	56.41	1.08	4.39
HL1800	1800	41.82	1.38	3.77
BL1800	1800	53.00	1.52	3.85
HL1900	1900	40.38	1.41	4.27
BL1900	1900	53.93	1.55	4.39
HL2000	2000	40.12	1.43	3.90
BL2000	2000	53.65	1.54	4.05
HL2450	2450	38.34	1.80	3.72
BL2450	2450	52.70	1.94	3.84
HL2600	2600	38.16	1.93	3.65
BL2600	2600	51.55	2.21	3.75

LOWER DETECTION LIMIT: 8mW/kg



COMOSAR E-FIELD PROBE CALIBRATION REPORT

Ref: ACR.139.1.15.SATU.A

5.4 ISOTROPY

HL900 MHz

- Axial isotropy: 0.04 dB
- Hemispherical isotropy: 0.05 dB

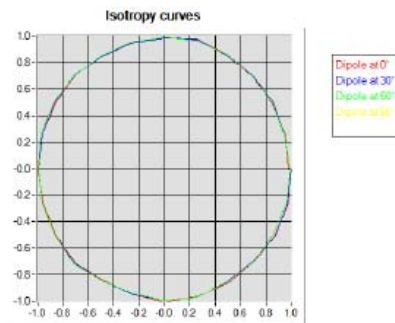

HL1800 MHz

- Axial isotropy: 0.05 dB
- Hemispherical isotropy: 0.08 dB

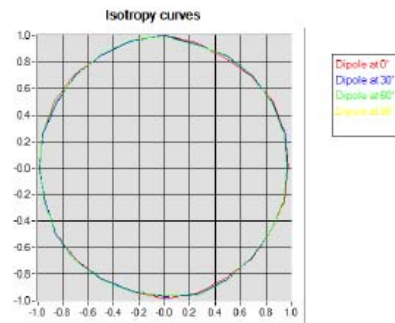



COMOSAR E-FIELD PROBE CALIBRATION REPORT

Ref. ACR.139.1.15.SATU.A

6 LIST OF EQUIPMENT

Equipment Summary Sheet				
Equipment Description	Manufacturer / Model	Identification No.	Current Calibration Date	Next Calibration Date
Flat Phantom	MVG	SN-20/09-SAM71	Validated. No cal required.	Validated. No cal required.
COMOSAR Test Bench	Version 3	NA	Validated. No cal required.	Validated. No cal required.
Network Analyzer	Rhode & Schwarz ZVA	SN100132	02/2013	02/2016
Reference Probe	MVG	EP 94 SN 37/08	10/2014	10/2015
Multimeter	Keithley 2000	1188656	12/2013	12/2016
Signal Generator	Agilent E4438C	MY49070581	12/2013	12/2016
Amplifier	Aethercomm	SN 046	Characterized prior to test. No cal required.	Characterized prior to test. No cal required.
Power Meter	HP E4418A	US38261498	12/2013	12/2016
Power Sensor	HP ECP-E26A	US37181460	12/2013	12/2016
Directional Coupler	Narda 4216-20	01386	Characterized prior to test. No cal required.	Characterized prior to test. No cal required.
Waveguide	Mega Industries	069Y7-158-13-712	Validated. No cal required.	Validated. No cal required.
Waveguide Transition	Mega Industries	069Y7-158-13-701	Validated. No cal required.	Validated. No cal required.
Waveguide Termination	Mega Industries	069Y7-158-13-701	Validated. No cal required.	Validated. No cal required.
Temperature / Humidity Sensor	Control Company	11-661-9	8/2012	8/2015



SAR Reference Dipole Calibration Report

Ref : ACR.139.4.15.SATU.A

NTEK TESTING TECHNOLOGY CO., LTD.
BUILDING E, FENDA SCIENCE PARK, SANWEI
COMMUNITY, XIXIANG STREET,
BAO'AN DISTRICT, SHENZHEN GUANGDONG, CHINA
MVG COMOSAR REFERENCE DIPOLE
FREQUENCY: 835 MHZ
SERIAL NO.: SN 03/15 DIP 0G835-347

Calibrated at MVG US
2105 Barrett Park Dr. - Kennesaw, GA 30144



04/06/2015

Summary:

This document presents the method and results from an accredited SAR reference dipole calibration performed in MVG USA using the COMOSAR test bench. All calibration results are traceable to national metrology institutions.



SAR REFERENCE DIPOLE CALIBRATION REPORT

Ref: ACR.139.4.15.SATU.A

	<i>Name</i>	<i>Function</i>	<i>Date</i>	<i>Signature</i>
<i>Prepared by :</i>	Jérôme LUC	Product Manager	5/19/2015	<i>JS</i>
<i>Checked by :</i>	Jérôme LUC	Product Manager	5/19/2015	<i>JS</i>
<i>Approved by :</i>	Kim RUTKOWSKI	Quality Manager	5/19/2015	<i>Kim Rutkowski</i>

	<i>Customer Name</i>
<i>Distribution :</i>	NTEK TESTING TECHNOLOGY CO., LTD.

<i>Issue</i>	<i>Date</i>	<i>Modifications</i>
A	5/19/2015	Initial release



TABLE OF CONTENTS

1	Introduction	4
2	Device Under Test	4
3	Product Description	4
3.1	General Information	4
4	Measurement Method	5
4.1	Return Loss Requirements	5
4.2	Mechanical Requirements	5
5	Measurement Uncertainty	5
5.1	Return Loss	5
5.2	Dimension Measurement	5
5.3	Validation Measurement	5
6	Calibration Measurement Results	6
6.1	Return Loss and Impedance In Head Liquid	6
6.2	Return Loss and Impedance In Body Liquid	6
6.3	Mechanical Dimensions	6
7	Validation measurement	7
7.1	Head Liquid Measurement	7
7.2	SAR Measurement Result With Head Liquid	8
7.3	Body Liquid Measurement	9
7.4	SAR Measurement Result With Body Liquid	10
8	List of Equipment	12



1 INTRODUCTION

This document contains a summary of the requirements set forth by the IEEE 1528, FCC KDBs and CEI/IEC 62209 standards for reference dipoles used for SAR measurement system validations and the measurements that were performed to verify that the product complies with the fore mentioned standards.

2 DEVICE UNDER TEST

Device Under Test	
Device Type	COMOSAR 835 MHz REFERENCE DIPOLE
Manufacturer	MVG
Model	SID835
Serial Number	SN 03/15 DIP 0G835-347
Product Condition (new / used)	New

A yearly calibration interval is recommended.

3 PRODUCT DESCRIPTION

3.1 GENERAL INFORMATION

MVG’s COMOSAR Validation Dipoles are built in accordance to the IEEE 1528, FCC KDBs and CEI/IEC 62209 standards. The product is designed for use with the COMOSAR test bench only.



Figure 1 – MVG COMOSAR Validation Dipole



4 MEASUREMENT METHOD

The IEEE 1528, FCC KDBs and CEI/IEC 62209 standards provide requirements for reference dipoles used for system validation measurements. The following measurements were performed to verify that the product complies with the fore mentioned standards.

4.1 RETURN LOSS REQUIREMENTS

The dipole used for SAR system validation measurements and checks must have a return loss of -20 dB or better. The return loss measurement shall be performed against a liquid filled flat phantom, with the phantom constructed as outlined in the fore mentioned standards.

4.2 MECHANICAL REQUIREMENTS

The IEEE Std. 1528 and CEI/IEC 62209 standards specify the mechanical components and dimensions of the validation dipoles, with the dimensions frequency and phantom shell thickness dependent. The COMOSAR test bench employs a 2 mm phantom shell thickness therefore the dipoles sold for use with the COMOSAR test bench comply with the requirements set forth for a 2 mm phantom shell thickness.

5 MEASUREMENT UNCERTAINTY

All uncertainties listed below represent an expanded uncertainty expressed at approximately the 95% confidence level using a coverage factor of k=2, traceable to the Internationally Accepted Guides to Measurement Uncertainty.

5.1 RETURN LOSS

The following uncertainties apply to the return loss measurement:

Frequency band	Expanded Uncertainty on Return Loss
400-6000MHz	0.1 dB

5.2 DIMENSION MEASUREMENT

The following uncertainties apply to the dimension measurements:

Length (mm)	Expanded Uncertainty on Length
3 - 300	0.05 mm

5.3 VALIDATION MEASUREMENT

The guidelines outlined in the IEEE 1528, FCC KDBs, CENELEC EN50361 and CEI/IEC 62209 standards were followed to generate the measurement uncertainty for validation measurements.

Scan Volume	Expanded Uncertainty



SAR REFERENCE DIPOLE CALIBRATION REPORT

Ref. ACR.139.4.15.SATU.A

1 g	20.3 %
10 g	20.1 %

6 CALIBRATION MEASUREMENT RESULTS

6.1 RETURN LOSS AND IMPEDANCE IN HEAD LIQUID

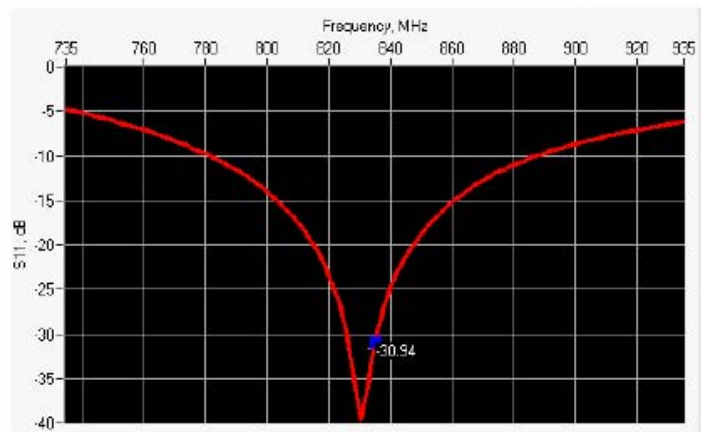

Frequency (MHz)	Return Loss (dB)	Requirement (dB)	Impedance
835	-30.94	-20	52.6 Ω + 1.1 jΩ

6.2 RETURN LOSS AND IMPEDANCE IN BODY LIQUID

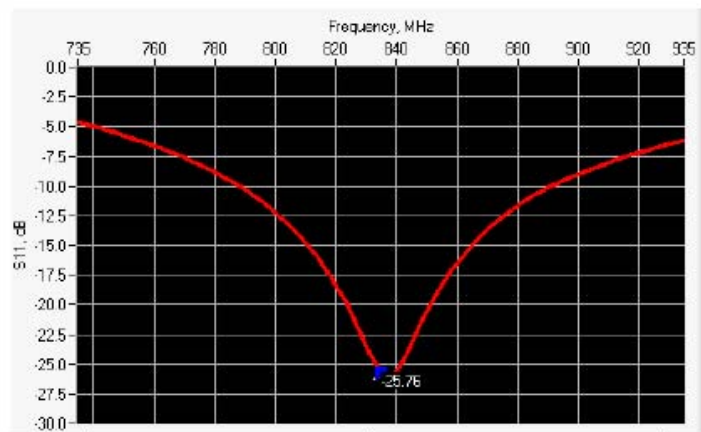

Frequency (MHz)	Return Loss (dB)	Requirement (dB)	Impedance
835	-25.76	-20	47.7 Ω + 4.6 jΩ

6.3 MECHANICAL DIMENSIONS

Frequency MHz	L mm		h mm		d mm	
	required	measured	required	measured	required	measured



SAR REFERENCE DIPOLE CALIBRATION REPORT

Ref ACR.139.4.15.SATU.A

300	420.0 ±1 %		250.0 ±1 %		6.35 ±1 %	
450	290.0 ±1 %		166.7 ±1 %		6.35 ±1 %	
750	176.0 ±1 %		100.0 ±1 %		6.35 ±1 %	
835	161.0 ±1 %	PASS	89.8 ±1 %	PASS	3.6 ±1 %	PASS
900	149.0 ±1 %		83.3 ±1 %		3.6 ±1 %	
1450	89.1 ±1 %		51.7 ±1 %		3.6 ±1 %	
1500	80.5 ±1 %		50.0 ±1 %		3.6 ±1 %	
1640	79.0 ±1 %		45.7 ±1 %		3.6 ±1 %	
1750	75.2 ±1 %		42.9 ±1 %		3.6 ±1 %	
1800	72.0 ±1 %		41.7 ±1 %		3.6 ±1 %	
1900	68.0 ±1 %		39.5 ±1 %		3.6 ±1 %	
1950	66.3 ±1 %		38.5 ±1 %		3.6 ±1 %	
2000	64.5 ±1 %		37.5 ±1 %		3.6 ±1 %	
2100	61.0 ±1 %		35.7 ±1 %		3.6 ±1 %	
2300	55.5 ±1 %		32.6 ±1 %		3.6 ±1 %	
2450	51.5 ±1 %		30.4 ±1 %		3.6 ±1 %	
2600	48.5 ±1 %		28.8 ±1 %		3.6 ±1 %	
3000	41.5 ±1 %		25.0 ±1 %		3.6 ±1 %	
3500	37.0 ±1 %		26.4 ±1 %		3.6 ±1 %	
3700	34.7 ±1 %		26.4 ±1 %		3.6 ±1 %	

7 VALIDATION MEASUREMENT

The IEEE Std. 1528, FCC KDBs and CEI/IEC 62209 standards state that the system validation measurements must be performed using a reference dipole meeting the fore mentioned return loss and mechanical dimension requirements. The validation measurement must be performed against a liquid filled flat phantom, with the phantom constructed as outlined in the fore mentioned standards. Per the standards, the dipole shall be positioned below the bottom of the phantom, with the dipole length centered and parallel to the longest dimension of the flat phantom, with the top surface of the dipole at the described distance from the bottom surface of the phantom.

7.1 HEAD LIQUID MEASUREMENT

Frequency MHz	Relative permittivity (ε _r)		Conductivity (σ) S/m	
	required	measured	required	measured
300	45.3 ±5 %		0.87 ±5 %	
450	43.5 ±5 %		0.87 ±5 %	
750	41.9 ±5 %		0.89 ±5 %	
835	41.5 ±5 %	PASS	0.90 ±5 %	PASS
900	41.5 ±5 %		0.97 ±5 %	
1450	40.5 ±5 %		1.20 ±5 %	
1500	40.4 ±5 %		1.23 ±5 %	
1640	40.2 ±5 %		1.31 ±5 %	

Page: 7/12

This document shall not be reproduced, except in full or in part, without the written approval of MVG. The information contained herein is to be used only for the purpose for which it is submitted and is not to be released in whole or part without written approval of MVG.



SAR REFERENCE DIPOLE CALIBRATION REPORT

Ref. ACR.139.4.15.SATU.A

1750	40.1 ±5 %		1.37 ±5 %	
1800	40.0 ±5 %		1.40 ±5 %	
1900	40.0 ±5 %		1.40 ±5 %	
1950	40.0 ±5 %		1.40 ±5 %	
2000	40.0 ±5 %		1.40 ±5 %	
2100	39.8 ±5 %		1.49 ±5 %	
2300	39.5 ±5 %		1.67 ±5 %	
2450	39.2 ±5 %		1.80 ±5 %	
2600	39.0 ±5 %		1.96 ±5 %	
3000	38.5 ±5 %		2.40 ±5 %	
3500	37.9 ±5 %		2.91 ±5 %	

7.2 SAR MEASUREMENT RESULT WITH HEAD LIQUID

The IEEE Std. 1528 and CEI/IEC 62209 standards state that the system validation measurements should produce the SAR values shown below (for phantom thickness of 2 mm), within the uncertainty for the system validation. All SAR values are normalized to 1 W forward power. In bracket, the measured SAR is given with the used input power.

Software	OPENSAR V4
Phantom	SN 20/09 SAM71
Probe	SN 18/11 EPG122
Liquid	Head Liquid Values: eps' : 42.3 sigma : 0.92
Distance between dipole center and liquid	15.0 mm
Area scan resolution	dx=8mm/dy=8mm
Zoon Scan Resolution	dx=8mm/dy=8mm/dz=5mm
Frequency	835 MHz
Input power	20 dBm
Liquid Temperature	21 °C
Lab Temperature	21 °C
Lab Humidity	45 %

Frequency MHz	1 g SAR (W/kg/W)		10 g SAR (W/kg/W)	
	required	measured	required	measured
300	2.85		1.94	
450	4.58		3.06	
750	8.49		5.55	
835	9.56	9.60 (0.96)	6.22	6.24 (0.62)
900	10.9		6.99	
1450	29		16	
1500	30.5		16.8	
1640	34.2		18.4	
1750	36.4		19.3	



SAR REFERENCE DIPOLE CALIBRATION REPORT

Ref: ACR.139.4.15.SATU.A

1800	38.4		20.1	
1900	39.7		20.5	
1950	40.5		20.9	
2000	41.1		21.1	
2100	43.6		21.9	
2300	48.7		23.3	
2450	52.4		24	
2600	55.3		24.6	
3000	63.8		25.7	
3500	67.1		25	

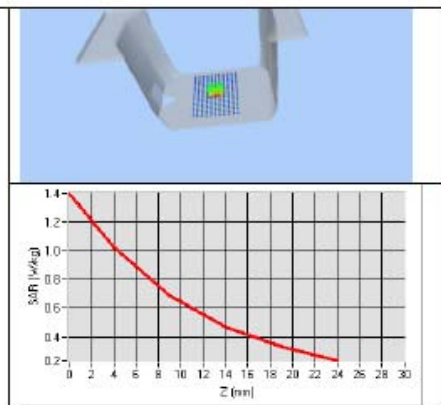
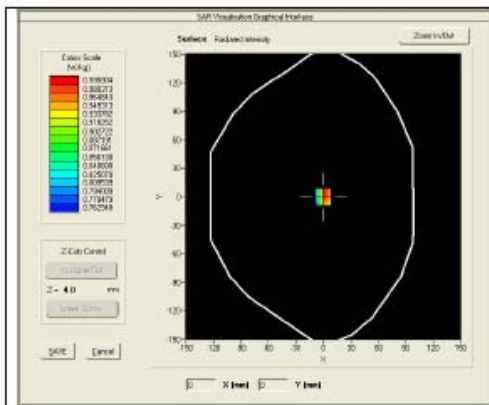

7.3 BODY LIQUID MEASUREMENT

Frequency MHz	Relative permittivity (ϵ_r')		Conductivity (σ) S/m	
	required	measured	required	measured
150	61.9 ± 5 %		0.80 ± 5 %	
300	58.2 ± 5 %		0.92 ± 5 %	
450	56.7 ± 5 %		0.94 ± 5 %	
750	55.5 ± 5 %		0.96 ± 5 %	
835	55.2 ± 5 %	PASS	0.97 ± 5 %	PASS
900	55.0 ± 5 %		1.05 ± 5 %	
915	55.0 ± 5 %		1.06 ± 5 %	
1450	54.0 ± 5 %		1.30 ± 5 %	
1610	53.8 ± 5 %		1.40 ± 5 %	
1800	53.3 ± 5 %		1.52 ± 5 %	
1900	53.3 ± 5 %		1.52 ± 5 %	
2000	53.3 ± 5 %		1.52 ± 5 %	
2100	53.2 ± 5 %		1.62 ± 5 %	

This document shall not be reproduced, except in full or in part, without the written approval of MVG. The information contained herein is to be used only for the purpose for which it is submitted and is not to be released in whole or part without written approval of MVG.



SAR REFERENCE DIPOLE CALIBRATION REPORT

Ref. ACR.139.4.15.SATU.A

2450	52.7 ±5 %		1.95 ±5 %	
2600	52.5 ±5 %		2.16 ±5 %	
3000	52.0 ±5 %		2.73 ±5 %	
3500	51.3 ±5 %		3.31 ±5 %	
5200	49.0 ±10 %		5.30 ±10 %	
5300	48.9 ±10 %		5.42 ±10 %	
5400	48.7 ±10 %		5.53 ±10 %	
5500	48.6 ±10 %		5.65 ±10 %	
5600	48.5 ±10 %		5.77 ±10 %	
5800	48.2 ±10 %		6.00 ±10 %	

7.4 SAR MEASUREMENT RESULT WITH BODY LIQUID

Software	OPENSAR V4
Phantom	SN 20/09 SAM71
Probe	SN 18/11 EPG122
Liquid	Body Liquid Values: eps' : 53.3 sigma : 0.97
Distance between dipole center and liquid	15.0 mm
Area scan resolution	dx=8mm/dy=8mm
Zoon Scan Resolution	dx=8mm/dy=8mm/dz=5mm
Frequency	835 MHz
Input power	20 dBm
Liquid Temperature	21 °C
Lab Temperature	21 °C
Lab Humidity	45 %

Frequency MHz	1 g SAR (W/kg/W)	10 g SAR (W/kg/W)
	measured	measured
835	9.48 (0.95)	6.29 (0.63)



SAR REFERENCE DIPOLE CALIBRATION REPORT

Ref. ACR.139.4.15.SATU.A

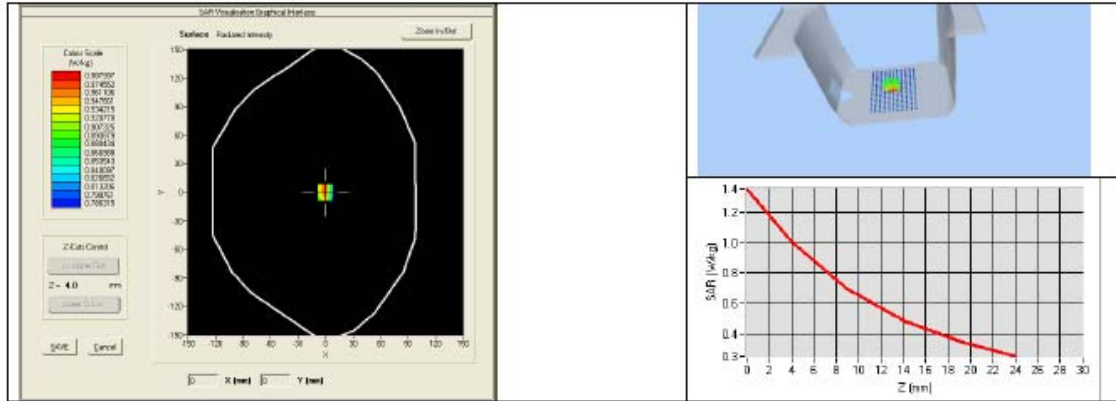



SAR REFERENCE DIPOLE CALIBRATION REPORT

Ref. ACR.139.4.15.SATU.A

8 LIST OF EQUIPMENT

Equipment Summary Sheet				
Equipment Description	Manufacturer / Model	Identification No.	Current Calibration Date	Next Calibration Date
SAM Phantom	MVG	SN-20/09-SAM71	Validated. No cal required.	Validated. No cal required.
COMOSAR Test Bench	Version 3	NA	Validated. No cal required.	Validated. No cal required.
Network Analyzer	Rhode & Schwarz ZVA	SN100132	02/2013	02/2016
Calipers	Carrera	CALIPER-01	12/2013	12/2016
Reference Probe	MVG	EPG122 SN 18/11	10/2014	10/2015
Multimeter	Keithley 2000	1188656	12/2013	12/2016
Signal Generator	Agilent E4438C	MY49070581	12/2013	12/2016
Amplifier	Aethercomm	SN 046	Characterized prior to test. No cal required.	Characterized prior to test. No cal required.
Power Meter	HP E4418A	US38261498	12/2013	12/2016
Power Sensor	HP ECP-E26A	US37181460	12/2013	12/2016
Directional Coupler	Narda 4216-20	01386	Characterized prior to test. No cal required.	Characterized prior to test. No cal required.
Temperature and Humidity Sensor	Control Company	11-661-9	8/2012	8/2015



SAR Reference Dipole Calibration Report

Ref : ACR.139.7.15.SATU.A

NTEK TESTING TECHNOLOGY CO., LTD.
BUILDING E, FENDA SCIENCE PARK, SANWEI
COMMUNITY, XIXIANG STREET,
BAO'AN DISTRICT, SHENZHEN GUANGDONG, CHINA
MVG COMOSAR REFERENCE DIPOLE
FREQUENCY: 1900 MHZ
SERIAL NO.: SN 03/15 DIP 1G900-350

Calibrated at MVG US
2105 Barrett Park Dr. - Kennesaw, GA 30144



04/06/2015

Summary:

This document presents the method and results from an accredited SAR reference dipole calibration performed in MVG USA using the COMOSAR test bench. All calibration results are traceable to national metrology institutions.



SAR REFERENCE DIPOLE CALIBRATION REPORT

Ref: ACR.139.7.15.SATU.A

	<i>Name</i>	<i>Function</i>	<i>Date</i>	<i>Signature</i>
<i>Prepared by :</i>	Jérôme LUC	Product Manager	5/19/2015	<i>JS</i>
<i>Checked by :</i>	Jérôme LUC	Product Manager	5/19/2015	<i>JS</i>
<i>Approved by :</i>	Kim RUTKOWSKI	Quality Manager	5/19/2015	<i>Kim Rutkowski</i>

	<i>Customer Name</i>
<i>Distribution :</i>	NTEK TESTING TECHNOLOGY CO., LTD.

<i>Issue</i>	<i>Date</i>	<i>Modifications</i>
A	5/19/2015	Initial release



TABLE OF CONTENTS

1	Introduction.....	4
2	Device Under Test.....	4
3	Product Description.....	4
3.1	General Information.....	4
4	Measurement Method.....	5
4.1	Return Loss Requirements.....	5
4.2	Mechanical Requirements.....	5
5	Measurement Uncertainty.....	5
5.1	Return Loss.....	5
5.2	Dimension Measurement.....	5
5.3	Validation Measurement.....	5
6	Calibration Measurement Results.....	6
6.1	Return Loss and Impedance In Head Liquid.....	6
6.2	Return Loss and Impedance In Body Liquid.....	6
6.3	Mechanical Dimensions.....	6
7	Validation measurement.....	7
7.1	Head Liquid Measurement.....	7
7.2	SAR Measurement Result With Head Liquid.....	8
7.3	Body Liquid Measurement.....	9
7.4	SAR Measurement Result With Body Liquid.....	10
8	List of Equipment.....	11



1 INTRODUCTION

This document contains a summary of the requirements set forth by the IEEE 1528, FCC KDBs and CEI/IEC 62209 standards for reference dipoles used for SAR measurement system validations and the measurements that were performed to verify that the product complies with the fore mentioned standards.

2 DEVICE UNDER TEST

Device Under Test	
Device Type	COMOSAR 1900 MHz REFERENCE DIPOLE
Manufacturer	MVG
Model	SID1900
Serial Number	SN 03/15 DIP 1G900-350
Product Condition (new / used)	New

A yearly calibration interval is recommended.

3 PRODUCT DESCRIPTION

3.1 GENERAL INFORMATION

MVG's COMOSAR Validation Dipoles are built in accordance to the IEEE 1528, FCC KDBs and CEI/IEC 62209 standards. The product is designed for use with the COMOSAR test bench only.



Figure 1 – MVG COMOSAR Validation Dipole



4 MEASUREMENT METHOD

The IEEE 1528, FCC KDBs and CEI/IEC 62209 standards provide requirements for reference dipoles used for system validation measurements. The following measurements were performed to verify that the product complies with the fore mentioned standards.

4.1 RETURN LOSS REQUIREMENTS

The dipole used for SAR system validation measurements and checks must have a return loss of -20 dB or better. The return loss measurement shall be performed against a liquid filled flat phantom, with the phantom constructed as outlined in the fore mentioned standards.

4.2 MECHANICAL REQUIREMENTS

The IEEE Std. 1528 and CEI/IEC 62209 standards specify the mechanical components and dimensions of the validation dipoles, with the dimensions frequency and phantom shell thickness dependent. The COMOSAR test bench employs a 2 mm phantom shell thickness therefore the dipoles sold for use with the COMOSAR test bench comply with the requirements set forth for a 2 mm phantom shell thickness.

5 MEASUREMENT UNCERTAINTY

All uncertainties listed below represent an expanded uncertainty expressed at approximately the 95% confidence level using a coverage factor of k=2, traceable to the Internationally Accepted Guides to Measurement Uncertainty.

5.1 RETURN LOSS

The following uncertainties apply to the return loss measurement:

Frequency band	Expanded Uncertainty on Return Loss
400-6000MHz	0.1 dB

5.2 DIMENSION MEASUREMENT

The following uncertainties apply to the dimension measurements:

Length (mm)	Expanded Uncertainty on Length
3 - 300	0.05 mm

5.3 VALIDATION MEASUREMENT

The guidelines outlined in the IEEE 1528, FCC KDBs, CENELEC EN50361 and CEI/IEC 62209 standards were followed to generate the measurement uncertainty for validation measurements.

Scan Volume	Expanded Uncertainty
1 g	20.3 %



SAR REFERENCE DIPOLE CALIBRATION REPORT

Ref: ACR.139.7.15.SATU.A

10 g	20.1 %
------	--------

6 CALIBRATION MEASUREMENT RESULTS

6.1 RETURN LOSS AND IMPEDANCE IN HEAD LIQUID

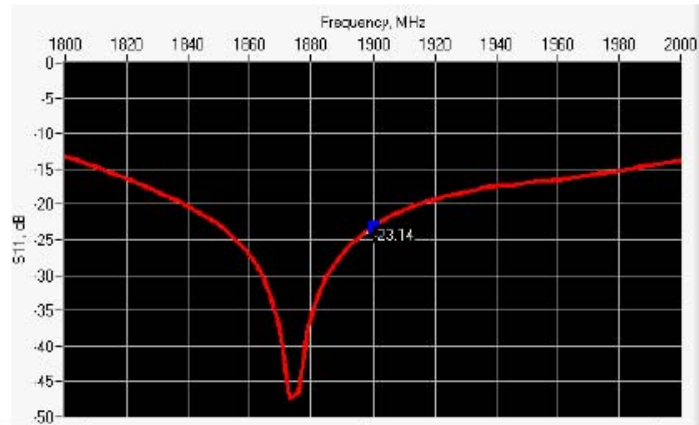

Frequency (MHz)	Return Loss (dB)	Requirement (dB)	Impedance
1900	-23.14	-20	53.6 Ω + 5.9 jΩ

6.2 RETURN LOSS AND IMPEDANCE IN BODY LIQUID

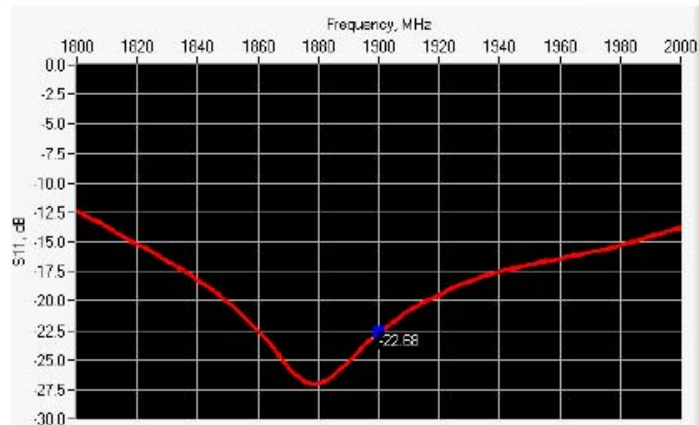

Frequency (MHz)	Return Loss (dB)	Requirement (dB)	Impedance
1900	-22.68	-20	49.3 Ω + 7.3 jΩ

6.3 MECHANICAL DIMENSIONS

Frequency MHz	L mm		h mm		d mm	
	required	measured	required	measured	required	measured
300	420.0 ±1 %		250.0 ±1 %		6.35 ±1 %	



SAR REFERENCE DIPOLE CALIBRATION REPORT

Ref. ACR.139.7.15.SATU.A

450	290.0 ±1 %.		166.7 ±1 %.		6.35 ±1 %.	
750	176.0 ±1 %.		100.0 ±1 %.		6.35 ±1 %.	
835	161.0 ±1 %.		89.8 ±1 %.		3.6 ±1 %.	
900	149.0 ±1 %.		83.3 ±1 %.		3.6 ±1 %.	
1450	89.1 ±1 %.		51.7 ±1 %.		3.6 ±1 %.	
1500	80.5 ±1 %.		50.0 ±1 %.		3.6 ±1 %.	
1640	79.0 ±1 %.		45.7 ±1 %.		3.6 ±1 %.	
1750	75.2 ±1 %.		42.9 ±1 %.		3.6 ±1 %.	
1800	72.0 ±1 %.		41.7 ±1 %.		3.6 ±1 %.	
1900	68.0 ±1 %.	PASS	39.5 ±1 %.	PASS	3.6 ±1 %.	PASS
1950	66.3 ±1 %.		38.5 ±1 %.		3.6 ±1 %.	
2000	64.5 ±1 %.		37.5 ±1 %.		3.6 ±1 %.	
2100	61.0 ±1 %.		35.7 ±1 %.		3.6 ±1 %.	
2300	55.5 ±1 %.		32.6 ±1 %.		3.6 ±1 %.	
2450	51.5 ±1 %.		30.4 ±1 %.		3.6 ±1 %.	
2600	48.5 ±1 %.		28.8 ±1 %.		3.6 ±1 %.	
3000	41.5 ±1 %.		25.0 ±1 %.		3.6 ±1 %.	
3500	37.0 ±1 %.		26.4 ±1 %.		3.6 ±1 %.	
3700	34.7 ±1 %.		26.4 ±1 %.		3.6 ±1 %.	

7 VALIDATION MEASUREMENT

The IEEE Std. 1528, FCC KDBs and CEI/IEC 62209 standards state that the system validation measurements must be performed using a reference dipole meeting the fore mentioned return loss and mechanical dimension requirements. The validation measurement must be performed against a liquid filled flat phantom, with the phantom constructed as outlined in the fore mentioned standards. Per the standards, the dipole shall be positioned below the bottom of the phantom, with the dipole length centered and parallel to the longest dimension of the flat phantom, with the top surface of the dipole at the described distance from the bottom surface of the phantom.

7.1 HEAD LIQUID MEASUREMENT

Frequency MHz	Relative permittivity (ε _r)		Conductivity (σ) S/m	
	required	measured	required	measured
300	45.3 ±5 %		0.87 ±5 %	
450	43.5 ±5 %		0.87 ±5 %	
750	41.9 ±5 %		0.89 ±5 %	
835	41.5 ±5 %		0.90 ±5 %	
900	41.5 ±5 %		0.97 ±5 %	
1450	40.5 ±5 %		1.20 ±5 %	
1500	40.4 ±5 %		1.23 ±5 %	
1640	40.2 ±5 %		1.31 ±5 %	
1750	40.1 ±5 %		1.37 ±5 %	

Page: 7/11

This document shall not be reproduced, except in full or in part, without the written approval of MVG. The information contained herein is to be used only for the purpose for which it is submitted and is not to be released in whole or part without written approval of MVG.



SAR REFERENCE DIPOLE CALIBRATION REPORT

Ref: ACR.139.7.15.SATU.A

1800	40.0 ±5 %		1.40 ±5 %	
1900	40.0 ±5 %	PASS	1.40 ±5 %	PASS
1950	40.0 ±5 %		1.40 ±5 %	
2000	40.0 ±5 %		1.40 ±5 %	
2100	39.8 ±5 %		1.49 ±5 %	
2300	39.5 ±5 %		1.67 ±5 %	
2450	39.2 ±5 %		1.80 ±5 %	
2600	39.0 ±5 %		1.96 ±5 %	
3000	38.5 ±5 %		2.40 ±5 %	
3500	37.9 ±5 %		2.91 ±5 %	

7.2 SAR MEASUREMENT RESULT WITH HEAD LIQUID

The IEEE Std. 1528 and CEI/IEC 62209 standards state that the system validation measurements should produce the SAR values shown below (for phantom thickness of 2 mm), within the uncertainty for the system validation. All SAR values are normalized to 1 W forward power. In bracket, the measured SAR is given with the used input power.

Software	OPENSAR V4
Phantom	SN 20/09 SAM71
Probe	SN 18/11 EPG122
Liquid	Head Liquid Values: eps' : 40.4 sigma : 1.41
Distance between dipole center and liquid	10.0 mm
Area scan resolution	dx=8mm/dy=8mm
Zoon Scan Resolution	dx=8mm/dy=8mm/dz=5mm
Frequency	1900 MHz
Input power	20 dBm
Liquid Temperature	21 °C
Lab Temperature	21 °C
Lab Humidity	45 %

Frequency MHz	1 g SAR (W/kg/W)		10 g SAR (W/kg/W)	
	required	measured	required	measured
300	2.85		1.94	
450	4.58		3.06	
750	8.49		5.55	
835	9.56		6.22	
900	10.9		6.99	
1450	29		16	
1500	30.5		16.8	
1640	34.2		18.4	
1750	36.4		19.3	
1800	38.4		20.1	



SAR REFERENCE DIPOLE CALIBRATION REPORT

Ref. ACR.139.7.15.SATU.A

1900	39.7	39.32 (3.93)	20.5	20.53 (2.05)
1950	40.5		20.9	
2000	41.1		21.1	
2100	43.6		21.9	
2300	48.7		23.3	
2450	52.4		24	
2600	55.3		24.6	
3000	63.8		25.7	
3500	67.1		25	

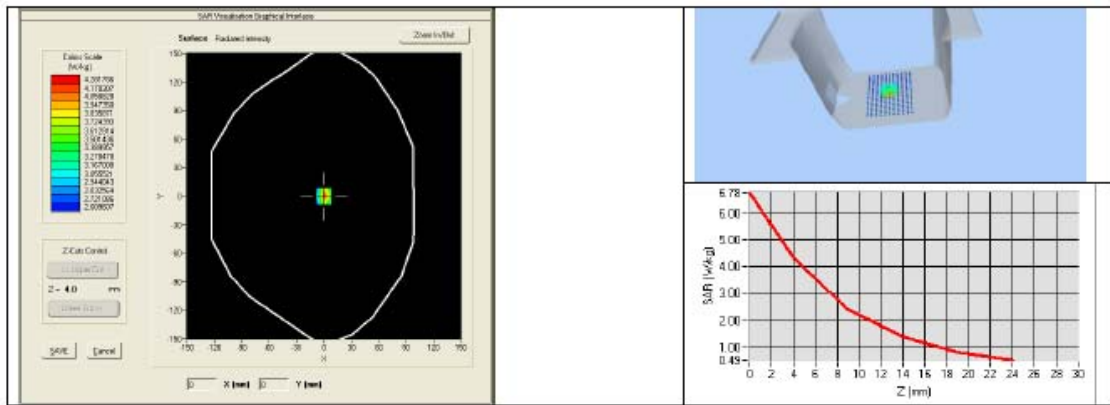

7.3 BODY LIQUID MEASUREMENT

Frequency MHz	Relative permittivity (ϵ_r')		Conductivity (σ) S/m	
	required	measured	required	measured
150	61.9 ±5 %		0.80 ±5 %	
300	58.2 ±5 %		0.92 ±5 %	
450	56.7 ±5 %		0.94 ±5 %	
750	55.5 ±5 %		0.96 ±5 %	
835	55.2 ±5 %		0.97 ±5 %	
900	55.0 ±5 %		1.05 ±5 %	
915	55.0 ±5 %		1.06 ±5 %	
1450	54.0 ±5 %		1.30 ±5 %	
1610	53.8 ±5 %		1.40 ±5 %	
1800	53.3 ±5 %		1.52 ±5 %	
1900	53.3 ±5 %	PASS	1.52 ±5 %	PASS
2000	53.3 ±5 %		1.52 ±5 %	
2100	53.2 ±5 %		1.62 ±5 %	
2450	52.7 ±5 %		1.95 ±5 %	

Page: 9/11

This document shall not be reproduced, except in full or in part, without the written approval of MVG. The information contained herein is to be used only for the purpose for which it is submitted and is not to be released in whole or part without written approval of MVG.



SAR REFERENCE DIPOLE CALIBRATION REPORT

Ref. ACR.139.7.15.SATU.A

2600	52.5 ±5 %		2.16 ±5 %	
3000	52.0 ±5 %		2.73 ±5 %	
3500	51.3 ±5 %		3.31 ±5 %	
5200	49.0 ±10 %		5.30 ±10 %	
5300	48.9 ±10 %		5.42 ±10 %	
5400	48.7 ±10 %		5.53 ±10 %	
5500	48.6 ±10 %		5.65 ±10 %	
5600	48.5 ±10 %		5.77 ±10 %	
5800	48.2 ±10 %		6.00 ±10 %	

7.4 SAR MEASUREMENT RESULT WITH BODY LIQUID

Software	OPENSAR V4
Phantom	SN 20/09 SAM71
Probe	SN 18/11 EPG122
Liquid	Body Liquid Values: eps' : 53.9 sigma : 1.55
Distance between dipole center and liquid	10.0 mm
Area scan resolution	dx=8mm/dy=8mm
Zoon Scan Resolution	dx=8mm/dy=8mm/dz=5mm
Frequency	1900 MHz
Input power	20 dBm
Liquid Temperature	21 °C
Lab Temperature	21 °C
Lab Humidity	45 %

Frequency MHz	1 g SAR (W/kg/W)	10 g SAR (W/kg/W)
	measured	measured
1900	38.43 (3.84)	20.34 (2.03)

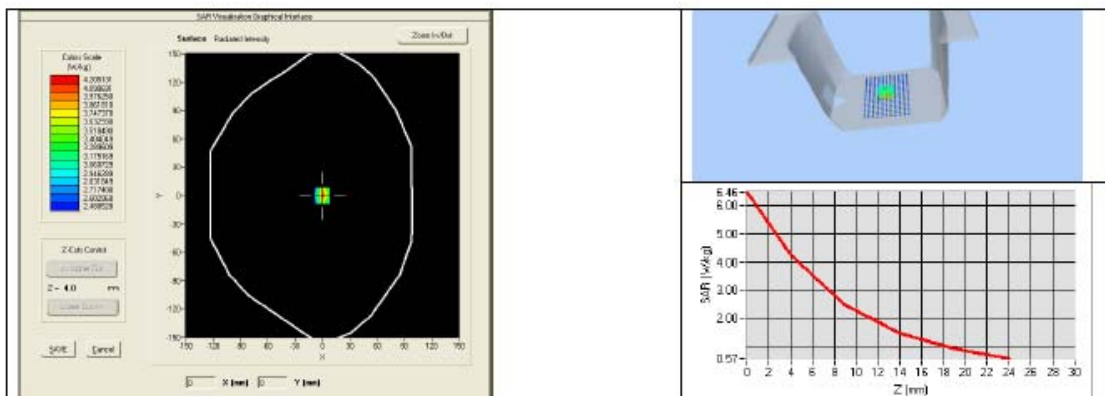



8 LIST OF EQUIPMENT

Equipment Summary Sheet				
Equipment Description	Manufacturer / Model	Identification No.	Current Calibration Date	Next Calibration Date
SAM Phantom	MVG	SN-20/09-SAM71	Validated. No cal required.	Validated. No cal required.
COMOSAR Test Bench	Version 3	NA	Validated. No cal required.	Validated. No cal required.
Network Analyzer	Rhode & Schwarz ZVA	SN100132	02/2013	02/2016
Calipers	Carrera	CALIPER-01	12/2013	12/2016
Reference Probe	MVG	EPG122 SN 18/11	10/2014	10/2015
Multimeter	Keithley 2000	1188656	12/2013	12/2016
Signal Generator	Agilent E4438C	MY49070581	12/2013	12/2016
Amplifier	Aethercomm	SN 046	Characterized prior to test. No cal required.	Characterized prior to test. No cal required.
Power Meter	HP E4418A	US38261498	12/2013	12/2016
Power Sensor	HP ECP-E26A	US37181460	12/2013	12/2016
Directional Coupler	Narda 4216-20	01386	Characterized prior to test. No cal required.	Characterized prior to test. No cal required.
Temperature and Humidity Sensor	Control Company	11-661-9	8/2012	8/2015

END