

SUNWAVE

INSTALLATION MANUAL



CROSSFIRE

M2RU

MID POWER

4T4R Digital Radios
37dBm per Band
5G NR Compliant
Passive Cooling
Outdoor Rated



Revision History

Revision Number	Revision Date	Summary of Changes	Author
1.0.0	5 th October 2020	Initial Release	Shuochao Zheng
1.0.1	25 th May 2021	Add Fan Installation	Shuochao Zheng
2.0.0	15 th November 2021	Upgrade System to Support 800MHz Mode	Shuochao Zheng
2.0.1	23 rd November 2021	Add M2RU-PSU48S Installation	Shuochao Zheng

Copyright © 2022 Sunwave All rights reserved.

No part of this publication may be reproduced, transmitted, transcribed, stored in a retrieval system, or translated into any language, in any form or by any means, electronic, mechanical, photocopying, recording, or otherwise, without prior written permission from Sunwave.

All copyright, confidential information, patents, design rights, and all other intellectual property rights of whatsoever nature contained herein are and shall remain the sole and exclusive property of Sunwave. The information furnished herein is believed to be accurate and reliable.

However, no responsibility is assumed by Sunwave for its use or any infringements of patents or other rights of third parties resulting from its use.

The Sunwave and CrossFire names and logos are trademarks or registered trademarks of Sunwave.

All other trademarks are the property of their respective owners.



MID POWER

4 x 37dBm Output
5G NR Compli

Content

Preface	5
Safety Instructions	5
Site Considerations	7
Environmental Considerations.....	7
DC Power Connections.....	8
Warning Marks.....	9
Unpacking and Inspecting.....	10
Inspecting the Packing Container	10
Unpacking the Device	10
Verifying the Contents	10
Inspecting the Device.....	11
Site Investigation.....	11
Installation Tools.....	11
Torque Settings	11
Clearance.....	11
Tools.....	12
Installing the Access Unit (A2)	13
Accessories List	13
Rack Installation	14
Fan Installation.....	17
Wall Installation	19
A2 Mounting Dimension Spacing.....	22
RF Connection	23
Installation of the E2-O	23
Mount the E2-O in the Rack.....	24
E2-O Accessories	24
Attach E2-O Handle.....	25
Attach Sliding Rails and E2-O to Rack	25
Connect Power and Ground Cable to E2-O.....	26
Mount the E2-O on the Wall.....	27
Attach Handle to E2-O	27

Contact us today:
www.sunwave.com
cf_support@sunwave.com



© Sunwave IM_CF_M2 v2.0.1 | 3 of 51



MID POWER

4 x 37dBm Output
5G NR Compli

Mount E2-O to Wall	27
Connect Power and Ground Cable to E2-O.....	28
E2-O Mounting Dimension Spacing	29
Installing the Mid Power Remote Unit (M2RU).....	30
Accessories List	30
Wall Installation (Back on the Wall).....	31
Wall Installation (Side on the Wall)	36
Pole Installation	40
M2RU-PSU48S Installation.....	41
Accessories.....	41
Installation Procedure.....	41
M2RU Mounting Dimension Spacing.....	44
Optical Connection.....	45
Optical Transceiver Module	45
Single Port Bidirectional SFP Transceiver.....	45
Dual Port SFP Transceiver	45
Optical Indicator.....	46
A2 Optical Port Description.....	47
E2-O Optical Port Description	47
RU Optical Port Description	49



MID POWER

4 x 37dBm Output
5G NR Compli

Preface

Safety Instructions

 All the following “Safety Precautions” must be observed during the entire installation and operation of the CrossFire system.

The CrossFire system components are designed for maximum safety and reliability when they are installed, used, and maintained by trained and qualified technicians in accordance with the procedures and instructions contained in this manual. To assure the safe operation of your system, always follow the safety and operational recommendations in this manual.

1. M2RU is not a consumer product. Please install and use M2RU in accordance with the instructions.
2. Before installing or modifying any M2RU equipment, read and fully understand the entire instructions in this guide.
3. Only qualified personnel are authorized to install and maintain the M2RU.
4. Changes or modifications to the M2RU equipment not expressly approved by the manufacturer could void the product warranty and the user’s authority to operate the equipment.
5. The shells of the device have protective ground terminals. During installation, connect the ground terminals securely to the protective building ground with yellow and green conductors or with braided ground wire. The aerial and feeder must be adequately grounded.
6. The power source must be within the required range of the device. The rated voltage range for the AC power supply system is 100 ~ 240VAC, and the rated frequency range is 50Hz / 60Hz. The rated power of the A2, E2-O, and M2RU is 80W, 60W, and 150W, respectively. The ground terminal of the three-core power socket used at the device installation site must be securely connected to the protective building ground.
7. To avoid injuries or damage, use care, and obtain assistance before lifting any heavy system components or equipment.
8. While fiber optic power levels used in this system are very low, it is advisable to avoid exposing the human eye to the laser light emanating from a fiber port or plug.
9. Signals coupled from the BTS shall be no greater than +15dBm, otherwise, the device will not operate normally, and damage may occur to the circuit.
10. Reserve at least 40mm of height above the radiation fins during device installation; otherwise, the device temperature may rise and affect the service life of the device.
11. Follow Electro Static Discharge precautions to avoid any damage to PCB, PSU, etc.
12. Keep equipment powered-off during installing or modifying.
13. Low path loss cables connected to antennas are highly recommended.
14. This is NOT a CONSUMER device. It is designed for installation by FCC LICENSEES and QUALIFIED INSTALLERS. You MUST have an FCC LICENSE or express consent of an FCC License to operate this device. Unauthorized use may result in significant forfeiture penalties, including penalties in excess of \$100,000 for each continuing violation.
15. This is NOT a CONSUMER device. It is designed for installation by an installer approved by an ISED licensee. You MUST have an ISED LICENCE or the express consent of an ISED licensee to operate this device.

Contact us today:
www.sunwave.com
cf_support@sunwave.com

SUNWAVE

© Sunwave IM_CF_M2 v2.0.1 | 5 of 51



MID POWER

4 x 37dBm Output
5G NR Compli

16. To comply with FCC RF exposure compliance requirements, each individual antenna used for this transmitter must be installed to provide a separation distance greater than 100cm or more from all persons during normal operation and must not be co-located with any other antenna for meeting RF exposure requirements.

17. Antenna gain should not exceed 6 dBi.

NOTE: This device complies with Part 15 of the FCC Rules. Operation is subject to the following two conditions: (1) this device may not cause harmful interference, and (2) this device must accept any interference received, including interference that may cause undesired operation.

NOTE: This equipment has been tested and found to comply with the limits for a Class B digital device, pursuant to Part 15 of the FCC Rules. These limits are designed to provide reasonable protection against harmful interference in a residential installation. This equipment generates uses and can radiate radio frequency energy and, if not installed and used in accordance with the instructions, may cause harmful interference to radio communications. However, there is no guarantee that interference will not occur in a particular installation.

If this equipment does cause harmful interference to radio or television reception, which can be determined by turning the equipment off and on, the user is encouraged to try to correct the interference by one or more of the following measures:

- Reorient or relocate the receiving antenna.
- Increase the separation between the equipment and receiver.
- Connect the equipment into an outlet on a circuit different from that to which the receiver is connected.
- Consult the dealer or an experienced radio/TV technician for help.

NOTE: Only authorized person can enter the area where the antenna is installed. And the person is fully aware of the potential for exposure and can exercise control over his or her exposure by leaving the area or by some other appropriate means. Awareness of the potential for RF exposure in a workplace or similar environment can be provided through specific training as part of a RF safety program

NOTE: This device complies with Industry Canada license-exempt RSS standard(s). Operation is subject to the following two conditions: (1) this device may not cause interference, and (2) this device must accept any interference, including interference that may cause undesired operation of the device.

Le présent appareil est conforme aux CNR d'Industrie Canada applicables aux appareils radio exempts de licence. L'exploitation est autorisée aux deux conditions suivantes : (1) l'appareil ne doit pas produire de brouillage, et (2) l'utilisateur de l'appareil doit accepter tout brouillage radioélectrique subi, même si le brouillage est susceptible d'en compromettre le fonctionnement.

This equipment complies with IC RSS-102 radiation exposure limits set forth for an uncontrolled environment. This equipment should be installed and operated with minimum distance 100cm between the radiator and your body.

Cet équipement est conforme aux limites d'exposition aux radiations IC CNR-102 établies pour un environnement non contrôlé. Cet équipement doit être installé et utilisé avec une distance minimale de 100cm entre le radiateur et votre corps.

Contact us today:
www.sunwave.com
cf_support@sunwave.com

SUNWAVE

© Sunwave IM_CF_M2 v2.0.1 | 6 of 51



MID POWER

4 x 37dBm Output
5G NR Compli

Site Considerations

1. CrossFire complies with FCC RF exposure limits for an uncontrolled environment.
2. The system delay should be taken into consideration when there are neighboring BTS sites that are overlapping in coverage. Normal use of the system will not damage the base station; however, with the increase of RU during network coverage for indoor distribution, the uplink output noise level may affect the sensitivity of the base station, which should be considered during engineering design. Pick an ideal easy-to-reach location for installation convenience.
3. Pick an ideal easy-to-reach location for installation convenience.
4. Verify that there is a minimum of a 100cm radius of space around CrossFire equipment for the convenience of maintenance and on-site inspection.
5. Install CrossFire close to the service area for monitor and debugging.

Environmental Considerations

Humidity and temperature can adversely affect reliability of the CrossFire system. Therefore, it is highly recommended to install the equipment in locations with stable humidity, temperature, and ventilating.

The equipment has to operate at humidity level and temperature range as follow:

- ✧ Maximum humidity (M2RU): 100% (Non-Condensing)
- ✧ Operating Temperature range (A2/E2-O): -10°C to +50°C
- ✧ Operating Temperature range (M2RU): -40°C to +55°C
- ✧ Storage Temperature range: -25°C to +70°C

DC Power Connections

Referring to the diagram, connect the power cables as follows:

Higher voltage wire linked to **RED** cable / Lower voltage wire linked to **BLUE** cable.

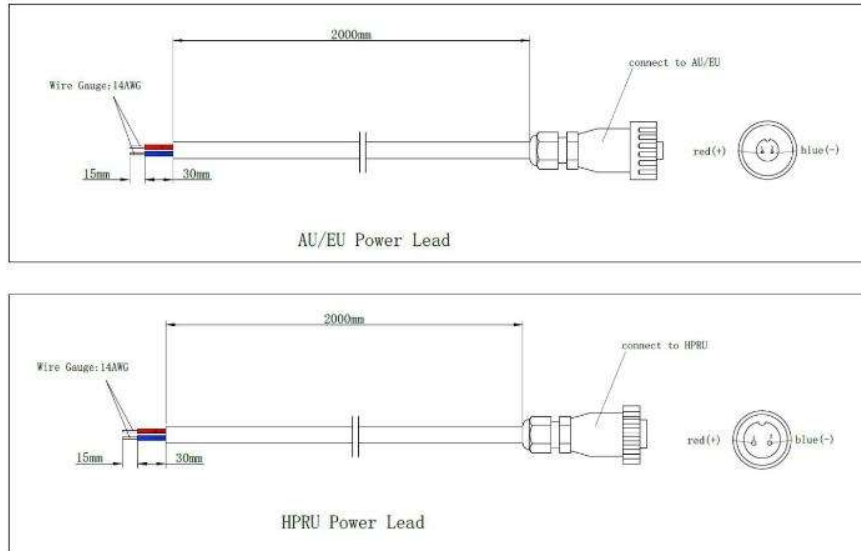

- ✧ Connect “+” to a high potential (+48VDC from a +48VDC power supply; 0VDC from a -48VDC power supply)
- ✧ Connect “-” to a low potential (0VDC from a +48VDC power supply; -48VDC from a -48VDC power supply)



Cable Core	Cable Length	Maximum Expandable Length
14AWG	2m	10m

Warning Marks

The warning marks on the CrossFire shell should be kept clean, readable, and identifiable.



ALWAYS disconnect all lines and power connections before servicing or disassembling this equipment.



NEVER touch the surface after the device's power on.



For performance and safety reasons, **NEVER** disassemble and remodel the devices.



Installation Preparation

Unpacking and Inspecting

This section discusses the procedures for receiving the shipment, inspecting the packing container, unpacking, and inspecting the device.

Inspecting the Packing Container

Handle the packing container carefully. Inspect the packing container immediately on arrival at the installation site to verify that no obvious damage occurred during shipment. Ensure that the container is sound and that the waterproof and vibration warning notices are still obvious. If possible, always inspect the equipment in the presence of the delivery person.

If any damage is observed:

1. Do not open or unpack the container.
2. Immediately contact the transportation carrier and notify them of the damage.
3. File a claim with the carrier once you determine the extent of any damage.
4. Return it to SUNWAVE's nearest RMA facility and contact SUNWAVE for RMA processing.

Unpacking the Device

If the container appears to be in satisfactory condition:

1. Ensure both user and supplier representatives are in attendance during shipment inspection.
2. Confirm where you will store the device.
3. Ensure procedures are in place to handle the device and other equipment properly.
4. Ensure the following tools are available to unpack the shipment: hammer, paper cutter, and crowbar.
5. Open the packing container carefully. The device is contained in a protective package inside the packing container; however, caution is still necessary so as not to damage the internal package and device.
6. Remove the internal package from the packing container.
7. Unpack the device from the internal package carefully.

Verifying the Contents

To verify the contents of the package:

1. Verify that the contents and quantities agree with the Delivery Packing List.
2. Check the device model against the Delivery Packing List.
3. Notify SUNWAVE immediately if any discrepancies are discovered, to verify whether the complete and correct shipment has been received.



MID POWER

4 x 37dBm Output
5G NR Compli

Inspecting the Device

After unpacking the device, place the device on solid ground and check the following to ensure the device has not been damaged:

1. Inspect the device's appearance, overall dimensions, and weight.
2. Check that the device has not been deformed or bent in any way.
3. Check that there are no warps, scratches, bubbles, or dirt marks.
4. Check that there are no loose, missing or incorrectly fastened screws.
5. Check that the installation slots in the cabinet sub-rack are rectangular.
6. Ensure that the guide bar has not been damaged and the fittings and auxiliary parts are intact.
7. Check that the silk-screened images on the device are visible and intact.

Site Investigation

Before installation, the installer should contact the project director to ensure that the site is suitable for installation. Details required include information about the installation site, such as whether there is an iron tower or high mast nearby, the surrounding environmental conditions such as temperature and humidity, the power source, and so on. Installation staff should complete a site investigation with the project director before construction and conduct field observation of the installation site and the coverage area of the device, to confirm factors such as signal intensity, signal quality, the required coverage range, device location, antenna-feeder system, and power supply system.

Note: Only maintenance personnel or users who understand the reason for access and are experienced with restricted area access and understand the necessary preventive measures should access the installation site.

Installation Tools

The following equipment and tools are required for a successful installation:

Electric percussion drill / Screwdriver / Wrench

Torque Settings

Type	M3	M6	M10
Specified Torques	0.6Nm	5Nm	50Nm

Clearance

You must ensure the following mounting clearances for mounting within a 19" rack/cabinet:

✧ FAN Cooling:

You can mount the fan between the bottom of the device and any other.

Maintain 2U clearance between the bottom of the device and any other.

You must ensure the following mounting clearances for wall mounting:

Contact us today:

www.sunwave.com

cf_support@sunwave.com

© Sunwave IM_CF_M2 v2.0.1 | 11 of 51



MID POWER

4 x 37dBm Output
5G NR Compli

✧ Convection cooling:

Maintain 150mm clearance from the bottom of the device to any other planar obstructions.

Maintain 150mm clearance from the top of the device to any other planar.

Maintain 150mm clearance from both sides of the device to any other planar obstructions.

Tools

Electric drill, cross head screwdriver, side cutters, ladder, and other tools are needed for M2RU installation which is not offered from Mavenir for now. Customers to provide these tools themselves.



Drilling Machine



Pen



Allen Wrench T5



Combination
Spanner 17mm



Nut M10 and M12







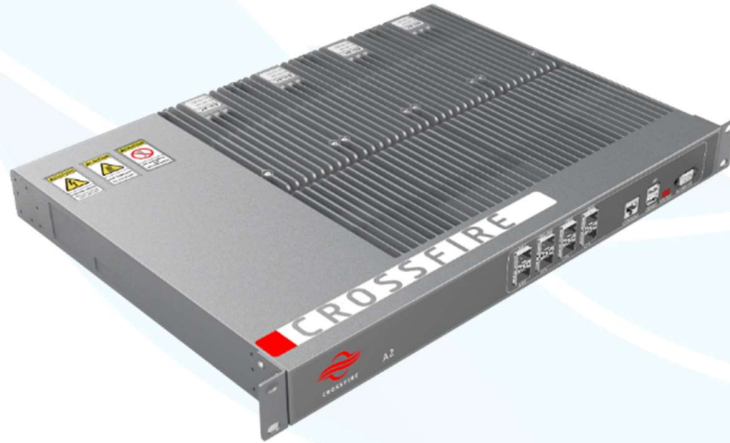

MID POWER

4 x 37dBm Output
5G NR Compli

Installing the Access Unit (A2)



Accessories List

① Screw M6*16	② Screw M3*6
	
③ Suspension Loop	④ AC Power Lead 2.5m
	
⑤ CAT-5 Cable 1.5m	⑥ Ground Wire 2m
	

Contact us today:
www.sunwave.com
cf_support@sunwave.com

SUNWAVE

© Sunwave IM_CF_M2 v2.0.1 | 13 of 51

Rack Installation

The Access Unit is a 19" 1U equipment shelf. When installing the Access Unit in a rack, make sure the mechanical loading of the rack is even to avoid a hazardous condition. The rack should safely support the combined weight of all the equipment and be securely anchored. Installing the Access Unit in a climate-controlled room with sufficient air circulation is recommended as the maximum ambient temperature is +50°C.

To install the Access Unit in the equipment rack.

1. Attach the 19" mounting brackets at the front of the A2, using 4 screws M3×6 per bracket and the Phillips screwdriver. Observe the orientation of the brackets.

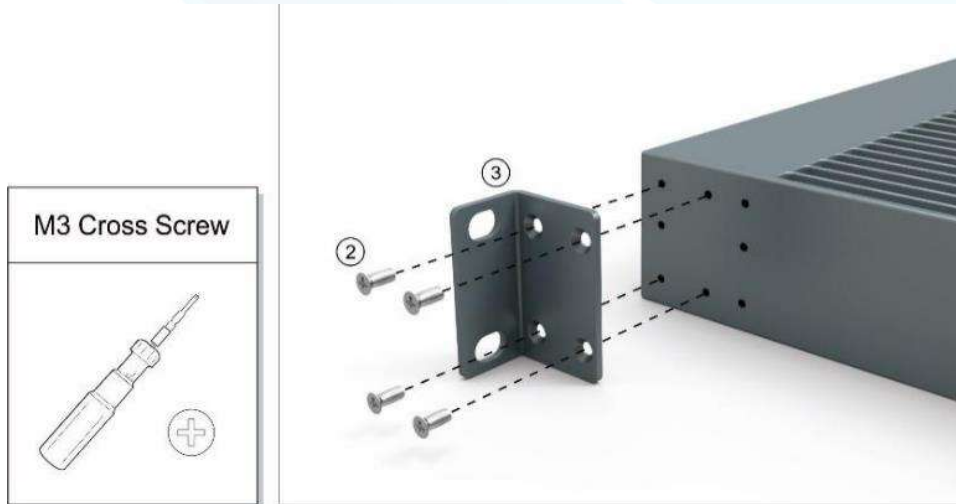

2. Recommended attaching the sliding rails to rack. (Not included in delivery).





MID POWER

4 x 37dBm Output
5G NR Compli

- Place the A2 in the rack and secure the A2 using 2 screws M6×16 on both side and the Phillips screwdriver.



- Install the fan for cooling if multiple A2s are installed in the same rack.

⚠ It is necessary to allow at least 3 rack unit (132mm) of free space below each unit for heat dissipation without fan installed or 1 rack unit (44mm) of free space below each unit with fan occupied in the middle.
Otherwise, the device temperature may rise and affect the service life of the device.



- Connect and lock the power cable at the A2 rear side.

Contact us today:
www.sunwave.com
cf_support@sunwave.com

SUNWAVE

© Sunwave IM_CF_M2 v2.0.1 | 15 of 51



MID POWER

4 x 37dBm Output
5G NR Compli

6. Connect and screw the ground wire at the A2 rear side.



Contact us today:
www.sunwave.com
cf_support@sunwave.com

SUNWAVE

© Sunwave IM_CF_M2 v2.0.1 | 16 of 51



MID POWER

4 x 37dBm Output
5G NR Compli

Fan Installation

1. Secure the Fan using 2 screws M6×16 on both sides and the Phillips screwdriver

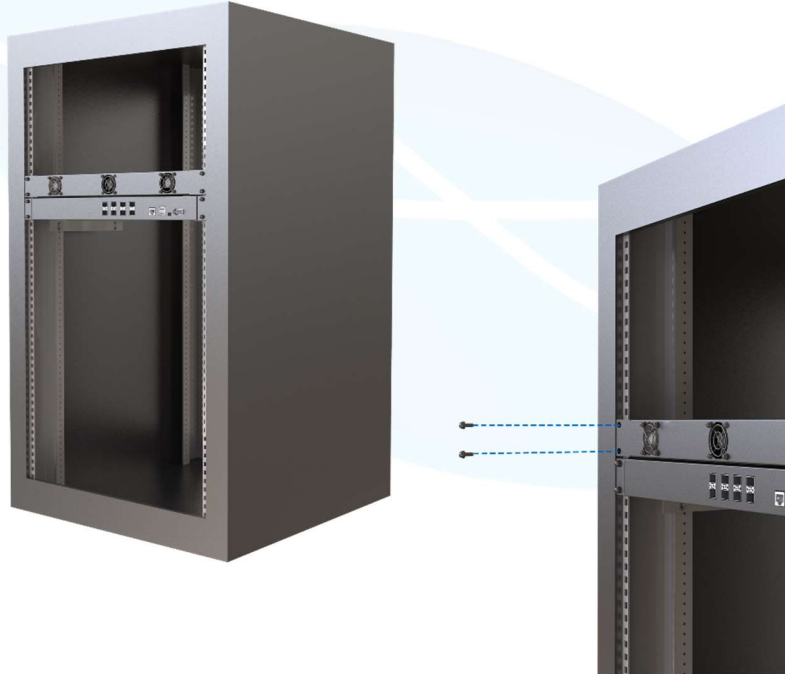

2. Plug AC power lead.



Contact us today:
www.sunwave.com
cf_support@sunwave.com

SUNWAVE

© Sunwave IM_CF_M2 v2.0.1 | 17 of 51



MID POWER

4 x 37dBm Output
5G NR Compli

3. Fan DC version has power cable embedded in chassis.

Note: Red is for positive; Black is for negative. There are labels at cable ends to distinguish positive or negative pole.

Note: Connect "+" to a high potential (+48VDC from a +48VDC power supply; 0VDC from a -48VDC power supply)

Note: Connect "-" to a low potential (0VDC from a +48VDC power supply; -48VDC from a -48VDC power supply)

Warning: The fan has no reverse polarity protection. Reverse connection will cause power supply damage.

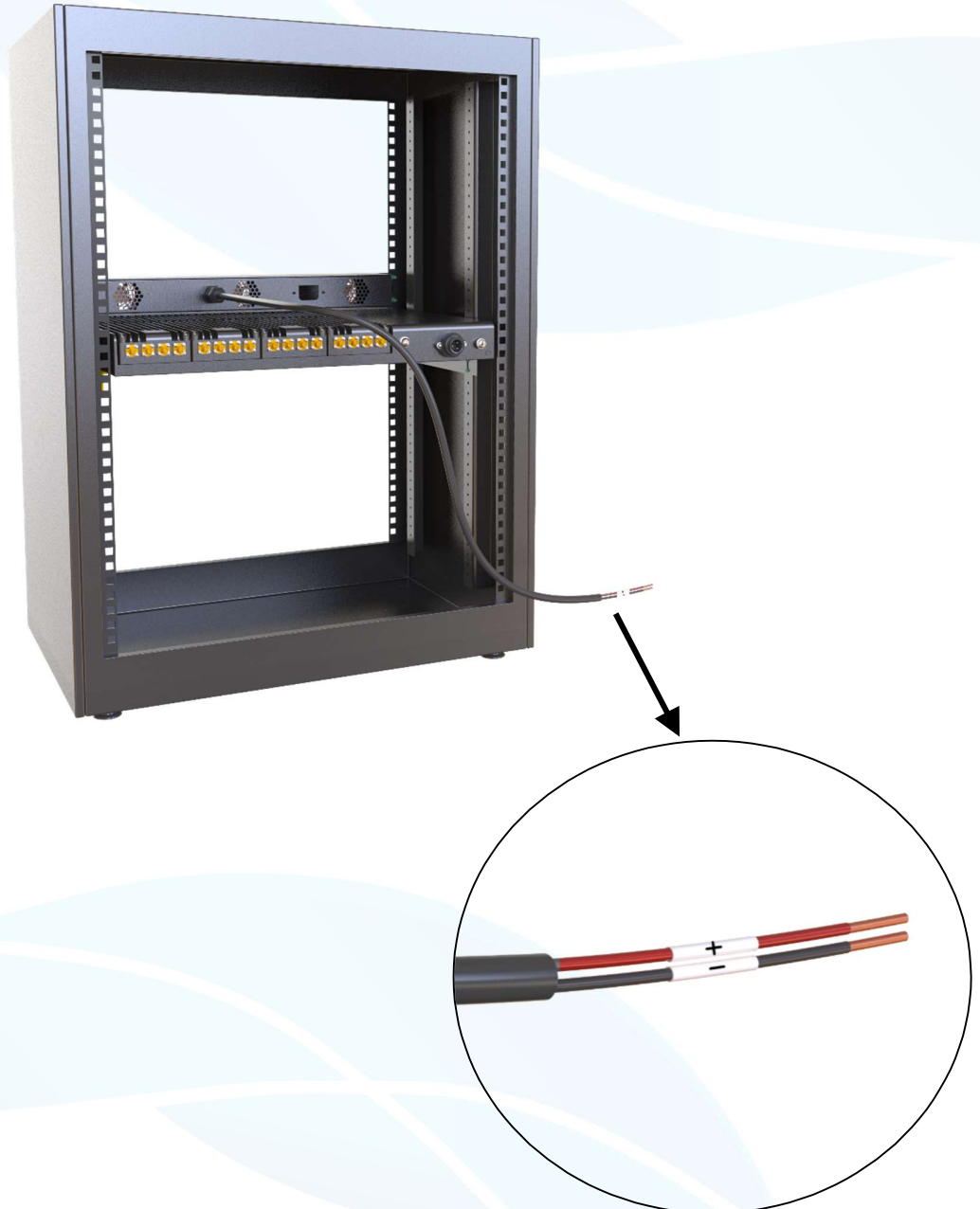

Contact us today:
www.sunwave.com
cf_support@sunwave.com

SUNWAVE

© Sunwave IM_CF_M2 v2.0.1 | 18 of 51

Wall Installation

To install the Access Unit on the wall:

1. Rotate the handles 90° and attach them at the rear of the A2, using 4 screws M3×6 per bracket and the Phillips screwdriver. Observe the orientation of the brackets.



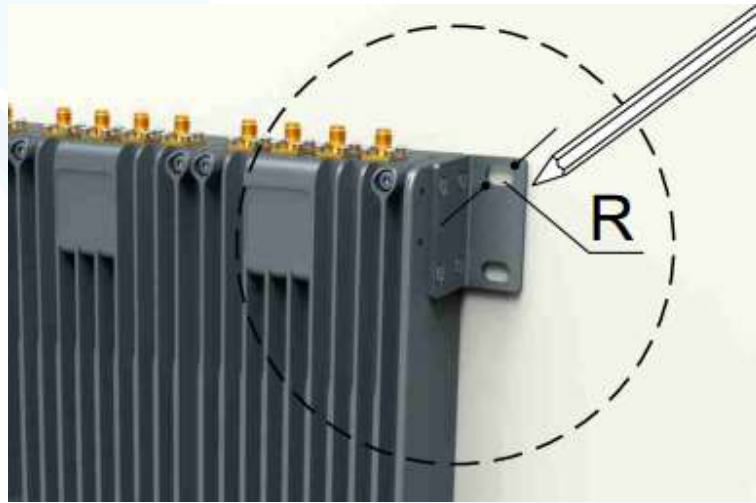

2. Mark 4 x $\varnothing 6.8\text{mm}$ drilling holes sites for the hanger to be attached to the wall.

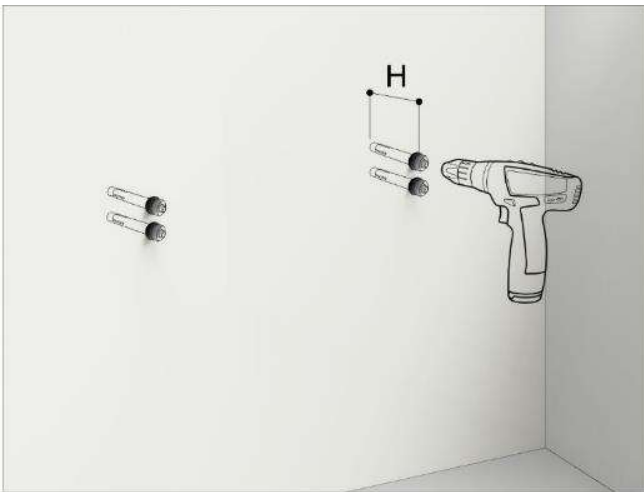

3. Drill 4 holes at the marked sites using percussion drill and embed 4x $\varnothing 10$ plastic expansion pipes. Note: H=70mm.
Fasten the case with 4xM6 expansion bolt.



Pen	Drill	Expansion Bolt
		



MID POWER

4 x 37dBm Output
5G NR Compli

4. Connect and lock the power cable at the A2 rear side
5. Connect and screw the ground wire at the A2 rear side

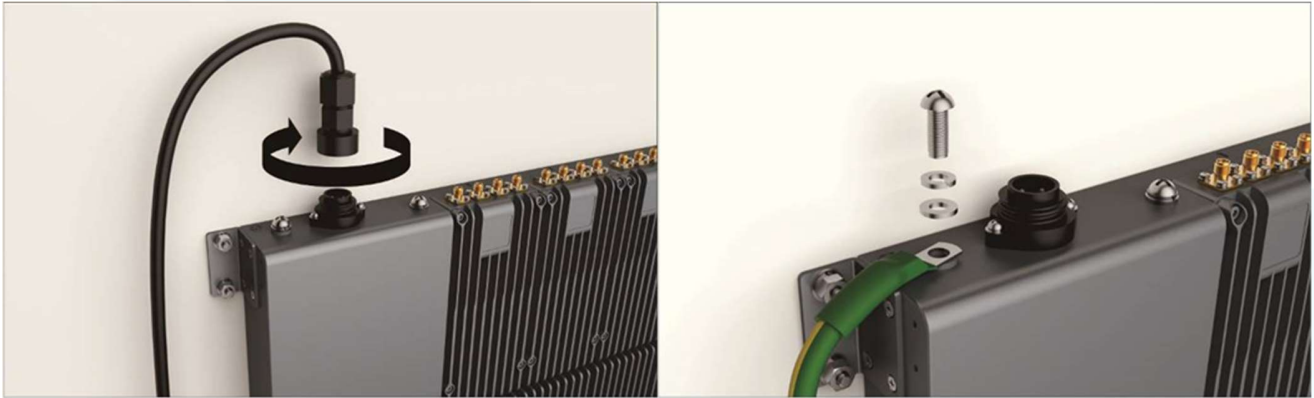

Contact us today:
www.sunwave.com
cf_support@sunwave.com

SUNWAVE

© Sunwave IM_CF_M2 v2.0.1 | 21 of 51



MID POWER

4 x 37dBm Output
5G NR Compli

A2 Mounting Dimension Spacing

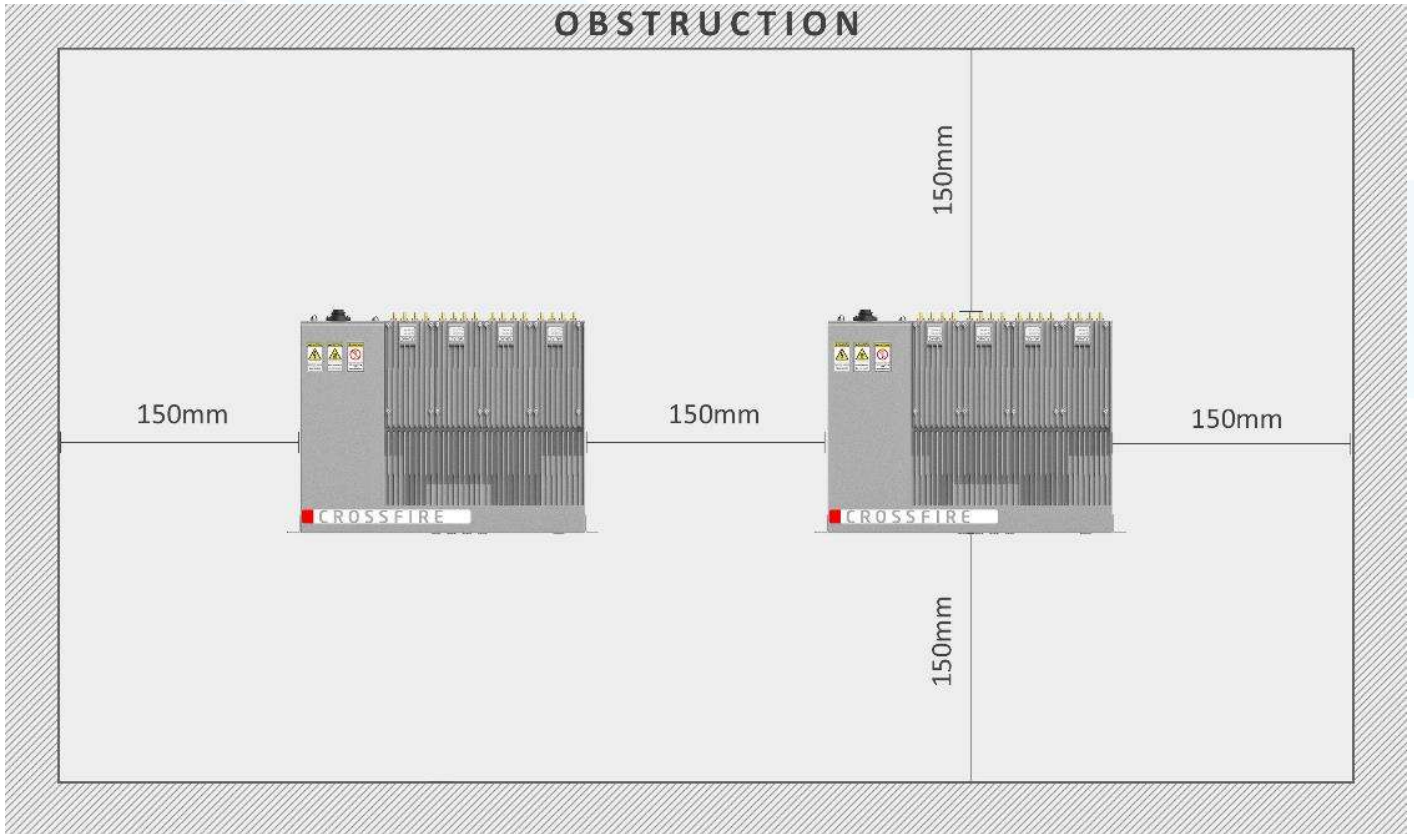

Contact us today:
www.sunwave.com
cf_support@sunwave.com

SUNWAVE

© Sunwave IM_CF_M2 v2.0.1 | 22 of 51



MID POWER

4 x 37dBm Output
5G NR Compli

RF Connection

The RF interface between the Access Unit and the service provider signal source (or CrossFire CPOI) is provided by duplex connections on the Active Combiner module.

To route and connect the coaxial cables to the Access Unit:

1. Obtain the required lengths of high performance, flexible, low loss 50Ω coaxial cable for all coaxial connections and route the cables from the signal source or CPOI to the Active Combiner module.
2. Connect the cables from the signal source to the QMA female connectors on the Active Combiner module on the back panel of Access Unit.

Note: Each Active Combiner module has four connectors to support up to four inputs.



A2 Rear Panel Interfaces

SN	Interface Name	Description
1	Module 4 Duplexer Interface	QMA Female
2	Module 3 Duplexer Interface	QMA Female
3	Module 2 Duplexer Interface	QMA Female
4	Module 1 Duplexer Interface	QMA Female
5	Electric Power Line Interface	/
6	Grounding	/

Installation of the E2-O

Installing the E2-O is virtually the same as installing the A2. Please refer to the steps described in the A2 installation for the E2-O.

Contact us today:
www.sunwave.com
cf_support@sunwave.com

SUNWAVE

© Sunwave IM_CF_M2 v2.0.1 | 23 of 51









MID POWER

4 x 37dBm Output
5G NR Compli



Mount the E2-O in the Rack

E2-O Accessories

	① Screw M6×16	② Screw M3×6
		
③ Suspension Loop	④ AC Power Lead 2.5m	
		
⑤ Optical Transceiver	⑥ Ground Wire 2m	
		

E2-O Accessories

Note: the ground wire of E2-O is 12AWG and 2 meter in Accessories package.

Contact us today:
www.sunwave.com
cf_support@sunwave.com



Attach E2-O Handle

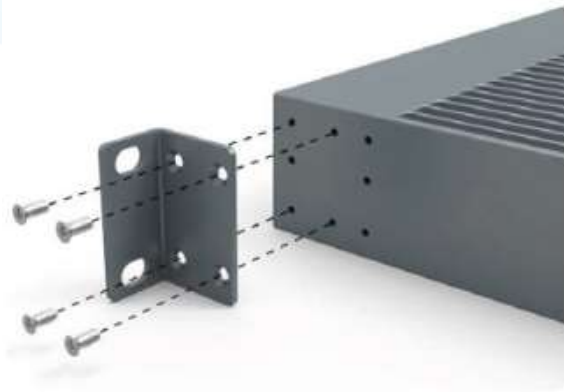

Attaching a 19" Mounting Bracket

1. Attach the 19" mounting brackets at the front of the E2-O, using 4 screws M3×16 per bracket and the Phillips screwdriver. Observe the orientation of the brackets.

Attach Sliding Rails and E2-O to Rack

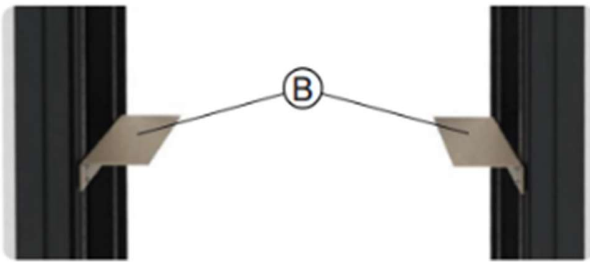

Attached Sliding Rails

1. Attach the sliding rails **B** to the rack
Note: the sliding rails are not included in the delivery.



Place E2-O in Rack

2. Place the E2-O in the rack

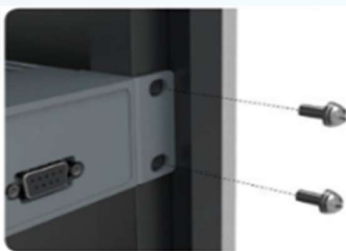

Fix E2-O with Screws

3. Secure the E2-O using 2 screws M6×16 on both sides and the Phillips screwdriver.



MID POWER

4 x 37dBm Output
5G NR Compli

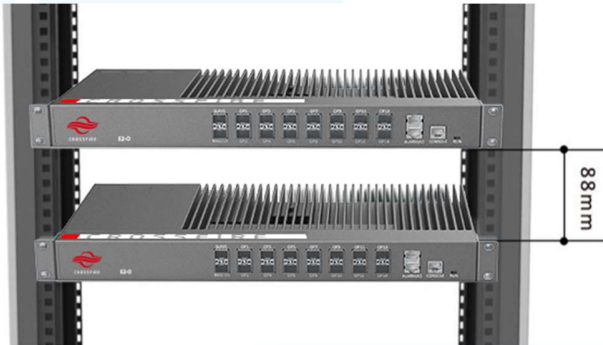

Separation of Adjacent E2-O

For rack installation, it is highly recommended to use a fan tray in the middle of 2 adjacent E2-O for cooling.

Keep 2U separation of 2 E2-O if there is no fan for cooling.

Note: It will reduce service life if E2-O is continuously working in environment of high temperature.

Connect Power and Ground Cable to E2-O



Connect Power Cable at Rear Side



Connect Ground Cable at Rear Side

1. Connect and lock the power cable at the rear of the E2-O.

2. Connect and screw the ground wire at the rear of the E2-O.

Mount the E2-O on the Wall

Attach Handle to E2-O

Attach the 19" mounting brackets to the rear of the E2-O, using 4 screws M3×16 per bracket and the Phillips screwdriver. Observe the orientation of the brackets.



Attaching a 19" Mounting Bracket

Mount E2-O to Wall

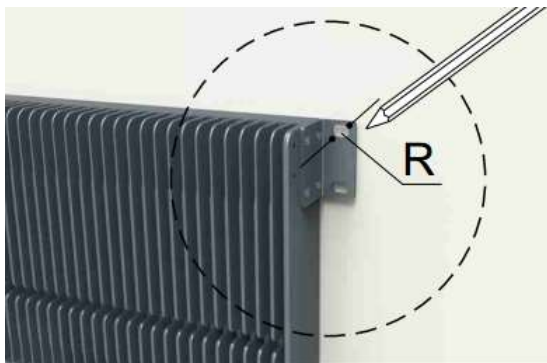

Marking the Position of Mounting Holes

1. Hold the E2-O to the installation location and mark the position of the 4 mounting holes in the mounting brackets; see arrows in the picture.
2. Drill the mounting holes according to the chosen mounting accessories.



Mounting Completed

1. Attach the dowels, expansion screws, or the similar and fasten the E2-O to the wall.

Connect Power and Ground Cable to E2-O



Connect power cable at the rear of the unit



Connect ground cable at the rear of the unit

1. Connect and lock the power cable at the rear of the E2-O

1. Connect and screw the ground wire at the rear of the E2-O



MID POWER

4 x 37dBm Output
5G NR Compli

E2-O Mounting Dimension Spacing

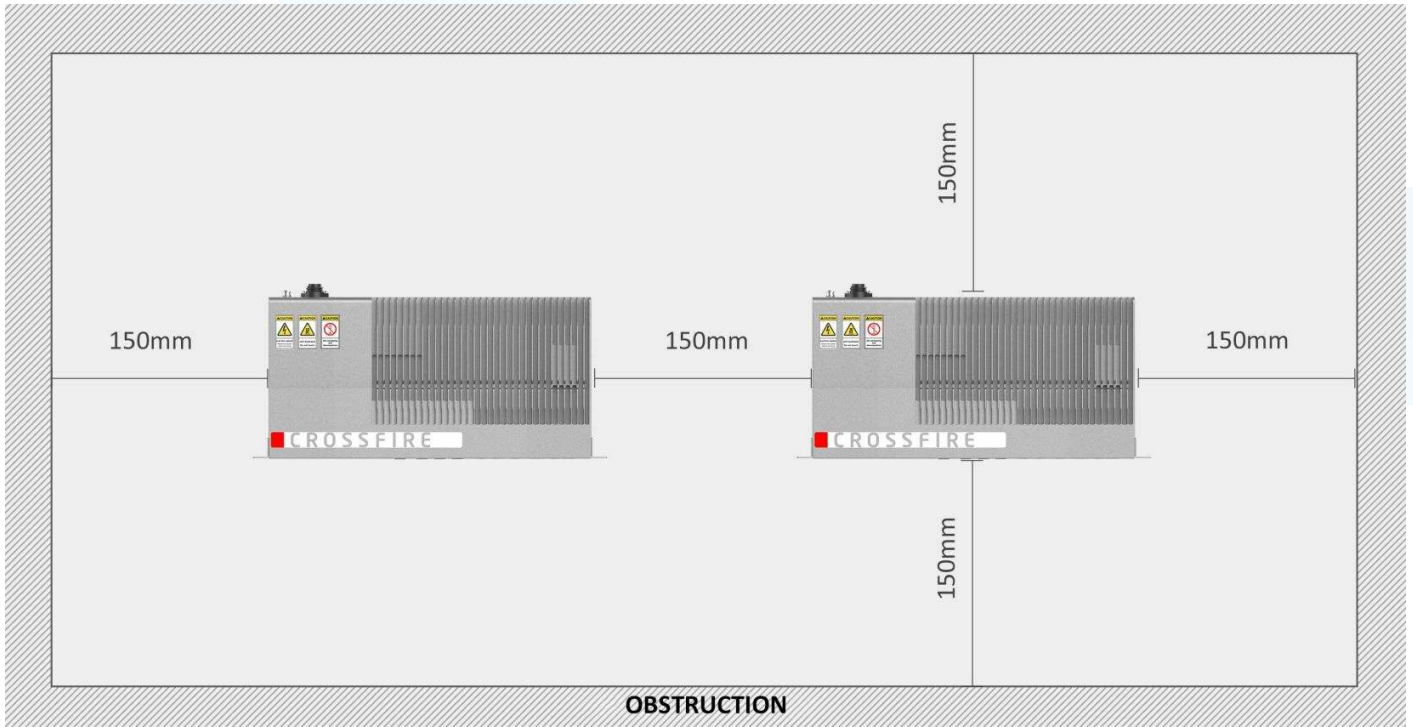

Contact us today:
www.sunwave.com
cf_support@sunwave.com

SUNWAVE

© Sunwave IM_CF_M2 v2.0.1 | 29 of 51

Installing the Mid Power Remote Unit (M2RU)

Accessories List

M2RU Accessories List	① Nut M10	② Screw M6x14	③ Flat Washer M10	④ Spring Washer M10
⑤ Handle 	⑥ Expansion Bolt M10x90 		⑦ Optical Transceiver A11200801841 Optical Transceiver A11200801831 	
⑧ HPRU Mounting Bracket I 	⑨ HPRU Mounting Bracket II 		⑩ Nut M12 	
⑪ Flat Washer M12 	⑫ Spring Washer M12 		⑬ Bolt M12 	
⑭ DC Power Lead 2m 	⑮ Ground Wire 2m 			

Wall Installation (Back on the Wall)

1. Attach and fasten the handle to the side of M2RU with screws M6×14 using T5 Wrench.

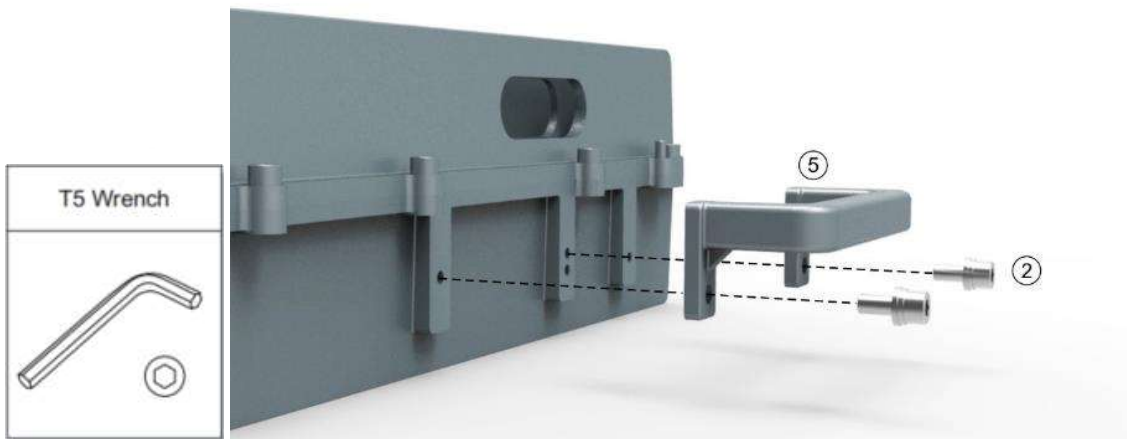

2. Attach and fasten the Bracket I to the back of M2RU with screws M6×14 using T5 Wrench.



3. Mark the position of the drilling holes in the mounting Bracket II. Note: R=13mm.

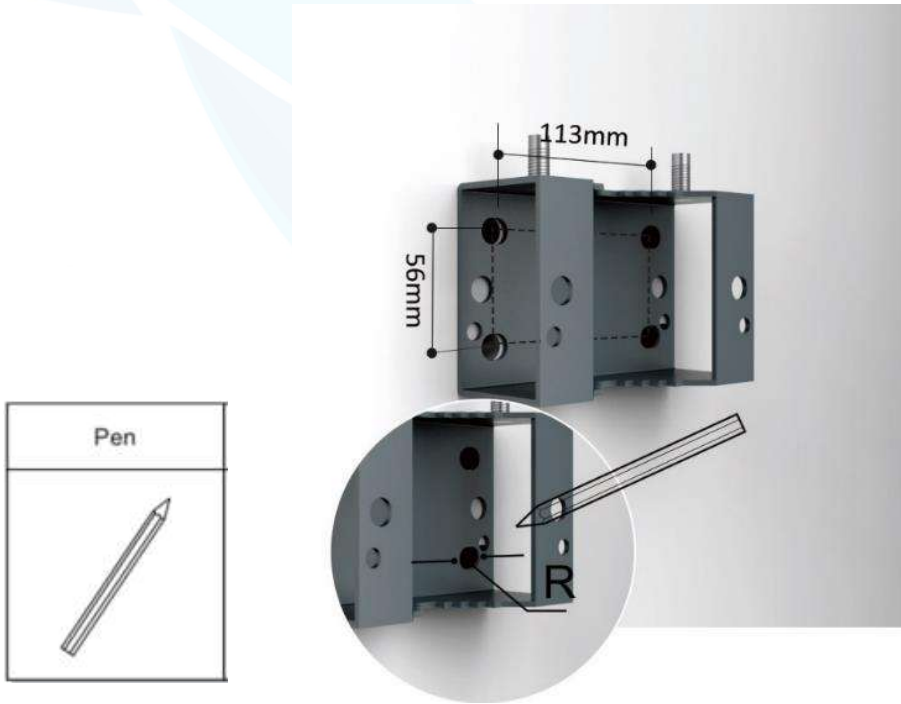

4. Drill 4 holes at the marked positions. Note: H=70mm

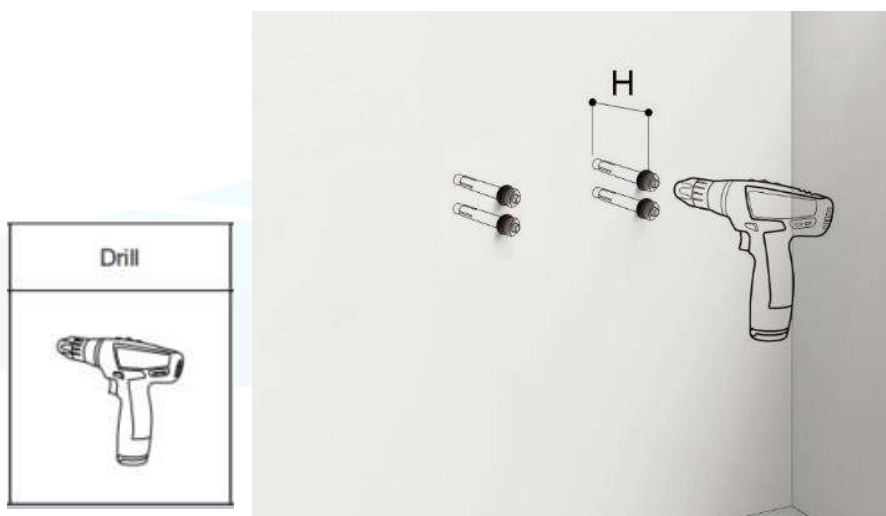

5. Attach the dowels, expansion screws or the like and fasten the Bracket II to the wall.

Tips: use Bracket II as a reference to control each devices' separation distance before hanging and locking M2RU up.

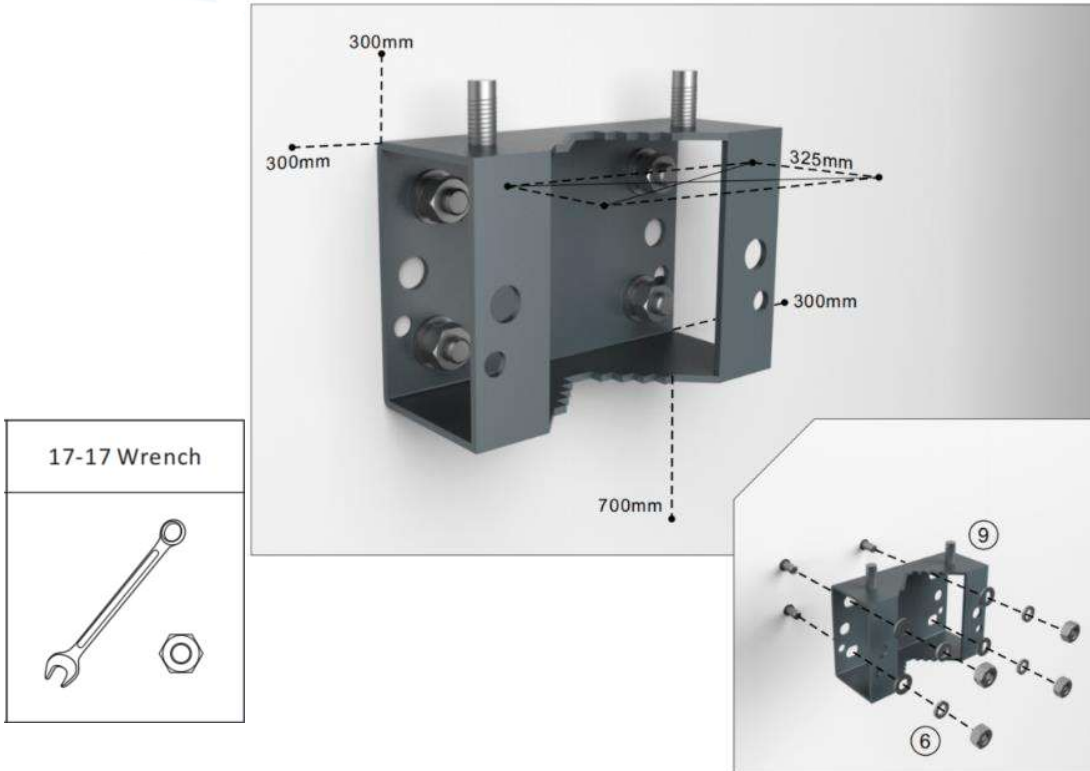

6. Hang the M2RU on the mounting bracket II and fasten with nuts M10.

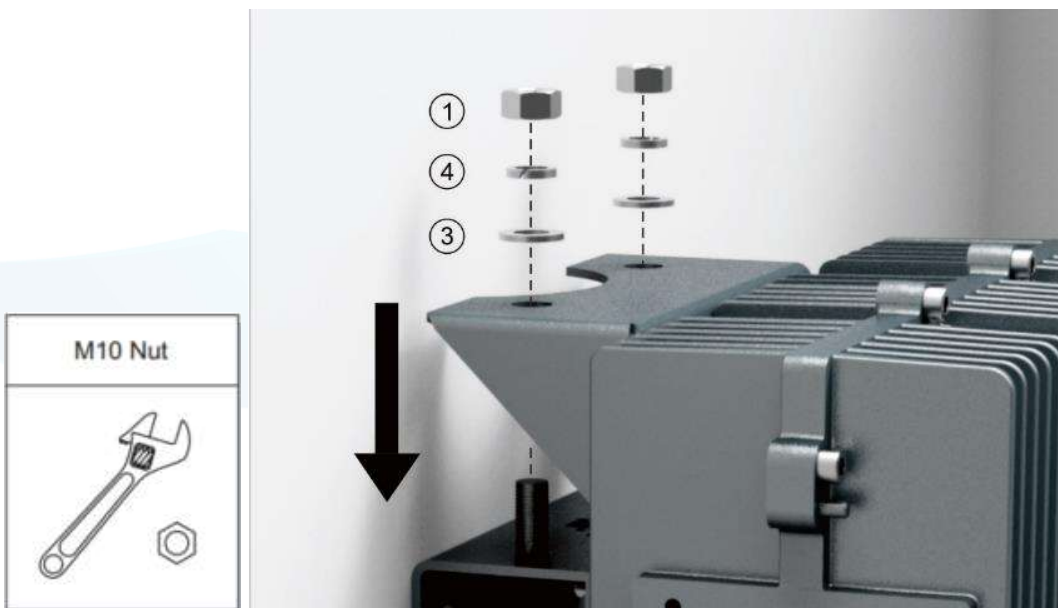

7. Fasten the Bracket I and II with screws M6×14.



8. Connect and lock the power cable at the M2RU rear side





MID POWER

4 x 37dBm Output
5G NR Compli

9. Connect and screw the ground cable at the M2RU's left side

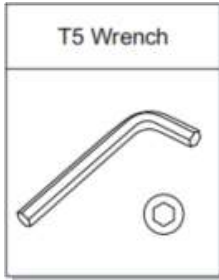

Contact us today:
www.sunwave.com
cf_support@sunwave.com

SUNWAVE

© Sunwave IM_CF_M2 v2.0.1 | 35 of 51



MID POWER

4 x 37dBm Output
5G NR Compli

Wall Installation (Side on the Wall)



1. Attach and fasten the handle to the side of M2RU with screws M6×14 using T5 Wrench.

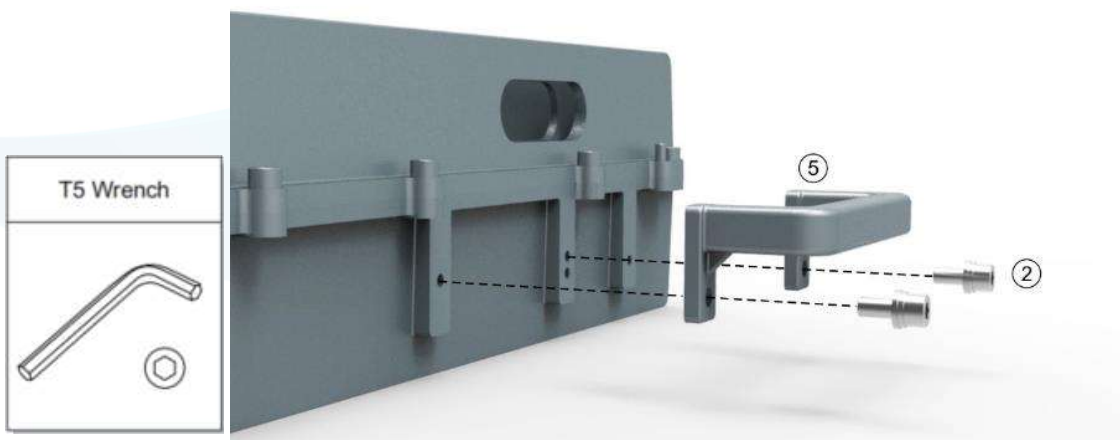
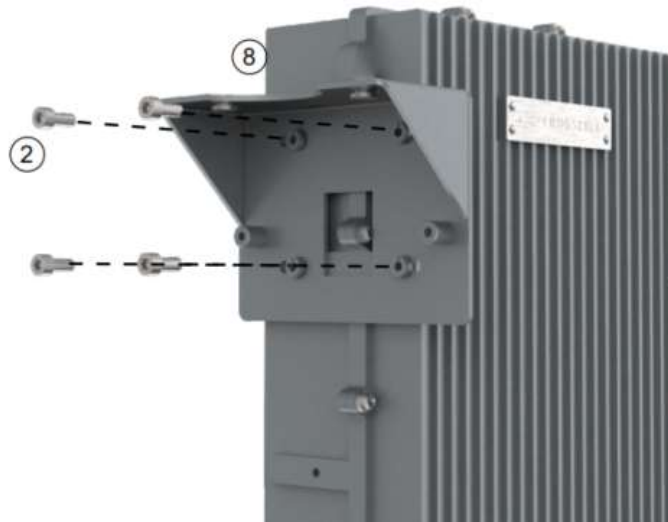
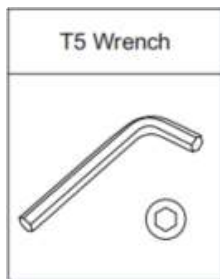

Figure 1.

Contact us today:
www.sunwave.com
cf_support@sunwave.com



- Attach and fasten the Bracket I to the left side of M2RU with screws M6×14 using T5 Wrench.



- Mark the position of the drilling holes in the mounting Bracket II. Note: R=13mm.

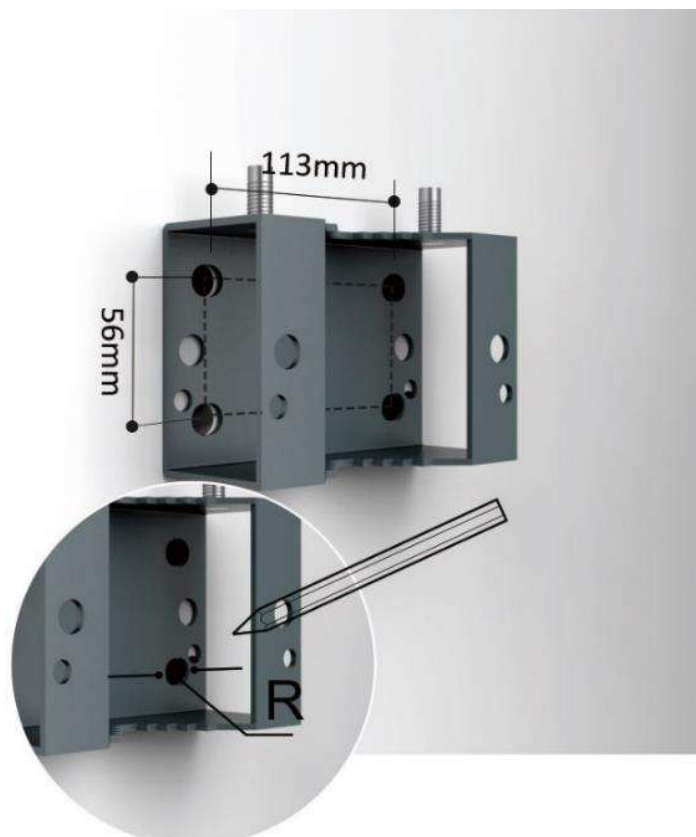
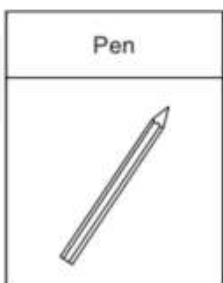

- Drill 4 holes at the marked positions. Note: H=70mm.



5. Attach the dowels, expansion screws or the like and fasten the Bracket II to the wall.

Tips: use Bracket II as a reference to control each devices' separation distance before hanging and locking M2RU up.

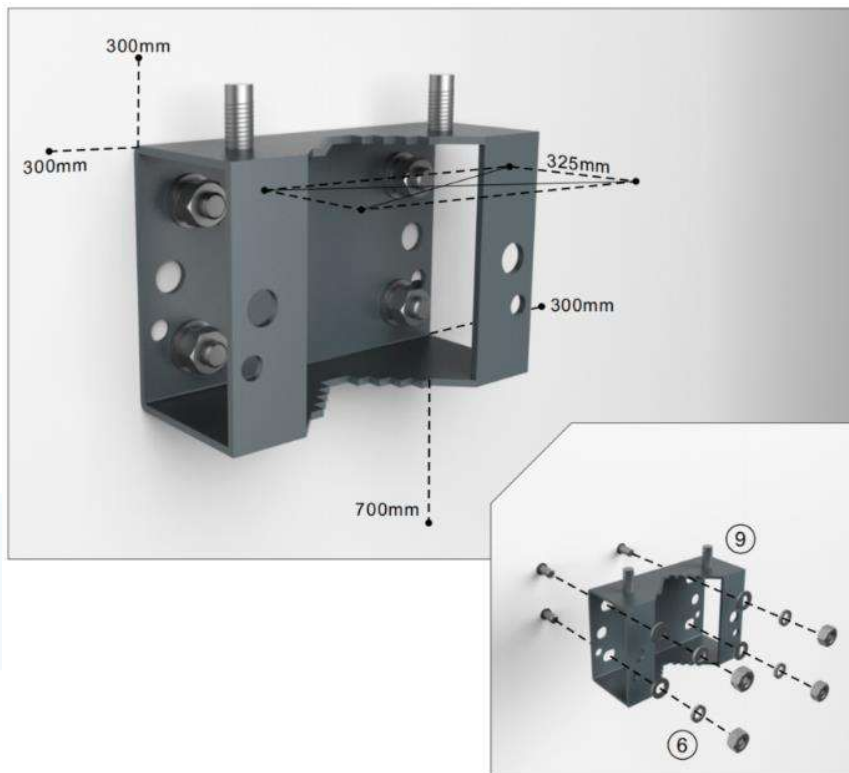
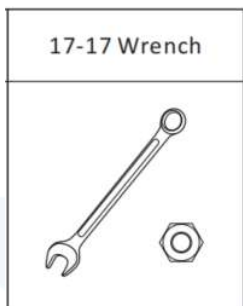

6. Hang the M2RU on the mounting bracket II and fasten with nuts M10.

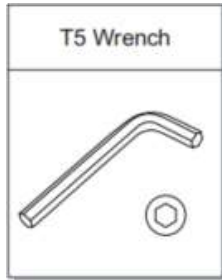

7. Fasten the Bracket I and II with screws M6×14.

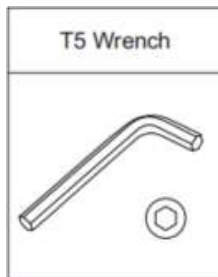

Pole Installation

1. Install the handle and Bracket I to the back of M2RU.
2. Install the bracket II and Bracket III to the pole.
3. Hang the M2RU on the mounting bracket and fasten with nuts M10.
4. Connect the ground cable and power cable.

Note: The diameter of Pole shall not be over 110mm or less than 55mm.

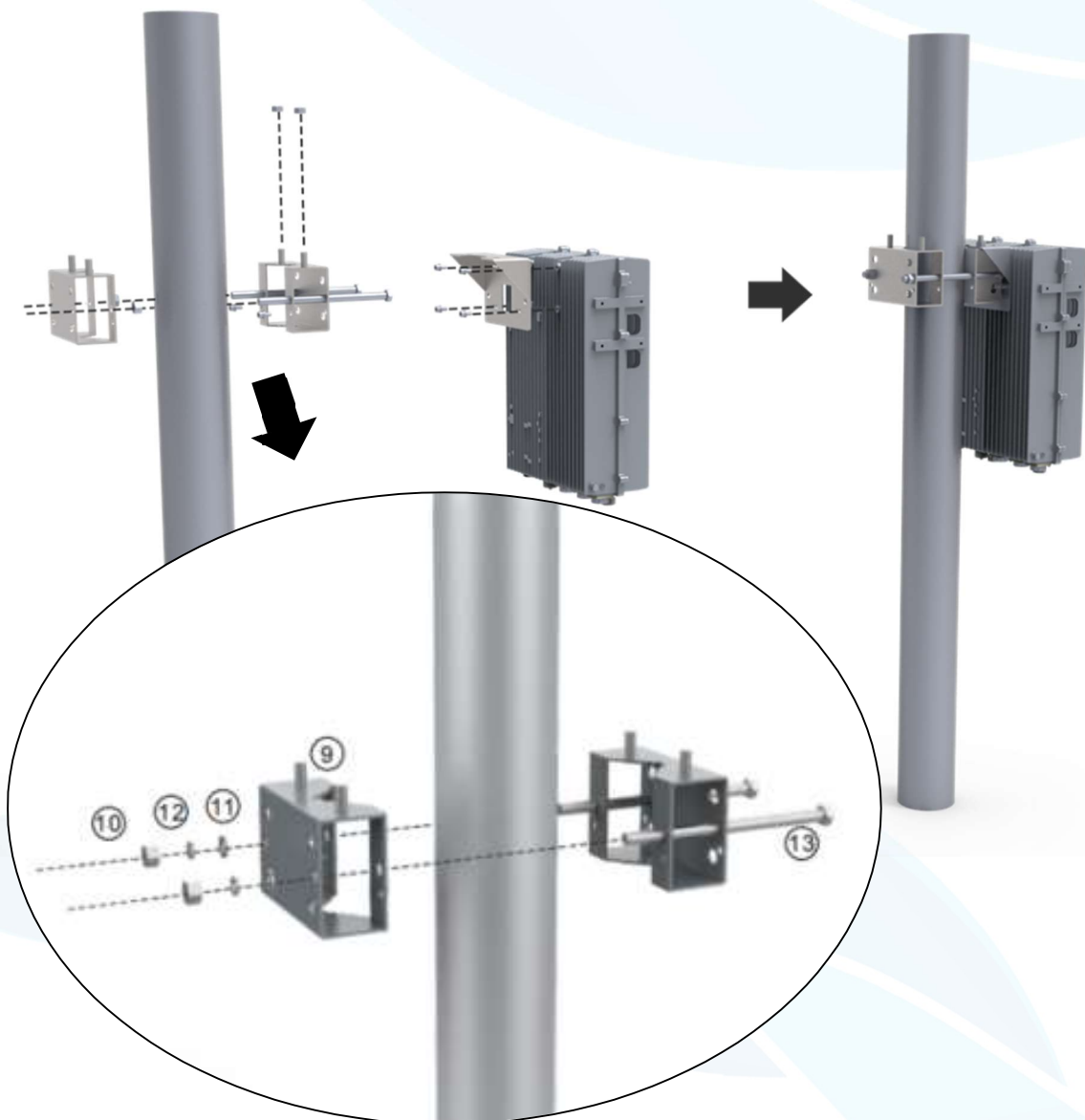

M2RU-PSU48S Installation

Accessories

Equipment Mounting Brackets x 2
AC Input Power Lead x 1 / 1.8m
DC Output Power Lead to Equipment x 1 / 0.25m
Various Screws used for Mounting on Equipment: 4 x M6x12 hexagon socket head screw 6 x M4x10 pan head combination screw

Note: the M2RU-PSU48S is not included in M2RU package. It needs to be purchased separately.

Installation Procedure

1. Attach and fasten the Bracket to the right side of M2RU with screws M6×12 using T5 wrench.

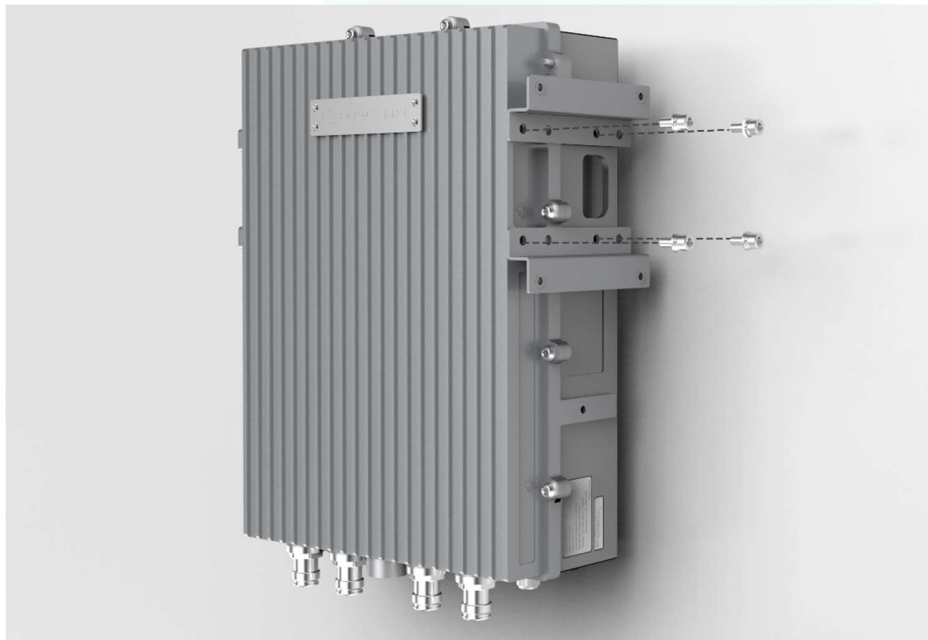



MID POWER

4 x 37dBm Output
5G NR Compli

2. Fasten the to the Bracket II with screws M6x12 using T5 wrench.

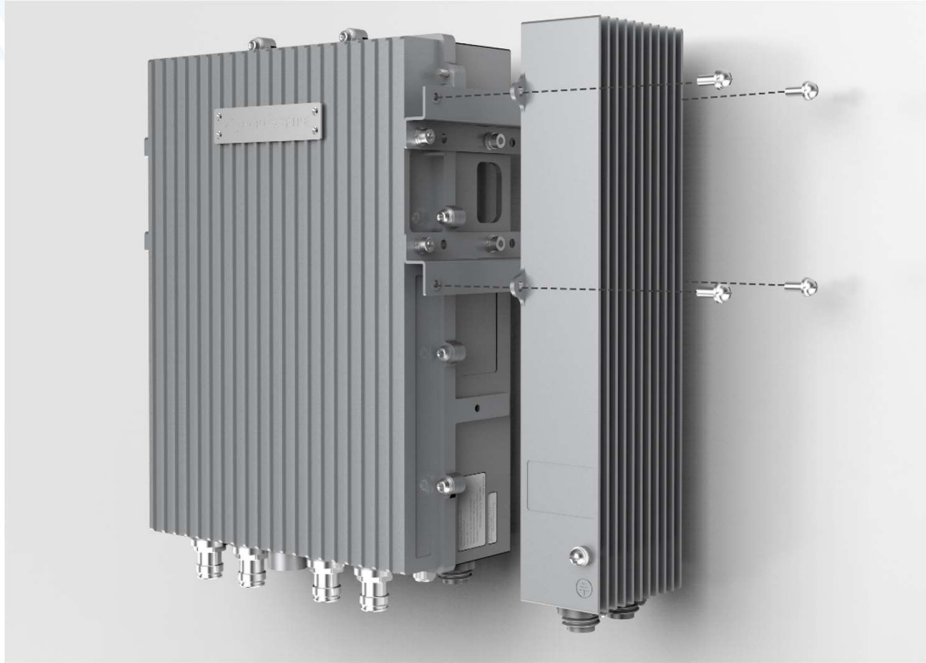

3. Connect and screw power cable to DC OUT port of M2RU-PSU48S and input port of M2RU.



Contact us today:
www.sunwave.com
cf_support@sunwave.com

SUNWAVE

© Sunwave IM_CF_M2 v2.0.1 | 42 of 51



MID POWER

4 x 37dBm Output
5G NR Compli

4. Connect and screw power cable to AC PWR of M2RU-PSU48S.



5. Installation is completed as the following figure.



Contact us today:
www.sunwave.com
cf_support@sunwave.com

SUNWAVE

© Sunwave IM_CF_M2 v2.0.1 | 43 of 51



MID POWER

4 x 37dBm Output
5G NR Compli

M2RU Mounting Dimension Spacing

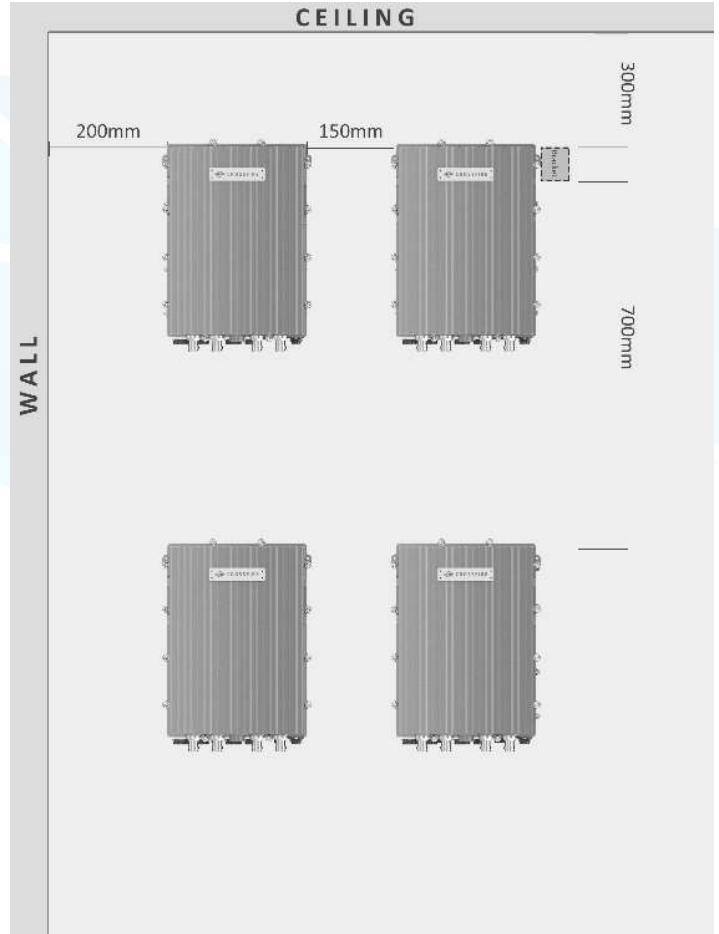
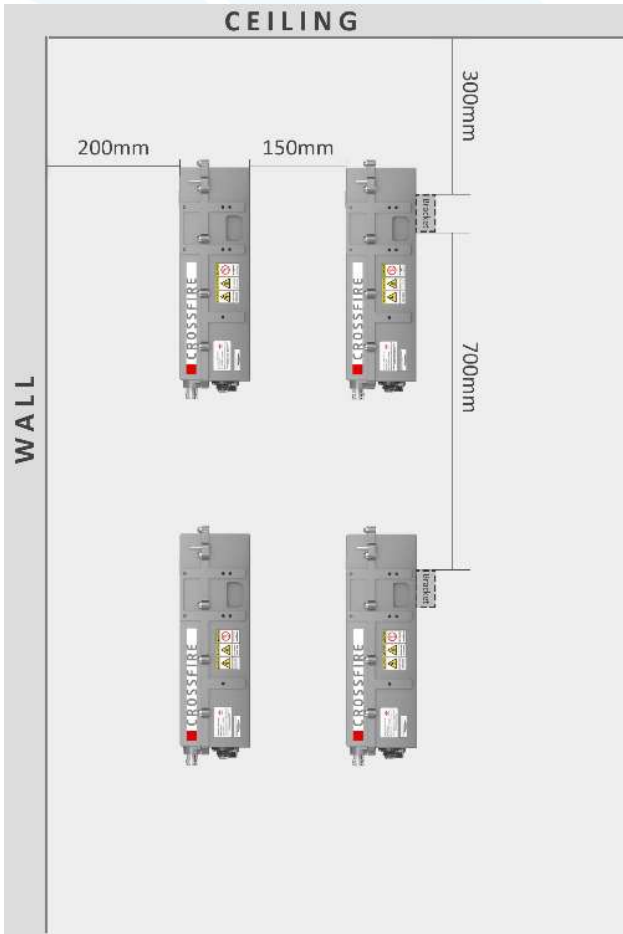

Contact us today:
www.sunwave.com
cf_support@sunwave.com

SUNWAVE

© Sunwave IM_CF_M2 v2.0.1 | 44 of 51

Optical Connection

Optical Transceiver Module

Single Port Bidirectional SFP Transceiver

The Figure below shows a pair of single port Bidirectional SFP transceivers. For devices optical connection, the transceivers of two sides must be paired - the wavelength of one side is 1271nm, and the wavelength of another side is 1331nm. Otherwise, it will fail the connection. All lower-level devices under this port won't be working in the system.

All the optical ports of all type devices have triangle LED indicators pointing to each port, which represent the synchronization status of the upper and lower optical modules. The indicator turns to green when optical modules are plugged in ports and synchronized. When the connection is down, or there is no optical module in port, the indicator remains red.



 The single port SFP modules have to be used in pairs.

Dual Port SFP Transceiver

The optical connector unit includes an optical module and optical fibre. The Figure below shows that when using a dual-port SFP module, the optical transmitter and optical receiver should correspond to each other. In other words, the optical transmitter of optical module A should correspond to the optical receiver of optical module B, and the receiver of A should correspond to the transmitter of B. The optical receiver and transmitter terminals of the optical module can be determined by the triangular mark on the optical module. The triangular mark in the yellow box and the red and blue lines indicate the optical fibre connections.

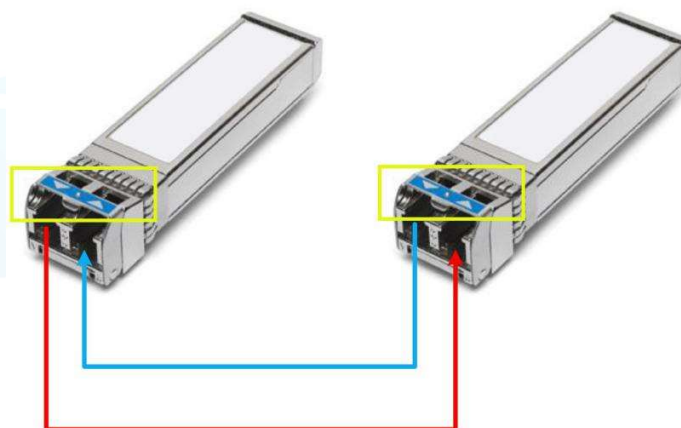



MID POWER

4 x 37dBm Output
5G NR Compli

Optical Indicator

Each pair (2) of optical module cages has four LED indicator arrows. The two on the left are green, and the two on the right are red, as shown in Figure below. The indicator arrows represent the synchronization status of the upper and lower optical modules. When a pair of optical modules are synchronized (both uplink and downlink), the indicators turn green as shown in the right pair of indicators in Figure below. When the optical module is unplugged or not synchronized, the indicators are red, as shown in the left pair of indicators. Check whether both indicators turn green after connecting one pair of optical modules. If the indicators are red, the terminal has not synchronized.

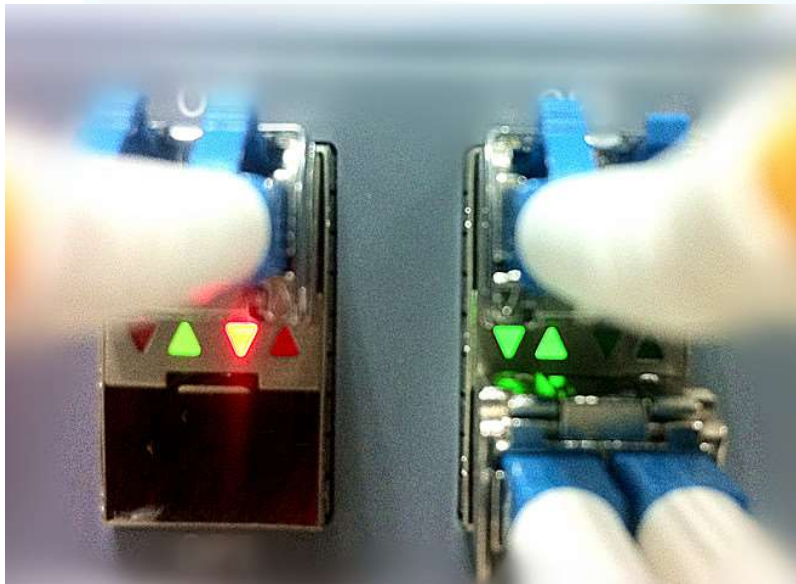

Contact us today:
www.sunwave.com
cf_support@sunwave.com

SUNWAVE

© Sunwave IM_CF_M2 v2.0.1 | 46 of 51

A2 Optical Port Description

Obtain the required lengths of optical fibers for all the optical connections and connect the fibers on the front panel of Access Unit.

The interface type of SFP transceivers is an LC connector.

It is important to label all ports on the fiber distribution panel correctly.

It is recommended to include additional length/slack in the optical fiber to allow future re-configurations without requiring additional splices.

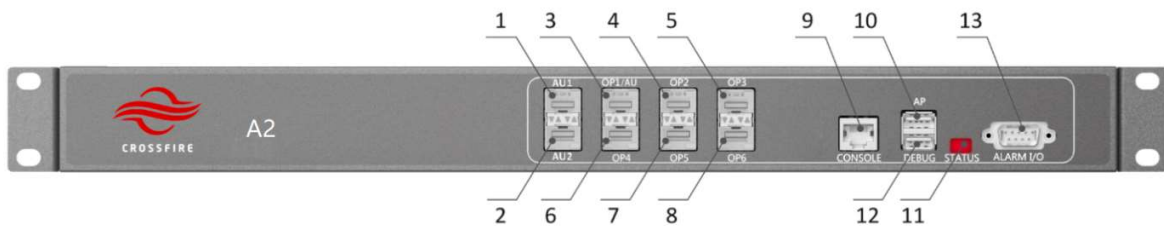

A2 Front Panel Interfaces

SN	Interface Name	Description
1	AU1	Connects Slave A2 1
2	AU2	Connects Slave A2 2
3	OP1/AU	For Master A2: connects E2-O/RU For Slave A2: connects Master A2
4	OP2	Connects E2-O/RU
5	OP3	Connects E2-O/RU
6	OP4	Connects E2-O/RU
7	OP5	Connects E2-O/RU
8	OP6	Connects E2-O/RU
9	CONSOLE	Connects OMC or local PC through CAT-5 for local and remote monitoring
10	AP	Connects WLAN network adapters for monitoring device through Wi-Fi
11	STATUS	Indicates device operating status
12	DEBUG	Connects local debugging PC through a USB connection
13	ALARM I/O	Connects external environment alarm interface for environment monitoring

E2-O Optical Port Description

Obtain the required lengths of optical fibers for all the optical connections and connect the fibers on the front panel of the Expansion Unit.

The interface type of SFP transceivers is an LC connector.

Contact us today:

www.sunwave.com

cf_support@sunwave.com



MID POWER

4 x 37dBm Output
5G NR Compli

It is important to label all ports on the fiber distribution panel correctly.

It is recommended to include additional length/slack in the optical fiber to allow future re-configurations without requiring additional splices.

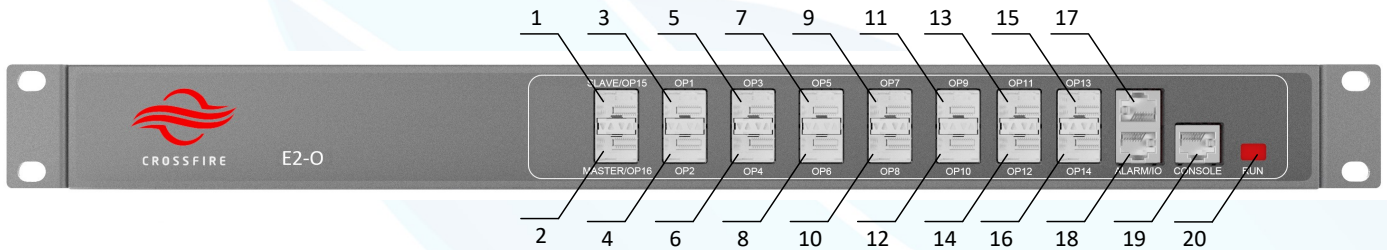

E2 Front Panel Interfaces

SN	Interface Name	Description
1	SLAVE/OP15	Connection for Master A2/E2-O at the next higher level
2	MASTER/OP16	Connection for E2-O at the next lower level
3	OP1	Connection for RU
4	OP2	Connection for RU
5	OP3	Connection for RU
6	OP4	Connection for RU
7	OP5	Connection for RU
8	OP6	Connection for RU
9	OP7	Connection for RU
10	OP8	Connection for RU
11	OP9	Connection for RU
12	OP10	Connection for RU
13	OP11	Connection for RU
14	OP12	Connection for RU
15	OP13	Connection for RU
16	OP14	Connection for RU
17	Alarm	Alarm IN
18	Alarm	Alarm OUT
19	CONSOLE	Connection for local PC through CAT-5 for local monitoring
20	STATUS	Indicates device operating status

Contact us today:
www.sunwave.com
cf_support@sunwave.com



RU Optical Port Description

Obtain the required lengths of optical fibers for all the optical connections and connect the fibers on the front panel of Remote Unit.

The interface type of SFP transceivers is an LC connector.

It is important to label all ports on the fiber distribution panel correctly.

It is recommended to include additional length/slack in the optical fiber to allow future re-configurations without requiring additional splices.

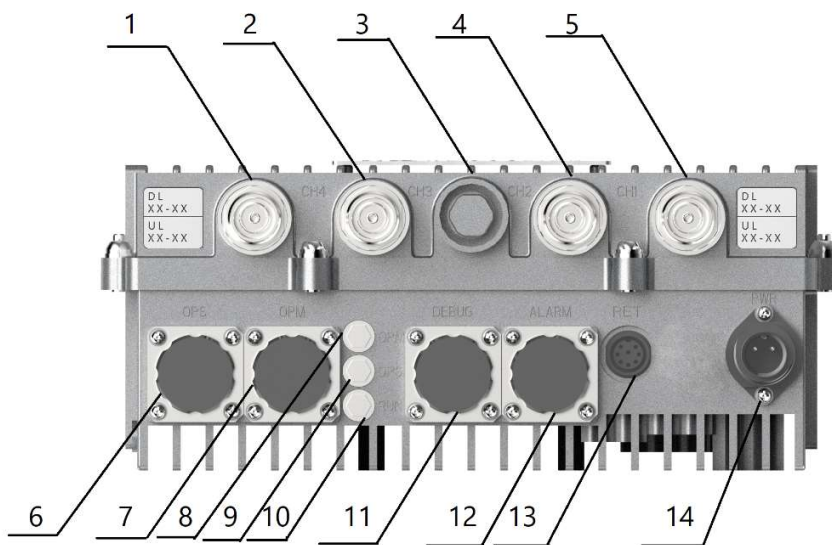

RU Front Panel Interfaces

SN	Interface Name	Description
1	CH4	PA 2 Module Interface, 4.3-10 female Connector
2	CH3	PA 2 Module Interface, 4.3-10 female Connector
3	Air Pressure hole	Make the pressure balance
4	CH2	PA 1 Module Interface, 4.3-10 female Connector
5	CH1	PA 1 Module Interface, 4.3-10 female Connector
6	Slave OP	Connection for E2 or RU at the next higher level
7	MASTER OP	Connection for RU at the next lower level
8	Master	Indicates Master OP port operating status
9	Slave	Indicates Slave OP port operating status
10	RUN	Indicates device operating status



MID POWER

4 x 37dBm Output
5G NR Compli

SN	Interface Name	Description
11	DEBUG	Connection for local PC through CAT-5 for local monitoring
12	ALARM	Reserved
13	RET	Tunable Antenna Interface
14	PWR	Electrical Power Line Interface

FCC Warning:

This device complies with Part 15 of the FCC Rules. Operation is subject to the following two conditions:

- (1) This device may not cause harmful interference, and
- (2) This device must accept any interference received, including interference that may cause undesired operation.

Part20 Warning :

WARNING. This is NOT a CONSUMER device. It is designed for installation by FCC LICENSEES and QUALIFIED INSTALLERS. You MUST have an FCC LICENSE or express consent of an FCC Licensee to operate this device. Unauthorized use may result in significant forfeiture penalties, including penalties in excess of \$100,000 for each continuing violation.

FCC Warning:

This device complies with Part 15 of the FCC Rules. Operation is subject to the following two conditions:

- (1) This device may not cause harmful interference, and
- (2) This device must accept any interference received, including interference that may cause undesired operation.

Part20 Warning :

Note: This product has been tested and found to comply with the limits for a Class B digital device, pursuant to Part 15 of the FCC Rules. These limits are designed to provide reasonable protection against harmful interference in a residential installation. This product generates, uses, and can radiate radio frequency energy and, if not installed and used in accordance with the instructions, may cause harmful interference to radio communications. However, there is no guarantee that interference will not occur in a particular installation. If this product does cause harmful interference to radio or television reception, which can be determined by turning the equipment off and on, the user is encouraged to try to correct the interference by one or more of

Contact us today:
www.sunwave.com
cf_support@sunwave.com





MID POWER

4 x 37dBm Output
5G NR Compli

the following measures:

- Reorient or relocate the receiving antenna.
- Increase the separation between the equipment and receiver.
- Connect the equipment into an outlet on a circuit different from that to which the receiver is connected.
- Consult the dealer or an experienced radio/TV technician for help.