



**SGS-CSTC Standards Technical Services Ltd.
Shenzhen Branch**

No. 1 Workshop, M-10, Middle section, Science & Technology Park,
Shenzhen, Guangdong, China 518057

Telephone: +86 (0) 755 2601 2053
Fax: +86 (0) 755 2671 0594
Email: ee.shenzhen@sgs.com

Report No.: SZEM170600640813
Page: 1 of 57

TEST REPORT

Application No.:	SZEM1706006408CR
Applicant:	Sunwave Communications Co., Ltd.
Manufacturer:	Sunwave Communications Co., Ltd.
Factory:	Sunwave Communications Co., Ltd.
Product Name:	Remote Unit
Product Description:	The RU conducts digital-analog conversion and power amplification of the input signals.
Model No.:	iDAS-R211
Trade Mark:	CROSSFIRE,SUNWAVE
FCC ID:	2AEJ4R2113030
Standards:	FCC Part 2:2016 FCC Part 27:2016
Date of Receipt:	2017-05-15
Date of Test:	2017-05-15 to 2017-06-25
Date of Issue:	2017-06-26
Test Result :	Pass*

* In the configuration tested, the EUT detailed in this report complied with the standards specified above. Please refer to section 3 of this report for further details.

Authorized Signature:



Jack Zhang
EMC Laboratory Manager



The manufacturer should ensure that all products in series production are in conformity with the product sample detailed in this report. If the product in this report is used in any configuration other than that detailed in the report, the manufacturer must ensure the new system complies with all relevant standards. Any mention of SGS International Electrical Approvals or testing done by SGS International Electrical Approvals in connection with, distribution or use of the product described in this report must be approved by SGS International Electrical Approvals in writing.

This document is issued by the Company subject to its General Conditions of Service printed overleaf, available on request or accessible at <http://www.sgs.com/en/Terms-and-Conditions.aspx> and, for electronic format documents, subject to Terms and Conditions for Electronic Documents at <http://www.sgs.com/en/Terms-and-Conditions/Terms-e-Document.aspx>. Attention is drawn to the limitation of liability, indemnification and jurisdiction issues defined therein. Any holder of this document is advised that information contained hereon reflects the Company's findings at the time of its intervention only and within the limits of Client's instructions, if any. The Company's sole responsibility is to its Client and this document does not exonerate parties to a transaction from exercising all their rights and obligations under the transaction documents. This document cannot be reproduced except in full, without prior written approval of the Company. Any unauthorized alteration, forgery or falsification of the content or appearance of this document is unlawful and offenders may be prosecuted to the fullest extent of the law. Unless otherwise stated the results shown in this test report refer only to the sample(s) tested and such sample(s) are retained for 30 days only.

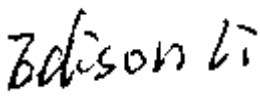

2 Version

Revision Record				
Version	Chapter	Date	Modifier	Remark
01		2017-06-26		Original

Authorized for issue by:			
Tested By		2017-06-26	
			Date
Checked By		2017-06-26	
			Date
	(Edison Li) /Project Engineer		
	(Eric Fu) /Reviewer		



3 Test Summary

Test Item	FCC part 2	FCC part 27	Result
RF Output Power	2.1046	27.50	PASS
Conducted Spurious Emissions	2.1051	27.53	PASS
Band Edge	2.1051	N/A	PASS
Radiated Spurious Emissions	2.1053	27.53	PASS
Occupied Bandwidth	2.1049	N/A	PASS
Frequency Stability	2.1055	27.54	PASS
Out of Band Rejection	N/A	N/A	PASS
Remark: EUT: In this whole report EUT means Equipment Under Test. Tx: In this whole report Tx (or tx) means Transmitter. Rx: In this whole report Rx (or rx) means Receiver.			
No need to implement uplink test as it is cable connect to BTS (No air radiation), then the test about Uplink would be ignored.			
Test method standard: ANSI/TIA-603-D-2010 KDB 935210 D05 Indus Booster Basic Meas v01r01 KDB 935210 D02 Signal Booster Certification v03r02			



4 Contents

	Page
1 Cover Page	1
2 Version	2
3 Test Summary	3
4 Contents	4
5 General Information	5
5.1 Client Information	5
5.2 General Description of E.U.T.	5
5.3 Details of E.U.T.	5
5.4 Standards Applicable for Testing	5
5.5 Test Location	6
5.6 Other Information Requested by the Customer	6
5.7 Test Facility	6
6 Equipment Used during Test	7
7 Test Results	9
7.1 E.U.T. test conditions	9
7.2 Test Procedure & Measurement Data	11
7.2.1 RF Output Power	12
7.2.2 Conducted Spurious Emissions	15
7.2.3 Band Edge	27
7.2.4 Radiated Spurious Emissions	32
7.2.5 Occupied Bandwidth	37
7.2.6 Out of Band Rejection	42
7.2.7 Frequency Stability	44
8 Photographs - Test Setup	46
9 Photographs - EUT Constructional Details	47-57



5 General Information

5.1 Client Information

Applicant:	Sunwave Communications Co., Ltd.
Address of Applicant:	Sunwave Building 581 Huoju Avenue, Binjiang District, Hangzhou, P.R.China Zip: 310053
Manufacturer:	Sunwave Communications Co., Ltd.
Address of Manufacturer:	Sunwave Building 581 Huoju Avenue, Binjiang District, Hangzhou, P.R.China Zip: 310053
Factory:	Sunwave Communications Co., Ltd.
Address of Factory:	Sunwave Building 581 Huoju Avenue, Binjiang District, Hangzhou, P.R.China Zip: 310053

5.2 General Description of E.U.T.

Product Name:	Remote Unit
Model No.:	iDAS-R211
Trade Mark:	CROSSFIRE,SUNWAVE
Sample Type:	Fixed production
Antenna Gain:	12.5dBi
Power Supply:	AC120V 60Hz
Optical Fiber:	100cm (unshielded)
DC Cable:	120cm (unshielded)

5.3 Details of E.U.T.

Type of Modulation:	LTE
Frequency Band:	Downlink 2350MHz to 2360MHz include the Modulation: LTE
Normal Output Power	43dBm (downlink)
System Gain	43dB
ALC Function	The system continuously monitors the input power. Once the detected input power is greater than nominal input power (0dBm for downlink and -50dBm for uplink), the signal will be reduced to nominal input power by automatically adjusting attenuation.

5.4 Standards Applicable for Testing

The standard used was FCC part 2 & FCC part 27



5.5 Test Location

All tests were performed at:

SGS-CSTC Standards Technical Services Co., Ltd., Shenzhen Branch

No. 1 Workshop, M-10, Middle Section, Science & Technology Park, Shenzhen, Guangdong, China.
518057.

Tel: +86 755 2601 2053 Fax: +86 755 2671 0594

No tests were sub-contracted.

5.6 Other Information Requested by the Customer

None.

5.7 Test Facility

The test facility is recognized, certified, or accredited by the following organizations:

- **CNAS (No. CNAS L2929)**

CNAS has accredited SGS-CSTC Standards Technical Services Co., Ltd. Shenzhen Branch EMC Lab to ISO/IEC 17025:2005 General Requirements for the Competence of Testing and Calibration Laboratories (CNAS-CL01 Accreditation Criteria for the Competence of Testing and Calibration Laboratories) for the competence in the field of testing.

- **A2LA (Certificate No. 3816.01)**

SGS-CSTC Standards Technical Services Co., Ltd., Shenzhen EMC Laboratory is accredited by the American Association for Laboratory Accreditation (A2LA). Certificate No. 3816.01.

- **VCCI**

The 10m Semi-anechoic chamber and Shielded Room of SGS-CSTC Standards Technical Services Co., Ltd. have been registered in accordance with the Regulations for Voluntary Control Measures with Registration No.: G-823, R-4188, T-1153 and C-2383 respectively.

- **FCC – Registration No.: 556682**

SGS-CSTC Standards Technical Services Co., Ltd., Shenzhen EMC Laboratory has been registered and fully described in a report filed with the (FCC) Federal Communications Commission. The acceptance letter from the FCC is maintained in our files. Registration No.: 556682.

- **Industry Canada (IC)**

Two 3m Semi-anechoic chambers and the 10m Semi-anechoic chamber of SGS-CSTC Standards Technical Services Co., Ltd. Shenzhen Branch EMC Lab have been registered by Certification and Engineering Bureau of Industry Canada for radio equipment testing with Registration No.: 4620C-1, 4620C-2, 4620C-3.



6 Equipment Used during Test

RE in Chamber						
Item	Test Equipment	Manufacturer	Model No.	Inventory No.	Cal. Date (yyyy-mm-dd)	Cal. Due date (yyyy-mm-dd)
1	3m Semi-Anechoic Chamber	AUDIX	N/A	SEM001-02	2017-05-10	2018-05-10
2	EXA Spectrum Analyzer	Agilent Technologies Inc	N9010A	SEM004-09	2016-07-19	2017-07-19
3	Log Antenna (26-3000MHz)	ETS-Lindgren	3142C	SEM003-02	2014-11-15	2017-11-15
4	Amplifier (0.1-1300MHz)	HP	8447D	SEM005-02	2016-10-09	2017-10-09
5	Horn Antenna (1-18GHz)	Rohde & Schwarz	HF907	SEM003-07	2015-06-14	2018-06-14
6	Horn Antenna (18-26GHz)	ETS-Lindgren	3160	SEM003-12	2014-11-24	2017-11-24
7	Horn Antenna(26GHz-40GHz)	A.H.Systems, inc.	SAS-573	SEM003-13	2015-02-12	2018-02-12
8	Low Noise Amplifier	Black Diamond Series	BDLNA-0118-352810	SEM005-05	2016-10-09	2017-10-09
9	Band filter	Amindeon	Asi 3314	SEM023-01	N/A	N/A

RE in Chamber						
Item	Test Equipment	Manufacturer	Model No.	Inventory No.	Cal. Date (yyyy-mm-dd)	Cal. Due date (yyyy-mm-dd)
1	10m Semi-Anechoic Chamber	SAEMC	FSAC1018	SEM001-03	2017-05-10	2018-05-10
2	EMI Test Receiver (9k-7GHz)	Rohde & Schwarz	ESR	SEM004-03	2016-04-25	2018-04-25
3	log-Broadband Antenna(30M-1GHz)	Schwarzbeck	VULB9168	SEM003-18	2016-06-29	2019-06-29
4	Pre-amplifier	Sonoma Instrument Co	310N	SEM005-03	2017-06-05	2018-06-04
5	Loop Antenna	ETS-Lindgren	6502	SEM003-08	2015-08-14	2018-08-14



**SGS-CSTC Standards Technical Services Ltd.
Shenzhen Branch**

Report No.: SZEM170600640813

Page: 8 of 57

RF connected test						
Item	Test Equipment	Manufacturer	Model No.	Inventory No.	Cal. Date (yyyy-mm-dd)	Cal. Due date (yyyy-mm-dd)
1	EXG Analog Signal Generator	KEYSIGHT	N5171B	SEM006-04	2014-08-27	2017-08-27
2	ESG vector signal generator	Agilent Technologies	E4438C	SEM006-03	2016-07-19	2017-07-19
3	Power Meter	Rohde & Schwarz	NRVS	SEM014-02	2016-10-09	2017-10-09
4	ESG Vector Signal Generator	KEYSIGHT	E4438C	MT-W520	2016-01-04	2018-01-03
5	PXA Signal Analyzer	KEYSIGHT	N9030A	MT-W521	2016-01-07	2018-01-06
6	Attenuator	HUAXIANG	10048953	MT-W504	2016-11-15	2018-11-14
7	Temperature chamber	ESPEC	EW1040	MT-X003	2016-10-04	2017-11-03



7 Test Results

7.1 E.U.T. test conditions

Input voltage:	AC 120V
Test voltage	Normal AC120V
	Extreme AC102V~AC138V
Operating Environment:	
Test Temperature:	Normal 22°C ~26°C
	Extreme -30~50°C
Humidity:	46%~56% RH
Atmospheric Pressure:	990~1005mbar
Test Requirement:	The RF output power of the EUT was measured at the antenna port, by adjusting the input power of signal generator to drive the EUT to get to maximum output power point and keep the EUT at maximum gain setting for all tests. The device should be tested on downlink. For detail test Modulation and Frequency, please refer to 7.2.

Remark:

FIBER-OPTIC AND OTHER SIMILAR RF DISTRIBUTION SYSTEMS

Fiber-optic distribution systems are a type of in-building radiation system that receives RF signals from an antenna, distributes the signal over fiber-optic cable, and then retransmits at another location for example within a building or tunnel. Most fiber-optic systems are signal boosters; however, some may be repeaters. These systems generally have two enclosures typically called host (or local or donor unit) and remote. Some systems may also have an optional expander box for fan-out to multiple remotes. The system transmits downlink signals from the remote unit to handsets, portables, or clients, and transmits uplink signals via from the host unit. Usually but not always the uplink goes through an intermediate amplifier to a "donor" antenna. Therefore both uplink and downlink must be tested, unless filing effectively documents how connection of uplink to donor antenna with or without an intermediate amplifier will be prevented, such as for always only a cabled connection to a base station. Fiber-optic systems are not amplifiers (AMP equipment class) – they are equipment class TNB or PCB. The same approval procedures also apply for multiple-enclosure systems connected by coax cable.

Synonyms and related terms: in-building radiation system, coverage enhancer, distributed antenna system, fiber-optic distribution system, converter, donor antenna

Typical in-building or distributed antenna systems can consist of five different components (enclosures), not counting antennas:

1) **host unit**

- a) transmits uplink to base station via antenna thru coax, **passive interface unit**, or **active interface unit** (amplifier)
- b) sends base-station downlink via fiber-optic or coax to **remote**
- c) receives handset uplink via fiber-optic or coax from **remote**
- d) optional connection to **expansion unit** via fiber-optic
- e) separate FCC ID from **remote**, unless electrically identical
- f) **non-transmitting host unit**
- i) connects directly to a base station via coax cable but does not connect to antenna or amplifier
- ii) Part 15 digital device subject to Verification, no FCC ID

2) **remote unit**

- a) receives base-station downlink via fiber-optic or coax from **host**, transmits via antenna to handsets
- b) returns handset uplink via fiber-optic or coax to **host**



c) separate FCC ID from **remote**, unless electrically identical

3) expansion unit

- a) fiber-optic or coax from **host**
- b) fiber-optic or coax fan-out to **remote(s)**
- c) Part 15 digital device subject to Verification, no FCC ID

4) passive interface unit

- a) contains attenuators, splitters, combiners
- b) coax cable connection between **host** and base-station
- c) passive device, no FCC ID

5) active interface unit

- a) amplifies uplink signal from **host unit** for transmit by donor antenna
- b) attenuates downlink from donor antenna
- c) coax cable connection between **host** and **active interface unit**
- d) usually has separate FCC ID; in some cases could be combined/included with **host** as one enclosure

GENERAL DEFINITIONS FOR CERTIFICATION PURPOSES:

The following three general definitions follow from those stated in the Part 22 and 24 rule sections as listed above. Two of the definitions replace previous EAB internal definitions given for booster, repeater and extender. The general term “extender” is the same as booster, but booster should be used rather than extender. The general term “translator” is the same as repeater, but repeater should be used rather than translator.

External radio frequency power amplifier (ERFPA) - any device which, (1) when used in conjunction with a radio transmitter signal source, is capable of amplification of that signal, and (2) is not an integral part of a radio transmitter as manufactured. The EAS equipment class AMP is used only for an ERFPA device inserted between a transmitter (TNB/PCB) and an antenna (has only one antenna port) **Booster** is a device that automatically reradiates signals from base transmitters without channel translation, for the purpose of improving the reliability of existing service by increasing the signal strength in dead spots. An “in-building radiation system” is a signal booster. These devices are not intended to extend the size of coverage from the originating base station. A booster can be either single or multiple channels.

Repeater is a device that retransmits the signals of other stations. Repeaters are different from boosters in that they can include frequency translation and can extend coverage beyond the design of the original base station. A repeater is typically single channel but can also be multiple channels.

ERFPA (AMP) and boosters/repeaters (TNB/PCB) can generally be authorized for all rule parts except 15 and 18.

Tests should be done with each typical signal. e.g., for F3E emissions use 2500 Hz with 2.5 or 5 kHz deviation. Use of CW signal for some tests is acceptable in lieu of actual emission, in some cases when CW signal gives worst case.

The GX system working principle: the RF signal coupled from BTS is transferred into optical signal, and then transmitted via a fiber to remote unit. The remote re-transfers the optical signal back to RF signal, through the frequency translation and after power amplifiers, can extend the BTS coverage to another desired area, the GX system is compliant with the description about repeater in FCC rules, So **the Equipment belongs to the repeater and TNB class.**



7.2 Test Procedure & Measurement Data

Test Bandwidth and Frequency

Downlink: 2350MHz to 2360MHz

LTE Bandwidth	Lowest frequency(MHz)	Middle frequency(MHz)	Highest frequency(MHz)
5MHz	2352.5	2355	2357.5
10MHz	/	2355	/

Remark:

- 1) We test the downlink in the band and test the respective frequency as above table;

7.2.1 RF Output Power

Test Requirement: FCC part 27.50(b)(4)& FCC part 27.50 (c)(3)
 Test Method: KDB 935210 D05 Indus Booster Basic Meas v01r01
 EUT Operation:
 Status: Drive the EUT to maximum output power.
 Conditions: Normal conditions
 Application: Cellular Band RF output ports
 Test Configuration:

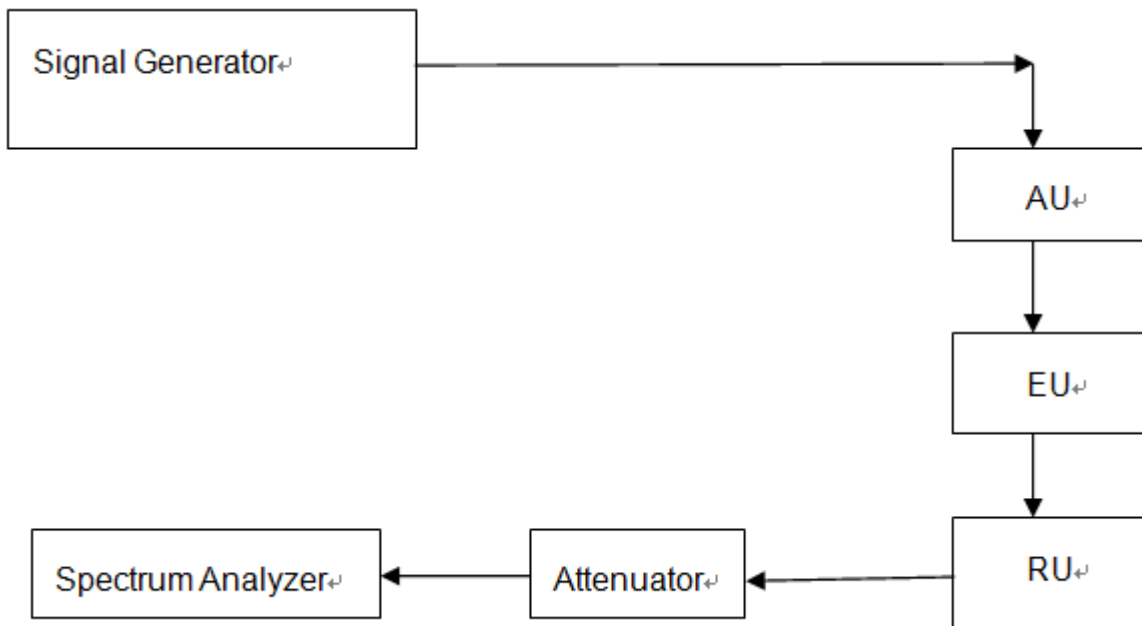

Fig.1 RF Output Power test configuration



SGS-CSTC Standards Technical Services Ltd. Shenzhen Branch

Report No.: SZEM170600640813

Page: 13 of 57

Test Procedure:

RF output power test procedure:

For part 27:

- a) Connect the equipment as illustrated, when the output power is over the max value of the Spectrum Analyzer, add the attenuator to avoid destroying the facility.
- b) Set the signal power level of the Signal Generator to 0dBm, and the modulation of the signal is 64QAM
- c) Set the center frequency of the spectrum analyzer to the assigned transmitter frequency, key the transmitter, and set the level of the carrier to the full scale reference line.
- d1) Adjust the spectrum analyzer for the following settings:
 - 1) Resolution Bandwidth $\gg 1\%$ the carrier bandwidth,
 - 2) Video Bandwidth refers to standard requirement.
- d2) Use spectrum analyzer channel power measurement function;
- e) Record the frequencies and levels of carrier power;
- f) Calculate the signal link way loss and final power value.

Remark:

The system continuously monitors the input power.

Once the detected input power is greater than nominal input power (0dBm for downlink and -50dBm for uplink), the signal will be reduced to nominal input power by automatically adjusting attenuation.



7.2.1.1 Measurement Record:

RF Conducted Power:
Downlink: 2350MHz to 2360MHz

LTE Bandwidth	Lowest frequency (dBm)	Middle frequency (dBm)	Highest frequency (dBm)
5MHz	42.74	42.78	42.64
10MHz	/	42.56	/

Remark: The limit of the Output Power is 43dBm (+1dB,-2dB)

7.2.2 Conducted Spurious Emissions

Test Requirement: FCC part 27.53(h) The limit is = -13 dBm.
 Test Method: KDB 935210 D05 Indus Booster Basic Meas v01r01
 EUT Operation:
 Status: Drive the EUT to maximum output power.
 Conditions: Normal conditions
 Application: Cellular Band RF output ports
 Test Configuration:

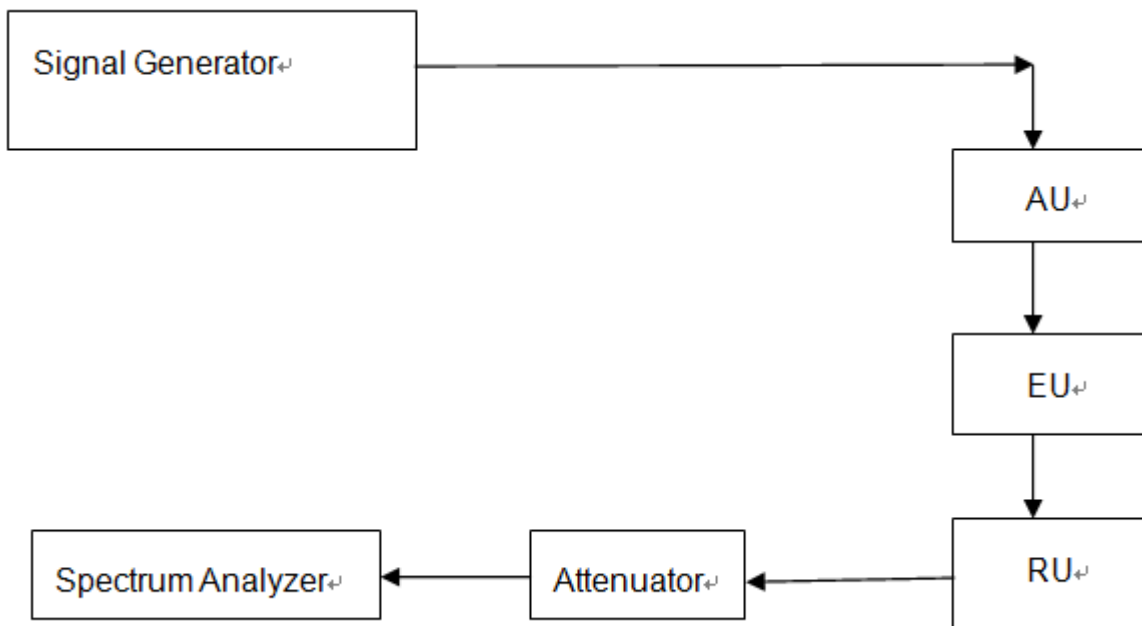

Fig.2. Conducted Spurious Emissions test configuration



SGS-CSTC Standards Technical Services Ltd. Shenzhen Branch

Report No.: SZEM170600640813

Page: 16 of 57

Test Procedure:

Conducted Emissions test procedure:

- a) Connect the equipment as illustrated, with the notch filter by-passed, when the output power is over the max value of the Spectrum Analyzer; add the attenuator to avoid destroying the facility.
- b) Set the center frequency of the spectrum analyzer to the assigned transmitter frequency, key the transmitter, and set the level of the carrier to the full scale reference line.
- c) Add one 64QAM modulation signal to the EUT and the level of the signal is 0dBm.
- d) Adjust the spectrum analyzer for the following settings:
 - 1) Resolution Bandwidth,(base the standard, apply the different set),her is 100KHz for frequency band less than 1GHz, 1MHz for frequency over 1GHz;
 - 2) Video Bandwidth refers to standard requirement.
- e) Adjust the center frequency of the spectrum analyzer for incremental coverage of the range from:
 - 1) the lowest radio frequency generated in the equipment, it can be 9KHz base the test method, here select 30MHz as lowest frequency start point;
 - 2) the highest radio frequency shall higher than 10 times of carrier frequency;
- f) Record the frequencies and levels of spurious emissions from step e)

Remark:

The notch filter is used for avoid the EUT fundamental carrier output power making the spectrum overload and the harmonic spurious brought by it.

When the EUT fundamental carrier is not enough to make the status, the notch filter could be not used.

Pretest the EUT on mode with 5M LTE signal input and 10M LTE signal input, found the 5M LTE signal input is worse and reports it.



7.2.2.1 Measurement Record:

- 1. Downlink: 2350MHz ~ 2360MHz(LTE)
- 1.1 lowest frequency:
9KHz to 1GHz

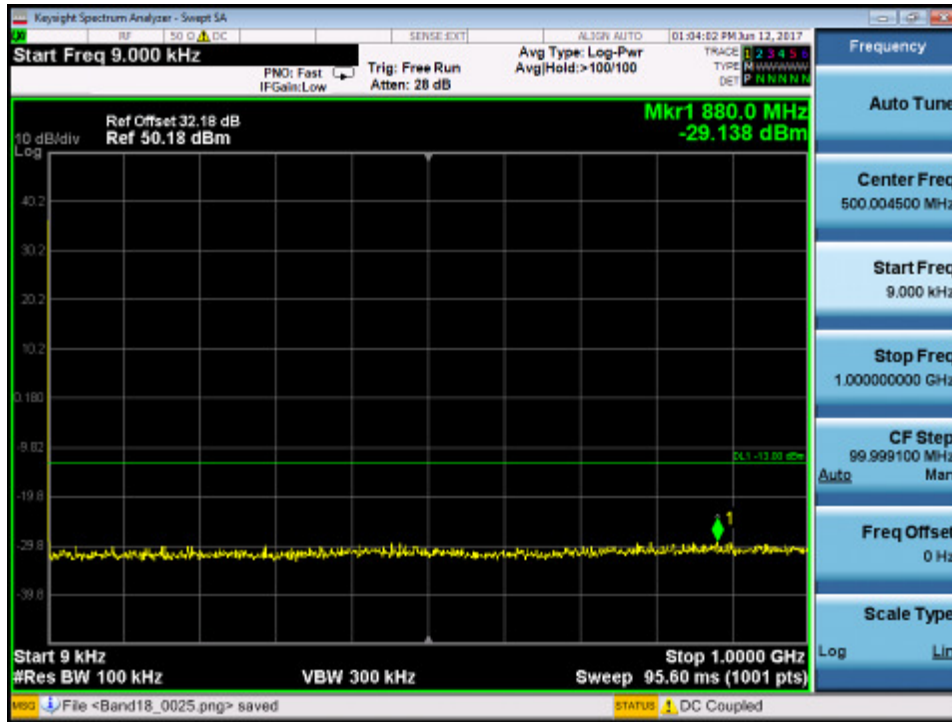



SGS-CSTC Standards Technical Services Ltd. Shenzhen Branch

Report No.: SZEM170600640813
Page: 18 of 57

1GHz to 5GHz

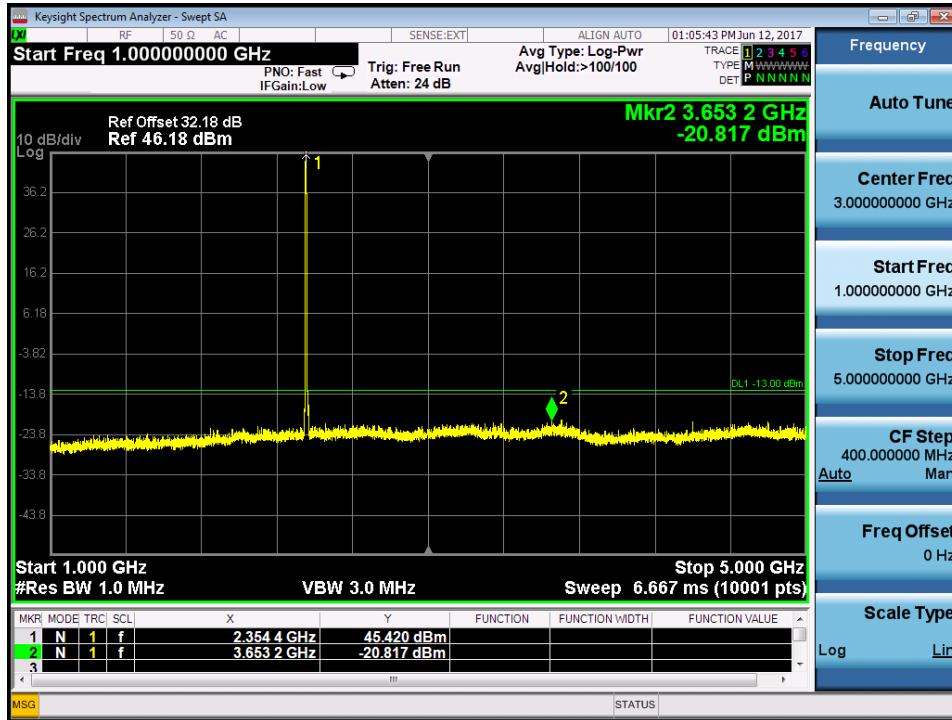

5GHz to 10GHz

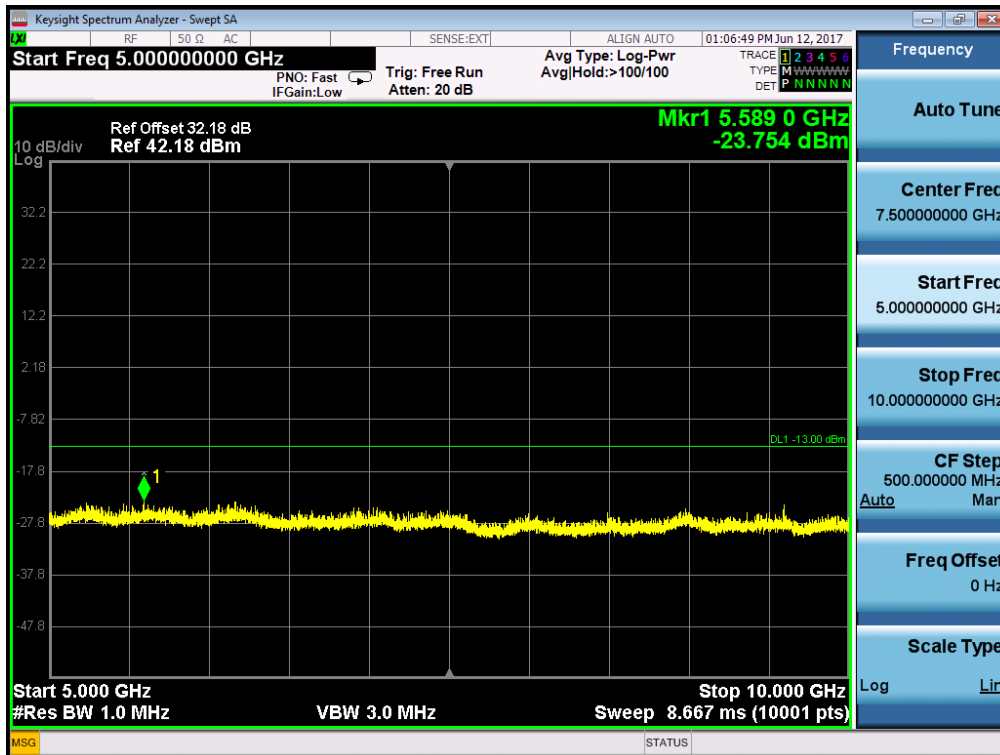



10GHz to 15GHz

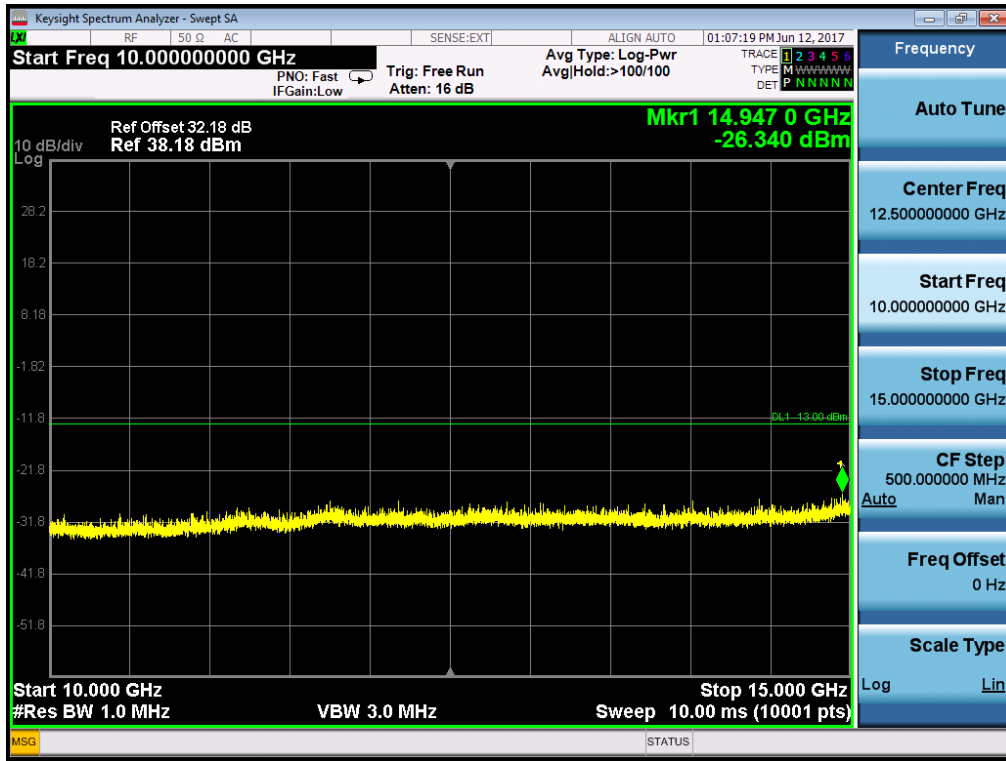

15GHz to 20GHz

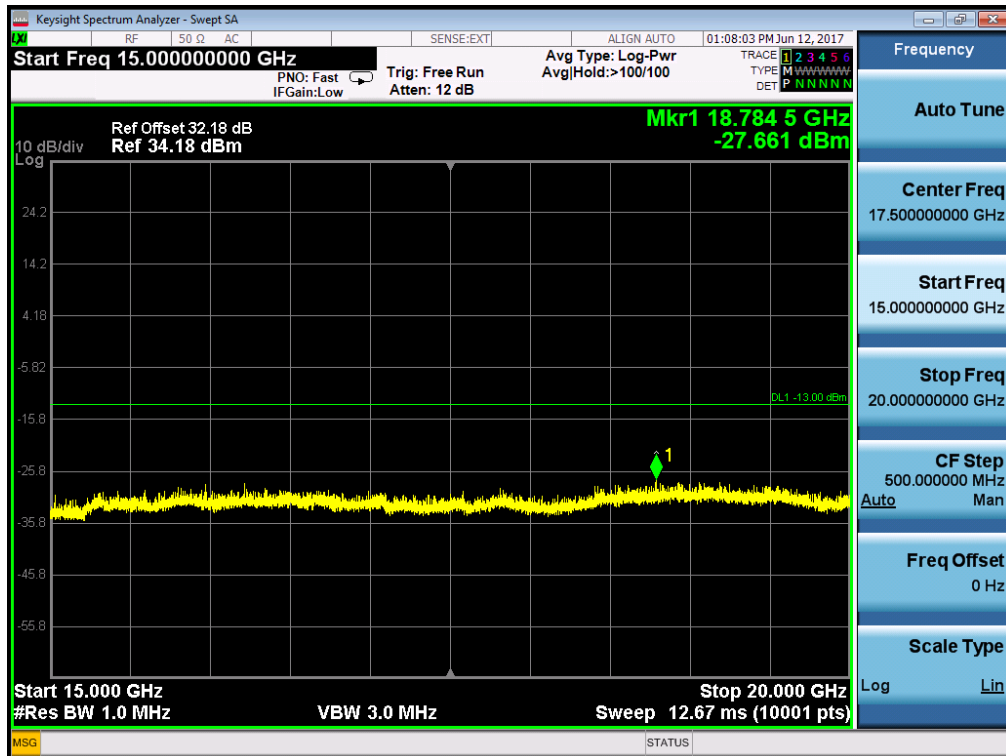



SGS-CSTC Standards Technical Services Ltd. Shenzhen Branch

Report No.: SZEM170600640813
Page: 20 of 57

20GHz to 25GHz





1.2 Middle frequency
9KHz to 1GHz

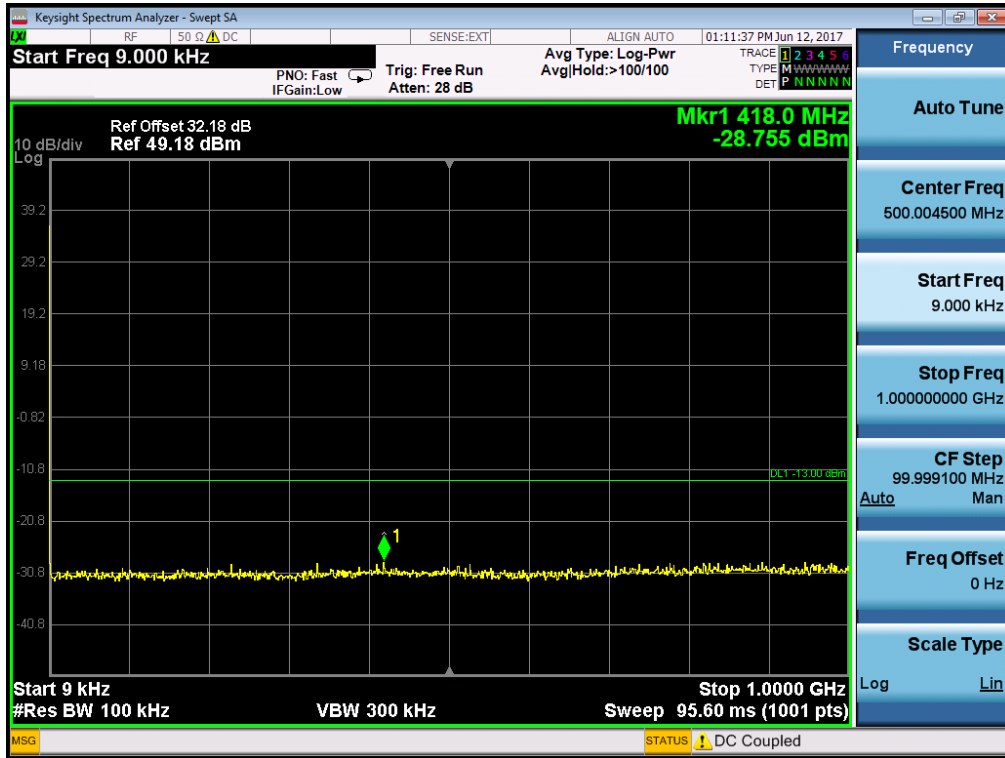

1GHz to 5GHz

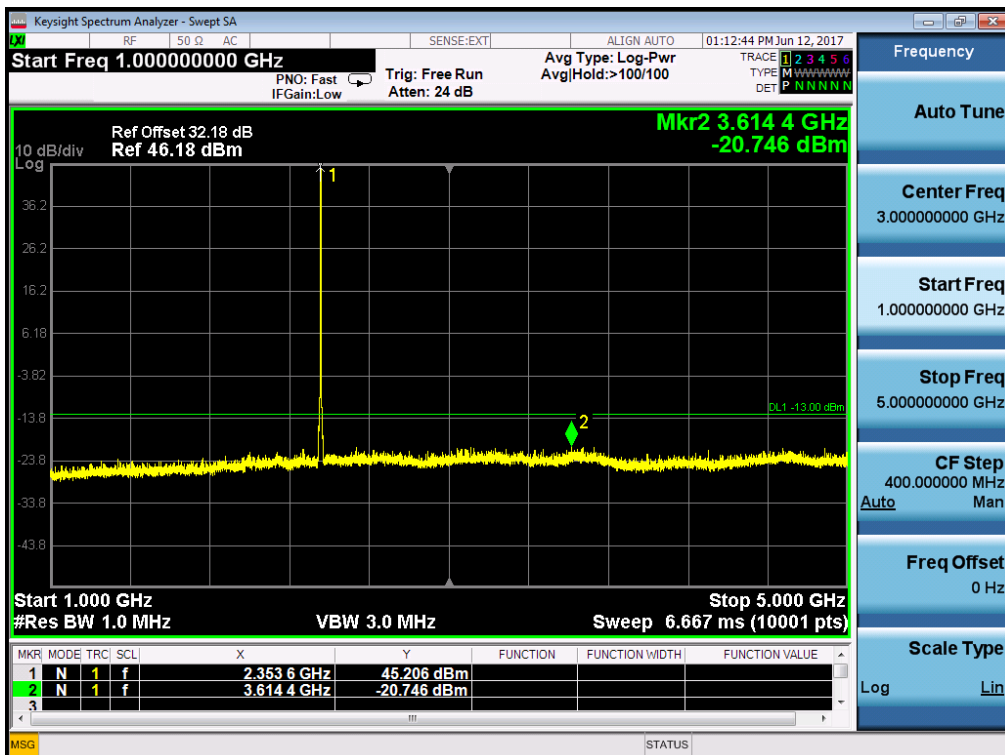



5GHz to 10GHz

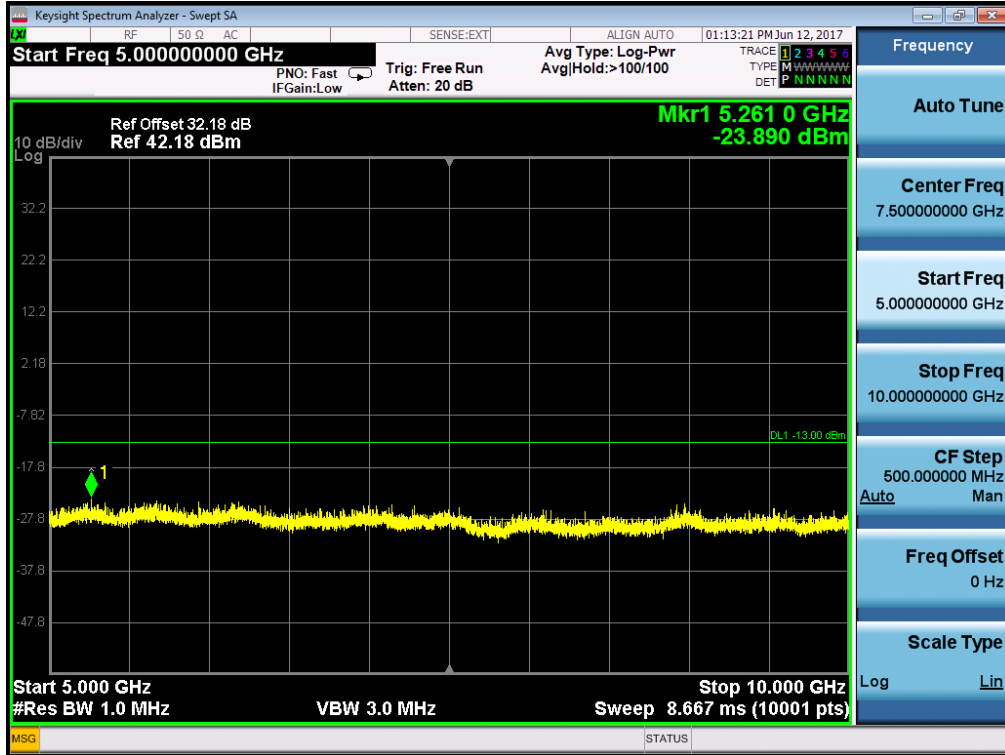

10GHz to 15GHz





15GHz to 20GHz

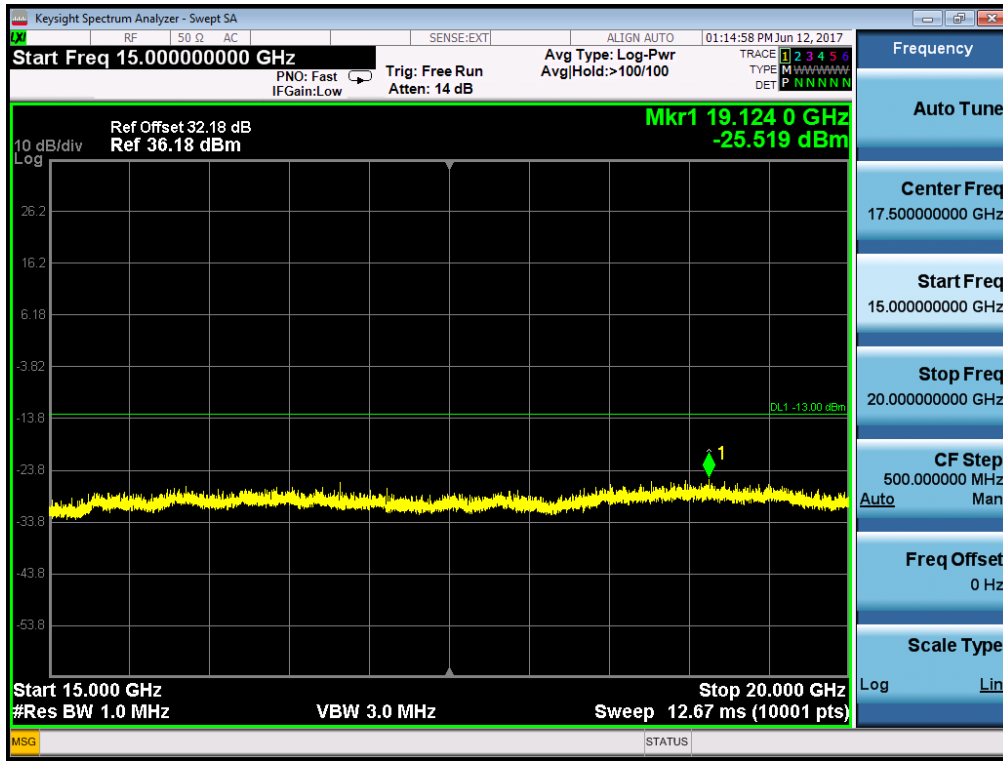

20GHz to 25GHz





1.3 highest frequency
9KHz to 1GHz

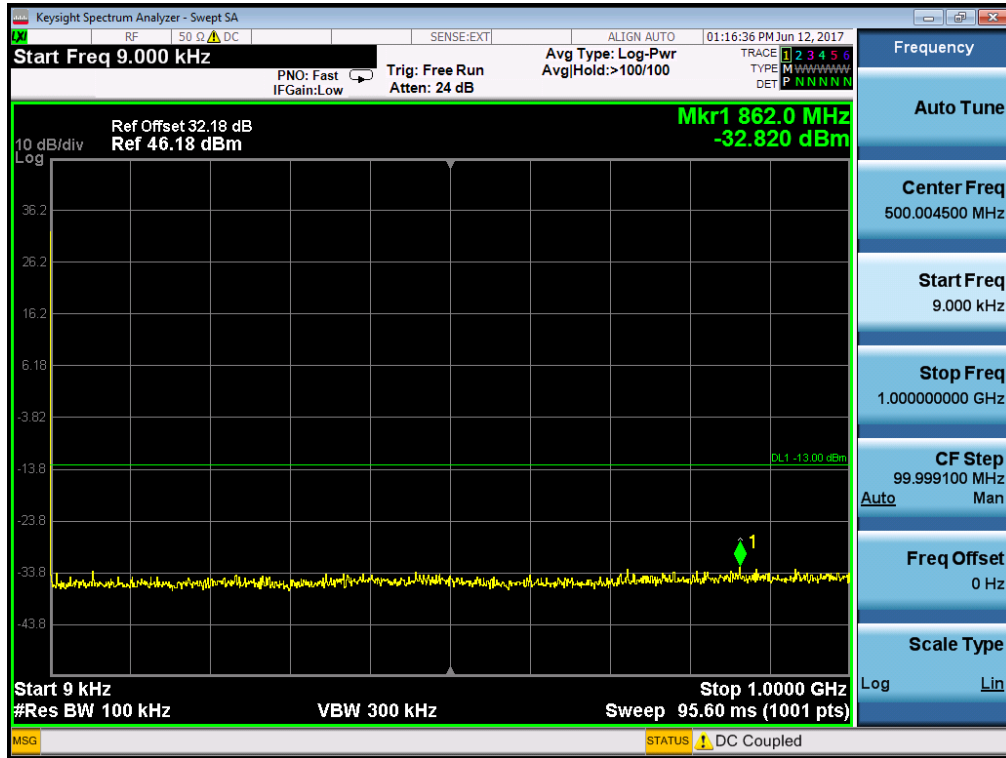

1GHz to 5GHz

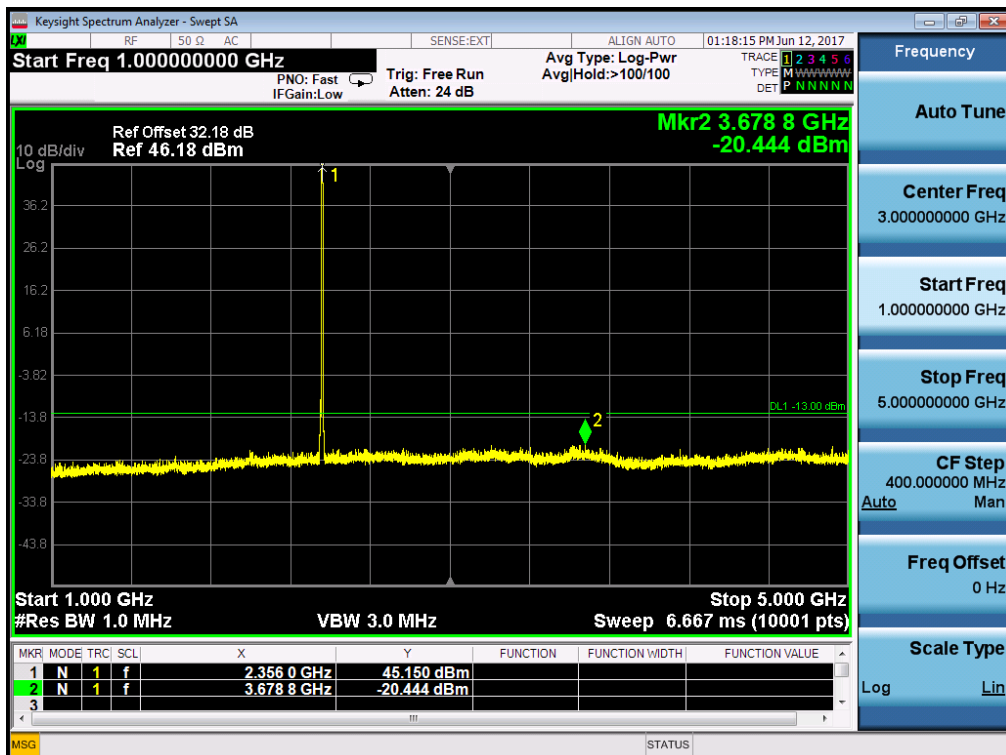



SGS-CSTC Standards Technical Services Ltd. Shenzhen Branch

Report No.: SZEM170600640813
Page: 25 of 57

5GHz to 10GHz

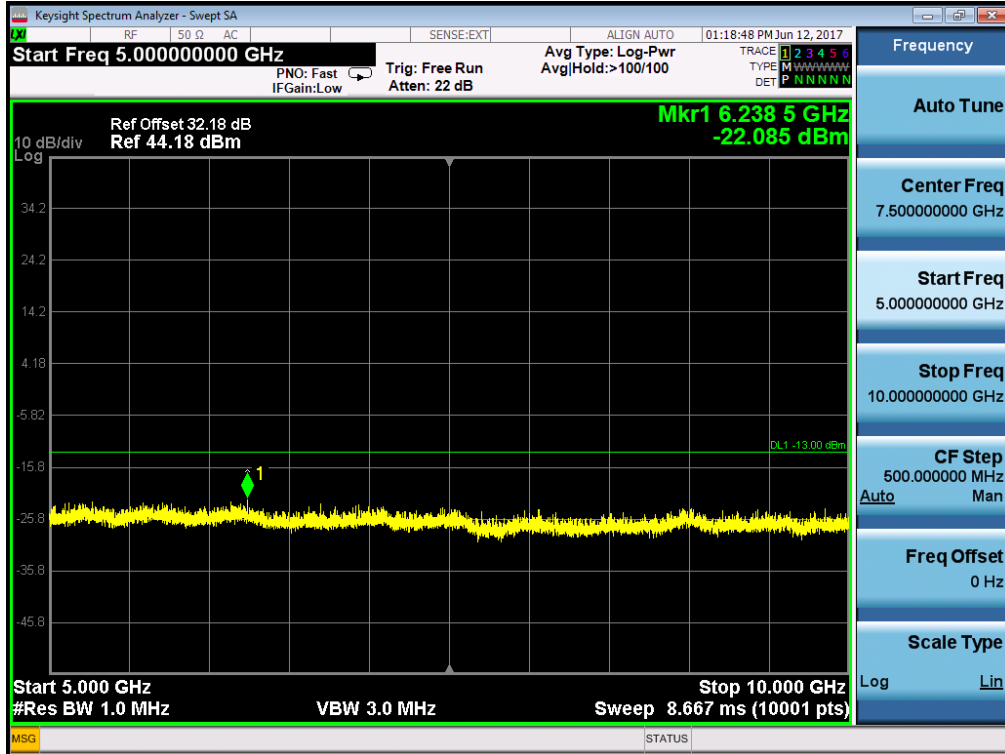

10GHz to 15GHz

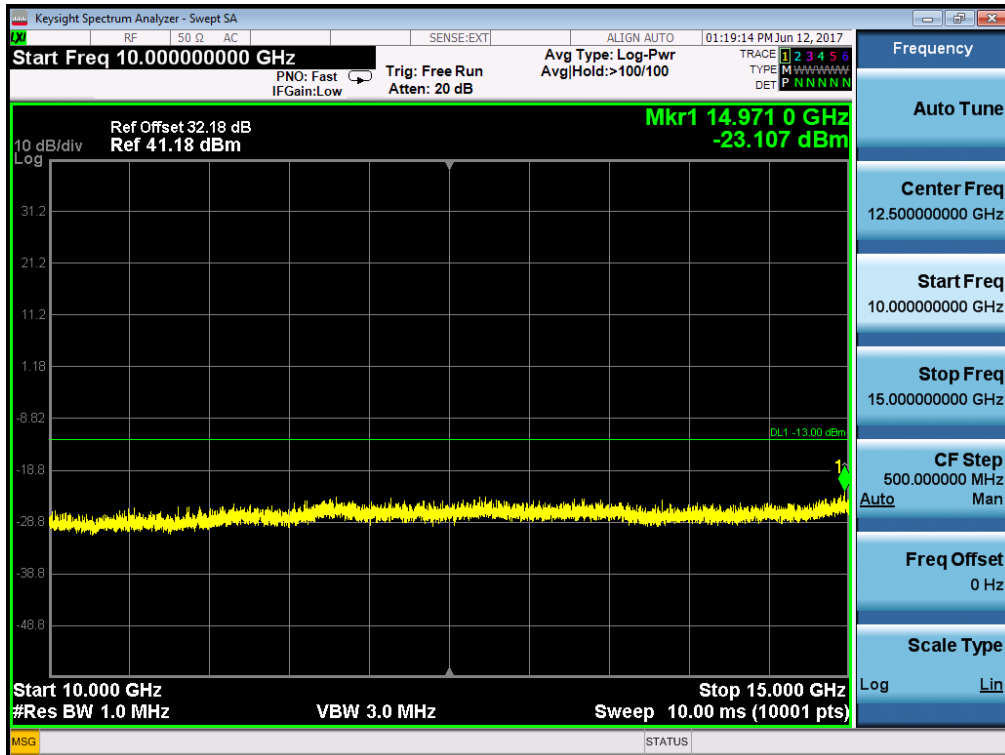



SGS-CSTC Standards Technical Services Ltd. Shenzhen Branch

Report No.: SZEM170600640813
Page: 26 of 57

15GHz to 20GHz

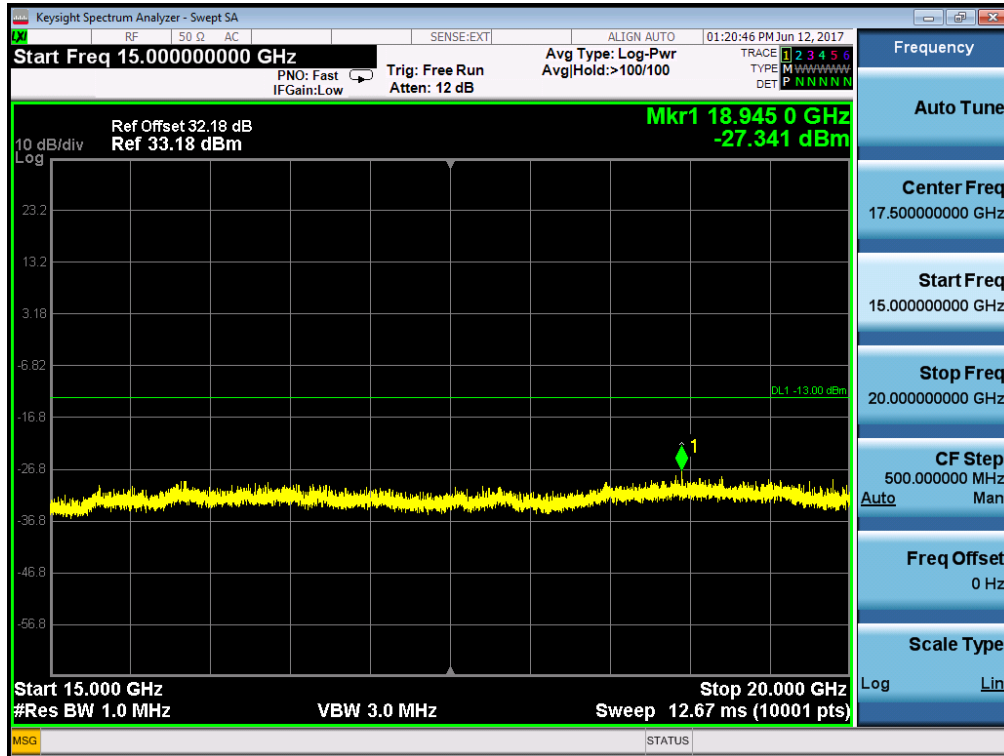

20GHz to 25GHz

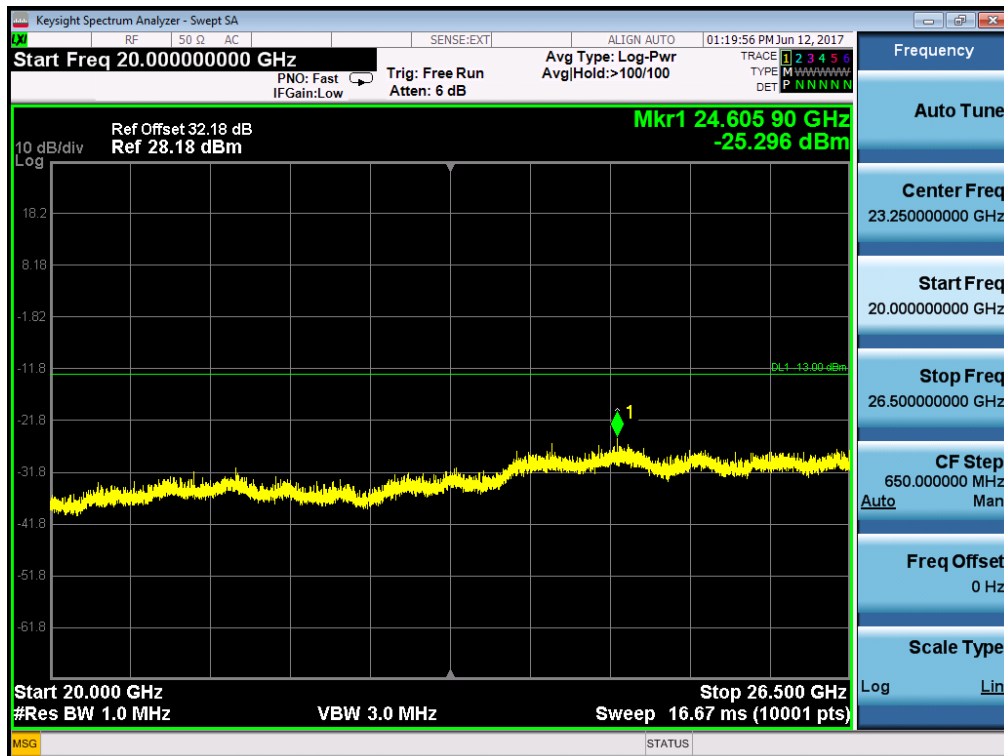

7.2.3 Band Edge

Test Requirement:	FCC part 27.53(h) The limit is = -13 dBm.
Test Method:	KDB 935210 D05 Indus Booster Basic Meas v01r01
EUT Operation:	
Status:	Drive the EUT to maximum output power.
Conditions:	Normal conditions
Application:	Cellular Band RF output ports
Test Configuration:	

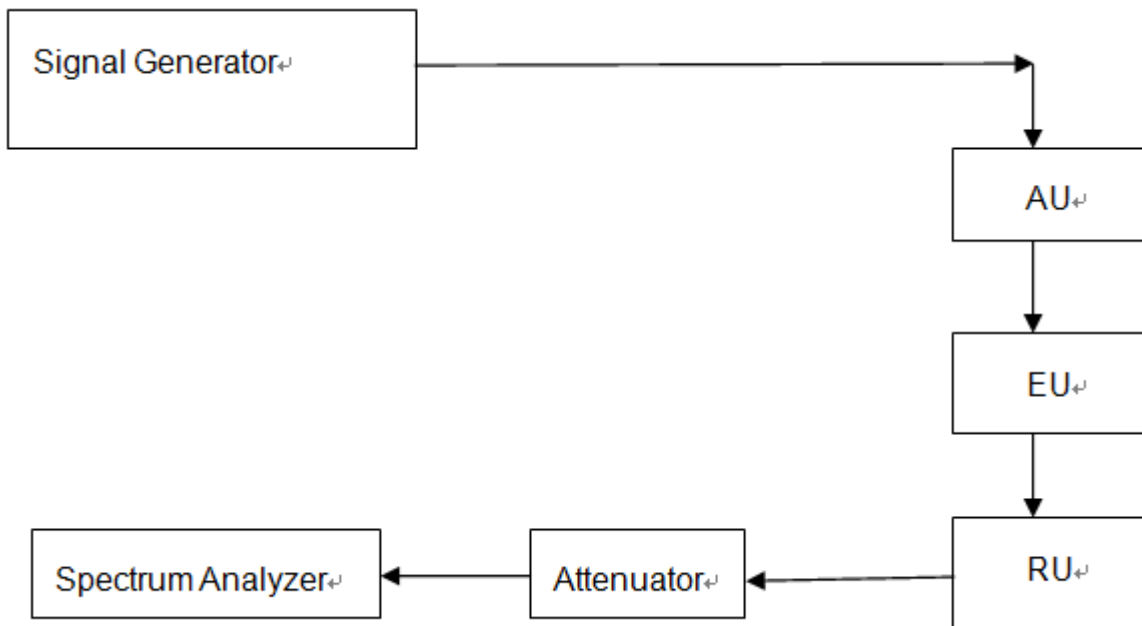

Fig.3. Band edge and Intermodulation test configuration

- Test Procedure: Conducted Emissions test procedure:
- a) Connect the equipment as illustrated, with the notch filter by-passed, when the output power is over the max value of the Spectrum Analyzer, add the attenuator to avoid destroying the facility.
 - b) Set the center frequency of the spectrum analyzer to the assigned transmitter frequency, key the transmitter, and set the level of the carrier to the full scale reference line.
 - c) Add one 64QAM modulation signal and the level of the signal is 0dBm to the signal generator.
 - d) Adjust the spectrum analyzer for the following settings:
 - 1) Resolution Bandwidth,(base the standard, apply the different set),here is 100KHz for frequency band less than 1GHz, 1MHz for frequency over 1GHz;
 - 2) Video Bandwidth refers to standard requirement.
 - e) Adjust the center frequency of the spectrum analyzer for incremental coverage of the range from:
 - 1) the lowest radio frequency generated in the equipment, it can be 9KHz



SGS-CSTC Standards Technical Services Ltd. Shenzhen Branch

Report No.: SZEM170600640813

Page: 28 of 57

base the test method, here select 30MHz as lowest frequency start point;

- 2) the highest radio frequency shall higher than 10 times of carrier frequency;
- f) Record the frequencies and levels of spurious emissions from step e)

Remark:

1)The notch filter is used for avoid the EUT fundamental carrier output power making the spectrum overload and the harmonic spurious brought by it.

When the EUT fundamental carrier is not enough to make the status, the notch filter could be not used.

2)At maximum drive level, for each modulation: two tests (high-, low-band edge) with two tones

Limit usually is -13dBm conducted.

3)Not needed for Single Channel systems.

Test Frequency:

Downlink: 2350MHz to 2360MHz

LTE Bandwidth	Lowest frequency(MHz)	Highest frequency(MHz)
5MHz	2352.5	2357.5
10MHz	2355	2355



7.2.3.1 Measurement Record:

Downlink: 2350MHz to 2360MHz(LTE Mode)

1. 5MHz bandwidth

1.1 one signal input(Level=0dBm, modulation= LTE(64QAM),Frequency1=2352.5MHz) —Lower Edge

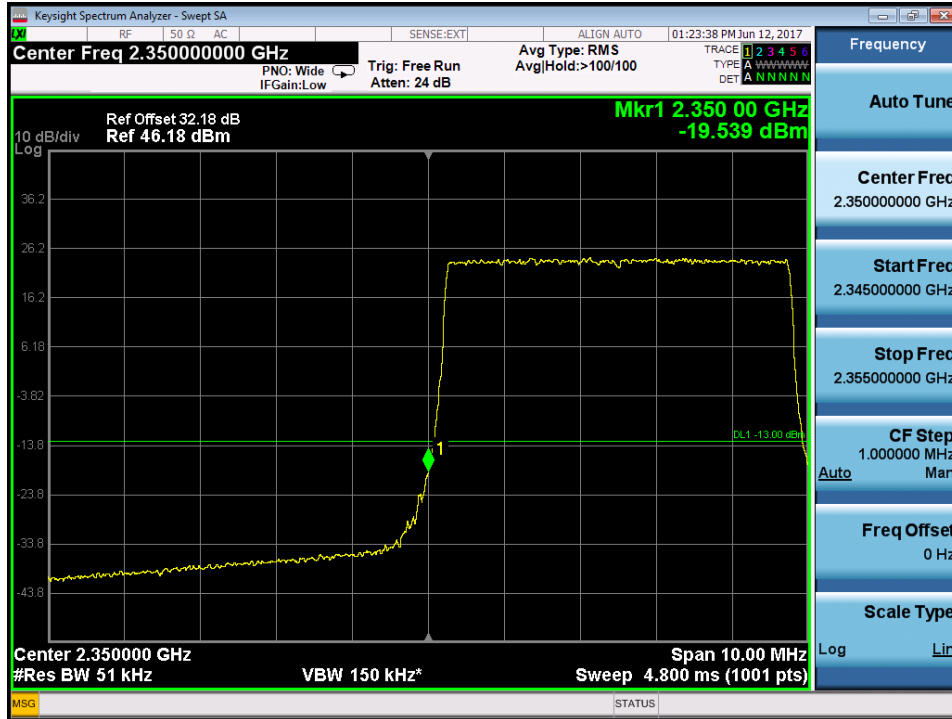

1.2 one signal input(Level=0dBm, modulation= LTE(64QAM),Frequency1=2357.5MHz) —Upper Edge





SGS-CSTC Standards Technical Services Ltd. Shenzhen Branch

Report No.: SZEM170600640813
Page: 30 of 57

1.3 two signal input(Level=0dBm, modulation= LTE(64QAM),Frequency1=2352.5MHz,
Frequency1=2357.5MHz) —Lower Edge

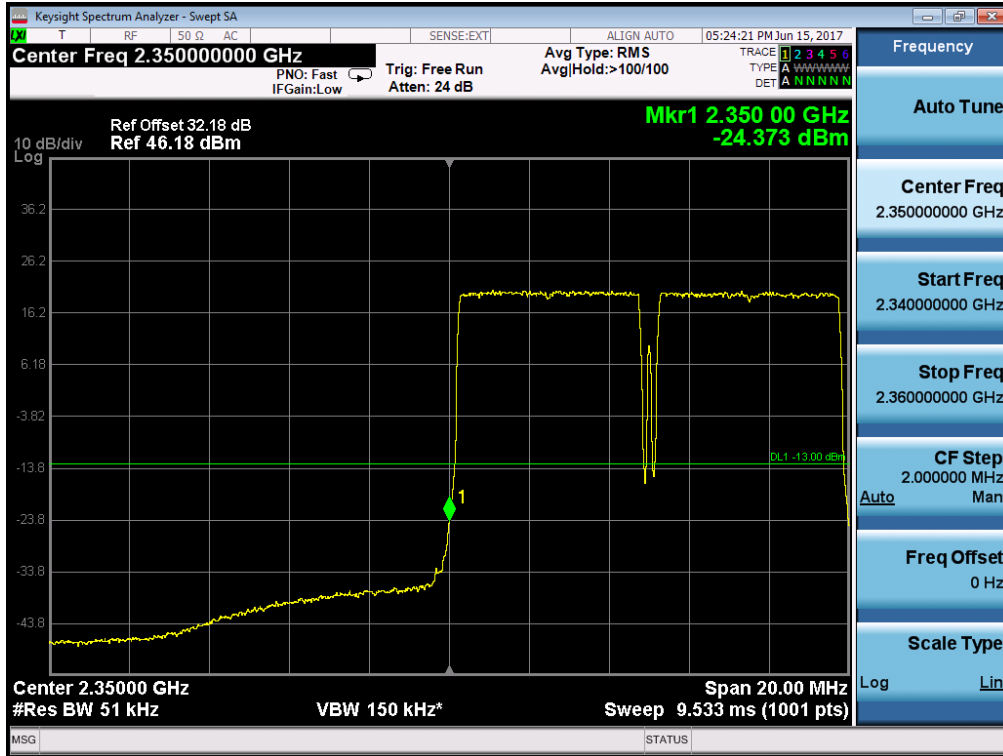

1.4 two signal input(Level=0dBm, modulation= LTE(64QAM),Frequency1=2352.5MHz,
Frequency1=2357.5MHz) —Upper Edge

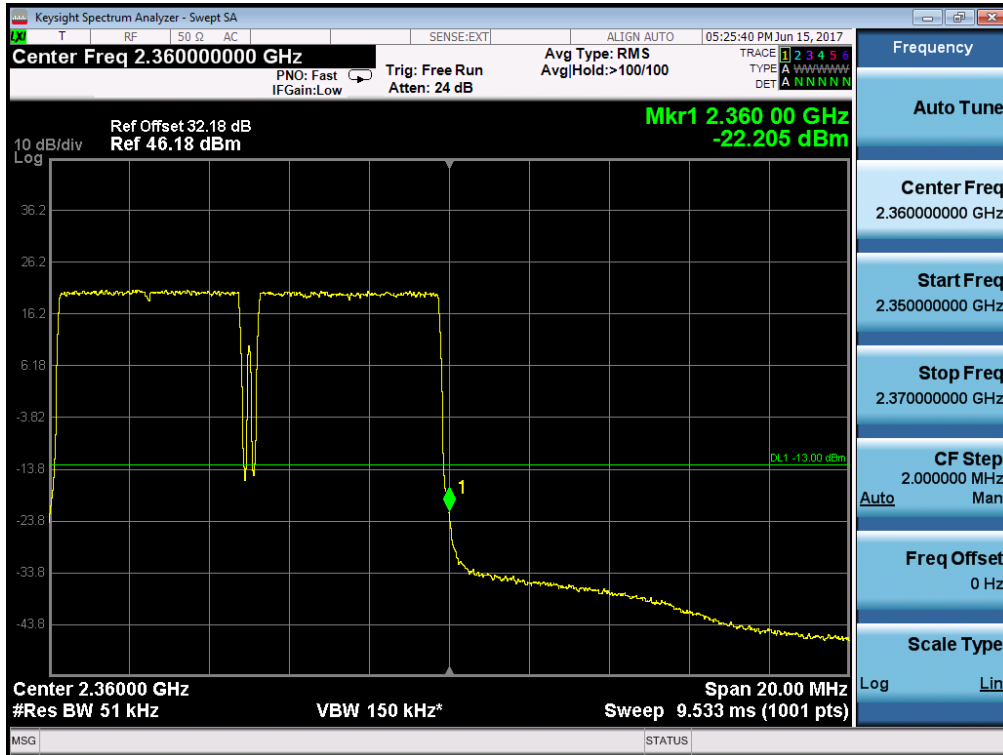



2. 10MHz bandwidth

2.1 one signal input(Level=0dBm, modulation= LTE(64QAM),Frequency1=2355MHz) —Lower Edge

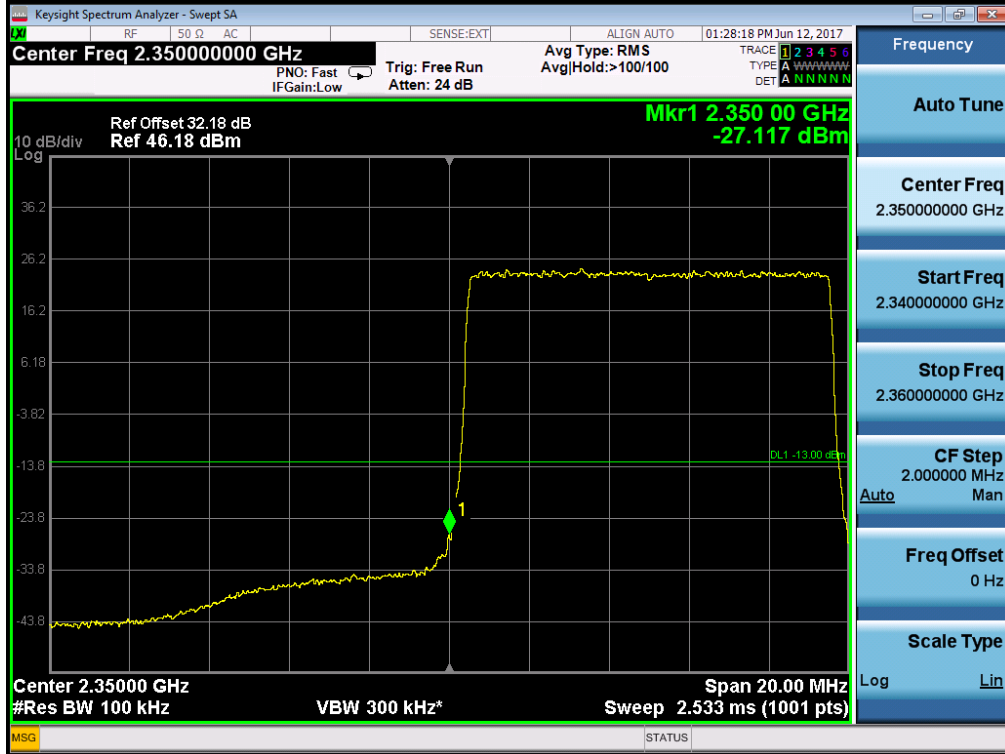

2.2 one signal input (Level=0dBm, modulation= LTE(64QAM),Frequency1=2355MHz)—Upper Edge



7.2.4 Radiated Spurious Emissions

Test Requirement: & FCC part 27.53(h) The limit is = -13 dBm.
 Test Method: KDB 935210 D05 Indus Booster Basic Meas v01r01
 EUT Operation:
 Status: Drive the EUT to maximum output power.
 Conditions: Normal conditions
 Application: Enclosure
 Test Configuration:

30MHz to 1GHz emissions:

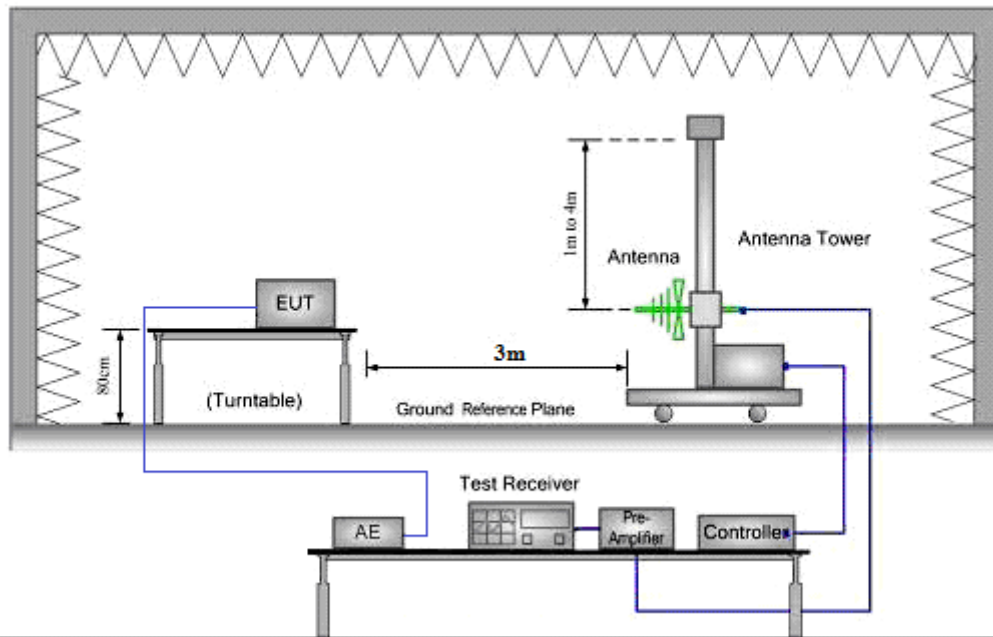

1GHz to 40GHz emissions:

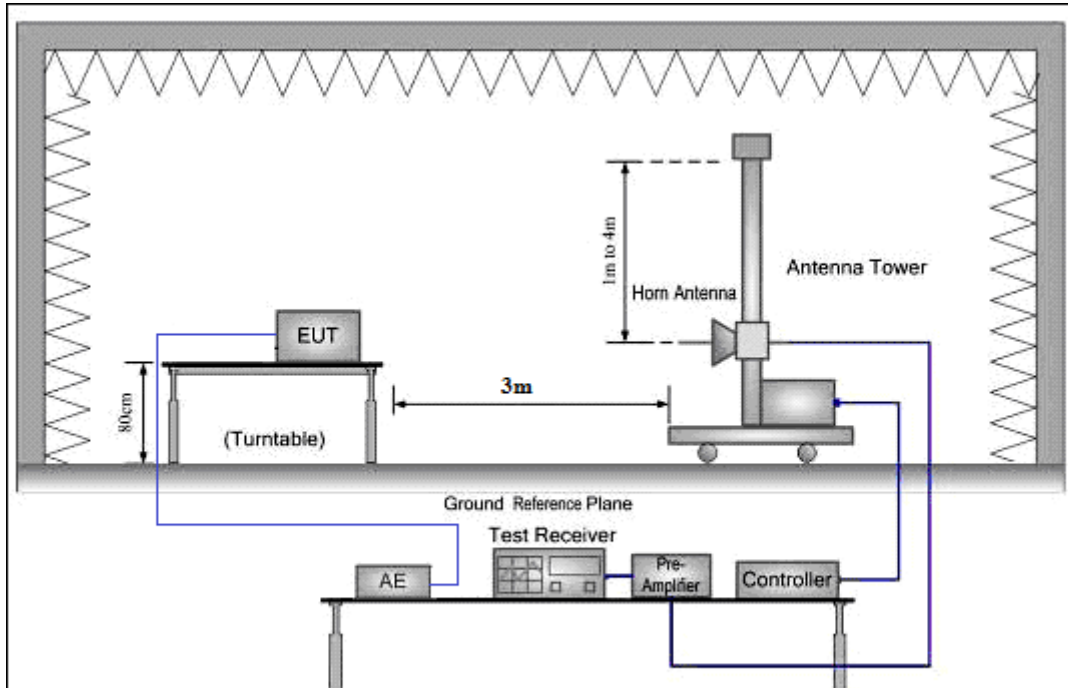

Test Procedure:

1. Test the background noise level with all the test facilities;
2. Keep one transmitting path, all other connectors shall be connected by normal power or RF leads;
3. Select the suitable RF notch filter to avoid the test receiver or spectrum analyzer produce unwanted spurious emissions;
4. Keep the EUT continuously transmitting in max power;
5. Read the radiated emissions of the EUT enclosure.

Radiated Emissions Test Procedure:

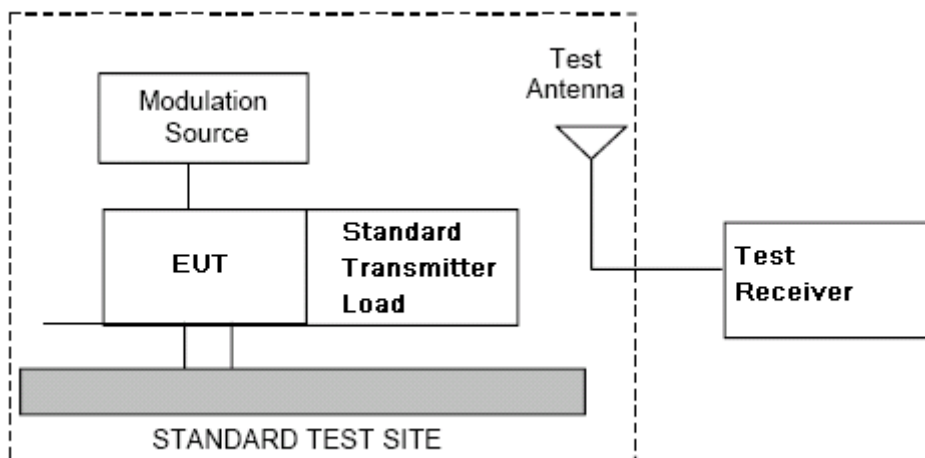

- a) Connect the equipment as illustrated.
- b) Adjust the spectrum analyzer for the following settings:
 - 1) Resolution Bandwidth = 100 kHz for spurious emissions below 1 GHz, and 1 MHz for spurious emissions above 1GHz.
 - 2) Video Bandwidth = 300 kHz for spurious emissions below 1 GHz, and 3 MHz for spurious emissions above 1 GHz.
 - 3) Sweep Speed slow enough to maintain measurement calibration.
 - 4) Detector Mode = Positive Peak.
- c) Place the transmitter to be tested on the turntable in the standard test site, The transmitter is transmitting into a no radiating load that is placed on the turntable. The RF cable to this load should be of minimum length.
- d) Measurements shall be made from 30MHz to 10 times of fundamental carrier, except for the region close to the carrier equal to \pm the carrier bandwidth.
- e) Key the transmitter without modulation or normal modulation base the standard.
- f) For each spurious frequency, raise and lower the test antenna from 1 m to 4 m to obtain a maximum reading on the spectrum analyzer with the test antenna at horizontal polarity. Then the turntable should be rotated 360° to determine the maximum reading. Repeat this procedure to obtain the highest possible reading. Record this maximum reading.
- g) Repeat step f) for each spurious frequency with the test antenna polarized vertically.

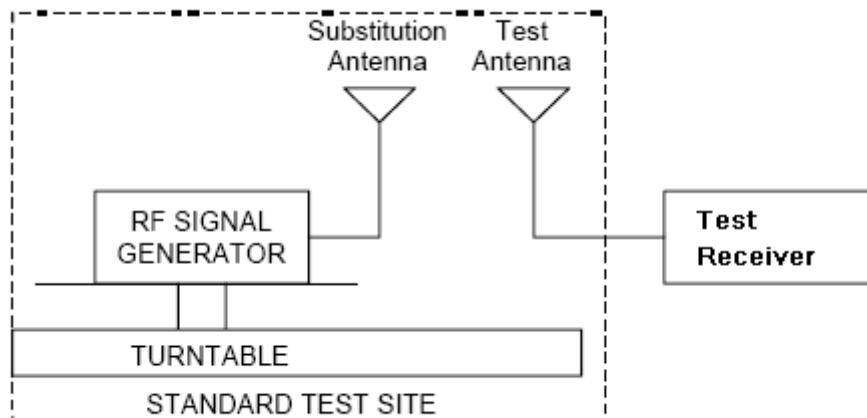



- h) Reconnect the equipment as illustrated.
- i) Keep the spectrum analyzer adjusted as in step b).
- j) Remove the transmitter and replace it with a substitution antenna (the antenna should be half-wavelength for each frequency involved). The center of the substitution antenna should be approximately at the same location as the center of the transmitter. At the lower frequencies, where the substitution antenna is very long, this will be impossible to achieve when the antenna is polarized vertically. In such case the lower end of the antenna should be 0.3 m above the ground.
- k) Feed the substitution antenna at the transmitter end with a signal generator connected to the antenna by means of a non-radiating cable. With the antennas at both ends horizontally polarized, and with the signal generator tuned to a particular spurious frequency, raise and lower the test antenna to obtain a maximum reading at the spectrum analyzer. Adjust the level of the signal generator output until the previously recorded maximum reading for this set of conditions is obtained. This should be done carefully repeating the adjustment of the test antenna and generator output.
- l) Repeat step k) with both antennas vertically polarized for each spurious frequency.
- m) Calculate power in dBm into a reference ideal half-wave dipole antenna by reducing the readings obtained in steps k) and l) by the power loss in the cable between the generator and the antenna, and further corrected for the gain of the substitution antenna used relative to an ideal half-wave dipole antenna by the following formula:

$$P_d(\text{dBm}) = P_g(\text{dBm}) - \text{cable loss (dB)} + \text{antenna gain (dB)}$$

where:

P_d is the dipole equivalent power and

P_g is the generator output power into the substitution antenna.

NOTE:

- 1) It is permissible to use other antennas provided they can be referenced to a dipole.
- 2) For below 1GHz signal, the *antenna gain* (dB) is dBd, and for above 1GHz signal, the *antenna gain* (dB) is dBi.
- 3) Effective radiated power (e.r.p) refers to the radiation of a half wave tuned dipole instead of an isotropic antenna. There is a constant difference of 2.15 dB between e.i.r.p. and e.r.p.
 $\text{e.r.p (dBm)} = \text{e.i.r.p. (dBm)} - 2.15$
- 4) for this test, the AU and EU are put outside of the chamber, connect to the RU through the optical fiber



7.2.4.1 Measurement Record:

No emissions were detected within 20dB below the limit for the Downlink direction.

Downlink : 2350MHz to 2360MHz

Middle channel					
Frequency	Spurious Emission Level			Limit	Over limit
(MHz)	(Deg)	Polaxis	(dBm)	dBm	(dB)
84.60	294.0	H	-73.88	-13.0	-60.88
336.60	108.0	H	-79.14	-13.0	-66.14
642.50	358.0	H	-84.98	-13.0	-71.98
1463.00	0.0	H	-66.14	-13.0	-53.14
1892.00	359.0	H	-62.61	-13.0	-49.61
2792.00	0.0	H	-57.00	-13.0	-44.00
4350.00	0.0	H	-68.07	-13.0	-55.07
7950.00	0.0	H	-65.11	-13.0	-52.11
9900.00	0.0	H	-65.76	-13.0	-52.76

Middle channel					
Frequency	Spurious Emission Level			Limit	Over limit
(MHz)	(Deg)	Polaxis	(dBm)	dBm	(dB)
72.00	162.0	V	-81.77	-13.0	-68.77
126.60	190.0	V	-78.19	-13.0	-65.19
620.50	0.0	V	-85.28	-13.0	-72.28
1031.00	0.0	V	-65.33	-13.0	-52.33
1793.00	0.0	V	-63.34	-13.0	-50.34
2648.00	0.0	V	-57.37	-13.0	-44.37
7050.00	0.0	V	-65.73	-13.0	-52.73
8700.00	0.0	V	-64.84	-13.0	-51.84
12300.00	0.0	V	-64.21	-13.0	-51.21

Remark:

The cabinet radiation was measured with the equipment transmitting a LTE signal into a non-radiating 50 Ohm load at maximum output power on a signal frequency .

Measured were performed in the lowest, middle and highest frequency for the Downlink.

The spectrum was searched from 30MHz to 26GHz (10th Harmonic) for downlink.

7.2.5 Occupied Bandwidth

Test Requirement:	FCC part 2.1049 The spectral shape of the output should look similar to input for all modulations.
EUT Operation:	
Status:	Drive the EUT to maximum output power. .
Conditions:	Normal conditions
Application:	Cellular Band RF output ports
Test Configuration:	

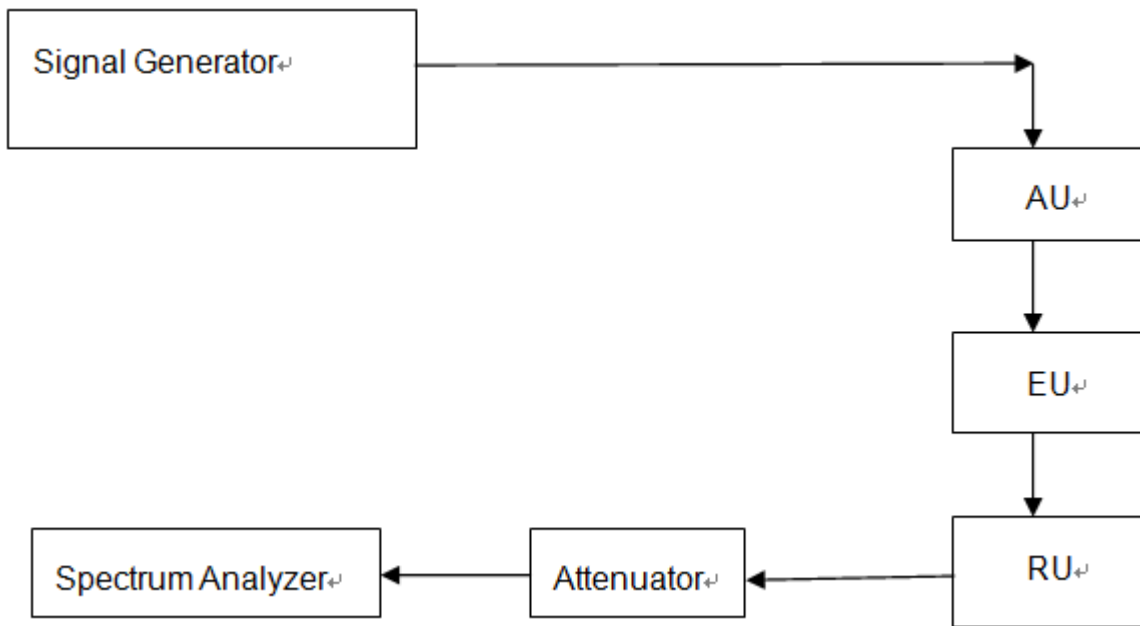

Fig.2. Conducted Spurious Emissions test configuration

Test Procedure:	<ol style="list-style-type: none"> a) Set the spectrum analyzer RBW 300 Hz or >1%&<2% emission bandwidth of carrier. b) Capture the trace of input signal; c) Connect the equipment as illustrated; d) Capture the trace of output signal; e) The signal add at the signal generator is 0dBm, and the modulation of the signal is 64QAM
-----------------	--



7.2.5.1 Measurement Record:

2.Downlink:2350MHz to 2360MHz(LTE mode)

2.1 lowest frequency – 5MHz bandwidth

Input:

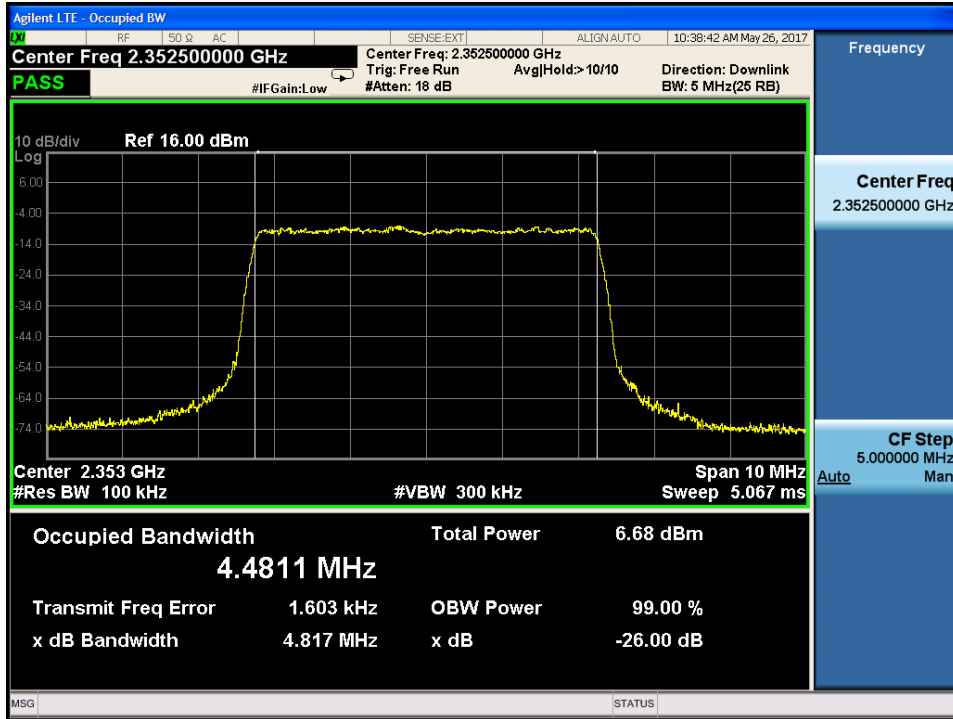

Output:

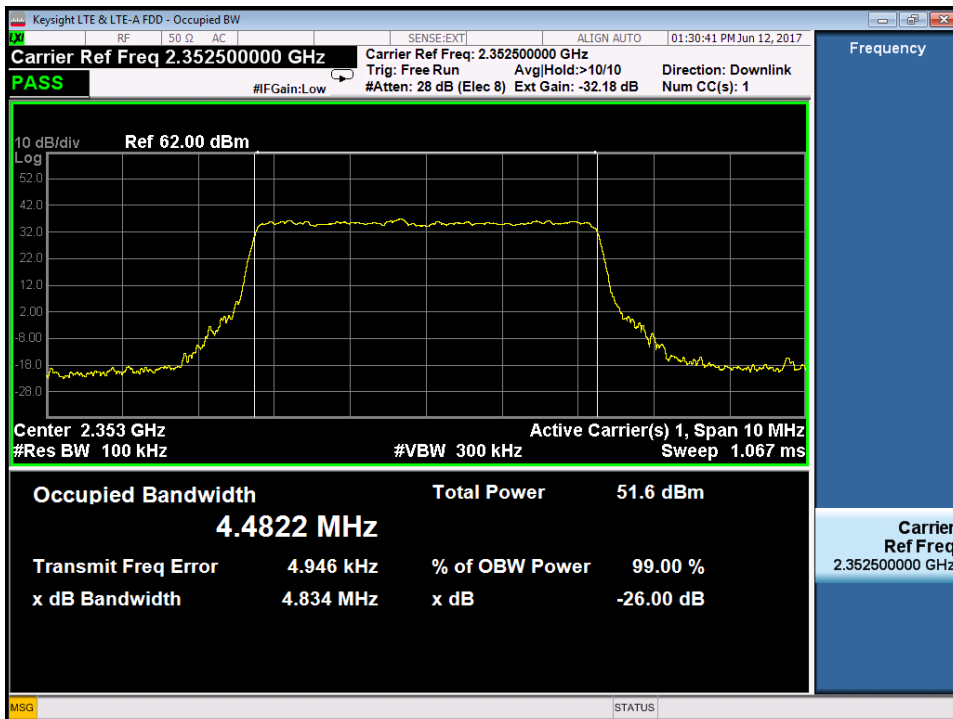



2.2 middle frequency-- 5MHz bandwidth

Input:

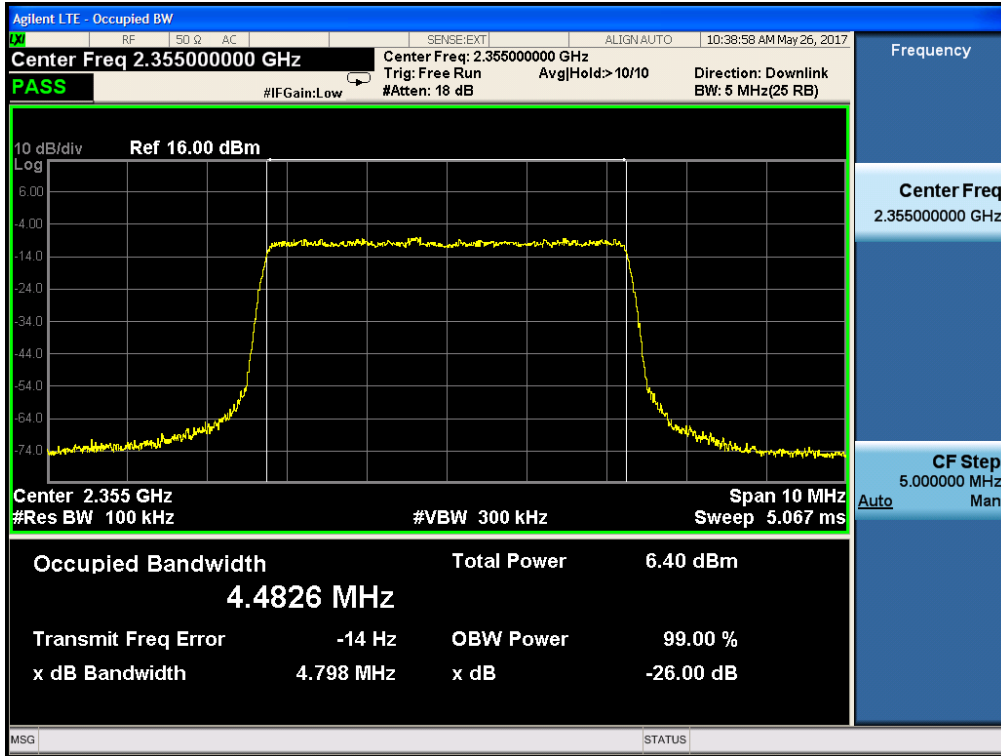

Output:

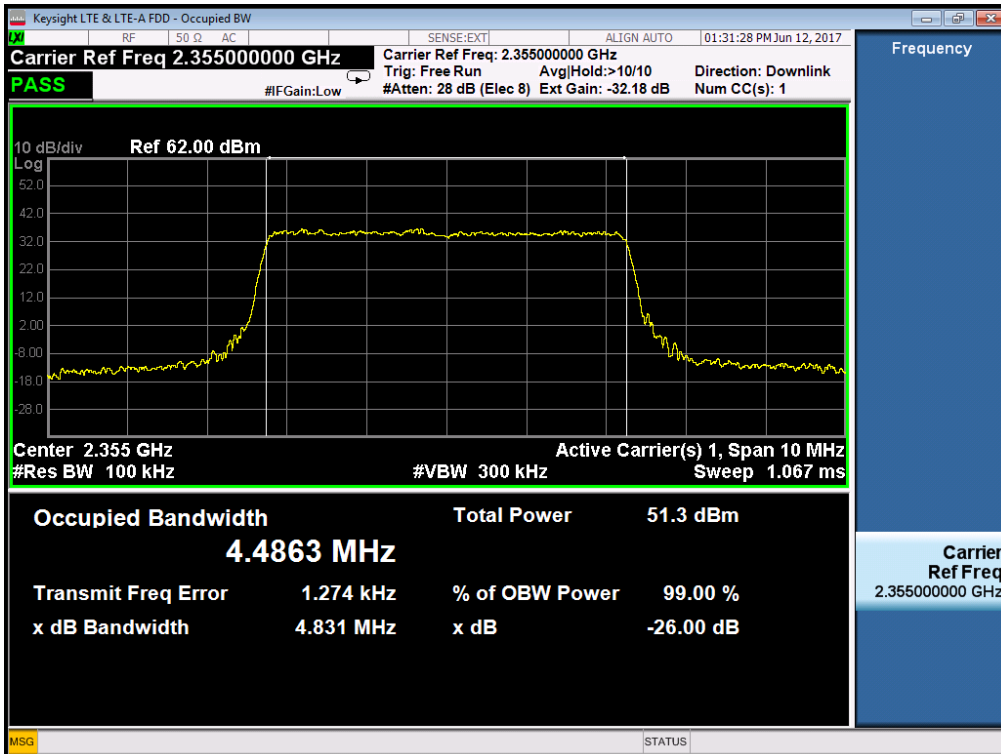



2.3 highest frequency—5MHz bandwidth

Input:

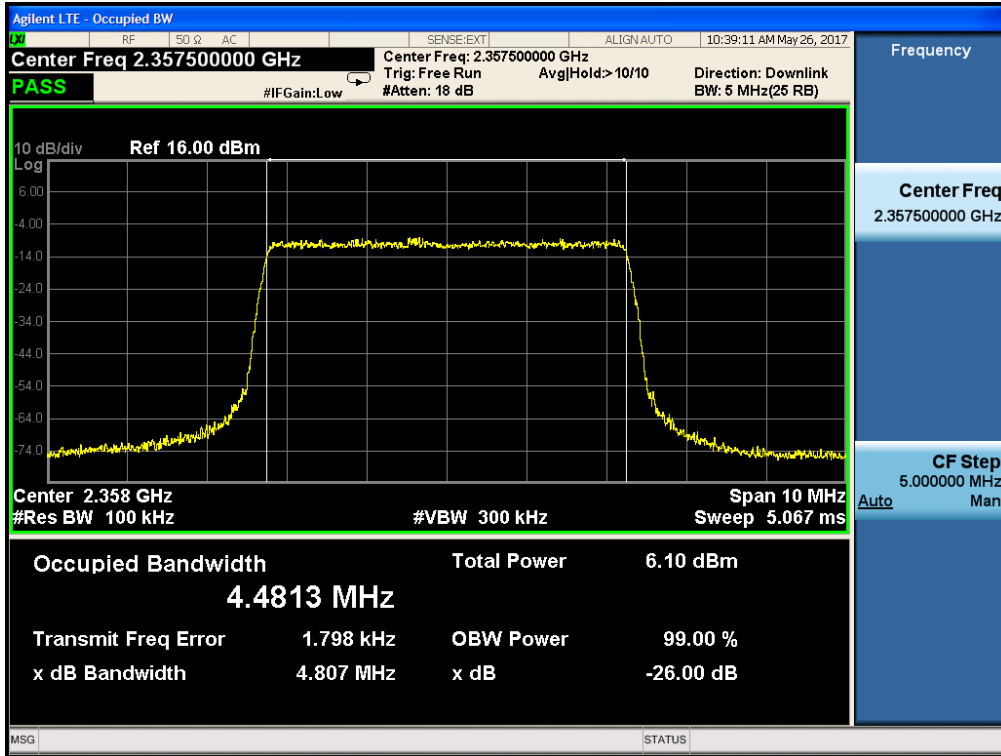

Output:

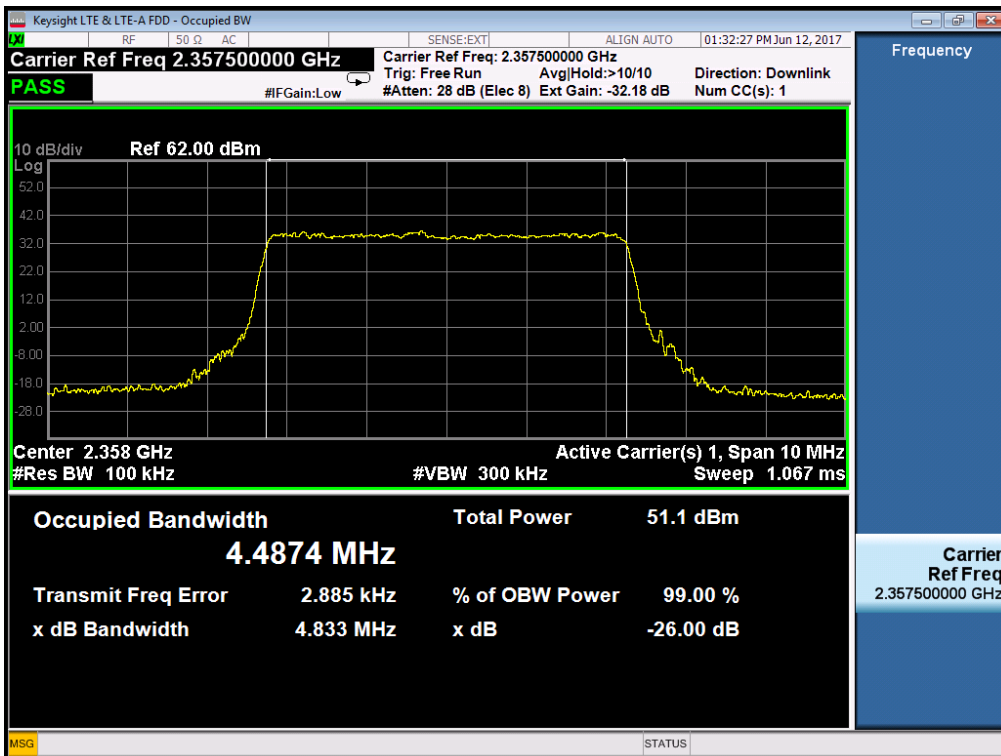



2.4 Middle frequency – 10MHz bandwidth

Input:

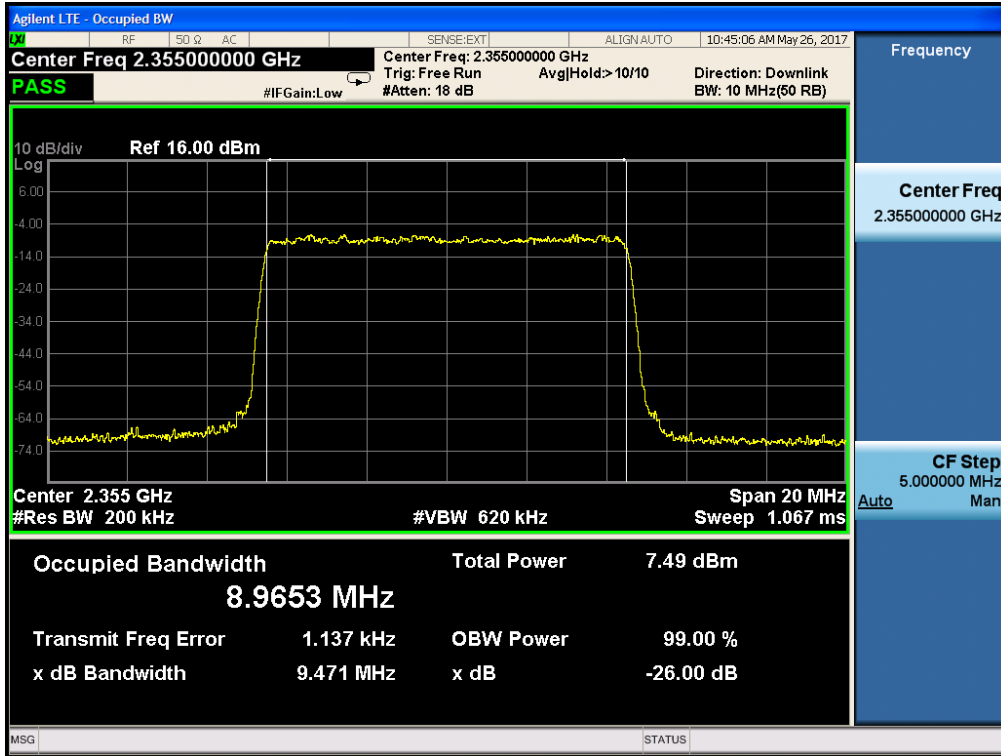

Output:

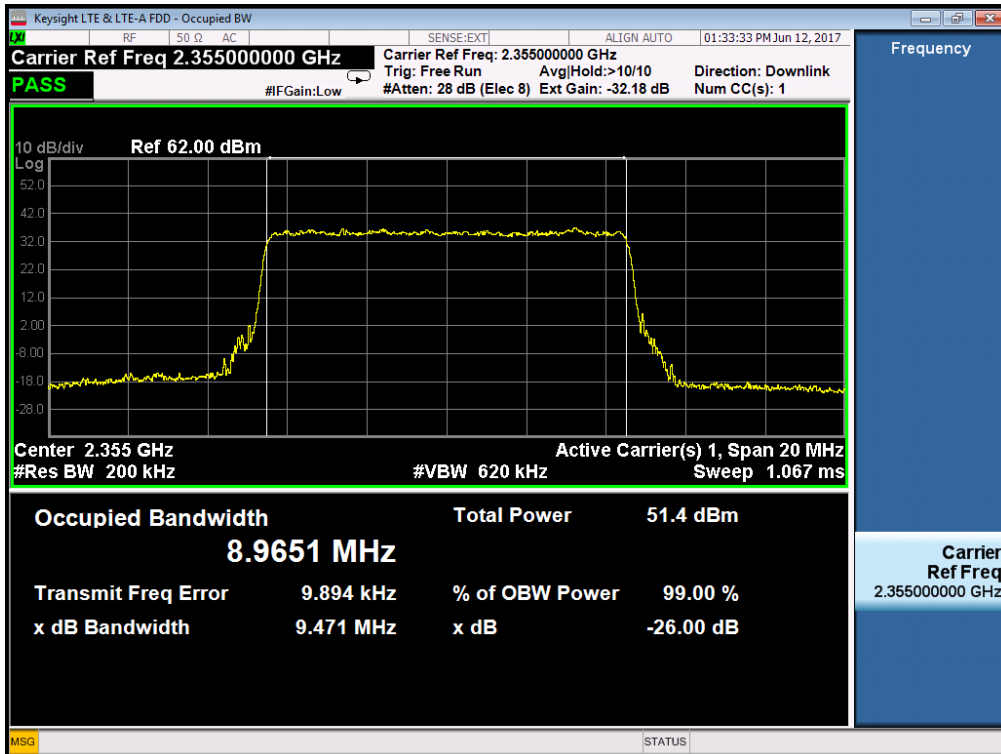

7.2.6 Out of Band Rejection

Test Requirement: Section D.3(l) of KDB 935210 D02 Signal Booster Certification v03r02
Test for rejection of out of band signals. Filter freq. response plots are acceptable.

Test Method: KDB 935210 D05 Indus Booster Basic Meas v01r01

EUT Operation:
Status: Drive the EUT to maximum output power. .
Conditions: Normal conditions
Application: Cellular Band RF output ports

Test Configuration:

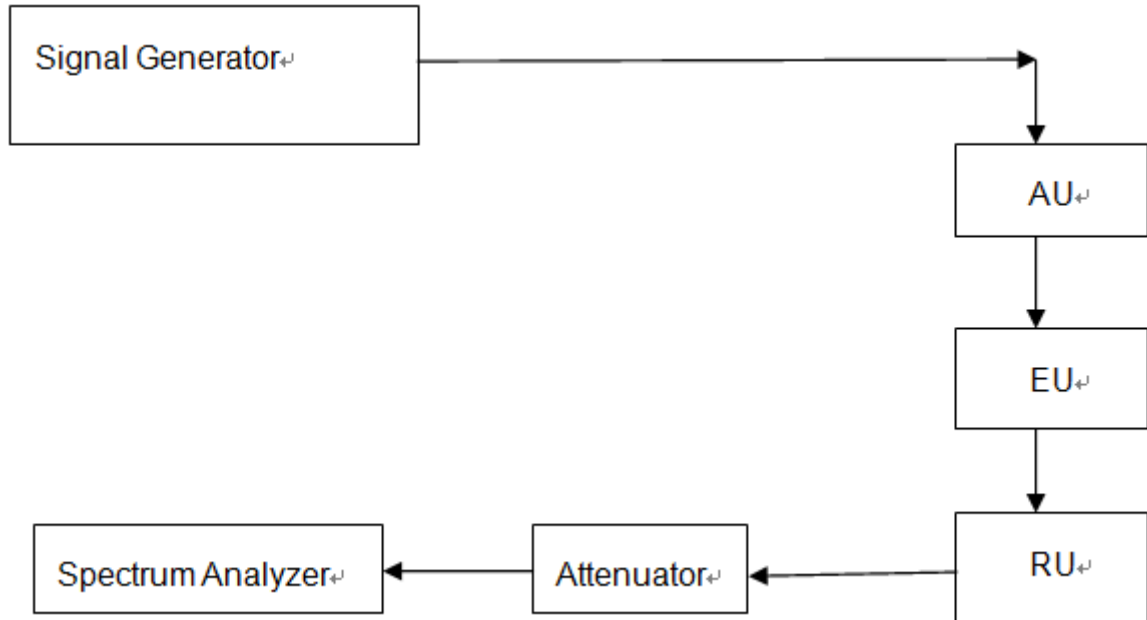
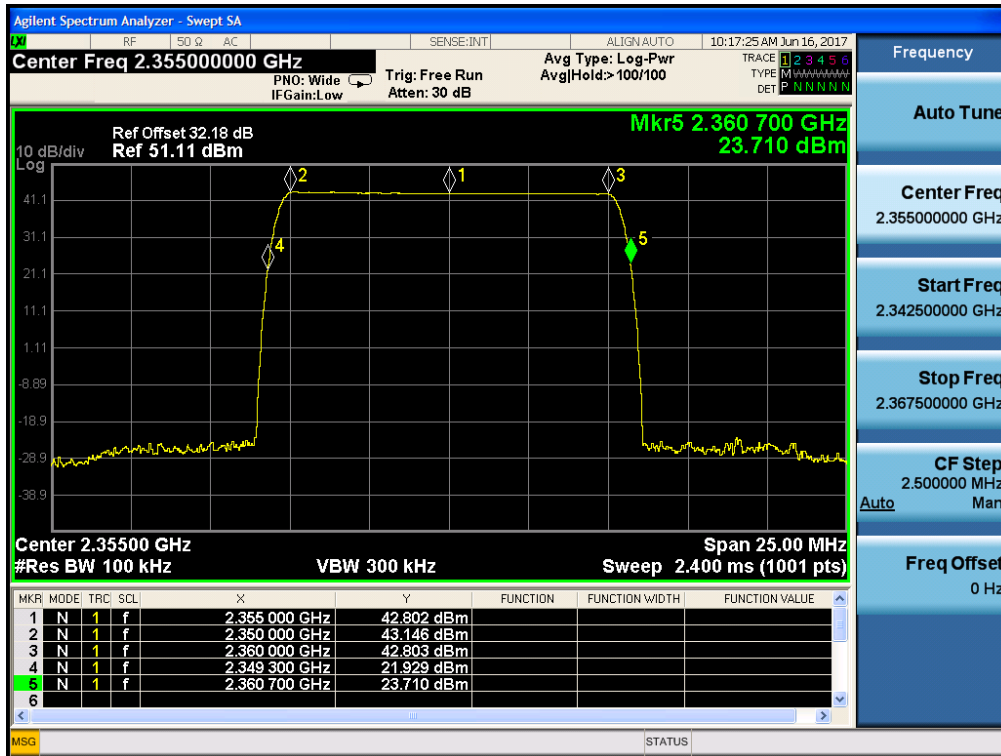

Fig.4. Out of Band rejection test configuration

- Test Procedure:
1. Connect the equipment as illustrated;
 2. Test the background noise level with all the test facilities;
 3. Keep one transmitting path, all other connectors shall be connected by normal power or RF leads;
 4. Select the attenuator to avoid the test receiver or spectrum analyzer being destroyed;
 5. Keep the EUT continuously transmitting in max power;
 6. Signal generator sweep from the frequency more lower than the product frequency to the frequency more higher than it, find the product band filter characteristic;
- CW signal rather than typical signal is acceptable (for FM).
 - Multiple band filter will need test each other.



7.2.6.1 Measurement Record:
Downlink: 2350MHz to 2360MHz





7.2.7 Frequency Stability

Test Requirement: FCC part 27.54

The frequency stability shall be sufficient to ensure that the fundamental emissions stay within the authorized bands of operation.

EUT Operation:

Status: Drive the EUT to maximum output power.

Conditions: Temperature conditions, voltage conditions

Application: Cellular Band RF output ports

Test Procedure:

1. Temperature conditions:
 - a) The RF output port of the EUT was connected to Frequency Meter;
 - b) Set the working Frequency in the middle channel;
 - c) record the 20°C and nominal voltage frequency value as reference point;
 - d) vary the temperature from -40°C to 50°C with step 10°C
 - e) when reach a temperature point, keep the temperature balance at least 1 hour to make the product working in this status;
 - f) read the frequency at the relative temperature.
2. Voltage conditions:
 - a) record the 20°C and nominal voltage frequency value as reference point;
 - b) vary the voltage from -15% nominal voltage to +15% voltage;
 - c) read the frequency at the relative voltage.



7.2.7.1 Measurement Record:

Frequency Stability vs temperature:

1. Test for Downlink: 2350~2360MHz (middle channel=2355MHz)

Temperature(°C)	Frequency(MHz)	Tolerance(ppm)
50	2355.000007	0.00297
40	2355.000007	0.00297
30	2355.000007	0.00297
20	2355.000007	0.00297
10	2355.000007	0.00297
0	2355.000007	0.00297
-10	2355.000007	0.00297
-20	2355.000007	0.00297
-30	2355.000007	0.00297
-40	2355.000007	0.00297

Frequency Stability vs voltage:

1. Test for Downlink: 2350~2360MHz (middle channel=2355MHz)

Voltage(V ac)	Frequency(MHz)	Tolerance(ppm)
102	2355.000007	0.00297
120	2355.000007	0.00297
138	2355.000007	0.00297

8 Photographs - Test Setup

Above 1GHz Radiated Emission

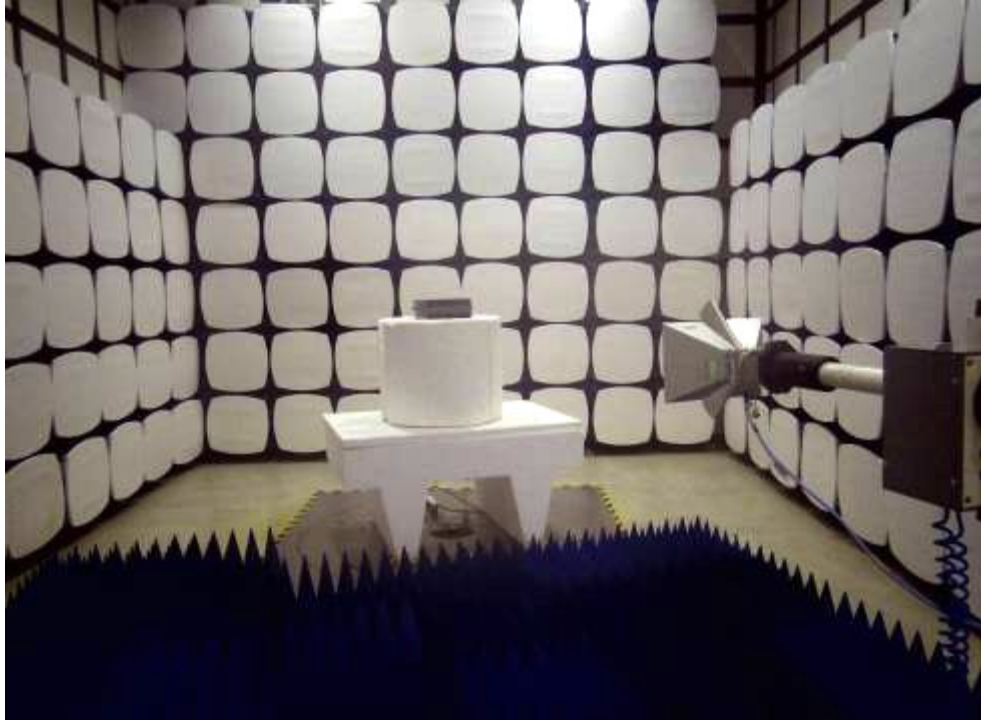

30MHz ~ 1GHz Radiated Emission



9 Photographs - EUT Constructional Details

Test Model No.: iDAS-R211





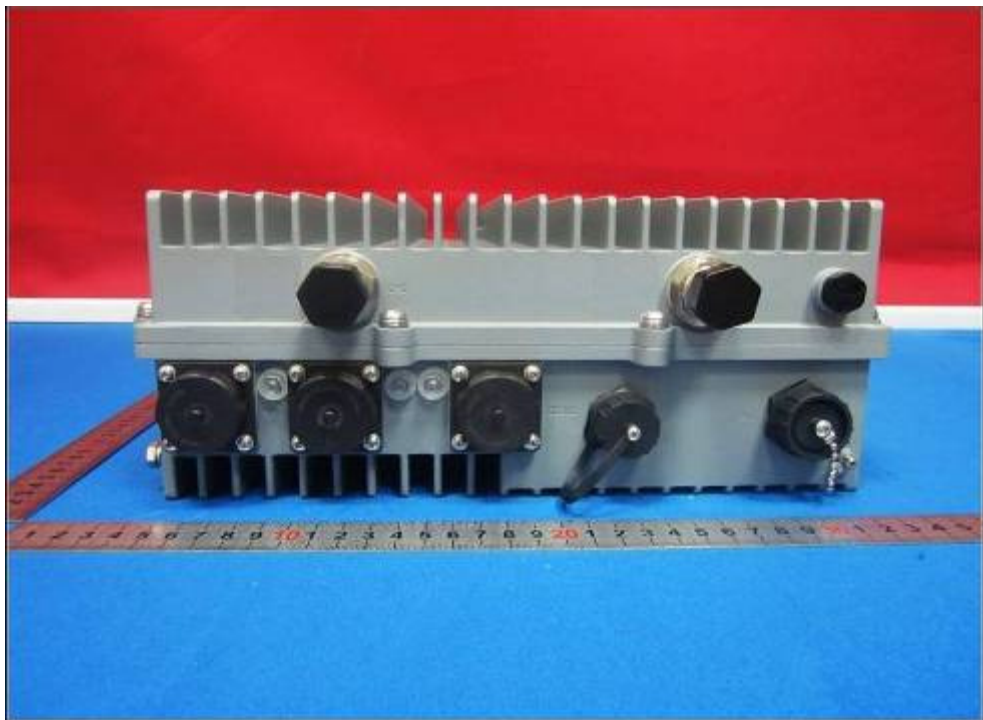



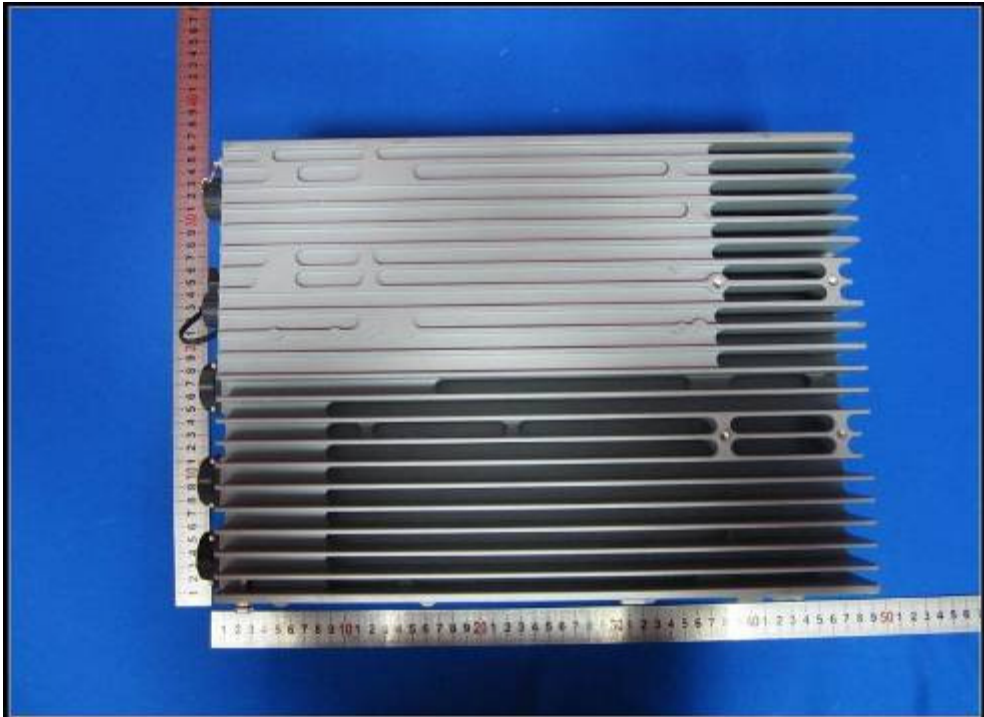
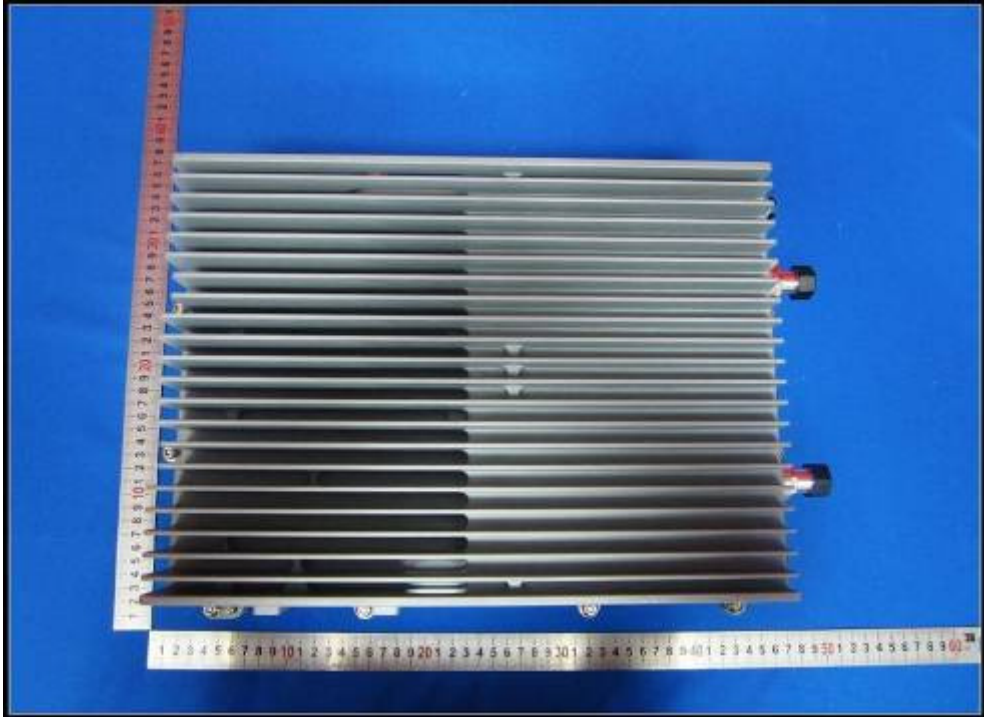

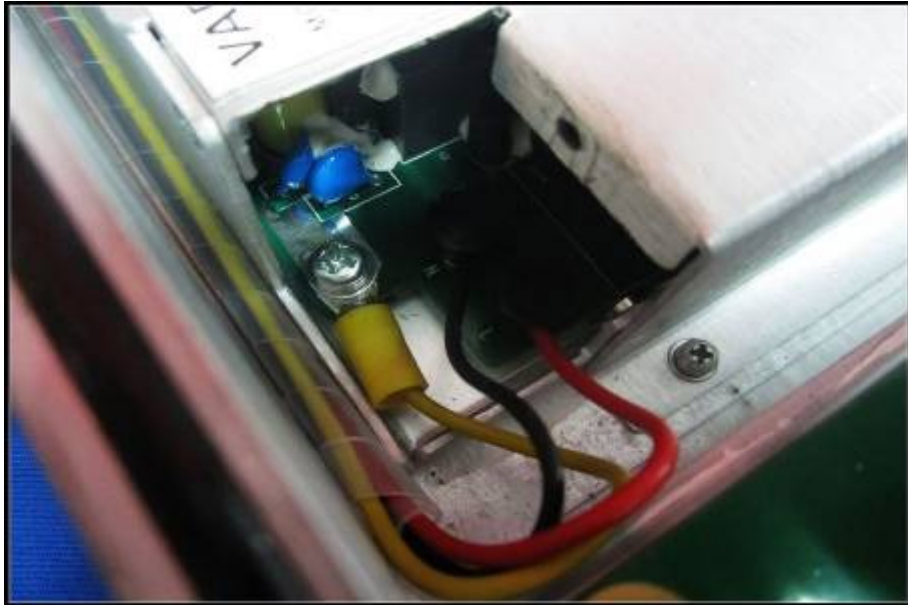

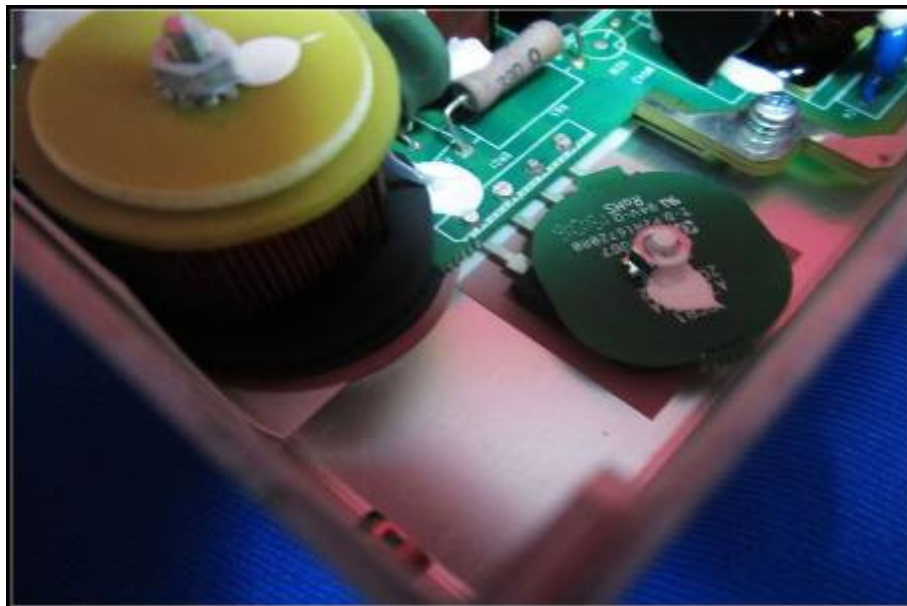
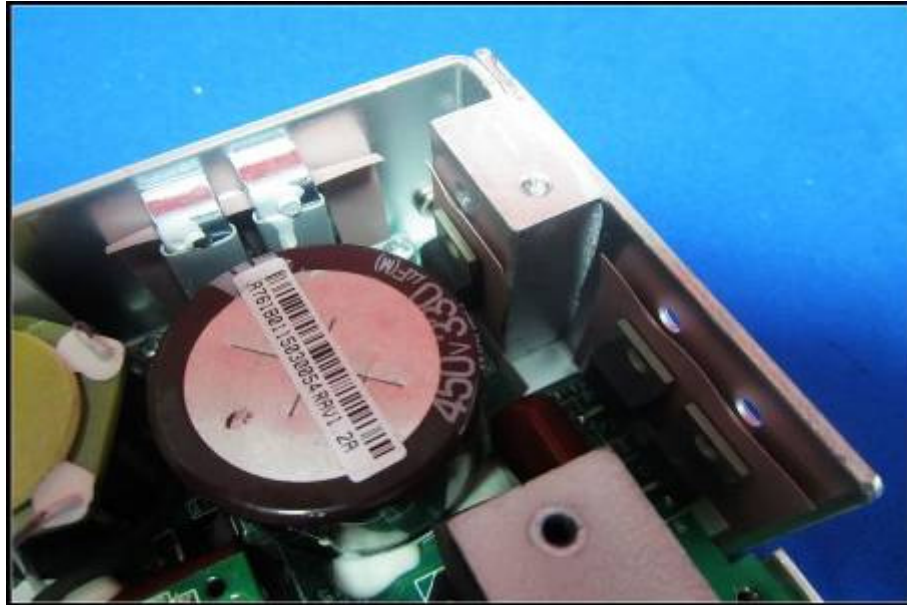

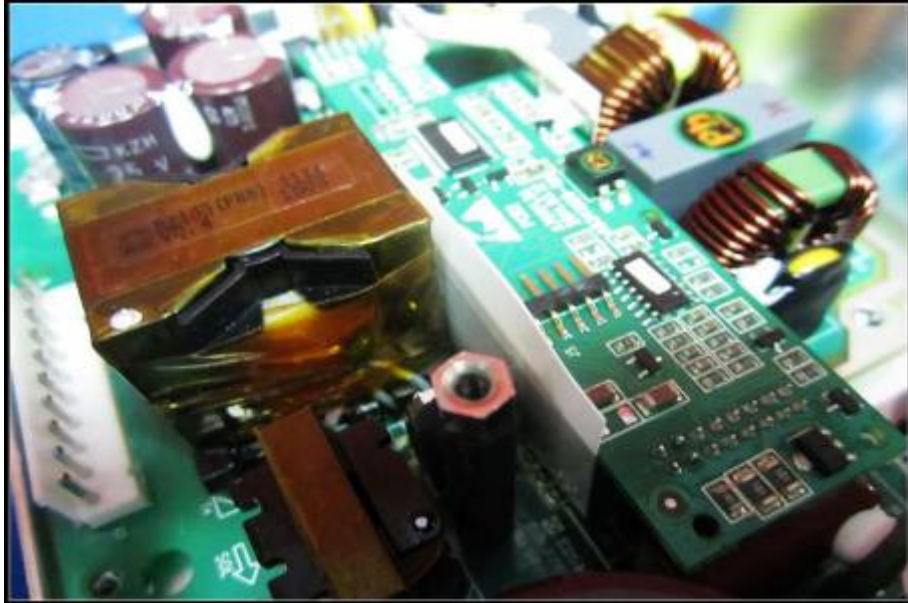

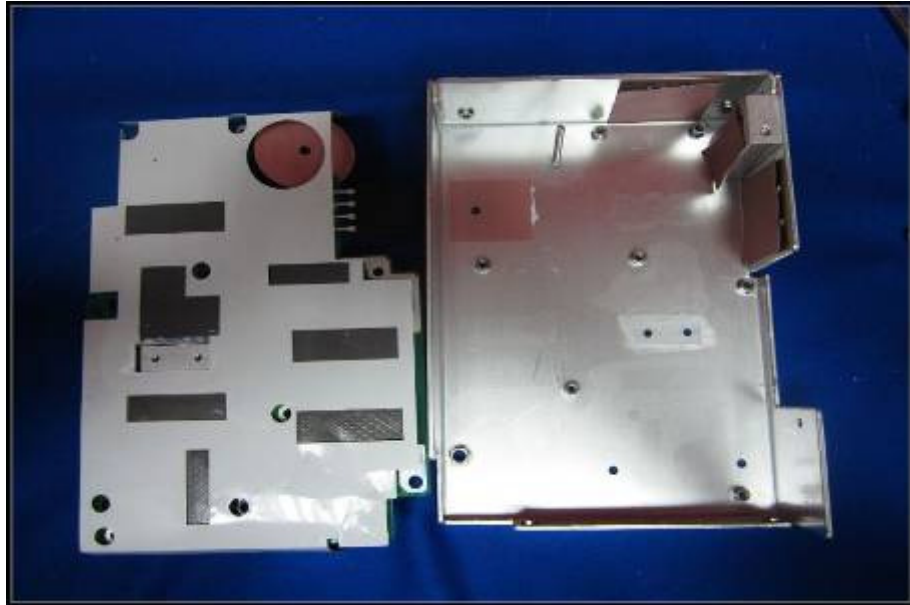



--The End of Report--