

TEST REPORT

Application No.:	SZEM1901010517CR
Applicant:	Sunwave Communications Co., Ltd.
Manufacturer:	Sunwave Communications Co., Ltd.
Factory:	Sunwave Communications Co., Ltd.
Product Name:	Remote Unit
Product Description:	The RU conducts digital-analog conversion and power amplification of the input signals.
Model No.:	iDAS-R211
Trade Mark:	CROSSFIRE, SUNWAVE
FCC ID:	2AEJ4R2112626
Standards:	FCC Part 2:2018 FCC Part 20:2018 FCC Part 22:2018
Date of Receipt:	2019-01-03
Date of Test:	2019-01-03 to 2019-01-18
Date of Issue:	2019-01-25
Test Result:	Pass*

* In the configuration tested, the EUT detailed in this report complied with the standards specified above. Please refer to section 3 of this report for further details.

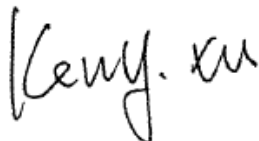

Keny Xu
EMC Laboratory Manager





2 Version

Revision Record				
Version	Chapter	Date	Modifier	Remark
01		2019-01-25		Original

Authorized for issue by:			
Tested By	Edison Li	Edison Li /Project Engineer	2019-01-25
			Date
Checked By	Eric Fu	Eric Fu /Reviewer	2019-01-25
			Date



3 Test Summary

Test Item	FCC part 2	FCC part 22	Result
RF Output Power, Amplifier Gain and Peak to Average Ratio	2.1046	22.913	PASS
Conducted Spurious Emissions	2.1051	22.917	PASS
Out-of-band/out-of-block (including intermodulation) Emissions	2.1051	22.917	PASS
Radiated Spurious Emissions	2.1053	22.917	PASS
Occupied Bandwidth and Input-versus-output signal comparison	2.1049	N/A	PASS
Frequency Stability	2.1055	22.355	PASS
Out of Band Rejection	N/A	N/A	PASS

Remark:

EUT: In this whole report EUT means Equipment Under Test.

Tx: In this whole report Tx (or tx) means Transmitter.

Rx: In this whole report Rx (or rx) means Receiver.

This is a DAS, no need to implement uplink test as it is cable connect to BTS (No air radiation), then the test about Uplink would be ignored.

Test method standard:

ANSI C63.26-2015

KDB 935210 D05 Indus Booster Basic Meas v01r01

KDB 935210 D02 Signal Booster Certification v03r02



4 Contents

	Page
1 Cover Page.....	1
2 Version.....	2
3 Test Summary.....	3
4 Contents.....	4
5 General Information.....	5
5.1 Client Information.....	5
5.2 General Description of E.U.T.....	5
5.3 Details of E.U.T.....	5
5.4 Standards Applicable for Testing.....	5
5.5 Measurement Uncertainty.....	6
5.6 Test Location.....	7
5.7 Other Information Requested by the Customer.....	7
5.8 Test Facility.....	7
6 Equipment Used during Test.....	8
7 Test Results.....	10
7.1 E.U.T. test conditions.....	10
7.1.1 RF Output Power And Amplifier Gain.....	12
7.1.2 Conducted Spurious Emissions.....	15
7.1.3 Out-of-band/out-of-block emissions.....	35
7.1.4 Radiated Spurious Emissions.....	43
7.1.5 Occupied bandwidth and Input-versus-output signal comparison.....	50
7.1.6 Out of Band Rejection.....	60
7.1.7 Frequency Stability.....	63
8 Photographs - Test Setup.....	65
9 Photographs - EUT Constructional Details.....	67-78



5 General Information

5.1 Client Information

Applicant: Sunwave Communications Co., Ltd.
Address of Applicant: Sunwave Building 581 Huoju Avenue, Binjiang District, Hangzhou, P.R.China Zip: 310053
Manufacturer: Sunwave Communications Co., Ltd.
Address of Manufacturer: Sunwave Building 581 Huoju Avenue, Binjiang District, Hangzhou, P.R.China Zip: 310053
Factory: Sunwave Communications Co., Ltd.
Address of Factory: Sunwave Building 581 Huoju Avenue, Binjiang District, Hangzhou, P.R.China Zip: 310053

5.2 General Description of E.U.T.

Product Name: Remote Unit
Model No.: iDAS-R211
Trade Mark: CROSSFIRE, SUNWAVE
Sample Type: Fixed production
Antenna Gain: 12.5dBi
Power Supply: AC120V 60Hz
Optical Fiber: 200cm (unshielded)
AC Cable: 200cm (unshielded)
RF Cable: 200cm (shielded)

5.3 Details of E.U.T.

Type of Modulation: LTE, WCDMA, CDMA
Frequency Band: Downlink 862MHz to 894MHz
Normal Output Power: 43dBm (downlink)
System Gain: 43dB
Power Control Method: ALC

5.4 Standards Applicable for Testing

The standard used was FCC part 2, FCC part 20 & FCC part 22



5.5 Measurement Uncertainty

No.	Item	Measurement Uncertainty
1	Radio Frequency	7.25 x 10 ⁻⁸
2	Duty cycle	0.37%
3	Occupied Bandwidth	3%
4	RF conducted power	0.75dB
5	Conducted Spurious emissions	0.75dB
6	RF Radiated power	4.5dB (below 1GHz)
7		4.8dB (above 1GHz)
8	Radiated Spurious emission test	4.5dB (30MHz-1GHz)
		4.8dB (1GHz-18GHz)
	Temperature test	1 °C
9	Humidity test	3%
10	Supply voltages	1.5%
11	Time	3%



5.6 Test Location

All tests were performed at:

SGS-CSTC Standards Technical Services Co., Ltd., Shenzhen Branch

No. 1 Workshop, M-10, Middle Section, Science & Technology Park, Shenzhen, Guangdong, China.
518057.

Tel: +86 755 2601 2053 Fax: +86 755 2671 0594

No tests were sub-contracted.

5.7 Other Information Requested by the Customer

None.

5.8 Test Facility

The test facility is recognized, certified, or accredited by the following organizations:

• CNAS (No. CNAS L2929)

CNAS has accredited SGS-CSTC Standards Technical Services Co., Ltd. Shenzhen Branch EMC Lab to ISO/IEC 17025:2005 General Requirements for the Competence of Testing and Calibration Laboratories (CNAS-CL01 Accreditation Criteria for the Competence of Testing and Calibration Laboratories) for the competence in the field of testing.

• A2LA (Certificate No. 3816.01)

SGS-CSTC Standards Technical Services Co., Ltd., Shenzhen EMC Laboratory is accredited by the American Association for Laboratory Accreditation(A2LA). Certificate No. 3816.01.

• VCCI

The 3m Fully-anechoic chamber for above 1GHz, 10m Semi-anechoic chamber for below 1GHz, Shielded Room for Mains Port Conducted Interference Measurement and Telecommunication Port Conducted Interference Measurement of SGS-CSTC Standards Technical Services Co., Ltd. have been registered in accordance with the Regulations for Voluntary Control Measures with Registration No.: G-20026, R-14188, C-12383 and T-11153 respectively.

• FCC –Designation Number: CN1178

SGS-CSTC Standards Technical Services Co., Ltd., Shenzhen EMC Laboratory has been recognized as an accredited testing laboratory.

Designation Number: CN1178. Test Firm Registration Number: 406779.

• Innovation, Science and Economic Development Canada

SGS-CSTC Standards Technical Services Co., Ltd., Shenzhen EMC Laboratory has been recognized by ISED as an accredited testing laboratory.

CAB identifier: CN0006.

IC#: 4620C.



6 Equipment Used during Test

RE in Chamber						
Item	Test Equipment	Manufacturer	Model No.	Inventory No.	Cal. Date (yyyy-mm-dd)	Cal. Due date (yyyy-mm-dd)
1	3m Semi-Anechoic Chamber	AUDIX	N/A	SEM001-02	2018-05-10	2019-05-10
2	EXA Spectrum Analyzer	Agilent Technologies Inc	N9010A	SEM004-09	2018-07-19	2019-07-19
3	Log Antenna (26-3000MHz)	ETS-Lindgren	3142C	SEM003-02	2018-11-15	2021-11-15
4	Amplifier (0.1-1300MHz)	HP	8447D	SEM005-02	2018-10-09	2019-10-09
5	Horn Antenna (1-18GHz)	Rohde & Schwarz	HF907	SEM003-07	2018-06-14	2021-06-14
76	Horn Antenna (18-26GHz)	ETS-Lindgren	3160	SEM003-12	2018-11-24	2021-11-24
7	Horn Antenna(26GHz-40GHz)	A.H.Systems, inc.	SAS-573	SEM003-13	2018-02-12	2021-02-12
8	Low Noise Amplifier	Black Diamond Series	BDLNA-0118-352810	SEM005-05	2018-10-09	2019-10-09
9	Band filter	Amindeon	Asi 3314	SEM023-01	N/A	N/A

RE in Chamber						
Item	Test Equipment	Manufacturer	Model No.	Inventory No	Cal. Date (yyyy-mm-dd)	Cal. Due date (yyyy-mm-dd)
1	10m Semi-Anechoic Chamber	SAEMC	FSAC1018	SEM001-03	2018-05-10	2019-05-10
2	EMI Test Receiver (9k-7GHz)	Rohde & Schwarz	ESR	SEM004-03	2018-04-25	2019-04-25
3	log-Broadband Antenna (30M-1GHz)	Schwarzbeck	VULB9168	SEM003-18	2018-06-29	2021-06-29
4	Pre-amplifier	Sonoma Instrument Co	310N	SEM005-03	2018-06-05	2019-06-04
5	Loop Antenna	ETS-Lindgren	6502	SEM003-08	2018-08-14	2021-08-14





RF connected test						
Item	Test Equipment	Manufacturer	Model No.	Inventory No.	Cal. Date (yyyy-mm-dd)	Cal. Due date (yyyy-mm-dd)
1	EXG Analog Signal Generator	KEYSIGHT	N5171B	SEM006-04	2018-08-27	2019-08-27
2	ESG vector signal generator	Agilent Technologies	E4438C	SEM006-03	2018-07-19	2019-07-19
3	Power Meter	Rohde & Schwarz	NRVS	SEM014-02	2018-10-09	2019-10-09
4	ESG Vector Signal Generator	KEYSIGHT	E4438C	MT-W520	2019-01-03	2020-01-02
5	PXA Signal Analyzer	KEYSIGHT	N9030A	MT-W521	2018-01-02	2020-01-01
6	Attenuator	HUAXIANG	10048953	MT-W504	2018-11-15	2020-11-14
7	Temperature chamber	ESPEC	EW1040	MT-X003	2019-11-03	2019-11-02



7 Test Results

7.1 E.U.T. test conditions

Input voltage:	AC120V	
Test voltage	Normal	AC120V
	Extreme	AC102V~AC138V
Operating Environment:		
Test Temperature:	Normal	22°C ~26°C
	Extreme	-40~50°C
Humidity:	46%~56% RH	
Atmospheric Pressure:	990~1005mbar	
Test Requirement:	The RF output power of the EUT was measured at the antenna port, by adjusting the input power of signal generator to drive the EUT to get to maximum output power point and keep the EUT at maximum gain setting for all tests. The device should be tested on downlink. For detail test Modulation and Frequency, please refer to 7.2.	

Remark:

FIBER-OPTIC AND OTHER SIMILAR RF DISTRIBUTION SYSTEMS

Fiber-optic distribution systems are a type of in-building radiation system that receives RF signals from an antenna, distributes the signal over fiber-optic cable, and then retransmits at another location for example within a building or tunnel. Most fiber-optic systems are signal boosters; however, some may be repeaters. These systems generally have two enclosures typically called host (or local or donor unit) and remote. Some systems may also have an optional expander box for fan-out to multiple remotes. The system transmits downlink signals from the remote unit to handsets, portables, or clients, and transmits uplink signals via from the host unit. Usually but not always the uplink goes through an intermediate amplifier to a "donor" antenna. Therefore both uplink and downlink must be tested, unless filing effectively documents how connection of uplink to donor antenna with or without an intermediate amplifier will be prevented, such as for always only a cabled connection to a base station. Fiber-optic systems are not amplifiers (AMP equipment class) – they are equipment class TNB or PCB. The same approval procedures also apply for multiple-enclosure systems connected by coax cable.

Synonyms and related terms: in-building radiation system, coverage enhancer, distributed antenna system, fiber-optic distribution system, converter, donor antenna

Typical in-building or distributed antenna systems can consist of five different components (enclosures), not counting antennas:

1) host unit

- a) transmits uplink to base station via antenna thru coax, **passive interface unit**, or **active interface unit** (amplifier)
- b) sends base-station downlink via fiber-optic or coax to **remote**
- c) receives handset uplink via fiber-optic or coax from **remote**
- d) optional connection to **expansion unit** via fiber-optic
- e) separate FCC ID from **remote**, unless electrically identical
- f) **non-transmitting host unit**
- i) connects directly to a base station via coax cable but does not connect to antenna or amplifier



ii) Part 15 digital device subject to Verification, no FCC ID

2) remote unit

- a) receives base-station downlink via fiber-optic or coax from **host**, transmits via antenna to handsets
- b) returns handset uplink via fiber-optic or coax to **host**
- c) separate FCC ID from **remote**, unless electrically identical

3) expansion unit

- a) fiber-optic or coax from **host**
- b) fiber-optic or coax fan-out to **remote(s)**
- c) Part 15 digital device subject to Verification, no FCC ID

4) passive interface unit

- a) contains attenuators, splitters, combiners
- b) coax cable connection between **host** and base-station
- c) passive device, no FCC ID

5) active interface unit

- a) amplifies uplink signal from **host unit** for transmit by donor antenna
- b) attenuates downlink from donor antenna
- c) coax cable connection between **host** and **active interface unit**
- d) usually has separate FCC ID; in some cases could be combined/included with **host** as one enclosure

GENERAL DEFINITIONS FOR CERTIFICATION PURPOSES:

The following three general definitions follow from those stated in the Part 22, 24, and 90 rule sections as listed above. Two of the definitions replace previous EAB internal definitions given for booster, repeater and extender. The general term “extender” is the same as booster, but booster should be used rather than extender. The general term “translator” is the same as repeater, but repeater should be used rather than translator.

External radio frequency power amplifier (ERFPA) - any device which, (1) when used in conjunction with a radio transmitter signal source, is capable of amplification of that signal, and (2) is not an integral part of a radio transmitter as manufactured. The EAS equipment class AMP is used only for an ERFPA device inserted between a transmitter (TNB/PCB) and an antenna (has only one antenna port) **Booster** is a device that automatically reradiates signals from base transmitters without channel translation, for the purpose of improving the reliability of existing service by increasing the signal strength in dead spots. An “in-building radiation system” is a signal booster. These devices are not intended to extend the size of coverage from the originating base station. A booster can be either single or multiple channels.

Repeater is a device that retransmits the signals of other stations. Repeaters are different from boosters in that they can include frequency translation and can extend coverage beyond the design of the original base station. A repeater is typically single channel but can also be multiple channels.

ERFPA (AMP) and boosters/repeaters (TNB/PCB) can generally be authorized for all rule parts except 15 and 18.

Tests should be done with each typical signal. e.g., for F3E emissions use 2500 Hz with 2.5 or 5 kHz deviation. Use of CW signal for some tests is acceptable in lieu of actual emission, in some cases when CW signal gives worst case.

The iDAS-R211 system working principle: the RF signal coupled from BTS is transferred into optical signal, and then transmitted via a fiber to remote unit. The remote re-transfers the optical signal back to RF signal, through the frequency translation and after power amplifiers, can extend the BTS coverage to another desired area; the iDAS-R211 system is compliant with the description about repeater in FCC rules, So **the Equipment belongs to the booster and B2I class.**





7.1.1 RF Output Power And Amplifier Gain

Test Requirement: FCC part 22.913(a)
 Test Method: KDB 935210 D05 Indus Booster Basic Meas v01r01
 EUT Operation:
 Status: Drive the EUT to maximum output power.
 Conditions: Normal conditions
 Application: Cellular Band RF output ports
 Test Configuration:

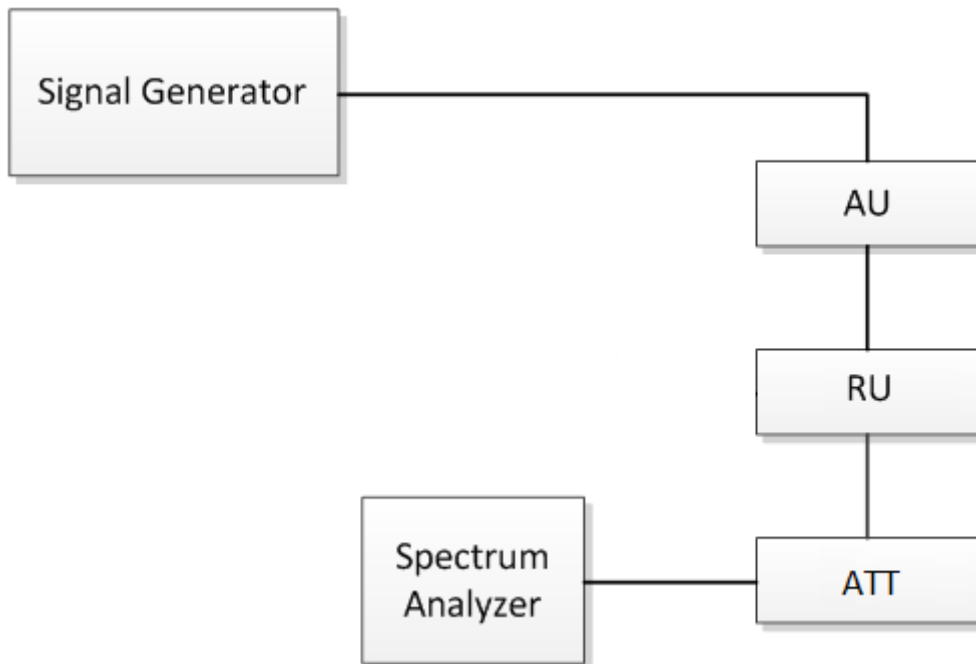

Fig.1 RF Output Power test configuration



Test Procedure:

RF output power test procedure:

- a) Connect a signal generator to the input of the EUT.
- b) Configure to generate the AWGN (broadband) test signal.
- c) The frequency of the signal generator shall be set to the frequency f_0 as determined from 3.3.
- d) Connect a spectrum analyzer or power meter to the output of the EUT using appropriate attenuation as necessary.
- e) Set the signal generator output power to a level that produces an EUT output level that is just below the AGC threshold (see 3.2), but not more than 0.5 dB below.
- f) Measure and record the output power of the EUT; use 3.5.3 or 3.5.4 for power measurement.
- g) Remove the EUT from the measurement setup. Using the same signal generator settings, repeat the power measurement at the signal generator port, which was used as the input signal to the EUT, and record as the input power. EUT gain may be calculated as described in 3.5.5.
- h) Repeat steps f) and g) with input signal amplitude set to 3 dB above the AGC threshold level.
- i) Repeat steps e) to h) with the narrowband test signal.
- j) Repeat steps e) to i) for all frequency bands authorized for use by the EUT.

Amplifier gain test procedure:

After the mean input and output power levels have been measured as described in the preceding subclauses, the mean gain of the EUT can be determined from:

Gain (dB) = output power (dBm) – input power (dBm).

Peak to Average Ratio:

Please according to KDB 971168 D01 clause 5.7.

Remark:

The system continuously monitors the input power.





7.1.1.1 Measurement Record:

Mode	Operation Band	Frequency (MHz)	Signal Type	Signal Level (dBm)	Input Power (dBm)	Output Power (dBm)	Gain (dB)
Downlink	862MHz ~894MHz	891.5MHz	AWGN	Pre-AGC	0.3	43.28	42.98
				3dB Above AGC	3.3	43.23	/
		891.9MHz	GSM	Pre-AGC	0.3	43.49	43.19
				3dB Above AGC	3.3	43.52	/

Mode	Operation Band	Frequency (MHz)	Signal Type	Signal Level (dBm)	Input Power (dBm)	MIMO Output Power (dBm)	Gain (dB)
Downlink	862MHz ~894MHz	891.5MHz	AWGN	Pre-AGC	0.0	46.29	/
				3dB Above AGC	3.3	46.24	/
		891.9MHz	GSM	Pre-AGC	0.0	46.50	/
				3dB Above AGC	3.3	46.53	/

Remark: The nominal Output Power is 43dBm at single output chain.

Mode	Operation Band	Frequency (MHz)	Signal Type	Signal Level (dBm)	Input Power (dBm)	PAPR (dB)	Limit (dB)
Downlink	862MHz ~894MHz	891.5MHz	AWGN	Pre-AGC	0.3	7.19	13.0
				3dB Above AGC	3.3	7.20	13.0
		891.9MHz	GSM	Pre-AGC	0.3	4.66	13.0
				3dB Above AGC	3.3	4.65	13.0



7.1.2 Conducted Spurious Emissions

Test Requirement: FCC part 22.917(a).
 Test Method: KDB 935210 D05 Indus Booster Basic Meas v01r01
 EUT Operation:
 Status: Drive the EUT to maximum output power.
 Conditions: Normal conditions
 Application: Cellular Band RF output ports
 Test Configuration:

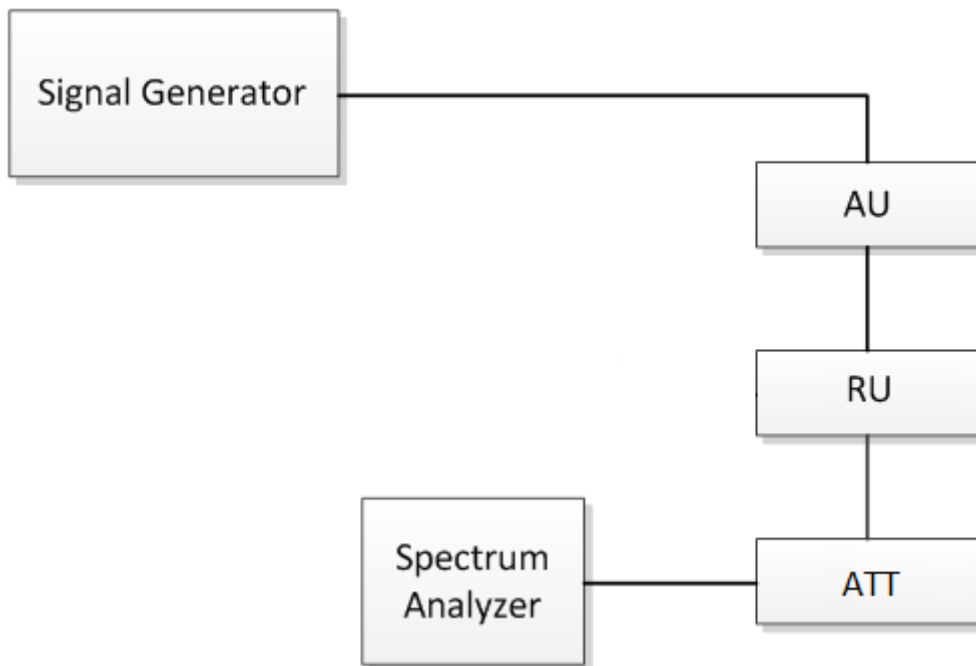

Fig.2. Conducted Spurious Emissions test configuration



Test Procedure:

Conducted Emissions test procedure:

- a) Connect a signal generator to the input of the EUT.
- b) Set the signal generator to produce the broadband test signal as previously described (i.e., 4.1 MHz OBW AWGN).
- c) Set the center frequency of the test signal to the lowest available channel within the frequency band or block.
- d) Set the EUT input power to a level that is just below the AGC threshold (see 3.2), but not more than 0.5 dB below.
- e) Connect a spectrum analyzer to the output of the EUT using appropriate attenuation as necessary.
- f) Set the RBW = reference bandwidth in the applicable rule section for the supported frequency band of operation (e.g., reference bandwidth is typically 100 kHz or 1 MHz).
- g) Set the VBW $\geq 3 \times$ RBW.
- h) Set the Sweep time = auto-couple.
- i) Set the spectrum analyzer start frequency to the lowest RF signal generated in the equipment, without going below 9 kHz, and the stop frequency to the lower band/block edge frequency minus 100 kHz or 1 MHz, as specified in the applicable rule part.
 The number of measurement points in each sweep must be $\geq (2 \times \text{span}/\text{RBW})$, which may require that the measurement range defined by the start and stop frequencies be subdivided, depending on the available number of measurement points provided by the spectrum analyzer.2
- j) Select the power averaging (rms) detector function.
- k) Trace average at least 10 traces in power averaging (rms) mode.
- l) Use the peak marker function to identify the highest amplitude level over each measured frequency range. Record the frequency and amplitude and capture a plot for inclusion in the test report.
- m) Reset the spectrum analyzer start frequency to the upper band/block edge frequency plus 100 kHz or 1 MHz, as specified in the applicable rule part, and the spectrum analyzer stop frequency to 10 times the highest frequency of the fundamental emission (see § 2.1057). The number of measurement points in each sweep must be $\geq (2 \times \text{span}/\text{RBW})$, which may require that the measurement range defined by the start and stop frequencies be subdivided, depending on the available number of measurement points provided by the spectrum analyzer.
- n) Trace average at least 10 traces in power averaging (rms) mode.
- o) Use the peak marker function to identify the highest amplitude level over each of the measured frequency ranges. Record the frequency and amplitude and capture a plot for inclusion in the test report; also provide tabular data, if required.
- p) Repeat steps i) to o) with the input test signals firstly tuned to a middle band/block frequency/channel, and then tuned to a high band/block frequency/channel.
- q) Repeat steps b) to p) with the narrowband test signal.
- r) Repeat steps b) to q) for all authorized frequency bands/blocks used by the EUT.





7.1.2.1 Measurement Record:

1.Downlink: 862MHz to 894MHz (AWGN)

1.1 lowest frequency:

9kHz to 150kHz

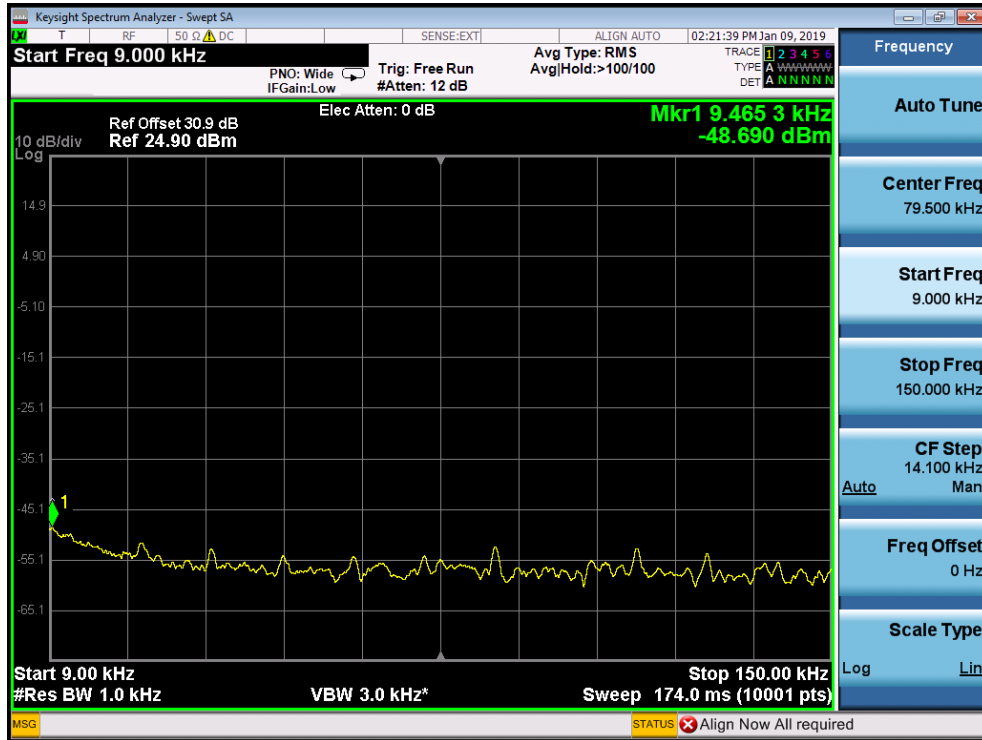

Unless otherwise agreed in writing, this document is issued by the Company subject to its General Conditions of Service printed overleaf, available on request or accessible at <http://www.sgs.com/en/Terms-and-Conditions.aspx> and, for electronic format documents, subject to Terms and Conditions for Electronic Documents at <http://www.sgs.com/en/Terms-and-Conditions/Terms-e-Documents.aspx>. Attention is drawn to the limitation of liability, indemnification and jurisdiction issues defined therein. Any holder of this document is advised that information contained hereon reflects the Company's findings at the time of its intervention only and within the limits of Client's instructions, if any. The Company's sole responsibility is to its Client and this document does not exonerate parties to a transaction from exercising all their rights and obligations under the transaction documents. This document cannot be reproduced except in full, without prior written approval of the Company. Any unauthorized alteration, forgery or falsification of the content or appearance of this document is unlawful and offenders may be prosecuted to the fullest extent of the law. Unless otherwise stated the results shown in this test report refer only to the sample(s) tested and such sample(s) are retained for 30 days only.
Attention: To check the authenticity of testing /inspection report & certificate, please contact us at telephone: (86-755) 8307 1443, or email: CN.Doccheck@sgs.com

150kHz to 30MHz

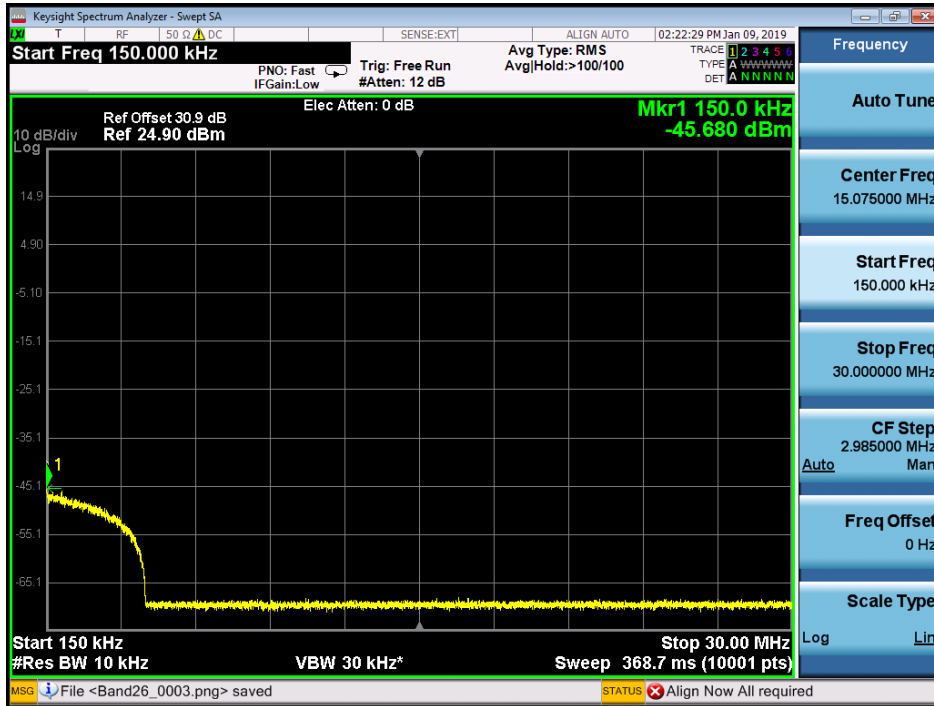

30MHz to 861MHz

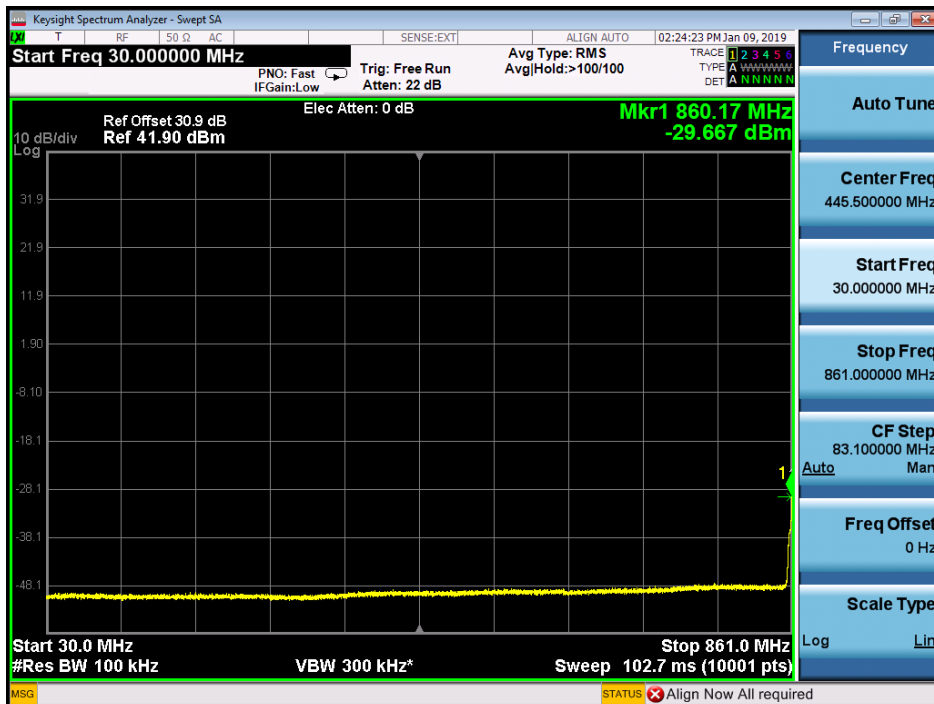

895MHz to 1GHz

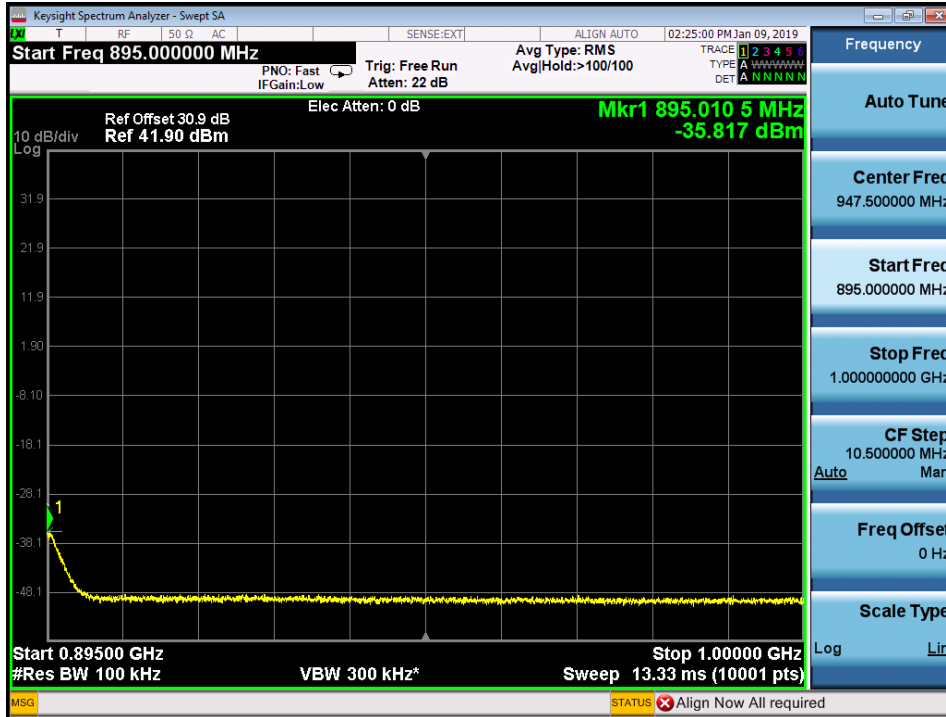

1GHz to 9GHz

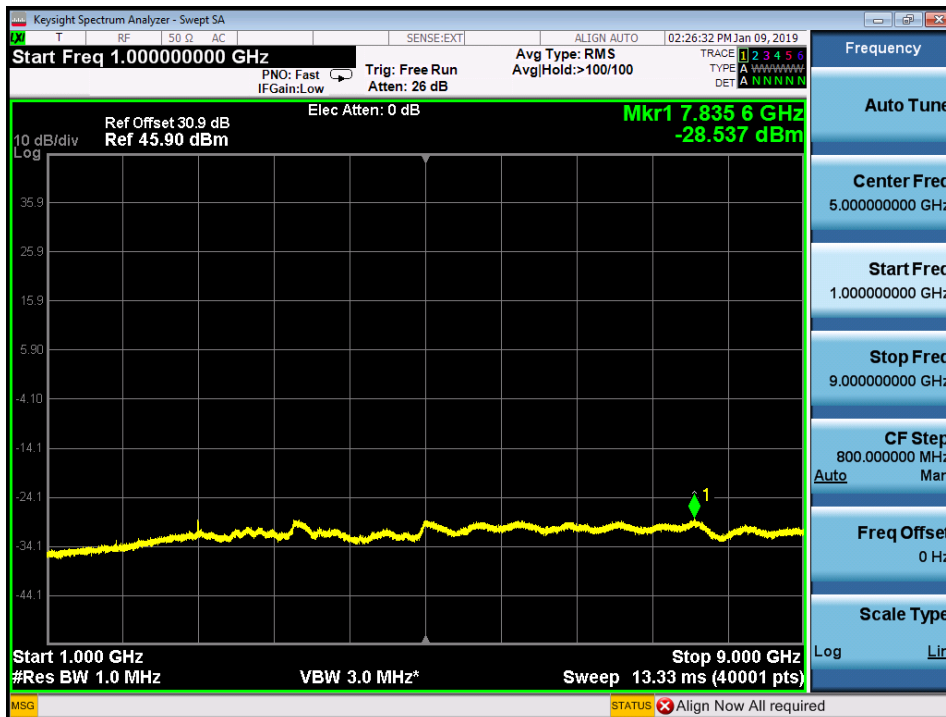

1.2 Middle frequency
9kHz to 150kHz

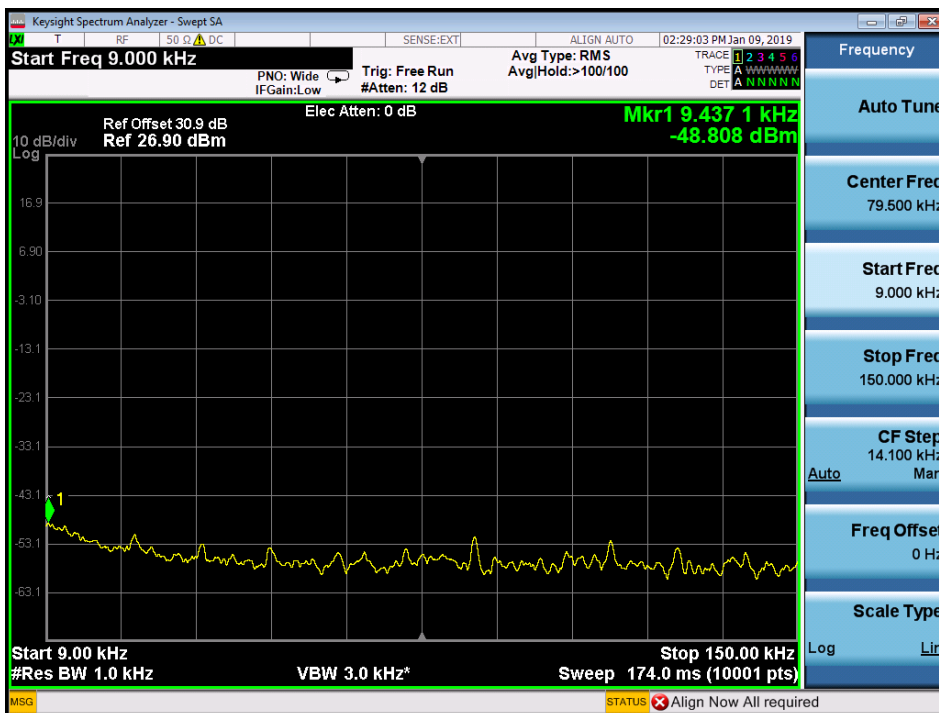

150kHz to 30MHz

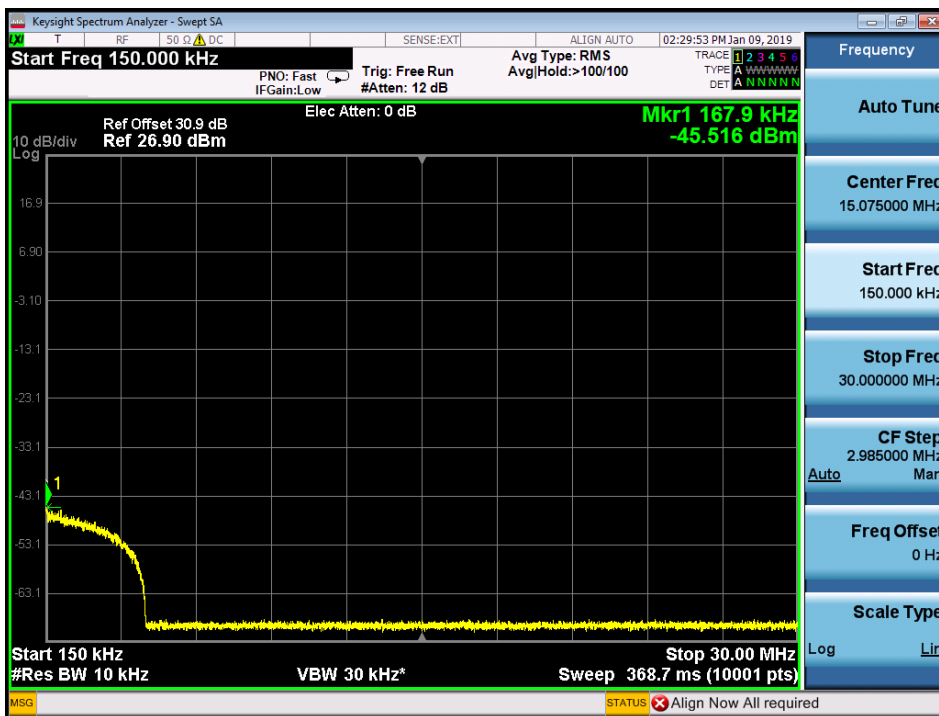

30MHz to 861MHz



Unless otherwise agreed in writing, this document is issued by the Company subject to its General Conditions of Service printed overleaf, available on request or accessible at <http://www.sgs.com/en/Terms-and-Conditions.aspx> and, for electronic format documents, subject to Terms and Conditions for Electronic Documents at <http://www.sgs.com/en/Terms-and-Conditions/Terms-e-Documents.aspx>. Attention is drawn to the limitation of liability, indemnification and jurisdiction issues defined therein. Any holder of this document is advised that information contained hereon reflects the Company's findings at the time of its intervention only and within the limits of Client's instructions, if any. The Company's sole responsibility is to its Client and this document does not exonerate parties to a transaction from exercising all their rights and obligations under the transaction documents. This document cannot be reproduced except in full, without prior written approval of the Company. Any unauthorized alteration, forgery or falsification of the content or appearance of this document is unlawful and offenders may be prosecuted to the fullest extent of the law. Unless otherwise stated the results shown in this test report refer only to the sample(s) tested and such sample(s) are retained for 30 days only.

Attention: To check the authenticity of testing / inspection report & certificate, please contact us at telephone: (86-755) 8307 1443, or email: CN.Doccheck@sgs.com

895MHz to 1GHz

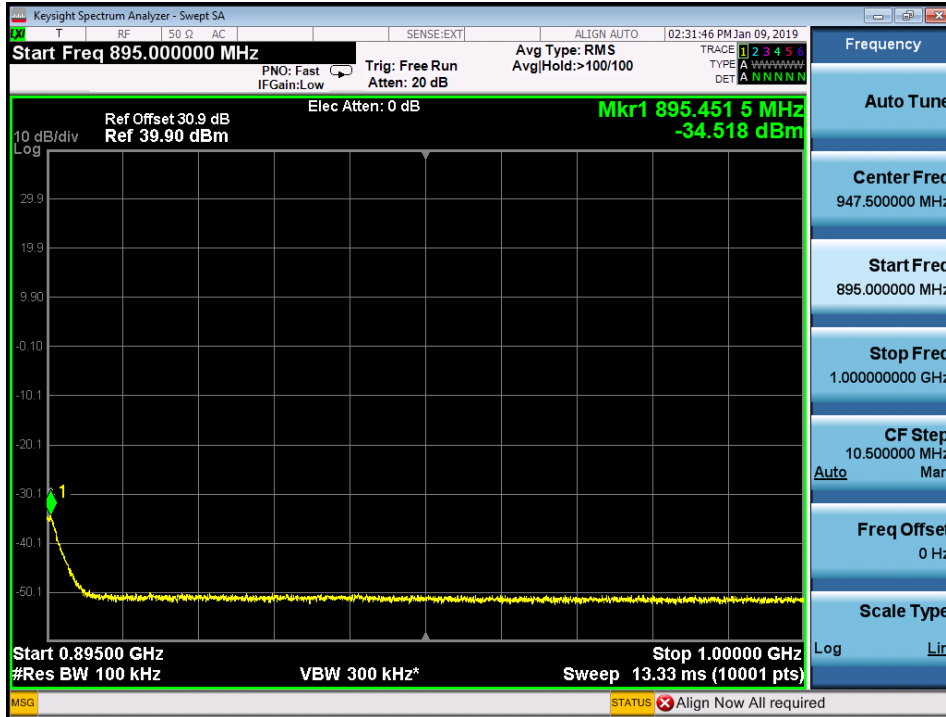

1GHz to 9GHz

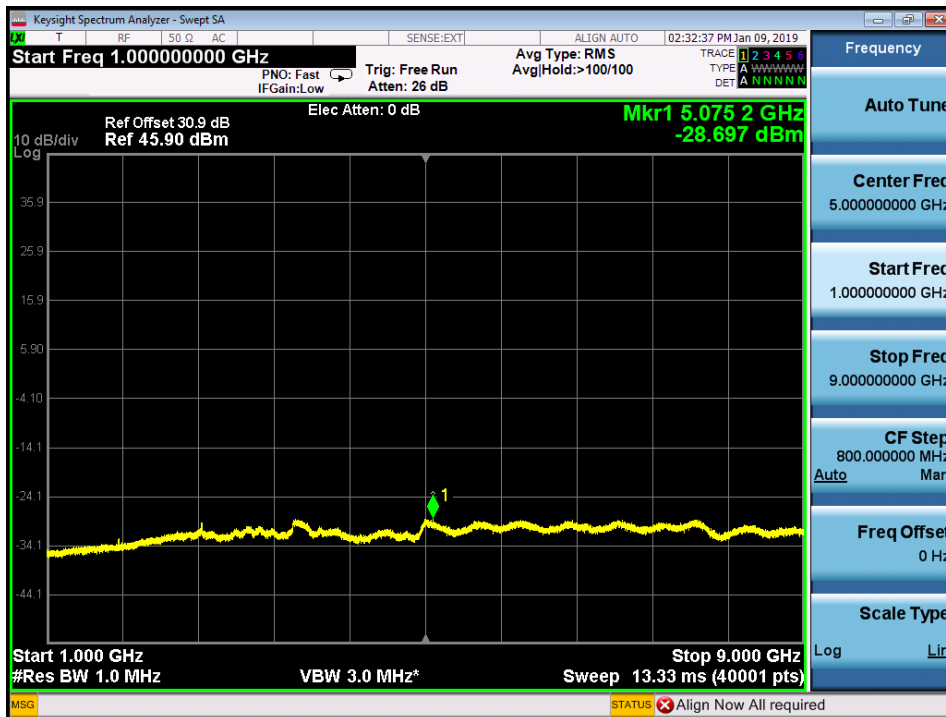

1.3 highest frequency

9kHz to 150kHz

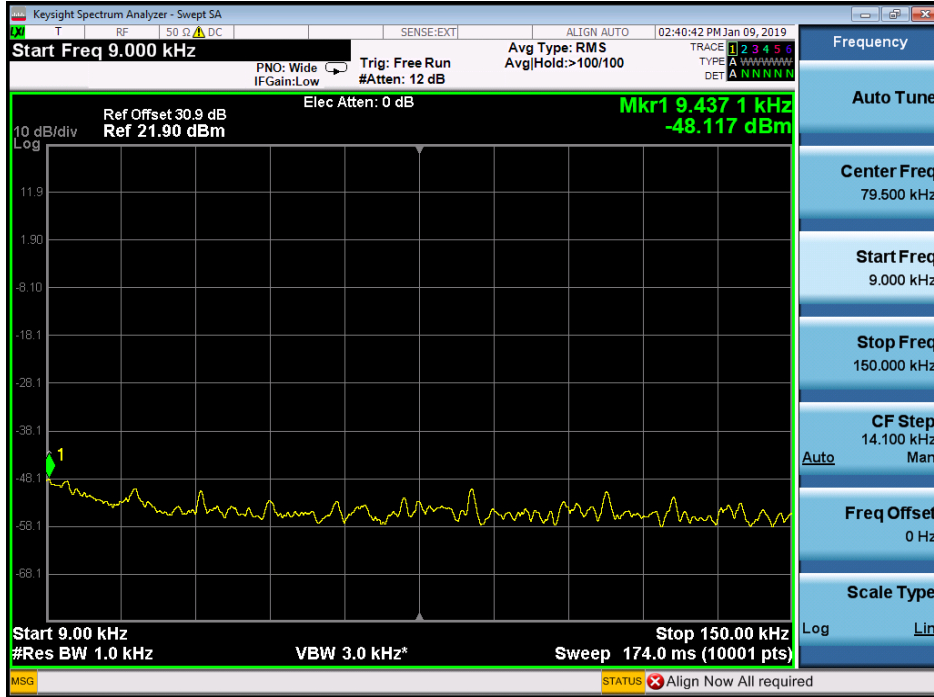

150kHz to 30MHz

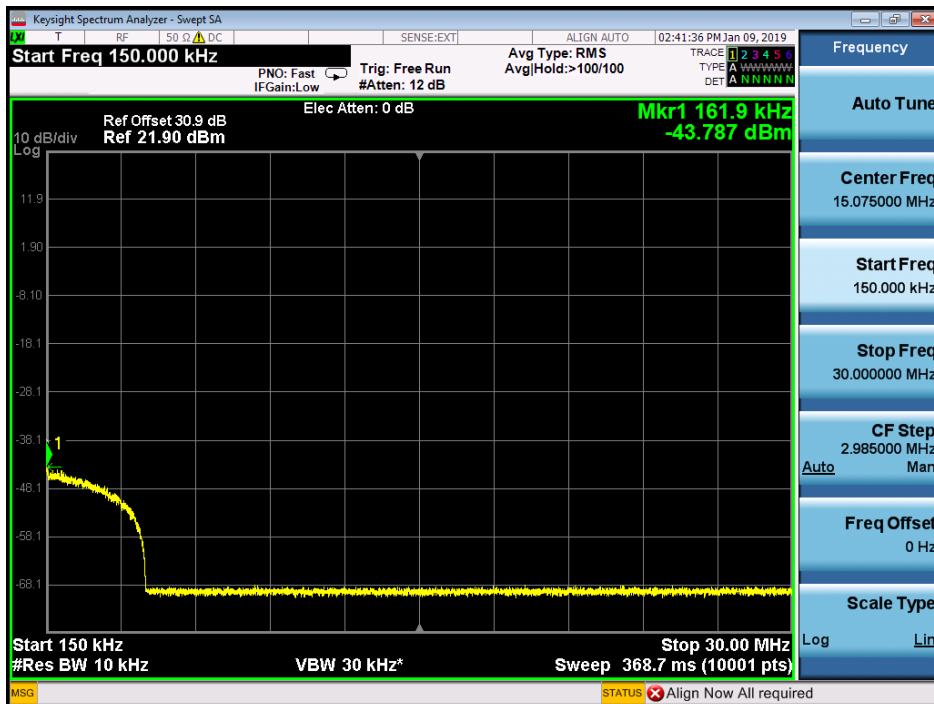

Unless otherwise agreed in writing, this document is issued by the Company subject to its General Conditions of Service printed overleaf, available on request or accessible at <http://www.sgs.com/en/Terms-and-Conditions.aspx> and, for electronic format documents, subject to Terms and Conditions for Electronic Documents at <http://www.sgs.com/en/Terms-and-Conditions/Terms-e-Documents.aspx>. Attention is drawn to the limitation of liability, indemnification and jurisdiction issues defined therein. Any holder of this document is advised that information contained hereon reflects the Company's findings at the time of its intervention only and within the limits of Client's instructions, if any. The Company's sole responsibility is to its Client and this document does not exonerate parties to a transaction from exercising all their rights and obligations under the transaction documents. This document cannot be reproduced except in full, without prior written approval of the Company. Any unauthorized alteration, forgery or falsification of the content or appearance of this document is unlawful and offenders may be prosecuted to the fullest extent of the law. Unless otherwise stated the results shown in this test report refer only to the sample(s) tested and such sample(s) are retained for 30 days only.

Attention: To check the authenticity of testing / inspection report & certificate, please contact us at telephone: (86-755) 8307 1443, or email: CN.Doccheck@sgs.com



30MHz to 861MHz

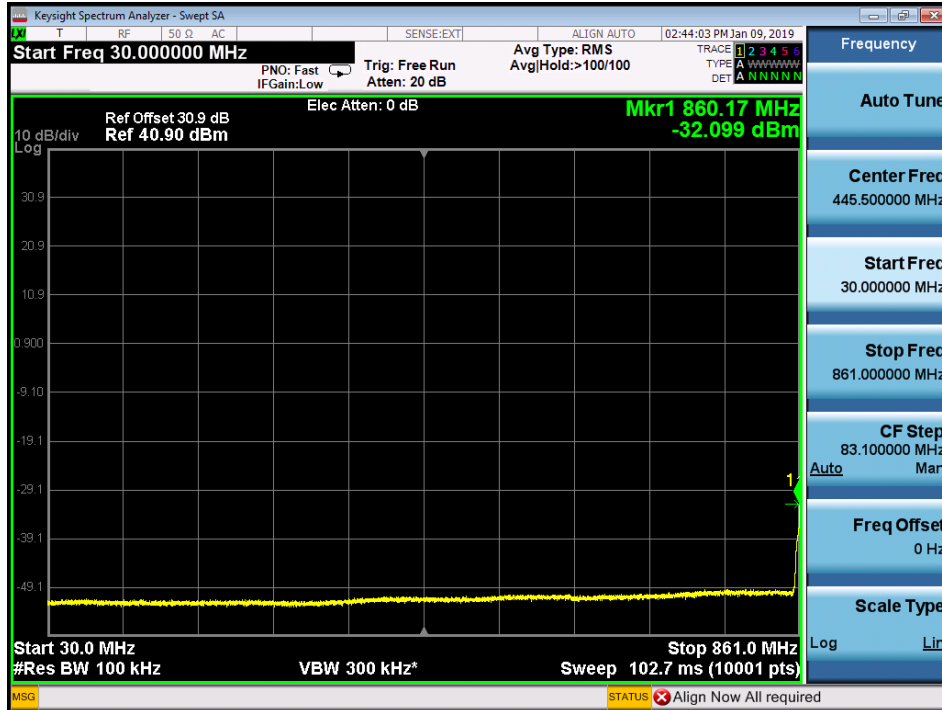

895MHz to 1GHz



Unless otherwise agreed in writing, this document is issued by the Company subject to its General Conditions of Service printed overleaf, available on request or accessible at <http://www.sgs.com/en/Terms-and-Conditions.aspx> and, for electronic format documents, subject to Terms and Conditions for Electronic Documents at <http://www.sgs.com/en/Terms-and-Conditions/Terms-e-Documents.aspx>. Attention is drawn to the limitation of liability, indemnification and jurisdiction issues defined therein. Any holder of this document is advised that information contained hereon reflects the Company's findings at the time of its intervention only and within the limits of Client's instructions, if any. The Company's sole responsibility is to its Client and this document does not exonerate parties to a transaction from exercising all their rights and obligations under the transaction documents. This document cannot be reproduced except in full, without prior written approval of the Company. Any unauthorized alteration, forgery or falsification of the content or appearance of this document is unlawful and offenders may be prosecuted to the fullest extent of the law. Unless otherwise stated the results shown in this test report refer only to the sample(s) tested and such sample(s) are retained for 30 days only.

Attention: To check the authenticity of testing / inspection report & certificate, please contact us at telephone: (86-755) 8307 1443, or email: CN.Doccheck@sgs.com

1GHz to 9GHz

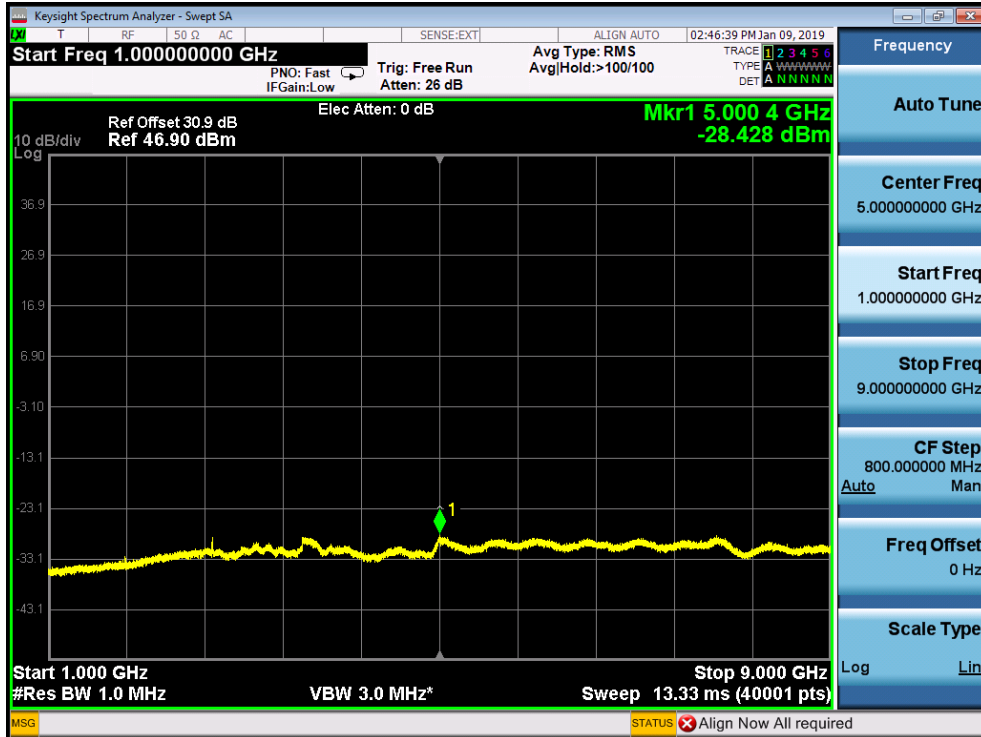

2. Downlink: 862MHz ~ 894MHz (GSM)

2.1 lowest frequency:

9kHz to 150kHz

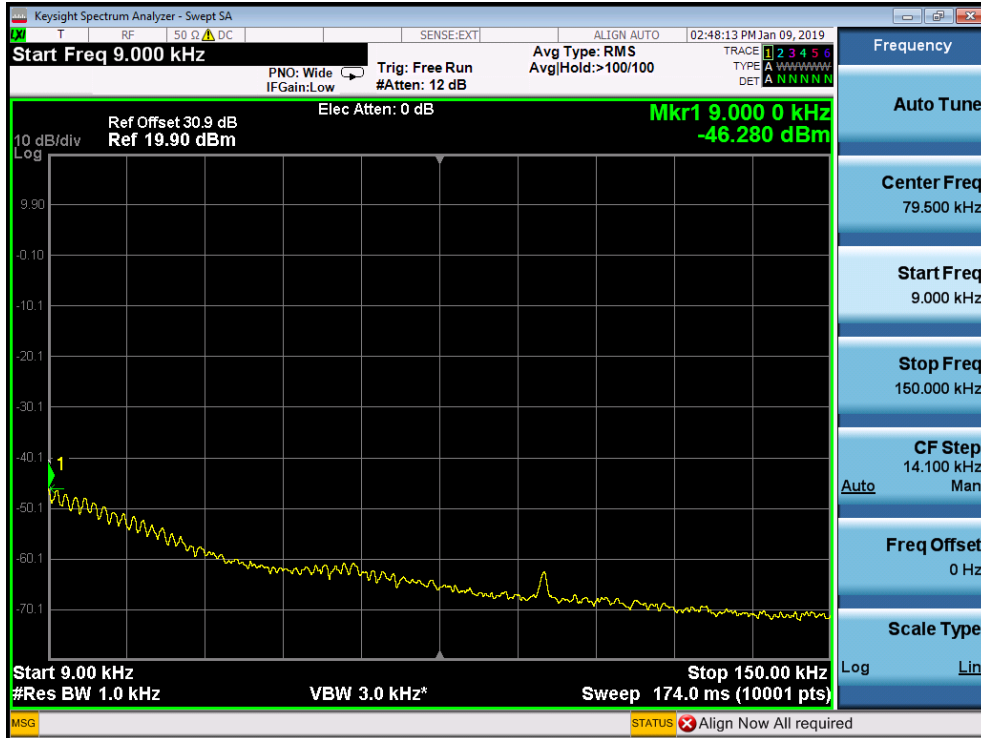



150kHz to 30MHz

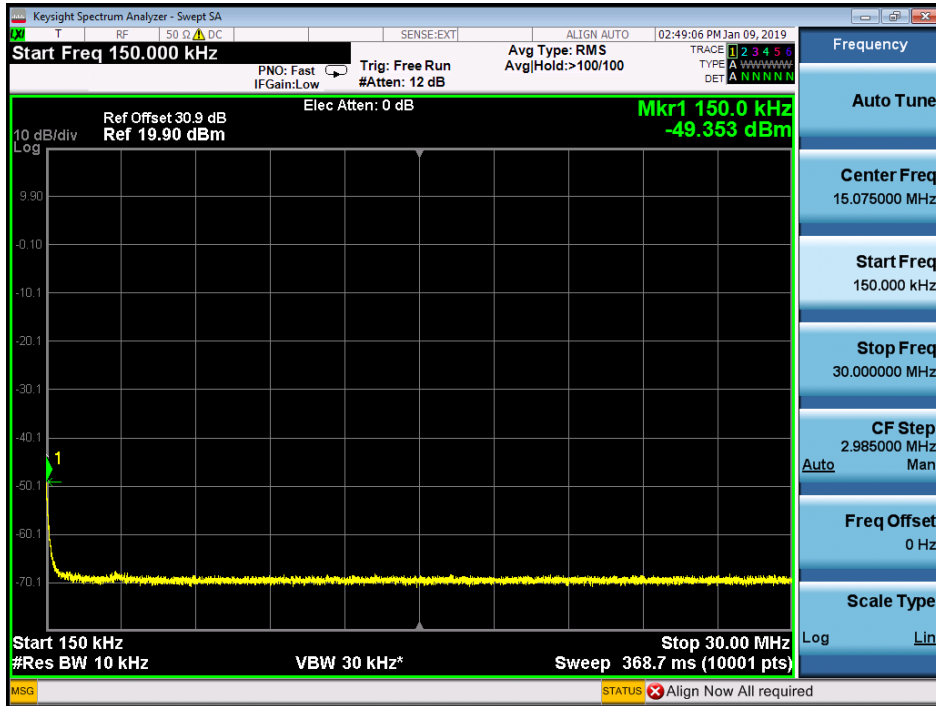

30MHz to 1GHz

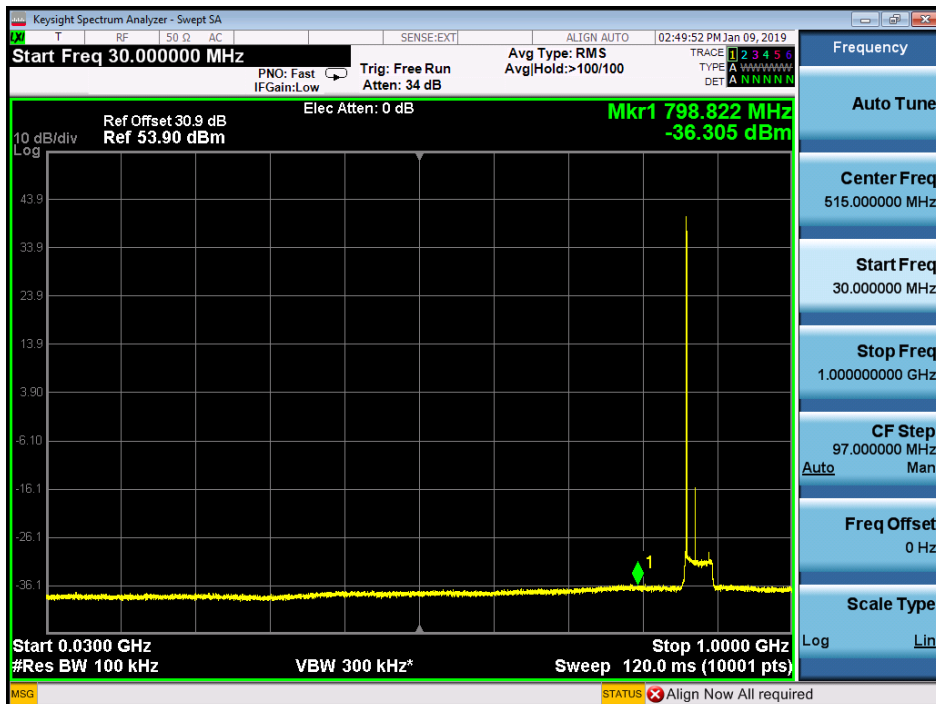

Unless otherwise agreed in writing, this document is issued by the Company subject to its General Conditions of Service printed overleaf, available on request or accessible at <http://www.sgs.com/en/Terms-and-Conditions.aspx> and, for electronic format documents, subject to Terms and Conditions for Electronic Documents at <http://www.sgs.com/en/Terms-and-Conditions/Terms-e-Document.aspx>. Attention is drawn to the limitation of liability, indemnification and jurisdiction issues defined therein. Any holder of this document is advised that information contained hereon reflects the Company's findings at the time of its intervention only and within the limits of Client's instructions, if any. The Company's sole responsibility is to its Client and this document does not exonerate parties to a transaction from exercising all their rights and obligations under the transaction documents. This document cannot be reproduced except in full, without prior written approval of the Company. Any unauthorized alteration, forgery or falsification of the content or appearance of this document is unlawful and offenders may be prosecuted to the fullest extent of the law. Unless otherwise stated the results shown in this test report refer only to the sample(s) tested and such sample(s) are retained for 30 days only.
Attention: To check the authenticity of testing /inspection report & certificate, please contact us at telephone: (86-755) 8307 1443, or email: CN.Doccheck@sgs.com



1GHz to 5GHz

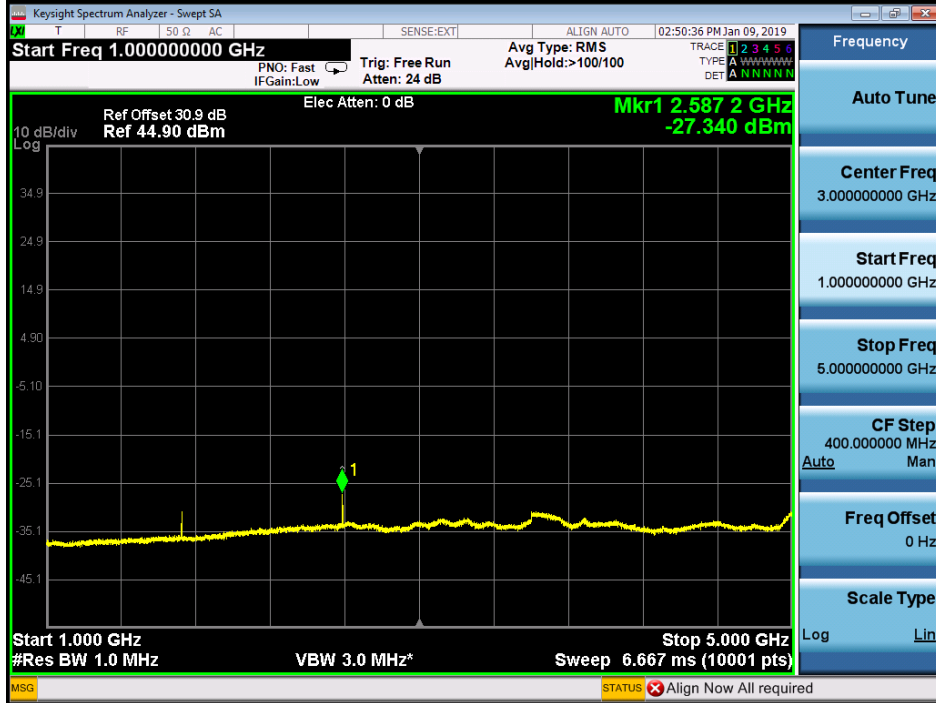

5GHz to 9GHz



Unless otherwise agreed in writing, this document is issued by the Company subject to its General Conditions of Service printed overleaf, available on request or accessible at <http://www.sgs.com/en/Terms-and-Conditions.aspx> and, for electronic format documents, subject to Terms and Conditions for Electronic Documents at <http://www.sgs.com/en/Terms-and-Conditions/Terms-e-Documents.aspx>. Attention is drawn to the limitation of liability, indemnification and jurisdiction issues defined therein. Any holder of this document is advised that information contained hereon reflects the Company's findings at the time of its intervention only and within the limits of Client's instructions, if any. The Company's sole responsibility is to its Client and this document does not exonerate parties to a transaction from exercising all their rights and obligations under the transaction documents. This document cannot be reproduced except in full, without prior written approval of the Company. Any unauthorized alteration, forgery or falsification of the content or appearance of this document is unlawful and offenders may be prosecuted to the fullest extent of the law. Unless otherwise stated the results shown in this test report refer only to the sample(s) tested and such sample(s) are retained for 30 days only.
Attention: To check the authenticity of testing /inspection report & certificate, please contact us at telephone: (86-755) 8307 1443, or email: CN.Doccheck@sgs.com

SGS-CSTC Standards Technical Services Co., Ltd.
Shenzhen Branch Inspection & Testing Services Laboratory

No.1 Workshop, M-10, Middle Section, Science & Technology Park, Shenzhen, China 518057 t (86-755) 26012053 f (86-755) 26710594 www.sgs.com.cn
中国·深圳·科技园中区M-10栋一号厂房 邮编: 518057 t (86-755) 26012053 f (86-755) 26710594 sgs.china@sgs.com



2.2 Middle frequency

9kHz to 150kHz



SGS-CSTC Standards Technical Services Co., Ltd.
 Shenzhen Branch (Shenzhen) EMC Laboratory

Unless otherwise agreed in writing, this document is issued by the Company subject to its General Conditions of Service printed overleaf, available on request or accessible at <http://www.sgs.com/en/Terms-and-Conditions.aspx> and, for electronic format documents, subject to Terms and Conditions for Electronic Documents at <http://www.sgs.com/en/Terms-and-Conditions/Terms-e-Documents.aspx>. Attention is drawn to the limitation of liability, indemnification and jurisdiction issues defined therein. Any holder of this document is advised that information contained hereon reflects the Company's findings at the time of its intervention only and within the limits of Client's instructions, if any. The Company's sole responsibility is to its Client and this document does not exonerate parties to a transaction from exercising all their rights and obligations under the transaction documents. This document cannot be reproduced except in full, without prior written approval of the Company. Any unauthorized alteration, forgery or falsification of the content or appearance of this document is unlawful and offenders may be prosecuted to the fullest extent of the law. Unless otherwise stated the results shown in this test report refer only to the sample(s) tested and such sample(s) are retained for 30 days only.
 Attention: To check the authenticity of testing /inspection report & certificate, please contact us at telephone: (86-755) 8307 1443, or email: CN.Doccheck@sgs.com

No.1 Workshop, M-10, Middle Section, Science & Technology Park, Shenzhen, China 518057 t (86-755) 26012053 f (86-755) 26710594 www.sgs.com.cn
 中国·深圳·科技园中区M-10栋一号厂房 邮编: 518057 t (86-755) 26012053 f (86-755) 26710594 sgs.china@sgs.com

150kHz to 30MHz

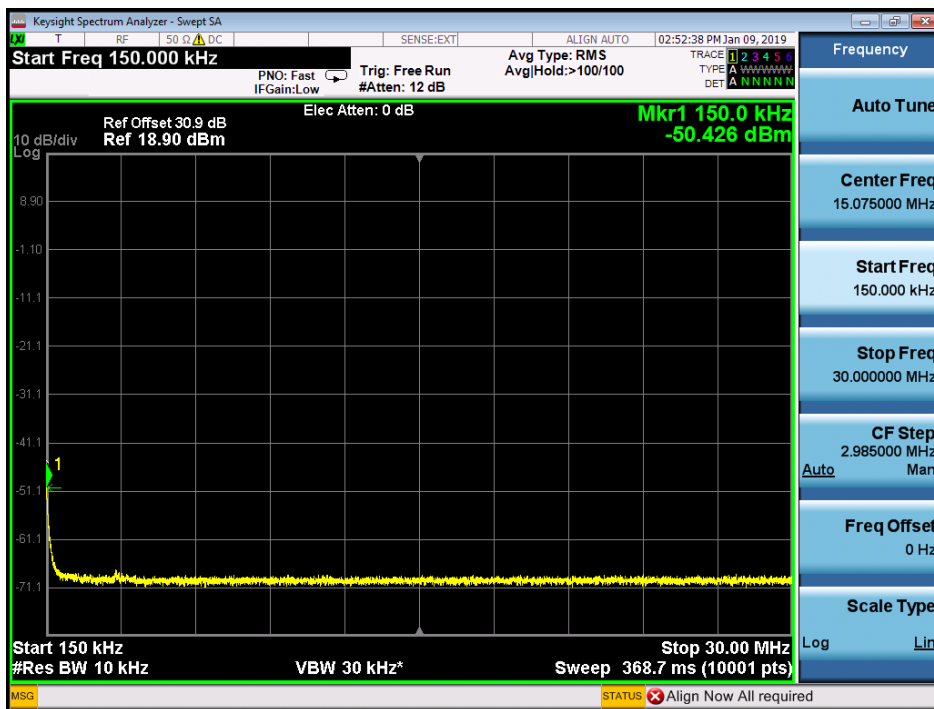

30MHz to 1GHz

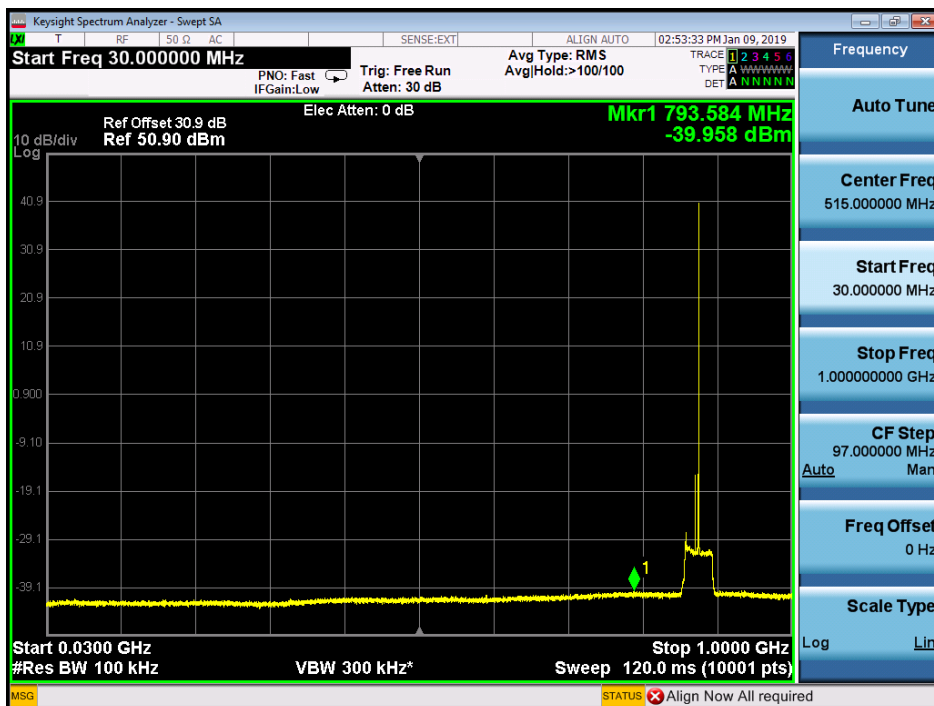



1GHz to 5GHz

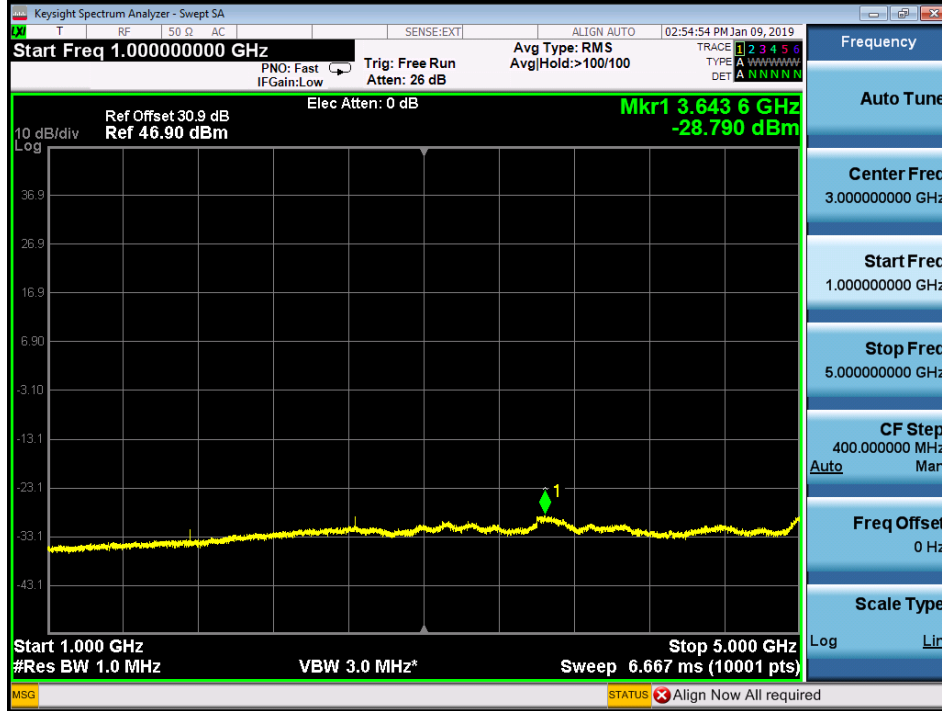

5GHz to 9GHz



Unless otherwise agreed in writing, this document is issued by the Company subject to its General Conditions of Service printed overleaf, available on request or accessible at <http://www.sgs.com/en/Terms-and-Conditions.aspx> and, for electronic format documents, subject to Terms and Conditions for Electronic Documents at <http://www.sgs.com/en/Terms-and-Conditions/Terms-e-Documents.aspx>. Attention is drawn to the limitation of liability, indemnification and jurisdiction issues defined therein. Any holder of this document is advised that information contained hereon reflects the Company's findings at the time of its intervention only and within the limits of Client's instructions, if any. The Company's sole responsibility is to its Client and this document does not exonerate parties to a transaction from exercising all their rights and obligations under the transaction documents. This document cannot be reproduced except in full, without prior written approval of the Company. Any unauthorized alteration, forgery or falsification of the content or appearance of this document is unlawful and offenders may be prosecuted to the fullest extent of the law. Unless otherwise stated the results shown in this test report refer only to the sample(s) tested and such sample(s) are retained for 30 days only.
Attention: To check the authenticity of testing /inspection report & certificate, please contact us at telephone: (86-755) 8307 1443, or email: CN.Doccheck@sgs.com

2.3 highest frequency

9kHz to 150kHz



150kHz to 30MHz



30MHz to 1GHz

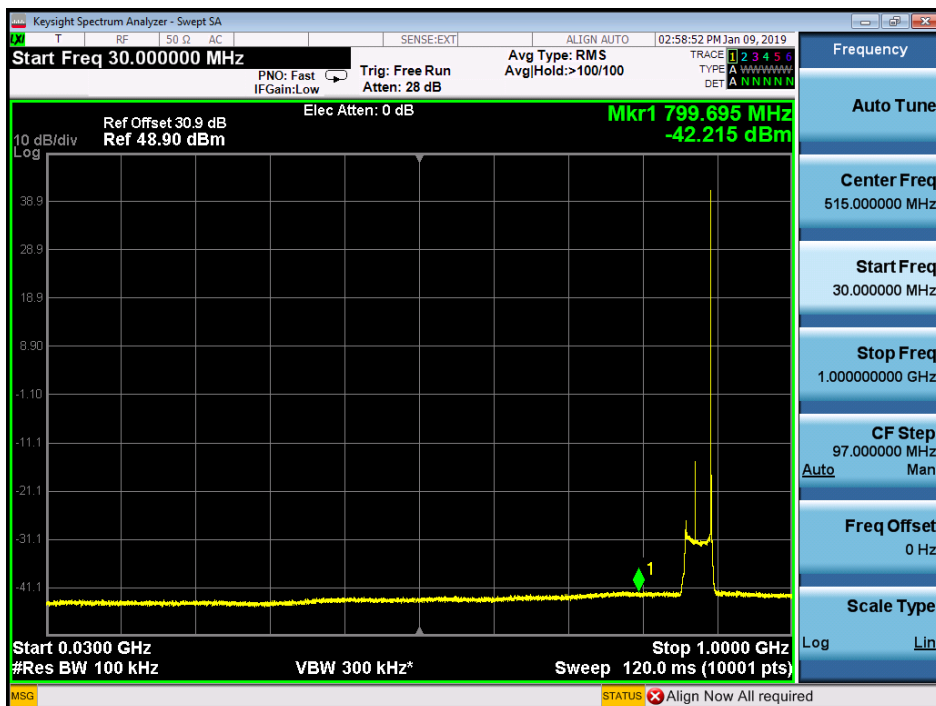



1GHz to 5GHz



5GHz to 9GHz



Note: When transmit only on single chain the limit is -13dBm and when On MIMO mode the limit is -16.01dBm



7.1.3 Out-of-band/out-of-block emissions

Test Requirement: FCC part 22.917(b).
 The limit is = -13 dBm.

Test Method: KDB 935210 D05 Indus Booster Basic Meas v01r01

EUT Operation:

Status: Drive the EUT to maximum output power.

Conditions: Normal conditions

Application: Cellular Band RF output ports

Test Configuration:

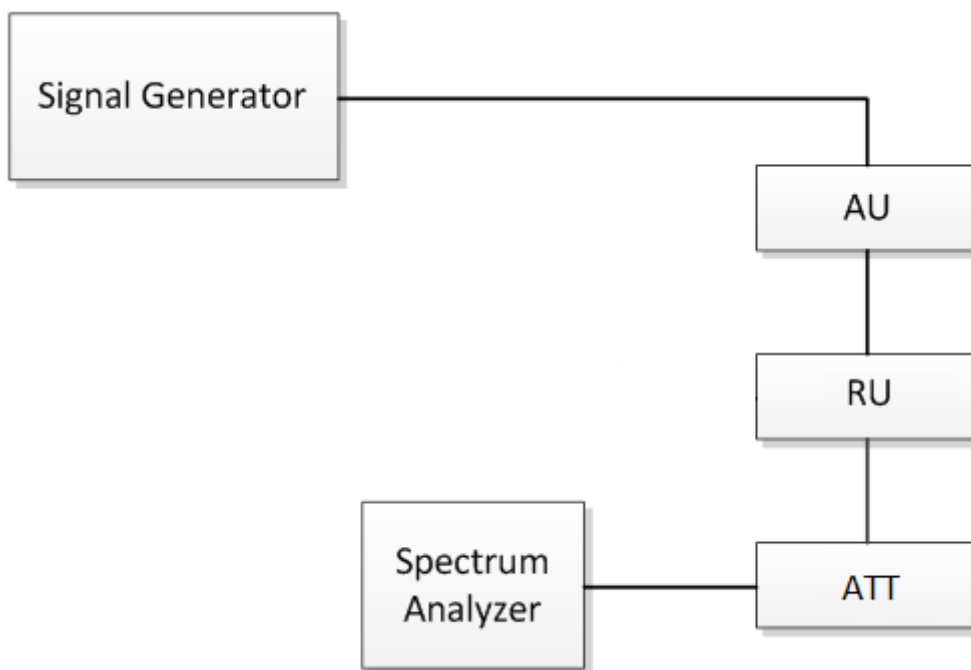

Fig.3. Band edge test configuration

Test Procedure: Out-of-band/out-of-block emissions test procedure:

- a) Connect a signal generator to the input of the EUT.
 If the signal generator is not capable of generating two modulated carriers simultaneously, then two discrete signal generators can be connected with an appropriate combining network to support this two-signal test.
- b) Set the signal generator to produce two AWGN signals as previously described (e.g., 4.1 MHz OBW).
- c) Set the center frequencies such that the AWGN signals occupy adjacent channels, as defined by industry standards such as 3GPP or 3GPP2, at the upper edge of the frequency band or block under test.
- d) Set the composite power levels such that the input signal is just below the AGC threshold (see 3.2), but not more than 0.5 dB below. The composite power



can be measured using the procedures provided in KDB Publication 971168 [R8], but it will be necessary to expand the power integration bandwidth so as to include both of the transmit channels. Alternatively, the composite power can be measured using an average power meter as described in KDB Publication 971168 [R8].

- e) Connect a spectrum analyzer to the output of the EUT using appropriate attenuation as necessary.
- f) Set the RBW = reference bandwidth in the applicable rule section for the supported frequency band (typically 1 % of the EBW or 100 kHz or 1 MHz)
- g) Set the VBW = 3 × RBW.
- h) Set the detector to power averaging (rms) detector.
- i) Set the Sweep time = auto-couple.
- j) Set the spectrum analyzer start frequency to the upper block edge frequency, and the stop frequency to the upper block edge frequency plus 300 kHz or 3 MHz, for frequencies below and above 1 GHz, respectively.
- k) Trace average at least 100 traces in power averaging (rms) mode.
- l) Use the marker function to find the maximum power level.
- m) Capture the spectrum analyzer trace of the power level for inclusion in the test report.
- n) Repeat steps k) to m) with the composite input power level set to 3 dB above the AGC threshold.
- o) Reset the frequencies of the input signals to the lower edge of the frequency block or band under test.
- p) Reset the spectrum analyzer start frequency to the lower block edge frequency minus 300 kHz or 3 MHz, for frequencies below and above 1 GHz, respectively, and the stop frequency to the lower band or block edge frequency.
- q) Repeat steps k) to n).
- r) Repeat steps a) to q) with the signal generator configured for a single test signal tuned as close as possible to the block edges.
- s) Repeat steps a) to r) with the narrowband test signal.
- t) Repeat steps a) to s) for all authorized frequency bands or blocks used by the EUT.

Remark:

- At maximum drive level, for each modulation: two tests (high-, low-band edge) with two tones
- Limit usually is -13dBm conducted.
- Not needed for Single Channel systems.

Test have been done with two modulated carriers and single modulated carriers, all modes have been tested and we only record the worst test result with two modulated carriers





7.1.3.1 Measurement Record:

Downlink: 862MHz to 894MHz (AWGN)

1.1 Pre-AGC_Lower Edge



SGS-CSTC Standards Technical Services Co., Ltd.
 Shenzhen Branch (China) EMC Laboratory

Unless otherwise agreed in writing, this document is issued by the Company subject to its General Conditions of Service printed overleaf, available on request or accessible at <http://www.sgs.com/en/Terms-and-Conditions.aspx> and, for electronic format documents, subject to Terms and Conditions for Electronic Documents at <http://www.sgs.com/en/Terms-and-Conditions/Terms-e-Documents.aspx>. Attention is drawn to the limitation of liability, indemnification and jurisdiction issues defined therein. Any holder of this document is advised that information contained hereon reflects the Company's findings at the time of its intervention only and within the limits of Client's instructions, if any. The Company's sole responsibility is to its Client and this document does not exonerate parties to a transaction from exercising all their rights and obligations under the transaction documents. This document cannot be reproduced except in full, without prior written approval of the Company. Any unauthorized alteration, forgery or falsification of the content or appearance of this document is unlawful and offenders may be prosecuted to the fullest extent of the law. Unless otherwise stated the results shown in this test report refer only to the sample(s) tested and such sample(s) are retained for 30 days only.
 Attention: To check the authenticity of testing /inspection report & certificate, please contact us at telephone: (86-755) 8307 1443, or email: CN.Doccheck@sgs.com

No.1 Workshop, M-10, Middle Section, Science & Technology Park, Shenzhen, China 518057 t (86-755) 26012053 f (86-755) 26710594 www.sgs.com.cn
 中国·深圳·科技园中区M-10栋一号厂房 邮编: 518057 t (86-755) 26012053 f (86-755) 26710594 sgs.china@sgs.com



1.2 3dB above AGC_Lower Edge





1.3 Pre-AGC_Higher Edge



1.4 3dB above AGC_Higher Edge



Unless otherwise agreed in writing, this document is issued by the Company subject to its General Conditions of Service printed overleaf, available on request or accessible at <http://www.sgs.com/en/Terms-and-Conditions.aspx> and, for electronic format documents, subject to Terms and Conditions for Electronic Documents at <http://www.sgs.com/en/Terms-and-Conditions/Terms-e-Documents.aspx>. Attention is drawn to the limitation of liability, indemnification and jurisdiction issues defined therein. Any holder of this document is advised that information contained hereon reflects the Company's findings at the time of its intervention only and within the limits of Client's instructions, if any. The Company's sole responsibility is to its Client and this document does not exonerate parties to a transaction from exercising all their rights and obligations under the transaction documents. This document cannot be reproduced except in full, without prior written approval of the Company. Any unauthorized alteration, forgery or falsification of the content or appearance of this document is unlawful and offenders may be prosecuted to the fullest extent of the law. Unless otherwise stated the results shown in this test report refer only to the sample(s) tested and such sample(s) are retained for 30 days only.

Attention: To check the authenticity of testing /inspection report & certificate, please contact us at telephone: (86-755) 8307 1443, or email: CN.Doccheck@sgs.com

SGS-CSTC Standards Technical Services Co., Ltd.
Shenzhen Branch

No.1 Workshop, M-10, Middle Section, Science & Technology Park, Shenzhen, China 518057 t (86-755) 26012053 f (86-755) 26710594 www.sgs.com.cn
中国·深圳·科技园中区M-10栋一号厂房 邮编: 518057 t (86-755) 26012053 f (86-755) 26710594 sgs.china@sgs.com

Downlink: 862MHz to 894MHz (GSM)

1.1 Pre-AGC_Lower Edge



1.2 3dB above AGC_Lower Edge



1.3 Pre-AGC_Higher Edge



Unless otherwise agreed in writing, this document is issued by the Company subject to its General Conditions of Service printed overleaf, available on request or accessible at <http://www.sgs.com/en/Terms-and-Conditions.aspx> and, for electronic format documents, subject to Terms and Conditions for Electronic Documents at <http://www.sgs.com/en/Terms-and-Conditions/Terms-e-Documents.aspx>. Attention is drawn to the limitation of liability, indemnification and jurisdiction issues defined therein. Any holder of this document is advised that information contained hereon reflects the Company's findings at the time of its intervention only and within the limits of Client's instructions, if any. The Company's sole responsibility is to its Client and this document does not exonerate parties to a transaction from exercising all their rights and obligations under the transaction documents. This document cannot be reproduced except in full, without prior written approval of the Company. Any unauthorized alteration, forgery or falsification of the content or appearance of this document is unlawful and offenders may be prosecuted to the fullest extent of the law. Unless otherwise stated the results shown in this test report refer only to the sample(s) tested and such sample(s) are retained for 30 days only.
Attention: To check the authenticity of testing / inspection report & certificate, please contact us at telephone: (86-755) 8307 1443, or email: CN.Doccheck@sgs.com



1.4 3dB above AGC_ Higher Edge



Note: When transmit only on single chain the limit is -13dBm and when On MIMO mode the limit is -16.01dBm



7.1.4 Radiated Spurious Emissions

- Test Requirement: FCC part 22.917(a).
 The limit is = -13 dBm.
- Test Method: KDB 935210 D05 Indus Booster Basic Meas v01r01
- EUT Operation:
- Status: Drive the EUT to maximum output power.
- Conditions: Normal conditions
- Application: Enclosure
- Test Configuration:

30MHz to 1GHz emissions:

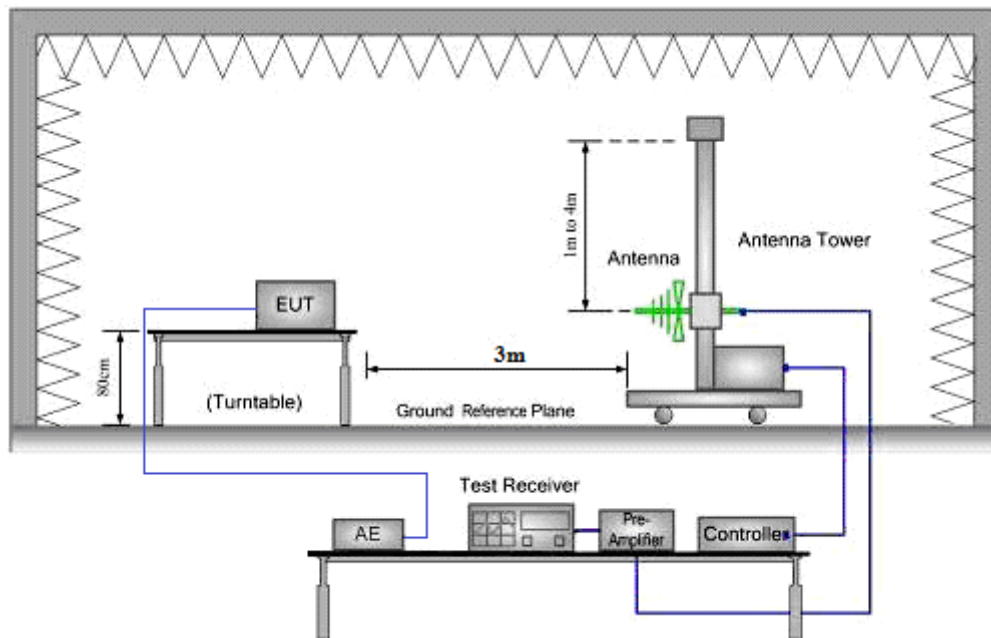

1GHz to 40GHz emissions:

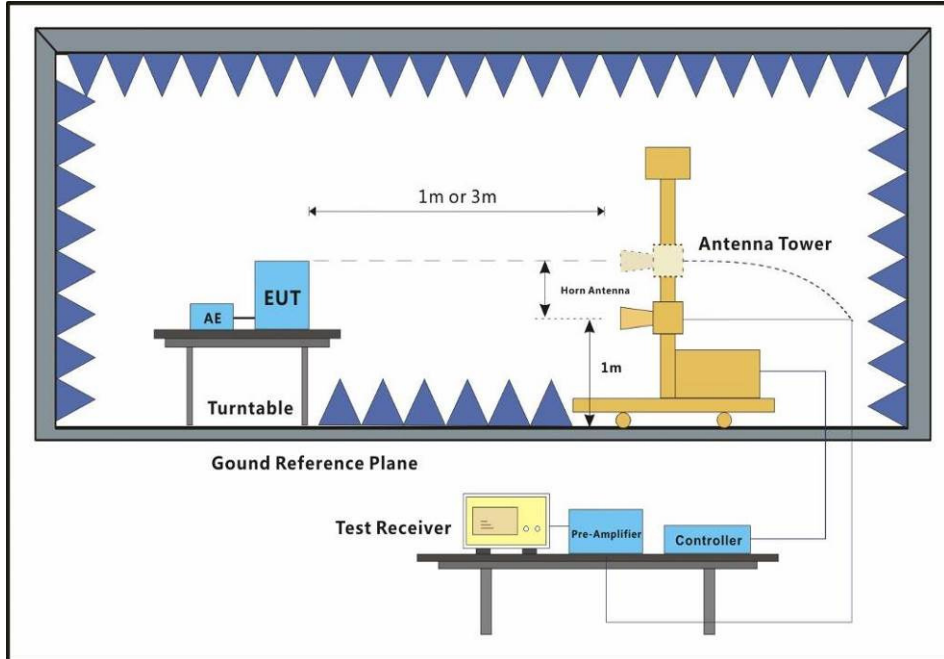

Test Procedure:

1. Test the background noise level with all the test facilities;
2. Keep one transmitting path, all other connectors shall be connected by normal power or RF leads;
3. Select the suitable RF notch filter to avoid the test receiver or spectrum analyzer produce unwanted spurious emissions;
4. Keep the EUT continuously transmitting in max power;
5. Read the radiated emissions of the EUT enclosure.

Radiated Emissions Test Procedure:

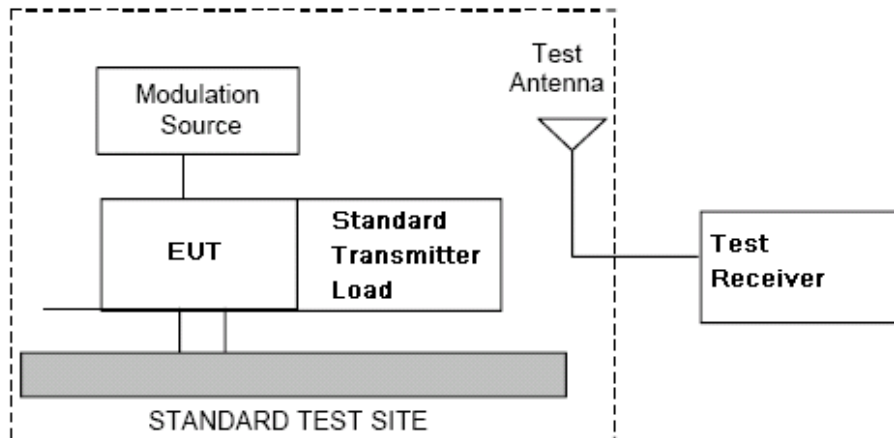

- a) Connect the equipment as illustrated.
- b) Adjust the spectrum analyzer for the following settings:
 - 1) Resolution Bandwidth = 100 kHz for spurious emissions below 1 GHz, and 1 MHz for spurious emissions above 1GHz.
 - 2) Video Bandwidth = 300 kHz for spurious emissions below 1 GHz, and 3 MHz for spurious emissions above 1 GHz.
 - 3) Sweep Speed slow enough to maintain measurement calibration.
 - 4) Detector Mode = Positive Peak.
- c) Place the transmitter to be tested on the turntable in the standard test site, The transmitter is transmitting into a no radiating load that is placed on the turntable. The RF cable to this load should be of minimum length.
- d) Measurements shall be made from 30MHz to 10 times of fundamental carrier, except for the region close to the carrier equal to \pm the carrier bandwidth.
- e) Key the transmitter without modulation or normal modulation base the standard.
- f) For each spurious frequency, raise and lower the test antenna from 1 m to 4 m to obtain a maximum reading on the spectrum analyzer with the test antenna at horizontal polarity. Then the turntable should be rotated 360° to determine the maximum reading. Repeat this procedure to obtain the highest possible reading. Record this maximum reading.
- g) Repeat step f) for each spurious frequency with the test antenna polarized vertically.

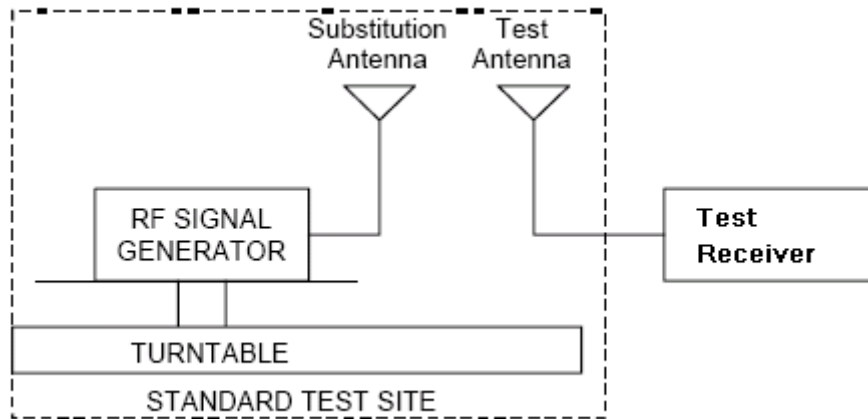

- h) Reconnect the equipment as illustrated.
- i) Keep the spectrum analyzer adjusted as in step b).
- j) Remove the transmitter and replace it with a substitution antenna (the antenna should be half-wavelength for each frequency involved). The center of the substitution antenna should be approximately at the same location as the center of the transmitter. At the lower frequencies, where the substitution antenna is very long, this will be impossible to achieve when the antenna is polarized vertically. In such case the lower end of the antenna should be 0.3 m above the ground.
- k) Feed the substitution antenna at the transmitter end with a signal generator connected to the antenna by means of a non-radiating cable. With the antennas at both ends horizontally polarized, and with the signal generator tuned to a particular spurious frequency, raise and lower the test antenna to obtain a maximum reading at the spectrum analyzer. Adjust the level of the signal generator output until the previously recorded maximum reading for this set of conditions is obtained. This should be done carefully repeating the adjustment of the test antenna and generator output.
- l) Repeat step k) with both antennas vertically polarized for each spurious frequency.
- m) Calculate power in dBm into a reference ideal half-wave dipole antenna by reducing the readings obtained in steps k) and l) by the power loss in the cable between the generator and the antenna, and further corrected for the gain of the substitution antenna used relative to an ideal half-wave dipole antenna by the following formula:

$$P_d(\text{dBm}) = P_g(\text{dBm}) - \text{cable loss (dB)} + \text{antenna gain (dB)}$$

where:

P_d is the dipole equivalent power and

P_g is the generator output power into the substitution antenna.

NOTE:

- 1) It is permissible to use other antennas provided they can be referenced to a dipole.
- 2) For below 1GHz signal, the *antenna gain* (dB) is dBd, and for above 1GHz signal, the *antenna gain* (dB) is dBi
- 3) Effective radiated power (e.r.p) refers to the radiation of a half wave tuned dipole instead of an isotropic antenna. There is a constant difference of 2.15 dB between e.i.r.p. and e.r.p.
 $e.r.p. (\text{dBm}) = e.i.r.p. (\text{dBm}) - 2.15$
- 4) For this test, the AU and EU are put outside of the sample chamber; connect to the RU through the optical fiber



Unless otherwise agreed in writing, this document is issued by the Company subject to its General Conditions of Service printed overleaf, available on request or accessible at <http://www.sgs.com/en/Terms-and-Conditions.aspx> and, for electronic format documents, subject to Terms and Conditions for Electronic Documents at <http://www.sgs.com/en/Terms-and-Conditions/Terms-e-Documents.aspx>. Attention is drawn to the limitation of liability, indemnification and jurisdiction issues defined therein. Any holder of this document is advised that information contained hereon reflects the Company's findings at the time of its intervention only and within the limits of Client's instructions, if any. The Company's sole responsibility is to its Client and this document does not exonerate parties to a transaction from exercising all their rights and obligations under the transaction documents. This document cannot be reproduced except in full, without prior written approval of the Company. Any unauthorized alteration, forgery or falsification of the content or appearance of this document is unlawful and offenders may be prosecuted to the fullest extent of the law. Unless otherwise stated the results shown in this test report refer only to the sample(s) tested and such sample(s) are retained for 30 days only.
Attention: To check the authenticity of testing / inspection report & certificate, please contact us at telephone: (86-755) 8307 1443, or email: CN.Doccheck@sgs.com

7.1.4.1 Measurement Record:

No emissions were detected within 20dB below the limit for the Downlink direction. Test on MIMO mode.

Downlink 862MHz to 894MHz:

Lowest Channel					
Frequency (MHz)	Spurious Emission Level			Limit dBm	Over limit (dB)
	(Deg)	Polaxis	(dBm)		
61.12	322.0	H	-69.90	-13.0	-56.90
218.76	211.0	H	-73.66	-13.0	-60.66
2397.50	330.0	H	-58.71	-13.0	-45.71
4125.00	1.0	H	-62.32	-13.0	-49.32
5212.50	331.0	H	-59.91	-13.0	-46.91
9830.25	0.0	H	-59.18	-13.0	-46.18

Lowest Channel					
Frequency (MHz)	Spurious Emission Level			Limit dBm	Over limit (dB)
	(Deg)	Polaxis	(dBm)		
47.59	320.0	V	-71.13	-13.0	-58.13
59.82	44.0	V	-72.89	-13.0	-59.89
2200.50	102.0	V	-59.15	-13.0	-46.15
4125.00	0.0	V	-60.16	-13.0	-47.16
5537.25	333.0	V	-60.38	-13.0	-47.38
9830.25	0.0	V	-51.02	-13.0	-38.02



Middle Channel					
Frequency (MHz)	Spurious Emission Level			Limit dBm	Over limit (dB)
	(Deg)	Polaxis	(dBm)		
60.75	300.0	H	-70.14	-13.0	-57.14
217.64	209.0	H	-72.31	-13.0	-59.31
2398.00	272.0	H	-58.72	-13.0	-45.72
4125.00	0.0	H	-59.79	-13.0	-46.79
5212.50	331.0	H	-59.61	-13.0	-46.61
9830.25	0.0	H	-54.64	-13.0	-41.64

Middle Channel					
Frequency (MHz)	Spurious Emission Level			Limit dBm	Over limit (dB)
	(Deg)	Polaxis	(dBm)		
48.24	339.0	V	-71.18	-13.0	-58.18
59.96	359.0	V	-72.70	-13.0	-59.70
2773.00	272.0	V	-57.09	-13.0	-44.09
4125.00	0.0	V	-61.28	-13.0	-48.28
5537.25	332.0	V	-59.98	-13.0	-46.98
9830.25	0.0	V	-50.69	-13.0	-37.69





Highest Channel					
Frequency (MHz)	Spurious Emission Level			Limit dBm	Over limit (dB)
	(Deg)	Polaxis	(dBm)		
60.47	320.0	H	-70.13	-13.0	-57.13
219.93	191.0	H	-73.49	-13.0	-60.49
2200.00	44.0	H	-59.46	-13.0	-46.46
4125.00	0.0	H	-62.01	-13.0	-49.01
5212.50	331.0	H	-59.87	-13.0	-46.87
9830.25	0.0	H	-61.83	-13.0	-48.83

Highest Channel					
Frequency (MHz)	Spurious Emission Level			Limit dBm	Over limit (dB)
	(Deg)	Polaxis	(dBm)		
47.54	339.0	V	-71.29	-13.0	-58.29
60.05	0.0	V	-72.61	-13.0	-59.61
2464.50	73.0	V	-58.68	-13.0	-45.68
4125.00	0.0	V	-61.31	-13.0	-48.31
5537.25	332.0	V	-61.84	-13.0	-48.84
9830.25	0.0	V	-60.33	-13.0	-47.33

Remark:

The cabinet radiation was measured with the equipment transmitting a CW signal into a non-radiating 50 Ohm load at maximum output power on a signal frequency.

Measured were performed in the lowest, middle and highest frequency for the Downlink.

The spectrum was searched from 30MHz to 20GHz (10th Harmonic) for downlink.



Unless otherwise agreed in writing, this document is issued by the Company subject to its General Conditions of Service printed overleaf, available on request or accessible at <http://www.sgs.com/en/Terms-and-Conditions.aspx> and, for electronic format documents, subject to Terms and Conditions for Electronic Documents at <http://www.sgs.com/en/Terms-and-Conditions/Terms-e-Documents.aspx>. Attention is drawn to the limitation of liability, indemnification and jurisdiction issues defined therein. Any holder of this document is advised that information contained hereon reflects the Company's findings at the time of its intervention only and within the limits of Client's instructions, if any. The Company's sole responsibility is to its Client and this document does not exonerate parties to a transaction from exercising all their rights and obligations under the transaction documents. This document cannot be reproduced except in full, without prior written approval of the Company. Any unauthorized alteration, forgery or falsification of the content or appearance of this document is unlawful and offenders may be prosecuted to the fullest extent of the law. Unless otherwise stated the results shown in this test report refer only to the sample(s) tested and such sample(s) are retained for 30 days only.
Attention: To check the authenticity of testing /inspection report & certificate, please contact us at telephone: (86-755) 8307 1443, or email: CN.Doccheck@sgs.com

7.1.5 Occupied bandwidth and Input-versus-output signal comparison

Test Requirement: FCC part 2.1049
 The spectral shape of the output should look similar to input for all modulations.

EUT Operation:
 Status: Drive the EUT to maximum output power. .
 Conditions: Normal conditions
 Application: Cellular Band RF output ports
 Test Configuration:

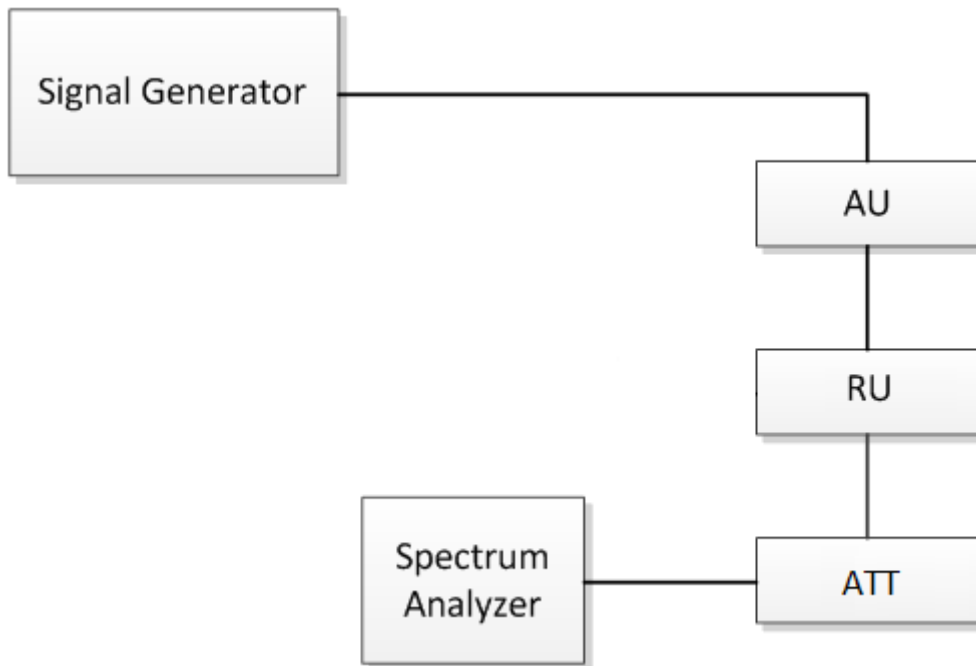

Fig.2. Conducted test configuration

- Test Procedure:
- Connect a signal generator to the input of the EUT.
 - Configure the signal generator to transmit the AWGN signal.
 - Configure the signal amplitude to be just below the AGC threshold level (see 3.2), but not more than 0.5 dB below.
 - Connect a spectrum analyzer to the output of the EUT using appropriate attenuation.
 - Set the spectrum analyzer center frequency to the center frequency of the operational band under test. The span range of the spectrum analyzer shall be between 2 times to 5 times the emission bandwidth (EBW) or alternatively, the OBW.
 - The nominal RBW shall be in the range of 1 % to 5 % of the anticipated OBW, and the VBW shall be $\geq 3 \times$ RBW.
 - Set the reference level of the instrument as required to preclude





the signal from exceeding the maximum spectrum analyzer input mixer level for linear operation. In general, the peak of the spectral envelope must be more than $[10 \log (OBW / RBW)]$ below the reference level.

Steps f) and g) may require iteration to enable adjustments within the specified tolerances.

h) The noise floor of the spectrum analyzer at the selected RBW shall be at least 36 dB below the reference level.

i) Set spectrum analyzer detection function to positive peak.

j) Set the trace mode to max hold.

k) Determine the reference value: Allow the trace to stabilize. Set the spectrum analyzer marker to the highest amplitude level of the displayed trace (this is the reference value) and record the associated frequency as f_0 .

l) Place two markers, one at the lowest and the other at the highest frequency of the envelope of the spectral display, such that each marker is at or slightly below the -26 dB down amplitude. The 26 dB EBW (alternatively OBW) is the positive frequency difference between the two markers. If the spectral envelope crosses the -26 dB down amplitude at multiple points, the lowest or highest frequency shall be selected as the frequencies that are the furthest removed from the center frequency at which the spectral envelope crosses the -26 dB down amplitude point.

m) Repeat steps e) to l) with the input signal connected directly to the spectrum analyzer (i.e., input signal measurement).

n) Compare the spectral plot of the input signal (determined from step m) to the output signal (determined from step l) to affirm that they are similar (in passband and rolloff characteristic features and relative spectral locations), and include plot(s) and descriptions in test report.

o) Repeat the procedure [steps e) to n)] with the input signal amplitude set to 3 dB above the AGC threshold.

p) Repeat steps e) to o) with the signal generator set to the narrowband signal.

q) Repeat steps e) to p) for all frequency bands authorized for use by the EUT.



7.1.5.1 Measurement Record:

1.Downlink: 862MHz to 894MHz (AWGN)

1.1 Pre-AGC

Input

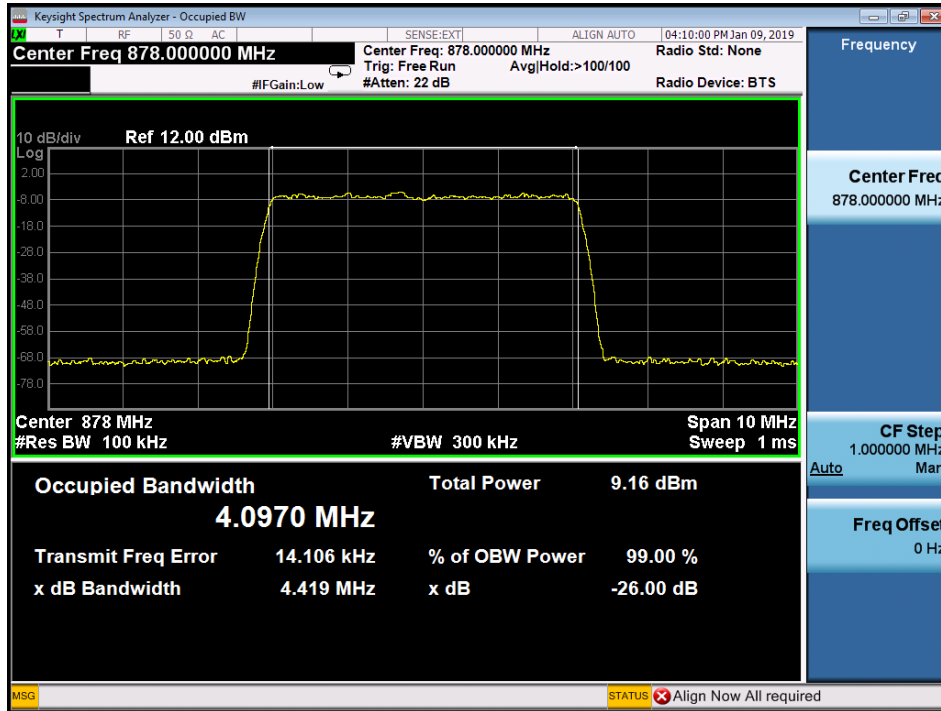

Output

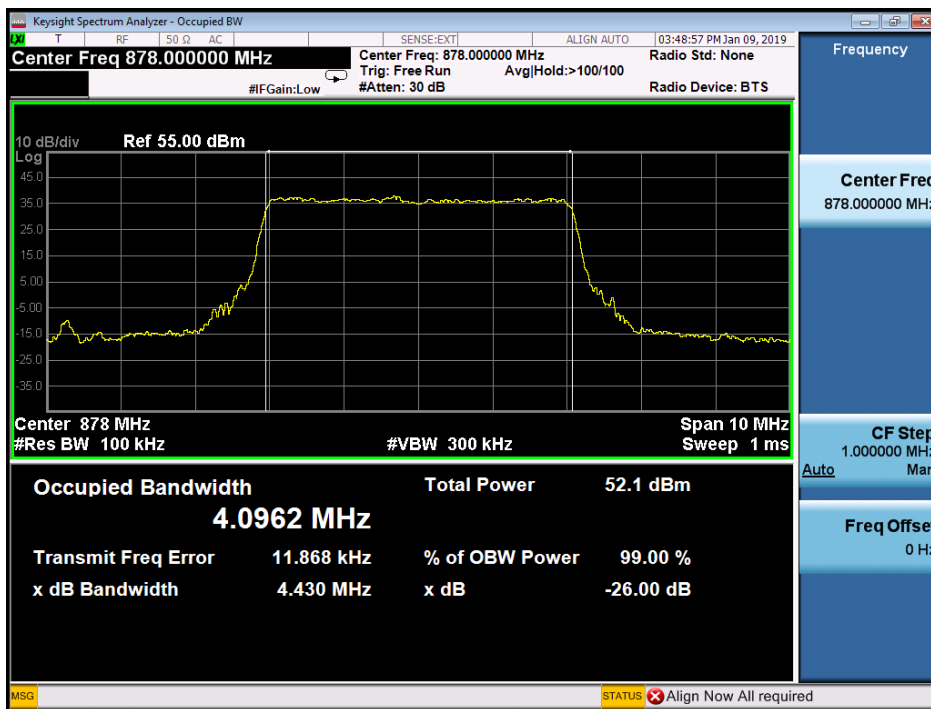



1.2 3dB above AGC
 Input

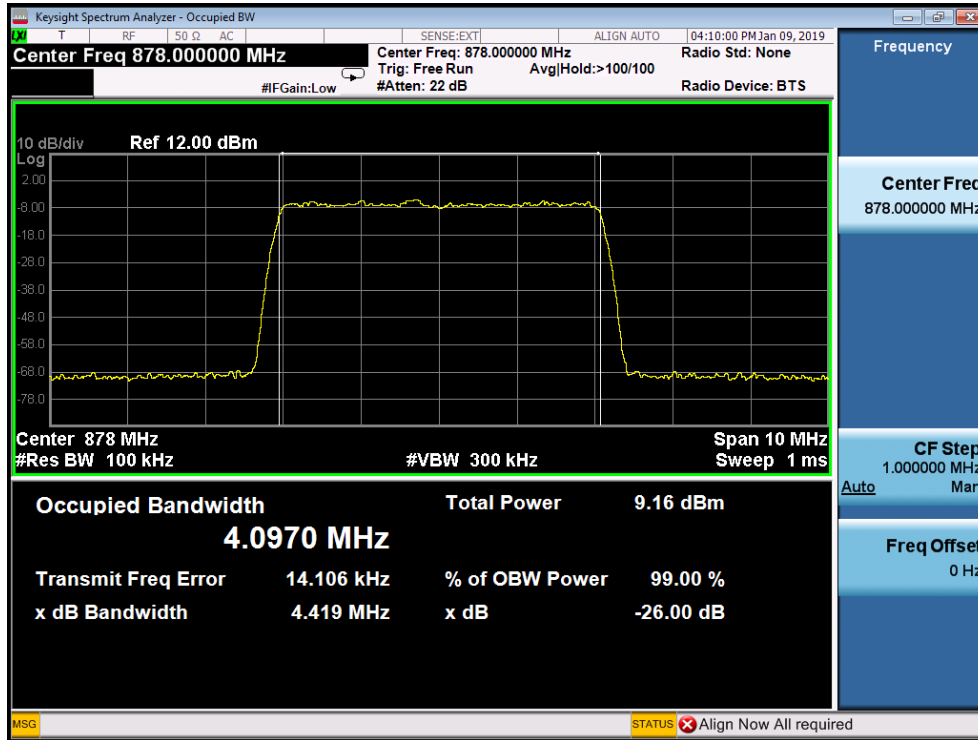

Output

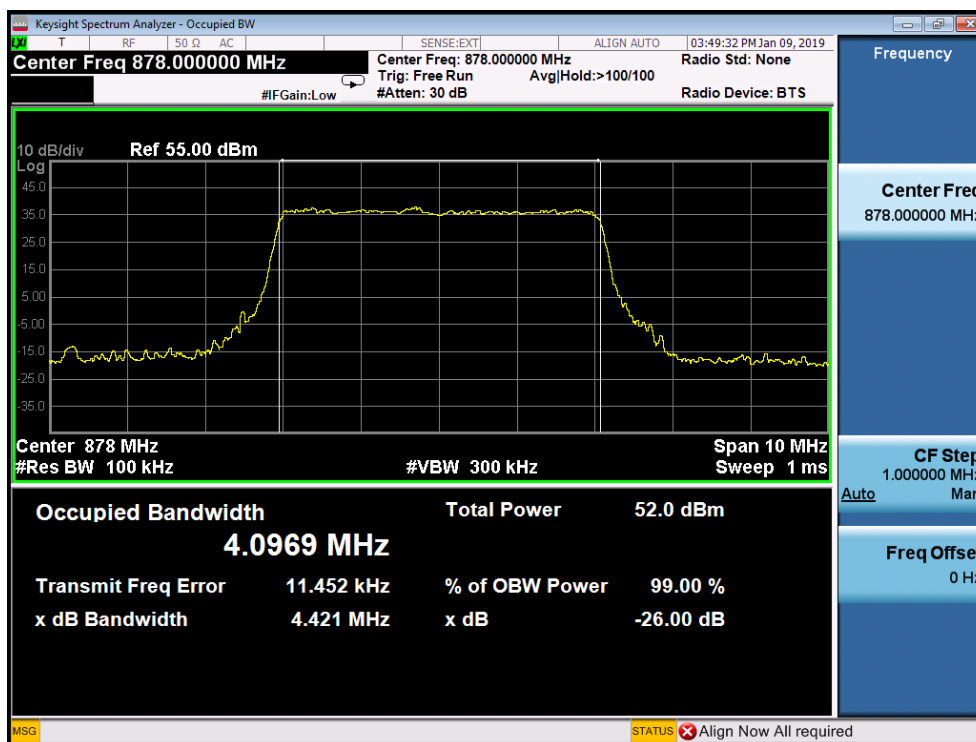

2. Downlink: 862MHz to 894MHz (GSM)

2.1 Pre-AGC

Input

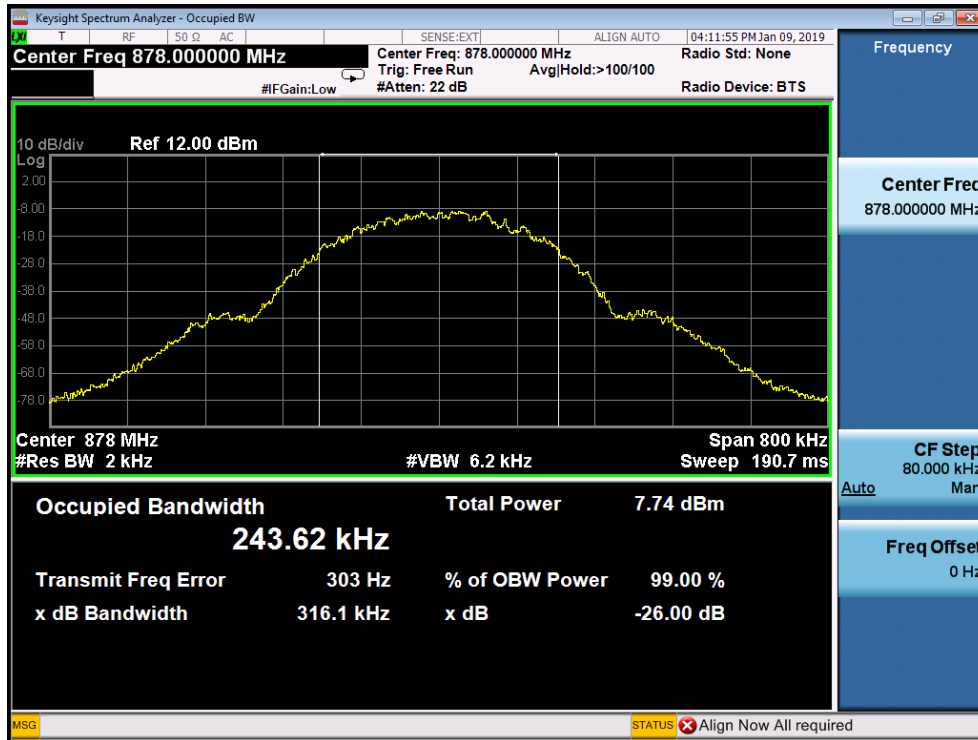

Output

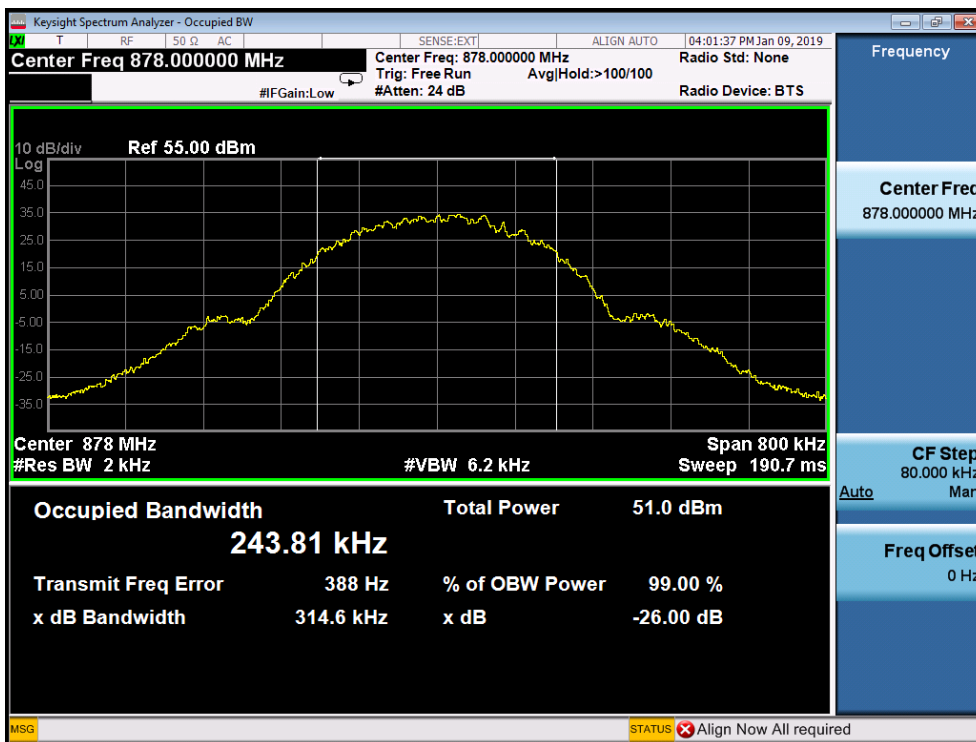



2.2 3dB above AGC
 Input

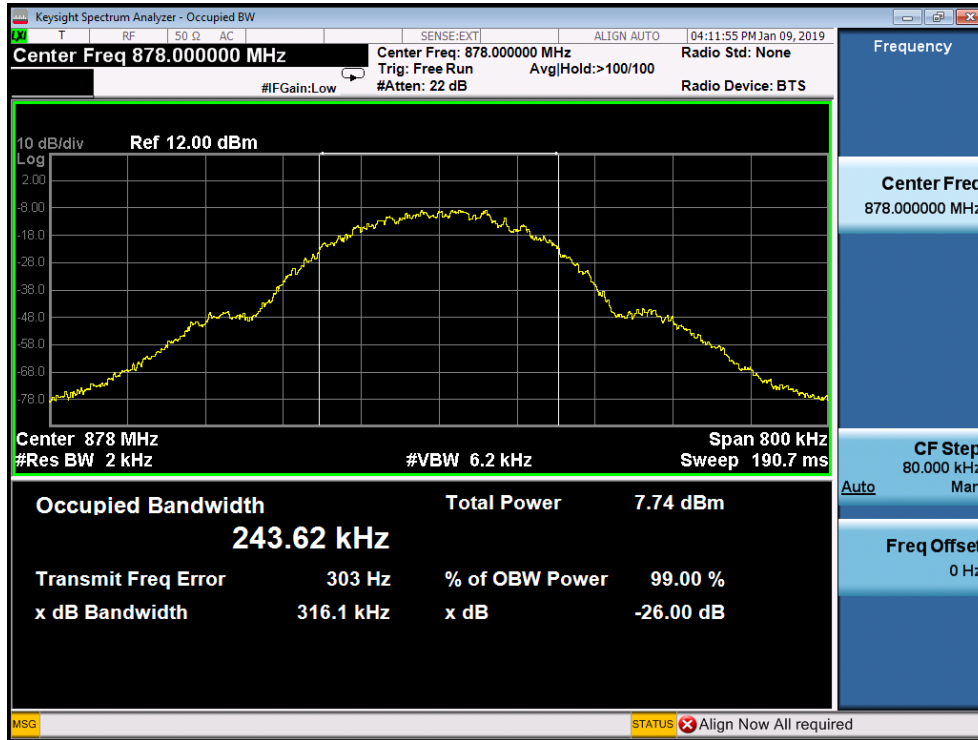

Unless otherwise agreed in writing, this document is issued by the Company subject to its General Conditions of Service printed overleaf, available on request or accessible at <http://www.sgs.com/en/Terms-and-Conditions.aspx> and, for electronic format documents, subject to Terms and Conditions for Electronic Documents at <http://www.sgs.com/en/Terms-and-Conditions/Terms-e-Documents.aspx>. Attention is drawn to the limitation of liability, indemnification and jurisdiction issues defined therein. Any holder of this document is advised that information contained hereon reflects the Company's findings at the time of its intervention only and within the limits of Client's instructions, if any. The Company's sole responsibility is to its Client and this document does not exonerate parties to a transaction from exercising all their rights and obligations under the transaction documents. This document cannot be reproduced except in full, without prior written approval of the Company. Any unauthorized alteration, forgery or falsification of the content or appearance of this document is unlawful and offenders may be prosecuted to the fullest extent of the law. Unless otherwise stated the results shown in this test report refer only to the sample(s) tested and such sample(s) are retained for 30 days only.
 Attention: To check the authenticity of testing /inspection report & certificate, please contact us at telephone: (86-755) 8307 1443, or email: CN.Doccheck@sgs.com

Output



7.1.6 Out of Band Rejection

Test Requirement: Section D.3(l) of KDB 935210 D02 Signal Booster Certification v03r2
 Test for rejection of out of band signals. Filter freq. response plots are acceptable.

Test Method: KDB 935210 D05 Indus Booster Basic Meas v01r01

EUT Operation:
 Status: Drive the EUT to maximum output power. .
 Conditions: Normal conditions
 Application: Cellular Band RF output ports

Test Configuration:

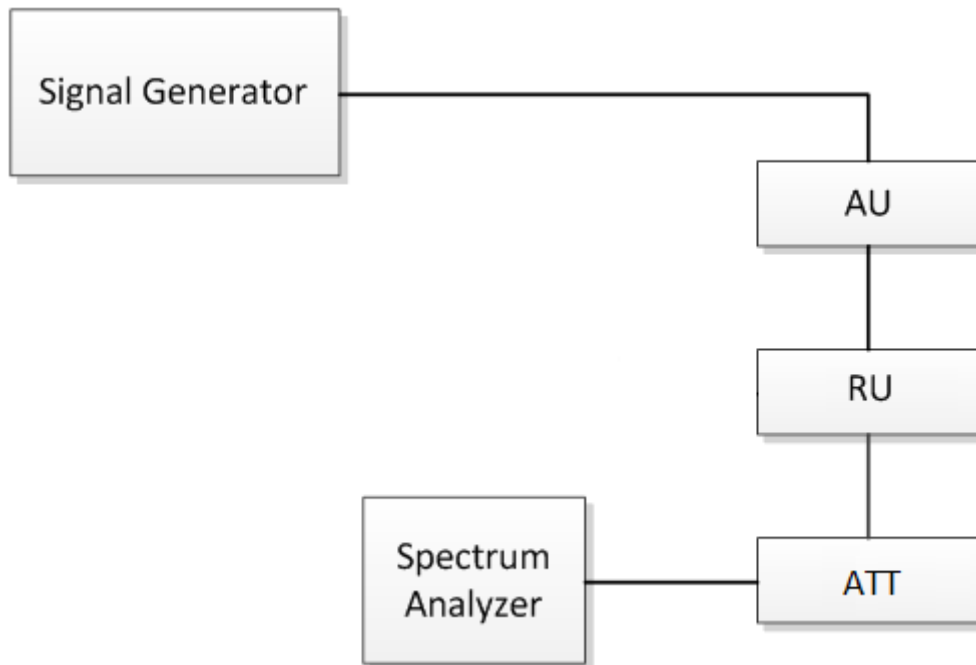

Fig.4. Out of Band rejection test configuration

Test Procedure:

- a) Connect a signal generator to the input of the EUT.
- b) Configure a swept CW signal with the following parameters:
 - 1) Frequency range = $\pm 250\%$ of the passband, for each applicable CMRS band (see also KDB Publication 935210 D02 [R7] and KDB Publication 634817 [R5] about selection of frequencies for testing and for grant listings).
 - 2) Level = a sufficient level to affirm that the out-of-band rejection is > 20 dB above the noise floor and will not engage the AGC during the entire sweep.
 - 3) Dwell time = approximately 10 ms.
 - 4) Number of points = $SPAN/(RBW/2)$.
- c) Connect a spectrum analyzer to the output of the EUT using appropriate



attenuation.

d) Set the span of the spectrum analyzer to the same as the frequency range of the signal generator.

e) Set the resolution bandwidth (RBW) of the spectrum analyzer to be 1 % to 5 % of the EUT passband, and the video bandwidth (VBW) shall be set to $\geq 3 \times$ RBW.

f) Set the detector to Peak Max-Hold and wait for the spectrum analyzer's spectral display to fill.

g) Place a marker to the peak of the frequency response and record this frequency as f_0 .

h) Place two markers, one at the lowest and the other at the highest frequency of the envelope of the spectral display, such that each marker is at or slightly below the -20 dB down amplitude, to determine the 20 dB bandwidth.

i) Capture the frequency response of the EUT.

j) Repeat for all frequency bands applicable for use by the EUT.



7.1.6.1 Measurement Record:

Downlink: 862MHz to 894MHz

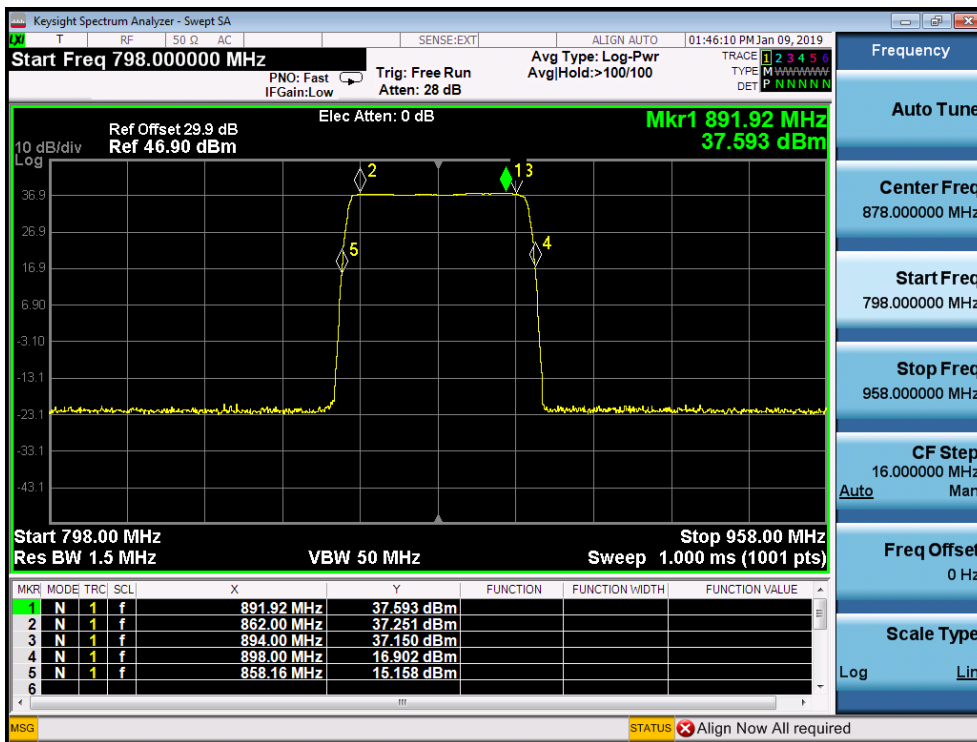

7.1.7 Frequency Stability

Test Requirement: FCC part 22.355

The frequency stability shall be sufficient to ensure that the fundamental emissions stay within the authorized bands of operation.

EUT Operation:

Status: Drive the EUT to maximum output power.

Conditions: Temperature conditions, voltage conditions

Application: Cellular Band RF output ports

Test Procedure:

1. Temperature conditions:
 - a) The RF output port of the EUT was connected to Frequency Meter;
 - b) Set the working Frequency in the middle channel;
 - c) record the 20°C and nominal voltage frequency value as reference point;
 - d) vary the temperature from -40°C to 50°C with step 10°C
 - e) when reach a temperature point, keep the temperature balance at least 1 hour to make the product working in this status;
 - f) read the frequency at the relative temperature.
2. Voltage conditions:
 - a) record the 20°C and nominal voltage frequency value as reference point;
 - b) vary the voltage from -15% nominal voltage to +15% voltage;
 - c) read the frequency at the relative voltage.





7.1.7.1 Measurement Record:

Frequency Stability vs temperature:

1. Test for Downlink: 862MHz to 894MHz (middle channel=878.0MHz)

Temperature(°C)	Frequency(MHz)	Tolerance(ppm)
50	878	0.004
40	878	0.004
30	878	0.004
20	878	0.004
10	878	0.004
0	878	0.004
-10	878	0.004
-20	878	0.004
-30	878	0.004
-40	878	0.004

Frequency Stability vs voltage:

1. Test for Downlink: 862MHz to 894MHz (middle channel=878.0MHz)

Voltage(V ac)	Frequency(MHz)	Tolerance(ppm)
102	878	0.004
120	878	0.004
138	878	0.004



8 Photographs - Test Setup

Above 1GHz Radiated Emission

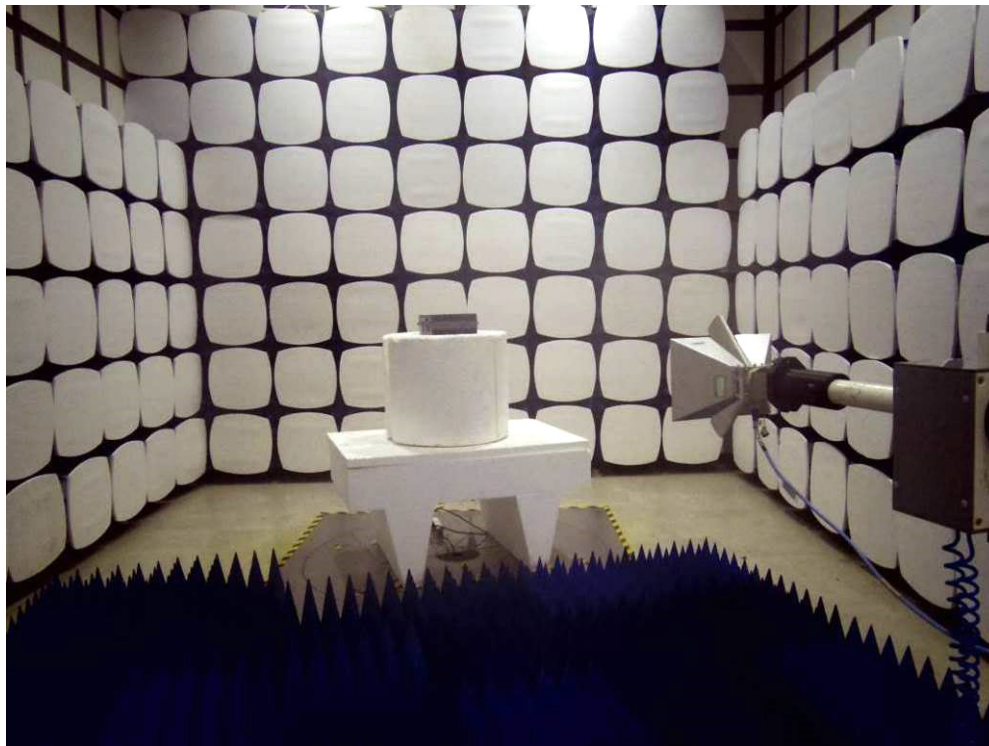

30MHz ~ 1GHz Radiated Emission

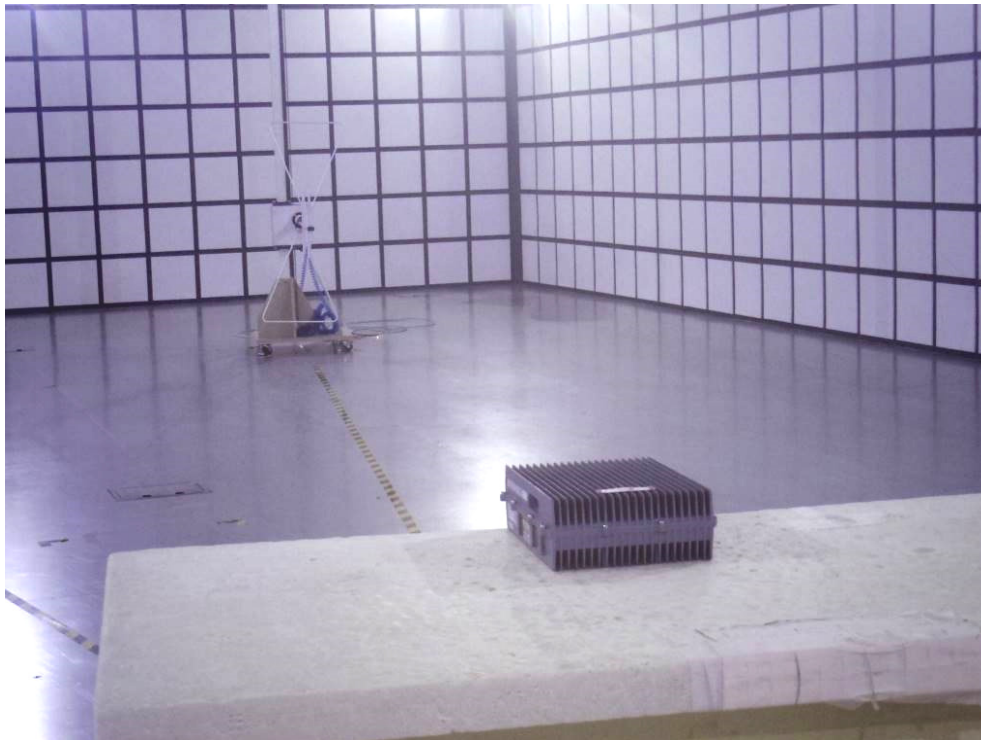

9 Photographs - EUT Constructional Details

Test Model No.: iDAS-R211







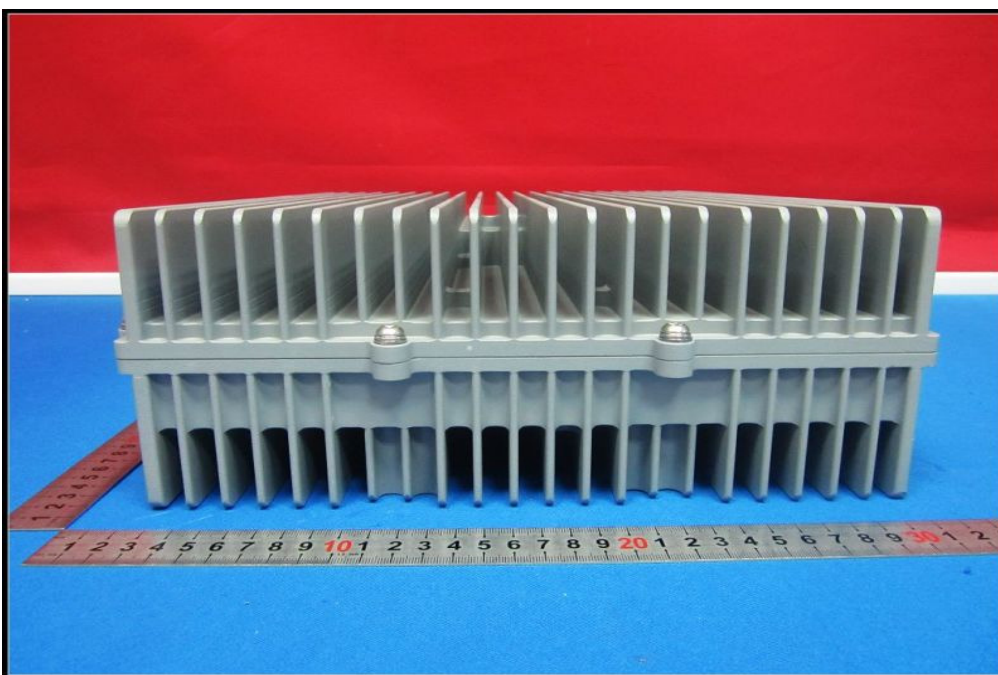
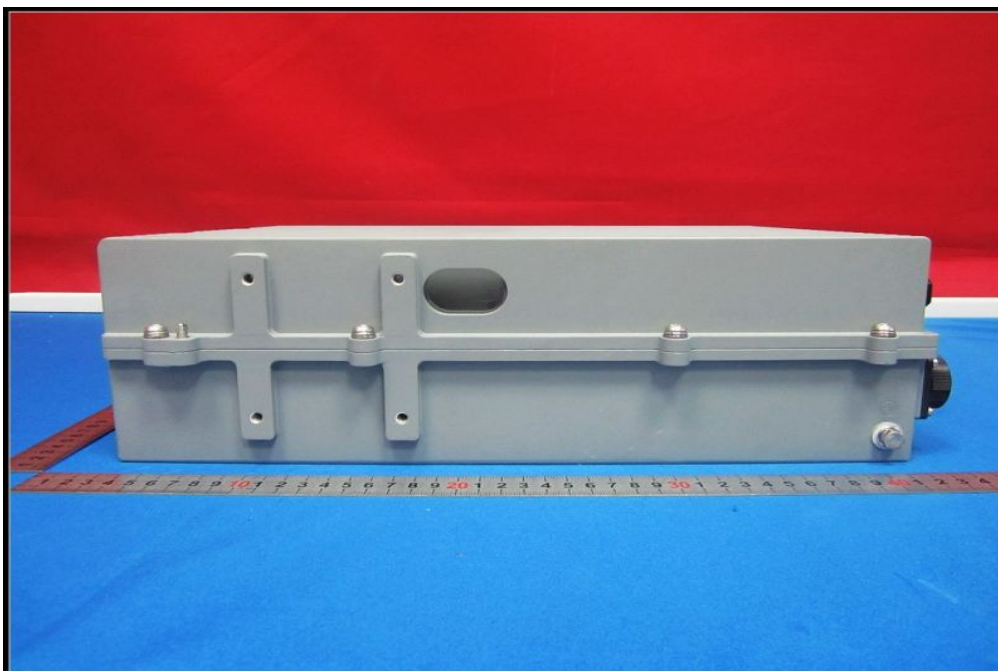

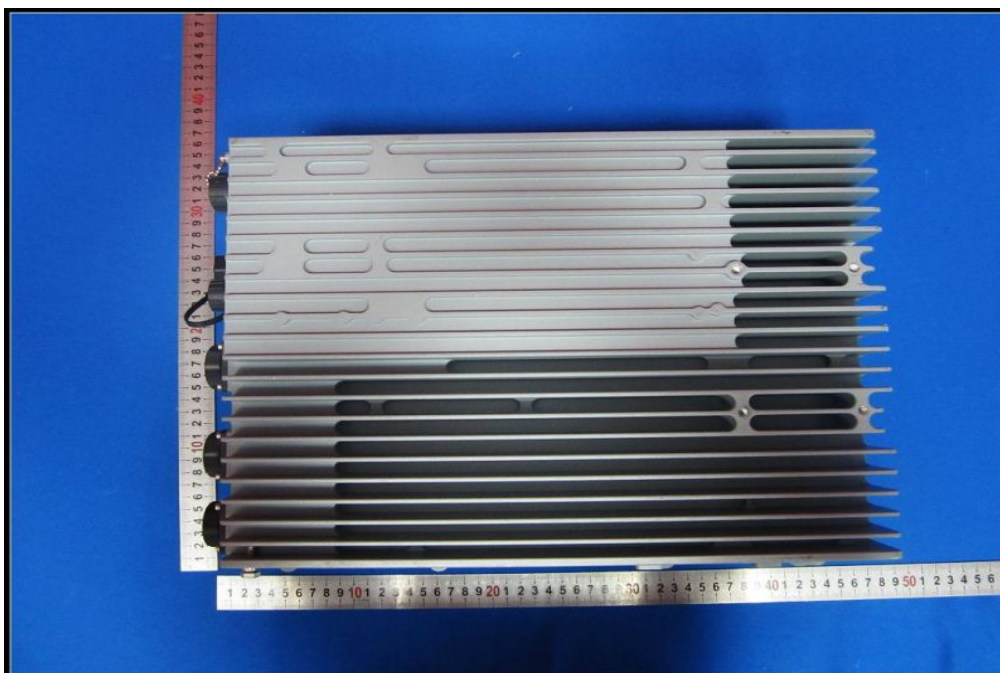
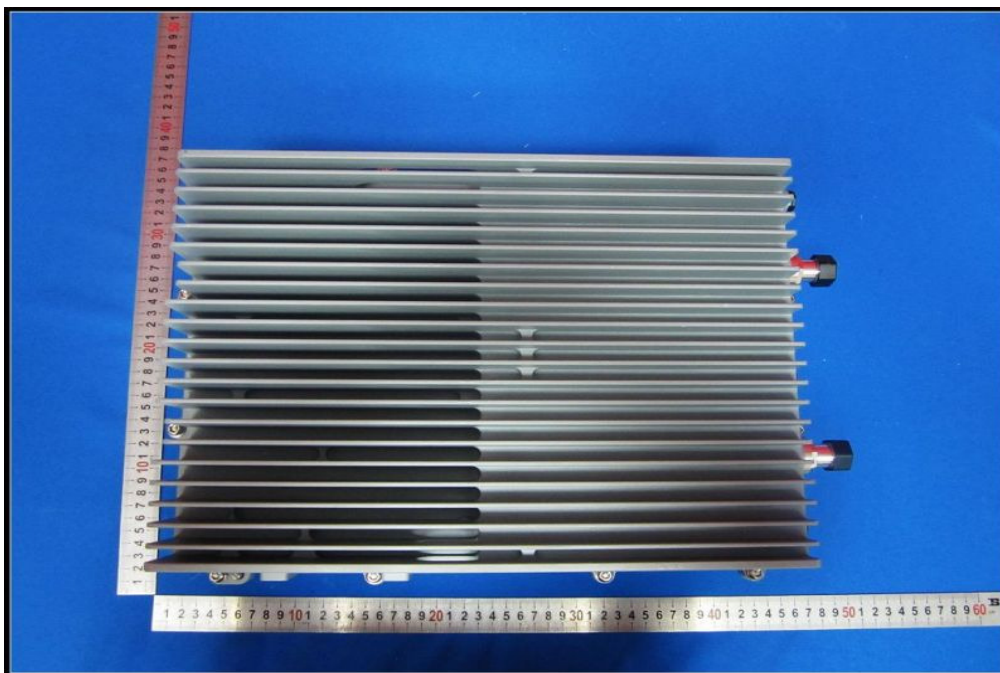

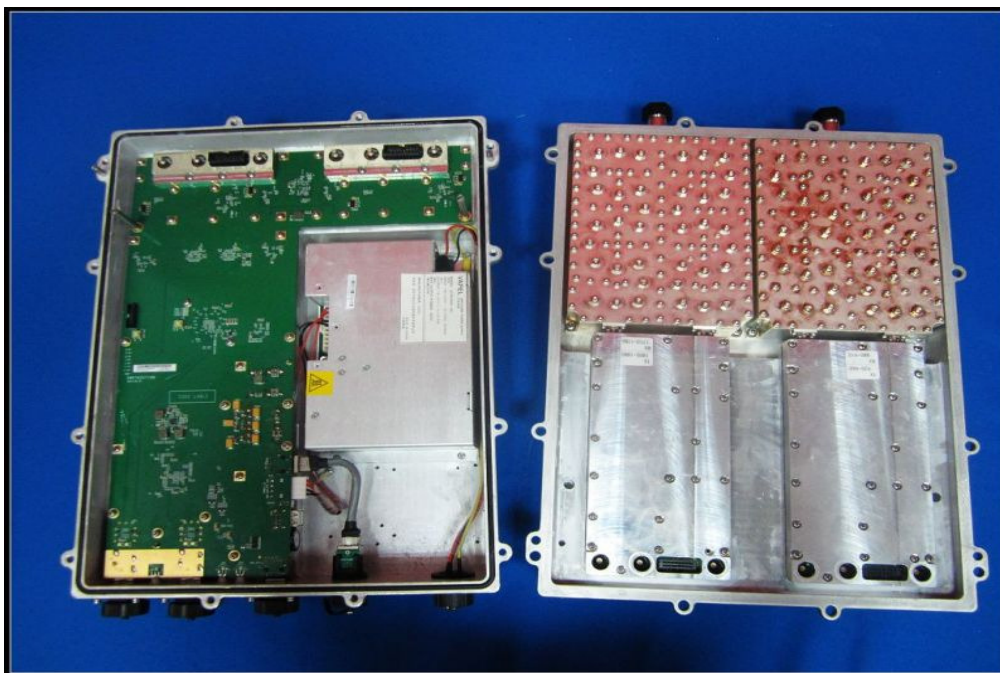

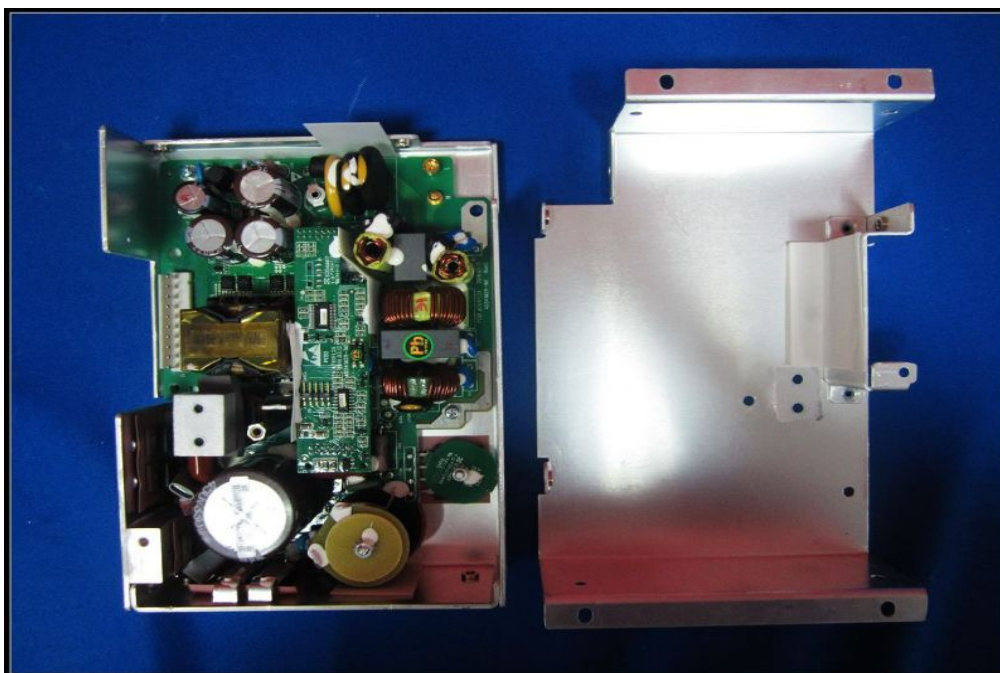
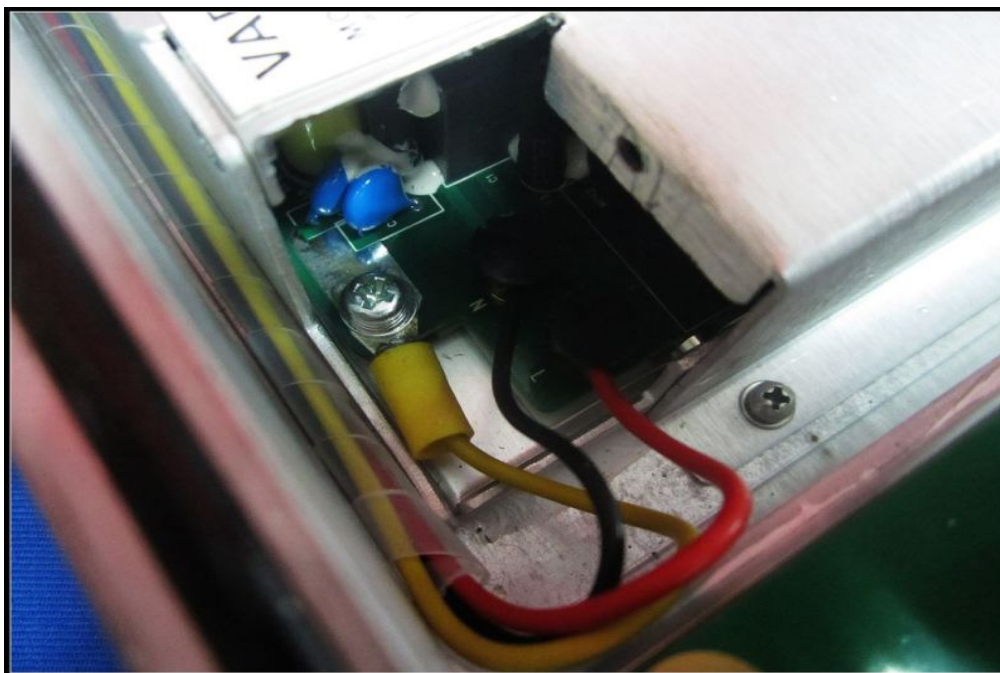

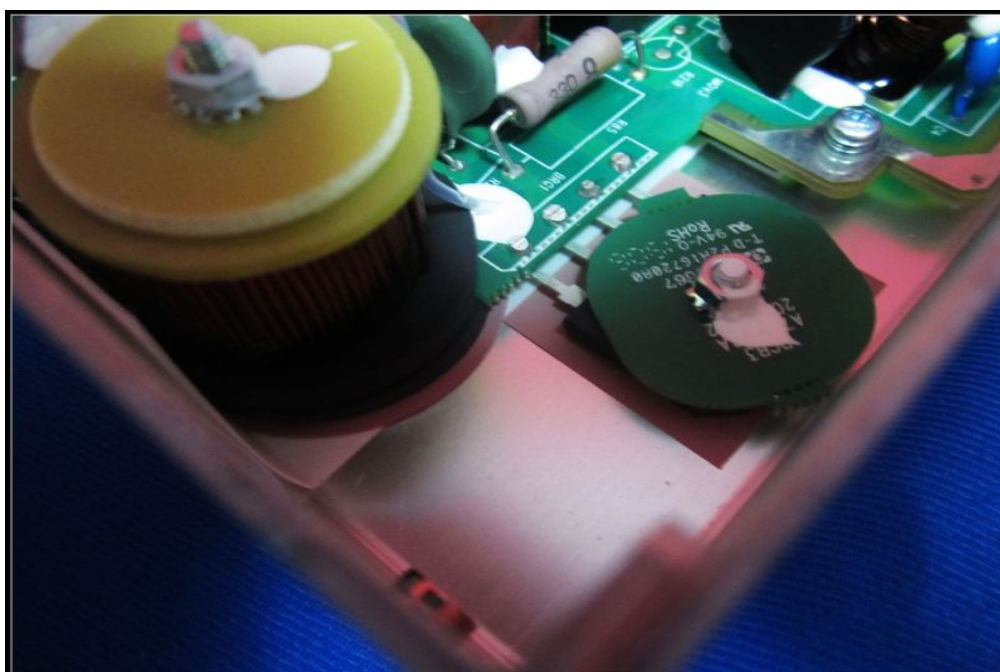
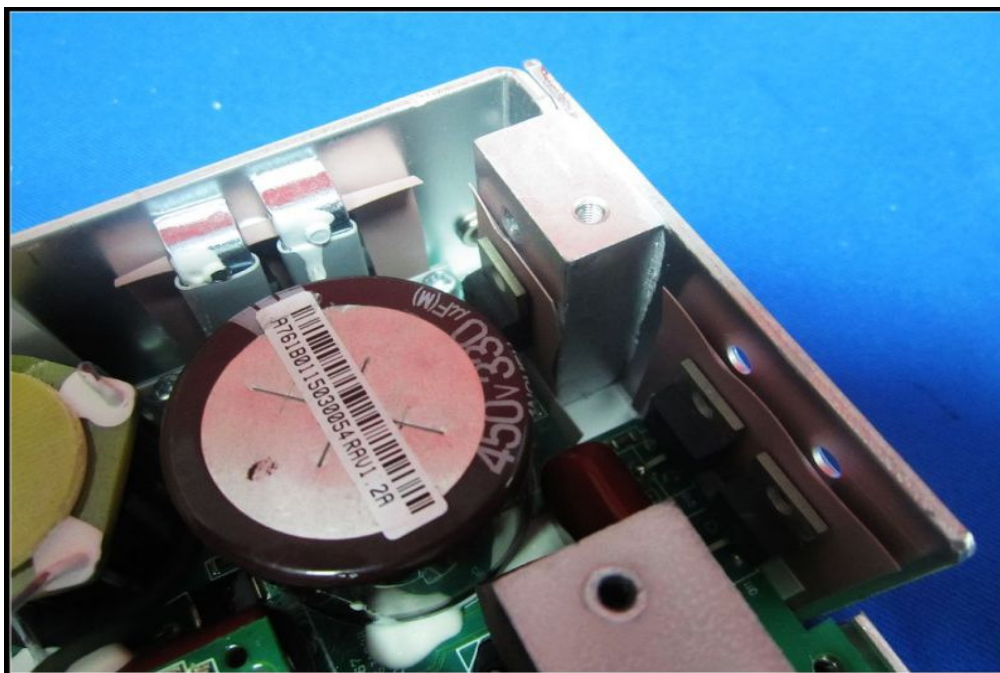

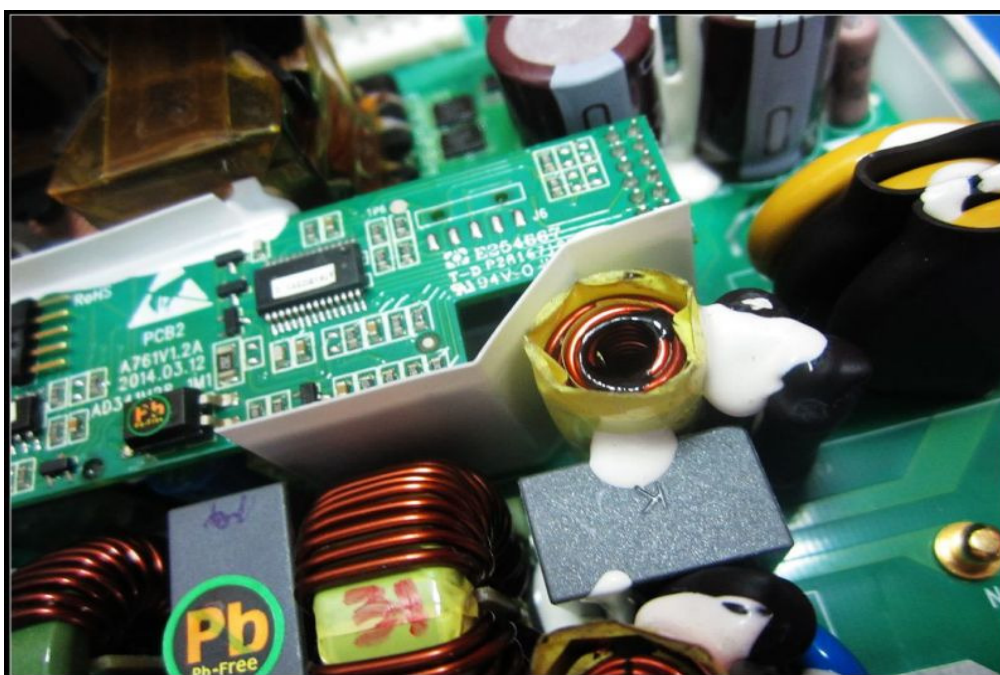
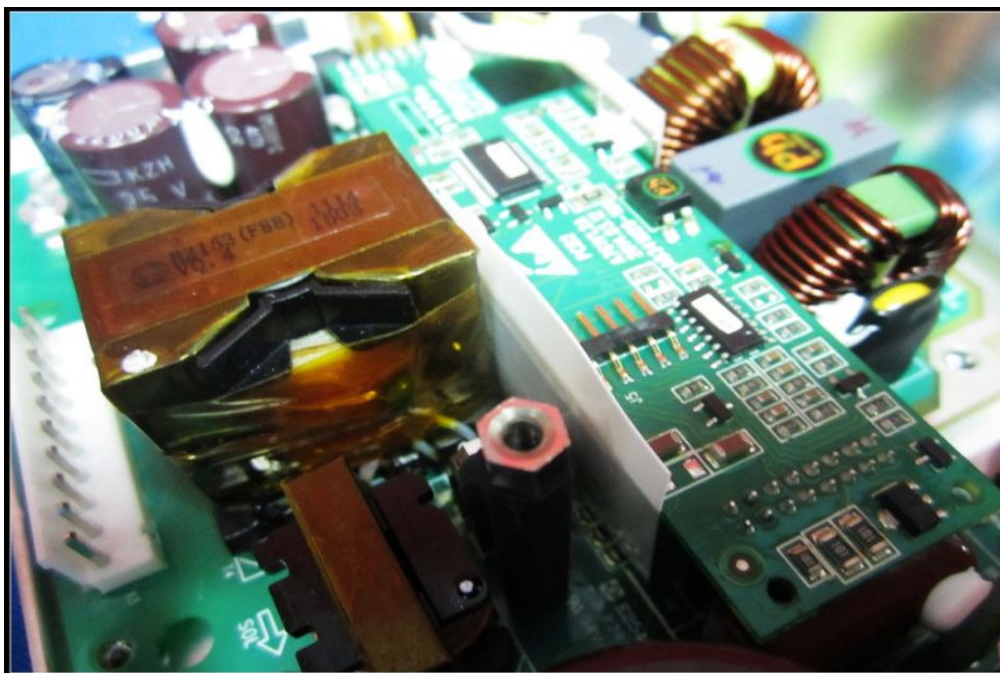

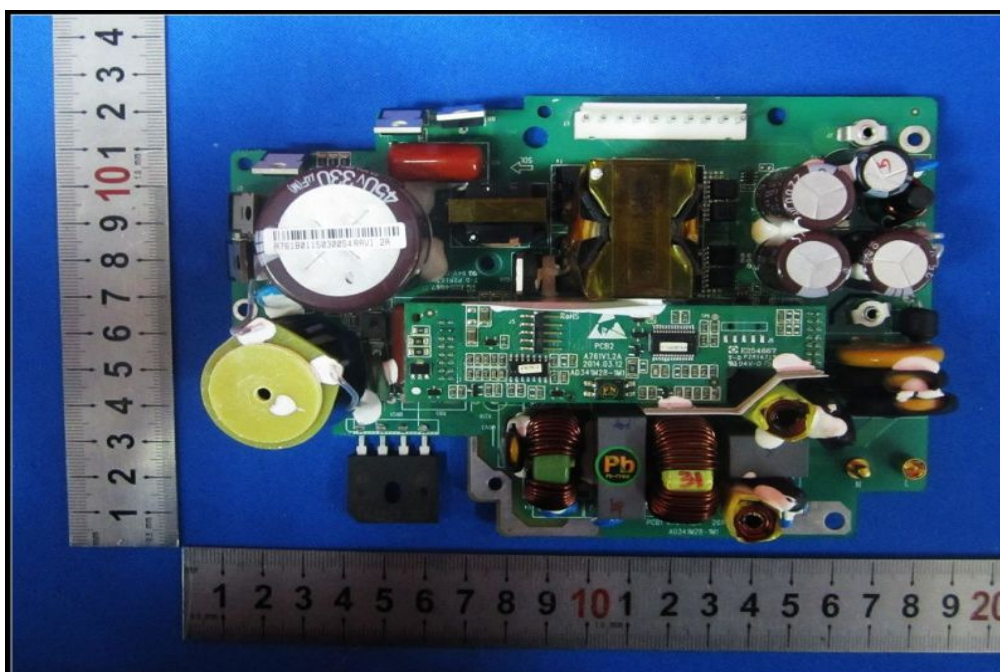
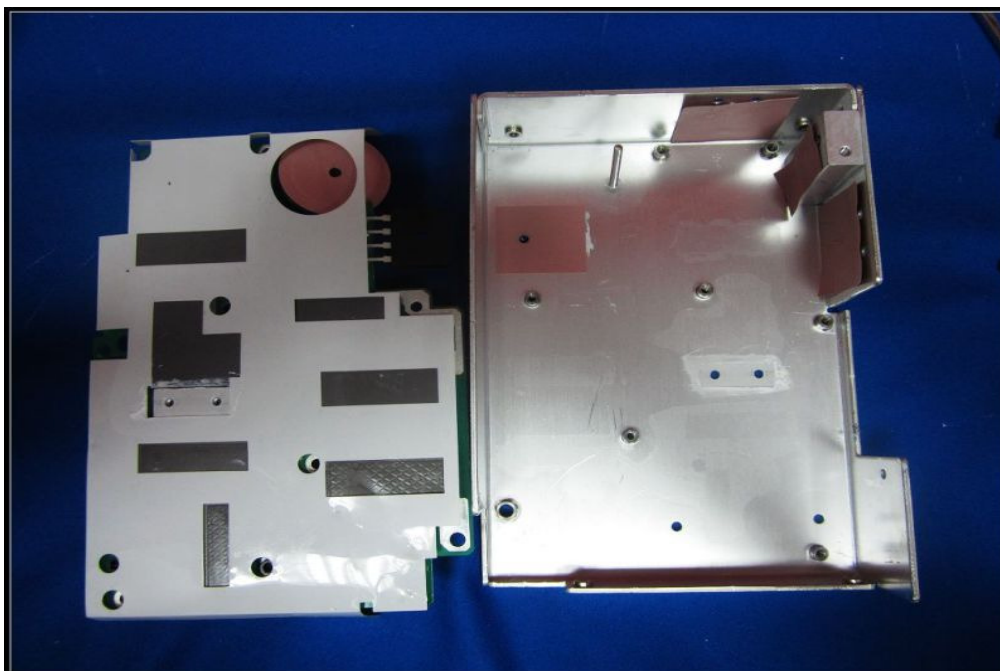

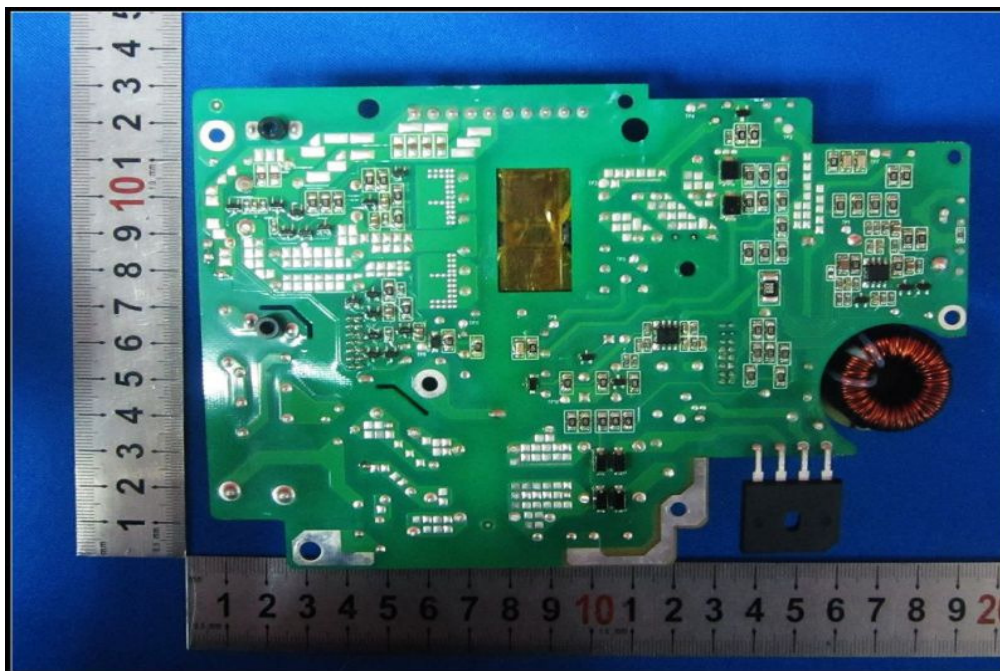

--The End of Report--

