

					AU	DWG NO.		
DRAWN BY	Heng Gao					REVISIONS	MASS	SCALE
CHECKED								1:3
APPROVED						SHEET: 1 OF 1		
					SUNWAVE COMMUNICATIONS Co., LTD.			

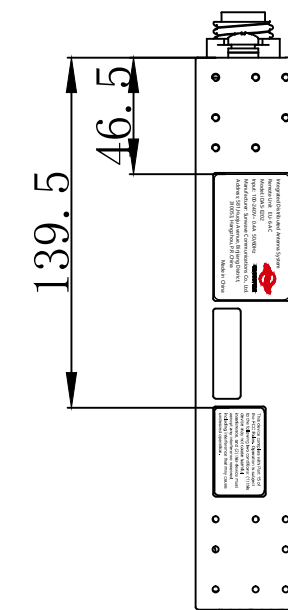

					EU	DWG NO.		
						REVISIONS	MASS	SCALE
DRAWN BY	Heng Gao							1:3
CHECKED								
APPROVED								
						SHEET: 1 OF 1		
						SUNWAVE COMMUNICATIONS Co., LTD.		

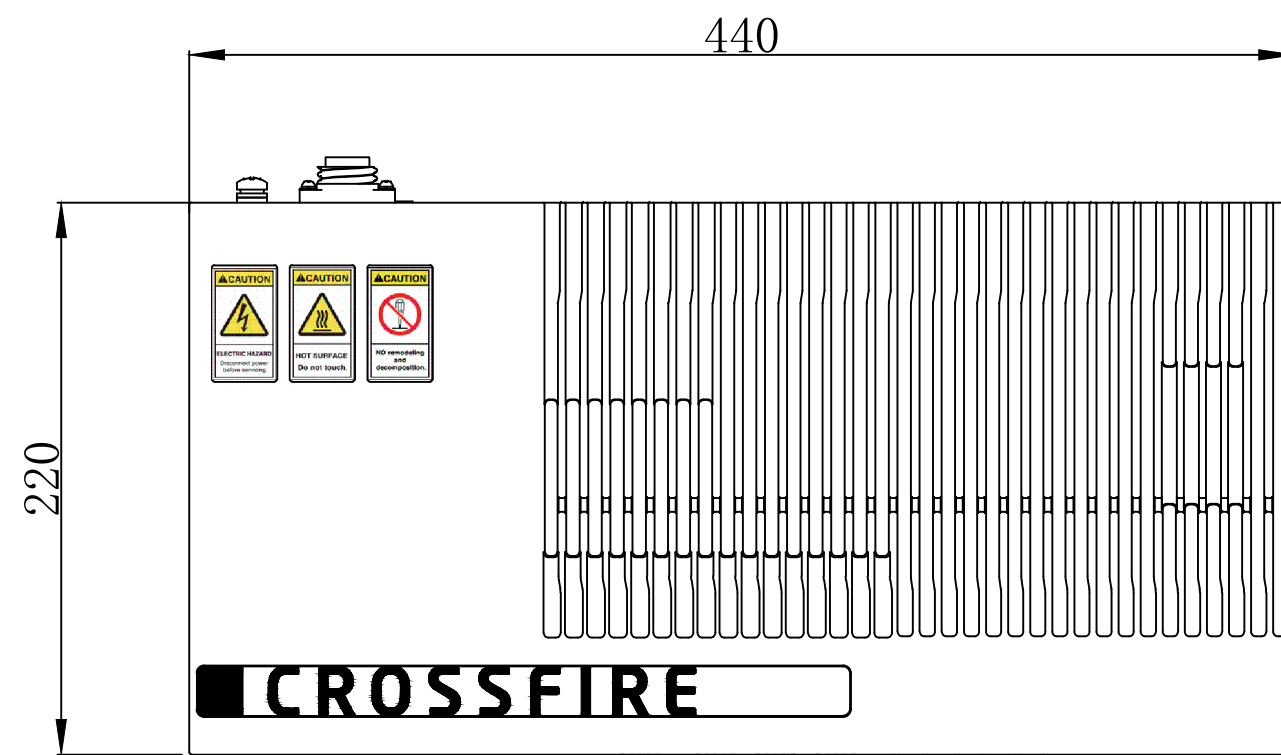
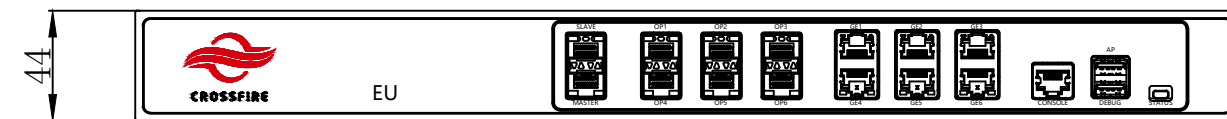
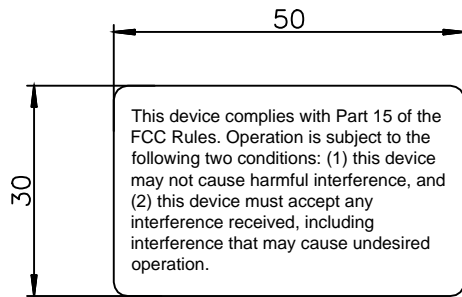
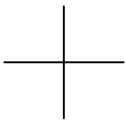
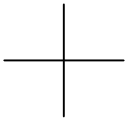

					FCC Nameplate 1	DWG NO.		
						REVISIONS	MASS	SCALE
DRAWN BY	Heng Gao							2:1
CHECKED								
APPROVED								
					SHEET:1 OF 1			
					SUNWAVE COMMUNICATIONS Co., LTD.			

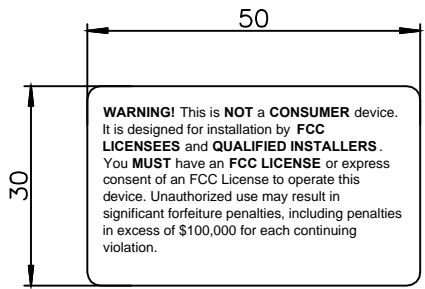
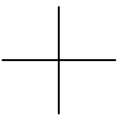
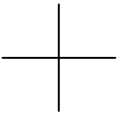

						FCC Nameplate 2	DWG NO.		
							REVISIONS	MASS	SCALE
									2:1
							SHEET:1 OF 1		
							SUNWAVE COMMUNICATIONS Co., LTD.		
DRAWN BY	Heng Gao								
CHECKED									
APPROVED									