



SGS-CSTC Standards Technical Services Ltd. Shenzhen Branch

Report No.: SZEM170600640803

Page: 36 of 75

- 1) the lowest radio frequency generated in the equipment, it can be 9KHz base the test method, here select 30MHz as lowest frequency start point;
 - 2) the highest radio frequency shall higher than 10 times of carrier frequency;
- f) Record the frequencies and levels of spurious emissions from step e)

Remark:

1)The notch filter is used for avoid the EUT fundamental carrier output power making the spectrum overload and the harmonic spurious brought by it.

When the EUT fundamental carrier is not enough to make the status, the notch filter could be not used.

2)At maximum drive level, for each modulation: two tests (high-, low-band edge) with two tones

Limit usually is -13dBm conducted.

3)Not needed for Single Channel systems.



7.2.3.1 Measurement Record:

Downlink: 2620MHz to 2690MHz (LTE Mode)

1. 5MHz bandwidth

1.1 one signal input(Level=0dBm, modulation= LTE(64QAM),Frequency1=2622.5MHz) —Lower Edge

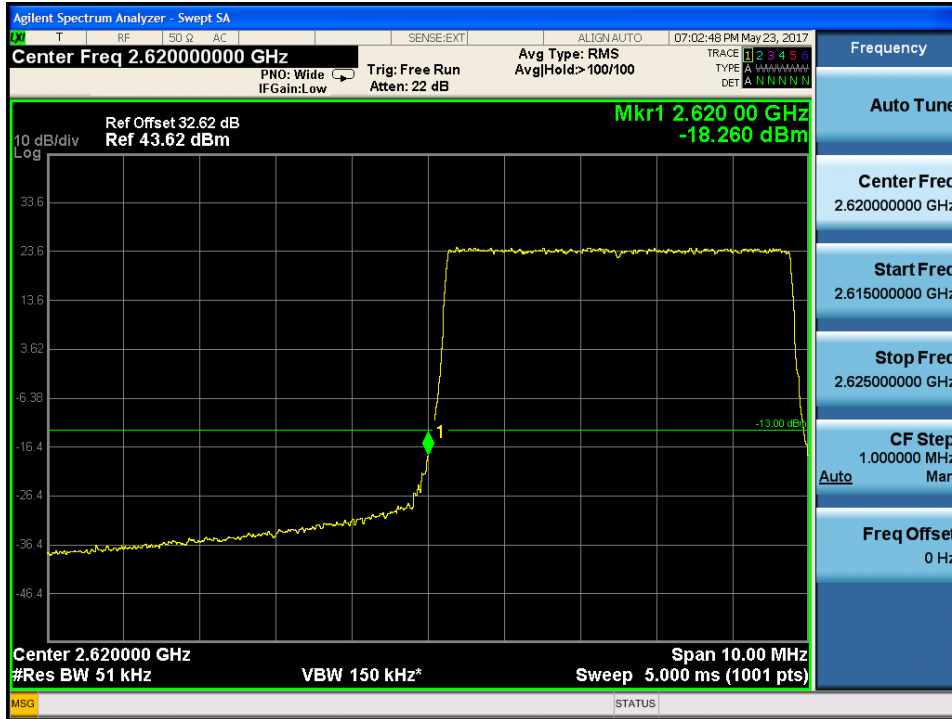

1.2 one signal input(Level=0dBm, modulation= LTE(64QAM),Frequency1=2687.5MHz) —Upper Edge





SGS-CSTC Standards Technical Services Ltd. Shenzhen Branch

Report No.: SZEM170600640803
Page: 38 of 75

1.3 two signal input(Level=0dBm, modulation= LTE(64QAM),Frequency1=2622.5MHz,
Frequency1=2627.5MHz) —Lower Edge



1.4 two signal input(Level=0dBm, modulation= LTE(64QAM),Frequency1=2687.5MHz,
Frequency1=2682.5MHz) —Upper Edge

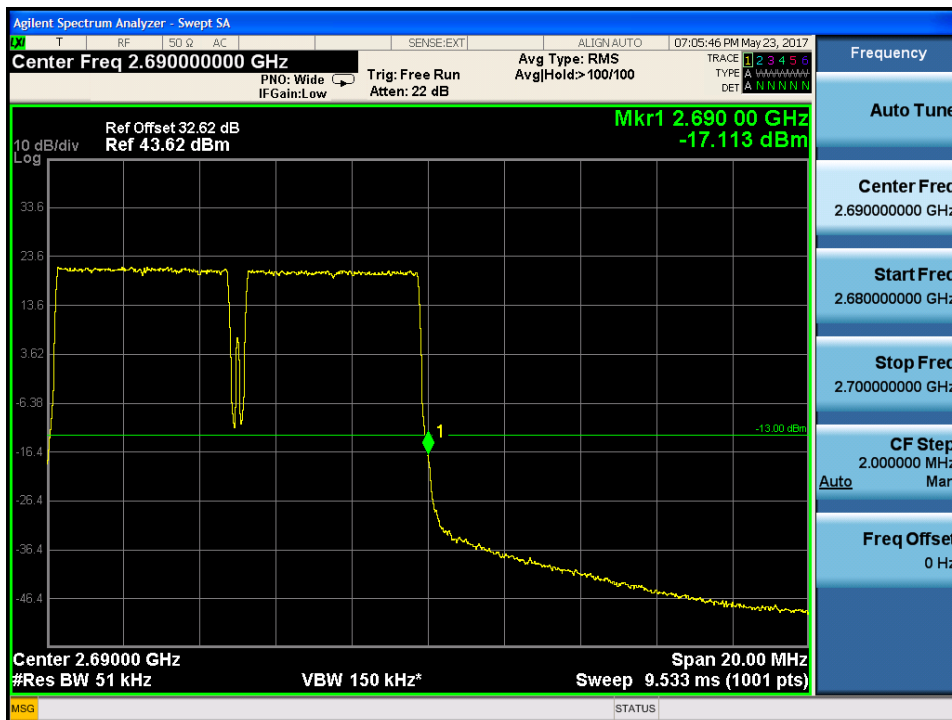



2. 20MHz bandwidth

2.1 one signal input(Level=0dBm, modulation= LTE(64QAM),Frequency1=2630MHz) —Lower Edge

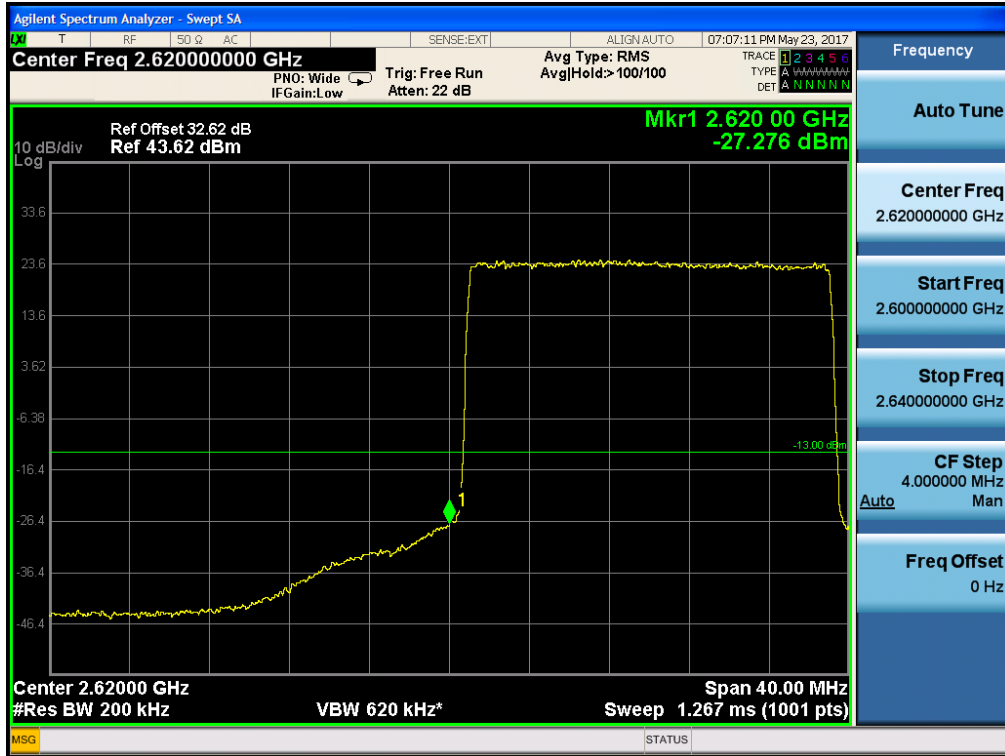

2.2 one signal input (Level=0dBm, modulation= LTE(64QAM),Frequency1=2680MHz)—Upper Edge





SGS-CSTC Standards Technical Services Ltd. Shenzhen Branch

Report No.: SZEM170600640803
Page: 40 of 75

2.3 Two signal input(Level=0dBm, modulation= LTE(64QAM),Frequency1=2630MHz, Frequency1=2650MHz)
—Lower Edge

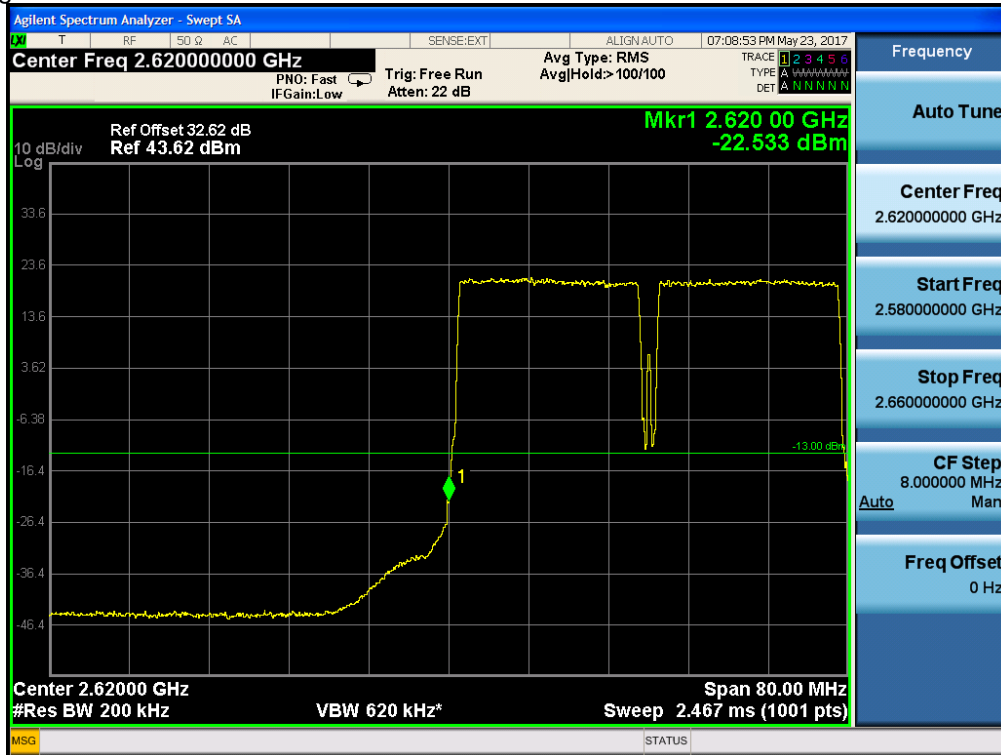

2.4 Two signal input(Level=0dBm, modulation= LTE(64QAM),Frequency1=2660MHz, Frequency1=2680MHz)
—Lower Edge

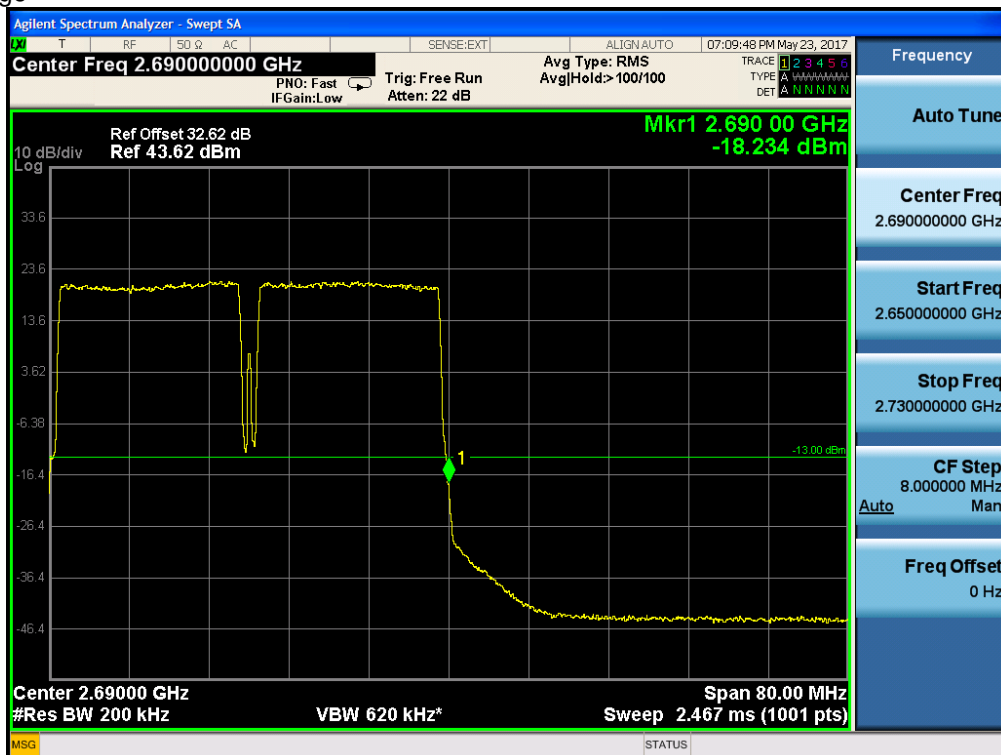



Downlink: 2620MHz to 2690MHz (WCDMA Mode)

1. one signal input(Level=0dBm, modulation=WCDMA, Frequency=2622.4MHz) —Lower Edge

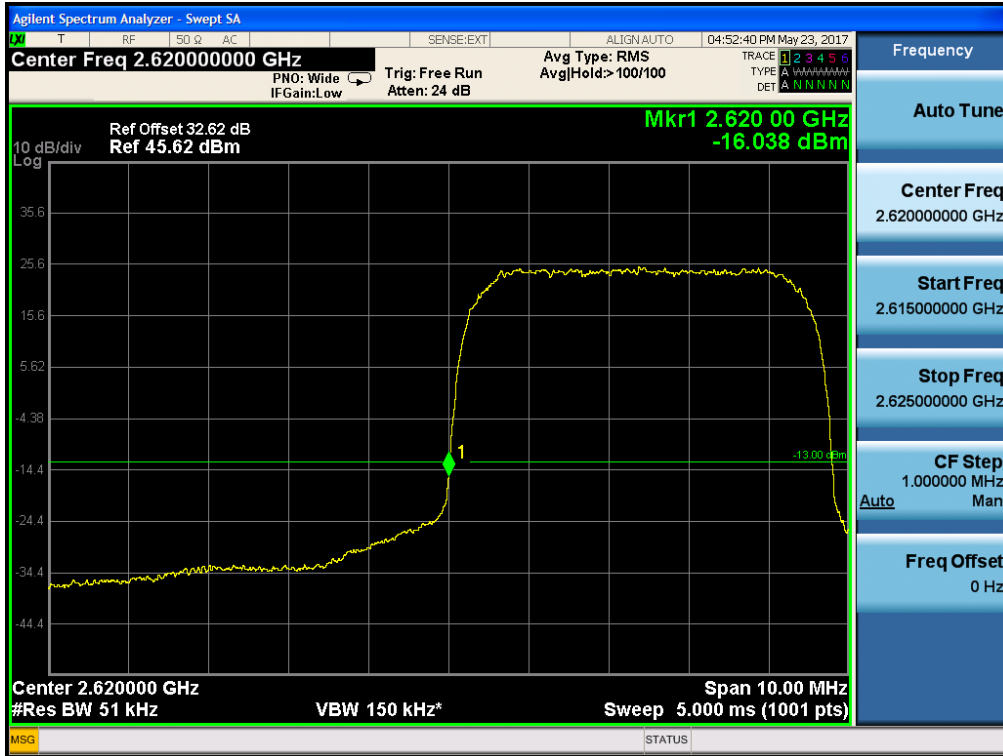

2. One signal input(Level=0dBm, modulation=WCDMA, Frequency=2687.6MHz) —Upper Edge





SGS-CSTC Standards Technical Services Ltd. Shenzhen Branch

Report No.: SZEM170600640803

Page: 42 of 75

3. Two signal input(Level=0dBm, modulation=WCDMA,Frequency1=2622.4MHz, Frequency2=2627.4MHz)
—Lower Edge

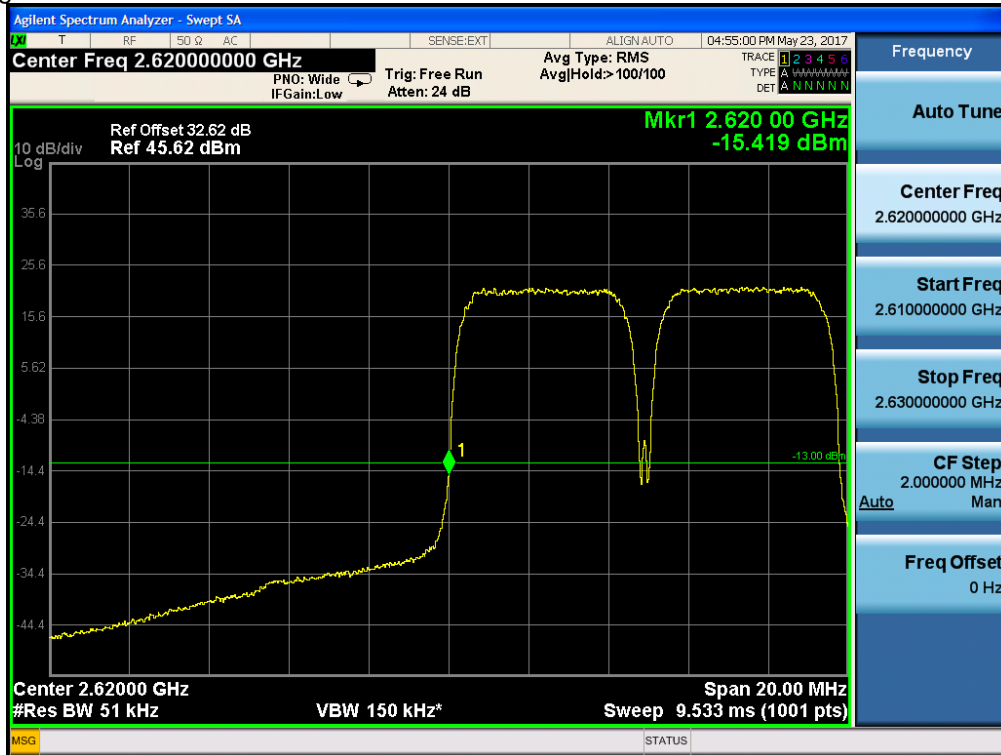

4. Two signal input(Level=0dBm, modulation=WCDMA,Frequency1=2687.6MHz, Frequency2=2682.6MHz)
—Upper Edge

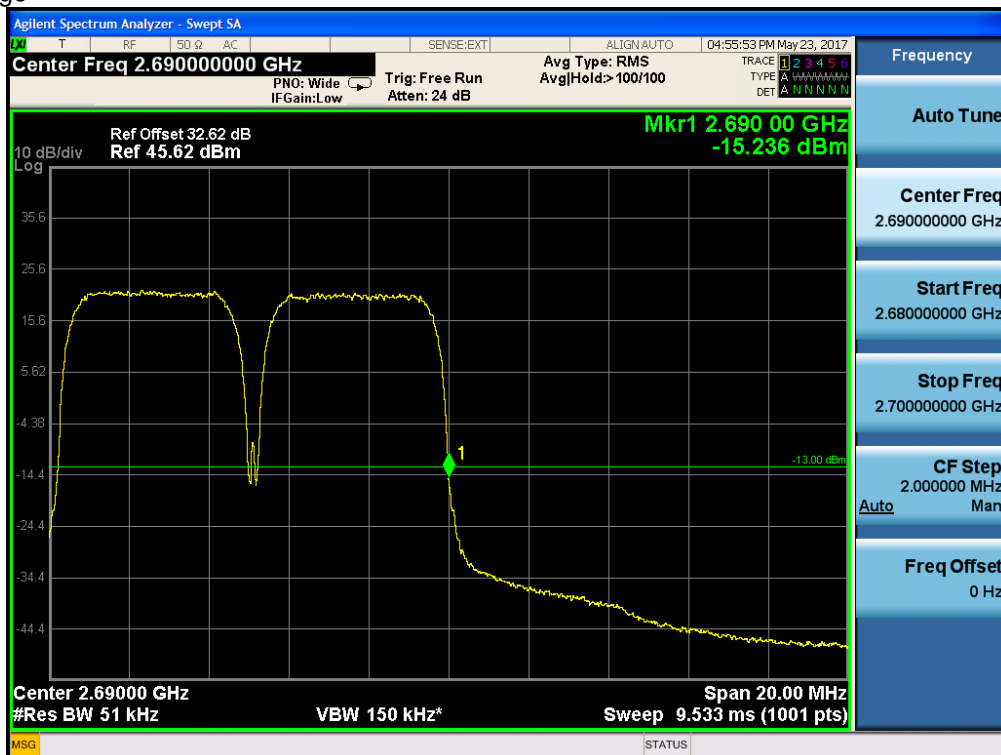

7.2.4 Radiated Spurious Emissions

Test Requirement: & FCC part 27.53(h) The limit is = -13 dBm.
 Test Method: KDB 935210 D05 Indus Booster Basic Meas v01r01
 EUT Operation:
 Status: Drive the EUT to maximum output power.
 Conditions: Normal conditions
 Application: Enclosure
 Test Configuration:

30MHz to 1GHz emissions:

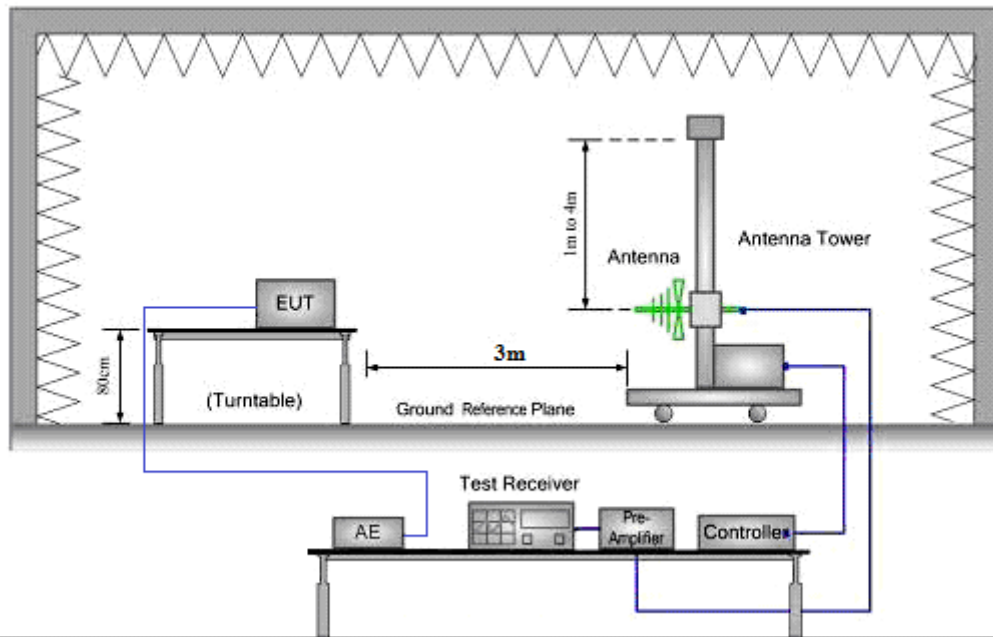

1GHz to 40GHz emissions:

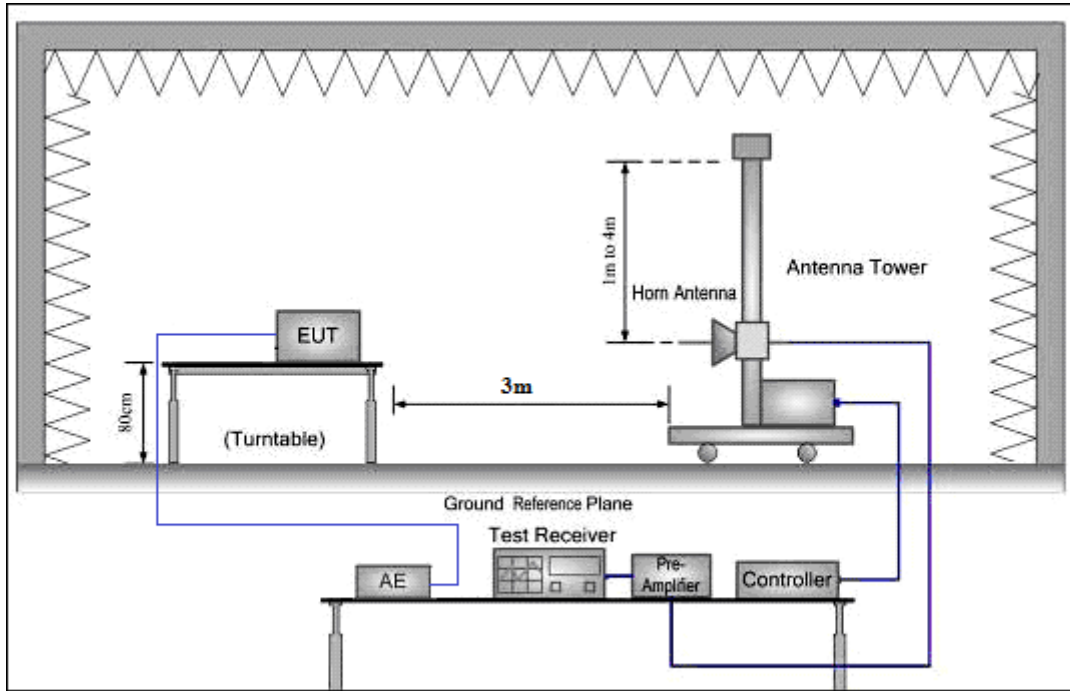

Test Procedure:

1. Test the background noise level with all the test facilities;
2. Keep one transmitting path, all other connectors shall be connected by normal power or RF leads;
3. Select the suitable RF notch filter to avoid the test receiver or spectrum analyzer produce unwanted spurious emissions;
4. Keep the EUT continuously transmitting in max power;
5. Read the radiated emissions of the EUT enclosure.

Radiated Emissions Test Procedure:

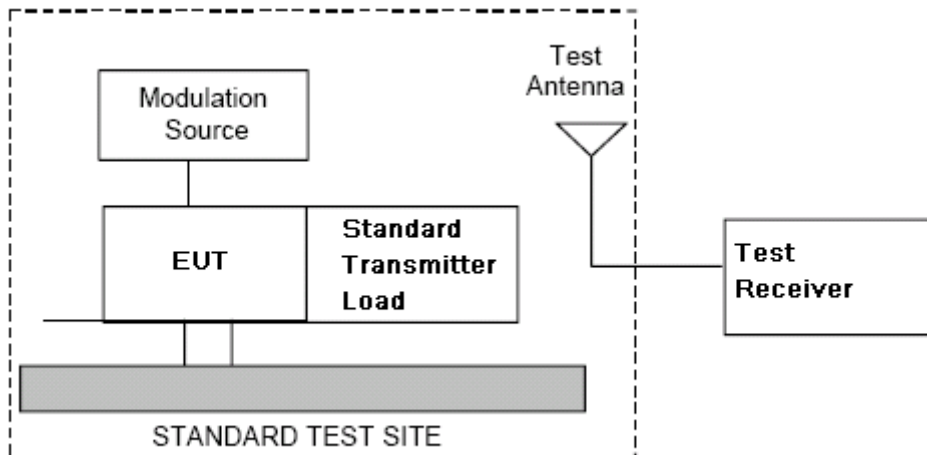

- a) Connect the equipment as illustrated.
- b) Adjust the spectrum analyzer for the following settings:
 - 1) Resolution Bandwidth = 100 kHz for spurious emissions below 1 GHz, and 1 MHz for spurious emissions above 1GHz.
 - 2) Video Bandwidth = 300 kHz for spurious emissions below 1 GHz, and 3 MHz for spurious emissions above 1 GHz.
 - 3) Sweep Speed slow enough to maintain measurement calibration.
 - 4) Detector Mode = Positive Peak.
- c) Place the transmitter to be tested on the turntable in the standard test site, The transmitter is transmitting into a no radiating load that is placed on the turntable. The RF cable to this load should be of minimum length.
- d) Measurements shall be made from 30MHz to 10 times of fundamental carrier, except for the region close to the carrier equal to \pm the carrier bandwidth.
- e) Key the transmitter without modulation or normal modulation base the standard.
- f) For each spurious frequency, raise and lower the test antenna from 1 m to 4 m to obtain a maximum reading on the spectrum analyzer with the test antenna at horizontal polarity. Then the turntable should be rotated 360° to determine the maximum reading. Repeat this procedure to obtain the highest possible reading. Record this maximum reading.
- g) Repeat step f) for each spurious frequency with the test antenna polarized vertically.

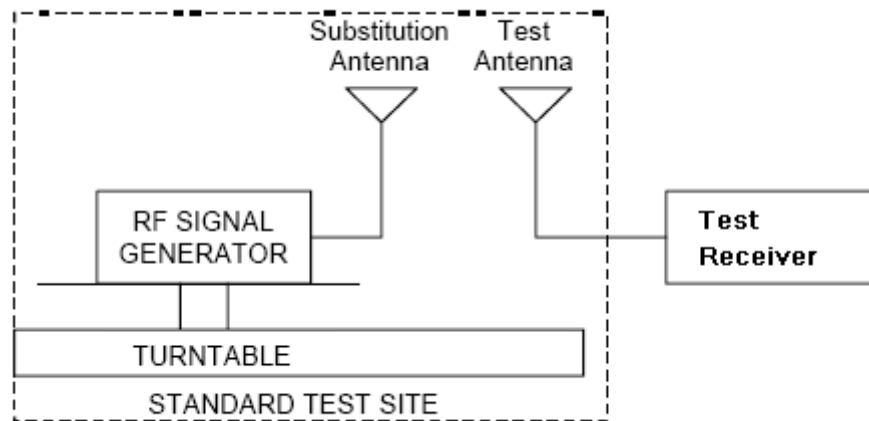



- h) Reconnect the equipment as illustrated.
- i) Keep the spectrum analyzer adjusted as in step b).
- j) Remove the transmitter and replace it with a substitution antenna (the antenna should be half-wavelength for each frequency involved). The center of the substitution antenna should be approximately at the same location as the center of the transmitter. At the lower frequencies, where the substitution antenna is very long, this will be impossible to achieve when the antenna is polarized vertically. In such case the lower end of the antenna should be 0.3 m above the ground.
- k) Feed the substitution antenna at the transmitter end with a signal generator connected to the antenna by means of a non-radiating cable. With the antennas at both ends horizontally polarized, and with the signal generator tuned to a particular spurious frequency, raise and lower the test antenna to obtain a maximum reading at the spectrum analyzer. Adjust the level of the signal generator output until the previously recorded maximum reading for this set of conditions is obtained. This should be done carefully repeating the adjustment of the test antenna and generator output.
- l) Repeat step k) with both antennas vertically polarized for each spurious frequency.
- m) Calculate power in dBm into a reference ideal half-wave dipole antenna by reducing the readings obtained in steps k) and l) by the power loss in the cable between the generator and the antenna, and further corrected for the gain of the substitution antenna used relative to an ideal half-wave dipole antenna by the following formula:

$$Pd(\text{dBm}) = Pg(\text{dBm}) - \text{cable loss (dB)} + \text{antenna gain (dB)}$$

where:

Pd is the dipole equivalent power and

Pg is the generator output power into the substitution antenna.

NOTE:

- 1) It is permissible to use other antennas provided they can be referenced to a dipole.
- 2) For below 1GHz signal, the *antenna gain* (dB) is dBd, and for above 1GHz signal, the *antenna gain* (dB) is dBi.
- 3) Effective radiated power (e.r.p) refers to the radiation of a half wave tuned dipole instead of an isotropic antenna. There is a constant difference of 2.15 dB between e.i.r.p. and e.r.p.
$$\text{e.r.p (dBm)} = \text{e.i.r.p. (dBm)} - 2.15$$
- 4) For this test, the AU and EU are put outside of the chamber, connect to the RU through the optical fiber



7.2.4.1 Measurement Record:

No emissions were detected within 20dB below the limit for the Downlink direction.

Downlink: 2620MHz to 2690MHz

Lowest channel					
Frequency	Spurious Emission Level			Limit	Over limit
(MHz)	(Deg)	Polaxis	(dBm)	dBm	(dB)
63.60	93.0	H	-77.59	-13.0	-64.59
177.00	93.0	H	-72.06	-13.0	-59.06
642.50	346.0	H	-85.25	-13.0	-72.25
1650.00	257.0	H	-65.14	-13.0	-52.14
3975.00	0.0	H	-68.39	-13.0	-55.39
7875.00	0.0	H	-64.99	-13.0	-51.99

Lowest channel					
Frequency	Spurious Emission Level			Limit	Over limit
(MHz)	(Deg)	Polaxis	(dBm)	dBm	(dB)
72.000000	37.0	V	-81.46	-13.0	-68.46
177.000000	64.0	V	-82.21	-13.0	-69.21
593.000000	0.0	V	-86.02	-13.0	-73.02
1551.000000	0.0	V	-66.32	-13.0	-53.32
3682.500000	0.0	V	-68.92	-13.0	-55.92
6412.500000	0.0	V	-66.55	-13.0	-53.55



**SGS-CSTC Standards Technical Services Ltd.
Shenzhen Branch**

Report No.: SZEM170600640803

Page: 48 of 75

Middle channel					
Frequency	Spurious Emission Level			Limit	Over limit
(MHz)	(Deg)	Polaxis	(dBm)	dBm	(dB)
109.80	199.0	H	-79.17	-13.0	-66.17
265.20	305.0	H	-79.31	-13.0	-66.31
1166.00	84.0	H	-67.88	-13.0	-54.88
2200.00	0.0	H	-59.24	-13.0	-46.24
6120.00	247.0	H	-66.23	-13.0	-53.23
9142.50	0.0	H	-64.46	-13.0	-51.46

Middle channel					
Frequency	Spurious Emission Level			Limit	Over limit
(MHz)	(Deg)	Polaxis	(dBm)	dBm	(dB)
109.800000	172.0	V	-80.56	-13.0	-67.56
265.200000	305.0	V	-84.40	-13.0	-71.40
1199.000000	41.0	V	-66.18	-13.0	-53.18
2200.000000	0.0	V	-58.93	-13.0	-45.93
4950.000000	0.0	V	-65.97	-13.0	-52.97
7972.500000	0.0	V	-64.61	-13.0	-51.61



**SGS-CSTC Standards Technical Services Ltd.
Shenzhen Branch**

Report No.: SZEM170600640803

Page: 49 of 75

Highest channel					
Frequency	Spurious Emission Level			Limit	Over limit
(MHz)	(Deg)	Polaxis	(dBm)	dBm	(dB)
177.00	93.0	H	-72.06	-13.0	-59.06
265.20	305.0	H	-79.31	-13.0	-66.31
1650.00	257.0	H	-65.14	-13.0	-52.14
2200.00	0.0	H	-59.24	-13.0	-46.24
7875.00	0.0	H	-64.99	-13.0	-51.99
9142.50	0.0	H	-64.46	-13.0	-51.46

Highest channel					
Frequency	Spurious Emission Level			Limit	Over limit
(MHz)	(Deg)	Polaxis	(dBm)	dBm	(dB)
177.000000	64.0	V	-82.21	-13.0	-69.21
265.200000	305.0	V	-84.40	-13.0	-71.40
1551.000000	0.0	V	-66.32	-13.0	-53.32
2200.000000	0.0	V	-58.93	-13.0	-45.93
6412.500000	0.0	V	-66.55	-13.0	-53.55
7972.500000	0.0	V	-64.61	-13.0	-51.61

Remark:

The cabinet radiation was measured with the equipment transmitting a CW signal into a non-radiating 50 Ohm load at maximum output power on a signal frequency.

Measured were performed in the lowest, middle and highest frequency for the Downlink.

The spectrum was searched from 30MHz to 27GHz (10th Harmonic) for downlink.

7.2.5 Occupied Bandwidth

Test Requirement:	FCC part 2.1049 The spectral shape of the output should look similar to input for all modulations.
EUT Operation:	
Status:	Drive the EUT to maximum output power. .
Conditions:	Normal conditions
Application:	Cellular Band RF output ports
Test Configuration:	

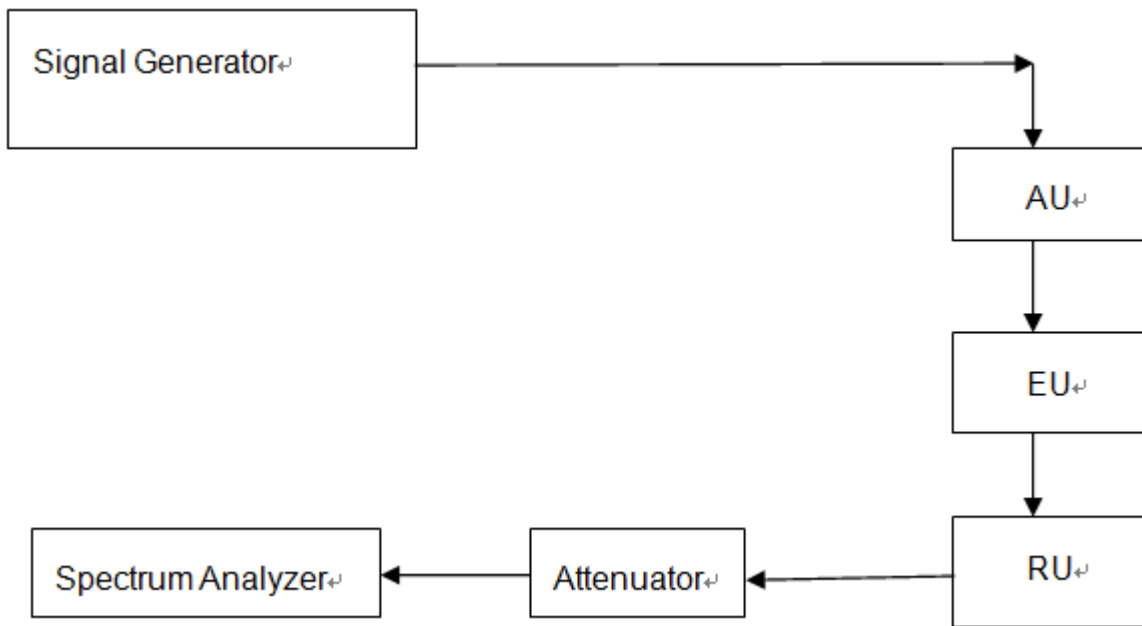

Fig.2. Conducted Spurious Emissions test configuration

Test Procedure:	<ol style="list-style-type: none"> a) Set the spectrum analyzer RBW 300 Hz or >1%&<2% emission bandwidth of carrier. b) Capture the trace of input signal; c) Connect the equipment as illustrated; d) Capture the trace of output signal; e) The signal add at the signal generator is 0dBm, and the modulation of the signal is 64QAM
-----------------	--



7.2.5.1 Measurement Record:

1. Downlink: 2620MHz to 2690MHz(LTE mode)

1.1 lowest frequency – 5MHz bandwidth

Input:

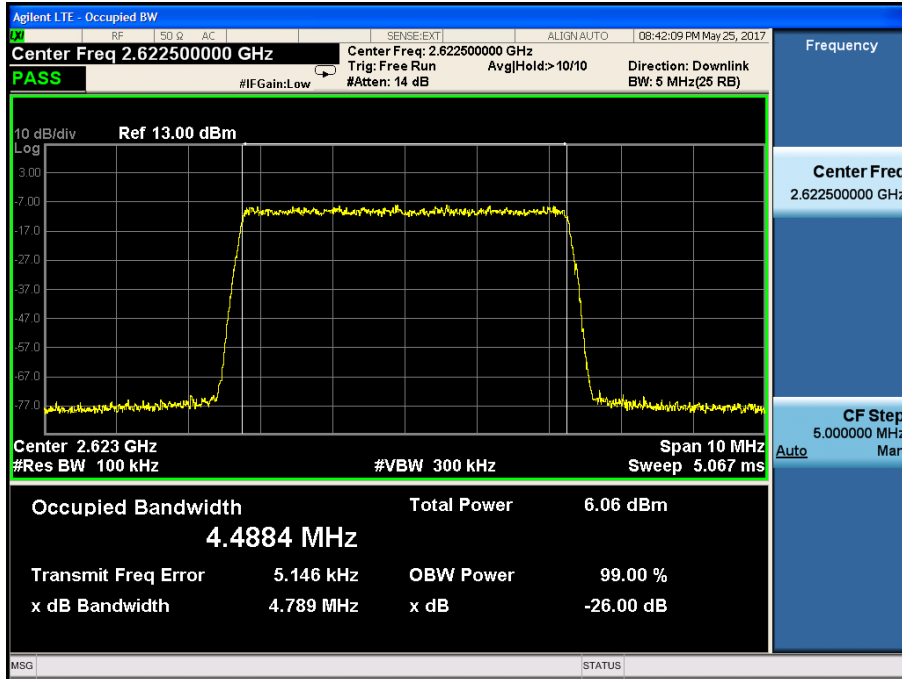

Output:

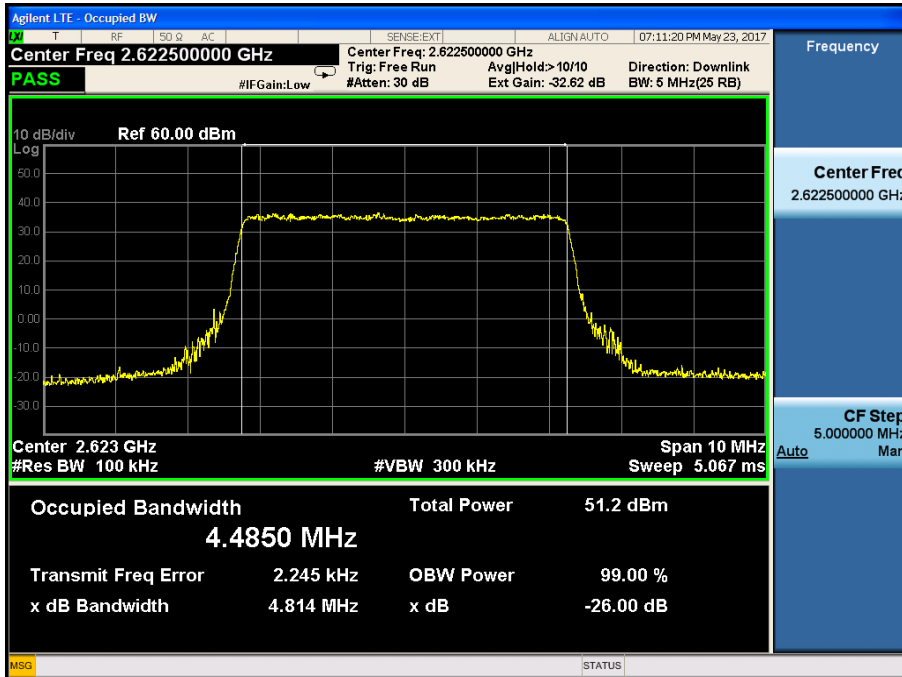



1.2 lowest frequency-- 20MHz bandwidth

Input:

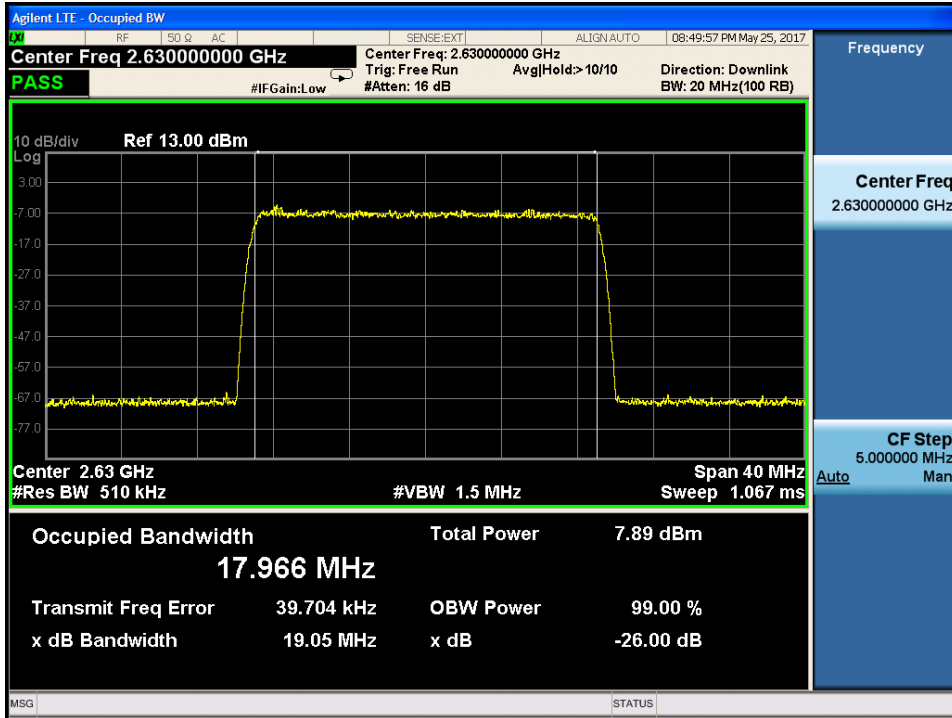

Output:

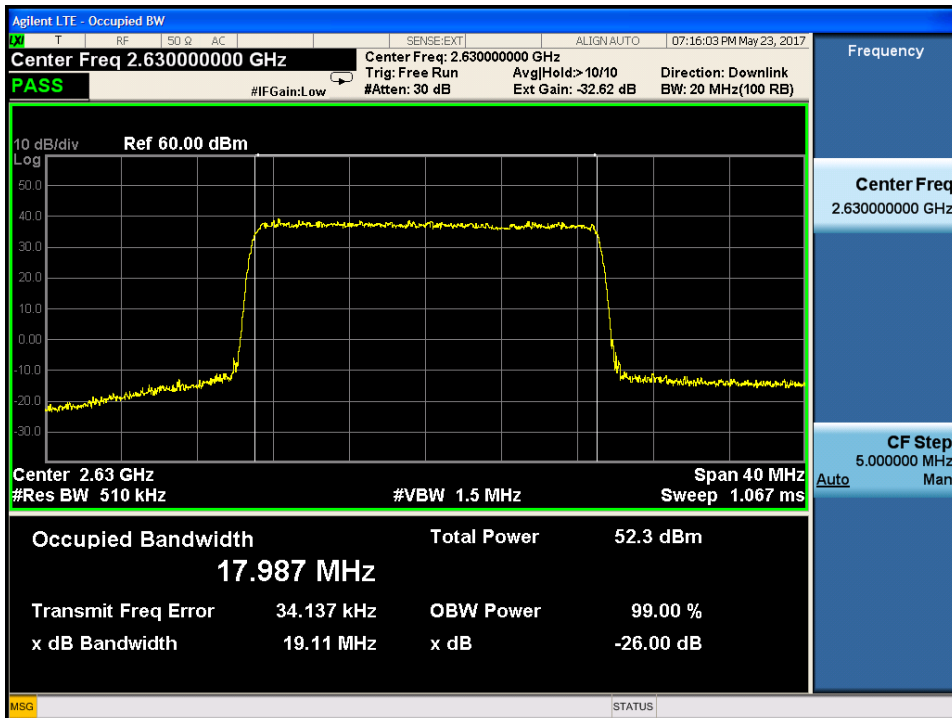



SGS-CSTC Standards Technical Services Ltd. Shenzhen Branch

Report No.: SZEM170600640803
Page: 53 of 75

1.3 middle frequency-- 5MHz bandwidth
Input:

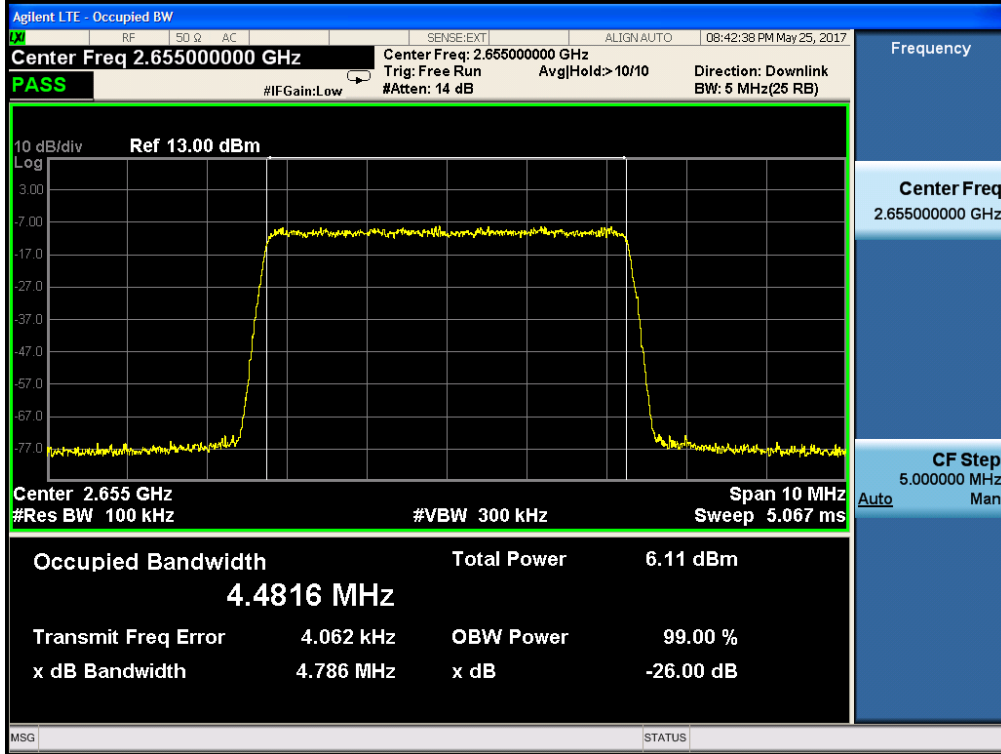

Output:

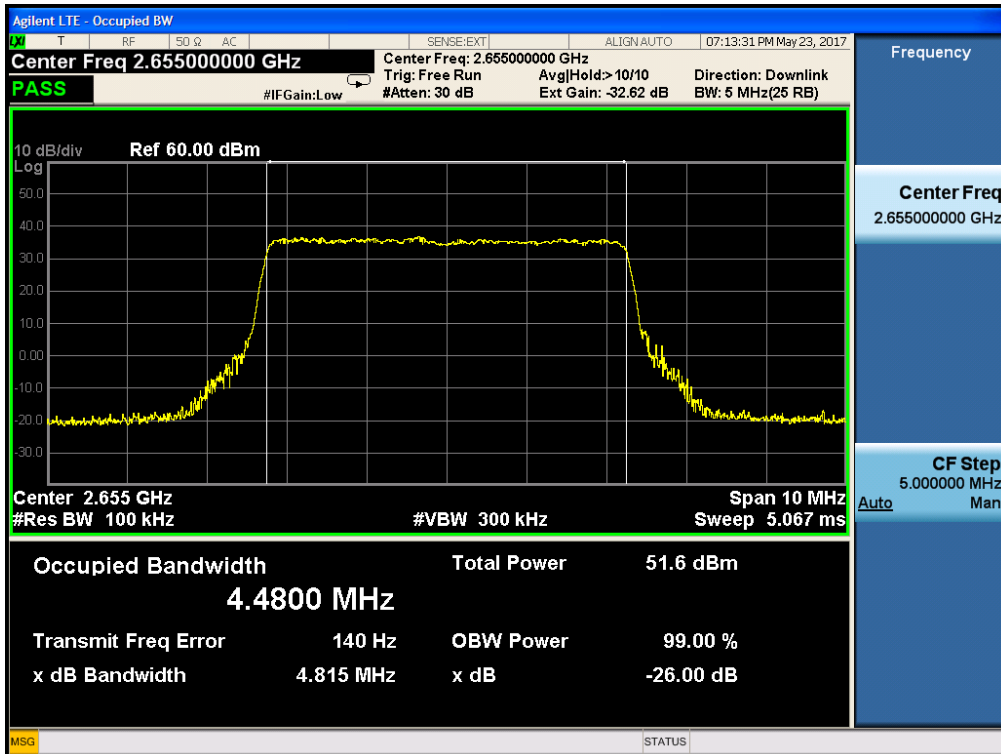



SGS-CSTC Standards Technical Services Ltd. Shenzhen Branch

Report No.: SZEM170600640803
Page: 54 of 75

1.4 middle frequency-- 20MHz bandwidth

Input:

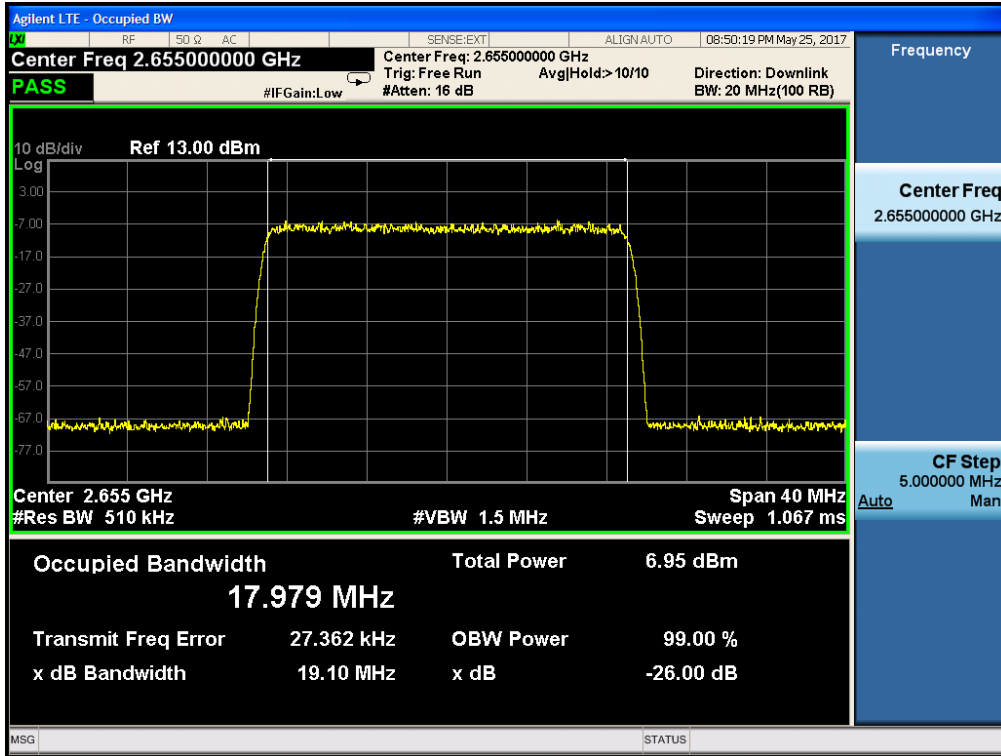

Output:

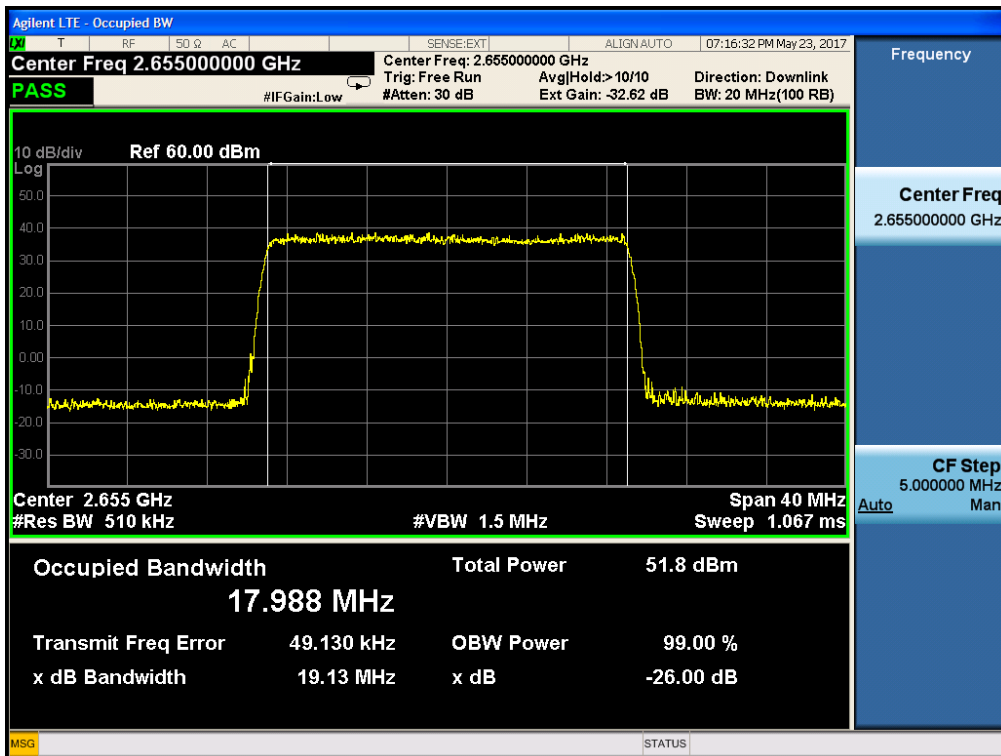



SGS-CSTC Standards Technical Services Ltd. Shenzhen Branch

Report No.: SZEM170600640803
Page: 55 of 75

1.5 highest frequency—5MHz bandwidth
Input:

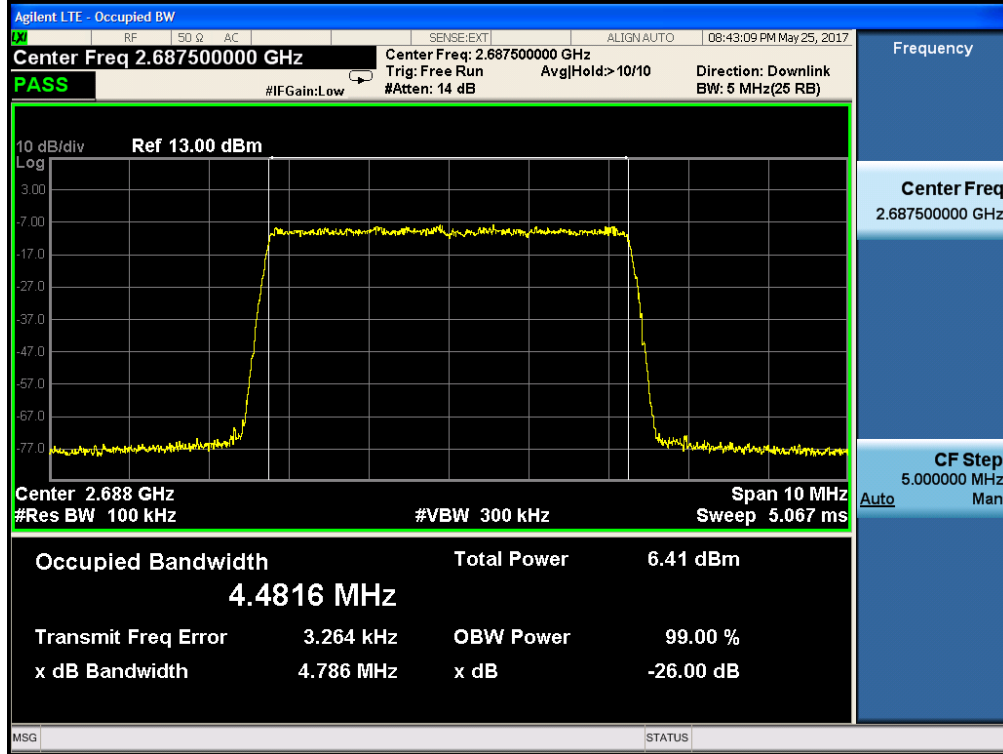

Output:

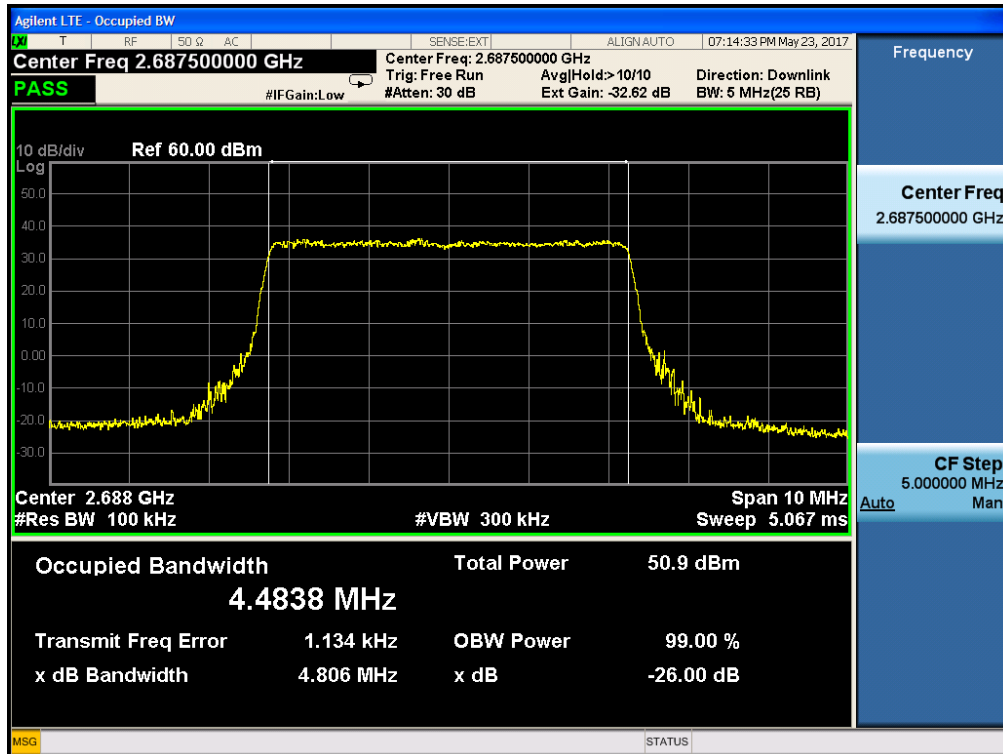



SGS-CSTC Standards Technical Services Ltd. Shenzhen Branch

Report No.: SZEM170600640803
Page: 56 of 75

1.6 highest frequency--20MHz bandwidth

Input:

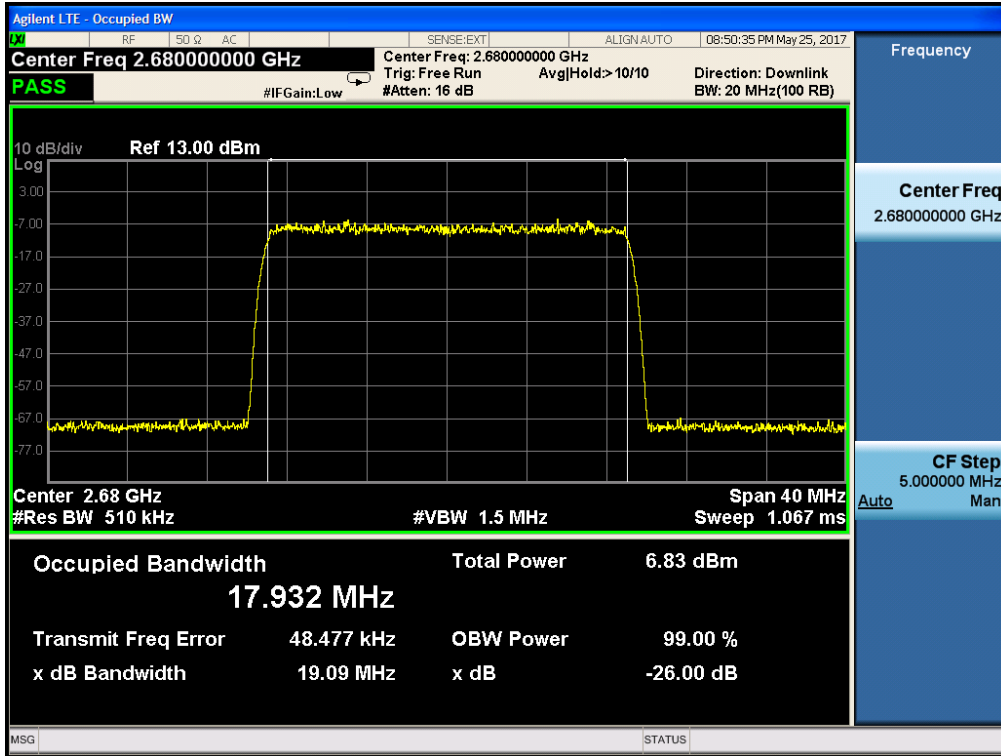

Output:

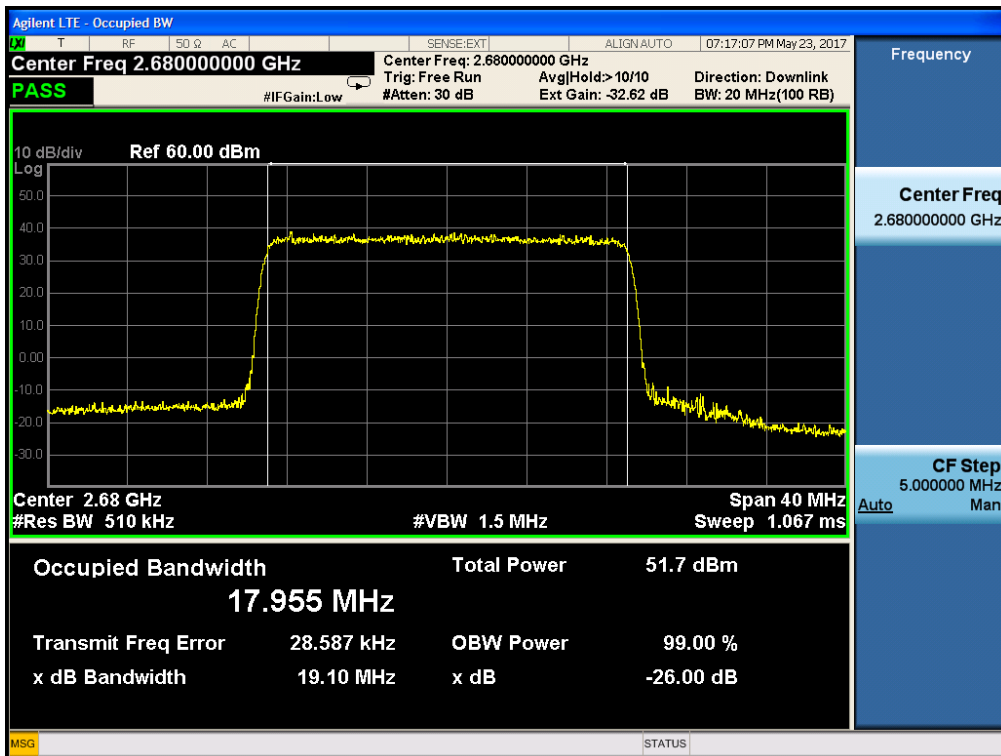



2.Downlink: 2620MHz to 2690MHz(WCDMA mode)

2.1 lowest frequency

Input:

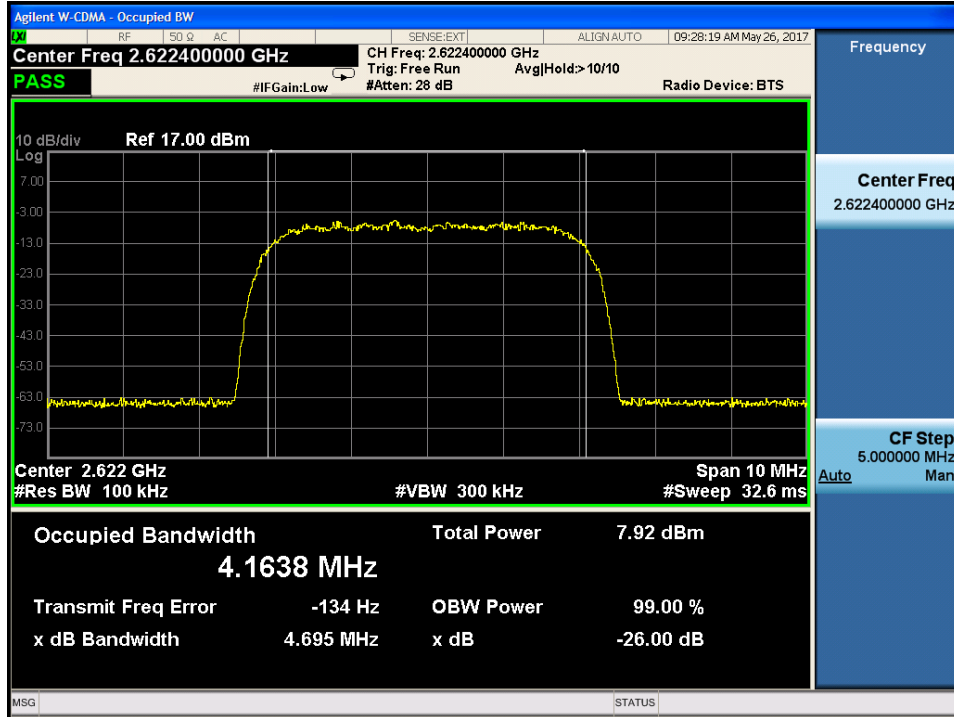

Output:

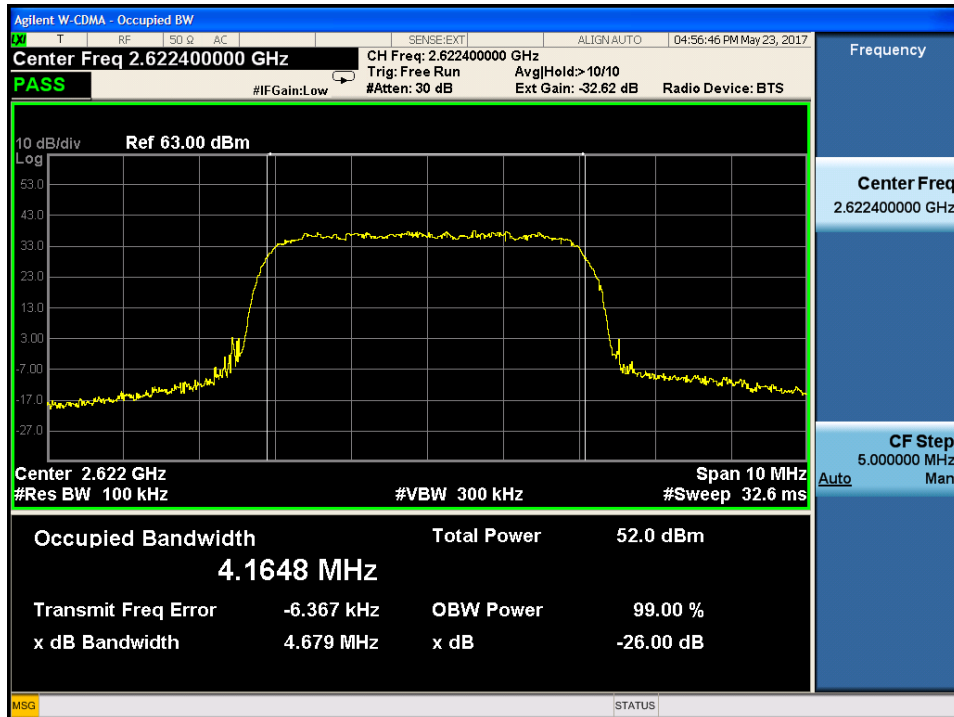



2.2 Middle frequency
Input:

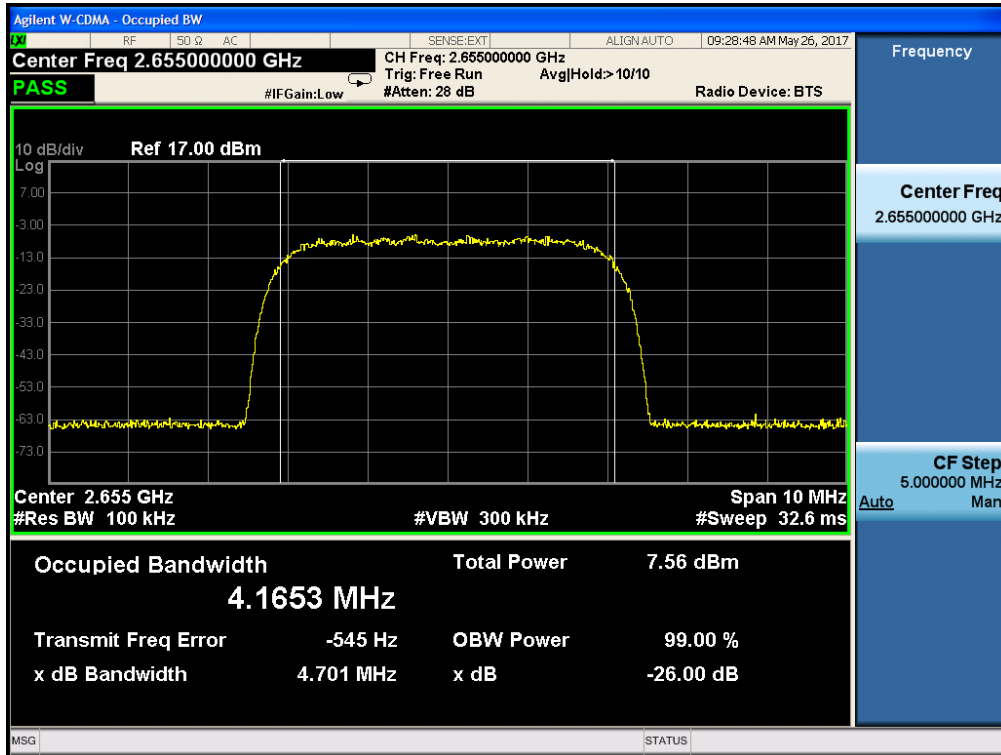

Output:

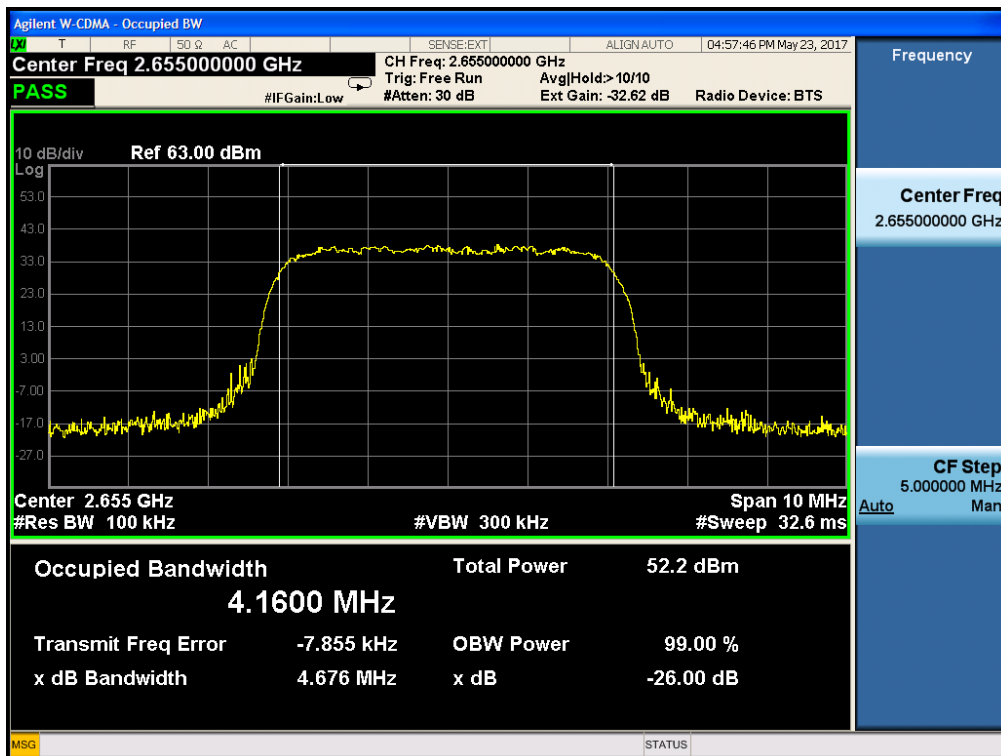



2.3 Highest frequency
Input:

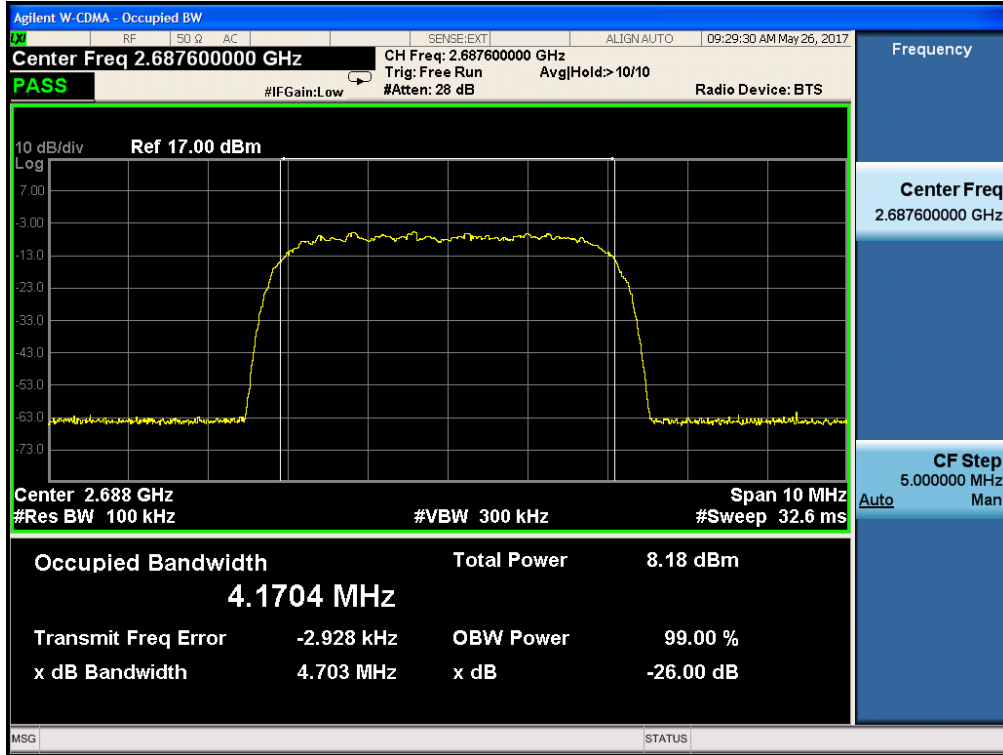

Output:

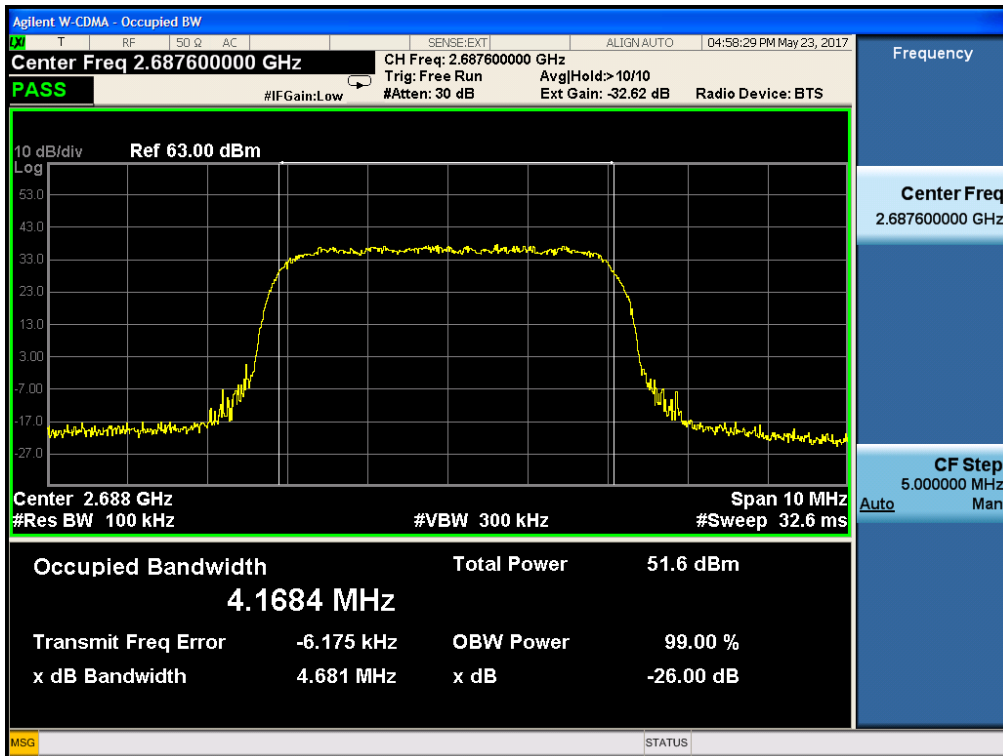

7.2.6 Out of Band Rejection

Test Requirement:	Section D.3(l) of KDB 935210 D02 Signal Booster Certification v03r02 Test for rejection of out of band signals. Filter freq. response plots are acceptable.
Test Method:	KDB 935210 D05 Indus Booster Basic Meas v01r01
EUT Operation:	
Status:	Drive the EUT to maximum output power. .
Conditions:	Normal conditions
Application:	Cellular Band RF output ports
Test Configuration:	

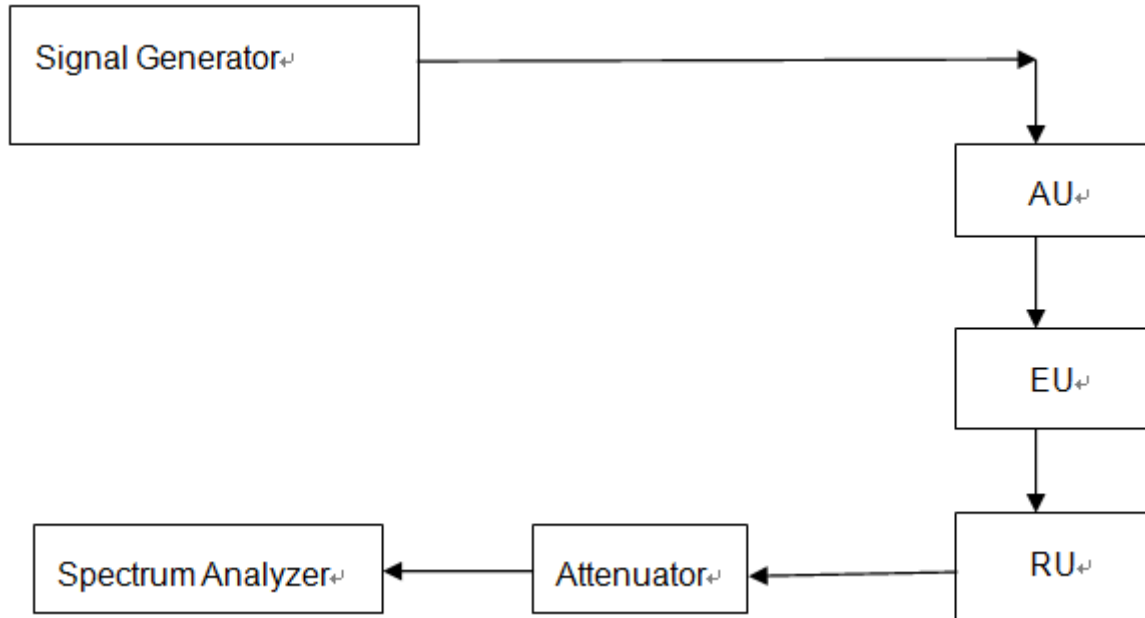
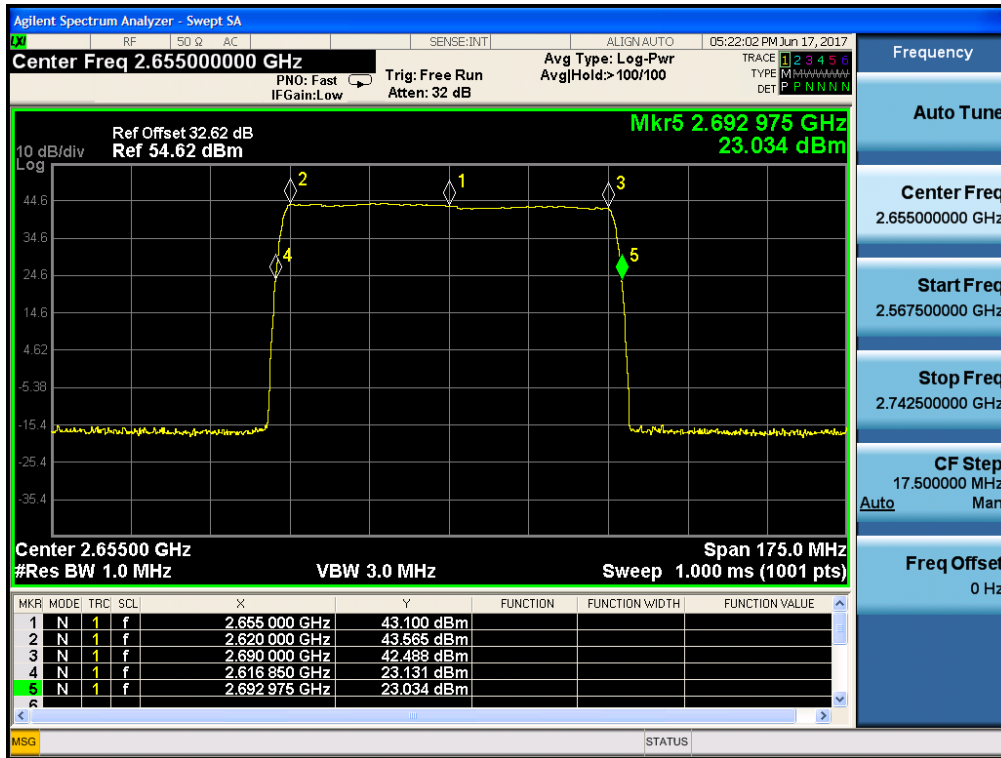

Fig.4. Out of Band rejection test configuration

Test Procedure:	<ol style="list-style-type: none"> 1. Connect the equipment as illustrated; 2. Test the background noise level with all the test facilities; 3. Keep one transmitting path, all other connectors shall be connected by normal power or RF leads; 4. Select the attenuator to avoid the test receiver or spectrum analyzer being destroyed; 5. Keep the EUT continuously transmitting in max power; 6. Signal generator sweep from the frequency more lower than the product frequency to the frequency more higher than it, find the product band filter characteristic; <ul style="list-style-type: none"> · CW signal rather than typical signal is acceptable (for FM). · Multiple band filter will need test each other.
-----------------	---



7.2.6.1 Measurement Record:
Downlink: 2620MHz to 2690MHz





7.2.7 Frequency Stability

Test Requirement: FCC part 27.54

The frequency stability shall be sufficient to ensure that the fundamental emissions stay within the authorized bands of operation.

EUT Operation:

Status: Drive the EUT to maximum output power.

Conditions: Temperature conditions, voltage conditions

Application: Cellular Band RF output ports

Test Procedure:

1. Temperature conditions:
 - a) The RF output port of the EUT was connected to Frequency Meter;
 - b) Set the working Frequency in the middle channel;
 - c) record the 20°C and nominal voltage frequency value as reference point;
 - d) vary the temperature from -40°C to 50°C with step 10°C
 - e) when reach a temperature point, keep the temperature balance at least 1 hour to make the product working in this status;
 - f) Read the frequency at the relative temperature.
2. Voltage conditions:
 - a) record the 20°C and normal voltage frequency value as reference point;
 - b) vary the voltage from -15% normal voltage to +15% voltage;
 - c) Read the frequency at the relative voltage.



7.2.7.1 Measurement Record:

Frequency Stability vs temperature:

1.Test for Downlink: 2620~2690MHz (middle channel=2655MHz)

Temperature(°C)	Frequency(MHz)	Tolerance(ppm)
50	2655.000006	0.00226
40	2655.000006	0.00226
30	2655.000006	0.00226
20	2655.000006	0.00226
10	2655.000006	0.00226
0	2655.000006	0.00226
-10	2655.000006	0.00226
-20	2655.000006	0.00226
-30	2655.000006	0.00226
-40	2655.000006	0.00226

Frequency Stability vs voltage:

1.Test for Downlink: 2620~2690MHz (middle channel=2655MHz)

Voltage(V ac)	Frequency(MHz)	Tolerance(ppm)
102	2655.000006	0.00226
120	2655.000006	0.00226
138	2655.000006	0.00226

8 Photographs - Test Setup

Above 1GHz Radiated Emission

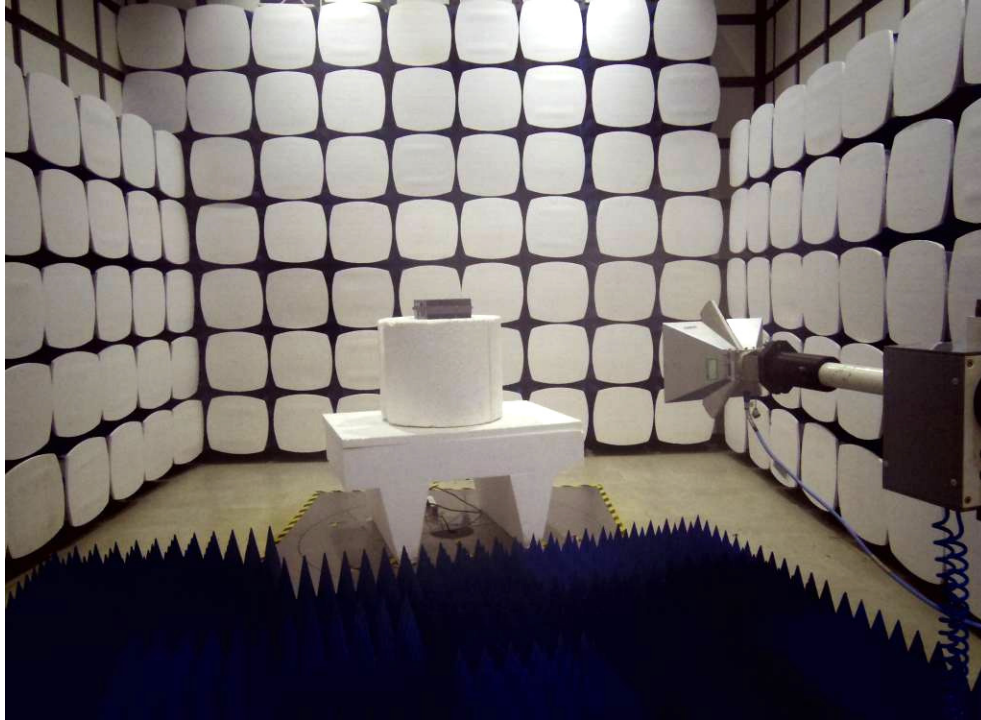

30MHz ~ 1GHz Radiated Emission

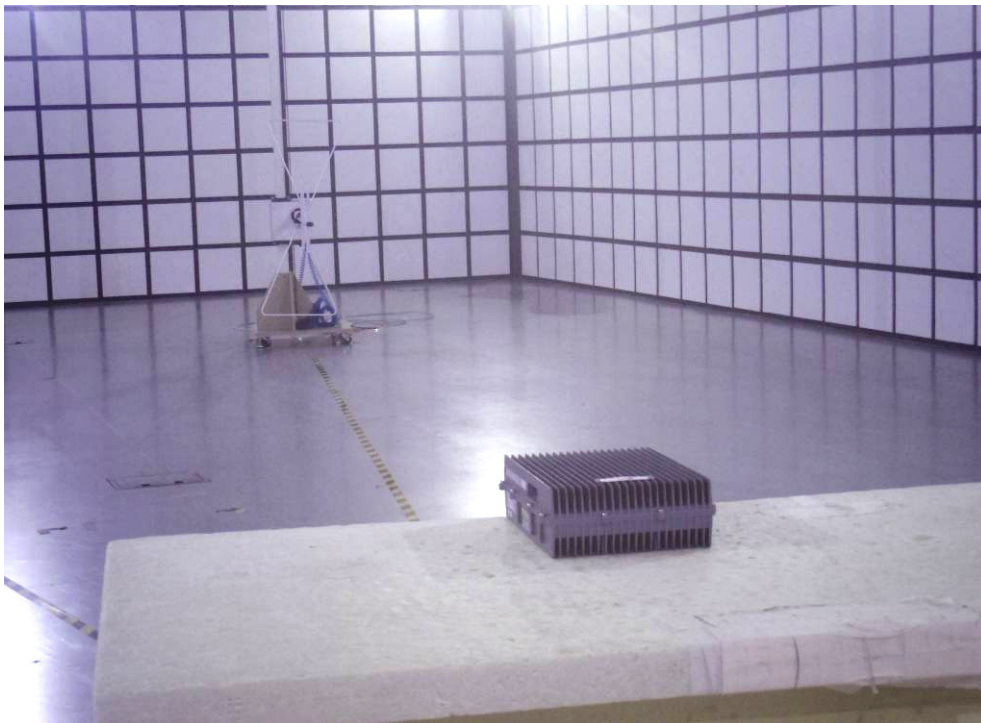

9 Photographs - EUT Constructional Details

Test Model No.: iDAS-R211





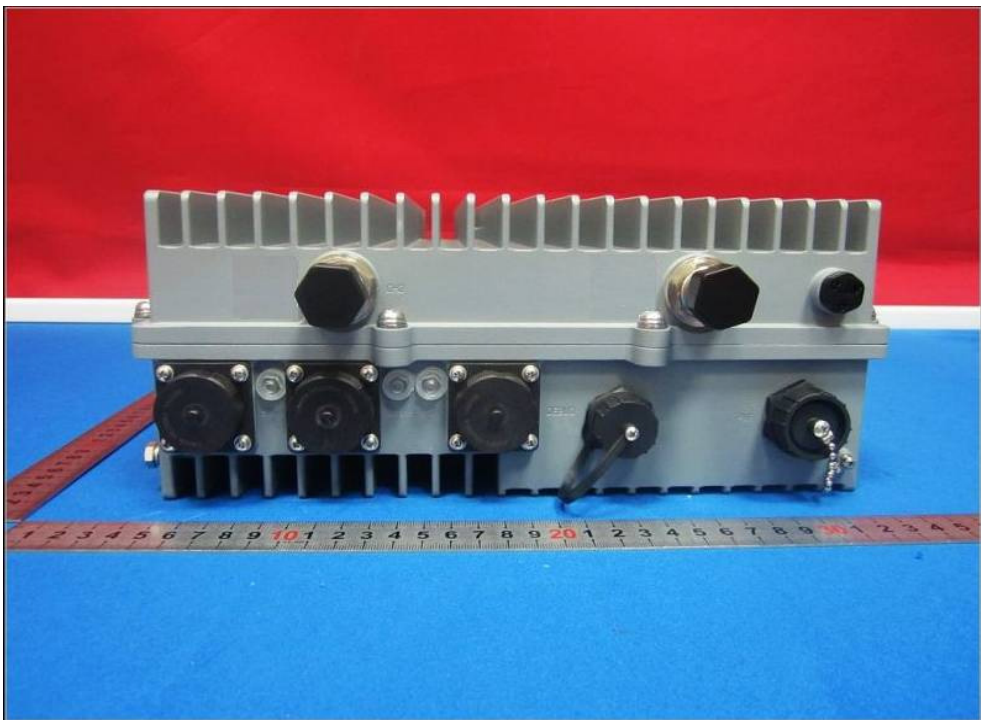

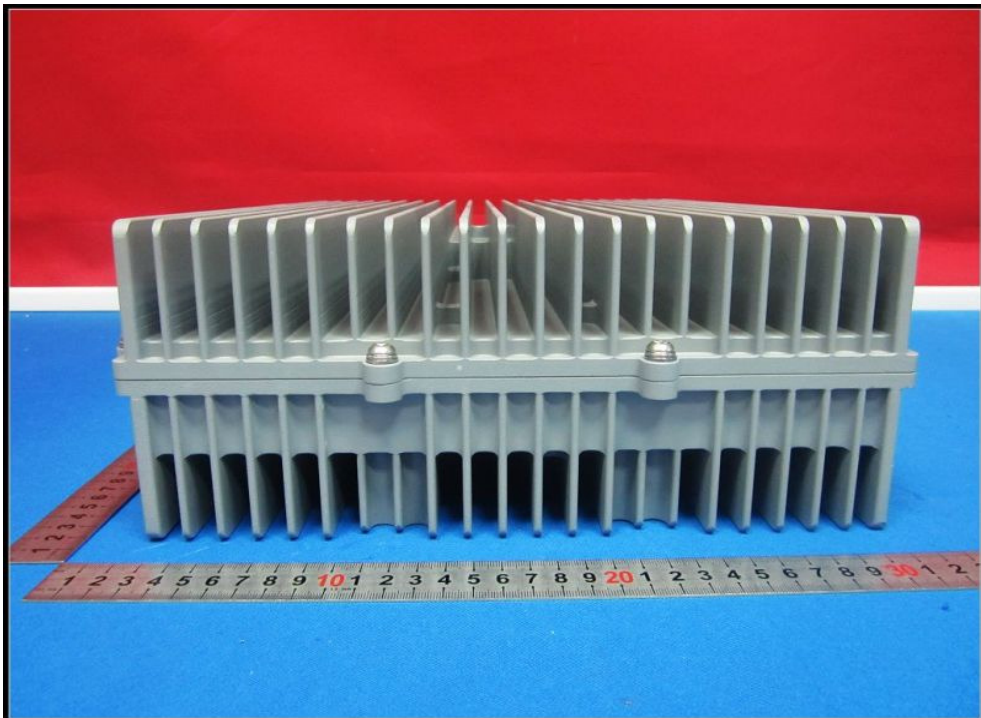
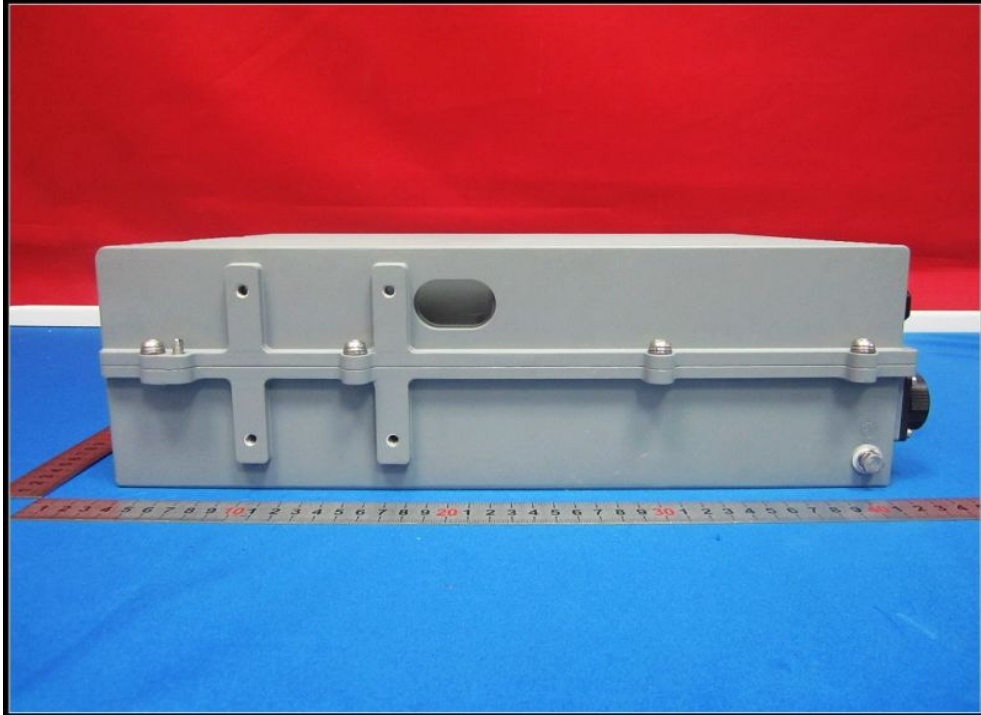

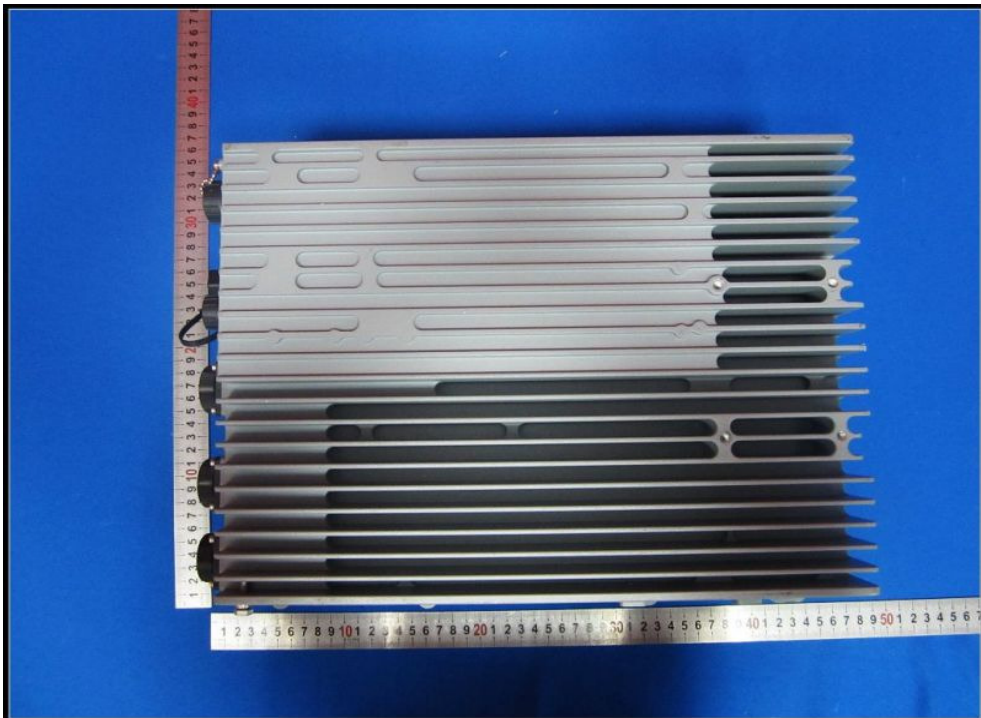
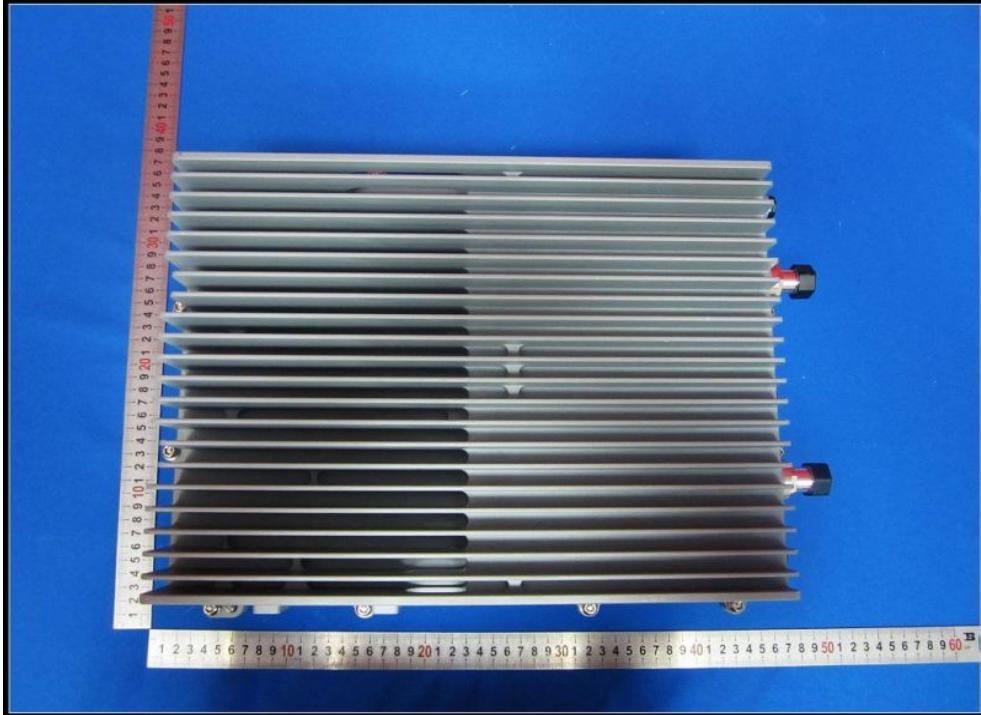

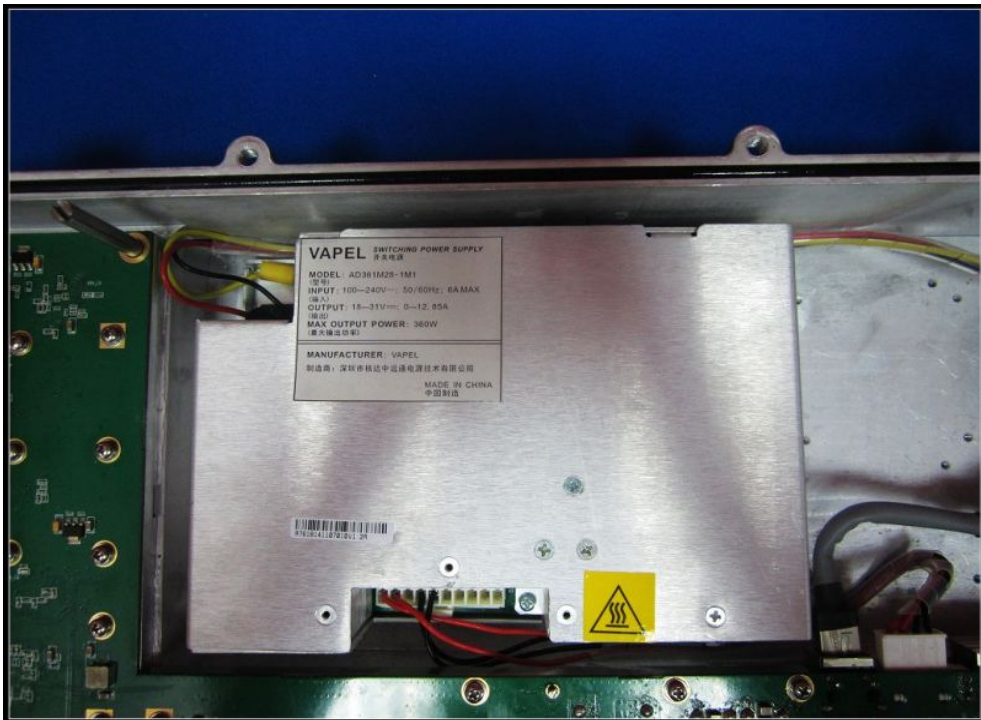
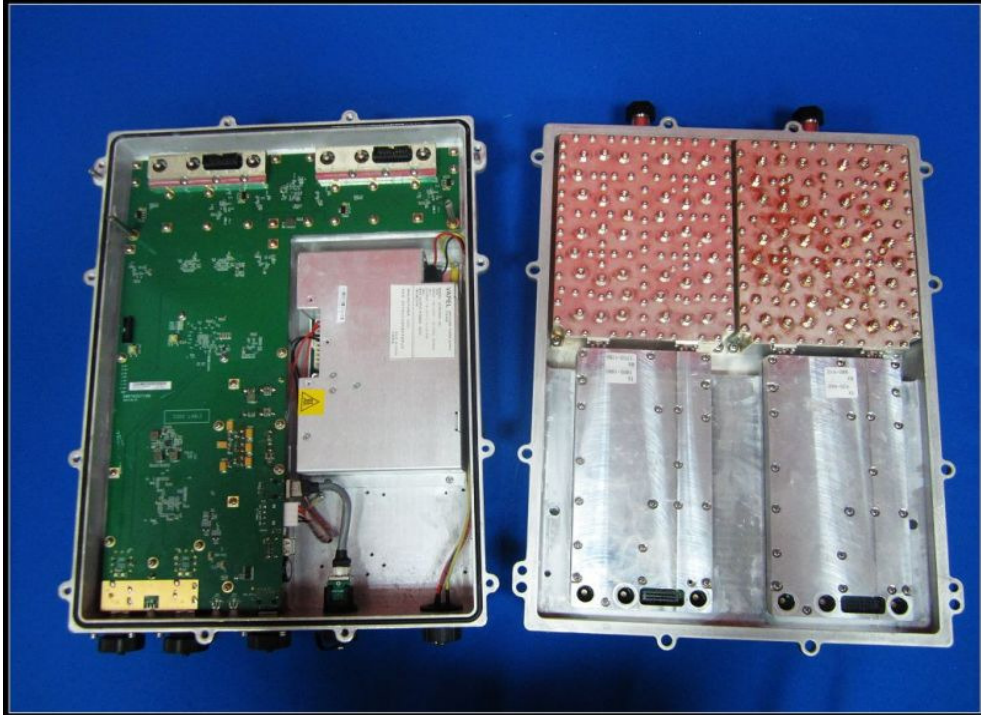

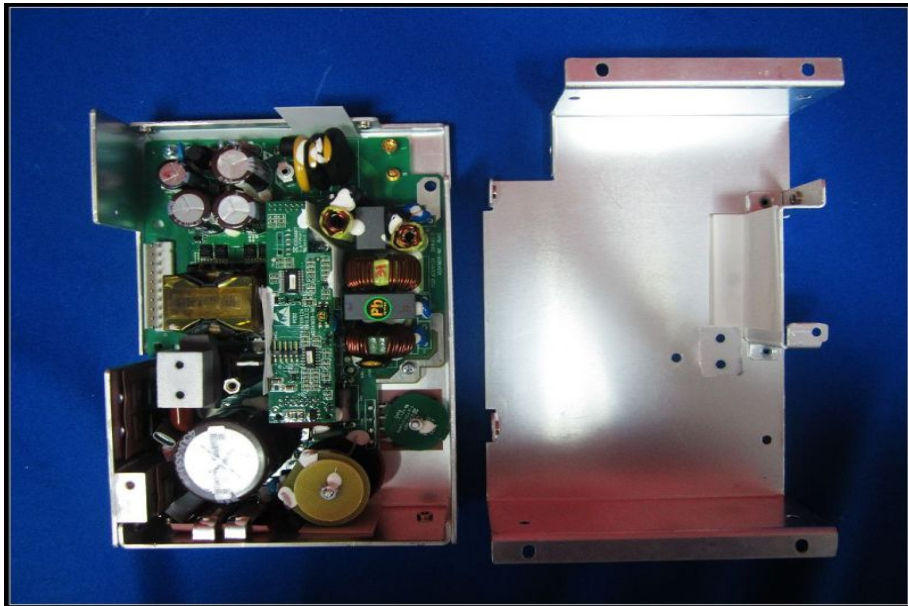
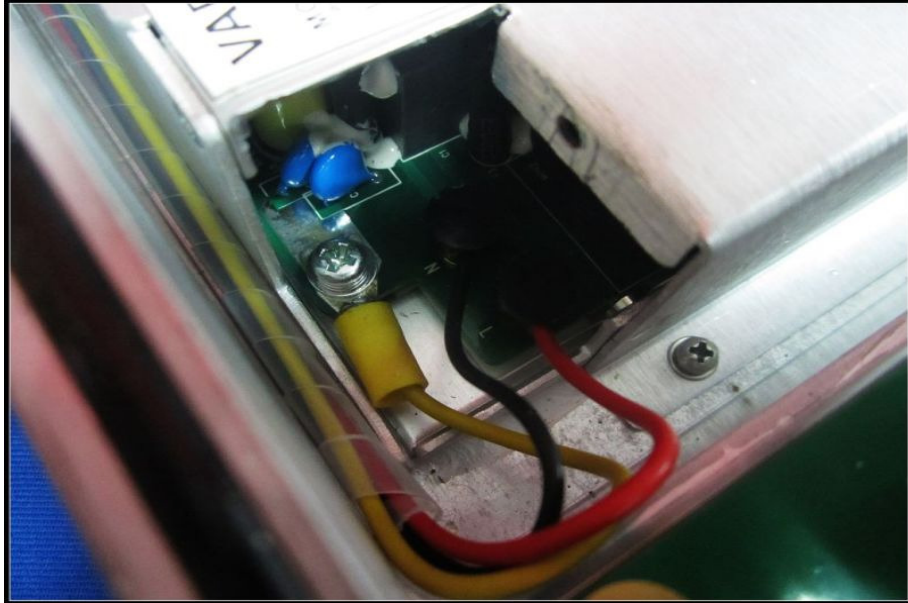

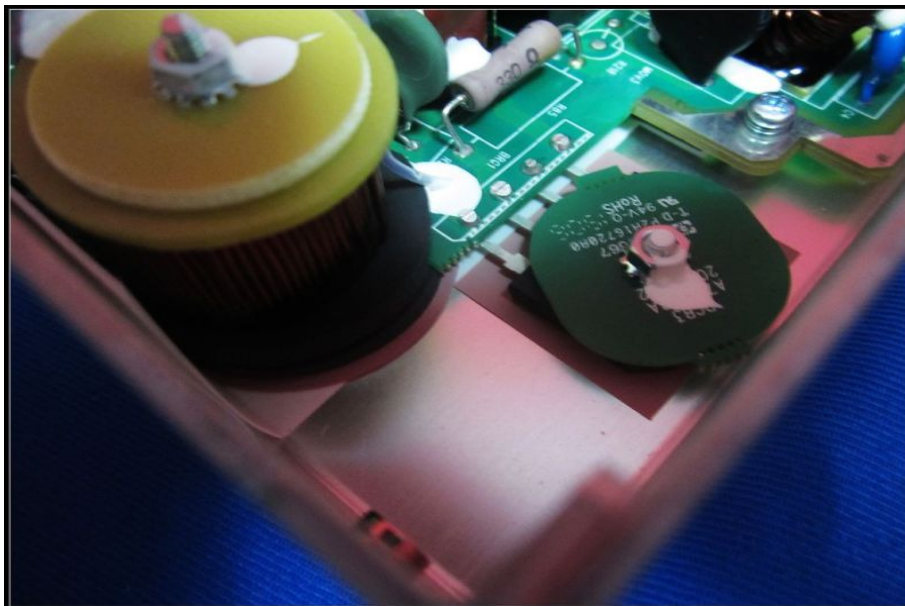
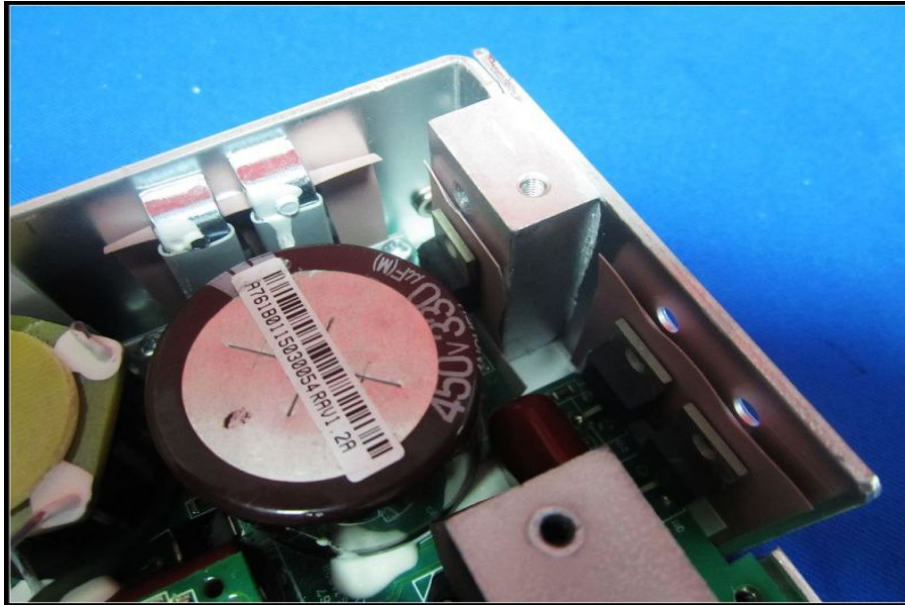

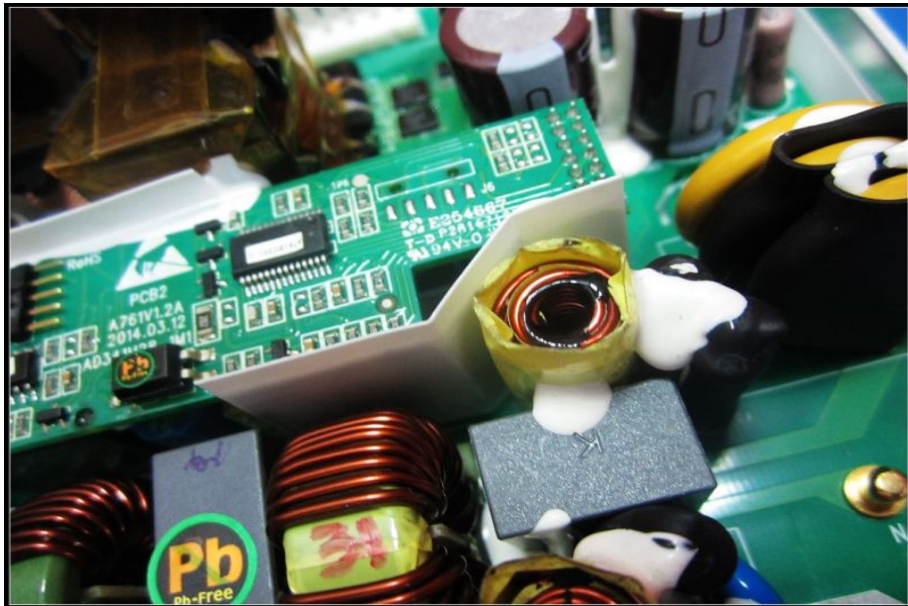
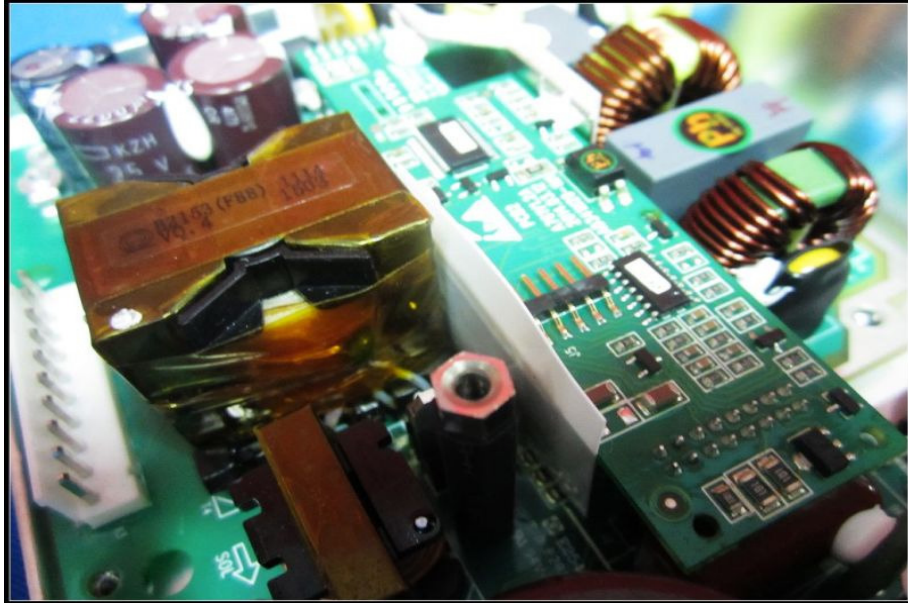

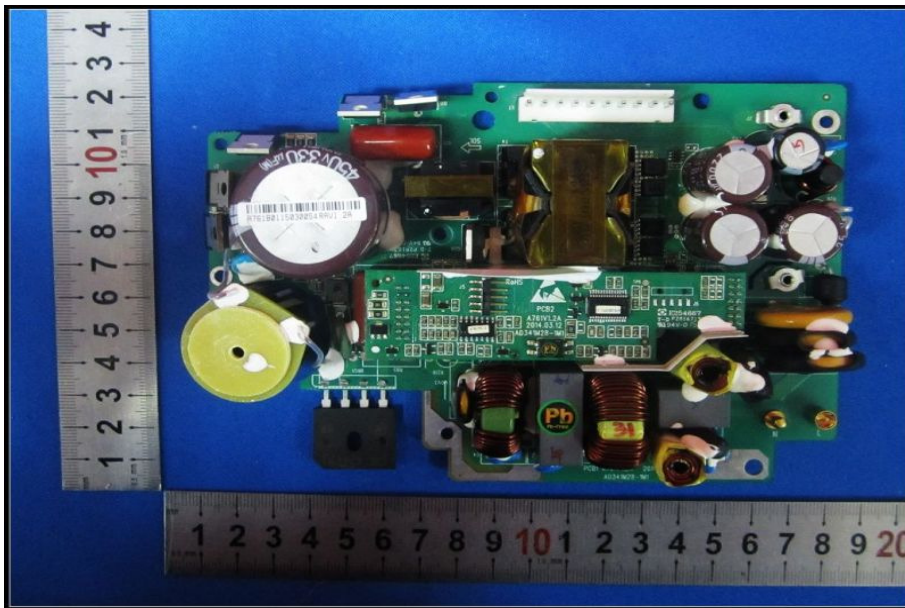
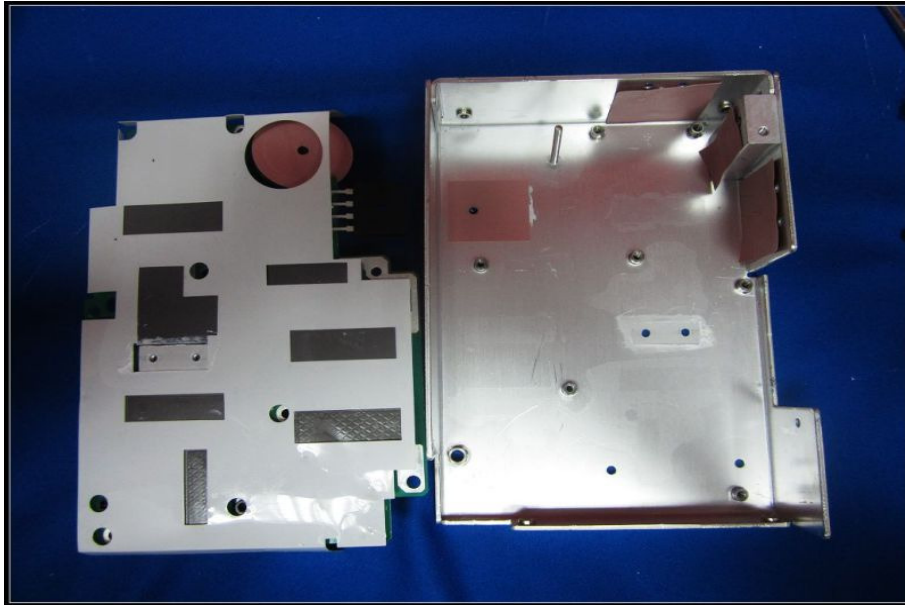



--The End of Report--