

					AU	DWG NO.		
DRAWN BY	Heng Gao					REVISIONS	MASS	SCALE
CHECKED								1:3
APPROVED						SHEET: 1 OF 1		
					SUNWAVE COMMUNICATIONS Co., LTD.			

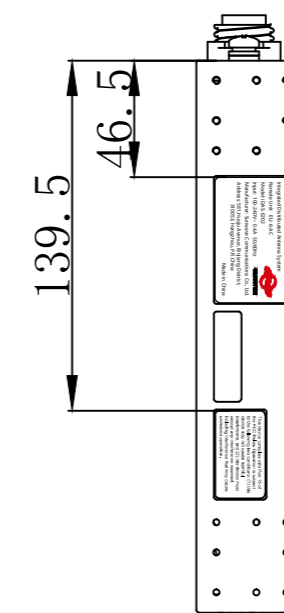

					EU	DWG NO.		
DRAWN BY	Heng Gao					REVISIONS	MASS	SCALE
CHECKED								1:3
APPROVED						SHEET: 1 OF 1		
						SUNWAVE COMMUNICATIONS Co., LTD.		

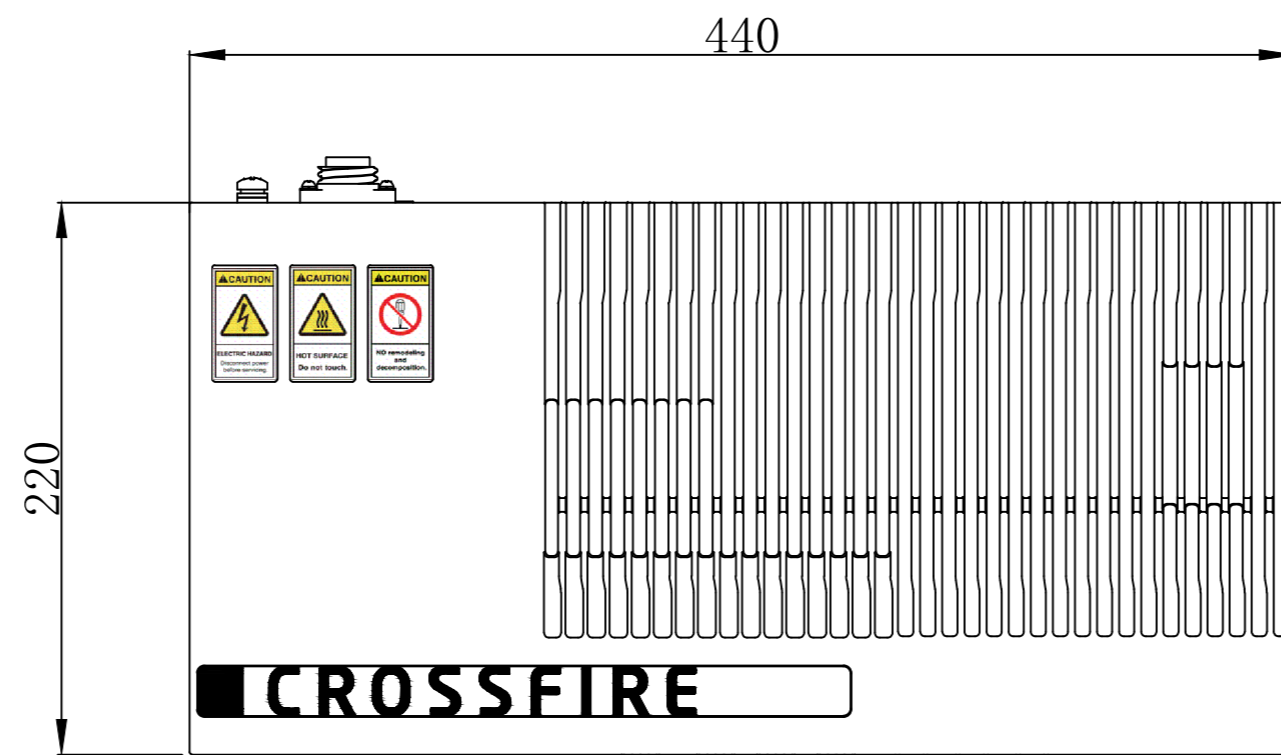
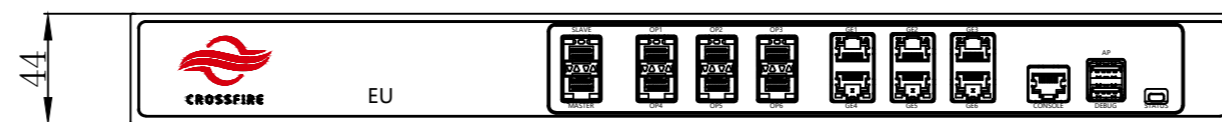
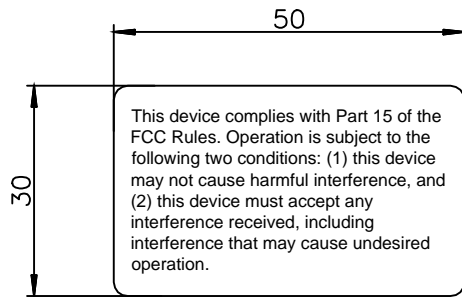
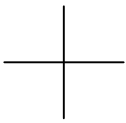
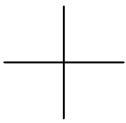

						DWG NO.		
						FCC Nameplate 1		
						REVISIONS	MASS	SCALE
								2:1
						SHEET:1 OF 1		
						SUNWAVE COMMUNICATIONS Co., LTD.		
DRAWN BY	Heng Gao							
CHECKED								
APPROVED								

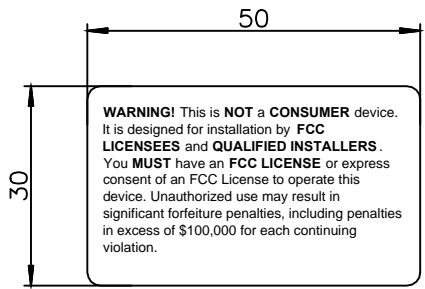
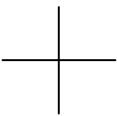
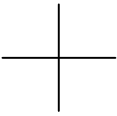

					FCC Nameplate 2	DWG NO.		
						REVISIONS	MASS	SCALE
								2:1
						SHEET:1 OF 1		
						SUNWAVE COMMUNICATIONS Co., LTD.		
DRAWN BY	Heng Gao							
CHECKED								
APPROVED								