

# FCC Part 22H and 24E

## Measurement And Test Report

For

### DBJ Technologies (Zhuhai) Co.,Ltd.

First Floor, Block 1, Manufacture Center, No.1 Software Road,  
Zhuhai, Guangdong, China.

**FCC ID: 2AEIXZJ210**

Apr.11, 2015

<b>This Report Concerns:</b> <input checked="" type="checkbox"/> Original Report	<b>Equipment Type:</b> GPS Tracker
<b>Report Number:</b>	MTI150316005RF
<b>Test Engineer:</b>	David Chen <i>David Chen</i>
<b>Reviewed By:</b>	Tim Zhang <i>Tim Zhang</i>
<b>Approved &amp; Authorized By:</b>	Hebe Lee <i>Hebe Lee</i>
<b>Test Date:</b>	Mar.22, 2015 - Apr.11, 2015
<b>Prepared By:</b>	<b>Shenzhen Microtest Technology Co.,Ltd</b> 6F, Zhongbao Building, Gushu, Bao'an District, Shenzhen, P.R.China Tel: +86-755-8885 0135 Fax: +86-755-8885 0136



**Note:** This test report is limited to the above client company and the product model only. It may not be duplicated without prior written consent of Shenzhen Microtest Technology Co.,Ltd.

## TEST RESULT CERTIFICATION

<b>TEST RESULT CERTIFICATION</b>	
<b>Applicant's name</b> .....	DBJ Technologies (Zhuhai) Co.,Ltd.
Address .....	First Floor, Block 1, Manufacture Center, No.1 Software Road, Zhuhai, Guangdong, China.
<b>Manufacture's Name</b> .....	DBJ Technologies (Zhuhai) Co.,Ltd.
Address .....	First Floor, Block 1, Manufacture Center, No.1 Software Road, Zhuhai, Guangdong, China.
<b>Product description</b>	
Product name .....	GPS Tracker
Brand Name	N/A
Model and/or type reference ...	ZJ210
Serial Model.....	N/A
<b>Standards</b> .....	FCC Part 22H and 24E
Test procedure.....	ANSI C63.4-2003

# TABLE OF CONTENTS

<b>MEASUREMENT AND TEST REPORT .....</b>	<b>1</b>
<b>1.1 PRODUCT DESCRIPTION .....</b>	<b>5</b>
<b>MODE .....</b>	<b>6</b>
<b>GSM850.....</b>	<b>6</b>
<b>1.2 RELATED SUBMITTAL(S) / GRANT (S).....</b>	<b>7</b>
<b>1.3 TEST METHODOLOGY .....</b>	<b>7</b>
<b>1.4 TEST FACILITY.....</b>	<b>7</b>
<b>1.5 MEASUREMENT INSTRUMENTS.....</b>	<b>7</b>
<b>1.6 SPECIAL ACCESSORIES.....</b>	<b>8</b>
<b>1.7 EQUIPMENT MODIFICATIONS .....</b>	<b>8</b>
<b>2. SYSTEM TEST CONFIGURATION .....</b>	<b>9</b>
<b>2.1 EUT CONFIGURATION.....</b>	<b>9</b>
<b>2.2 EUT EXERCISE .....</b>	<b>9</b>
<b>2.3 GENERAL TECHNICAL REQUIREMENTS .....</b>	<b>9</b>
<b>2.4 CONFIGURATION OF EUT SYSTEM.....</b>	<b>10</b>
<b>3. SUMMARY OF TEST RESULTS .....</b>	<b>11</b>
<b>4. DESCRIPTION OF TEST MODES .....</b>	<b>11</b>
<b>5. OUTPUT POWER.....</b>	<b>12</b>
<b>5.1 Conducted Output Power.....</b>	<b>12</b>
<b>5.2 Radiated Output Power.....</b>	<b>19</b>
<b>6. SPURIOUS EMISSION.....</b>	<b>23</b>
<b>6.1 CONDUCTED SPURIOUS EMISSION.....</b>	<b>23</b>
<b>6.2 Radiated Spurious Emission .....</b>	<b>25</b>
<b>7. FREQUENCY STABILITY .....</b>	<b>29</b>
<b>7.1 MEASUREMENT METHOD .....</b>	<b>29</b>

<b>7.2 PROVISIONS APPLICABLE.....</b>	<b>29</b>
<b>7.3 MEASUREMENT RESULT.....</b>	<b>30</b>
<b>8. OCCUPIED BANDWIDTH.....</b>	<b>34</b>
<b>8.1 MEASUREMENT METHOD.....</b>	<b>34</b>
<b>8.2 PROVISIONS APPLICABLE.....</b>	<b>34</b>
<b>8.3 MEASUREMENT RESULT.....</b>	<b>34</b>
<b>9. EMISSION BANDWIDTH.....</b>	<b>36</b>
<b>9.1 MEASUREMENT METHOD.....</b>	<b>36</b>
<b>9.2 PROVISIONS APPLICABLE.....</b>	<b>36</b>
<b>9.3 MEASUREMENT RESULT.....</b>	<b>36</b>
<b>10. BAND EDGE.....</b>	<b>38</b>
<b>10.1 MEASUREMENT METHOD.....</b>	<b>38</b>
<b>10.2 PROVISIONS APPLICABLE.....</b>	<b>38</b>
<b>10.3 MEASUREMENT RESULT.....</b>	<b>38</b>
<b>11. PEAK-TO-AVERAGE RATIO.....</b>	<b>39</b>
<b>11.1 DESCRIPTION OF THE PAR MEASUREMENT.....</b>	<b>39</b>
<b>11.2 MEASURING INSTRUMENTS.....</b>	<b>39</b>
<b>11.3 TEST PROCEDURES.....</b>	<b>39</b>
<b>11.4 TEST SETUP.....</b>	<b>39</b>
<b>11.5 TEST RESULT OF PEAK-TO-AVERAGE RATIO.....</b>	<b>40</b>
<b>11.6 TEST RESULT (PLOTS) OF PEAK-TO-AVERAGE RATIO.....</b>	<b>41</b>

# 1. GENERAL INFORMATION

## 1.1 PRODUCT DESCRIPTION

A major technical description of EUT is described as following:

Product Designation:	GPS Tracker
Hardware version:	ZJ210_T_REV1_CR00
Software version:	QD103103
Frequency Bands:	<input checked="" type="checkbox"/> GSM 850 <input checked="" type="checkbox"/> PCS 1900 (U.S. Bands) <input checked="" type="checkbox"/> GSM 900 <input checked="" type="checkbox"/> DCS 1800 (Non-U.S. Bands) U.S. Bands: <input checked="" type="checkbox"/> UMTS FDD Band II <input checked="" type="checkbox"/> UMTS FDD Band V Non-U.S. Bands: <input checked="" type="checkbox"/> UMTS FDD Band I <input type="checkbox"/> UMTS FDD Band VIII
Antenna:	Integrated Antenna
Antenna gain:	WCDMA850: -4.55dBi, WCDMA1900: -4.36dBi GSM850: -5.11dBi, GSM1900: -3.55dBi
Power Supply:	DC 3.7V by battery or DC 12.0V supplied by DC power supply
Battery parameter:	230mAh/0.85Wh
Adapter	N/A
GPRS/EDGE Class	Multi-Class12 Only 5 timeslots are used for GPRS/EDGE
Extreme Vol. Limits:	DC3.4 V to 4.2 V (Nominal DC3.7 V)
Extreme Temp. Tolerance	-10°C to +50°C
<b>** Note: The High Voltage 4.2V and Low Voltage 3.4V was declared by manufacturer, The EUT couldn't be operate normally with higher or lower voltage.</b>	

<b>MODE</b>	<b>Max. Conducted Power (dBm)</b>
GSM850	32.01
GPRS 850	31.63
EDGE 850	26.31
GSM1900	28.59
GPRS 1900	28.47
EDGE1900	25.23
UMTS BAND II	22.13
UMTS BAND V	23.37

## 1.2 RELATED SUBMITTAL(S) / GRANT (S)

This submittal(s) (test report) is intended for **FCC ID: 2AEIXZJ210** filing to comply with the FCC Part 22H&24E .

## 1.3 TEST METHODOLOGY

The radiated emission testing was performed according to the procedures of ANSI C 63.4: 2003; TIA/EIA 603 and FCC CFR 47 Rules of 2.1046, 2.1047, 2.1049, 2.1051, 2.1053, 2.1055, 2.1057.

## 1.4 TEST FACILITY

The test site used to collect the radiated data is located at:

Shenzhen Toby Technology Co., Ltd.

Add.: 10/F.,A Block, Jiada R&D Bldg., No.5 Songpingshan, Road, Science&Technology Park, Shenzhen, 518057

The test site is constructed and calibrated to meet the FCC requirements in documents ANSI C63.4: 2003.

FCC Registration No.: 811562

## 1.5 MEASUREMENT INSTRUMENTS

NAME OF EQUIPMENT	MANUFACTURER	MODEL	SERIAL NUMBER	NEXT CAL. DATE
SPECTRUM ANALYZER	AGILENT	E4440A	US44300399	2015.6.26
TEST RECEIVER	R&S	ESCI	A0304218	2015.6.26
COMMUNICATION TESTER	AGILENT	8960	3104A03367	2015.6.26
COMMUNICATION TESTER	R&S	CMU200	A0304247	2015.6.26
TEST RECEIVER	R&S	FCKL1528	A0304230	2015.6.26
LISN	SCHWARZBECK	NSLK8127	A0304233	2015.6.26
CLIMATE CHAMBER	ALBATROSS	--	--	2015.6.26
Loop Antenna	Daze	ZN30900N	SEL0097	2015.6.26
Biological Antenna	A.H. Systems Inc.	SAS-521-4	N/A	2015.6.26
Horn Antenna	EM	EM-AH-10180	N/A	2015.6.26
HORN ANTENNA	ShwarzBeck	9120D	1012	2015.6.26

## **1.6 SPECIAL ACCESSORIES**

The battery and the charger, earphone supplied by the applicant were used as accessories and being tested with EUT intended for FCC grant together.

## **1.7 EQUIPMENT MODIFICATIONS**

Not available for this EUT intended for grant.



## 2. SYSTEM TEST CONFIGURATION

### 2.1 EUT CONFIGURATION

The EUT configuration for testing is installed on RF field strength measurement to meet the Commission's requirement and operating in a manner which intends to maximize its emission characteristics in a continuous normal application.

### 2.2 EUT EXERCISE

The Transmitter was operated in the maximum output power mode through Communication Tester. The TX frequency was fixed which was for the purpose of the measurements.

### 2.3 GENERAL TECHNICAL REQUIREMENTS

Item Number	Item Description		FCC Rules
1	Output Power	Conducted output power	22.913(a) / 24.232 (b)
		Radiated output power	
2	Spurious Emission	Conducted spurious emission	2.1051 / 22.917 / 24.238
		Radiated spurious emission	
3	Frequency Stability		2.1055 /24.235
4	Occupied Bandwidth		2.1049 (h)(i)
5	Emission Bandwidth		22.917(b) / 24.238 (b)
6	Band Edge		22.917(b) / 24.238 (b)
7	Peak-to-Average Ratio		24.232

## 2.4 CONFIGURATION OF EUT SYSTEM

Fig. 2-1 Configuration of EUT System

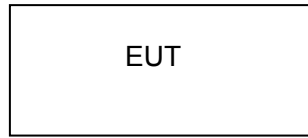

Table 2-1 Equipment Used in EUT System

Item	Equipment	Model No.	ID or Specification	Note
1	GPS Tracker	ZJ210	FCC ID: 2AEIXZJ210	EUT

*Note: All the accessories have been used during the test.  
the following "EUT" in setup diagram means EUT system.*

### 3. SUMMARY OF TEST RESULTS

Item Number	Item Description		FCC Rules	Result
1	Output Power	Conducted Output Power	22.913(a) / 24.232 (b)	Pass
		Radiated Output Power		
2	Spurious Emission	Conducted Spurious Emission	2.1051 / 22.917 / 24.238	Pass
		Radiated Spurious Emission		
3	Frequency Stability		2.1055 /24.235	Pass
4	Occupied Bandwidth		2.1049 (h)(i)	Pass
5	Emission Bandwidth		22.917(b) / 24.238 (b)	Pass
6	Band Edge		22.917(b) / 24.238 (b)	Pass
7	Peak-to-Average Ratio		24.232	Pass

### 4. DESCRIPTION OF TEST MODES

During the testing, the EUT was controlled via Rhode & Schwarz Digital Radio Communication Tester (CMU 200) to ensure max power transmission and proper modulation. Three channels (The top channel, the middle channel and the bottom channel) were chosen for testing on both GPRS850 and GPRS1900 frequency band.

**Note:** GSM/GPRS/EDGES850, GSM/GPRS/EDGE1900, HSDPA band II, HSUPA band II, HSDPA band V, HSUPA band V modes have been tested during the test.

the worst condition (GPRS/EDGE 850) be recorded in the test report if no other modes test data.

## 5. OUTPUT POWER

### 5.1 Conducted Output Power

#### 5.1.1 MEASUREMENT METHOD

The EUT was setup for the max output power with pseudo random data modulation. Power was measured with Spectrum Analyzer. The measurements were performed on all modes(GPRS/EDGE850, GPRS/EDGE1900, HSDPA band V) at 3 typical channels(the Top Channel, the Middle Channel and the Bottom Channel) for each band.

#### 5.1.2 MEASUREMENT RESULT

Conducted Output Power Limits for GSM 850 MHZ		
Mode	Nominal Peak Power	Tolerance(dB)
GSM850	32 dBm	+/- 1.5
GPRS 850-1TS:	31 dBm	+/- 1.5
GPRS 850-2TS:	30 dBm	+/- 1.5
GPRS 850-3TS:	28 dBm	+/- 1.5
GPRS 850-4TS:	27 dBm	+/- 1.5
EDGE 850-1TS:	26 dBm	+/- 1.5
EDGE 850-2TS:	25 dBm	+/- 1.5
EDGE 850-3TS:	24 dBm	+/- 1.5
EDGE 850-4TS:	22 dBm	+/- 1.5

Conducted Output Power Limits for PCS 1900 MHZ		
Mode	Nominal Peak Power	Tolerance(dB)
GSM1900	28 dBm	+/- 1.5
GPRS 1900-1TS:	28 dBm	+/- 1.5
GPRS 1900-2TS:	27 dBm	+/- 1.5
GPRS 1900-3TS:	26 dBm	+/- 1.5
GPRS 1900-4TS:	24 dBm	+/- 1.5
EDGE 1900-1TS:	25 dBm	+/- 1.5
EDGE 1900-2TS:	24 dBm	+/- 1.5
EDGE 1900-3TS:	23 dBm	+/- 1.5
EDGE 1900-4TS:	21 dBm	+/- 1.5

<b>Conducted Output Power Limits for WCDMA band II</b>		
<b>Mode</b>	<b>Nominal Peak Power</b>	<b>Tolerance(dB)</b>
<b>WCDMA band II</b>	22 dBm	+/- 1.5
<b>HSDPA band II</b>	21 dBm	+/- 1.5
<b>HSUPA band II</b>	21 dBm	+/- 1.5

<b>Conducted Output Power Limits for WCDMA band V</b>		
<b>Mode</b>	<b>Nominal Peak Power</b>	<b>Tolerance(dB)</b>
<b>WCDMA band V</b>	22 dBm	+/- 1.5
<b>HSDPA band V</b>	21 dBm	+/- 1.5
<b>HSUPA band V</b>	21 dBm	+/- 1.5

**GSM 850:**

<b>Mode</b>	<b>Frequency (MHz)</b>	<b>Peak Power</b>
GSM850	824.2	<b>32.01</b>
	836.6	31.22
	848.8	31.43
GPRS850 (1 Slot)	824.2	31.11
	836.6	31.25
	848.8	31.63
GPRS850 (2 Slot)	824.2	31.14
	836.6	31.28
	848.8	31.57
GPRS850 (3 Slot)	824.2	28.01
	836.6	28.96
	848.8	28.07
GPRS850 (4 Slot)	824.2	27.14
	836.6	27.35
	848.8	27.59
EGPRS850 (1 Slot)	824.2	26.31
	836.6	26.12
	848.8	26.14
EGPRS850 (2 Slot)	824.2	25.22
	836.6	25.23
	848.8	25.21
EGPRS850 (3 Slot)	824.2	24.21
	836.6	24.87
	848.8	24.11
EGPRS850 (4 Slot)	824.2	22.32
	836.6	22.35
	848.8	22.68

**PCS 1900:**

<b>Mode</b>	<b>Frequency (MHz)</b>	<b>Peak Power</b>
GSM1900	1850.2	28.44
	1880	28.59
	1909.8	28.56
GPRS1900 (1 Slot)	1850.2	28.31
	1880	28.43
	1909.8	28.47
GPRS1900 (2 Slot)	1850.2	27.36
	1880	27.39
	1909.8	27.51
GPRS1900 (3 Slot)	1850.2	26.71
	1880	26.81
	1909.8	26.96
GPRS1900 (4 Slot)	1850.2	24.41
	1880	24.56
	1909.8	24.72
EGPRS1900 (1 Slot)	1850.2	25.11
	1880	25.23
	1909.8	25.23
EGPRS1900 (2 Slot)	1850.2	24.65
	1880	24.72
	1909.8	24.69
EGPRS1900 (3 Slot)	1850.2	23.98
	1880	23.68
	1909.8	23.22
EGPRS1900 (4 Slot)	1850.2	21.32
	1880	21.45
	1909.8	21.65

**UMTS BAND II**

<b>Mode</b>	<b>Frequency (MHz)</b>	<b>Peak Power</b>
WCDMA band II RMC	1852.4	<b>22.13</b>
	1880	21.14
	1907.6	21.32
HSDPA Subtest 1	1852.4	21.41
	1880	21.61
	1907.6	21.71
HSDPA Subtest 2	1852.4	21.36
	1880	21.41
	1907.6	21.54
HSDPA Subtest 3	1852.4	21.35
	1880	21.49
	1907.6	21.56
HSDPA Subtest 4	1852.4	21.41
	1880	21.53
	1907.6	21.65

HSUPA Subtest 1	1852.4	21.43
	1880	21.64
	1907.6	21.51
HSUPA Subtest 2	1852.4	21.36
	1880	20.41
	1907.6	21.52
HSUPA Subtest 3	1852.4	21.35
	1880	20.49
	1907.6	21.55
HSUPA Subtest 4	1852.4	21.41
	1880	21.51
	1907.6	20.63
HSUPA Subtest 5	1852.4	21.23
	1880	21.21
	1907.6	21.13



**UMTS BAND V**

<b>Mode</b>	<b>Frequency (MHz)</b>	<b>Peak Power</b>
WCDMA 850 RMC	826.4	22.11
	835.0	22.26
	846.6	<b>22.37</b>
HSDPA Subtest 1	826.4	21.54
	835.0	21.56
	846.6	21.71
HSDPA Subtest 2	826.4	22.76
	835.0	22.81
	846.6	22.87
HSDPA Subtest 3	826.4	22.68
	835.0	22.75
	846.6	22.83
HSDPA Subtest 4	826.4	22.62
	835.0	22.64
	846.6	22.68

HSUPA Subtest 1	826.4	21.51
	835.0	21.31
	846.6	21.41
HSUPA Subtest 2	826.4	21.36
	835.0	21.22
	846.6	21.22
HSUPA Subtest 3	826.4	21.32
	835.0	21.23
	846.6	21.22
HSUPA Subtest 4	826.4	21.62
	835.0	21.64
	846.6	21.61
HSUPA Subtest 5	826.4	21.12
	835.0	21.21
	846.6	21.15

According to 3GPP 25.101 sub-clause 6.2.2 , the maximum output power is allowed to be reduced by following the table.

Table 6.1aA: UE maximum output power with HS-DPCCH and E-DCH

UE Transmit Channel Configuration	CM(db)	MPR(db)
For all combinations of ,DPDCH,DPCCH HS-DPDCH,E-DPDCH and E-DPCCH	$0 \leq CM \leq 3.5$	$MAX(CM-1,0)$
Note: CM=1 for $\beta_c/\beta_d=12/15$ , $\beta_{hs}/\beta_c=24/15$ .For all other combinations of DPDCH, DPCCH, HS-DPCCH, E-DPDCH and E-DPCCH the MPR is based on the relative CM difference.		

The device supports MPR to solve linearity issues (ACLR or SEM) due to the higher peak-to average ratios (PAR) of the HSUPA signal. This prevents saturating the full range of the TX DAC inside of device and provides a reduced power output to the RF transceiver chip according to the Cubic Metric (a function of the combinations of DPDCH, DPCCH, HS-DPCCH, E-DPDCH and E-DPCCH).

When E-DPDCH channels are present the beta gains on those channels are reduced firsts to try to get the power under the allowed limit. If the beta gains are lowered as far as possible, then a hard limiting is applied at the maximum allowed level.

The SW currently recalculates the cubic metric every time the beta gains on the E-DPDCH are reduced. The cubic metric will likely get lower each time this is done .However, there is no reported reduction of maximum output power in the HSUPA mode since the device also provides a compensate for the power back-off by increasing the gain of TX\_AGC in the transceiver (PA) device.

The end effect is that the DUT output power is identical to the case where there is no MPR in the device.

## 5.2 Radiated Output Power

### 5.2.1 MEASUREMENT METHOD

The measurements procedures specified in TIA-603C-2004 were applied.

- 1 In an anechoic antenna test chamber, a half-wave dipole antenna for the frequency band of interest is placed at the reference centre of the chamber. An RF Signal source for the frequency band of interest is connected to the dipole with a cable that has been constructed to not interfere with the radiation pattern of the antenna. A known (measured) power ( $P_{in}$ ) is applied to the input of the dipole, and the power received ( $P_r$ ) at the chamber's probe antenna is recorded.
- 2 The substitution method is used. Substitution values at each frequency are measured before and saved to the test software. A "reference path loss" is established as  $AR_{pl} = P_{in} + 2.15 - P_r$ . The  $AR_{pl}$  is the attenuation of "reference path loss", and including the gain of receive antenna, the cable loss and the air loss. The measurement results are obtained as described below:  $Power = P_{Mea} + AR_{pl}$
- 3 The EUT is substituted for the dipole at the reference centre of the chamber and a scan is performed to obtain the radiation pattern.
- 4 From the radiation pattern, the co-ordinates where the maximum antenna gain occurs are identified.
- 5 The EUT is then put into continuously transmitting mode at its maximum power level.
- 6 Power mode measurements are performed with the receiving antenna placed at the coordinates determined in Step 3 to determine the output power as defined in Rule 24.232 (b) and (c). The "reference path loss" from Step1 is added to this result.
- 7 This value is EIRP since the measurement is calibrated using a half-wave dipole antenna of known gain (2.15 dBi) and known input power ( $P_{in}$ ).
- 8 ERP can be calculated from EIRP by subtracting the gain of the dipole,  $ERP = EIRP - 2.15dBi$ .
9. Both horizontal and vertical antenna polarities were tested and performed pretest to three orthogonal axis. The worst case emissions were reported

### 5.2.2 PROVISIONS APPLICABLE

This is the test for the maximum radiated power from the EUT. Rule Part 24.232(b) specifies, "Mobile/portable stations are limited to 2 watts e.i.r.p. Peak power" and 24.232(c) specifies that "Peak transmit power must be measured over any interval of continuous transmission using instrumentation calibrated in terms of an rms-equivalent voltage." Rule Part 22.913(a) specifies "Maximum ERP. The effective radiated power (ERP) of base transmitters and cellular repeaters must not exceed 500 Watts. The ERP of mobile transmitters and auxiliary test transmitters must not exceed 7 Watts."

Mode	Nominal Peak Power
GSM 850	$\leq 38.45$ dBm (7W)
PCS 1900	$\leq 33$ dBm (2W)
UMTS BAND II	$\leq 33$ dBm (2W)
UMTS BANDV	$\leq 38.45$ dBm (7W)

### 5.2.3 MEASUREMENT RESULT

Radiated Power (ERP) for GSM 850 MHZ				
Mode	Frequency	Result		Conclusion
		Max. Peak ERP (dBm)	Polarization Of Max. ERP	
GSM850	824.2	29.32	Horizontal	Pass
	824.2	27.14	Vertical	Pass
	836.6	29.34	Horizontal	Pass
	836.6	28.82	Vertical	Pass
	848.8	<b>30.43</b>	Horizontal	Pass
	848.8	29.09	Vertical	Pass

Radiated Power (ERP) for GPRS 850 MHZ				
Mode	Frequency	Result		Conclusion
		Max. Peak ERP (dBm)	Polarization Of Max. ERP	
GPRS850	824.2	28.31	Horizontal	Pass
	824.2	27.01	Vertical	Pass
	836.6	28.09	Horizontal	Pass
	836.6	28.31	Vertical	Pass
	848.8	<b>28.89</b>	Horizontal	Pass
	848.8	27.43	Vertical	Pass

Radiated Power (ERP) for EDGE 850 MHZ				
Mode	Frequency	Result		Conclusion
		Max. Peak ERP (dBm)	Polarization Of Max. ERP	
EDGE850	824.2	28.15	Horizontal	Pass
	824.2	27.12	Vertical	Pass
	836.6	28.21	Horizontal	Pass
	836.6	27.13	Vertical	Pass
	848.8	<b>28.78</b>	Horizontal	Pass
	848.8	27.22	Vertical	Pass

Radiated Power (E.I.R.P) for PCS 1900 MHZ				
Mode	Frequency	Result		Conclusion
		Max. Peak E.I.R.P.(dBm)	Polarization Of Max. E.I.R.P.	
PCS1900	1850.2	27.69	Horizontal	Pass
	1850.2	26.79	Vertical	Pass
	1880.0	27.87	Horizontal	Pass
	1880.0	25.65	Vertical	Pass
	1909.8	<b>28.54</b>	Horizontal	Pass
	1909.8	26.45	Vertical	Pass

Radiated Power (E.I.R.P) for GPRS 1900 MHZ				
Mode	Frequency	Result		Conclusion
		Max. Peak E.I.R.P.(dBm)	Polarization Of Max. E.I.R.P.	
GPRS 1900	1850.2	27.64	Horizontal	Pass
	1850.2	26.54	Vertical	Pass
	1880.0	27.78	Horizontal	Pass
	1880.0	25.89	Vertical	Pass
	1909.8	<b>28.78</b>	Horizontal	Pass
	1909.8	26.44	Vertical	Pass

Radiated Power (E.I.R.P) for GPRS 1900 MHZ				
Mode	Frequency	Result		Conclusion
		Max. Peak E.I.R.P.(dBm)	Polarization Of Max. E.I.R.P.	
EGPRS 1900	1850.2	26.23	Horizontal	Pass
	1850.2	26.34	Vertical	Pass
	1880.0	27.32	Horizontal	Pass
	1880.0	25.45	Vertical	Pass
	1909.8	<b>27.98</b>	Horizontal	Pass
	1909.8	26.12	Vertical	Pass

Radiated Power (ERP) for UMTS band II				
Mode	Frequency	Result		Conclusion
		Max. Peak ERP (dBm)	Polarization Of Max. ERP	
RMC 12.2kbps	1852.4	20.65	Horizontal	Pass
	1852.4	19.12	Vertical	Pass
	1880	20.88	Horizontal	Pass
	1880	18.98	Vertical	Pass
	1907.6	<b>20.89</b>	Horizontal	Pass
	1907.6	19.03	Vertical	Pass

Radiated Power (E.I.R.P) for UMTS band V				
Mode	Frequency	Result		Conclusion
		Max. Peak E.I.R.P.(dBm)	Polarization Of Max. E.I.R.P.	
RMC 12.2kbps	826.4	20.67	Horizontal	Pass
	826.4	19.85	Vertical	Pass
	835.0	21.23	Horizontal	Pass
	835.0	20.45	Vertical	Pass
	846.6	<b>21.89</b>	Horizontal	Pass
	846.6	20.67	Vertical	Pass

NOTE 1: in the part, result the worst case GPRS 1slot for GSM 850 and PCS1900, and RMC 12.2kbps for UMTS band II and band V.

## 6. SPURIOUS EMISSION

### 6.1 CONDUCTED SPURIOUS EMISSION

#### 6.1.1 MEASUREMENT METHOD

The following steps outline the procedure used to measure the conducted emissions from the EUT.

1, Determine frequency range for measurements: From CFR 2.1057 the spectrum should be investigated from the lowest radio frequency generated in the equipment up to at least the 10th harmonic of the carrier frequency. For the equipment of PCS1900 band, this equates to a frequency range of 30 MHz to 19.1 GHz, data taken from 30 MHz to 20 GHz. For GSM850, data taken from 30 MHz to 9 GHz.

2, Determine EUT transmit frequencies: the following typical channels were chosen to conducted emissions testing.

<b>Typical Channels for testing of GSM/GPRS/EDGE 850 MHz</b>	
Channel	Frequency (MHz)
128	824.2
190	836.6
251	848.8

<b>Typical Channels for testing of PCS/ GPRS/EDGE 1900 MHz</b>	
Channel	Frequency (MHz)
512	1850.2
661	1880.0
810	1909.8

<b>Typical Channels for testing of UMTS band II</b>	
Channel	Frequency (MHz)
9262	1852.4
9400	1880
9538	1907.6

<b>Typical Channels for testing of UMTS band V</b>	
Channel	Frequency (MHz)
4132	826.4
4175	835.0
4233	846.6

### **6.1.2 PROVISIONS APPLICABLE**

On any frequency outside frequency band of the USPCS spectrum, the power of any emission shall be attenuated below the transmitter power (P, in Watts) by at least  $43+10\log(P)$  dB. For all power levels +30 dBm to 0 dBm, this becomes a constant specification limit of -13 dBm.

### **6.1.3 MEASUREMENT RESULT**

**PLEASE REFER TO : APPENDIX I TEST PLOTS FOR CONDUCTED SPURIOUS EMISSION**

- Note:**
1. Below 30MHZ no Spurious found and The GSM modes is the worst condition.
  2. As no emission found in standby or receive mode, no recording in this report.



## 6.2 Radiated Spurious Emission

### 6.2.1 MEASUREMENT METHOD

The measurements procedures specified in TIA-603C-2004 were used for testing. The spectrum was scanned from 30 MHz to the 10th harmonic of the highest frequency generated within the equipment. The resolution bandwidth is set 1MHz as outlined in Part 24.238. The measurements were performed on all modes(GPRS850, GPRS1900, HSDPA band II, HSDPA band V) at 3 typical channels(the Top Channel, the Middle Channel and the Bottom Channel) for each band.

The procedure of radiated spurious emissions is as follows:

a) Pre-calibration With pre-calibration method, the Radiated Spurious Emissions(RSE) is calculated as,  $RSE = Rx \text{ (dBuV)} + CL \text{ (dB)} + SA \text{ (dB)} + Gain \text{ (dBi)} - 107 \text{ (dBuV to dBm)}$  The SA is calibrated using following setup.

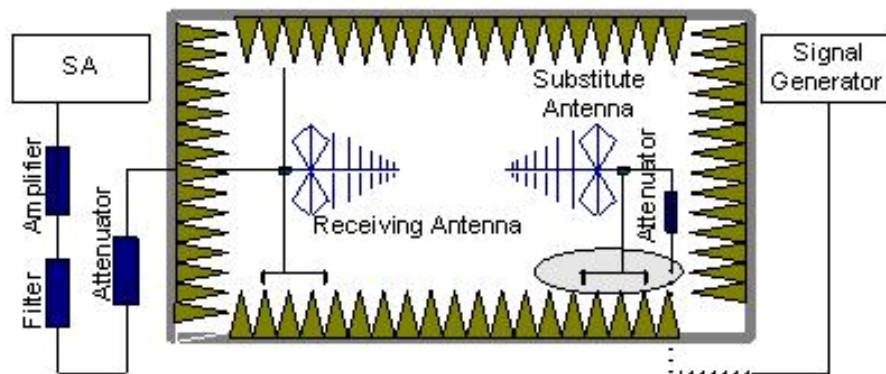

b) EUT was placed on a 0.8 meter high non-conductive stand at a 3 meter test distance from the receive antenna. A receiving antenna was placed on the antenna mast 3 meters from the test item for emission measurements. The height of receiving antenna is 0.8m. The test setup refers to figure below. Detected emissions were maximized at each frequency by rotating the test item and adjusting the receiving antenna polarization. The radiated emission measurements of all non-harmonic and harmonics of the transmit frequency through the 10th harmonic were measured with peak detector and 1MHz bandwidth.

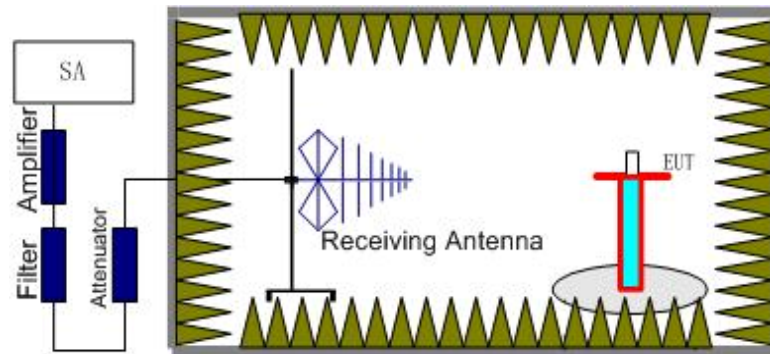

Radiated emissions measurements were made only at the upper, middle, and lower carrier frequencies of the PCS 1900 band (1850.2 MHz, 1880 MHz and 1909.8 MHz), GSM850 band (824.2MHz, 836.6MHz, 848.8MHz), UMTS band II(1852.4MHz, 1880MHz, 1907.6MHz), UMTS band V(826.4MHz, 835.0MHz, 846.6MHz). It was decided that measurements at these three carrier frequencies would be sufficient to demonstrate compliance with emissions limits because it was seen that all the significant spurs occur well outside the band and no radiation was seen from a carrier in one block of any band into any of the other blocks.

The substitution method is used. Substitution values at each frequency are measured before and saved to the test software. A "reference path loss" is established and the  $A_{Rpl}$  is the attenuation of "reference path loss", and including the gain of receive antenna, the gain of the preamplifier, the cable loss and the air loss. The measurement results are obtained as described below:  $Power = P_{Mea} + A_{Rpl}$

### 6.2.2 PROVISIONS APPLICABLE

(a) On any frequency outside a licensee's frequency block (e.g. A, D, B, etc.) within the USPCS spectrum, the power of any emission shall be attenuated below the transmitter power ( $P$ , in Watts) by at least  $43 + 10 \log(P)$  dB. The specification that emissions shall be attenuated below the transmitter power ( $P$ ) by at least  $43 + 10 \log(P)$  dB, translates in the relevant power range (1 to 0.001 W) to -13 dBm. At 1 W the specified minimum attenuation becomes 43 dB and relative to a 30 dBm (1 W) carrier becomes a limit of -13 dBm. At 0.001 W (0 dBm) the minimum attenuation is 13 dB, which again yields a limit of -13 dBm. In this way a translation of the specification from relative to absolute terms is carried out.

**Note:** only result the worst condition of each test mode:

### 6.2.3 MEASUREMENT RESULT

GSM 850:

The Worst Test Results for Channel 251/848.8 MHz					
Frequency(MHz)	Power(dBm)	ARpl (dBm)	P <sub>Mea</sub> (dBm)	Limit (dBm)	Polarity
1365.23	-36.28	-4.97	-41.26	-13.00	Horizontal
1365.23	-37.25	-4.97	-42.22	-13.00	Vertical
2230.45	-36.25	-2.10	-38.36	-13.00	Vertical
2230.45	-38.18	-2.10	-40.28	-13.00	Horizontal
3641.32	-36.38	3.69	-32.70	-13.00	Vertical
3641.32	-37.44	3.69	-33.75	-13.00	Horizontal
4563.58	-38.67	2.92	-35.75	-13.00	Horizontal
4563.58	-40.24	2.92	-37.32	-13.00	Vertical

PCS 1900:

The Worst Test Results for Channel 810/1909.8MHz					
Frequency(MHz)	Power(dBm)	ARpl (dBm)	P <sub>Mea</sub> (dBm)	Limit (dBm)	Polarity
1429.36	-36.05	9.9	-26.15	-13.00	Vertical
1429.36	-38.45	9.9	-28.55	-13.00	Horizontal
2341.66	-32.40	11.8	-20.6	-13.00	Vertical
2341.66	-35.56	11.8	-23.76	-13.00	Horizontal
5530.42	-41.26	15.0	-26.26	-13.00	Horizontal
5530.42	-43.43	15.0	-28.43	-13.00	Vertical
7512.46	-36.93	14.9	-22.03	-13.00	Vertical
7512.46	-38.45	14.9	-23.55	-13.00	Horizontal
9656.23	-37.80	18.7	-19.1	-13.00	Horizontal
9656.23	-40.40	18.7	-21.7	-13.00	Vertical

UMTS band II:

The Worst Test Results for Channel 9538/1907.6MHz					
Frequency(MHz)	Power(dBm)	A <sub>Rpl</sub> (dBm)	P <sub>Mea</sub> (dBm)	Limit (dBm)	Polarity
1536.98	-38.94	7.25	-31.69	-13.00	Vertical
2536.41	-40.40	8.24	-32.16	-13.00	Horizontal
3786.52	-45.51	10.87	-34.64	-13.00	Horizontal
5123.56	-38.03	8.52	-29.51	-13.00	Vertical
6615.32	-56.36	18.7	-37.66	-13.00	Horizontal

UMTS band V:

The Worst Test Results for Channel 4233/846.6MHz					
Frequency(MHz)	Power(dBm)	A <sub>Rpl</sub> (dBm)	P <sub>Mea</sub> (dBm)	Limit (dBm)	Polarity
1591.32	-41.09	9.6	-31.49	-13.00	Vertical
1591.32	-43.12	9.6	-33.52	-13.00	Horizontal
2378.91	-37.89	8.91	-28.98	-13.00	Horizontal
2378.91	-39.98	8.91	-31.07	-13.00	Vertical
4960.24	-37.56	12.3	-25.26	-13.00	Horizontal
4960.24	-40.09	12.3	-27.79	-13.00	Vertical
6455.54	-36.57	15.0	-21.57	-13.00	Vertical
6455.54	-38.98	15.0	-23.98	-13.00	Horizontal
7897.71	-41.32	18.7	-22.62	-13.00	Horizontal
7897.71	-43.19	18.7	-24.49	-13.00	Vertical

**Note:** Below 30MHZ no Spurious found and The GPRS/EDGE modes is the worst condition.

## 7. FREQUENCY STABILITY

### 7.1 MEASUREMENT METHOD

In order to measure the carrier frequency under the condition of AFC lock, it is necessary to make measurements with the EUT in a "call mode". This is accomplished with the use of R&S CMU200 DIGITAL RADIO COMMUNICATION TESTER.

- 1 , Measure the carrier frequency at room temperature.
- 2 , Subject the EUT to overnight soak at -10°C.
- 3 , With the EUT, powered via nominal voltage, connected to the CMU200 and in a simulated call on channel 661 for PCS 1900 band , channel 190 for GSM 850 band, channel 9400 for UMTS band II and channel 4175 for UMTS band V measure the carrier frequency. These measurements should be made within 2 minutes of Powering up the EUT, to prevent significant self-warming.
- 4 , Repeat the above measurements at 10°C increments from -10°C to +50°C. Allow at least 1 1/2 hours at each temperature, unpowered, before making measurements.
- 5 , Re-measure carrier frequency at room temperature with nominal voltage. Vary supply voltage from minimum voltage to maximum voltage, in 0.1Volt increments re-measuring carrier frequency at each voltage. Pause at nominal voltage for 1 1/2 hours unpowered, to allow any self-heating to stabilize, before continuing.
- 6 , Subject the EUT to overnight soak at +50°C.
- 7 , With the EUT, powered via nominal voltage, connected to the CMU200 and in a simulated call on the centre channel, measure the carrier frequency. These measurements should be made within 2 minutes of Powering up the EUT, to prevent significant self-warming.
- 8 , Repeat the above measurements at 10°C increments from +50°C to -10°C. Allow at least 1 1/2 hours at each temperature, unpowered, before making measurements.
- 9 , At all temperature levels hold the temperature to +/- 0.5°C during the measurement procedure.

### 7.2 PROVISIONS APPLICABLE

#### 7.2.1 For Hand carried battery powered equipment

According to the JTC standard the frequency stability of the carrier shall be accurate to within 0.1 ppm of the received frequency from the base station. This accuracy is sufficient to meet Sec. 24.235, Frequency Stability. The frequency stability shall be sufficient to ensure that the fundamental emission stays within the authorized frequency block. As this transceiver is considered "Hand carried, battery powered equipment" Section 2.1055(d)(2) applies. This requires that the lower voltage for frequency stability testing be specified by the manufacturer. This transceiver is specified to operate with an input voltage of between 3.4VDC and 4.2VDC, with a nominal voltage of 3.7VDC. Operation above or below these voltage limits is prohibited by transceiver software in order to prevent improper operation as well as to protect components from overstress. These voltages represent a tolerance of -10 % and +12.5 %. For the purposes of measuring frequency stability these voltage limits are to be used.

### 7.2.2 For equipment powered by primary supply voltage

According to the JTC standard the frequency stability of the carrier shall be accurate to within 0.1 ppm of the received frequency from the base station. This accuracy is sufficient to meet Sec. 24.235, Frequency Stability. The frequency stability shall be sufficient to ensure that the fundamental emission stays within the authorized frequency block. For this EUT section 2.1055(d)(1) applies. This requires varying primary supply voltage from 85 to 115 percent of the nominal value for other than hand carried battery equipment, the normal environment temperature is 20°C.

### 7.3 MEASUREMENT RESULT

Frequency Error Against Voltage for GSM850 band		
Voltage(V)	Frequency error(Hz)	Frequency error(ppm)
3.4	29	0.035
3.7	24	0.029
4.2	31	0.037

Frequency Error Against Temperature for GSM850 band		
temperature(°C)	Frequency error(Hz)	Frequency error(ppm)
-10	41	0.049
0	32	0.038
10	29	0.035
20	26	0.031
30	31	0.037
40	28	0.033
50	61	0.073

Frequency Error Against Voltage for GPRS850 band		
Voltage(V)	Frequency error(Hz)	Frequency error(ppm)
3.4	28	0.033
3.7	23	0.028
4.2	27	0.032

Frequency Error Against Temperature for GPRS850 band		
temperature(°C)	Frequency error(Hz)	Frequency error(ppm)
-10	42	0.050
0	33	0.039
10	27	0.032
20	27	0.032
30	30	0.036
40	35	0.042
50	41	0.049

Frequency Error Against Voltage for EGPRS850 band		
Voltage(V)	Frequency error(Hz)	Frequency error(ppm)
3.4	37	0.044
3.7	35	0.042
4.2	31	0.037

Frequency Error Against Temperature for EGPRS850 band		
temperature(°C)	Frequency error(Hz)	Frequency error(ppm)
-10	38	0.045
0	35	0.042
10	29	0.035
20	27	0.032
30	34	0.041
40	29	0.035
50	41	0.049

Note: The EUT doesn't work below -10°C

Frequency Error Against Voltage for GSM1900 band		
Voltage(V)	Frequency error(Hz)	Frequency error(ppm)
3.4	45	0.024
3.7	43	0.023
4.2	66	0.035

Frequency Error Against Temperature for GPRS1900 band		
temperature(°C)	Frequency error(Hz)	Frequency error(ppm)
-10	58	0.031
0	54	0.029
10	47	0.025
20	45	0.024
30	39	0.021
40	41	0.022
50	38	0.020

Frequency Error Against Voltage for GPRS1900 band		
Voltage(V)	Frequency error(Hz)	Frequency error(ppm)
3.4	41	0.022
3.7	41	0.022
4.2	62	0.033

Frequency Error Against Temperature for GPRS1900 band		
temperature(°C)	Frequency error(Hz)	Frequency error(ppm)
-10	61	0.032
0	52	0.028
10	43	0.023
20	42	0.022
30	36	0.019
40	44	0.023
50	39	0.021

Frequency Error Against Voltage for EDGE1900 band		
Voltage(V)	Frequency error(Hz)	Frequency error(ppm)
3.4	44	0.023
3.7	37	0.020
4.2	48	0.026

Frequency Error Against Temperature for EDGE1900 band		
temperature(°C)	Frequency error(Hz)	Frequency error(ppm)
-10	55	0.029
0	47	0.025
10	36	0.019
20	32	0.017
30	37	0.020
40	45	0.024
50	51	0.027



Frequency Error Against Voltage for UMTS band II		
Voltage(V)	Frequency error(Hz)	Frequency error(ppm)
3.4	46	0.024
3.7	39	0.021
4.2	48	0.026

Frequency Error Against Temperature for UMTS band II		
temperature(°C)	Frequency error(Hz)	Frequency error(ppm)
-10	67	0.036
0	52	0.028
10	47	0.025
20	46	0.024
30	38	0.020
40	41	0.022
50	50	0.027

Frequency Error Against Voltage for UMTS band V		
Voltage(V)	Frequency error(Hz)	Frequency error(ppm)
3.4	37	0.044
3.7	28	0.034
4.2	30	0.036

Frequency Error Against Temperature for UMTS band V		
temperature(°C)	Frequency error(Hz)	Frequency error(ppm)
-10	49	0.059
0	42	0.050
10	39	0.047
20	29	0.035
30	29	0.035
40	31	0.037
50	40	0.048

**Note:** The EUT doesn't work below -10°C

## 8. OCCUPIED BANDWIDTH

### 8.1 MEASUREMENT METHOD

The test set up and general procedure is similar to conducted peak output power test. Only different for setting the measurement configuration of the measuring instrument of Spectrum Analyzer.

### 8.2 PROVISIONS APPLICABLE

The occupied bandwidth (99%) shall not exceed 300 KHz.

### 8.3 MEASUREMENT RESULT

<b>Occupied Bandwidth (99%) for GSM 850 band</b>		
Mode	Frequency(MHz)	Occupied Bandwidth (99%)( kHz)
Low Channel	824.2	247.85
Middle Channel	836.6	246.22
High Channel	848.8	245.21

<b>Occupied Bandwidth (99%) for GPRS 850 band</b>		
Mode	Frequency(MHz)	Occupied Bandwidth (99%)( kHz)
Low Channel	824.2	245.43
Middle Channel	836.6	242.32
High Channel	848.8	243.11

<b>Occupied Bandwidth (99%) for EGPRS 850 band</b>		
Mode	Frequency(MHz)	Occupied Bandwidth (99%)( kHz)
Low Channel	824.2	245.42
Middle Channel	836.6	242.31
High Channel	848.8	243.10

<b>Occupied Bandwidth (99%) for GSM1900 band</b>		
Mode	Frequency(MHz)	Occupied Bandwidth (99%)( kHz)
Low Channel	1850.2	249.36
Middle Channel	1880.0	248.34
High Channel	1909.8	247.56

<b>Occupied Bandwidth (99%) for GPRS1900 band</b>		
Mode	Frequency(MHz)	Occupied Bandwidth (99%)( kHz)
Low Channel	1850.2	249.24
Middle Channel	1880.0	248.11
High Channel	1909.8	247.15

<b>Occupied Bandwidth (99%) for EDGE1900 band</b>		
Mode	Frequency(MHz)	Occupied Bandwidth (99%)( kHz)
Low Channel	1850.2	243.43
Middle Channel	1880.0	248.12
High Channel	1909.8	245.09

<b>Occupied Bandwidth (99%) for UMTS band II</b>		
Mode	Frequency(MHz)	Occupied Bandwidth (99%)( MHz)
Low Channel	1852.4	4.18
Middle Channel	1880	4.15
High Channel	1907.6	4.17

<b>Occupied Bandwidth (99%) for UMTS band V</b>		
Mode	Frequency(MHz)	Occupied Bandwidth (99%)( MHz)
Low Channel	826.4	4.19
Middle Channel	835.0	4.18
High Channel	846.6	4.21

## 9. EMISSION BANDWIDTH

### 9.1 MEASUREMENT METHOD

The test set up and general procedure is similar to conducted peak output power test. Only different for setting the measurement configuration of the measuring instrument of Spectrum Analyzer.

### 9.2 PROVISIONS APPLICABLE

The emission bandwidth is defined as two points, one below the carrier center frequency and one above the carrier center frequency, outside of which all emissions are attenuated at least 26dB below the transmitter power

### 9.3 MEASUREMENT RESULT

<b>Emission Bandwidth (-26dBc) for GSM850 band</b>		
Mode	Frequency(MHz)	Emission Bandwidth (-26dBc)( kHz)
Low Channel	824.2	321.93
Middle Channel	836.6	312.82
High Channel	848.8	311.23

<b>Emission Bandwidth (-26dBc) for GPRS850 band</b>		
Mode	Frequency(MHz)	Emission Bandwidth (-26dBc)( kHz)
Low Channel	824.2	321.87
Middle Channel	836.6	312.56
High Channel	848.8	311.87

<b>Emission Bandwidth (-26dBc) for EDGE850 band</b>		
Mode	Frequency(MHz)	Emission Bandwidth (-26dBc)( kHz)
Low Channel	824.2	311.34
Middle Channel	836.6	310.67
High Channel	848.8	309.22

<b>Emission Bandwidth (-26dBc) for GSM1900 band</b>		
Mode	Frequency(MHz)	Emission Bandwidth (-26dBc)( kHz)
Low Channel	1850.2	309.77
Middle Channel	1880.0	313.61
High Channel	1909.8	309.34

<b>Emission Bandwidth (-26dBc) for GPRS1900 band</b>		
Mode	Frequency(MHz)	Emission Bandwidth (-26dBc)( kHz)
Low Channel	1850.2	309.19
Middle Channel	1880.0	313.32
High Channel	1909.8	309.10

<b>Emission Bandwidth (-26dBc) for EDGE1900 band</b>		
Mode	Frequency(MHz)	Emission Bandwidth (-26dBc)( kHz)
Low Channel	1850.2	312.09
Middle Channel	1880.0	313.31
High Channel	1909.8	307.40

<b>Emission Bandwidth (-26dBc) for UMTS band II</b>		
Mode	Frequency(MHz)	Emission Bandwidth (-26dBc)( MHz)
Low Channel	1852.4	4.68
Middle Channel	1880.0	4.59
High Channel	1907.6	4.66

<b>Emission Bandwidth (-26dBc) for UMTS band V</b>		
Mode	Frequency(MHz)	Emission Bandwidth (-26dBc)( MHz)
Low Channel	826.4	4.66
Middle Channel	835.0	4.66
High Channel	846.6	4.68

## **10. BAND EDGE**

### **10.1 MEASUREMENT METHOD**

The test set up and general procedure is similar to conducted peak output power test. Only different for setting the measurement configuration of the measuring instrument of Spectrum Analyzer.

### **10.2 PROVISIONS APPLICABLE**

as Specified in FCC rules of 22.917(b) and 24.238(b)

### **10.3 MEASUREMENT RESULT**

Please refers to Appendix III for compliance test plots for band edges

## 11. Peak-to-Average Ratio

### 11.1 DESCRIPTION OF THE PAR MEASUREMENT

The peak-to-average ratio (PAR) of the transmission may not exceed 13 dB.

### 11.2 MEASURING INSTRUMENTS

See list of measuring instruments of this test report.

### 11.3 TEST PROCEDURES

1. The EUT was connected to Spectrum Analyzer and Base Station via power divider.
2. The RF output of EUT was connected to the spectrum analyzer by RF cable and attenuator. The path loss was compensated to the results for each measurement.
3. For GSM/EGPRS operating modes:
  - a. Set the RBW = 1MHz, VBW = 1MHz, Peak detector in spectrum analyzer.
  - b. Set EUT in maximum power output, and triggered the burst signal.
  - c. Measured respectively the Peak level and Mean level, and the deviation was recorded as Peak to Average Ratio.
4. For UMTS operating modes:
  - a. Set the CCDF (Complementary Cumulative Distribution Function) option in spectrum analyzer.
  - b. The highest RF powers were measured and recorded the maximum PAPR level associated with a probability of 0.1 %.

### 11.4 TEST SETUP

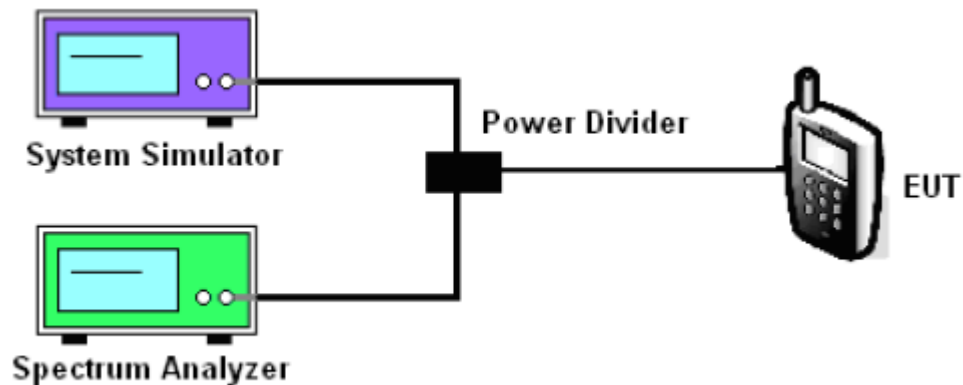

**11.5 TEST RESULT OF PEAK-TO-AVERAGE RATIO**

Cellular Band						
Modes	GSM850(GSM)			WCDMA Band V (RMC 12.2Kbps)		
Channel	129 (Low)	190 (Mid)	251 (High)	4132 (Low)	4175 (Mid)	4233 (High)
Frequency(MHz)	824.2	836.6	848.8	826.4	835.0	846.6
Peak-to-Average Ratio (dB)	0.03	0.02	0.03	3.32	2.92	3.36

Cellular Band						
Modes	GSM1900(GSM)			WCDMA Band II (RMC 12.2Kbps)		
Channel	512 (Low)	661 (Mid)	810 (High)	9262 (Low)	9400 (Mid)	9538 (High)
Frequency(MHz)	1850.2	1880	1909.8	1852.4	1880	1907.6
Peak-to-Average Ratio (dB)	0.02	0.01	0.01	3.52	3.48	3.40



### 11.6 TEST RESULT (PLOTS) OF PEAK-TO-AVERAGE RATIO

<b>Band :</b>	GSM 850	<b>Test Mode :</b>	GSM Link
---------------	---------	--------------------	----------

#### Peak-to-Average Ratio on Channel 129

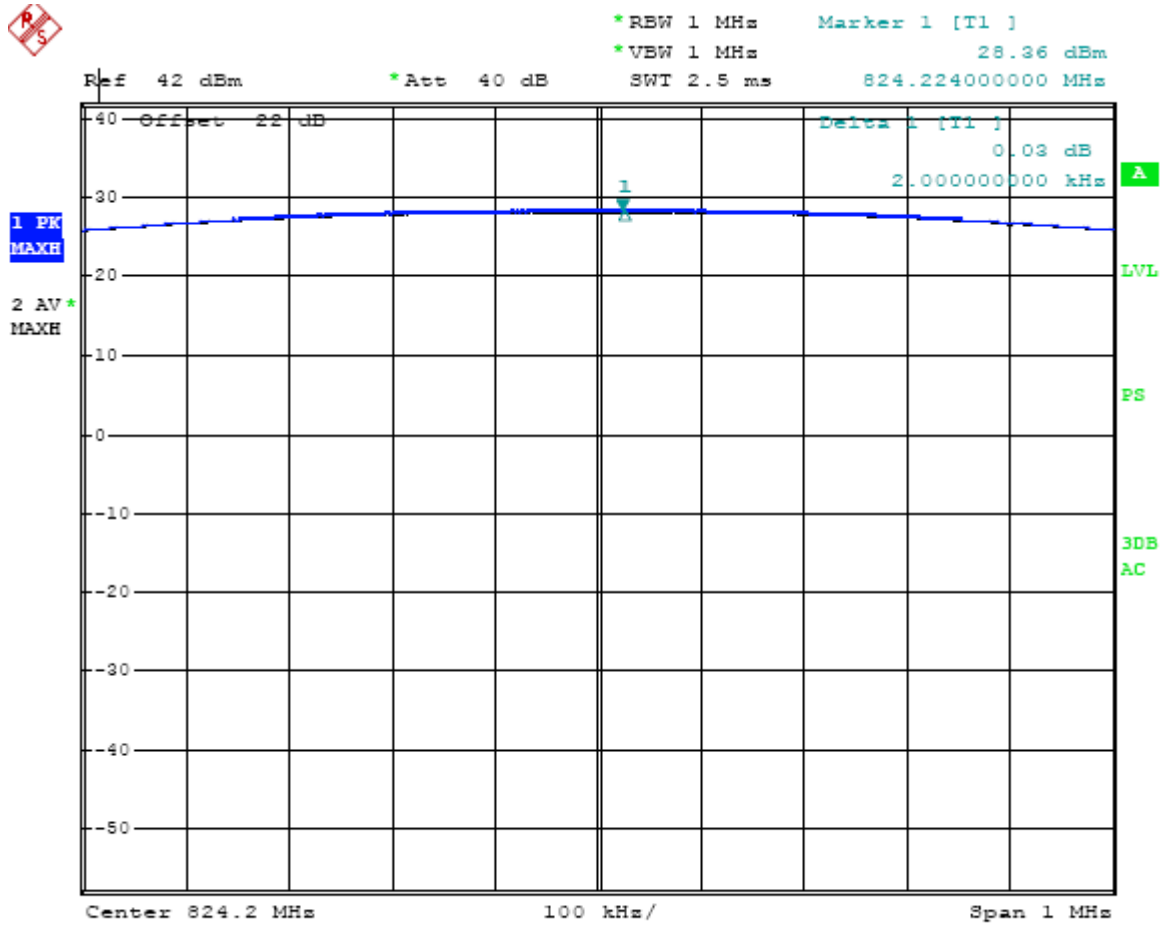

Peak-to-Average Ratio on Channel 190

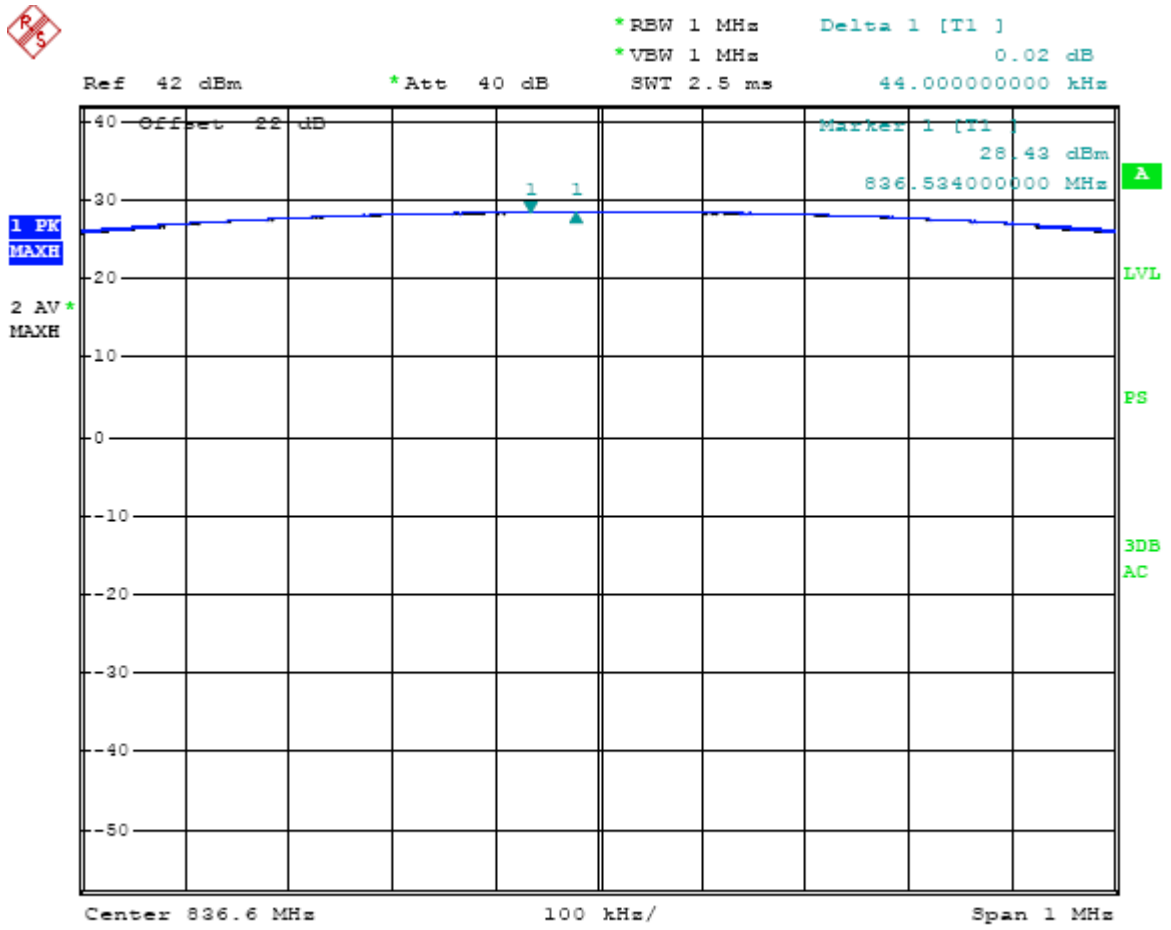

Peak-to-Average Ratio on Channel 251

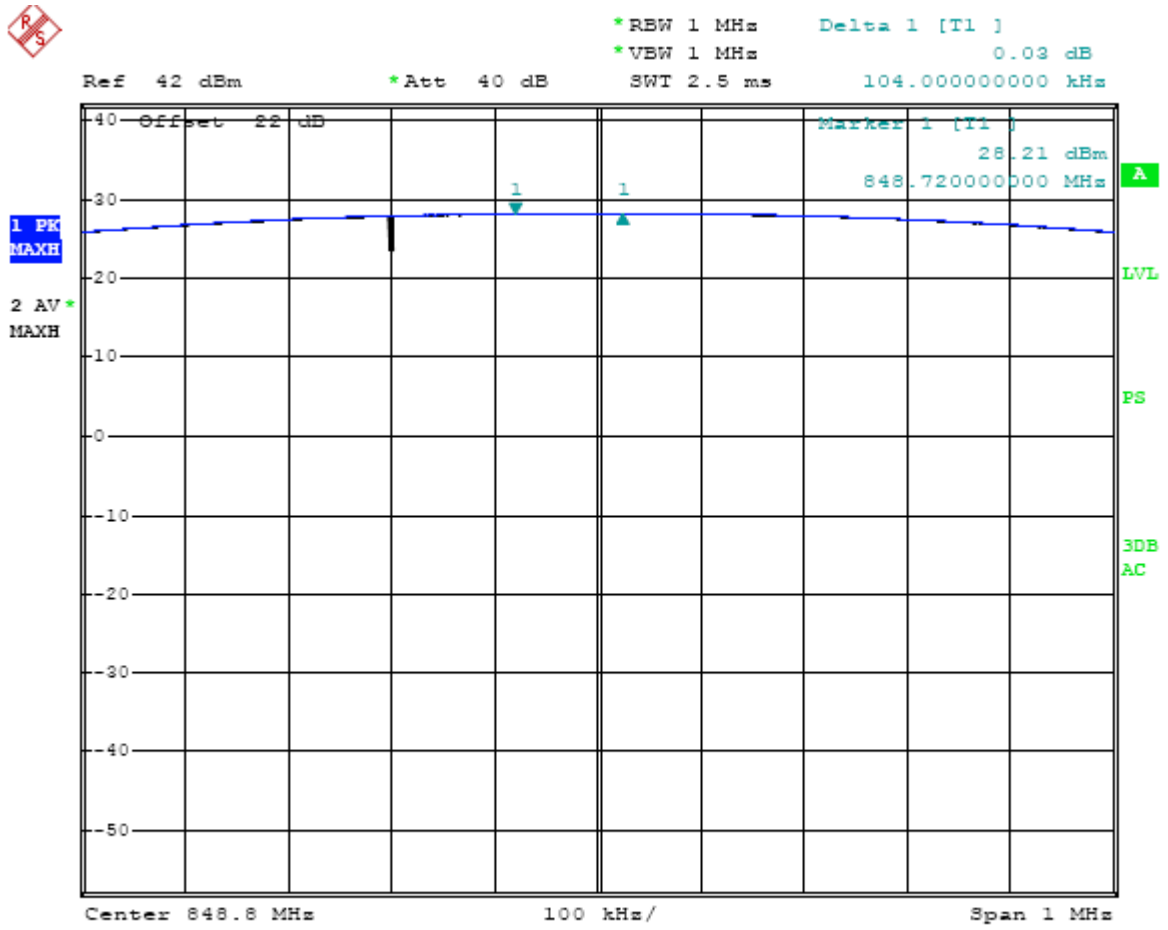

<b>Band :</b>	GSM 1900	<b>Test Mode :</b>	GSM Link
---------------	----------	--------------------	----------

**Peak-to-Average Ratio on Channel 512**

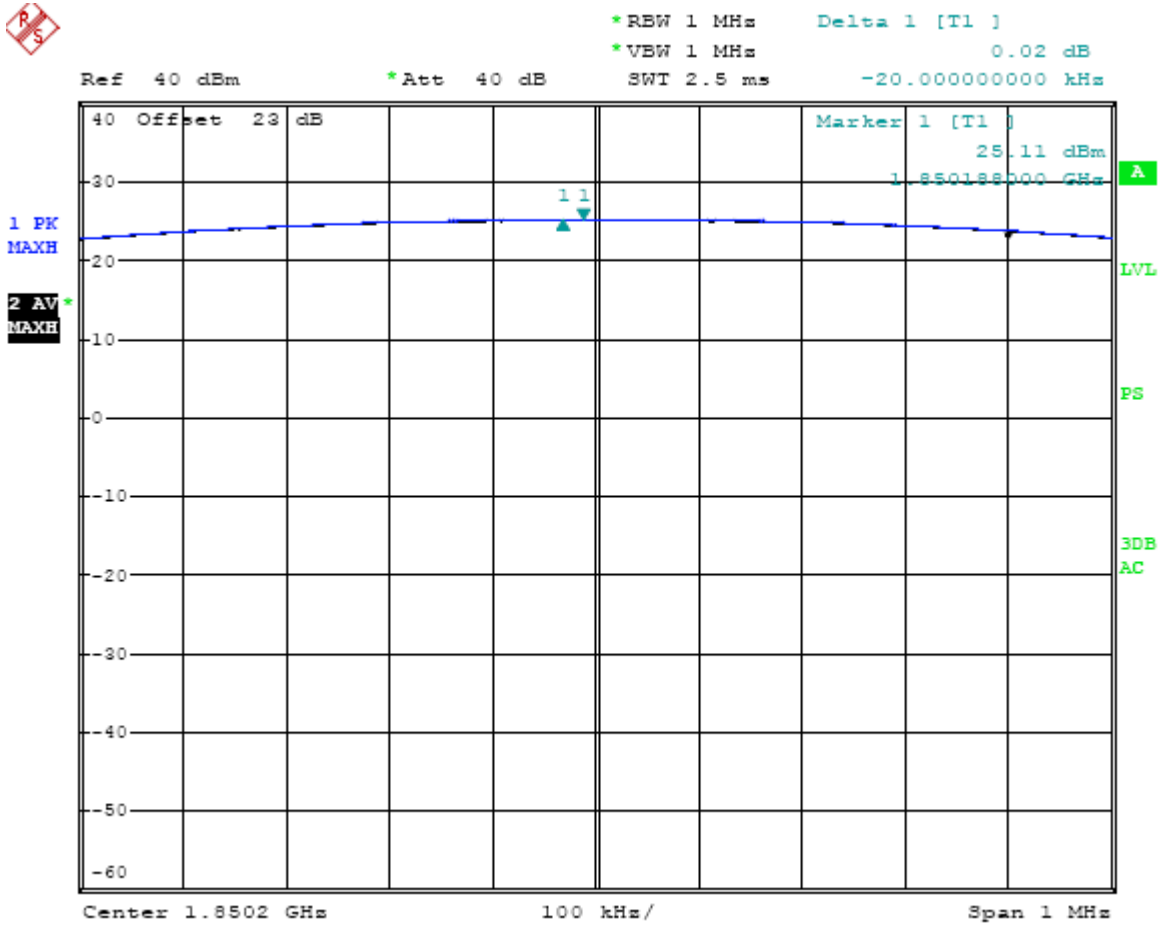

Peak-to-Average Ratio on Channel 661

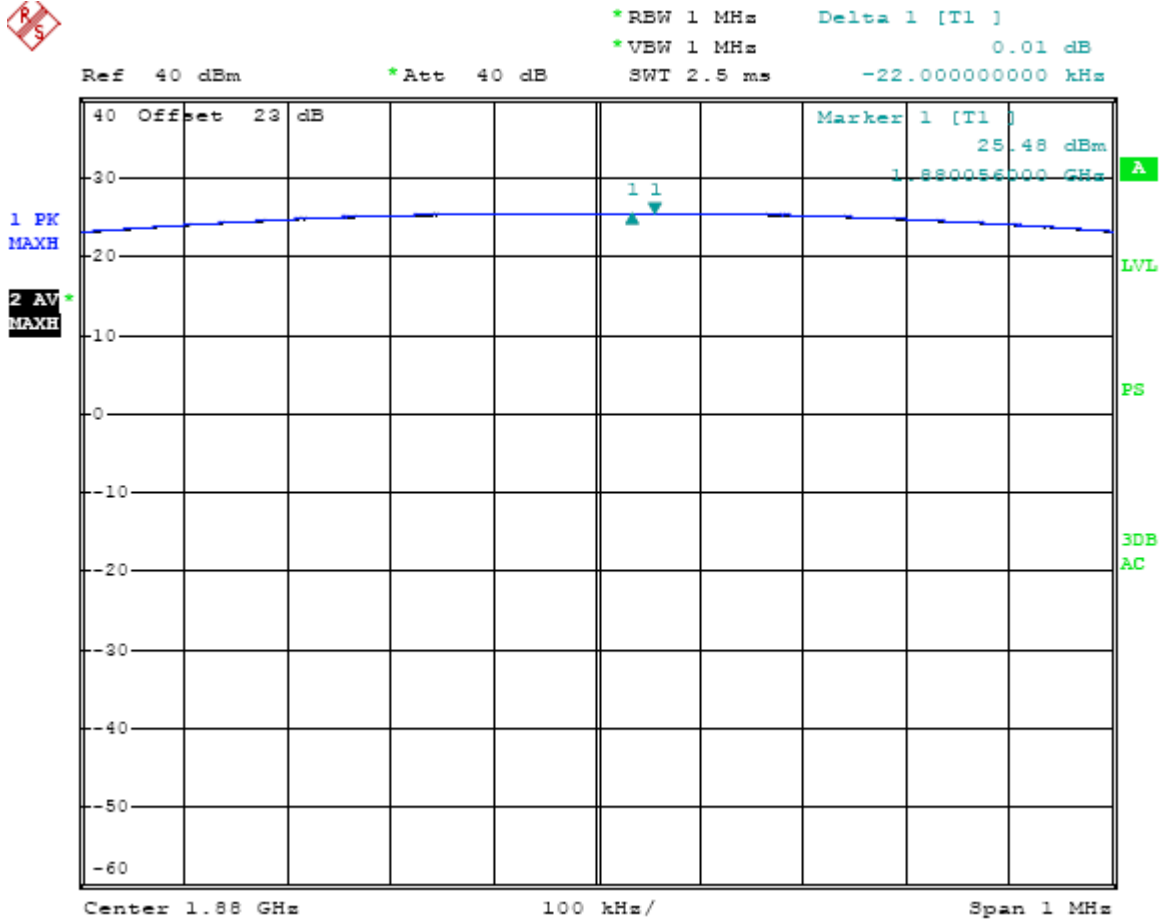

Peak-to-Average Ratio on Channel 810

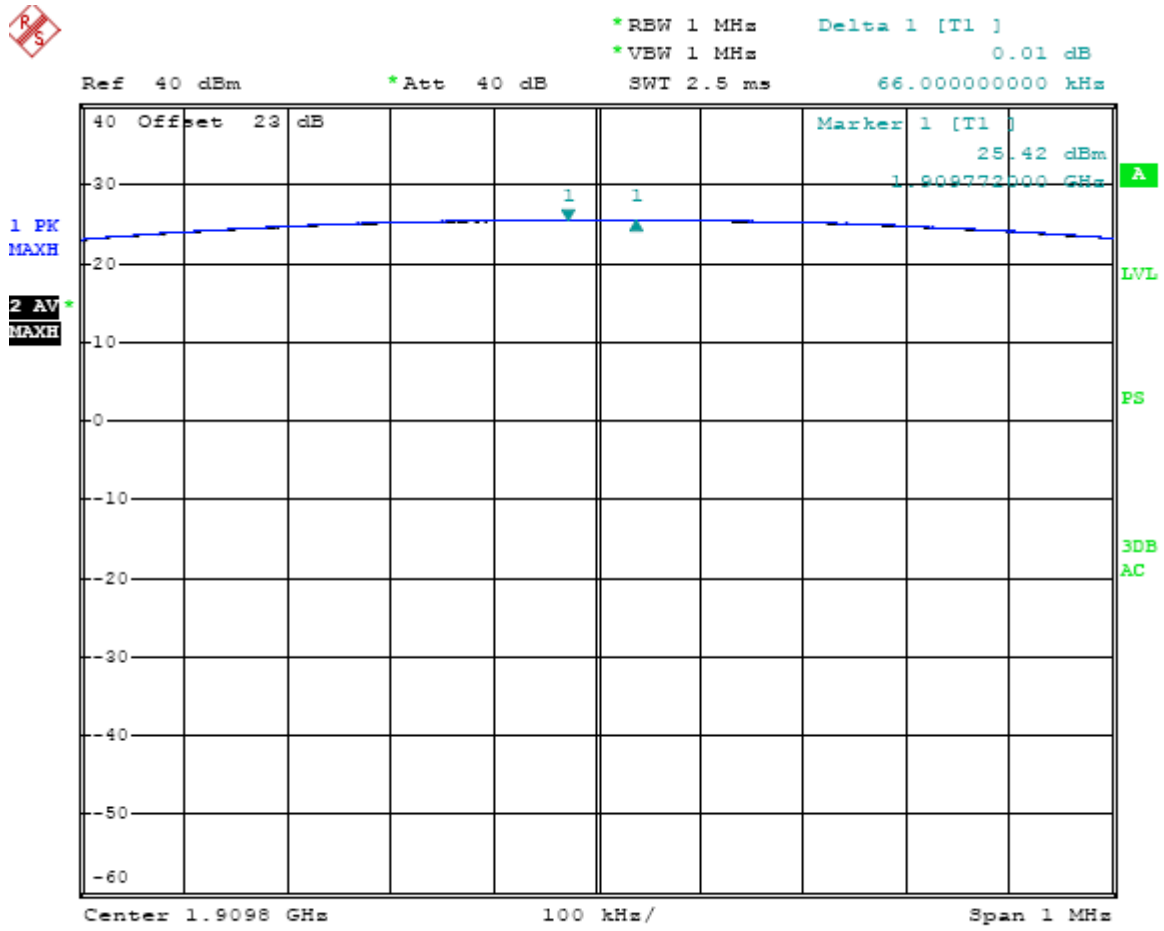

<b>Band :</b>	WCDMA Band V	<b>Test Mode :</b>	RMC 12.2Kbps Link
---------------	--------------	--------------------	-------------------

**Peak-to-Average Ratio on Channel 4132**

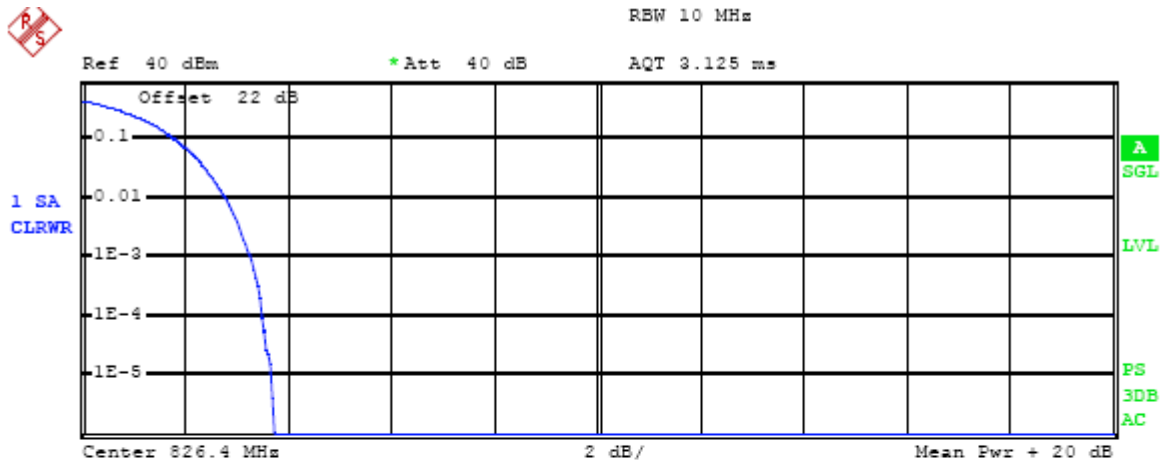

Complementary Cumulative Distribution Function (100000 samples)

Trace 1

Mean 19.06 dBm

Peak 22.79 dBm

Crest 3.73 dB

10 % 1.88 dB

1 % 2.84 dB

.1 % 3.32 dB

.01 % 3.52 dB

Peak-to-Average Ratio on Channel 4175

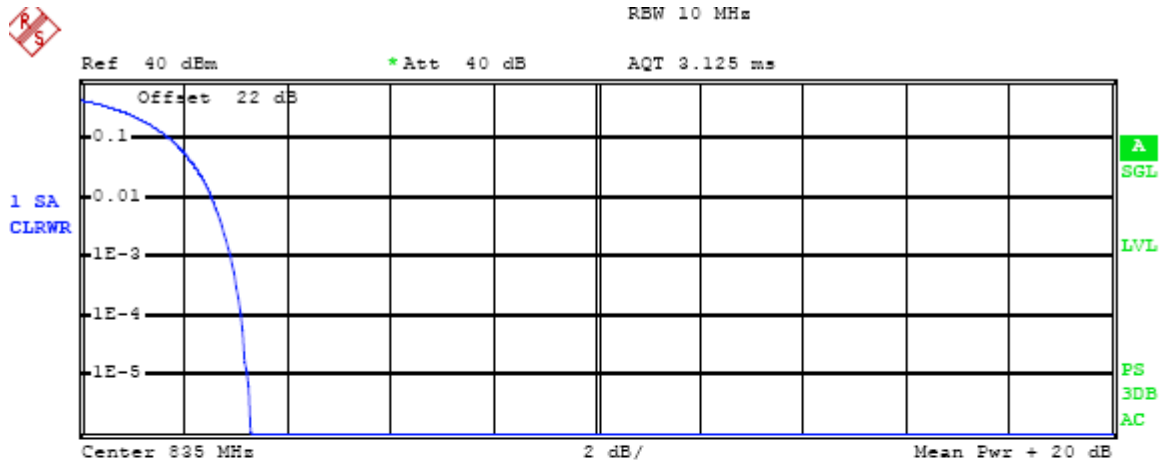

Complementary Cumulative Distribution Function (100000 samples)

Trace 1

Mean 18.84 dBm  
 Peak 22.16 dBm  
 Crest 3.32 dB

10 %	1.80 dB
1 %	2.56 dB
.1 %	2.92 dB
.01 %	3.12 dB



Peak-to-Average Ratio on Channel 4233

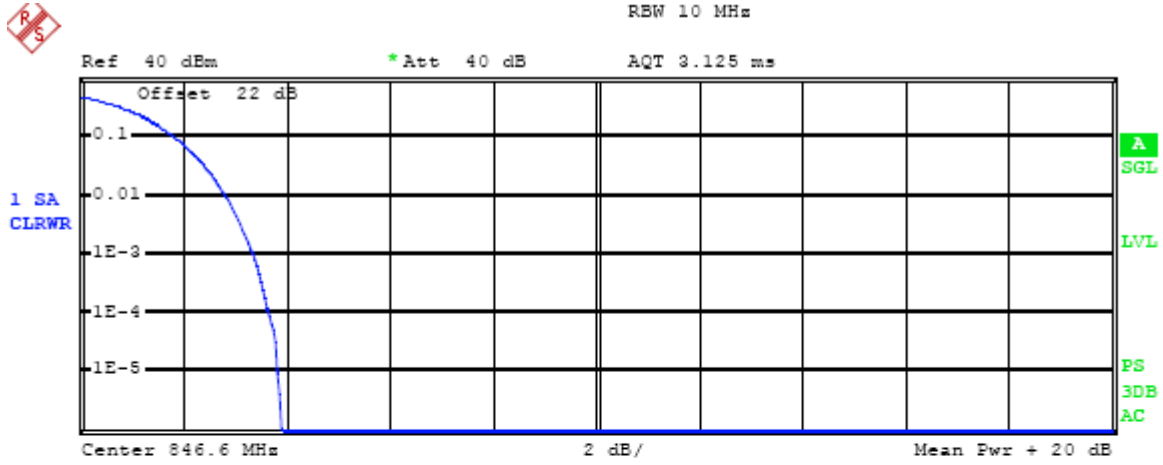

Complementary Cumulative Distribution Function (100000 samples)

Trace 1

Mean      18.53 dBm  
Peak      22.44 dBm  
Crest      3.90 dB

10 %      1.88 dB  
1 %      2.84 dB  
.1 %      3.36 dB  
.01 %      3.68 dB

<b>Band :</b>	WCDMA Band II	<b>Test Mode :</b>	RMC 12.2Kbps Link
---------------	---------------	--------------------	-------------------

**Peak-to-Average Ratio on Channel 9262**

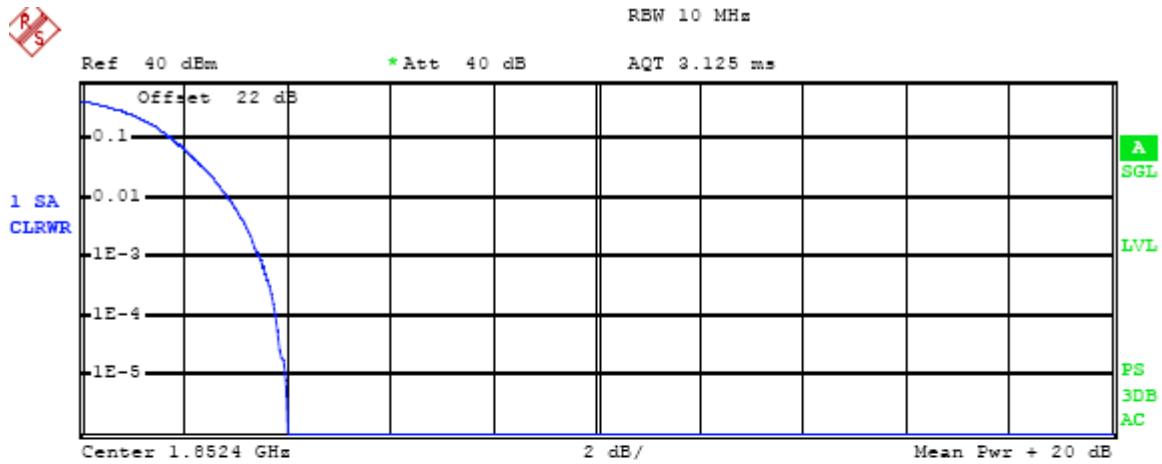

Complementary Cumulative Distribution Function (100000 samples)

Trace 1

Mean 18.42 dBm

Peak 22.44 dBm

Crest 4.02 dB

10 % 1.84 dB

1 % 2.92 dB

.1 % 3.52 dB

.01 % 3.80 dB

Peak-to-Average Ratio on Channel 9400

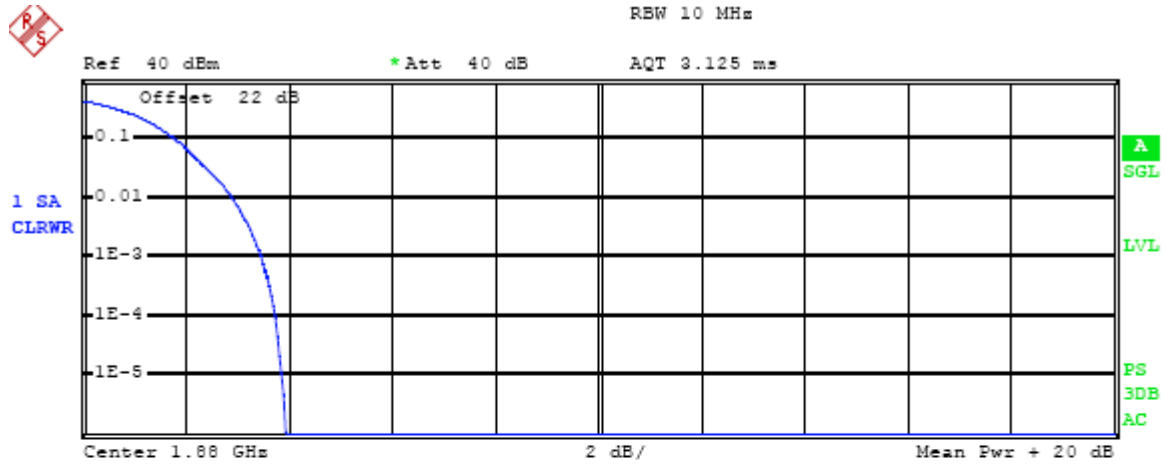

Complementary Cumulative Distribution Function (100000 samples)

Trace 1

Mean 18.84 dBm  
 Peak 22.79 dBm  
 Crest 3.95 dB

10 %	1.84 dB
1 %	2.96 dB
.1 %	3.48 dB
.01 %	3.76 dB

Peak-to-Average Ratio on Channel 9538

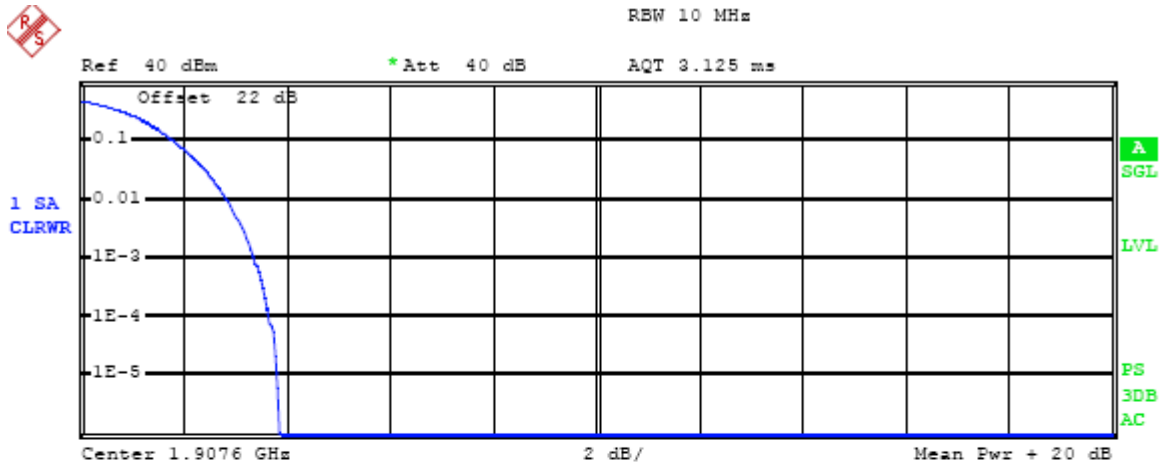

Complementary Cumulative Distribution Function (100000 samples)

Trace 1

Mean	18.63 dBm
Peak	22.51 dBm
Crest	3.88 dB
10 %	1.84 dB
1 %	2.88 dB
.1 %	3.40 dB
.01 %	3.68 dB

**APPENDIX I**

**TEST PLOTS FOR CONDUCTED SPURIOUS EMISSION**

CONDUCTED EMISSION IN GSM 850 BAND  
 Conducted Emission Transmitting Mode CH 128 30MHz – 1GHz

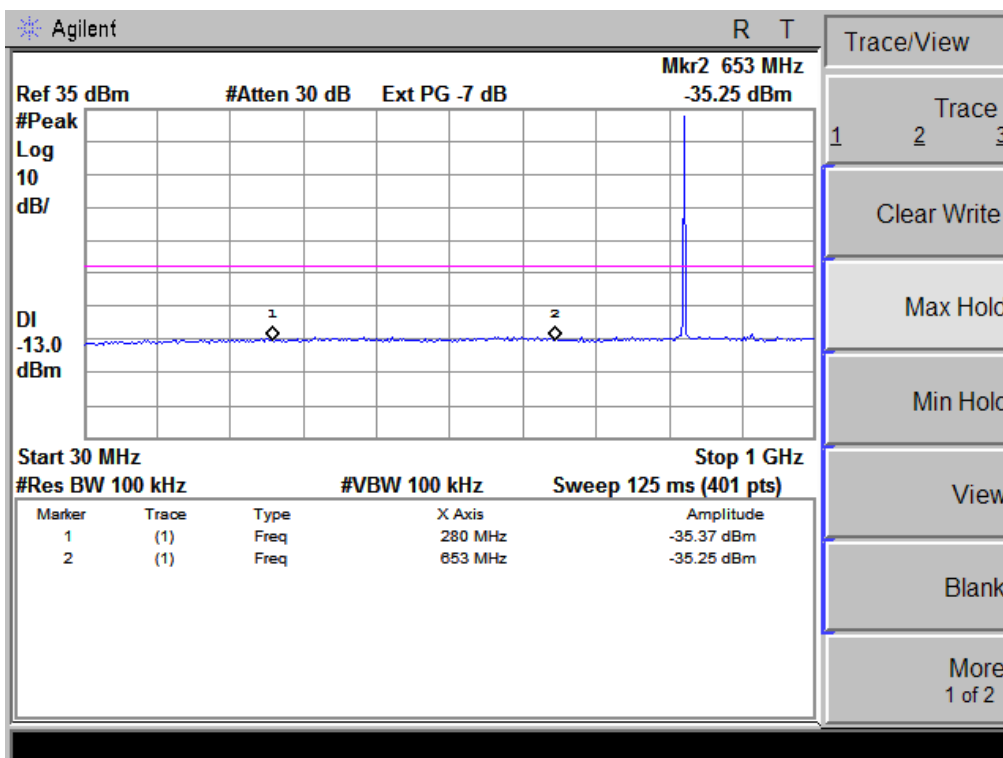

Conducted Emission Transmitting Mode CH 128 1GHz – 9GHz

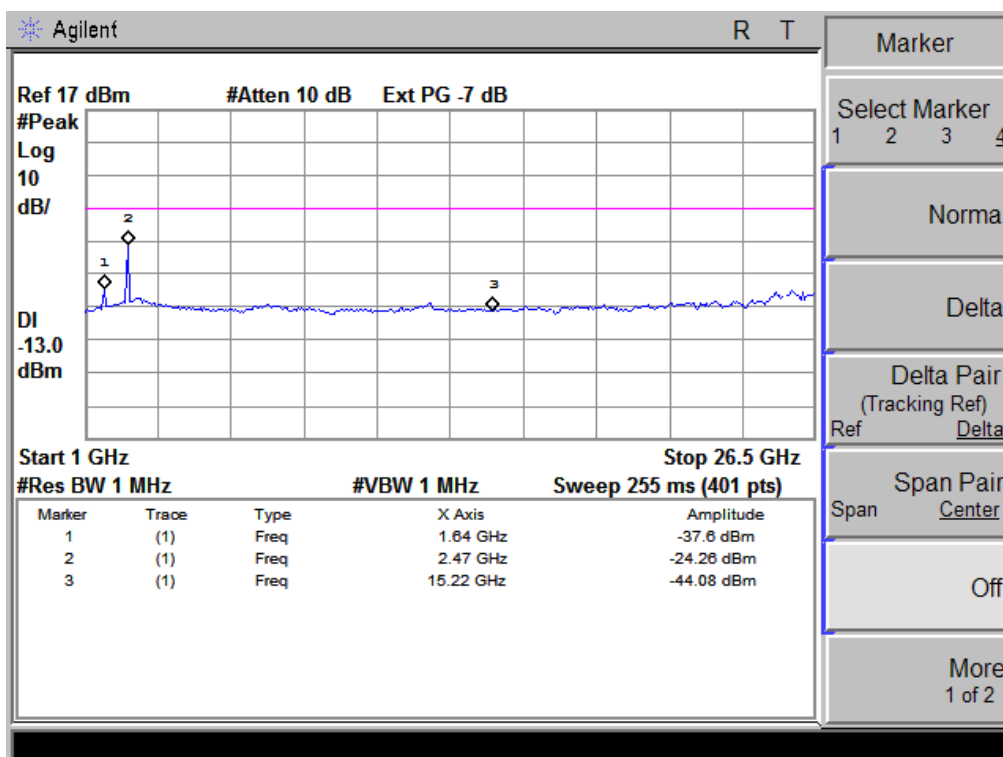

Conducted Emission Transmitting Mode CH 190 30MHz – 1GHz

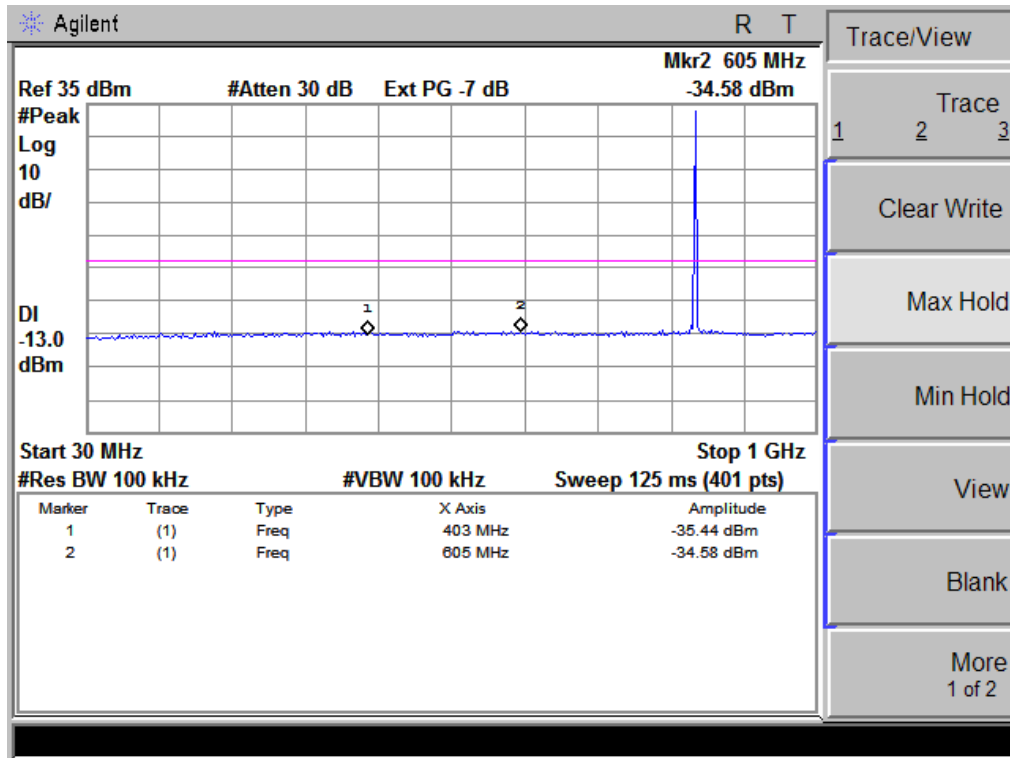

Conducted Emission Transmitting Mode CH 190 1GHz – 9GHz

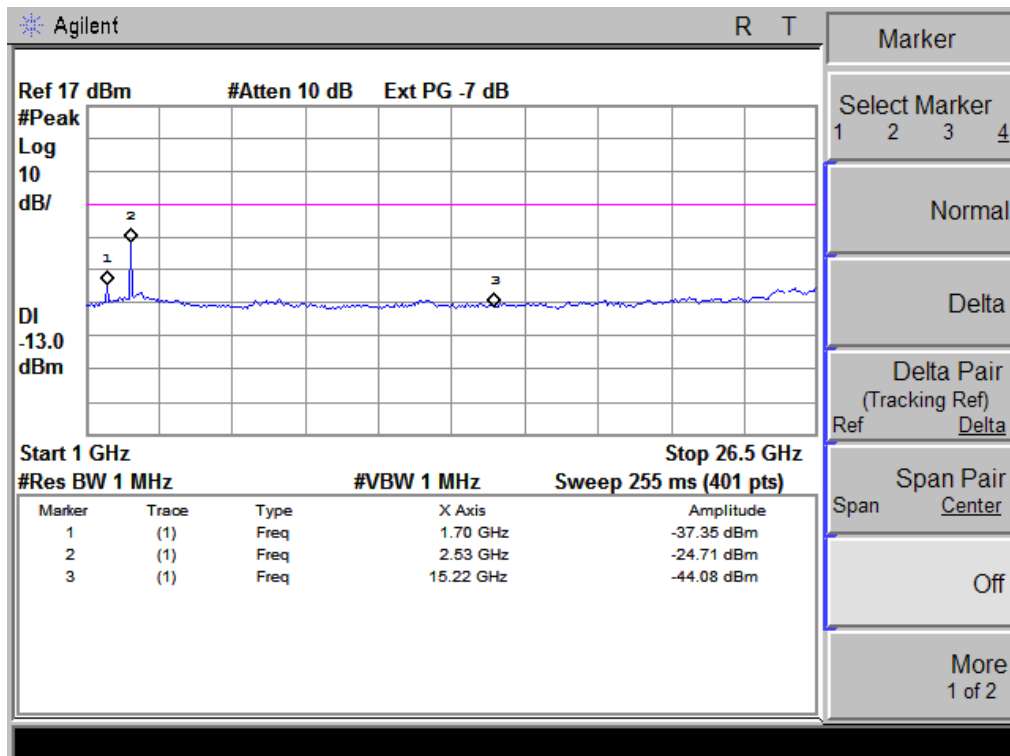

Conducted Emission Transmitting Mode CH 251 30MHz – 1GHz

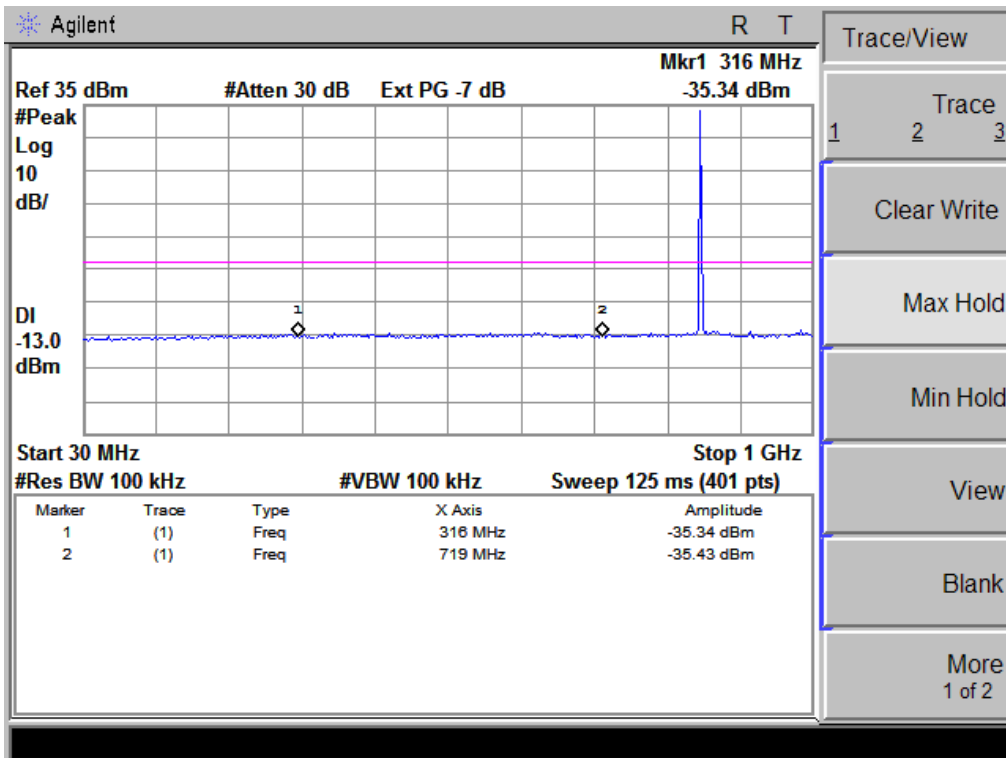

Conducted Emission Transmitting Mode CH 251 1GHz – 9GHz

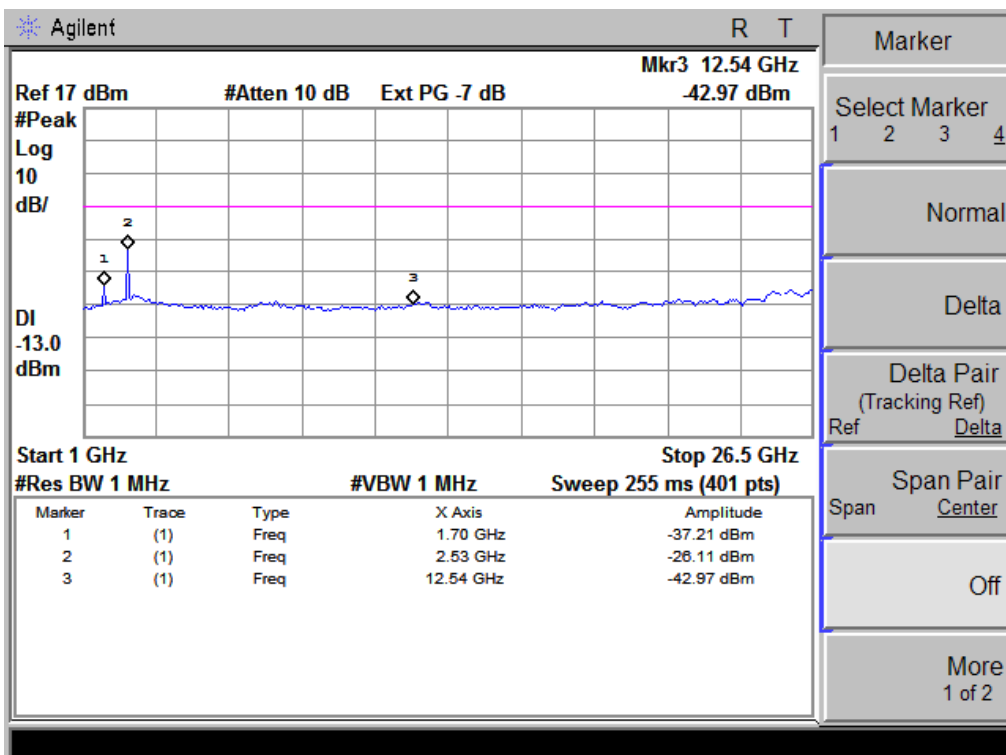



CONDUCTED EMISSION IN GSM1900 BAND  
 Conducted Emission Transmitting Mode CH 512 30MHz – 1GHz

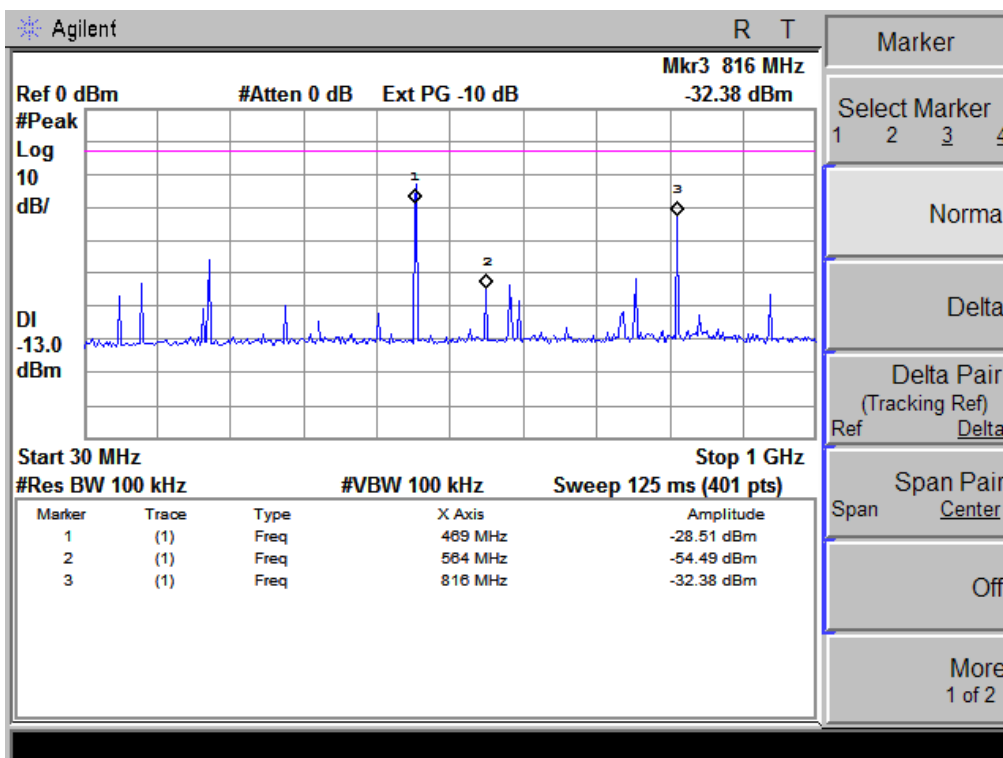

Conducted Emission Transmitting Mode CH 512 1GHz – 20GHz

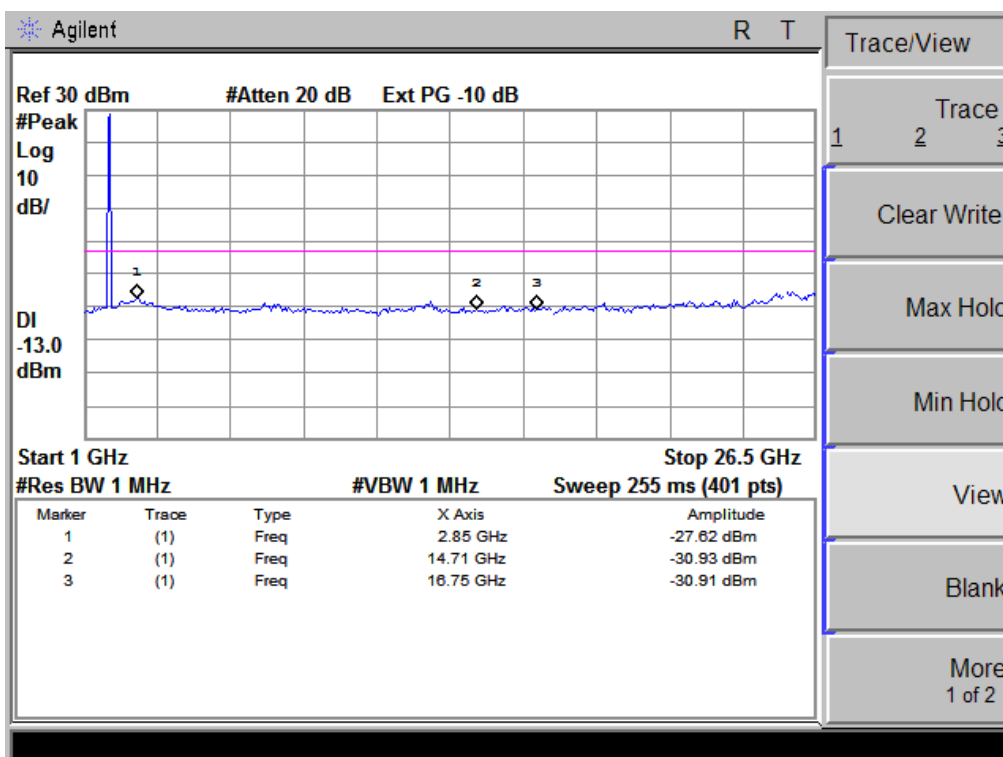

Conducted Emission Transmitting Mode CH 661 30MHz – 1GHz

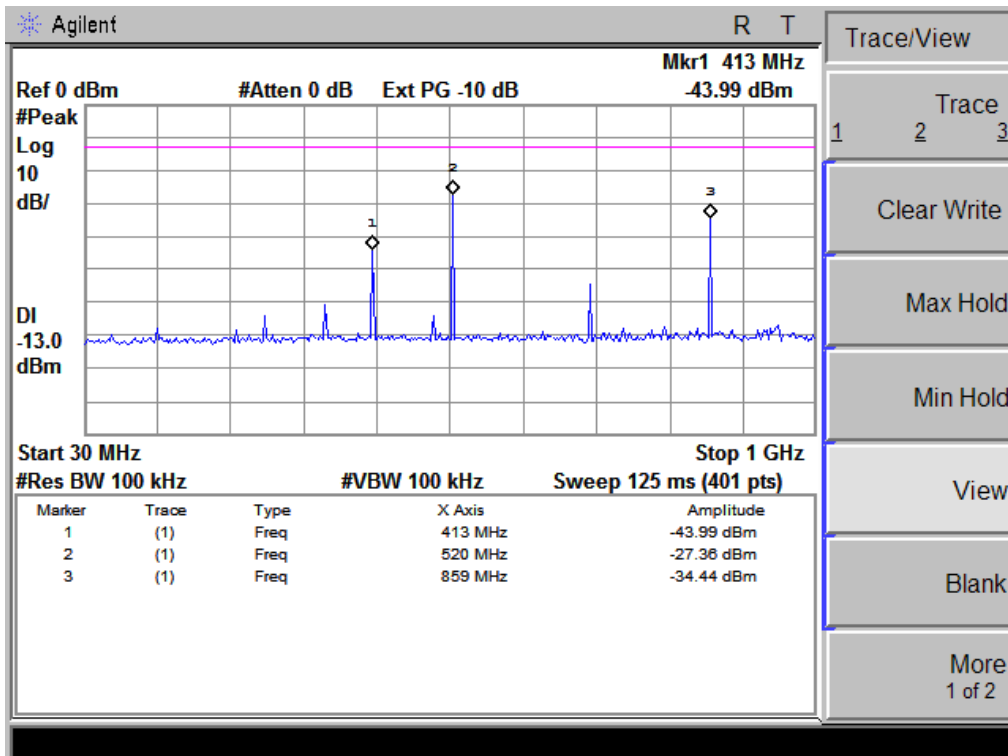

Conducted Emission Transmitting Mode CH 661 1GHz – 20GHz

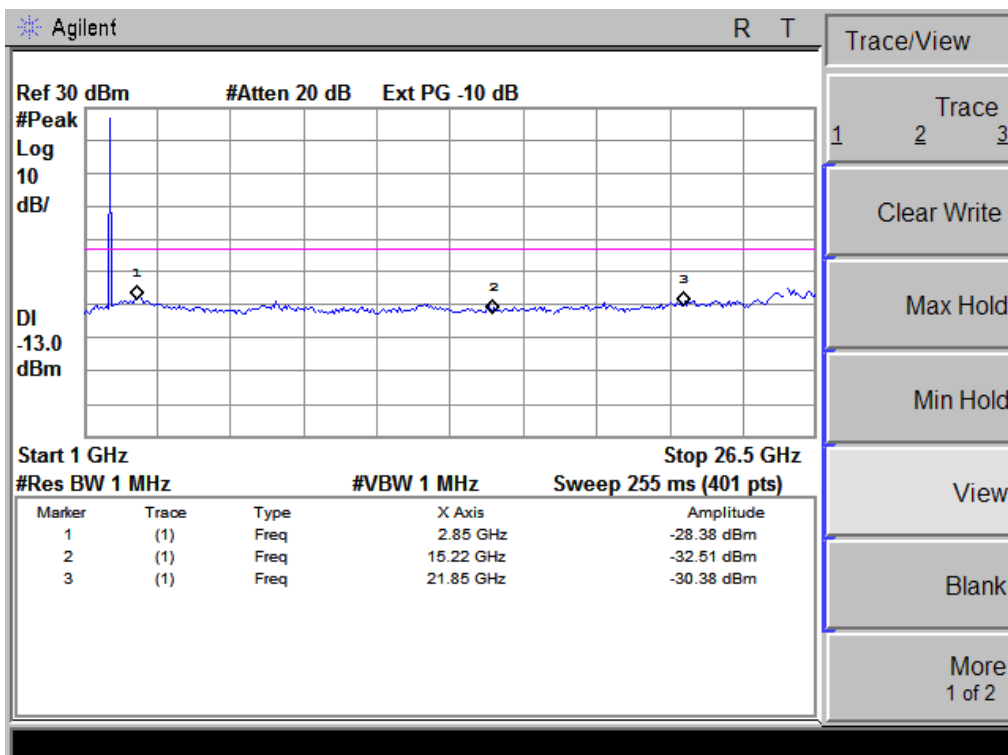

Conducted Emission Transmitting Mode CH 810 30MHz – 1GHz

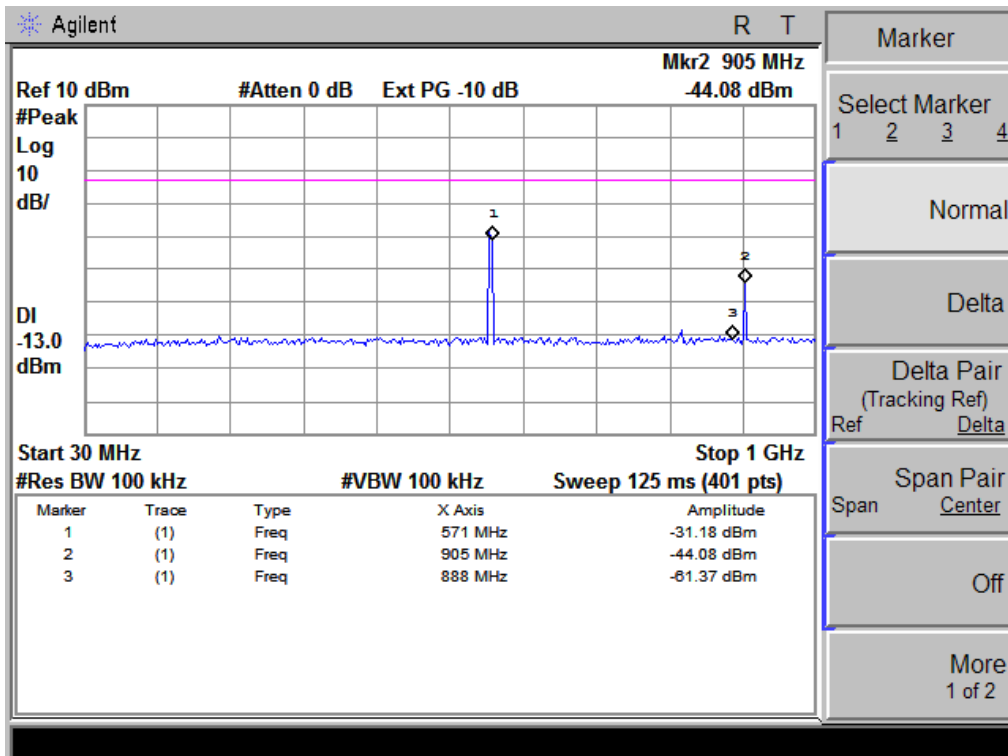

Conducted Emission Transmitting Mode CH 810 1GHz – 20GHz

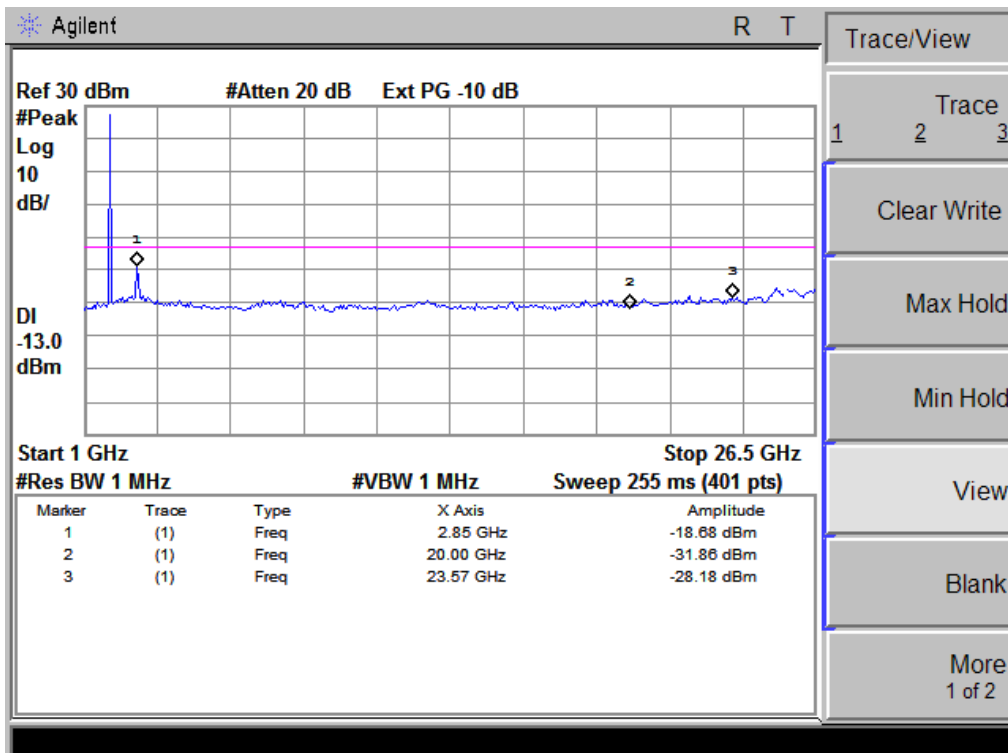

CONDUCTED EMISSION IN UMTS band II  
 Conducted Emission Transmitting Mode CH 9262 30MHz – 1GHz

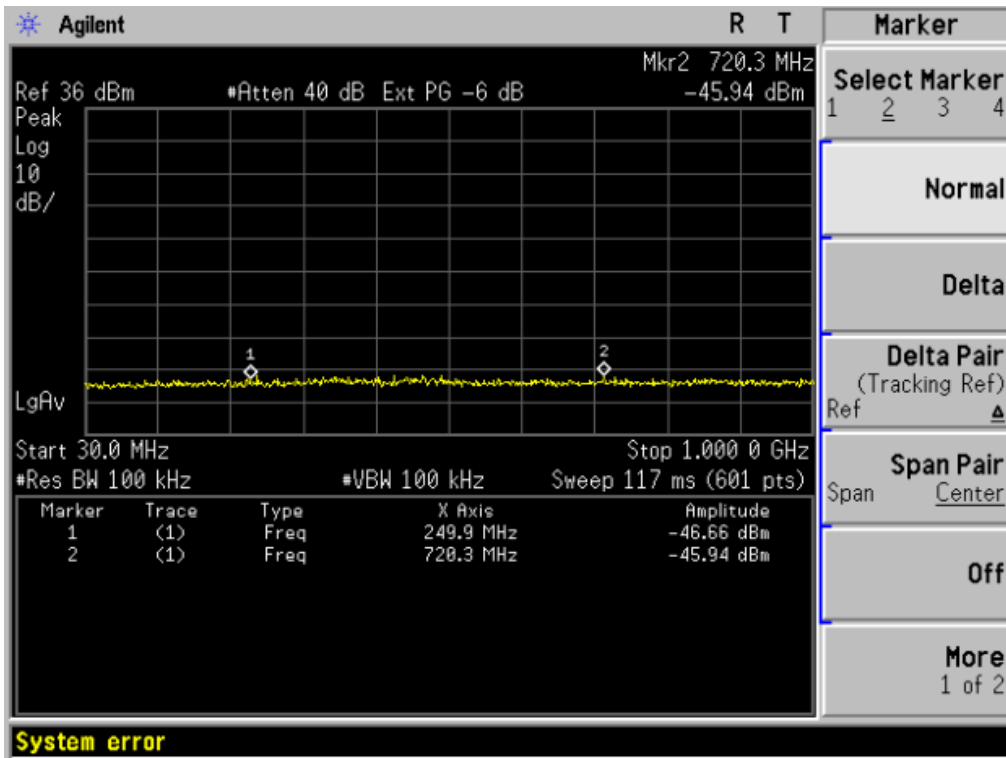

Conducted Emission Transmitting Mode CH 9262 1GHz – 20GHz

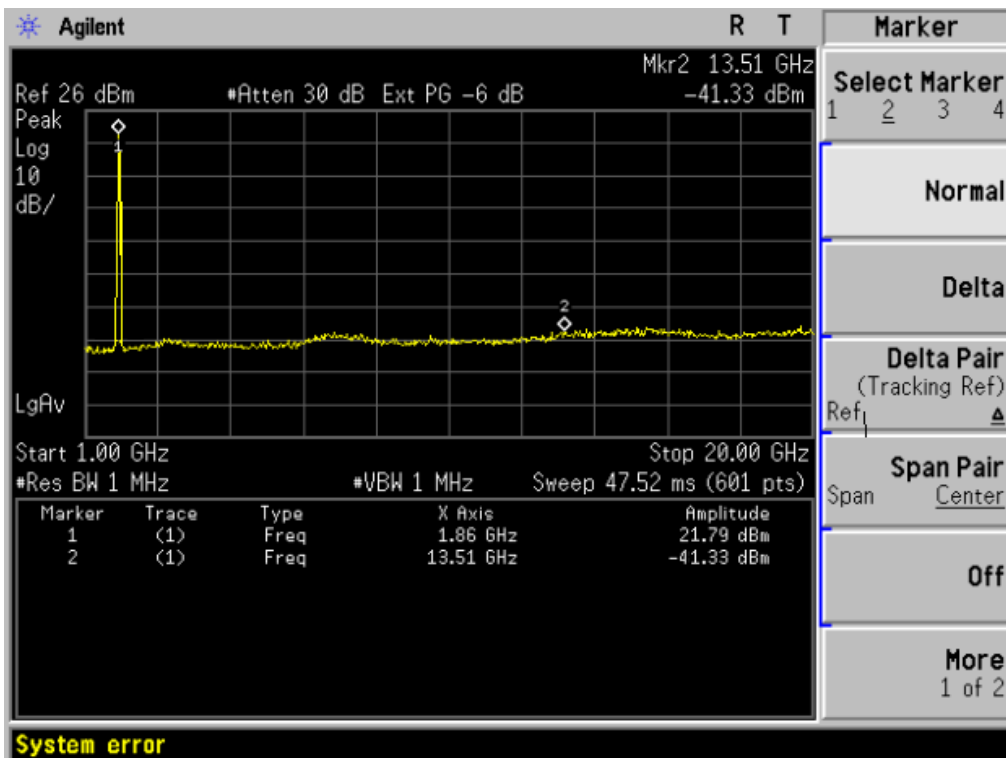

Conducted Emission Transmitting Mode CH 9400 30MHz – 1GHz

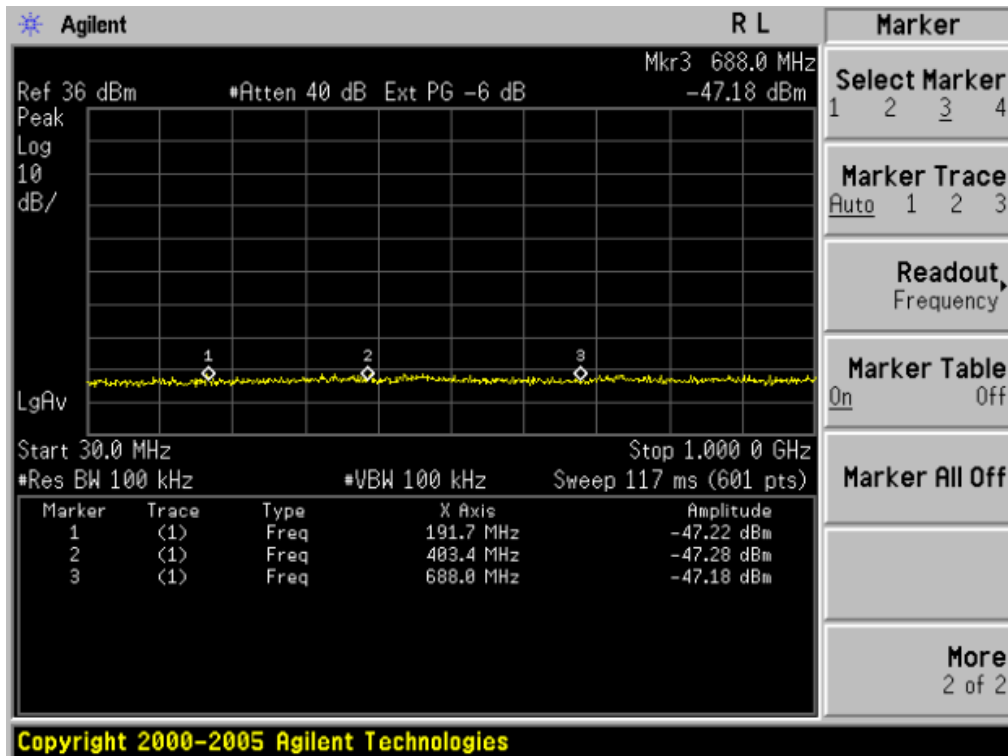

Conducted Emission Transmitting Mode CH 9400 1GHz – 20GHz

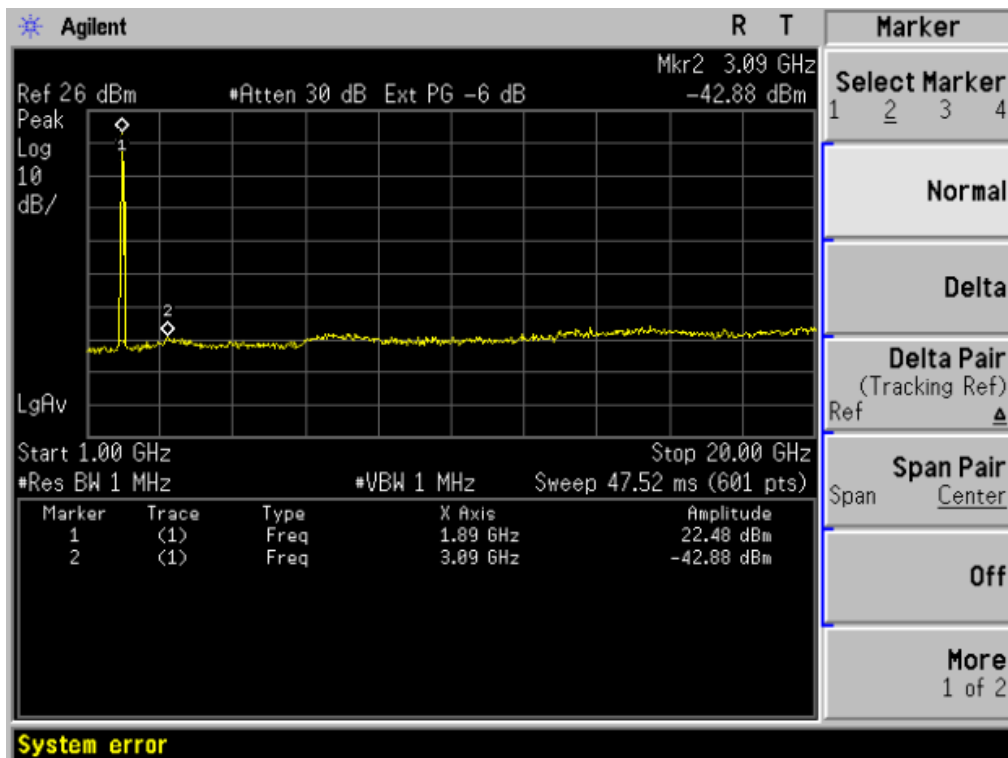

Conducted Emission Transmitting Mode CH 9538 30MHz – 1GHz

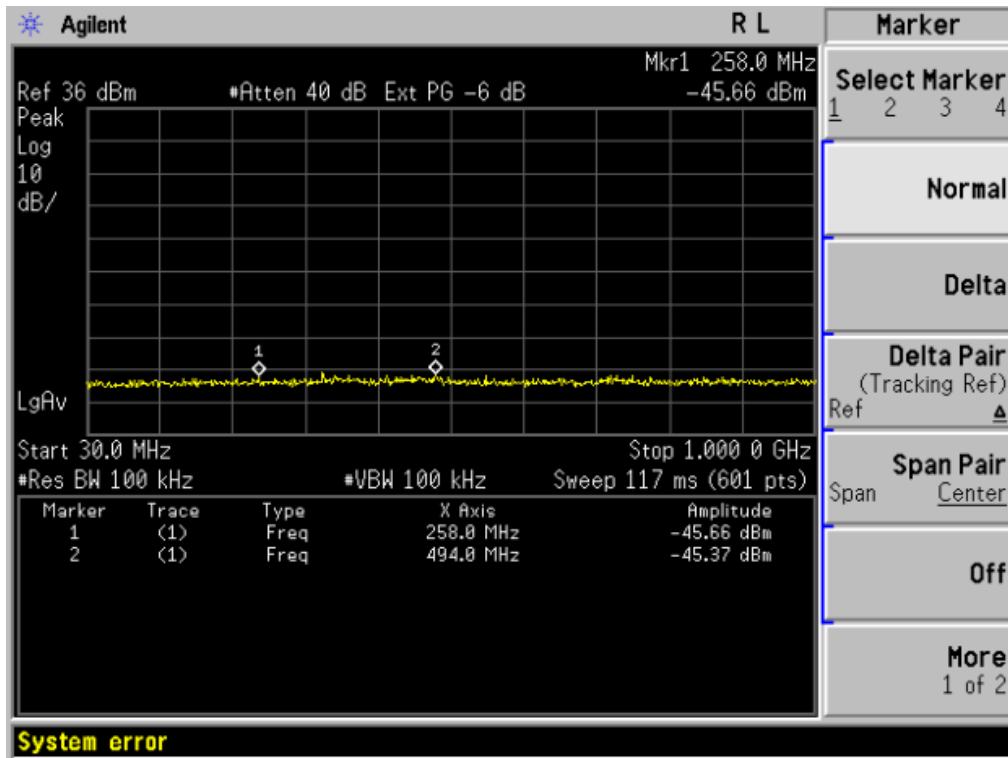

Conducted Emission Transmitting Mode CH 9538 1GHz –20GHz

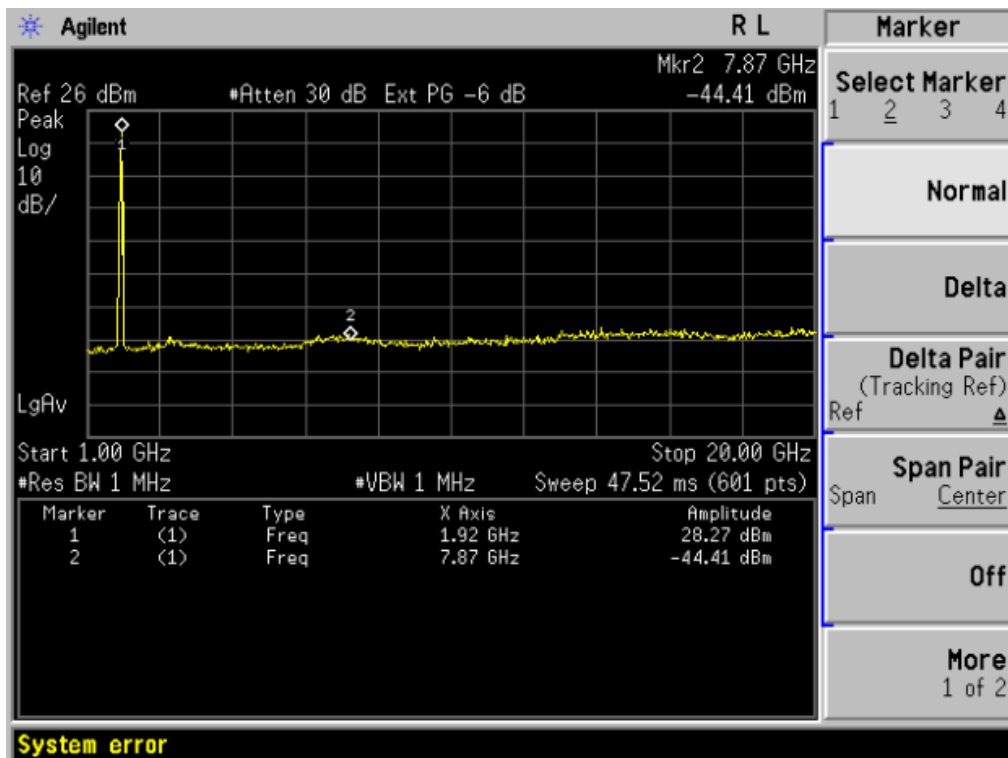

CONDUCTED EMISSION IN UMTS band V  
 Conducted Emission Transmitting Mode CH 4132 30MHz – 1GHz

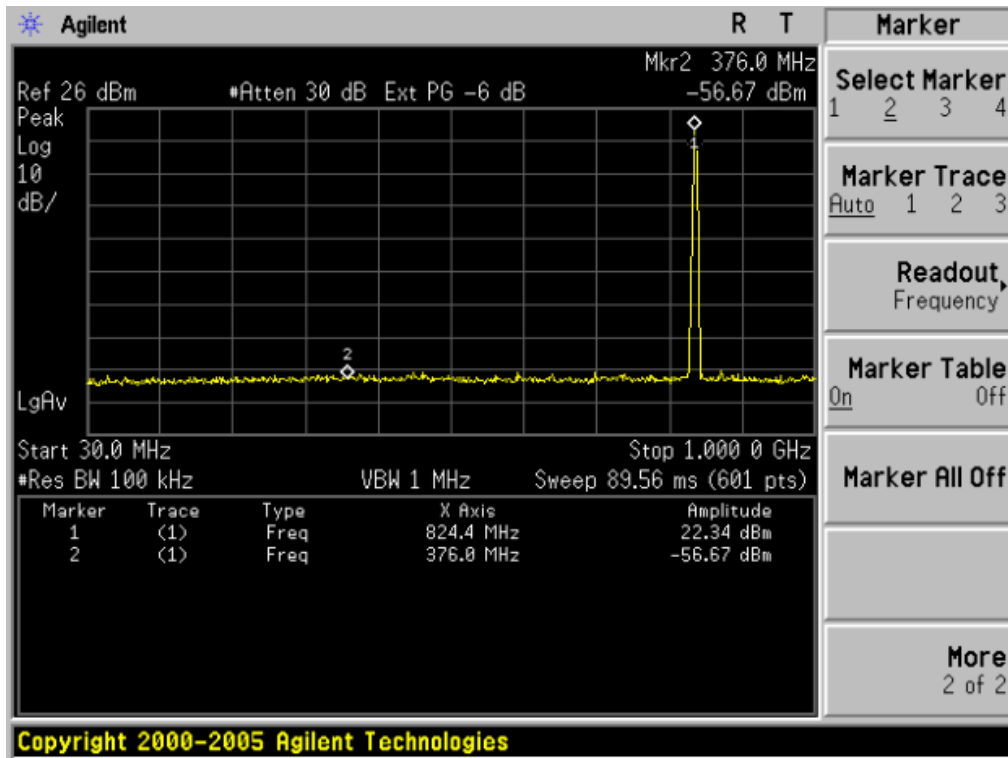

Conducted Emission Transmitting Mode CH 4132 1GHz – 9GHz

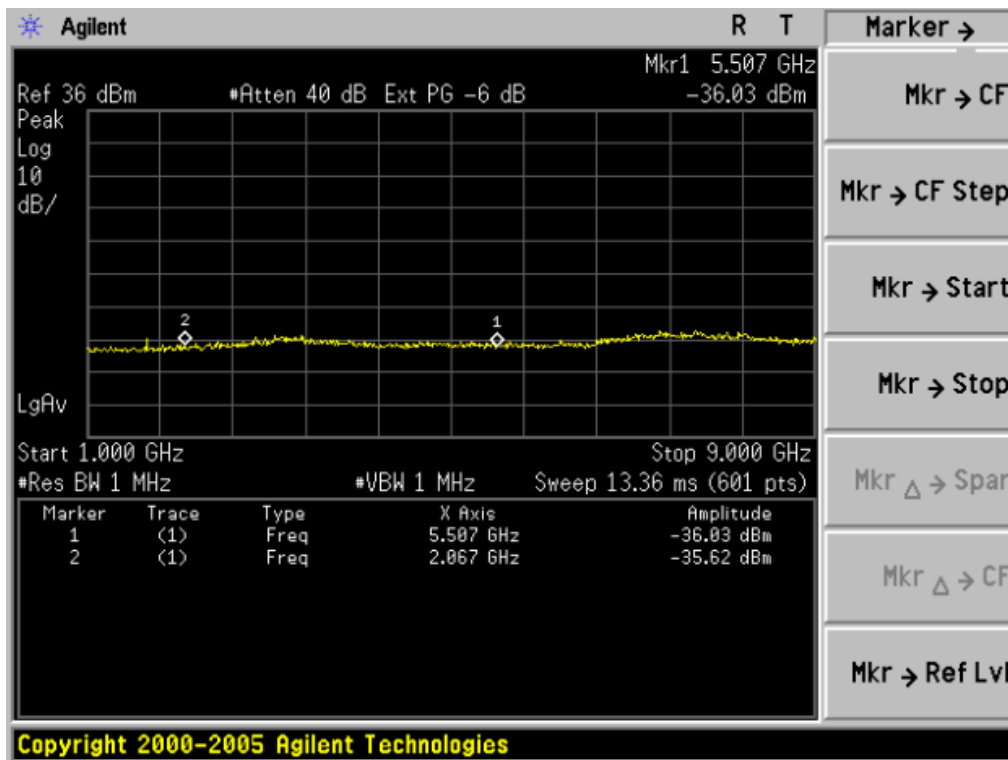

Conducted Emission Transmitting Mode CH 4175 30MHz – 1GHz

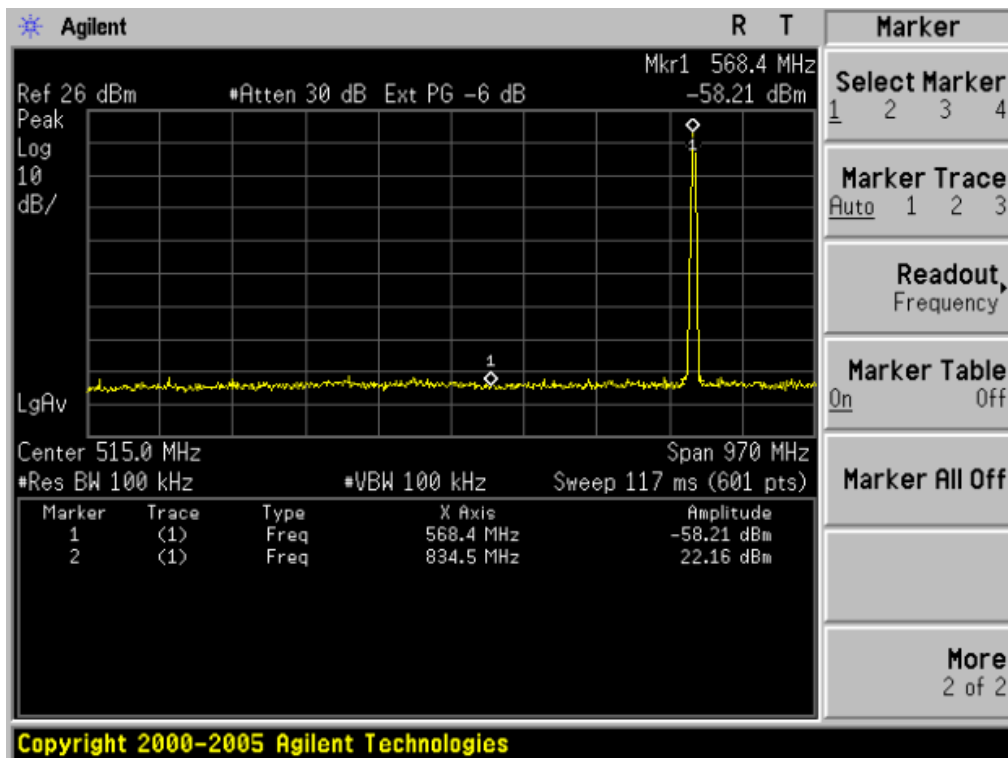

Conducted Emission Transmitting Mode CH 4175 1GHz – 20GHz

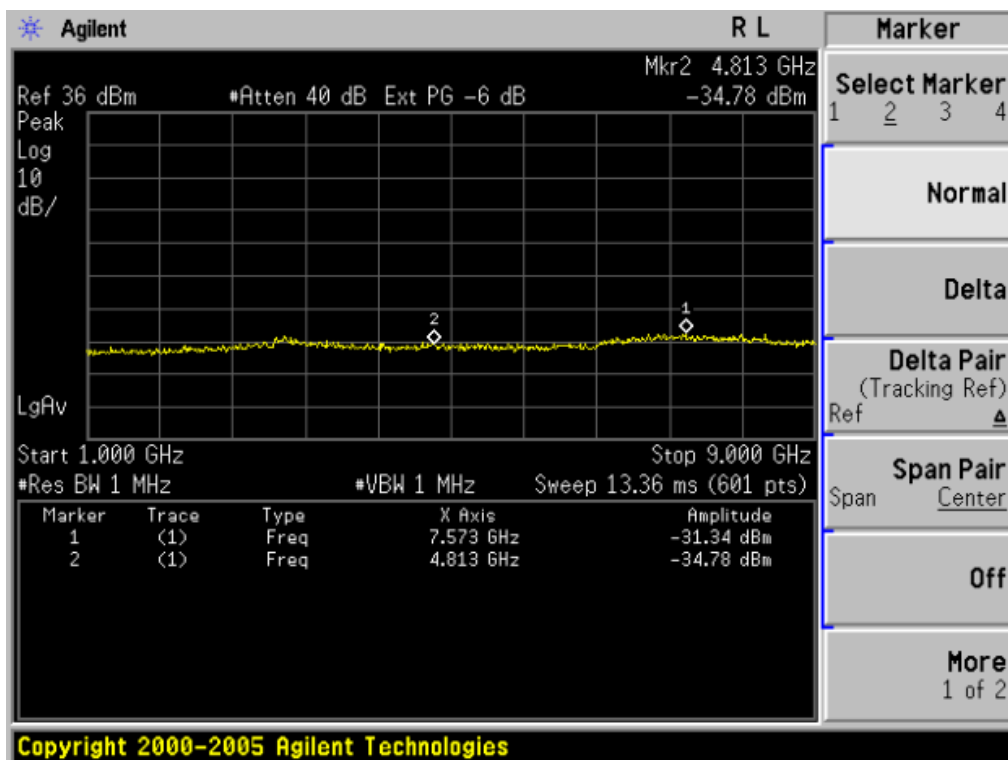



Conducted Emission Transmitting Mode CH 4233 30MHz – 1GHz

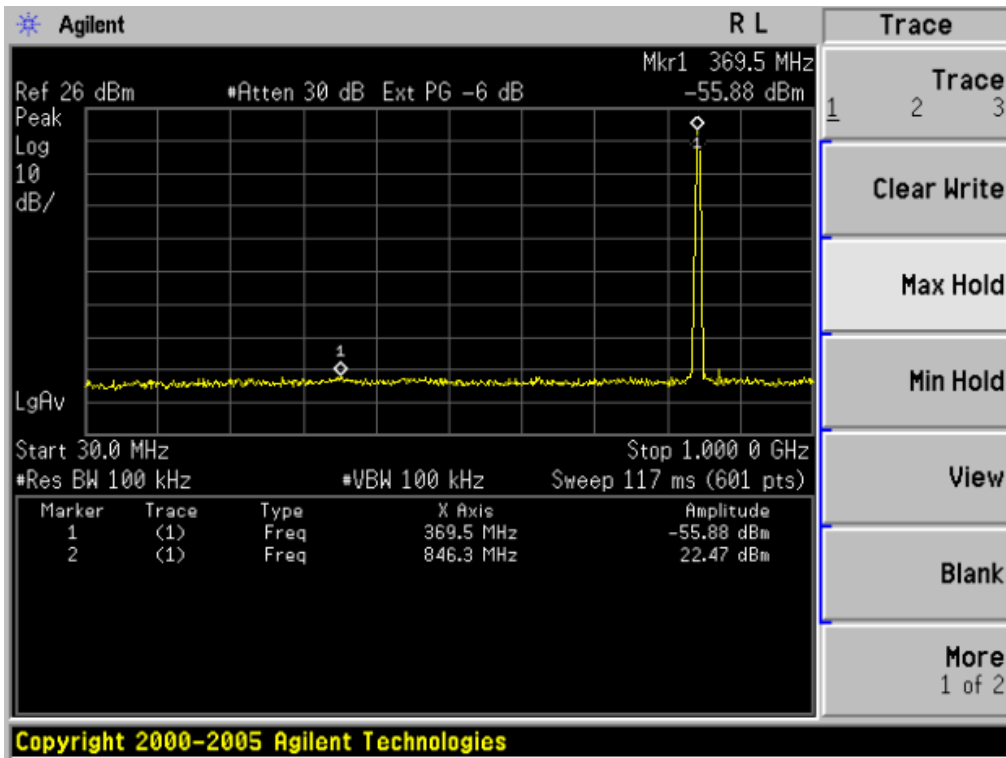

Conducted Emission Transmitting Mode CH 4233 1GHz – 20GHz

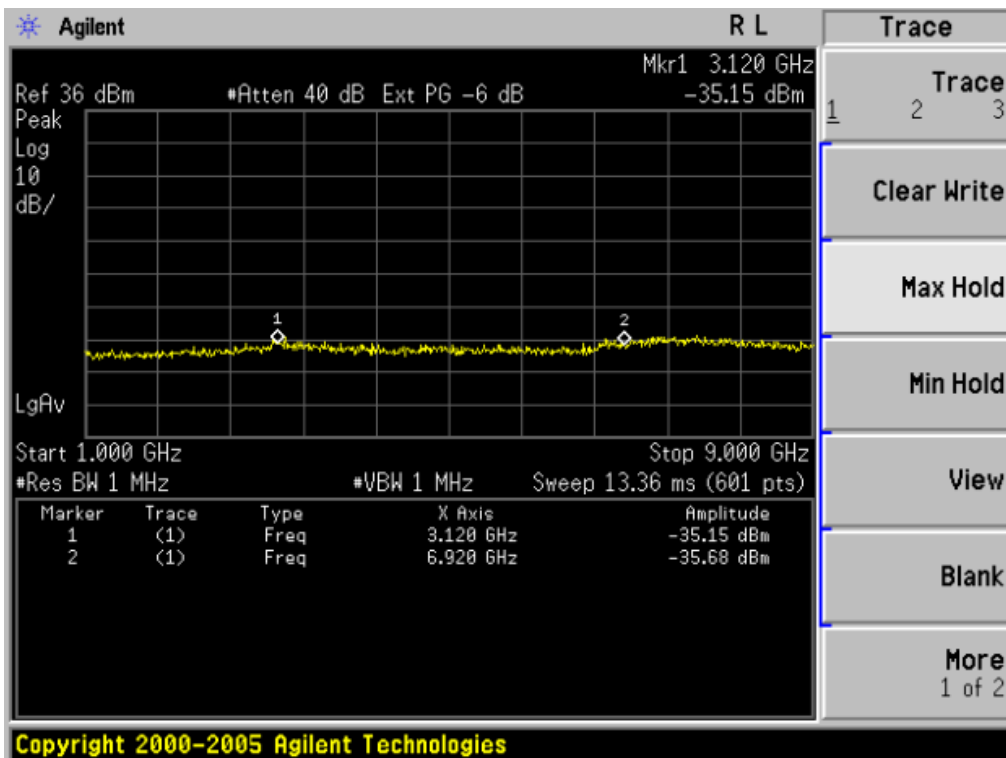

**APPENDIX II**  
**TEST PLOTS FOR OCCUPIED BANDWIDTH (99%)**  
**EMISSION BANDWIDTH (-26dBC)**

Occupied Bandwidth (99%) GSM 850 BAND CH 128



Occupied Bandwidth (99%) GSM 850 BAND CH 190

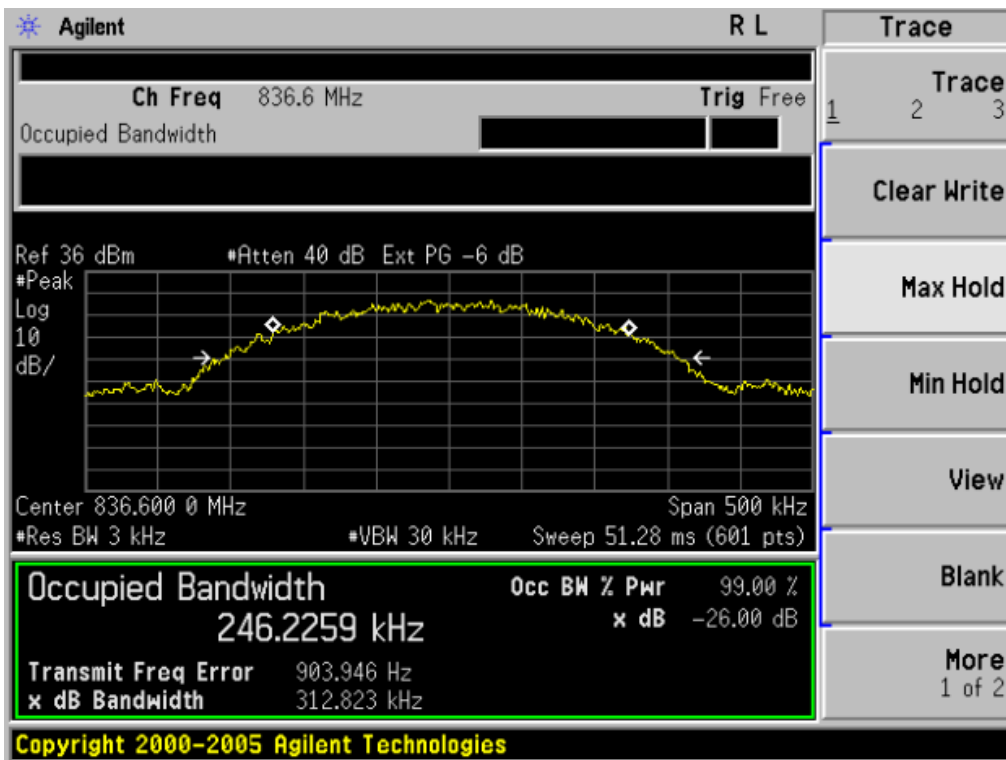

Occupied Bandwidth (99%) GSM 850 BAND CH 251



Occupied Bandwidth (99%) PCS 1900 BAND CH 512

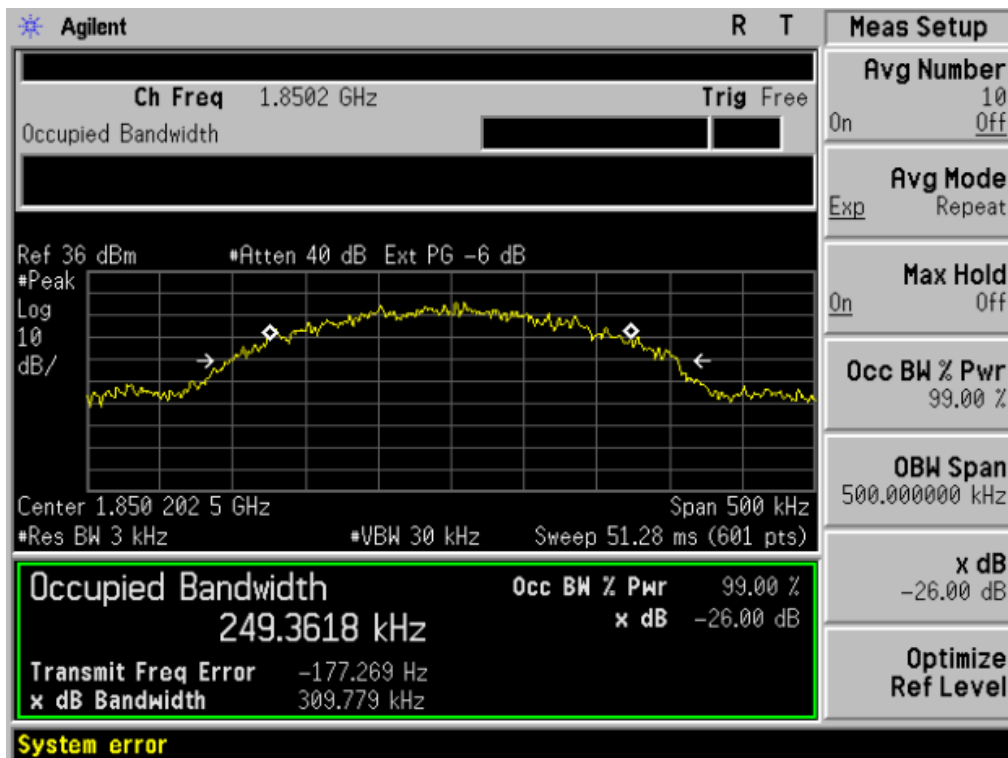

Occupied Bandwidth (99%) PCS 1900 BAND CH 661

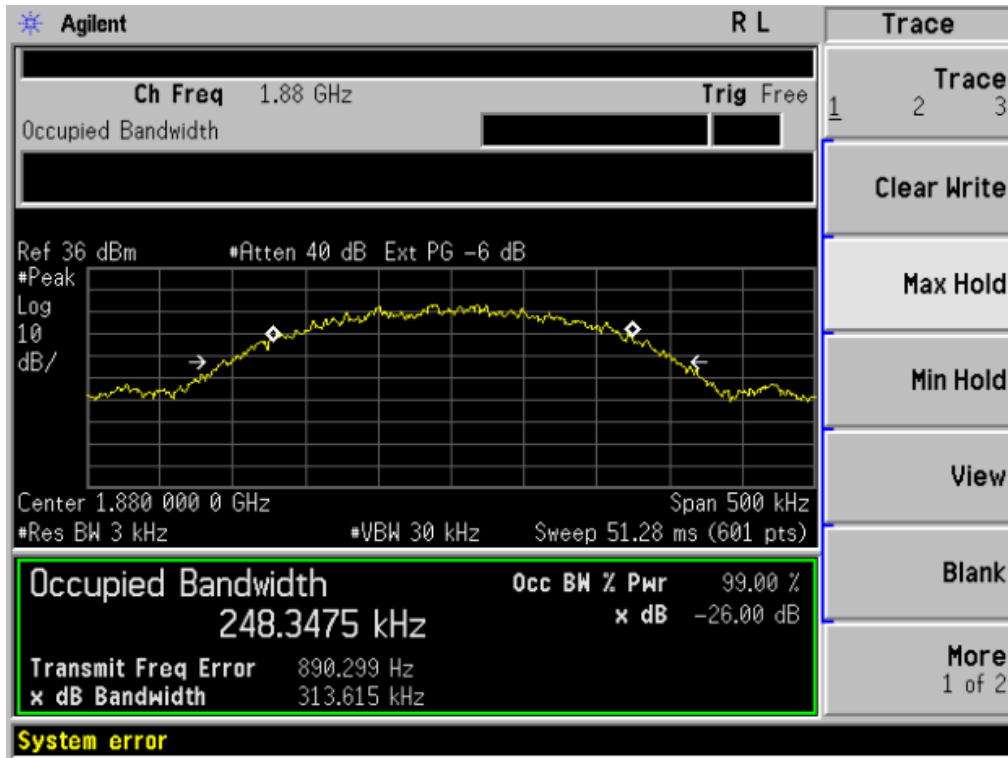

Occupied Bandwidth (99%) PCS 1900 BAND CH 810

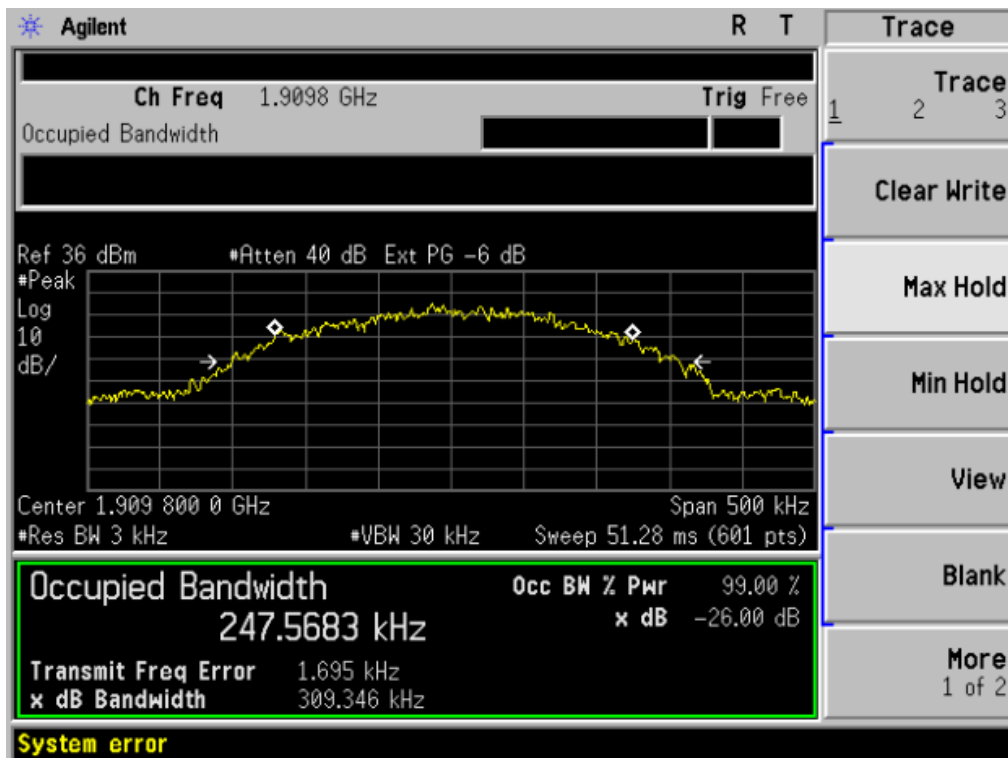

Occupied Bandwidth (99%) UMTS band II CH 9262

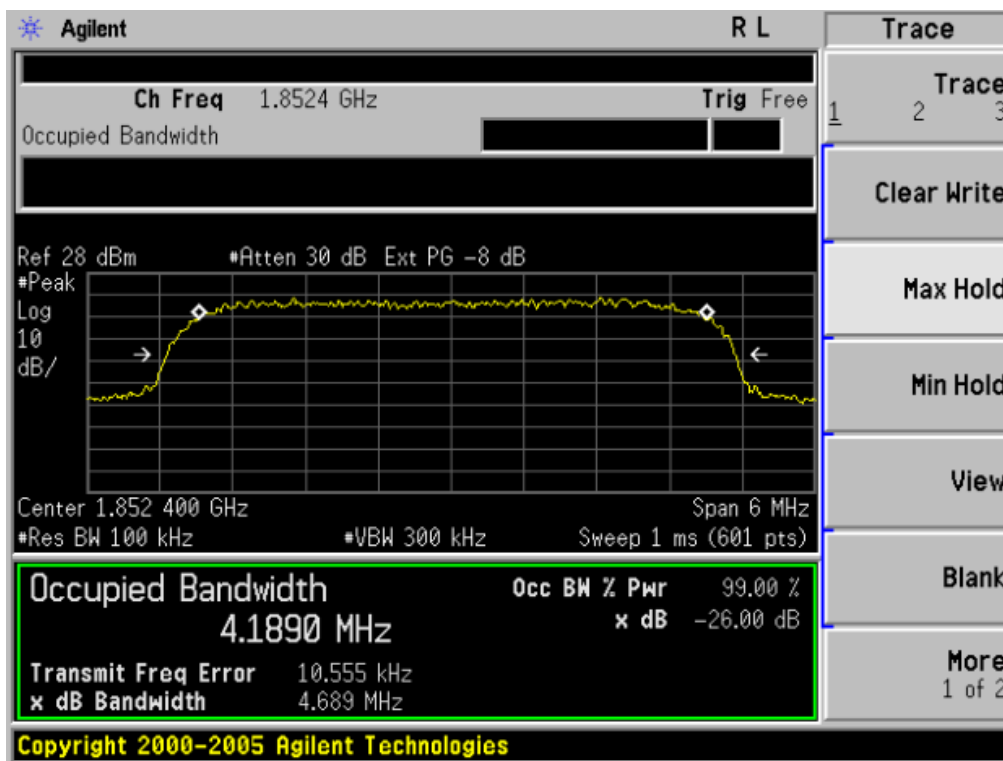

Occupied Bandwidth (99%) UMTS band II CH 9400

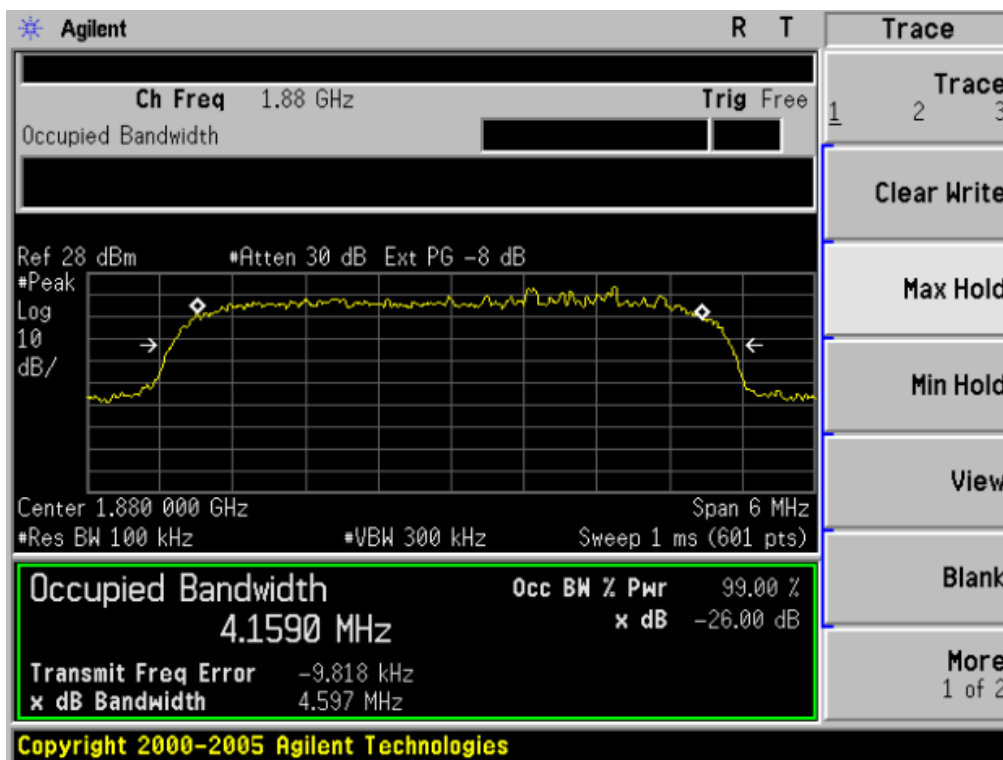

Occupied Bandwidth (99%) UMTS band II CH 9538

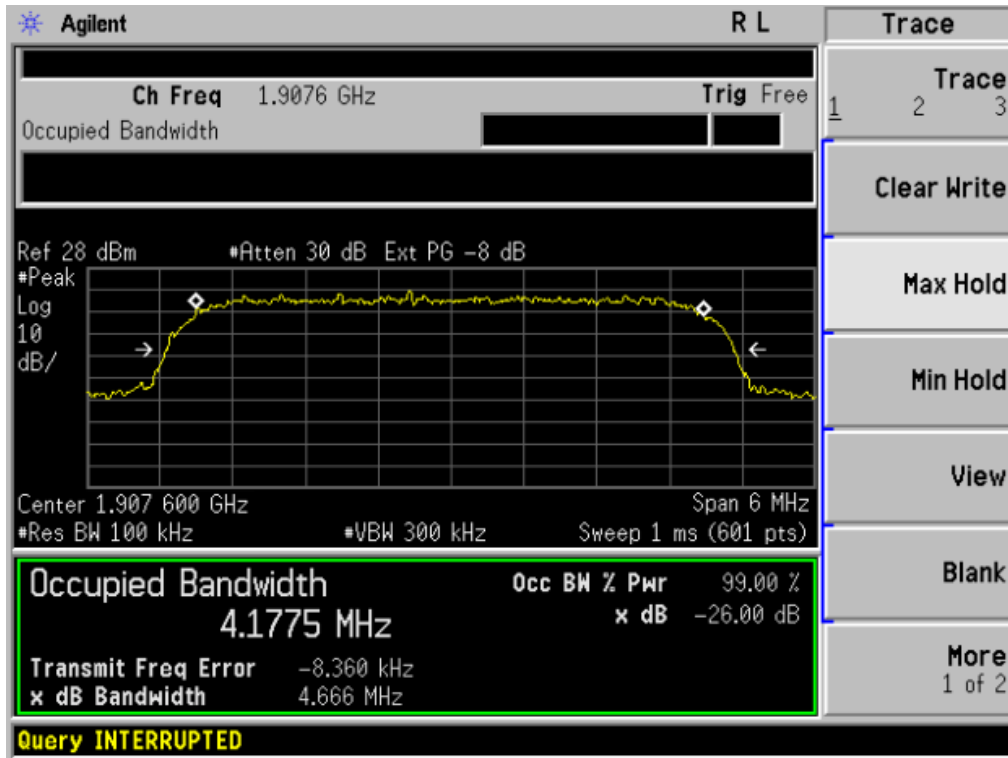

Occupied Bandwidth (99%) UMTS BAND V CH 4132

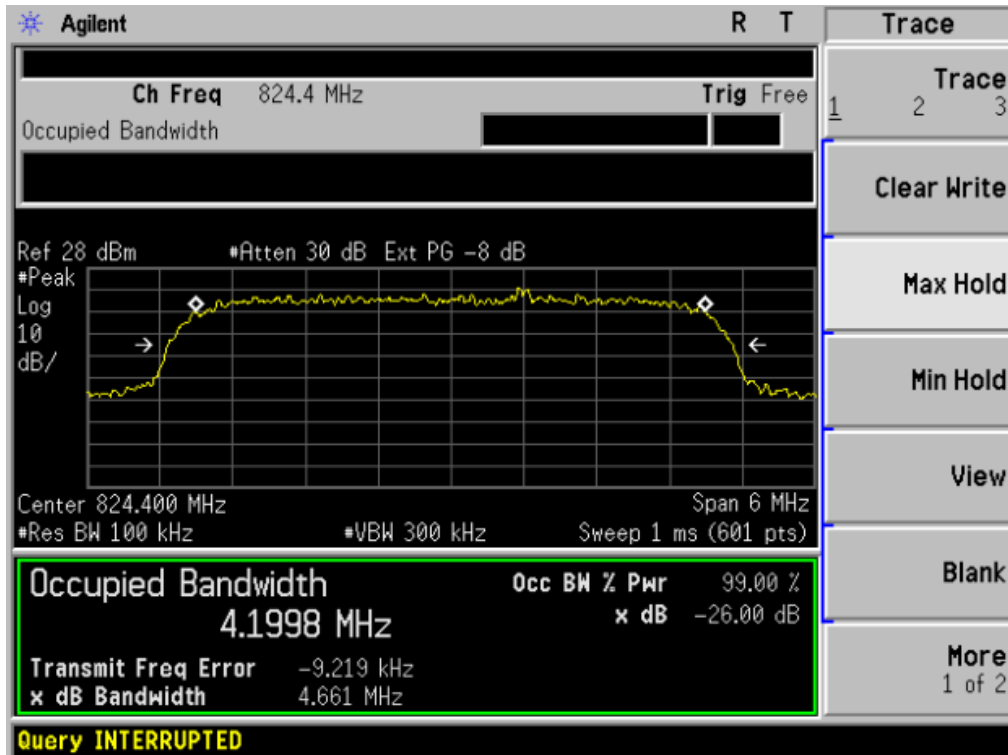

Occupied Bandwidth (99%) UMTS BAND V CH 4175

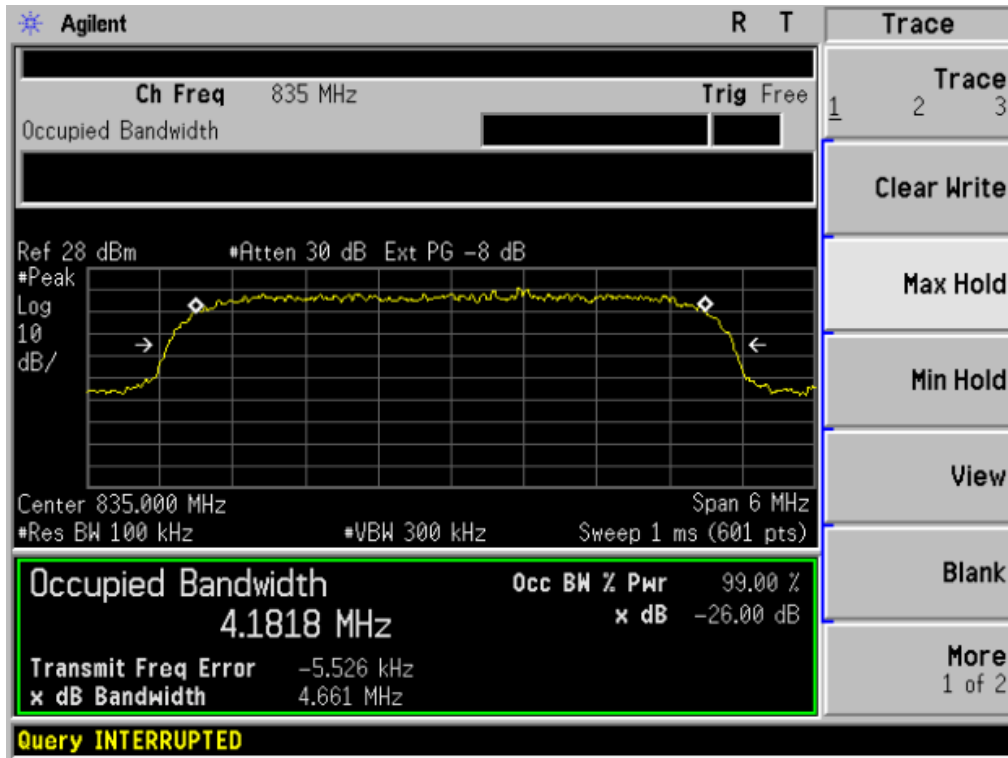

Occupied Bandwidth (99%) UMTS BAND V CH 4233

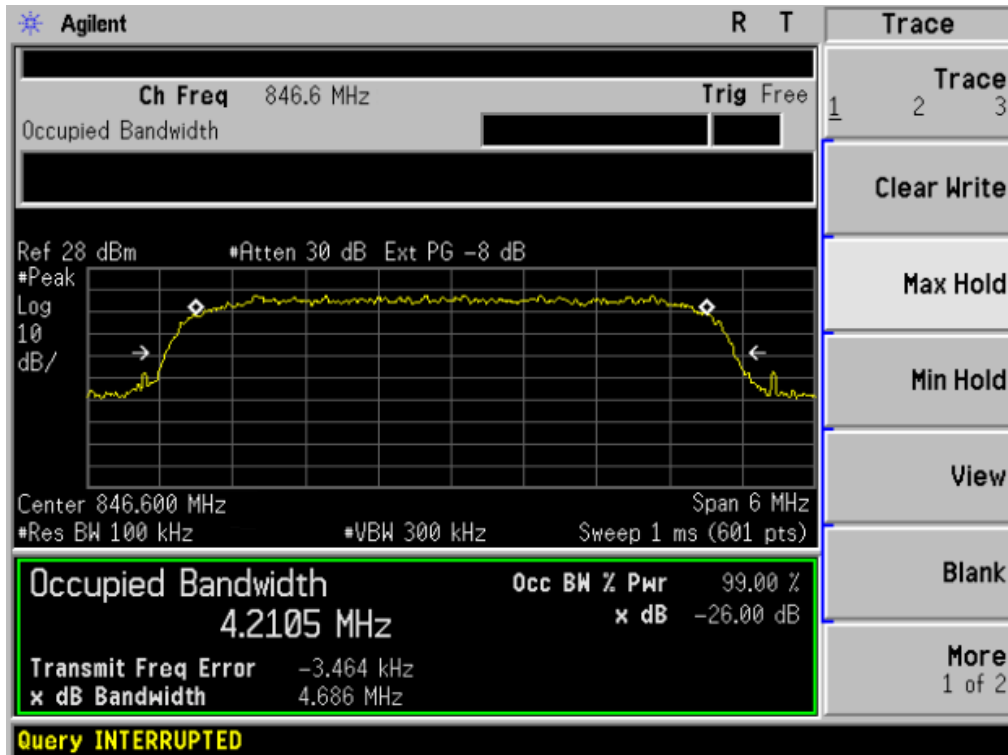



**APPENDIX III**  
**TEST PLOTS FOR BAND EDGES**

### Low Band Edge GSM 850 BAND CH 128

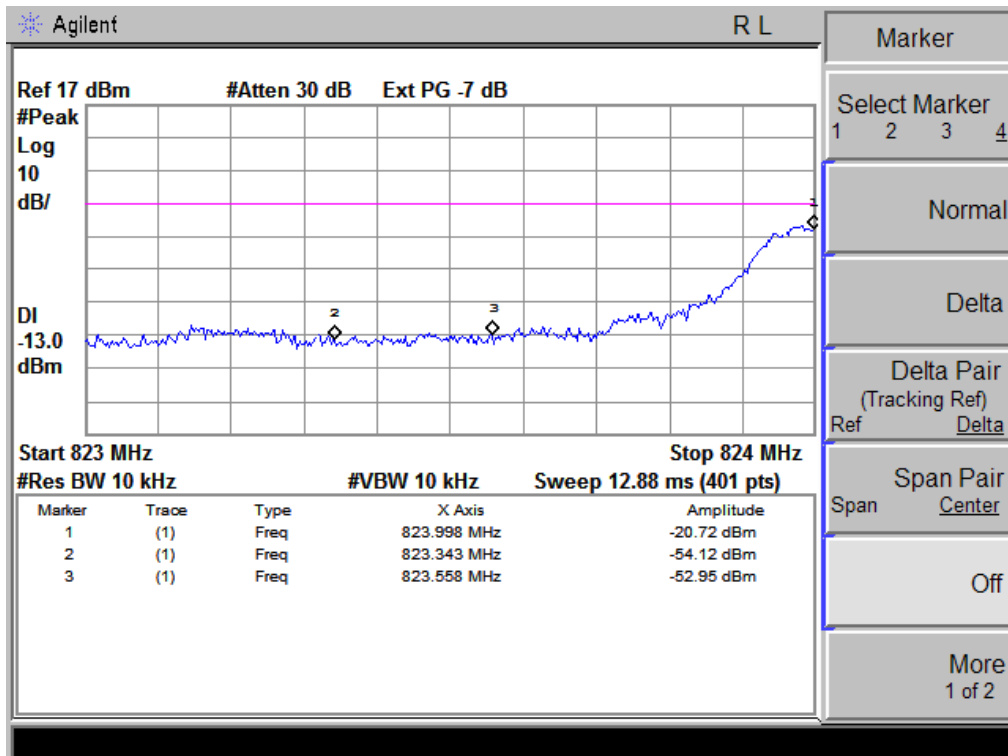

### High Band Edge GSM 850 BAND CH 251

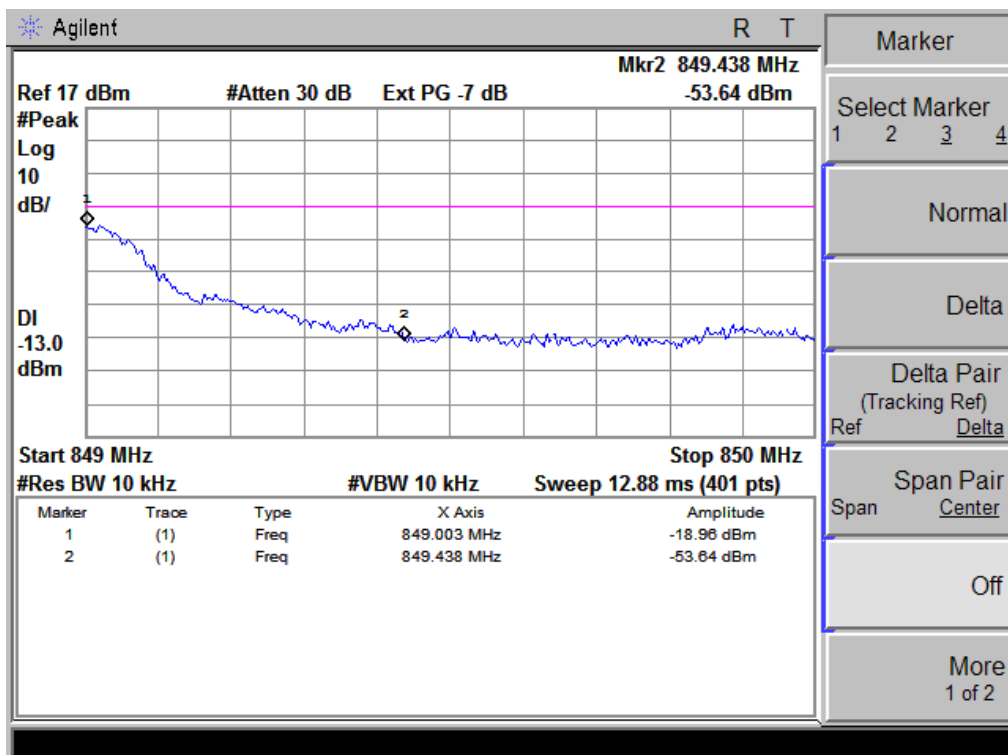

### Low Band Edge PCS 1900 BAND CH 512

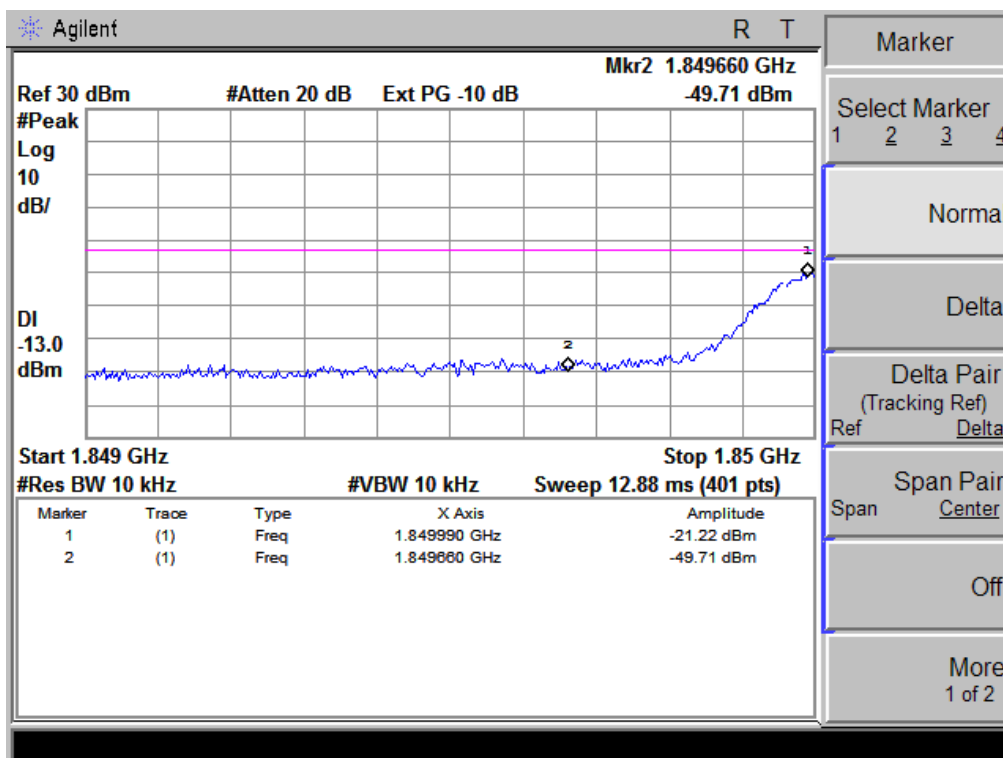

### High Band Edge PCS 1900 BAND CH 810

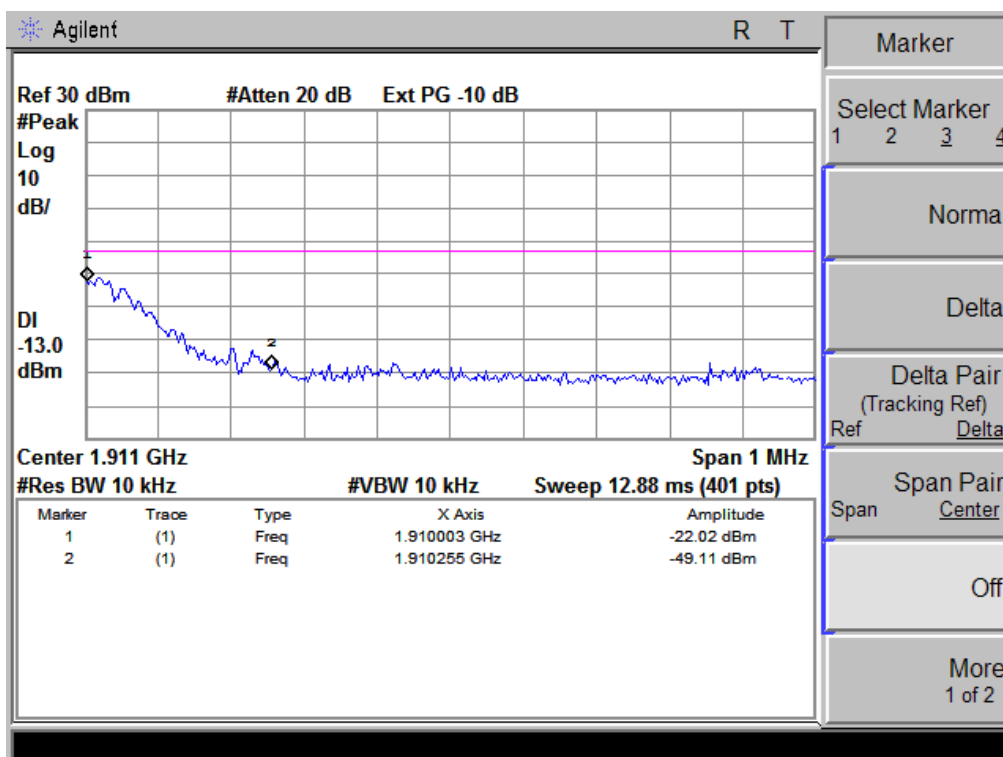

Low Band Edge UMTS BAND II CH 9262

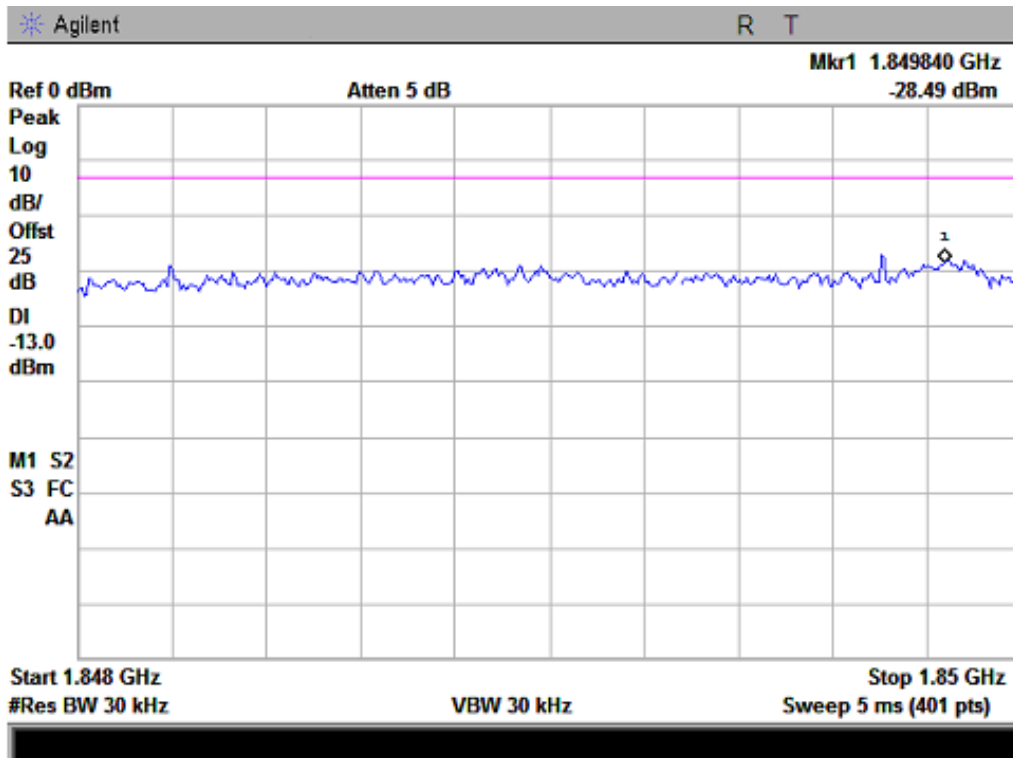

High Band Edge UMTS BAND II CH 9538

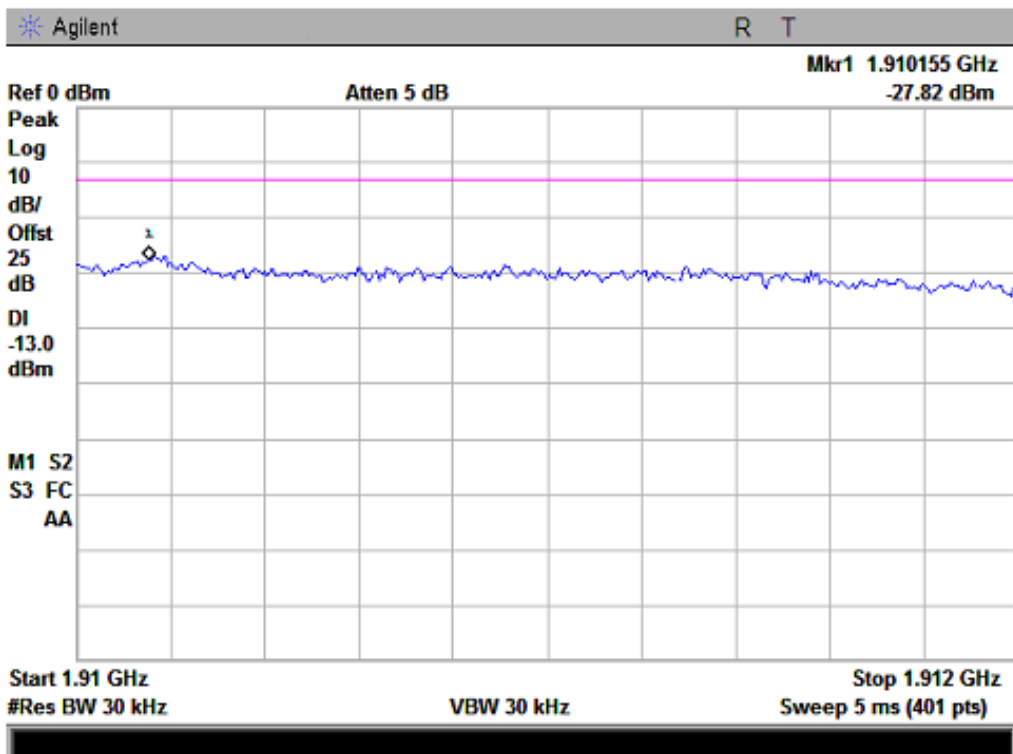

Low Band Edge UMTS BAND V CH 4132

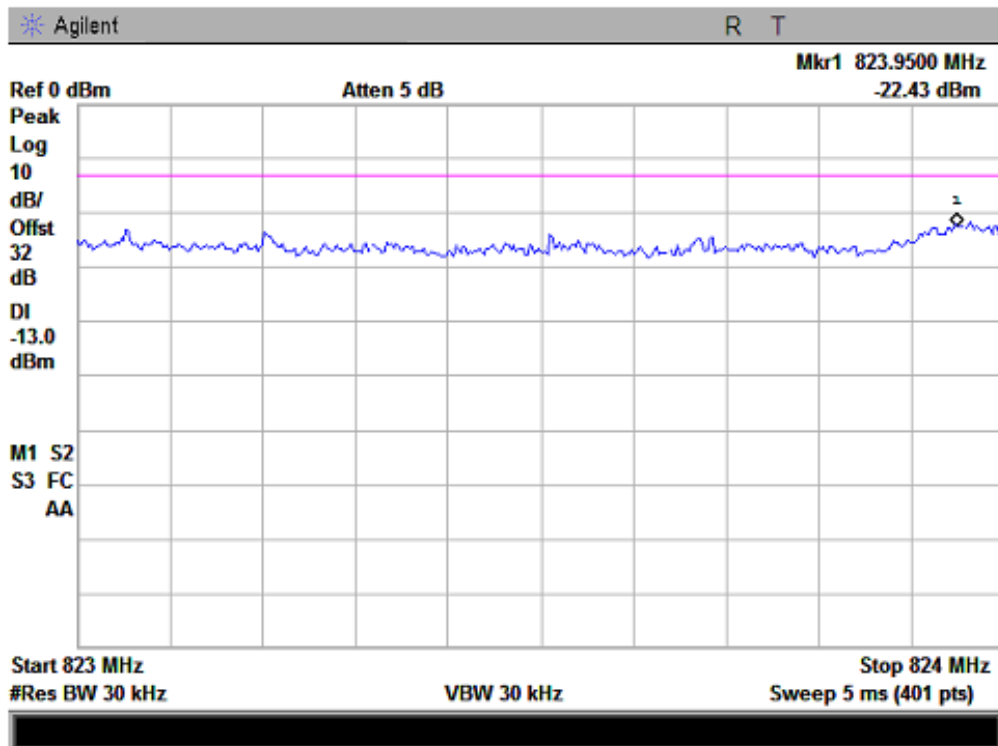

High Band Edge UMTS BAND V CH 4233

