

JENSEN®

VX3024

6.2" Double DIN Multimedia Receiver
DVD / Built-in Bluetooth / Compatible with iPhone /
Compatible with iPod / Pandora Link / USB / Aux In

Operating Instructions



Thank you for choosing a Jensen product. We hope you will find the instructions in this owner's manual clear and easy to follow. If you take a few minutes to look through it, you'll learn how to use all the features of your new Jensen VX3024 Mobile Multimedia Receiver for maximum enjoyment.

Contents

Safety Precautions	3
Front Panel.....	5
Basic Operations	7
Radio Mode	9
Playback Mode	12
Bluetooth Mode	18
iPod Mode	20
PANDORA® RADIO OPERATION	21
Settings.....	23
Other Modes.....	26
Specifications	27
Troubleshooting	29
Wire Connections	30

Safety Precautions

Only connect the unit to a 12-volt power supply with negative grounding.

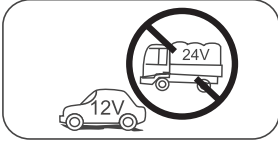

Never install this unit where the operation & condition for safe driving is impaired.



Never use the video display function in the front when driving to prevent the violation of laws & regulations and also to reduce the risk of traffic accident except for using rear view video camera.



Never expose this unit, amplifier, and speakers to moisture or water to prevent electric sparks or fire.

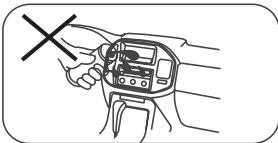

Please don't change the fuse on the power cord without professional guidance, using improper fuse may cause damage to this unit or even cause fire.

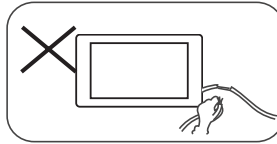

Please contact your nearest dealer if one of the following symptoms is experienced:

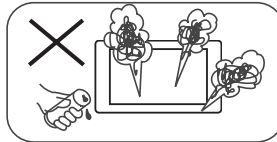

- (a). Water or other objects enters the unit.
- (b). There is smoke.
- (c). Peculiar smell.

To ensure safe driving, please adjust the volume to a safe and comfortable level in case of emergency situations.

1. Never disassemble or adjust the unit without any professional guidance.
For details, please consult any professional car shop / dealer for inquiry.
2. If the front panel or TFT monitor is dirty, please use a clean silicone cloth and neutral detergent to wipe off the spot. Using a rough cloth and non-neutral detergent such as alcohol for cleaning may result in scratching or decoloration to the monitor.
3. If any abnormal behavior of the unit is found, please refer to trouble shooting guide of this manual. If no relevant information is found, please press the [RESET] key on the front panel to resume factory default.
4. If you have parked the car in hot or cold weather for a long time, please wait until the temperature in the car becomes normal before operating the unit.
5. Using the car heater in low temperature environment may result in moisture inside the unit, DO NOT use the unit in this situation. Eject the disc and wipe off the moisture on the disc. If the unit still doesn't work after a few hours, please contact the service center.
6. Do not impact the LCD monitor which could cause damage.
7. To prevent damage to the screen, avoid touching it with sharp objects.
8. To provide a clear demonstration and an alternative for easy understanding to the operation of this unit, graphic illustrations are used.
However, some illustrations are different from the actual images displayed on the screen.
9. Operate the unit correctly according to this manual to prevent unnecessary problem. The guarantee won't be valid if the problem is caused by inappropriate operation.

FCC STATEMENT

This device complies with Part 15 of the FCC Rules. Operation is subject to the following two conditions:

- (1) This device may not cause harmful interference.
 - (2) This device must accept any interference received, including interference that may cause undesired operation.
- Changes or modifications not expressly approved by the party responsible for compliance could void the user's authority to operate the equipment.

NOTE:

This equipment has been tested and found to comply with the limits for a Class B digital device, pursuant to Part 15 of the FCC Rules. These limits are designed to provide reasonable protection against harmful interference in a residential installation.

This equipment generates uses and can radiate radio frequency energy and, if not installed and used in accordance with the instructions, may cause harmful interference to radio communications. However, there is no guarantee that interference will not occur in a particular installation. If this equipment does cause harmful interference to radio or television reception, which can be determined by turning the equipment off and on, the user is encouraged to try to correct the interference by one or more of the following measures:

- Reorient or relocate the receiving antenna.
- Increase the separation between the equipment and receiver.
- Connect the equipment into an outlet on a circuit different from that to which the receiver is connected.
- Consult the dealer or an experienced radio/TV technician for help.

FCC Radiation Exposure Statement

This equipment complies with FCC radiation exposure limits set forth for an uncontrolled environment. This equipment should be installed and operated with minimum distance 20cm between the radiator & your body

This unit supports only the following iPod/iPhone models:

- iPhone 5
- iPhone 4S
- iPhone 4
- iPod touch (5th generation)
- iPod touch (4th generation)
- iPod nano (7th generation)
- iPod nano (6th generation)



"Made for iPod," and "Made for iPhone" mean that an electronic accessory has been designed to connect specifically to iPod, or iPhone, respectively, and has been certified by the developer to meet Apple performance standards.

Apple is not responsible for the operation of this device or its compliance with safety and regulatory standards. Please note that the use of this accessory with iPod or iPhone may affect wireless performance.

iPhone and iPod are trademarks of Apple Inc., registered in the U.S. and other countries.

Pandora® is a registered trademark of Pandora Media, Inc.

Front Panel

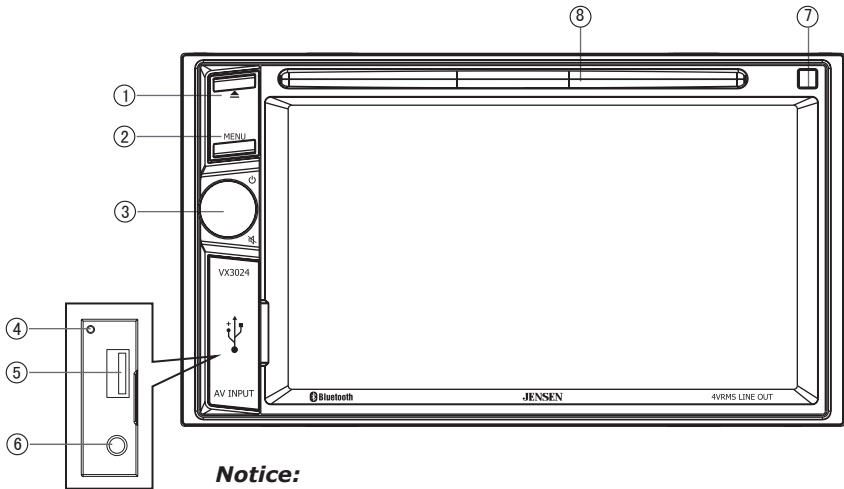

Notice:

The graphic in this manual is for reference only, and may be different from the actual unit. Reference to actual unit is suggested.

1. **[▲] Button**
Press to eject a disc.
2. **[MENU] Button**
Press to switch between the sources menu and the previous source.
3. **[⏻/⏸] Knob**
Rotate to adjust the volume.
Press momentarily to activate the MUTE function. Press again to resume normal listening.
Press to turn the unit ON. Press and hold to turn the unit OFF.
4. **Reset Button**
Press to reset system settings to factory default (except password and parental lock settings).
5. **USB Connector**
Connect a USB device for playback of music/video files.
6. **A/V Input**
Accepts a 3.5mm jack through which signals from various audio/video devices can be applied to the unit.
7. **Remote Sensor**
8. **Disc slot**

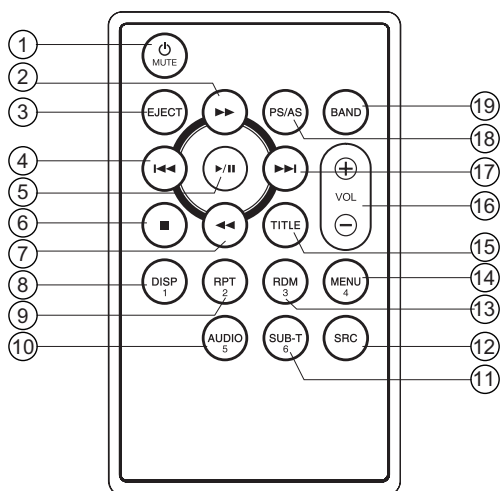

1. Power & Mute On/Off
2. Fast forward / Station up
3. Eject the disc
4. Previous / Seek down
5. Play / Pause
6. Stop
7. Fast backward / Station down
8. Preset station 1.
9. Repeat play / Preset station 2.
10. DVD/VCD audio stream change / Preset station 5.
11. DVD subtitle/ Preset station 6.
12. Show main menu.
13. CD/MP3 Random play / Preset station 3.
14. DVD/VCD root menu/ Preset station 4.
15. DVD title.
16. Adjust volume level.
17. Next / Seek up
18. Scan play / Preset scan
Auto memory store (long press)
19. Select tuner band.

Notes on Remote Control Usage

1. Aim the remote control at the remote sensor on the unit.
2. Replace the battery from the remote control or insert a battery insulator if the battery has not been used for a month or longer.
3. DO NOT store the remote control in direct sunlight or in a high temperature environment, as it may not function properly.
4. The battery can last up to for 6 months in normal conditions. If the remote control does not work, please change the battery.
5. Use "button shaped" lithium battery "CR2025"(3V) only.
6. DO NOT recharge, disassemble, heat or expose the battery to fire.
7. Insert the battery in the proper direction according to the (+) and (-) poles.
8. Store the battery in a place where it cannot be reached by children to avoid the risk of accident.

Replacing the lithium battery

When the range of operation of the card remote control becomes short or no function, replace the lithium battery with a new one. Make sure the battery polarity replacement is correct.

1. Pull out the battery holder while pressing the stopper.
2. Insert the button-type lithium battery with the (+) mark facing upward. Insert the battery holder into the remote control.

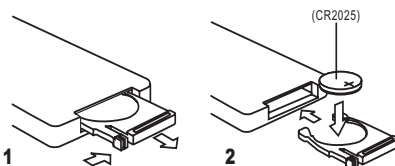



Basic Operations



Parking Brake Inhibit

- When the "BRAKE" cable is connected to the brake switch, the display on the TFT monitor will display video only when the vehicle is applied.
- Parking brake function is overridden when the video source is set to REVERSE.
- When the parking brake inhibit is active, the front monitor displays Warning information, preventing the driver from watching content while driving. Rear video screens are not affected.

Mute

Press [] knob to mute the volume from the unit. Press again to restore the volume. [] is displayed on the LCD. Adjusting the volume or using any of the audio setup features cancels the mute function.

Power On / Off

Press the [] on the unit to turn the unit on. The buttons on the front of the unit light up for a moment and the current mode status appears in the LCD. Press and hold the [] knob to power off the unit.

Demo

Demo mode is used to illustrate the functions of the unit. Touch the screen to exit it. Demo mode is default on. You can turn it off in Setting menu.

Audible Beep Confirmation

An audible beep tone confirms each function selection. The Beep tone can be disabled through the Setup menu.

Playing Source Selection

Press the [MENU] button on the front panel to display the playing source menu.

1. Prev or Next: Touch to view the previous or next page of playing sources.
2. Playing source icon: touch to access corresponding work mode.
3. Clock



Volume Adjustment

To increase or decrease the volume level, turn the [] knob on the front panel. The volume range is from "0" to "50". The LCD or TFT screen displays the volume level for 3 seconds.

EQ Menu

The Audio Control feature allows you to easily adjust your audio system to meet the acoustical characteristics of your vehicle, which vary depending on the type of vehicle and its measurements. Proper setting of the Fader and Balance boosts the effects of the cabin equalizer.

Select Preset Equalizer

1. Enter the EQ setup mode
Touch the [EQ] icon in the user interface and the EQ setup interface will display on the screen.
2. Select EQ mode
Touch the desired EQ selection: [Optimal] / [Classic] / [Rock] / [Jazz] / [Techno] / [Pop], and the EQ mode will change.

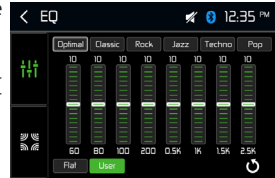

Adjust EQ Parameters

To adjust EQ parameters, touch and drag the parameters adjustment bar.

- [User]: Set the desired audio effect.
- [Flat]: Select the original audio effect.
- [⏪]: Cancel the equalizer function settings.

Adjust FAD BAL

You can adjust front/back/left/right balance of the speaker and the subwoofer volume to get balanced listening effect according to the surroundings and your interest.

1. Enter the EQ setup mode
Touch the [FAD_BAL] icon in the user interface and the EQ setup interface will display on the screen.
2. Adjust subwoofer volume
Touch [▲] / [▼] to adjust subwoofer volume from -8 to +8.
3. Adjust fader / balance value
Touch [▲] / [▼] / [◀] / [▶] to adjust fader / balance value from -14 to +14.
 - [▲]: Front speaker
 - [▼]: Rear speaker
 - [◀]: Left speaker
 - [▶]: Right speaker

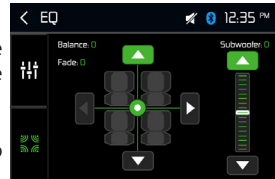

Notes:

1. The parameters of the EQ modes has been preset and you can not change them besides 'User'.
2. The EQ mode will change to 'User' automatically when you adjust the frequency value under the modes besides 'User'.
3. The value of Sub is independent of EQ mode and can be adjusted separately.

Radio Mode

Tuner TFT Display

1. Current radio band indicator.
2. Return to home menu.
3. Current station frequency.
4. Preset stations list.
5. Shortcut.
6. Band switch.
7. Seek backward
Tune backward(long press)
8. Auto searching.
9. Seek forward
Tune forward(long press)
10. Show the next page of options menu.
11. Enter EQ menu.
12. Choose local or distant seeking mode.
13. Enter frequency directly.
14. Show RDS PTY list
15. Turn on/off CT function
16. Return to the first page of options menu.

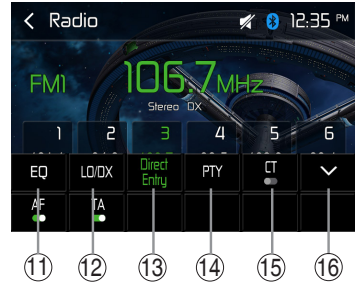

Select Radio as Playing Source

Open the Source Menu and then touch [Radio].

Select One Radio Band

Touch the [Band Select] icon on the user interface to select one radio band among FM1, FM2, FM3, AM1 and AM2.

Tune

Auto Tuning

Press [◀◀] / [▶▶] icon on the user interface to seek a higher / lower station.

To stop searching, repeat the operation above or press other keys having radio functions.

Note:

When a station is received, searching stops and the station is played.

Manual Tuning

Method 1:

During manual tuning, the frequency will be changed in steps.

Press and hold [◀◀] / [▶▶] icon on the user interface more than 1 second to tune in a higher / lower station.

Method 2:

1. Touch the numeric keypad icon [Direct Entry]. Numeric keyboard is displayed, touch numbers to input frequency.
2. Touch [<x] to delete the input numbers step by step.
3. Touch [OK] to enter.



Preset Station

The unit has 5 bands, such as FM1, FM2, FM3, AM1, AM2, and each band can store 6 stations; hence the unit can store 30 stations in total.

Search Stations Automatically

Touch [Search] to search station and store 6 strongest stations in current band automatically.

Manual Store

1. Tune to a station.
2. Long press one of the channels 1 to 6 on the screen to save the selected station.

Tune to a Preset Station

1. At radio mode, select a band (if needed).
2. Touch one of the preset channels on the screen.

Local Seeking

Press the [More ∨] and [LO/DX] icons to choose the Radio Distance or Local .
When the [Local] displays, only stations with a strong signal strength will be detected .

EQ Selection

Press the [More ∨] and [EQ] icon to enter the EQ setup menu.

RBDS

RBDS (Radio Broadcast Data System) transmits data to the radio which displays information such as station identification, song artist, and song title.

RBDS service availability varies with areas. If RBDS service is not available in your area, the following service is not available.

CT (Clock Time)

Some stations broadcast the time and date within the encoded RBDS signal. The clock time is automatically adjusted when 'CT' is set to 'ON'.

NOTE:

Stations broadcasting close to time zones may not broadcast the correct time in your particular area. In this case, turn CT Off and manually set the time.

PTY Function

PTY is the abbreviation for Program Type which is a code defining the type of program being broadcast (e.g. News or Rock).

Then PTY options will display on the screen. To view more PTY options, touch the scroll bar and arrows on the screen.

When one PTY option is touched (e.g. News), auto search for next available PTY by increasing tuning frequency until the PTY of the next station matches the current. If no matched PTY has been found, the unit will return to the original radio frequency.

Playback Mode

Basic information

This system will play the following types of discs:

The car sound system can be used to play audio DVDs/CDs and DVD/CD-R/RWs with audio or MP3 files as well as MP3 or WMA files on USB stick and SD cards.

In addition, you can view movies and images from DVDs/VCDs/CDs, USB stick and SD cards on the display.

For safety reasons, the playback of movies and images on the integrated monitor is allowed only while the vehicle is standing and the hand brake is applied. The "PARKING" cable must be connected with the hand brake connection of the vehicle (see Connection diagram at the end of these instructions).

NOTE:

This unit is designed to play pre-recorded (original) DVDs/VCDs/CDs. Some burned DVDs/VCDs/CDs may not play due to different recording formats.

Insert a disc

Upon inserting a disc, the unit will switch to **[Disc]** mode automatically.

Eject a Disc

Press the [▲] key on the front panel to eject the disc.

Touch Screen Controls

The touch key areas for DVD playback are outlined below:

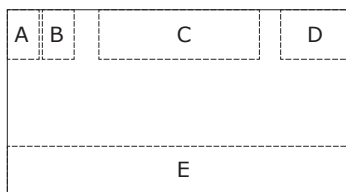

A: Return to the main menu

B: Disc type

C: Play the video and display playback information

D: Time display

E: Display onscreen control menu

Controlling Playback

To access the on-screen controls, touch the screen anywhere except for the upper left corner and touch again to cancel display. Touch [More ▼] to view all function icons.

Connecting the USB Device

1. Open the USB door.
2. Connect an USB device into the USB connector.
Play starts automatically.

NOTES:

1. If there are audio files supported on the USB stick, the system will enter the audio files menu automatically.
If there are no audio files, but there are video files supported on the USB stick, the system will enter the video files menu automatically.
If there are no audio or video files, but there are picture files supported on the USB stick, the system will enter the picture files menu automatically.
If there no above audio/video/picture files supported in the USB stick, the screen will display "Load Error!".
2. Not all USB devices are compatible with the unit.

Removing the USB Device

1. Select another source in the main menu.
2. Remove the USB device.

DVD movie playback

The car sound system can play video DVDs and VCDs. After inserting the DVD, the playback starts automatically.

The DVD menu is displayed.

You can navigate in the DVD menu by touching the corresponding buttons in the DVD menu on the screen.

After starting the movie via the menu of the DVD, the movie is displayed. The playback menu for DVDs is hidden.

NOTE:

Briefly touch the screen once to display the playback menu again.

The playback menu is shown.

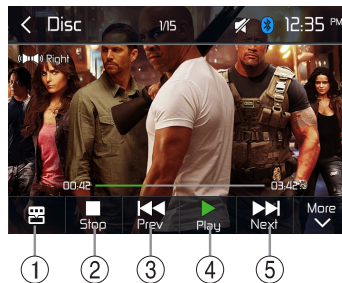

1. Shortcut.
2. Stop playback, call up home menu.
3. Select previous chapter.
4. Pause playback and continue playback.
5. Select next chapter.

Tap on [More ∨] to display additional operating options of the playback menu.



6. Select playback language (only if supported by the DVD).
7. Display equalizer.
8. Return to menu.
9. Start and end REPEAT function.
Repeat mode:
Repeat Chapter → Repeat Title → Repeat All → Repeat Off
10. Return to title.
11. Adjust the brightness, contrast, and saturation.
12. Call up keypad for direct selection of titles or chapters.
13. Select playback audio channel (only if supported by the DVD).

Audio playback

The principles of audio playback (MP3/WMA) from data carriers are identical for all sources. Select the desired source via the main menu.

The device changes to the desired source and the playback starts.

If the playback does not start with the audio playback, touch the [≡] icon to change to the folder/file list.

Touch the [📁] icon to display all the folders and files of the data carrier.

- Or -

Press the [🎵] icon to display all the audio files of the data carrier.

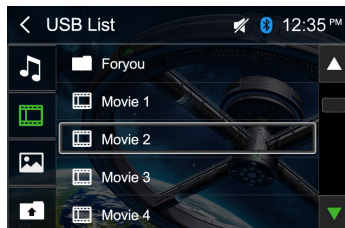

After starting a title, the playback menu is displayed.

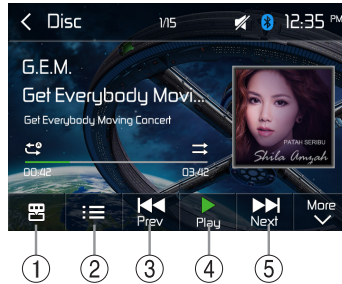

1. Shortcut.
2. Display the folder/file list.
3. Short press: Previous track.
Long press: Fast backward.
4. Pause playback and continue playback.
5. Short press: Next track.
Long press: Fast forward.

Tap on [More ▾] to display additional operating options of the playback menu.

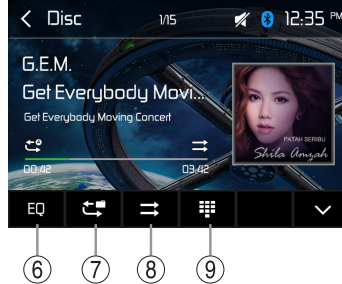

6. Display equalizer.
7. Start and end REPEAT function.
Repeat mode:
Repeat One → Repeat Folder → Repeat All → Repeat Off
8. Shuffle playback.
9. Display keypad to directly enter the number of the desired title.

Video playback

Select the desired source via the main menu.

The device changes to the desired source and the playback starts.

If the playback does not start with the video playback, touch the [≡] icon to change to the folder/file list.

Touch the [📁] icon to display all the folders and files of the data carrier.

- Or -

Touch the [] icon to display all the audio files of the data carrier.

If you selected a movie, the playback is started. During the movie playback, the playback menu is hidden.

Briefly touch the screen once to display the playback menu again.

The playback menu is shown.

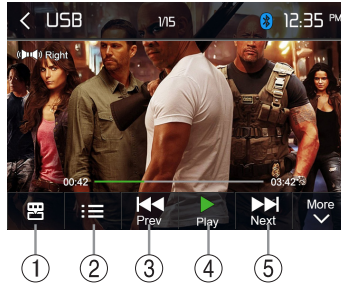

1. Shortcut.
2. Display the folder/file list.
3. Short press: Previous movie.
Long press: Fast backward.
4. Pause playback and continue playback.
5. Short press: Next movie.
Long press: Fast forward.

Tap on [More ] to display additional operating options of the playback menu.

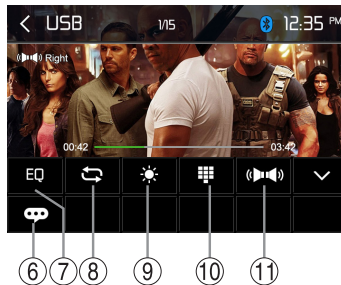

6. Select playback language.
7. Display equalizer.
8. Start and end REPEAT function.
Repeat mode:
Repeat One → Repeat Folder → Repeat All → Repeat Off
9. Adjust the brightness, contrast, and saturation.
10. Display keypad to directly enter the number of the desired title.
11. Select playback audio channel.

Image playback

Select the desired source via the main menu.

The device changes to the desired source and the playback starts.

If the playback does not start with the image playback, touch the [≡] icon to change to the folder/file list.

Touch the [📁] icon to display all the folders and files of the data carrier.

- Or -

Touch the [🖼️] icon to display all the images of the data carrier.

If you selected a image, the playback is started. During the playback, the playback menu is hidden.

Briefly touch the screen once to display the playback menu again.

The playback menu is shown.

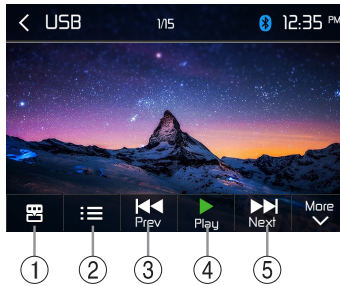

1. Shortcut.
2. Display the folder/file list.
3. Previous image.
4. Pause playback and continue playback.
5. Next image.

Tap on [More ∨] to display additional operating options of the playback menu.



6. Zoom in/out.
7. Rotate images .
8. Adjust the brightness, contrast, and saturation.
9. Display keypad to directly enter the number of the desired title.

Bluetooth Mode

You can make or receive phone calls with Bluetooth-enabled phones through the unit. You can also listen to music from a Bluetooth-enabled device.

Pair the Bluetooth-enabled Devices

To connect your Bluetooth device to the unit, you need to pair the device to the unit. Pairing needs only to be done once. You can pair up to five devices. You also can search for Bluetooth devices by mobile phone.

1. Turn ON the Bluetooth function on the device.
2. Search for Bluetooth devices by mobile phone.
3. Select the Bluetooth device ID (shown on the screen of the unit) in the pairing list.
4. Enter default password "5309" if necessary.

Tip:

- The operational range between this unit and a Bluetooth device is approximately 5 meters .
- Before you connect a Bluetooth device to this unit, familiarize yourself with the Bluetooth capabilities of the device.
- Compatibility with all Bluetooth device is not guaranteed.
- Any obstacle between this unit and a Bluetooth device can reduce the operational range.
- Keep this unit away from any other electronic device that may cause interference.



Disconnect Bluetooth Device

To disconnect one device, touch [].

Tip

- The device will also be disconnected when the device is moved beyond the operational range.
- If you want to reconnect the device to the unit, place it within the operational range.
- If you do not want to reconnect the device to the unit automatically, touch [], then set [Auto connect] to Off (the green icon turns grey).

For details, see the "Adjust Bluetooth Settings" section.



Make a Call

1. Select Bluetooth function in the home menu.
2. Pair the phone with the unit.
3. Search for phone number from the following list:
 - [Phone Book]
 - [Call Log]
 - [Missed calls]
 - [Received calls]
 - [Dialed calls]

Or touch the number pad directly, then touch [] to dial.

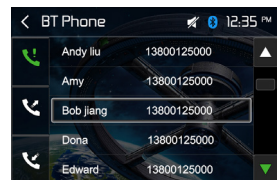

Receive a Call

By default, all incoming calls are received automatically.

1. If there is an incoming call, the screen will appear "Incoming call...".
2. You may touch the screen to select [📞] or [📞].
Speak into the Bluetooth microphone.

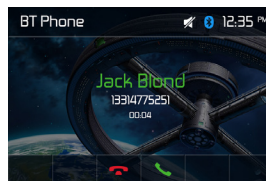

Tip

- You can select to receive calls manually by set [Auto answer] to Off status.

Adjust Bluetooth Settings

1. In Bluetooth menu, touch [⚙️].
The option menu is displayed.
2. Touch on the selected option to change the setting.
 - [Bluetooth]: To turn on or off "Bluetooth" function.
 - [Auto connect]: To turn on or off "Auto connect" function.
 - [Auto answer]: To turn on or off "Auto answer" function.
 - [Pin code]: To set pairing code.
 - [Phone sync]: Phonebook sync may take several minutes to load on initial setup.



Music Mode

A2DP

A2DP is short for Advanced Audio Distribution Profile. The mobile phones supporting this function can transmit stereo audio, whereas the ones not supporting this function can transmit mono audio only.

AVRCP

AVRCP is short for Audio/Video Remote Control Profile. The mobile phones supporting this function can control the playback of a Bluetooth audio player.

In the mode of the music player working, if you want to make a phone call, you can press the number keys on the mobile phone. At the same time the music player will stop. The TFT screen will display "Calling", after the call received, the voice will be transferred to the unit. When the call ends, the screen will display music playing menu.

If there is an incoming phone call, the music player will stop, and the screen will display "Incoming". When the call ends, the screen will display music playing menu.

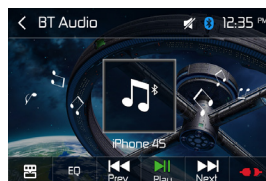

iPod Mode

Connect an iPod or iPhone to the unit via an iPod cable.

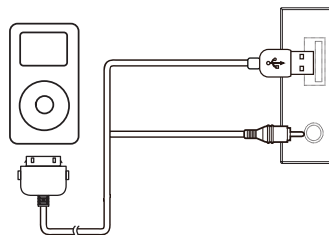

Accessing iPod mode

Touch [iPod] on the main menu to enter iPod menu.

If [iPod] is not on the current source menu, hold the center of screen and drag left/right to show more icons.

1. Return to main menu
2. Show Music files
3. Show Video files
4. Show Folders
5. File list

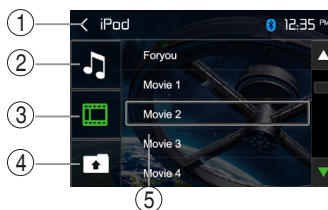

Pausing play

1. Touch the [||] button on the bottom of the screen to pause play. "PAUSE" appears in the display, and [||] button becomes [▶].
2. Touch [▶] button to resume play.

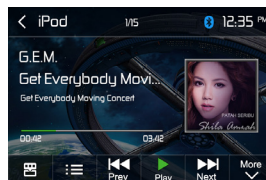

Selecting a track

Track-up

Touch the [▶▶] button to move to the beginning of the next track.

Track-down

1. Touch the [◀◀] button to move back to the beginning of the current track.
2. Touch the [◀◀] button twice to move back to the beginning of the previous track.

Fast forward/Fast reverse

Fast forward

Touch and hold the [▶▶▶] button .

Fast reverse

Touch and hold the [◀◀◀] button .

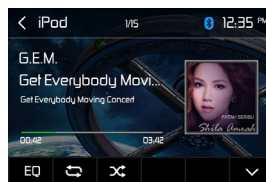

Repeat play

This function allows you to play the track repeatedly.

Touch the [↺] button to select Repeat one or Repeat all.

Random play

This function allows you to play all tracks recorded in a random order.

Touch the [↻] button to perform random play. The icon becomes [⌘], touch it to resume normal play.

PANDORA® RADIO OPERATION

Pandora Radio is available on your iPhone® / iPod® touch via USB cable or an Android™ device via Bluetooth®. Data usage may occur.

Note: Pandora is available in the United States, Australia and New Zealand.

Note: The Pandora Radio app must be installed on your iPhone®/iPod® touch or Android device. For iPod®/ iPhone® connectivity, you can use the cable that comes with your Apple device for audio connectivity. To play Pandora Radio using an Android device, it is necessary to pair your mobile phone via Bluetooth to the VX3024. A cable connection for Pandora via Android is not supported.

Pandora Radio

The on-screen indicators and touch key areas for Pandora Radio functions are outlined below.

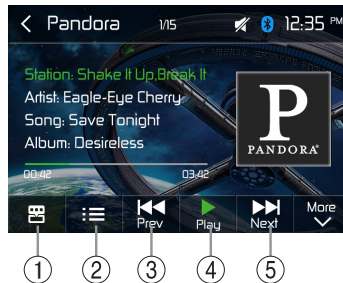

1. Shortcuts
2. Station List Icon - Press this icon to access the Station List Screen.
3. Prev Icon - Press this icon skip a song, subject to the skip limit.
4. Pause / Play Icon - Touch the icon to pause playback. Touch the icon to begin playback.
5. Next Icon - Press this icon skip a song, subject to the skip limit.
Pandora will skip to the next track. If the skip limit has been reached, Pandora will continue to play but your feedback will be recorded.

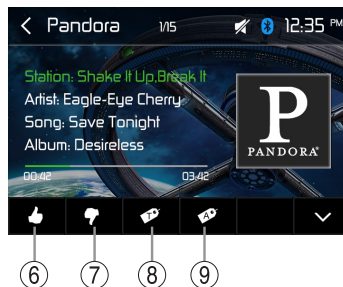

6. Thumbs Up Icon - Press thumbs up to tell Pandora you like the track currently playing, and Pandora will play more tracks like it.
7. Thumbs Down Icon - Press thumbs down to tell Pandora not to play this track.
8. Bookmark Track Icon - Touch to bookmark a track.
9. Bookmark Artist Icon - Touch to bookmark an artist.

Station List Screen

The Station List Screen allows you to search for music by stations you created.

Touch a station on the list to choose that station.

Touch the Scroll Down (▼) icon to view the next page in the list or the

Scroll Up (▲) icon to view the previous page.

Touch the top left corner of the screen to return to the Pandora Radio user interface screen.

To Launch/Stop Pandora Radio

1. Launch the Pandora app on the iPhone®, iPod® or Android device.
2. Touch the Pandora icon on the main menu screen. If only one device is connected to the radio, the Pandora Radio user interface screen appears.
3. If both an Android device and iPhone®/ iPod® are connected to the radio, the Select Android or iOS Screen appears.

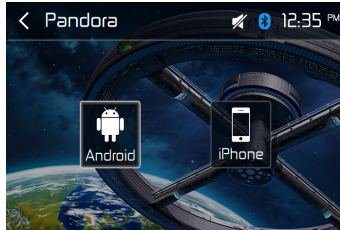

4. To stop Pandora, exit the Pandora app on the iPhone®, iPod® or Android device.

Settings

Display System

1. Touch the upper left corner to display main menu.
2. Touch [Settings].
The settings menu is displayed.

Adjust General Settings

1. Touch [General], if necessary.
2. Touch to highlight a setting.
3. Touch on the option to display/select an option.

General settings	Options	Description
Radio Region	USA/China/Japan/Europe/Europe (LW)/OIRT	Select one that matches your location.
Radio Range	Local	Select radio local or distance. When select local, only stations with sufficient strength will be detected.
	Distance	
Beep	On	Turn on the beep sound. Each time you press a button, the unit beeps.
	Off	Turn off the beep sound.
Demo	On	Enable the demo of operations.
	Off	Disable the demo of operations.
Calibration	Start	Calibrate the touch screen.
Shortcut	Seat1/2/3/4	Set the shortcuts in the options menu.
SWC	Show the definition of Steering Wheel Control buttons.	
Load Factory	Restore to default settings.	

4. Touch top left of the screen to exit.

Calibration

When the touch operation is not sensitive or valid, you should calibrate the touch screen through calibration setting function. Adjust the response positions of the touch panel as followings:

1. Press the [Calibration] option on the setup menu to enter.
2. Touch [Start] to enter.
3. Press and hold the center of [+] for 2 seconds, the [+] will move automatically.
4. Aim at center of [+], follow the path as shown of the figure, after steps from 1 to 5, the system will exit calibrating automatically.

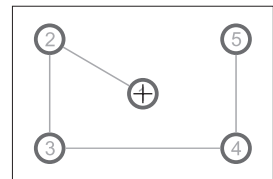

Adjust sound settings

1. Touch [Audio].
2. Touch an option repeatedly to select:

Sound settings	Options	Description
Subwoofer	On	Turn on the subwoofer.
	Off	Turn off the subwoofer
Sub Woofer Filter	80Hz	Select subwoofer filter criteria.
	120Hz	
	160Hz	
Loudness	On	Turn on the Loudness.
	Off	Turn off the Loudness

3. Touch top left of the screen to exit.

Adjust Time Settings

1. Touch [Time].
2. Touch an option repeatedly to select:

Sound settings	Options	Description
Date	Y/M/D	Touch [▲] or [▼] to set year, month and day.
Clock Format	12Hr/24Hr	Touch [12Hr] or [24Hr] to switch clock mode.
Time	H/M/AM/ PM	Touch [▲] or [▼] to set hour and minute. Touch [▲] or [▼] to set AM/PM (only for 12Hr).

3. Touch top left of the screen to exit.

Adjust Language Settings

1. Touch [Language].
2. Touch an option repeatedly to select:

Language settings	Description
OSD	Select on-screen display language.
DVD Audio	Select DVD audio language. Options available depend on DVD disc.
DVD Subtitle	Select DVD subtitle language. Options available depend on DVD disc.
Disc Menu	Select DVD menu language. Options available depend on DVD disc.

3. Touch top left of the screen to exit.

Adjust Video

1. Touch [video].
2. Touch an option repeatedly to select.

DVD rating	Options	Description
Aspect Ratio	Full	Set the Aspect Ratio of the video image.
	Normal	
Password	Set password to restrict the play of discs. The default password is 4321.	
Rating	Kid safe	Acceptable for children.
	G	Acceptable for general viewers.
	PG	Parental guidance suggested.
	PG-13	Unsuitable for children under age 13.
	PG-R	Recommend parents to restrict children under 17 to view.
	R	Restricted recommend parents to guide children under 17 to view.
	NC-17	Unsuitable for children under age 17.
Adult	Acceptable for adults only.	
Adjust	Adjust the Brightness/Contrast/Saturation of the video image.	

3. Touch top left of the screen to exit.

Adjust Volume Settings

You can set different volume for different modes.

1. Touch [Volume].
The volume setting sub-menu is displayed.
2. Touch to select a source.
3. Select a value from 00 to 06.
When switching to the source, the volume increases automatically.
4. Touch top left of the screen to exit.

Other Modes

Listen to Other Devices

You can connect an external audio/video device to the unit.

1. Connect the external device with the supplied AV cable.
2. Touch the upper left corner to display the main menu.
3. Touch [Aux-1]/[Aux-2] to access external device.

Reset

When the unit hangs up, you can reset it.

Open the cap located on the bottom left of the panel, press [RESET] with a ball-point pen or similar tool.

Tip

When the unit has been reset, all the settings will return to default settings.

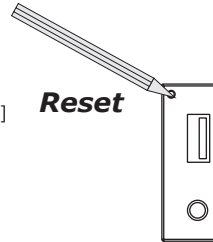

Replace a Fuse

If there is no power, the fuse may be damaged and need to be replaced.

1. Take out the unit from dashbpard.
2. Check all electrical connections.
3. Buy a fuse that matches the amperage of the damaged fuse.
4. Replace the fuse while the units power is disconnected.

Specifications

General

Reference Supply Voltage	12V(DC)
Operating Voltage Range	10.5 - 15.8V(DC)
Max Operating Current	15A
Grounding System	Car Battery Negative Pole
Dimensions(WXHXD)	178*100*167mm
Weight(main unit)	1.74kg

FM

Signal Noise Ratio	≥55dB
Residual Noise Sensitivity (S/N=30dB)	18dBμV
Frequency Response (±3dB)	20Hz~12.5KHz
Station Seeking Level	20~28dBμV
Distortion	≤1.0%
Stereo Separation (1KHz)	≥25dB
Antenna Impedance	75Ω

AM

Residual Noise Sensitivity (S/N=20dB)	30dBμV
Selectivity (±9KHz)	≥50dB

LCD

Screen size	6.2 inches(16:9)
Display resolution	800X480dots
Contrast ratio	4000:1

DVD Player

Signal / Noise Ratio	80dB
Dynamic Range	80dB
Distortion (line out)	≤0.1%
Frequency Response (±3dB)	20Hz~20KHz
Maximum Output Power	4×40W
Load Impedance	4Ω

AUX IN

Distortion	≤0.5%
Frequency Response (±3dB)	20Hz~20KHz
Audio Input Level	0.5Vrms

Audio

Audio Output Impedance	100Ω
Audio Output Level	4Vrms

Video

Normal Video Input Level (CVBS)	1.0±0.2V
Video Input Impedance	75Ω
Video Output Impedance	75Ω
Video Output Level	1.0±0.2V

Environment

Operating Temperature	-10°C ~ +60°C
Storing Temperature	-20°C ~ +70°C
Operating Humidity	45%~80%RH
Storing Humidity	30%~90%RH

Notice:

When the unit is operated to extremes, such as with maximum power output for a long time, or the temperature is over 70°C, it will enter heat protection mode, the volume will be reduced automatically. This is normal.

Supported Formats:

- USB or memory file format: FAT16,FAT32
- Mp3 bit rate(date rate): 32-320 Kbps and variable bit rate
- Directory nesting up to a maximum of 8 levels
- Number of albums/folders: maximum 99
- Number of tracks/titles: maximum 999
- ID3 tag v2.0 or later
- File name in Unicode UTF8(maximum length:128 bytes)

Unsupported Formates:

- Empty albums:an empty album is an album that does not contain MP3 files,and is not be shown in the display.
- Unsupported file formats are skipped.For example,Word documents(.doc) or Mp3 files with extension.dlf are ignored and not played.
- AAC,WMV,PCM audio files

Supported MP3 Disc Format:

- ISO9660,Joliet
- Maximum title number: 512(depending on file name length)
- Maximum album number: 255
- Supported sampling frequencies: 32kHz,44.1kHz,48kHz
- Supported Bit-rates: 32-320Kbps and variable bit rate

Supported Video Formats:

- DVD
- MP4

Region Code

According to DVD sale region, the whole world is divided into six regions. A DVD disc can be played back only when its region code is compatible with that of the player in use.

Region 1: USA, Canada, East Pacific Ocean Islands;

Region 2: Japan, West Europe, North Europe, Egypt, South Africa, Middle East;

Region 3: Taiwan of China, Hong Kong of China, South Korea, Thailand, Indonesia, South East Asia;

Region 4: Australia, New Zealand, Mid & south America, South Pacific Ocean Islands/Oceania;

Region 5: Russia, Mongolia, India, Middle Asia, East Europe, North Korea, North Africa, North West Asia;

Region 6: China, Mainland.

Cautions when using Discs

- 1) DO NOT use irregular shaped disc.
- 2) Disc Cleaning
Use a dry, soft cloth to wipe the disc from center to edge, only neutral detergent can be used.
- 3) When playing a new disc
New disc may have some rough spots around the inner and outer edges. If such a disc is used, remove these rough spots with a pencil or ball-point pen, etc.

Troubleshooting

What appears to be trouble is not always serious. Please check the following points before calling a service center.

Problem	Cause	Corrective action
General		
Unit can not power on	Unit fuse blown.	Install new fuse with correct rating.
	Car battery fuse blown.	Install new fuse with correct rating.
	Illegal operation	Reset the unit.
No/low audio output	Improper audio output connection.	Check wiring and correct.
	Volume set too low.	Increase volume level.
	Speakers damaged.	Replace speakers.
	Heavily biased volume balance.	Adjust the channel balance to center position.
	Speaker wiring is in contact with metal part of car.	Insulate all speaker wiring connections.
Poor sound quality or distortion	Pirated disc is in use.	Use original disc.
	Speaker power rating does not match unit.	Replace speakers.
	Wrong connections.	Check wiring and correct.
	Speaker is shorted.	Check wiring and correct.
Tel-Mute malfunction	MUTE wire is grounded.	Check the 'MUTE' wiring and correct.
Unit resets itself when engine is off	Incorrect connection between ACC and BATT.	Check wiring and correct.
TFT monitor		
Warning information is shown at all times	Parking break wiring is not correct.	Check wiring and correct.
Flashing image or interference appears on screen	The color system of DVD disc does not match the monitor.	Adjust the color system of the DVD disc playing back or the monitor in use.
	Pirated disc is in use.	Use original disc.
	Video cable damaged.	Replace cables.
	Improper video signal connections.	Check wiring and correct.
Disc playback		
Cannot insert disc	A disc is already inside the unit.	Eject current disc and insert new one.
Disc does not play back	Disc is warped or scratched.	Use disc in good condition.
	Disc is dirty or wet.	Clean disc with soft cloth.
	Incompatible disc is used.	Use compatible disc.
	Disc is inserted upside down.	Insert disc with label side up.
	Disc region code is not compatible with unit.	Use disc with proper region code.
PBC cannot be used during VCD playback	PBC is not available on the disc.	Use disc with PBC available.
Repeat or search function is invalid during VCD playback	PBC is on.	Turn PBC off.
Error messages		
No disc	Disc is dirty.	Clean disc with soft cloth.
	Disc is upside down.	Insert disc with label side up.
	No disc inside.	Insert disc.
Bad disc	Disc is dirty.	Clean disc with soft cloth.
	Disc is upside down.	Insert disc with label side up.
Unknown disc	Disc format is not compatible with this unit.	Use disc with compatible format.
Region Error	DVD region code is not compatible with this unit.	Use disc with compatible region code.

Wire Connections

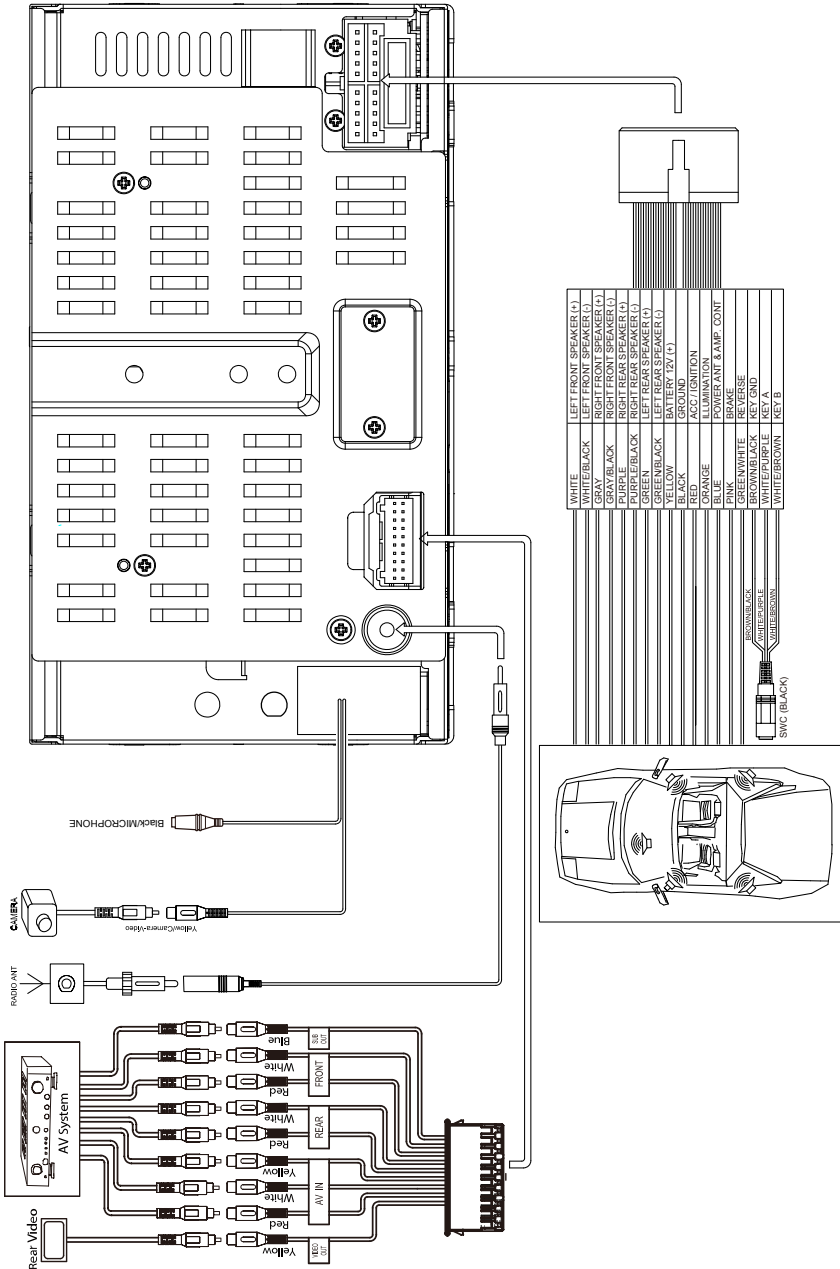

Dual Electronics Corporation
Heathrow, FL 32746
Technical Assistance: 1-888-921-4088
www.jensenmobile.com
© 2015
Printed in China