



by Johnson Safty Inc.

K17

In-Dash
Double Din
Multimedia
SmartLink



DVD | CD | MP3 | SD | USB | BLUETOOTH | SMARTLINK

Operating Instructions

Safety Precautions

Thank you for purchasing this product. Please read through these operating instructions so you will know how to operate your model properly. Please keep this manual in a safe place for future reference.

Only connect the unit to a 12-volt power supply with negative grounding.

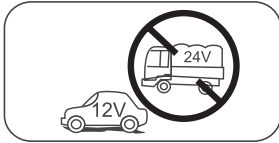

Never install this unit where operating it may impair safe driving conditions.

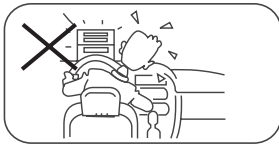

Never use the front video display function when driving, so as to prevent violating traffic regulations or causing an accident.



Never expose this unit, amplifier, and speakers to moisture or water to prevent electric sparks or fire.

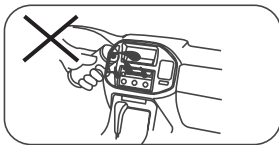

Do not change the fuse on the power cord without professional guidance. Using an improper fuse may cause damage to this unit or even cause fire.

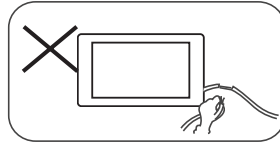

Please contact your nearest dealer if one of the following is experienced:

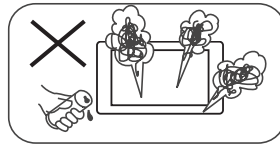

- (a). Water or other objects enter the unit.
- (b). There is smoke.
- (c). Peculiar smell.

To ensure safe driving, please adjust the volume to a safe and comfortable level in case of emergency situations.

Safety Precautions

1. Never disassemble or adjust the unit without any professional guidance.
For details, please consult any professional car shop / dealer for inquiry.
2. If the front panel or TFT monitor is dirty, please use a clean silicone cloth and neutral detergent to wipe off the spot. Using a rough cloth and non-neutral detergent such as alcohol for cleaning may result in scratching or decoloration to the monitor.
3. If any abnormal behavior of the unit is found, please refer to trouble shooting guide of this manual. If no relevant information is found, please press the [RESET] key on the front panel to resume factory default.
4. If you have parked the car in hot or cold weather for a long time, please wait until the temperature in the car becomes normal before operating the unit.
5. Using the car heater in low temperature environment may result in moisture inside the unit, DO NOT use the unit in this situation. Eject the disc and wipe off the moisture on the disc. If the unit still doesn't work after a few hours, please contact the service center.
6. Do not impact the LCD monitor which could cause damage.
7. To prevent damage to the screen, avoid touching it with sharp objects.
8. To provide a clear demonstration and an alternative for easy understanding to the operation of this unit, graphic illustrations are used.
However, some illustrations are different from the actual images displayed on the screen.
9. Operate the unit correctly according to this manual to prevent unnecessary problem. The guarantee won't be valid if the problem is caused by inappropriate operation.

FCC STATEMENT

1. This device complies with Part 15 of the FCC Rules. Operation is subject to the following two conditions:
 - (1) This device may not cause harmful interference.
 - (2) This device must accept any interference received, including interference that may cause undesired operation.
2. Changes or modifications not expressly approved by the party responsible for compliance could void the user's authority to operate the equipment.

NOTE: This equipment has been tested and found to comply with the limits for a Class B digital device, pursuant to Part 15 of the FCC Rules. These limits are designed to provide reasonable protection against harmful interference in a residential installation.

This equipment generates uses and can radiate radio frequency energy and, if not installed and used in accordance with the instructions, may cause harmful interference to radio communications. However, there is no guarantee that interference will not occur in a particular installation. If this equipment does cause harmful interference to radio or television reception, which can be determined by turning the equipment off and on, the user is encouraged to try to correct the interference by one or more of the following measures:

- Reorient or relocate the receiving antenna.
- Increase the separation between the equipment and receiver.
- Connect the equipment into an outlet on a circuit different from that to which the receiver is connected.
- Consult the dealer or an experienced radio/TV technician for help.

FCC Radiation Exposure Statement

This equipment complies with FCC radiation exposure limits set forth for an uncontrolled environment. This equipment should be installed and operated with minimum distance 20cm between the radiator & your body

Contents

Safety Precautions	1
Before Using	4
Front Panel	4
Basic Operations	5
Power On / Off	5
Playing Source Selection	5
Mute	5
Volume Adjustment	5
Audible Beep Confirmation	5
Parking Brake Inhibit	5
Adjusting Equalizer Controls	5
Equalizer (EQ)	5
Adjusting the Fader and Balance	6
Settings	7
System Settings	7
General Settings	7
Calibration	7
SWC Programming	7
Audio Settings	8
Time Settings	8
Language Settings	9
Video Settings	9
Adjust Volume Settings	9
Radio Mode	10
Select Radio as Playing Source	10
Select One Radio Band	10
Tune	10
Preset Station	10
Local radio station seeking	11
EQ Selection	11
RBDS	11
Playback Mode	12
Basic information	12
Insert a disc	12
Eject a Disc	12
Touch Screen Controls	12
Controlling Playback	12
Connecting the USB Device	12
Removing the USB Device	12
Inserting the SD card	12
Removing the SD card	13
DVD movie playback	13
Audio playback	13
Video playback	14
Image playback	15
Bluetooth Mode	16
Pairing Bluetooth Enabled Devices	16
Disconnecting a Bluetooth Device	16
Make a Call	16
Receiving a Call	17
Adjust Bluetooth Settings	17
Bluetooth Music Function	17
iPod/iPhone Operations	18
Accessing iPod mode	18
Pausing play	18
Selecting a track	18
Fast forward/Fast backward	18
Repeat play	18
Random play	18
Search function	18
SmartLink	19
About SmartLink	19
About HDMI	19
Connect with Android Phone	19
Connect with iPhone	19
Setting	20
Limitations	20
Other Modes	21
Aux 1 / Aux 2 Controls	21
Reset	21
Replace a Fuse	21
Rear Camera Operation	21
Specifications	22
Troubleshooting	24
Wire Connections	25

Before Using

Front Panel

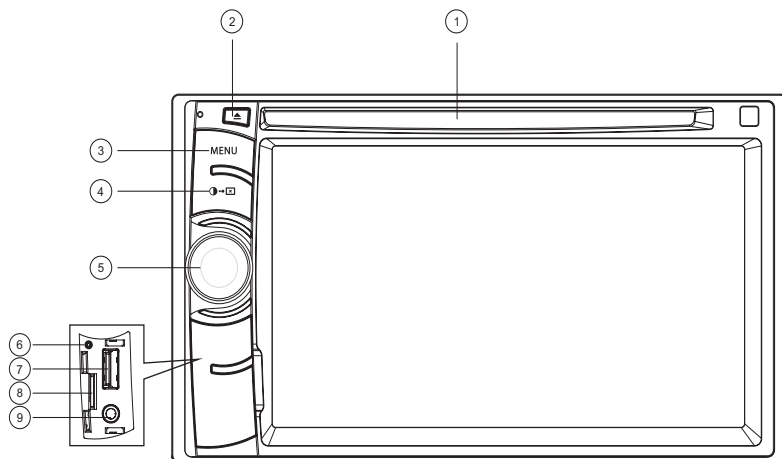

Notice:

The graphics in this manual are for reference purposes only and may differ somewhat from the actual unit.

1. Disc slot

2. [▲] Button

Press to eject a disc.

3. [MENU] Button

Press to display the main menu

4. [●→☐] Button

Adjust the brightness of screen.

5. Power/Volume knob

Rotate to adjust volume.

Press briefly to activate the MUTE function. Press again to resume normal sound.

Press and hold to turn the unit OFF.

6. Reset Hole

7. USB Socket

8. SD card reader for media.

9. A/V IN Socket

Basic Operations

Power On / Off

Press the Power/Volume knob on the unit or [] on the remote control to turn the unit ON. The buttons on the front panel light up for a moment and the current mode status appears on LCD.

Press and hold the knob or [] on the remote control to turn OFF the unit.

Playing Source Selection

Press the [**MENU**] button on the front panel or [**SRC**] on the remote control to display the playing source menu.



1. < or >: Touch to view the previous or next page of playing sources.
2. Time and Date
3. Playing source icon: touch to access corresponding work mode.
4. Mute indicator
5. Bluetooth status

Mute

Press the Power/Volume knob on the front panel or press [**MUTE**] on the remote control to mute the volume from the unit. Press again to restore the volume. Adjusting the volume or using any of the audio setup features cancels the mute function.

Volume Adjustment

To increase or decrease the volume level, turn the knob on the front panel or press [+]/[-] on the remote control. The volume range is from “0” to “40”. The TFT screen displays the volume level for 3 seconds.

Audible Beep Confirmation

An audible beep tone confirms each function selection. The Beep tone can be disabled through the Setup menu.

Parking Brake Inhibit

- When the “BRAKE” wire is connected to the brake switch, the TFT monitor will display video only when the vehicle is parked.
- Parking brake function is overridden when the video source is set to REVERSE.
- When the parking brake inhibit is active, the front monitor displays Warning information, preventing the driver from watching content while driving. Rear video screens are not affected.

Adjusting Equalizer Controls

The Equalizer adjustment screen allows the user to easily adjust the audio system to meet the acoustical characteristics of the vehicle depending on vehicle type and cabin dimensions.

For example: proper setting of the audio controls can improve the speakers frequency response.

The Balance/Fade levels also adjusted through the Equalizer adjustment screen.

Equalizer (EQ)

Touch the Equalizer [] icon to view and select a desired acoustical preset level (Optimal / Classic / Rock / Jazz / Techno / Pop or User).

Basic Operations

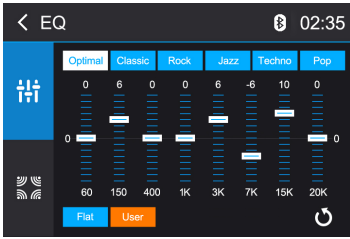

NOTE:

The equalizer will automatically change to “USER” when individual audio functions are adjusted.

Adjusting the Fader and Balance

The user can adjust front/rear fader settings, L/R balance settings, and subwoofer levels here.

1. Enter the EQ setup mode.
2. Touch the [] icon in the EQ interface menu.

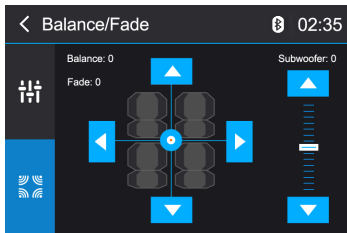

Balance

This feature is used to balance the audio output levels between the left and right side of the vehicle. Touch the [◀] / [▶] icons to change the balance control settings -14 (Left) to +14 (Right). The setting can also be changed by touching screen within the grid to move the blue sphere.

Fader

This feature is used to fade the audio output levels between the front and rear of the vehicle. Touch the [▲] / [▼] icons to change the fade control settings -14 (Rear) to +14 (Front). The setting can also be changed by touching screen within the grid to move the blue sphere.

Subwoofer

This feature is used to reduce or increase the subwoofer sound level. Touch the [▲] / [▼] icons to adjust the subwoofer volume from -8 to +8. This setting will vary depending on the input level setting of your subwoofer amplifier.

To exit the Balance/Fader touch the return icon on the top left corner of the screen.

NOTE:

The EQ mode will change to ‘User’ automatically when you adjust the frequency value in all modes besides ‘User’.

Settings

System Settings

1. Press the [MENU] button on the front panel or [SRC] on the remote control to display the playing source menu.
2. Touch the Settings icon [⚙️] and the settings menu is displayed.

General Settings

1. Touch [⚙️], if necessary.
2. Touch to highlight a setting to display/select an option.

General Settings	Options	Description
Radio Region	USA/Asia/Japan/Europe/Europe LW/Oirt	Select one that matches your location.
Radio Range	Distance	Select Local to receive only stations with extremely strong signal.
	Local	
Beep	On	Turn-ON the beep sound. Each time you press a button, the unit beeps.
	Off	Turn-OFF the beep sound.
Key Color	Choose the backlight color of the buttons.	
Calibration	Start	Calibrate the touch screen.
Shortcut	Set the shortcut.	
SWC	Enter to SWC interface	
Load Factory	Restore to default settings.	

Calibration

When the touch operation is not sensitive or valid, you should calibrate the touch screen using the calibration setting function. Adjust the response positions of the touch panel as followings:

1. Touch [Start] to enter.
2. Touch [Cancel] to exit.
3. Press and hold the center of [+] for 2 seconds, the [+] will move automatically.
4. Aim at center of [+], follow the path as shown in the figure. Once steps 1-5 are complete, touch [OK] to exit calibrating mode.

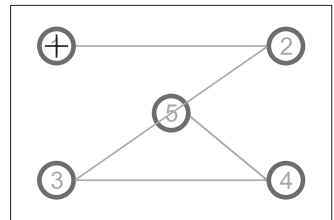

SWC Programming

The following controls are available for most vehicles:

1	2	3	4	5	6
Volume +	Volume -	Mute	Next	Prev	Play
7	8	9	10	11	12
Siri	Preset +	Preset -	Band	Source	Answer

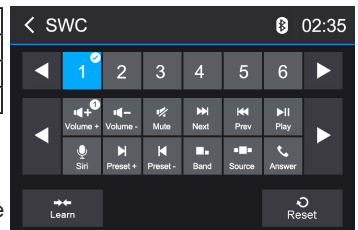

Touch [Enter], the SWC menu will display.

Up to 12 steering wheel control functions can be programmed via the built-in SWC interface. Not all functions may be supported for each vehicle.

Settings

1. Popular OE steering wheel functions are already pre-programmed from the factory. If your vehicle does not support the exact same functions already pre-programmed, you will need to clear / reset the SWC interface and program in the exact functions of your vehicle. To clear / reset the SWC interface, touch [**Reset**] icon.
2. To begin programming the SWC interface after it has been cleared / reset, press a number 1 ~ 12, then press a function. A check mark should appear corresponding to the number and function. Continue programming in this manner until all of the OE steering wheel control functions are completed.

NOTE:

Functions 1 ~ 12 must be assigned to a function on the OE steering wheel. For example, if the OE steering wheel does not support Preset + and Preset -, then these functions must be cleared / reset in order for the other functions to work correctly.

3. To “learn” the programming completed in step 2 above, touch the [**Learn**] icon. You will then be prompted to push each button on the OE steering wheel (for 1 second), so the unit can learn the corresponding function.
4. SWC learning / programming is now complete.
5. Touch [<] to exit.





Audio Settings

1. Touch [].
2. Touch an option repeatedly to select.

Audio Settings	Options	Description
Subwoofer	On	Turn On the subwoofer.
	Off	Turn Off the subwoofer
Subwoofer Filter	80Hz	Select a crossover frequency to set a cut-off frequency for the subwoofer's LFP (low-pass filter).
	120Hz	
	160Hz	
Loudness	On	Turn On the loudness
	Off	Turn Off the loudness

Time Settings

1. Touch [].
2. Touch an option repeatedly to select.

Time Settings	Options	Description
Date	Y/M/D	Touch [] or [] to set year, month and day.
Clock Format	24Hr/12Hr	Touch [24Hr] or [12Hr] to switch clock mode.
Time	H/M	Touch [] or [] to set hour and minutes.

NOTE:

When date/time is set, touch [**Save**] to confirm or [**Cancel**] to exit.

Settings

Language Settings

1. Touch [].
2. Touch an option repeatedly to select.

Language Settings	Description
OSD Language	Select on-screen display language.
DVD Audio	Select DVD audio language. Options available depending on DVD disc.
DVD Subtitle	Select DVD subtitle language. Options available depending on DVD disc.
DVD Menu	Select DVD menu language. Options available depending on DVD disc.

Video Settings

1. Touch [].
2. Touch an option repeatedly to select.

Video Settings	Options	Description
Aspect Ratio	Full	Adjust aspect ratio.
	Normal	
Parking	On	Disable video when driving.
	Off	Enable video when driving.
Password	Set password to restrict the play of discs. The default password is 0000.	
Rating	1 Kid Safe	Acceptable for children.
	2 G	Acceptable for general viewers.
	3 PG	Parental guidance suggested.
	4 PG13	Unsuitable for children under age 13.
	5 PG-R	Recommend parents to restrict viewing for children under 17.
	6 R	Restricted re-parental guidance is advised for children under the age of 17.
	7 NC-17	Unsuitable for children under age 17.
	8 Adult	Acceptable for adults only.
Adjust	Enter	Touch [+] or [-] to adjust brightness, contrast and saturation.
Version Info	Enter	Display the current version information

Adjust Volume Settings

You can set different volumes for different sources.

1. Touch the [] icon to display and access the volume setting sub-menu
2. Touch the source to be adjusted.
3. The volume range is from "00" to "06"
When switching to the source, the volume increases automatically.
4. Touch blank area to close the sub-menu and touch the upper left corner icon [<] to exit setting menu.

Radio Mode

Select Radio as Playing Source

Open the Source Menu and then touch [Radio].



1. Current radio band indicator.
2. Return to home menu.
3. Current station frequency.
4. Preset stations list.
5. Shortcut.
6. Band switch.
7. Tune backward.
8. Auto searching.
9. Tune forward.
10. Opening/closing the options menu.
11. Enter EQ menu.
12. Choose local or distant seeking mode.
13. Enter frequency directly.
14. To show PTY list.
15. To turn On or Off “Clock Time” synchronization function.

Select One Radio Band

Touch the [Band] icon on the user interface to select one radio band among FM1, FM2, FM3, AM1 and AM2.

Tune

Auto Tuning

Press [◀◀] / [▶▶] on the remote control or touch [◀◀] / [▶▶] icons on the user interface to seek a higher / lower station.

To stop searching, repeat the operation above or press other keys having radio functions.

NOTE:

When a station is received, searching stops and the station is played.

Manual Tuning

Method 1:

Press the [▶▶] / [◀◀] on the remote control or touch [◀◀] / [▶▶] icon on the user interface for more than 1 second to enter Manual Tuning mode.

During manual tuning, the frequency will be changed in steps.

Method 2:

1. Touch the numeric keypad icon [⌨].
Numeric keyboard is displayed, touch numbers to input frequency.
2. Touch [⏪] to delete the input numbers step by step.
3. Touch [OK] to enter.

Preset Station

The unit has 5 bands, such as FM1, FM2, FM3, AM1, AM2, and each band can store 6 stations; hence the unit can store 30 stations in total.

Search Stations Automatically

Touch the search icon [🔍] to search stations and store the 6 strongest stations in the current band automatically.



Manual Store

1. Tune to a desired station.
2. Touch and hold one of the presets (1 to 6) to save the selected station.

Recalling a Station

1. Select a band.
2. Touch an on-screen preset button to select the corresponding stored station.

Local radio station seeking

When the Local function is on, only radio stations with a strong local radio signal are played. To activate the Local function in the AM/FM tuner mode, touch [] on the screen. The Options tab is revealed. Touch [], icon and choose the Radio Local or Distance. When the Local function is active, the “Local” indicator on the screen is illuminated. When the Distant function is active, the “Distance” indicator on the screen is illuminated.

EQ Selection

Press the [] icon and enter the EQ setup.

RBDS

RBDS (Radio Broadcast Data System) transmits data to the radio which displays information such as station identification, song artist, and song title.

RBDS service availability varies with areas. If RBDS service is not available in your area, the following service is not available.

CT (Clock Time)

Some stations broadcast the time and date within the encoded RBDS signal. The clock time is automatically adjusted when ‘CT’ is set to ‘ON’.

NOTE:

Stations broadcasting close to time zones may not broadcast the correct time in your particular area. In this case, turn CT Off and manually set the time.

PTY Function

PTY is the abbreviation for Program Type which is a code defining the type of program being broadcast (e.g. News or Rock).

Then PTY options will display on the screen. To view more PTY options, touch the scroll bar and arrows on the screen.

When one PTY option is touched (e.g. News), auto search for next available PTY by increasing tuning frequency until the PTY of the next station matches the current. If no matched PTY has been found, the unit will return to the original radio frequency.

Playback Mode

Basic information

This system will play the following types of discs:

The car sound system can be used to play audio DVDs/CDs and DVD/CD-R/RWs with audio or MP3 files as well as MP3 or WMA files on USB stick and SD cards.

In addition, you can view movies and images from DVDs/VCDs/CDs, USB stick and SD cards on the display.

For safety reasons, the playback of movies and images on the integrated monitor is allowed only while the vehicle is standing and the hand brake is applied. The "PARKING" cable must be connected with the hand brake connection of the vehicle (see Connection diagram at the end of these instructions).

NOTE:

This unit is designed to play pre-recorded (original) DVDs/VCDs/CDs. Some burned DVDs/VCDs/CDs may not play due to different recording formats.

Insert a disc

Upon inserting a disc, the unit will switch to [Disc] mode automatically.

Eject a Disc

Press the [▲] key on the front panel or [EJECT] on the remote control to eject the disc.

Touch Screen Controls

The touch key areas for DVD playback are outlined below:

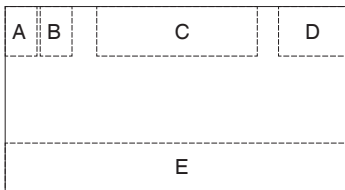

- A: Return to the main menu
- B: Disc type
- C: Play the video and display playback information

D: Time display

E: Display onscreen control menu

Controlling Playback

To access the on-screen controls, touch the screen anywhere except for the upper left corner and touch again to cancel display. Touch [••••] to view all function icons.

Connecting the USB Device

1. Open the USB door.
2. Connect an USB device into the USB connector.
Play starts automatically.

NOTES:

1. If there are audio files supported on the USB stick, the system will enter the audio files menu automatically.
If there are no audio files, but there are video files supported on the USB stick, the system will enter the video files menu automatically.
If there are no audio or video files, but there are picture files supported on the USB stick, the system will enter the picture files menu automatically.
If there no above audio/video/picture files supported in the USB stick, the screen will display "Load Error!".
2. Not all USB devices are compatible with the unit.

Removing the USB Device

1. Select another source in the main menu.
2. Remove the USB device.

Inserting the SD card

1. Open SD card cover.
2. Insert the SD card into the SD card slot.
Play starts automatically.

NOTES:

1. If there are audio files supported on the SD card, the system will enter the audio files menu automatically.
If there are no audio files, but there are video files supported on the SD card, the system will enter the video files menu

Playback Mode

automatically.

If there are no audio or video files, but there are picture files supported on the SD card, the system will enter the picture files menu automatically.

If there no above audio/video/picture files supported in the SD card, the screen will display "Load Error!".

2. Not all SD cards are compatible with the unit.

Removing the SD card

1. Select another source in the main menu.
2. Press the card until you hear a click sound.
3. Remove the SD card.

DVD movie playback

The car sound system can play video DVDs and VCDs. After inserting the DVD, the playback starts automatically. The DVD menu is displayed.

You can navigate in the DVD menu by touching the corresponding buttons in the DVD menu on the screen.

After starting the movie via the menu of the DVD, the movie is displayed. The playback menu for DVDs is hidden.

NOTE:

Briefly touch the screen once to display the playback menu again.

The playback menu is shown.



1. Shortcut.
2. Stop playback, call up home menu.
3. Select previous chapter.
4. Pause playback and continue playback.
5. Select next chapter.

Tap on [...] to display additional operating options of the playback menu.



6. Select playback language (only if supported by the DVD).
7. Display equalizer.
8. Return to menu.
9. Start and end REPEAT function.
Repeat mode:
Repeat Chapter → Repeat Title → Repeat All → Repeat Off
10. Return to title.
11. Adjust the brightness, contrast, and saturation.
12. Call up keypad for direct selection of titles or chapters.
13. Select playback audio channel (only if supported by the DVD).

Audio playback from DVD/CD, USB or SD

The principles of audio playback (MP3/WMA) from data carriers are identical for all sources.

Select the desired source via the main menu. The device changes to the desired source and the playback starts.

If the playback does not start with the audio playback, touch the [≡] icon to change to the folder/file list.

Touch the [📁] icon to display all the folders and files of the data carrier.

- Or -

Press the [🎵] icon to display all the audio files of the data carrier.

Playback Mode

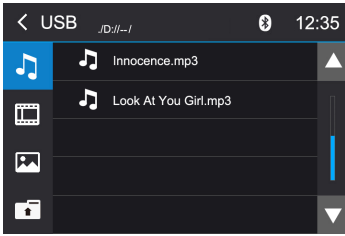

After starting a title, the playback menu is displayed.

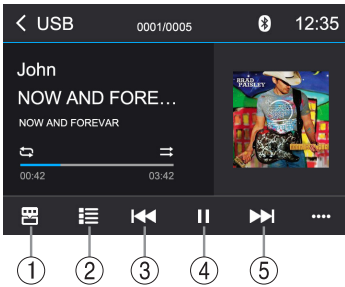

1. Shortcut.
2. Display the folder/file list.
3. Short press: Previous track.
Long press: Fast backward.
4. Pause playback and continue playback.
5. Short press: Next track.
Long press: Fast forward.

Tap on [••••] to display additional operating options of the playback menu.

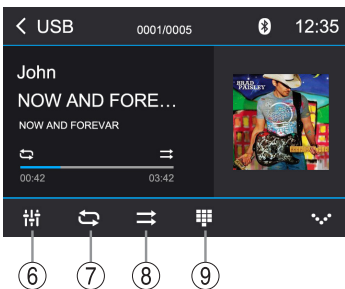

6. Display equalizer.
7. Start and end REPEAT function.
Repeat mode:
Repeat One → Repeat Folder → Repeat All
→ Repeat Off

8. Shuffle playback.
9. Display keypad to directly enter the number of the desired title.

Video playback from DVD/CD, USB or SD

Select the desired source via the main menu. The device changes to the desired source and the playback starts.

If the playback does not start with the video playback, touch the [≡] icon to change to the folder/file list.

Touch the [📁] icon to display all the folders and files of the data carrier.

- Or -

Touch the [📺] icon to display all the audio files of the data carrier.

If you selected a movie, the playback is started. During the movie playback, the playback menu is hidden.

Briefly touch the screen once to display the playback menu again.

The playback menu is shown.

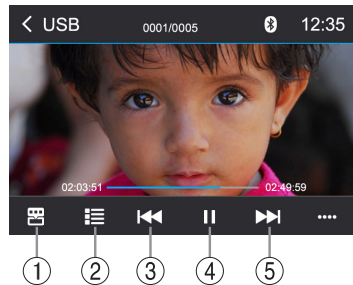

1. Shortcut.
2. Display the folder/file list.
3. Short press: Previous movie.
Long press: Fast backward.
4. Pause playback and continue playback.
5. Short press: Next movie.
Long press: Fast forward.

Playback Mode

Tap on [••••] to display additional operating options of the playback menu.

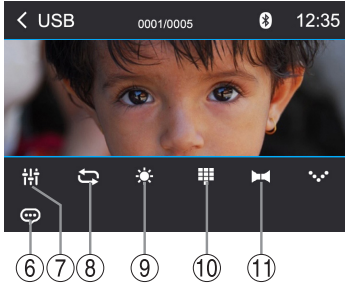

6. Select playback language.
7. Display equalizer.
8. Start and end REPEAT function.
Repeat mode:
Repeat One → Repeat Folder → Repeat All
→ Repeat Off
9. Adjust the brightness, contrast, and saturation.
10. Display keypad to directly enter the number of the desired title.
11. Select playback audio channel.

Image playback from DVD/CD, USB or SD

Select the desired source via the main menu. The device changes to the desired source and the playback starts.

If the playback does not start with the image playback, touch the [≡] icon to change to the folder/file list.

Touch the [📁] icon to display all the folders and files of the data carrier.
- Or -

Touch the [🖼️] icon to display all the images of the data carrier.

If you selected a image, the playback is started. During the playback, the playback menu is hidden.

Briefly touch the screen once to display the playback menu again.

The playback menu is shown.



1. Shortcut.
2. Display the folder/file list.
3. Previous image.
4. Pause playback and continue playback.
5. Next image.

Tap on [••••] to display additional operating options of the playback menu.



6. Zoom in/out.
7. Rotate images .
8. Adjust the brightness, contrast, and saturation.
9. Display keypad to directly enter the number of the desired title.

Bluetooth Mode

The user can make or receive phone calls with Bluetooth enabled phones through the unit. The user can also listen to music from a Bluetooth enabled device.

Pairing Bluetooth Enabled Devices

To connect your Bluetooth phone to the unit, the user needs to pair the phone to the unit. Pairing needs only to be done once. The user can pair up to five phones. The user can search for Bluetooth head units by mobile phone.

1. Turn ON the Bluetooth function on the device.
2. Search for Bluetooth devices by mobile phone.
3. Select the Bluetooth device ID (shown on the screen of the unit) in the pairing list.
4. Enter default password "0000" if necessary.

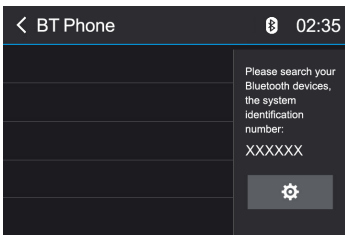

NOTES:

- The operational range between this unit and a Bluetooth device is approximately 5 meters.
- Before you connect a Bluetooth device to this unit, familiarize yourself with the Bluetooth capabilities of the device.
- Compatibility with all Bluetooth device is not guaranteed.
- Any obstacle between this unit and a Bluetooth device can reduce the operational range.
- Keep this unit away from any other electronic device that may cause interference.

Disconnecting a Bluetooth Device

To disconnect one device, touch []. After pressed, the unit will display a screen listing paired devices. Pressing the Green "Plug" icon will reconnect a previously paired phone to the

BT radio. Pressing the "Wastebin" icon next to a device's name will unpair the phone from the unit.

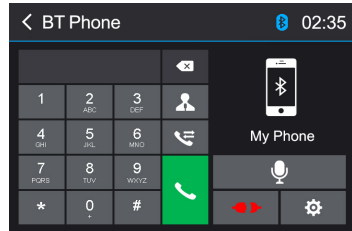

NOTES

- The device will be disconnected when the device is moved beyond the operational range.
- If you want to reconnect the device to the unit, place it within the operational range.
- If you do not want to reconnect the device to the unit automatically, touch [], then set [Auto Connect] to [OFF]. For details, see the "Adjust Bluetooth Settings" section.
- Touch and hold [] to clear all the inputs.

Make a Call

1. Select Bluetooth function in the home menu.
2. On Option page, see the "Phone Synch" item, and press "Synch" to synchronize the phone book with the BT. If you have many contacts, this may take up to 3-4 minutes.
3. Search for phone number from the following list:
 - [Phone Book]
 - [Call History]
 - [Missed calls]
 - [Received calls]
 - [Dialed calls]

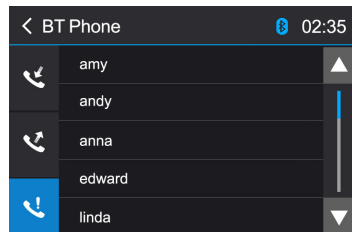



Or touch the number pad directly, then touch [] to dial.

Bluetooth Mode

Receiving a Call

By default, all incoming calls are received automatically.

1. If there is an incoming call, the screen will display incoming call number.
2. Touch the screen to select [] or [].
Speak into the Bluetooth microphone.

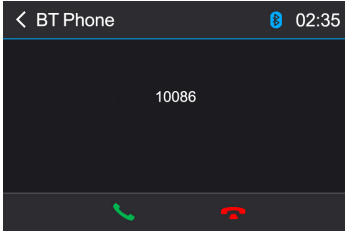

NOTE:

- You can select to receive calls manually by setting [Auto Answer] to [OFF]

i-Mode

Touch the [] icon to activate Siri of your iPhone.

Adjust Bluetooth Settings

In the options menu for Bluetooth, you can make the basic settings for the Bluetooth mode.

Touch the [] icon.

The options menu is displayed.

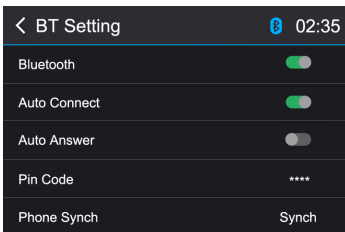

Bluetooth — To turn the “Bluetooth” function ON or OFF.

Auto Connect — To turn the “Auto Connect” function ON or OFF.

Auto Answer — To turn the “Auto Answer” function ON or OFF.

Pin Code — To set the pairing code.

Phone Synch — To synchronize phone book, touch [OK] on the sub-menu Phonebook Synch may take several minutes to load on initial setup.

Bluetooth Music Function

Bluetooth provides an Advanced Audio Distribution Profile (A2DP) profile for streaming music from a mobile phone, sometimes referred to as a MP3 player. The unit allows you to play back audio files from your mobile phone using a Bluetooth connection.

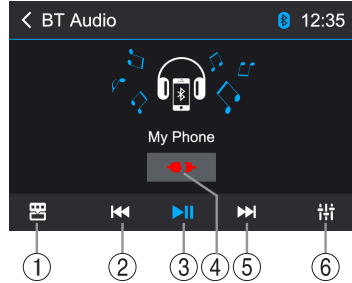

1. Shortcut.
2. Previous track.
3. Pause playback and continue playback.
4. Disconnect connection with current device.
5. Next track.
6. Display equalizer.

NOTE:

Please quit A2DP mode before attempting to make a phone call, as unexpected results may occur depending on your mobile phone model.

AVRCP is short for Audio/Video Remote Control Profile. Mobile phones supporting this function can control the playback of a Bluetooth audio player.

The unit can control a Bluetooth audio player via Advanced Audio Distribution Profile (A2DP) or Audio/Video Remote Control Profile (AVRCP). Bluetooth audio players (or Bluetooth adapters) compatible with these profiles can be connected to this unit.

While listening to music from any source, the user can make a phone call by pressing the number keys on the mobile phone. The unit will stop playing music, after the call received, the voice will be transferred to the unit. When the call ends, the screen will display music playing menu.

If there is an incoming phone call, the music will stop, when the call ends, the screen will display music playing menu.

Accessing iPod mode

Connect an iPod or iPhone to the USB connector via an iPod cable.

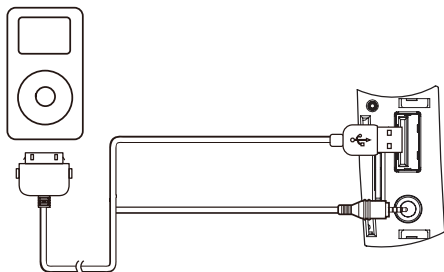

Touch [iPod] on the main menu to enter iPod menu.

Pausing play

1. Touch the [⏸] icon on the bottom of the screen to pause play.
[⏸] appears on the screen.
2. Touch [⏸] icon again to resume play.

Selecting a track

Track-up

Touch the [⏮] icon to move to the beginning of the next track.

Track-down

1. Touch the [⏮] icon to move back to the beginning of the current track.
2. Touch the [⏮] icon twice to move back to the beginning of the previous track.

Fast forward/Fast backward

Fast forward

Touch and hold the [⏭] icon .

Fast backward

Touch and hold the [⏪] icon .

Repeat play

This function allows you to play the track repeatedly.

Touch the [↺] icon to select Repeat one or Repeat all.

Random play

This function allows you to play all tracks recorded in a random order.

Touch the [⇄] icon to perform random play.

Search function

1. Touch the [🔍] icon to enter search menu.
2. Input number, then touch [OK] to begin searching.
Touch [✕] icon to delete inputted number.

Open the Source Menu and then touch [**SmartLink**] to enter SmartLink menu.

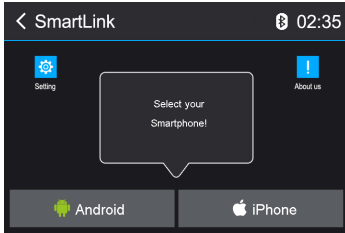

About SmartLink

SmartLink is the function about interconnecting information between the smart phone and the car device.

By SmartLink, you can synchronize the screen from your smart phone to the car device.

And you can also control your phone by the car device, such as receiving calls, dialing calls, listening to the music and watching movies or pictures from your phone, as well using navigation from the smart phone to the screen of the car device.

The function of the SmartLink depends on the configuration of your smart phone.

About HDMI

To active the SmartLink function, you need to connect your smartphone to the car device's HDMI connector via appropriate cable(sold separately).

HDMI (High-Definition Multimedia Interface) is a proprietary audio/video interface for transferring uncompressed video data and compressed or uncompressed digital audio data from an HDMI-compliant source device, such as a display controller, to a compatible computer monitor, video projector, digital television, or digital audio device.

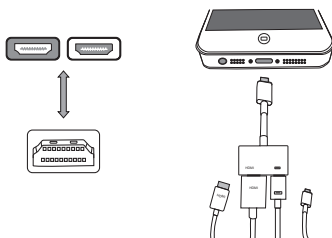

Connect with Android Phone

1. How to get SmartLink APP

Method1: Scan the QR code on the screen of the car device with your Android phone to download and install "SmartLink" APP.

Method 2: Download and install SmartLink from Google Play.

2. Cable connection

Connect your Smartphone with this system via appropriate cable(sold separately).

(Some Samsung phones adaptor cable interface is different to others)

3. BT Connection

Scan for Bluetooth devices and select this system for connection.

4. Touch panel calibration

Dialog box will be shown on your smartphone when connection between Smartphone and this system via BT. Click "OK" on the dialog, and then touch panel calibration procedure will be run on this system. Calibration should be made for horizontal display case and vertical display case of your smartphone.

Connect with iPhone

Connect you iPhone with this system via HDMI cable(sold separately).

For iPhone 5 or above: To connect HDMI use the Apple Lightning Digital AV Adapter.

Setting

Touch [**Setting**] icon to display the following option:

Screen Rotation(iphone only) — Select the screen's landscape direction based on your preference. The default setting is Right landscape.

Version — Displaying the device version

Limitations

1. SmartLink can't work if car-unit or phone is Off or in inappropriate operation.
2. SmartLink can't work if operated in a wrong way or without specified adaptor or wiring.
3. Wireless communication could be shortly influenced for some phones which can cause impact on SmartLink.
4. Inappropriate phones or systems can cause impact on SmartLink.
5. If no specified versions of app in phone or can't match with the versions of app in car-unit can cause impact on SmartLink.
6. SmartLink can limited to third-party software. (IOS or Android systems upgrade, treaty of phone port changed, navigation systems upgrade or the treaty changed.)
7. SmartLink can't work if PIN code is needed when starting Wi-Fi.
8. Wire or wireless communication is upset by weather, busy lines, capacitance, device, and so on, which may cause influence on SmartLink.
9. Power system and the structure of your car, car-unit, phone, or damaged wiring can cause impact on SmartLink.
10. SmartLink can't work without available signal or normal system.
11. The dpi of phone may cause little deviation when you control phone with car-unit.

NOTE:

No liability shall be assumed for cases described above.

Aux 1 / Aux 2 Controls

Aux 1

Aux 1 is used for playback of audio/video from an external device connected to the unit through a 3.5mm jack located on the front panel.

Aux 2

Aux 2 is used for playback of audio/video from an external device connected through RCA connectors located on the back of the unit.

You can connect an external audio/video device to the unit.

1. Connect the external device with the supplied AV cable.
2. Touch the upper left corner to display the main menu.
3. Touch [Aux 1] / [Aux 2] to access external device.

NOTES:

1. Audio/Video device must be connected to the unit using an audio/video adapter cable that is available separately.
2. Video will only play when the vehicle parking brake is engaged. The parking brake must be connected for this feature to operate.

Reset

When the unit hangs up, you can reset it, press [RESET] with a ball-point pen or similar tool.

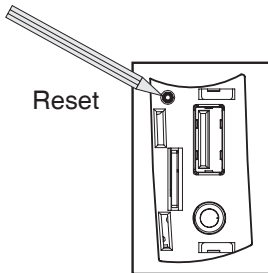

NOTE:

When the [RESET] button is pressed, frequencies of radio stations, date, time, etc. stored in memory are cleared.

Replace a Fuse

If there is no power, the fuse may be damaged and need to be replaced.

1. Remove the unit from the dashboard.
2. Check all electrical connections.
3. Buy a fuse that matches the amperage of the damaged fuse.
4. Replace the fuse while the unit is powered off.

Rear Camera Operation

This unit is "camera ready." Before accessing any camera features, you must install a rear video camera (sold Separately).

When the camera is installed, the rear view image of what is behind the vehicle will appear when the vehicle is placed in reverse gear. When leaving reverse gear, the unit displays the previous screen.

Specifications

General

Reference Supply Voltage.....	12V(DC)
Operating Voltage Range.....	10.8 - 16.0V(DC)
Max Operating Current.....	15A
Grounding System.....	Negative
Dimensions(WXHxD).....	178.5X101.5X166.0mm
Weight(main unit).....	1.8kg

FM

Signal Noise Ratio.....	≥55dB
Residual Noise Sensitivity (S/N=30dB).....	≤15dBμV
Frequency Response (±3dB).....	30Hz~15KHz
Station Seeking Level.....	20~28dBμV
Distortion.....	≤1.0%
Stereo Separation (1KHz).....	≥25dB
Antenna Impedance.....	75Ω

AM

Residual Noise Sensitivity (S/N=20dB).....	≤35dBμV
Selectivity (±9KHz).....	≥50dB

Screen

Screen size.....	6.2 inches(16:9)
Display resolution.....	800X480

DVD Player

S/N Ratio.....	≥75dB
THD+N.....	≤0.1%
Frequency Response (±3dB).....	20Hz~20KHz
Maximum Output Power.....	4x40W
Load Impedance.....	4Ω

AUX IN

Distortion.....	≤0.5%
Frequency Response (±3dB).....	20Hz~20KHz
Audio Input Level.....	0.5V

Preout

Output Impedance.....	10KΩ
Output Level.....	3V

Video

Normal Video Input Level (CVBS).....	1.0±0.2V
Video Input Impedance.....	75Ω
Video Output Impedance.....	75Ω
Video Output Level.....	1.0±0.2Vp-p

Environment

Operating Temperature.....	-20°C ~ +60°C
Storing Temperature.....	-30°C ~ +80°C
Operating Humidity.....	45°C/80%RH
Storing Humidity.....	60°C/90%RH

Notice:

When the unit is operated to extremes, such as with maximum power output for a long time, or the temperature is over 70°C, it will enter heat protection mode, the volume will be reduced automatically. This is normal.

Specifications

Supported Formats:

- USB or memory file format: FAT16,FAT32
- Mp3 bit rate(date rate): 32-320 Kbps and variable bit rate
- Directory nesting up to a maximum of 8 levels
- Number of albums/folders: maximum 99
- Number of tracks/titles: maximum 999
- ID3 tag v2.0 or later
- File name in Unicode UTF8(maximum length:128 bytes)

Unsupported Formats:

- Empty albums: an empty album is an album that does not contain MP3 files and is not shown in the display.
- Unsupported file formats are skipped. For example, Word documents(.doc) or Mp3 files with extension.dlf are ignored and not played.

Supported MP3 Disc Format:

- ISO9660, Joliet
- Maximum title number: 512(depending on file name length)
- Maximum album number: 255
- Supported sampling frequencies: 32kHz,44.1kHz,48kHz
- Supported bit-rates: 32-320Kbps and variable bit rates

Supported Video Formats:

- DVD
- MPEG
- RMVB
- etc.

Region Code

According to DVD sales regions, the whole world is divided into six regions. A DVD disc can be played back only when its region code is compatible with that of the player in use.

Region 1: USA, Canada, East Pacific Ocean Islands;

Region 2: Japan, West Europe, North Europe, Egypt, South Africa, Middle East;

Region 3: Taiwan of China, Hong Kong of China, South Korea, Thailand, Indonesia, South East Asia;

Region 4: Australia, New Zealand, Mid & south America, South Pacific Ocean Islands/Oceania;

Region 5: Russia, Mongolia, India, Middle Asia, East Europe, North Korea, North Africa, North West Asia;

Region 6: China, Mainland.

Precautions when using Discs

- 1) DO NOT use irregular shaped discs.
- 2) Disc cleaning:
Use a dry, soft cloth to wipe the disc from center to edge, only neutral detergent can be used.
- 3) When playing a new disc:
New discs may have some rough spots around the inner and outer edges. If such a disc is used, remove these rough spots with a pencil or ball-point pen, etc.

Troubleshooting

What appears to be a problem is not always serious. Please check the following points before calling a service center.

Problem	Cause	Corrective action
General		
Unit does not power on	Unit fuse blown.	Install new fuse with correct rating.
	Car battery fuse blown.	Install new fuse with correct rating.
	Illegal operation	Reset the unit.
No/low audio output	Improper audio output connection.	Check wiring and correct.
	Volume set too low.	Increase volume level.
	Speakers damaged.	Replace speakers.
	Heavily biased volume balance.	Adjust the channel balance to center position.
	Speaker wiring is in contact with metal part of car.	Insulate all speaker wiring connections.
Poor sound quality or distortion	Pirated disc is in use.	Use original disc.
	Speaker power rating does not match unit.	Replace speakers.
	Wrong connections.	Check wiring and correct.
	Speaker is shorted.	Check wiring and correct.
Tel-Mute malfunction	MUTE wire is grounded.	Check the 'MUTE' wiring and correct.
Unit resets itself when engine is off	Incorrect connection between ACC and BATT.	Check wiring and correct.
TFT monitor		
Warning information is shown at all times	Parking break wiring is not correct.	Check wiring and correct.
Flashing image or interference appears on screen	The color system of DVD disc does not match the monitor.	Adjust the color system of the DVD disc playing back or the monitor in use.
	Pirated disc is in use.	Use original disc.
	Video cable damaged.	Replace cables.
	Improper video signal connections.	Check wiring and correct.
Disc playback		
Cannot insert disc	A disc is already inside the unit.	Eject current disc and insert new one.
Disc does not play back	Disc is warped or scratched.	Use disc in good condition.
	Disc is dirty or wet.	Clean disc with soft cloth.
	Incompatible disc is used.	Use compatible disc.
	Disc is inserted upside down.	Insert disc with label side up.
	Disc region code is not compatible with unit.	Use disc with proper region code.
PBC cannot be used during VCD playback	PBC is not available on the disc.	Use disc with PBC available.
Repeat or search function is invalid during VCD playback	PBC is on.	Turn PBC off.
Error messages		
No disc	Disc is dirty.	Clean disc with soft cloth.
	Disc is upside down.	Insert disc with label side up.
	No disc inside.	Insert disc.
Bad disc	Disc is dirty.	Clean disc with soft cloth.
	Disc is upside down.	Insert disc with label side up.
Unknown disc	Disc format is not compatible with this unit.	Use disc with compatible format.
Region error	DVD region code is not compatible with this unit.	Use disc with compatible region code.

Wire Connections

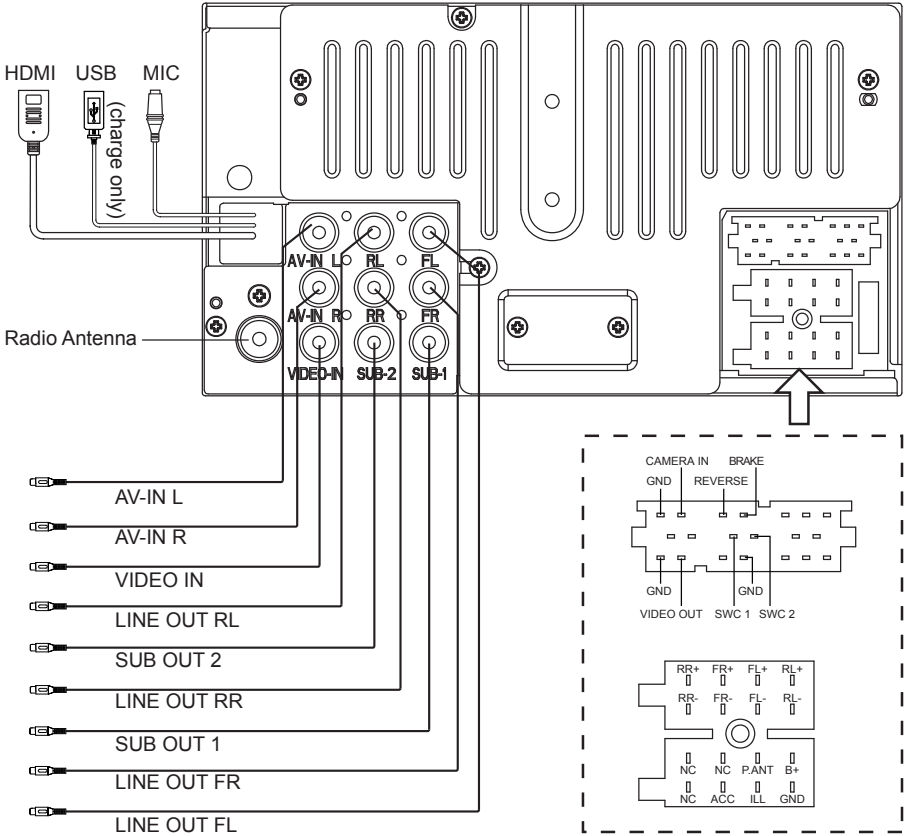



**CLASS 1
LASER PRODUCT**

P/N: 127075006775