





FCC PART 15.225
ISED C RSS-210, ISSUE 10, DECEMBER 2019

TEST REPORT

For
Tesla, Inc.

3500 Deer Creek Road, Palo Alto, CA 94304, USA

FCC ID: 2AEIM-1783148Y
IC: 20098-1783148Y

Report Type: Original Report	Product Type: Automotive Part
Prepared By: Deepak Mishra Test Engineer	
Report Number: R2206271-01	
Report Date: 2022-10-12	
Reviewed By: Christian McCaig RF Lead Engineer	
Bay Area Compliance Laboratories Corp. 1274 Anvilwood Avenue, Sunnyvale, CA 94089, USA Tel: (408) 732-9162, Fax: (408) 732 9164	



Note: This test report is prepared for the customer shown above and for the device described herein. It may not be duplicated or used in part without prior written consent from Bay Area Compliance Laboratories Corp. This report **must not** be used by the customer to claim product certification, approval, or endorsement by A2LA*, NIST, or any agency of the Federal Government.

* This report may contain data that are not covered by the A2LA accreditation and are marked with an asterisk "*" (Rev.2)

TABLE OF CONTENTS

1	General Description.....	4
1.1	Product Description for Equipment Under Test (EUT)	4
1.2	Mechanical Description of EUT	4
1.3	Objective.....	4
1.4	Related Submittal(s)/Grant(s)	4
1.5	Test Methodology	4
1.6	Measurement Uncertainty	4
1.7	Test Facility Registrations	5
1.8	Test Facility Accreditations	5
2	System Test Configuration.....	8
2.1	Justification.....	8
2.2	EUT Exercise Software.....	8
2.3	Equipment Modifications.....	8
2.4	Local Support Equipment	8
2.5	Remote Support Equipment	8
2.6	Interface Ports and Cabling.....	8
3	Summary of Test Results	9
4	FCC §15.203 & ISEDC RSS-Gen §6.8 - Antenna Requirements	10
4.1	Applicable Standards	10
4.2	Antenna Description	10
5	FCC §15.225(a)(b)(c)(d), §15.209 & ISEDC RSS-210, Annex B.6 - Radiated Field Strength.....	11
5.1	Applicable Standards	11
5.2	Test Setup	12
5.3	Test Procedure	12
5.4	Corrected Amplitude & Margin Calculation.....	13
5.5	Test Setup Block Diagram	13
5.6	Test Equipment List and Details.....	14
5.7	Test Environmental Conditions	14
5.8	Summary of Test Results.....	15
5.9	Radiated Field Strength Test Data and Plots.....	15
6	FCC §15.225(e) & ISEDC RSS-210, Annex B.6 – Frequency Tolerance.....	18
6.1	Applicable Standards	18
6.2	Test Setup Block Diagram	18
6.3	Test Equipment List and Details.....	18
6.4	Test Environmental Conditions	19
6.5	Test Results.....	19
7	FCC §15.215(c) & ISEDC RSS-GEN §6.7 - Occupied Bandwidth.....	25
7.1	Applicable Standards	25
7.2	Test Setup	25
7.3	Test Setup Block Diagram	26
7.4	Test Equipment List and Details.....	26
7.5	Test Environmental Conditions	26
7.6	Test Results.....	27
8	Annex A (Normative) - Test Setup Photographs	28
9	Annex B (Normative) - EUT External Photographs.....	29
10	Annex C (Normative) - EUT Internal Photographs	30
11	Annex D (Normative) - A2LA Electrical Testing Certificate.....	31

DOCUMENT REVISION HISTORY

Revision Number	Report Number	Description of Revision	Date of Revision
0	R2206271-01	Original Report	2022-10-12

1 General Description

1.1 Product Description for Equipment Under Test (EUT)

This test and measurement report has been compiled on behalf of *Tesla, Inc.*, and their product, *FCC ID: 2AEIM-1783148Y; IC: 20098-1783148Y*, model: 1783148Y, which henceforth is referred to as the EUT (Equipment under Test.) The EUT is an Automotive Part (B Pillar Endpoint) with NFC operating at 13.56 MHz and Bluetooth Low Energy.

1.2 Mechanical Description of EUT

1783148Y measures approximately 51 cm (Length) x 22 cm (Width) x 3 cm (High), and weighs approximately < 1kg

The data gathered are from a typical production sample provided by the manufacturer with serial number: ED322185000272, assigned by Tesla, Inc.

1.3 Objective

This report was prepared on behalf of *Tesla, Inc.*, in accordance with Part 2, Subpart J, and Part 15, Subparts B and C of the Federal Communication Commission's rules and ISEDC RSS-210 Annex B.6's rules. The objective was to determine compliance with FCC Part 15.225 and ISEDC RSS-210.

1.4 Related Submittal(s)/Grant(s)

FCC Part 15, Subpart C, Equipment Class: DTS with FCC ID: 2AEIM-1783148Y; IC: 20098-1783148Y

1.5 Test Methodology

All measurements contained in this report were conducted in accordance with ANSI C63.10-2013, American National Standard of Procedures for Compliance Testing of Unlicensed Wireless Devices.

1.6 Measurement Uncertainty

All measurements involve certain levels of uncertainties, especially in the field of EMC. The factors contributing to uncertainties are spectrum analyzer, cable loss, antenna factor calibration, antenna directivity, antenna factor variation with height, antenna phase center variation, antenna factor frequency interpolation, measurement distance variation, site imperfections, mismatch (average), and system repeatability.

Based on CISPR16-4-2:2011, The Treatment of Uncertainty in EMC Measurements, the values ranging from ± 2.0 dB for Conducted Emissions tests and ± 4.0 dB for Radiated Emissions tests are the most accurate estimates pertaining to uncertainty of EMC measurements at BAEL Corp.

1.7 Test Facility Registrations

BACLs test facilities that are used to perform Radiated and Conducted Emissions tests are currently recognized by the Federal Communications Commission as Accredited with NIST Designation Number US1129.

BACL's test facilities that are used to perform Radiated and Conducted Emissions tests are currently registered with Industry Canada under Registration Numbers: 3062A-1, 3062A-2, and 3062A-3.

BACL is a Chinese Taipei Bureau of Standards Metrology and Inspection (BSMI) validated Conformity Assessment Body (CAB), under Appendix B, Phase I Procedures of the APEC Mutual Recognition Arrangement (MRA). BACL's BSMI Lab Code Number is: SL2-IN-E-1002R

BACL's test facilities that are used to perform AC Line Conducted Emissions, Telecommunications Line Conducted Emissions, Radiated Emissions from 30 MHz to 1 GHz, and Radiated Emissions from 1 GHz to 6 GHz are currently recognized as Accredited in accordance with the Voluntary Control Council for Interference [VCCI] Article 15 procedures under Registration Number A-0027.

1.8 Test Facility Accreditations

Bay Area Compliance Laboratories Corp. (BACL) is:

A- An independent, 3rd-Party, Commercial Test Laboratory accredited to ISO/IEC 17025:2017 by A2LA (Test Laboratory Accreditation Certificate Number 3297.02), in the fields of: Electromagnetic Compatibility and Telecommunications. Unless noted by an Asterisk (*) in the Compliance Matrix (See Section 3 of this Test Report), BACL's ISO/IEC 17025:2017 Scope of Accreditation includes all of the Test Method Standards and/or the Product Family Standards detailed in this Test Report.

BACL's ISO/IEC 17025:2017 Scope of Accreditation includes a comprehensive suite of EMC Emissions, EMC Immunity, Radio, RF Exposure, Safety and wireline Telecommunications test methods applicable to a wide range of product categories. These product categories include Central Office Telecommunications Equipment [including NEBS - Network Equipment Building Systems], Unlicensed and Licensed Wireless and RF devices, Information Technology Equipment (ITE); Telecommunications Terminal Equipment (TTE); Medical Electrical Equipment; Industrial, Scientific and Medical Test Equipment; Professional Audio and Video Equipment; Industrial and Scientific Instruments and Laboratory Apparatus; Cable Distribution Systems, and Energy Efficient Lighting.

B- A Product Certification Body accredited to ISO/IEC 17065:2012 by A2LA (Product Certification Body Accreditation Certificate Number 3297.03) to certify

- For the USA (Federal Communications Commission):

- 1- All Unlicensed radio frequency devices within FCC Scopes A1, A2, A3, and A4;
- 2- All Licensed radio frequency devices within FCC Scopes B1, B2, B3, and B4;
- 3- All Telephone Terminal Equipment within FCC Scope C.

- For the Canada (Industry Canada):

- 1- All Scope 1-Licence-Exempt Radio Frequency Devices;
- 2- All Scope 2-Licensed Personal Mobile Radio Services;
- 3- All Scope 3-Licensed General Mobile & Fixed Radio Services;
- 4- All Scope 4-Licensed Maritime & Aviation Radio Services;
- 5- All Scope 5-Licensed Fixed Microwave Radio Services
- 6- All Broadcasting Technical Standards (BETS) in the Category I Equipment Standards List.

- For Singapore (Info-Communications Development Authority (IDA)):

- 1- All Line Terminal Equipment: All Technical Specifications for Line Terminal Equipment – Table 1 of IDA MRA Recognition Scheme: 2011, Annex 2
- 2- All Radio-Communication Equipment: All Technical Specifications for Radio-Communication Equipment – Table 2 of IDA MRA Recognition Scheme: 2011, Annex 2

- For the Hong Kong Special Administrative Region:

- 1- All Radio Equipment, per KHCA 10XX-series Specifications;
 - 2- All GMDSS Marine Radio Equipment, per HKCA 12XX-series Specifications;
 - 3- All Fixed Network Equipment, per HKCA 20XX-series Specifications.
- For Japan:
- 1- MIC Telecommunication Business Law (Terminal Equipment):
 - All Scope A1 - Terminal Equipment for the Purpose of Calls;
 - All Scope A2 - Other Terminal Equipment
 - 2- Radio Law (Radio Equipment):
 - All Scope B1 - Specified Radio Equipment specified in Article 38-2-2, paragraph 1, item 1 of the Radio Law
 - All Scope B2 - Specified Radio Equipment specified in Article 38-2-2, paragraph 1, item 2 of the Radio Law
 - All Scope B3 - Specified Radio Equipment specified in Article 38-2-2, paragraph 1, item 3 of the Radio Law

C- A Product Certification Body accredited to ISO/IEC 17065:2012 by A2LA (Product Certification Body Accreditation Certificate Number 3297.01) to certify Products to USA's Environmental Protection Agency (EPA) ENERGY STAR Product Specifications for:

- 1 Electronics and Office Equipment:
 - for Telephony (ver. 3.0)
 - for Audio/Video (ver. 3.0)
 - for Battery Charging Systems (ver. 1.1)
 - for Set-top Boxes & Cable Boxes (ver. 4.1)
 - for Televisions (ver. 6.1)
 - for Computers (ver. 6.0)
 - for Displays (ver. 6.0)
 - for Imaging Equipment (ver. 2.0)
 - for Computer Servers (ver. 2.0)
- 2 Commercial Food Service Equipment
 - for Commercial Dishwashers (ver. 2.0)
 - for Commercial Ice Machines (ver. 2.0)
 - for Commercial Ovens (ver. 2.1)
 - for Commercial Refrigerators and Freezers
- 3 Lighting Products
 - For Decorative Light Strings (ver. 1.5)
 - For Luminaires (including sub-components) and Lamps (ver. 1.2)
 - For Compact Fluorescent Lamps (CFLs) (ver. 4.3)
 - For Integral LED Lamps (ver. 1.4)
- 4 Heating, Ventilation, and AC Products
 - for Residential Ceiling Fans (ver. 3.0)
 - for Residential Ventilating Fans (ver. 3.2)
- 5 Other
 - For Water Coolers (ver. 3.0)

D- A NIST Designated Phase-I and Phase-II Conformity Assessment Body (CAB) for the following economies and regulatory authorities under the terms of the stated MRAs/Treaties:

- Australia: ACMA (Australian Communication and Media Authority) – APEC Tel MRA -Phase I;
- Canada: (Innovation, Science and Economic development Canada - ISED) Foreign Certification Body – FCB – APEC Tel MRA -Phase I & Phase II;
- Chinese Taipei (Republic of China – Taiwan):
 - BSMI (Bureau of Standards, Metrology and Inspection) APEC Tel MRA -Phase I;
 - NCC (National Communications Commission) APEC Tel MRA -Phase I;

- European Union:
 - EMC Directive 2014/30/EU US-EU EMC & Telecom MRA CAB (NB)
 - Radio Equipment (RE) Directive 2014/53/EU US-EU EMC & Telecom MRA CAB (NB)
 - Low Voltage Directive (LVD) 2014/35/EU
- Hong Kong Special Administrative Region: (Office of the Telecommunications Authority – OFTA)
APEC Tel MRA -Phase I & Phase II
- Israel – US-Israel MRA Phase I
- Republic of Korea (Ministry of Communications - Radio Research Laboratory) APEC Tel MRA -Phase I
- Singapore: (Infocomm Media Development Authority - IMDA) APEC Tel MRA -Phase I & Phase II;
- Japan: VCCI - Voluntary Control Council for Interference US-Japan Telecom Treaty VCCI Side Letter-
- USA:
 - ENERGY STAR Recognized Test Laboratory – US EPA
 - Telecommunications Certification Body (TCB) – US FCC;
 - Nationally Recognized Test Laboratory (NRTL) – US OSHA
- Vietnam: APEC Tel MRA -Phase I;

2 System Test Configuration

2.1 Justification

The EUT was configured for testing according to ANSI C63.10-2013.

2.2 EUT Exercise Software

The test software used was *python scripts* provided by *Tesla, Inc* and verified by *Christian McCaig* to comply with the standard requirements being tested against.

Radio	Frequency (MHz)	Power Setting
NFC	13.56	0x00

2.3 Equipment Modifications

N/A

2.4 Local Support Equipment

Manufacturer	Description	Model No.	Serial No.
Volteq	DC Power Supply	HY5003D	160402343

2.5 Remote Support Equipment

Manufacturer	Description	Model No.	Serial No.
HP	Laptop	Zbook Studio G3	00329-00000-00003-AA284
PJRC	Teensy	Teensy-LC	-

2.6 Interface Ports and Cabling

Cable Descriptions	Length (m)	From	To
USB Type A to Micro USB Type B	< 1 m	Microcontroller	Laptop
Power cables	< 1 m	EUT	Power Supply
RS-232	< 1 m	EUT	Microcontroller

3 Summary of Test Results

Results reported relate only to the product tested.

FCC & ISED Rules	Description of Test	Results
FCC §15.203 ISED RSS-Gen §6.8	Antenna Requirements	Compliant
FCC §2.1091 & ISED RSS-102	RF Exposure	Compliant ²
FCC §15.207 ISED RSS-Gen §8.8	AC Line Conducted Emissions	N/A ¹
FCC §15.225 (a) (b) (c) (d), §15.205, §15.209 & ISED RSS-210 Annex B.6	Radiated Field Strength (9 kHz-30 MHz, 30 MHz-1 GHz)	Compliant
FCC §15.225 (e) & ISED RSS-210-Annex B.6	Frequency Tolerance	Compliant
FCC §15.215 (c) ISED RSS-Gen §6.7	Occupied Bandwidth	Compliant

Note¹: Device is DC powered by car battery.

Note²: Please refer to Test Report R2206271-03 for FCC RF Exposure Evaluation, Test Report R2206271-04 for IC RF Exposure Evaluation.

4 FCC §15.203 & ISEDC RSS-Gen §6.8 - Antenna Requirements

4.1 Applicable Standards

According to FCC §15.203:

An intentional radiator shall be designed to ensure that no antenna other than that furnished by the responsible party shall be used with the device. The use of a permanently attached antenna or of an antenna that uses a unique coupling to the intentional radiator shall be considered sufficient to comply with the provisions of this Section. The manufacturer may design the unit so that a broken antenna can be replaced by the user, but the use of a standard antenna jack or electrical connector is prohibited.

And according to FCC §15.247 (b) (4), if transmitting antennas of directional gain greater than 6 dBi are used the power shall be reduced by the amount in dB that the directional gain of the antenna exceeds 6 dBi.

According to ISEDC RSS-Gen §6.8: Transmitter Antenna

The applicant for equipment certification shall provide a list of all antenna types that may be used with the transmitter, where applicable (i.e. for transmitters with detachable antenna), indicating the maximum permissible antenna gain (in dBi) and the required impedance for each antenna. The test report shall demonstrate the compliance of the transmitter with the limit for maximum equivalent isotropically radiated power (e.i.r.p.) specified in the applicable RSS, when the transmitter is equipped with any antenna type, selected from this list.

For expediting the testing, measurements may be performed using only the antenna with highest gain of each combination of transmitter and antenna type, with the transmitter output power set at the maximum level. However, the transmitter shall comply with the applicable requirements under all operational conditions and when in combination with any type of antenna from the list provided in the test report (and in the notice to be included in the user manual, provided below).

When measurements at the antenna port are used to determine the RF output power, the effective gain of the device's antenna shall be stated, based on a measurement or on data from the antenna's manufacturer.

The test report shall state the RF power, output power setting and spurious emission measurements with each antenna type that is used with the transmitter being tested.

For license-exempt equipment with detachable antennas, the user manual shall also contain the following notice in a conspicuous location:

This radio transmitter has been approved by Innovation, Science and Economic Development Canada to operate with the antenna types listed below, with the maximum permissible gain indicated. Antenna types not included in this list that have a gain greater than the maximum gain indicated for any type listed are strictly prohibited for use with this device.

Immediately following the above notice, the manufacturer shall provide a list of all antenna types which can be used with the transmitter, indicating the maximum permissible antenna gain (in dBi) and the required impedance for each antenna type.

4.2 Antenna Description

External/Internal/ Integral	Frequency Range (MHz)	Antenna Type	Maximum Antenna Gain (dBi)
Integral	13.56 MHz	Coil	N/A

5 FCC §15.225(a)(b)(c)(d), §15.209 & ISEDC RSS-210, Annex B.6 - Radiated Field Strength

5.1 Applicable Standards

As per FCC §15.225 Operation within the band 13.110-14.010 MHz

(a) The field strength of any emissions within the band 13.553-13.567 MHz shall not exceed 15,848 microvolts/meter at 30 meters.

(b) Within the bands 13.410-13.553 MHz and 13.567-13.710 MHz, the field strength of any emissions shall not exceed 334 microvolts/meter at 30 meters.

(c) Within the bands 13.110-13.410 MHz and 13.710-14.010 MHz the field strength of any emissions shall not exceed 106 microvolts/meter at 30 meters.

(d) The field strength of any emissions appearing outside of the 13.110-14.010 MHz band shall not exceed the general radiated emission limits in §15.209.

As per FCC §15.209(a): Except as provided elsewhere in this Subpart, the emissions from an intentional radiator shall not exceed the field strength levels specified in the following table

Frequency (MHz)	Field Strength (micro volts/meter)	Measurement Distance (meters)
0.009 - 0.490	2400/F(kHz)	300
0.490 - 1.705	24000/F(kHz)	30
1.705 - 30.0	30	30
30 - 88	100**	3
88 - 216	150**	3
216 - 960	200**	3
Above 960	500	3

** Except as provided in paragraph (g), fundamental emissions from intentional radiators operating under this Section shall not be located in the frequency bands 54-72 MHz, 76-88 MHz, 174-216 MHz or 470-806 MHz. However, operation within these frequency bands is permitted under other sections of this Part, e.g., Sections 15.231 and 15.241.

As per FCC §15.35:

The conducted and radiated emission limits shown in this part are based on the following, unless otherwise specified elsewhere in this part:

(a) On any frequency or frequencies below or equal to 1000 MHz, the limits shown are based on measuring equipment employing a CISPR quasi-peak detector function and related measurement bandwidths, unless otherwise specified. The specifications for the measuring instrument using the CISPR quasi-peak detector can be found in Publication 16 of the International Special Committee on Radio Interference (CISPR) of the International Electrotechnical Commission. As an alternative to CISPR quasi-peak measurements, the responsible party, at its option, may demonstrate compliance with the emission limits using measuring equipment employing a peak detector function, properly adjusted for such factors as pulse desensitization, as long as the same bandwidths as indicated for CISPR quasi-peak measurements are employed.

Note: For pulse modulated devices with a pulse-repetition frequency of 20 Hz or less and for which CISPR quasi-peak measurements are specified, compliance with the regulations shall be demonstrated using measuring equipment employing a peak detector function, properly adjusted for such factors as pulse desensitization, using the same measurement bandwidths that are indicated for CISPR quasi-peak measurements.

As per ISEDC RSS-210 Annex B.6 Band 13.110 – 14.010 MHz:

- a. the field strength of any emission shall not exceed the following limits:

15.848 mV/m (84 dB μ V/m) at 30 m, within the band 13.553-13.567 MHz

334 μ V/m (50.5 dB μ V/m) at 30 m, within the bands 13.410-13.553 MHz and 13.567-13.710 MHz

106 μ V/m (40.5 dB μ V/m) at 30 m, within the bands 13.110-13.410 MHz and 13.710-14.010 MHz

RSS-Gen general field strength limits for frequencies outside the band 13.110-14.010 MHz

5.2 Test Setup

The radiated emissions tests were performed in the 5-meter Chamber and 10 meter chamber, using the setup in accordance with ANSI C63.10-2013. The specification utilized was the FCC §15.225, §15.209 and ISEDC RSS-210 limits.

The spacing between the peripherals was 10 centimeters.

External I/O cables were draped along the edge of the test table and bundle when necessary.

5.3 Test Procedure

For the radiated emissions test, the EUT host, and all support equipment power cords was connected to the AC floor outlet.

Maximizing procedure was performed on the highest emissions to ensure that the EUT complied with all installation combinations.

The EUT is set 3 meter away from the testing antenna for frequency below 30MHz and set 3 meters away from the testing antenna for frequency from 30 MHz to 1 GHz, which was fixed at around 1 meters, and the EUT is placed on a turntable, which is 0.8 meter above ground plane, the table shall be rotated for 360 degrees to find out the highest emission. The receiving antenna should be changed the polarization both of perpendicular and parallel.

The spectrum analyzer or receiver is set as:

Below 150 kHz:

RBW = 200 Hz / VBW = 600 Hz / Sweep = Auto / Average

From 150 kHz to 30 MHz:

RBW = 9 kHz / VBW = 27 kHz / Sweep = Auto / Average

From 30MHz to 1GHz:

RBW = 120 kHz / VBW = 300 kHz / Sweep = Auto / Average

5.4 Corrected Amplitude & Margin Calculation

The Corrected Amplitude (CA) is calculated by adding the Antenna Factor (AF), the Cable Loss (CL), the Attenuator Factor (Atten) and subtracting the Amplifier Gain (Ga) to indicated Amplitude (Ai) reading. The basic equation is as follows:

$$CA = Ai + AF + CL + \text{Atten} - Ga$$

For example, a corrected amplitude of 40.3 dBuV/m = Indicated Reading (32.5 dBuV) + Antenna Factor (+23.5dB/m) + Cable Loss (3.7 dB) + Attenuator (10 dB) - Amplifier Gain (29.4 dB)

The “**Margin**” column of the following data tables indicates the degree of compliance within the applicable limit. For example, a margin of -7 dB means the emission is 7 dB below the maximum limit. The equation for margin calculation is as follows:

$$\text{Margin} = \text{Corrected Amplitude} - \text{Limit}$$

5.5 Test Setup Block Diagram

Below 9 kHz to 30 MHz:

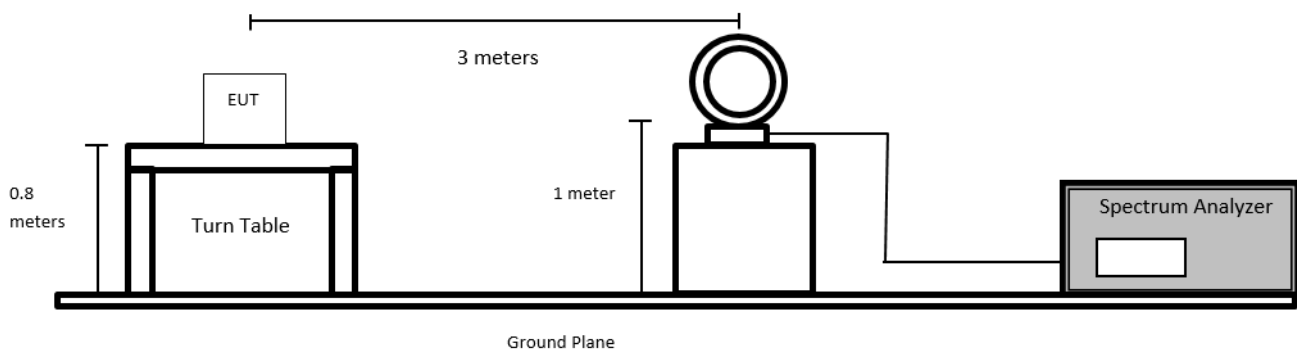

Below 30 MHz to 1 GHz:

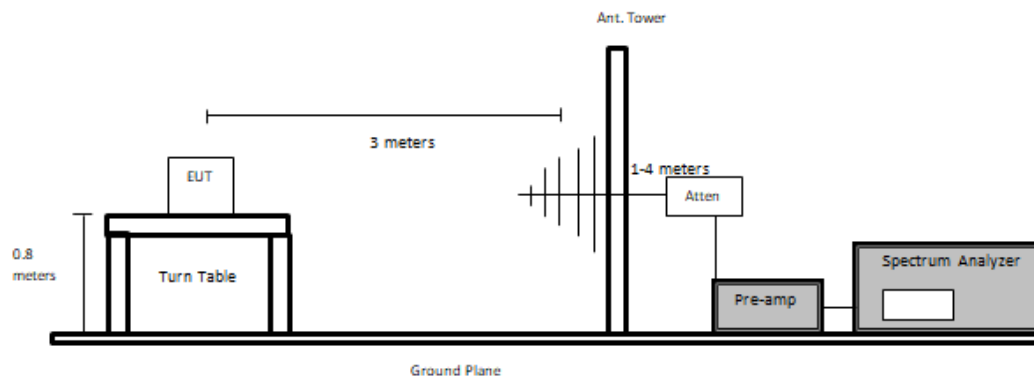

5.6 Test Equipment List and Details

Bacl No.	Manufacturer	Description	Model No.	Serial No.	Calibration Date	Calibration Interval
655	Rhode & Schwarz	Signal Analyzer	FSQ26	200749	2022-02-07	2 years
393	Com-Power	Active Loop Antenna	AL-130	17043	2021-05-05	2 years
-	-	RF Cable	-	-	Each time ¹	N/A
310	Rohde & Schwarz	EMI Test Receiver	ESCI 1166.5950.03	100338	2021-11-18	1 year
-	Sunol Science Corp	System Controller	SC99V	011003-1	N/R	N/A
321	Sunol Sciences	Biconi-Log Antenna	JB3	A020106-2	2021-11-22	2 years
459	HP	Preamplifier	8447D	2443A04374	2021-11-02	1 year
1228	Pasternack	Coaxial Cable, RG213	PE3496-800CM	2111301	2021-11-30	1 year

Note¹: cable included in the test set-up will be checked each time before testing.

Statement of Traceability: BACL Corp. attests that all of the calibrations on the equipment items listed above were traceable to NIST or to another internationally recognized National Metrology Institute (NMI), and were compliant with the latest version of A2LA policy P102 "A2LA Policy on Metrological Traceability".

5.7 Test Environmental Conditions

Temperature:	23 ° C
Relative Humidity:	36-39 %
ATM Pressure:	101.6 kPa

The testing was performed by Deepak Mishra on from 2022-07-28 to 2022-09-29 in 5-meter chamber 3

5.8 Summary of Test Results

According to the data hereinafter, the EUT complied with the FCC Part 15C and ISEDC RSS-210 standard's radiated emissions limits, and had the worst margin of:

Mode: Transmitting			
Margin (dB)	Frequency (MHz)	Antenna Polarization	Range
-8.84	27.1205	Perpendicular	9 kHz – 30 MHz
-0.29	433.92	Horizontal	30 MHz – 150 MHz

Please refer to the following table and plots for specific test result details

5.9 Radiated Field Strength Test Data and Plots

9 kHz to 30 MHz Measured at 3 meters

Frequency (MHz)	S.A. Reading (dB μ V)	Turntable Azimuth (degrees)	Test Antenna		Cable Loss (dB)	Cord. Reading (dB μ V/m)	FCC/ISEDC		Comments
			Height (cm)	Factor (dB/m)			Limit (dB μ V/m)	Margin (dB)	
Loop Parallel									
13.56	77.79	160	100	11.4	0.4	89.59	124	-34.41	QP
13.553	53.69	200	100	11.4	0.4	65.49	90.47	-24.98	QP
13.567	53.37	171	100	11.4	0.4	65.17	90.47	-25.3	QP
13.41	10.4	12	100	11.4	0.4	22.2	80.51	-58.31	QP
13.7342	11.57	357	100	11.4	0.4	23.37	80.51	-57.14	QP
7.055	36.62	304	100	11.4	0.4	48.22	69.54	-21.32	QP
27.1205	48.96	68	100	11.4	0.4	60.56	69.54	-8.98	QP

Frequency (MHz)	S.A. Reading (dB μ V)	Turntable Azimuth (degrees)	Test Antenna		Cable Loss (dB)	Cord. Reading (dB μ V/m)	FCC/ISEDC		Comments
			Height (cm)	Factor (dB/m)			Limit (dB μ V/m)	Margin (dB)	
Loop Perpendicular									
13.56	76.47	250	100	11.4	0.4	88.27	124	-35.73	QP
13.553	53.94	259	100	11.4	0.4	65.74	90.47	-24.73	QP
13.567	53.62	253	100	11.4	0.4	65.42	90.47	-25.05	QP
13.16475	10.65	360	100	11.4	0.4	22.45	80.51	-58.06	QP
13.8414	11.82	78	100	11.4	0.4	23.62	80.51	-56.89	QP
7.05	28.22	214	100	11.4	0.4	39.82	69.54	-29.72	QP
27.1205	49.1	247	100	11.4	0.4	60.7	69.54	-8.84	QP

Note: the distance extrapolation factor (40 dB/decade) is used for below 30 MHz.

Below 30 MHz Radiated Field Strength (Parallel):

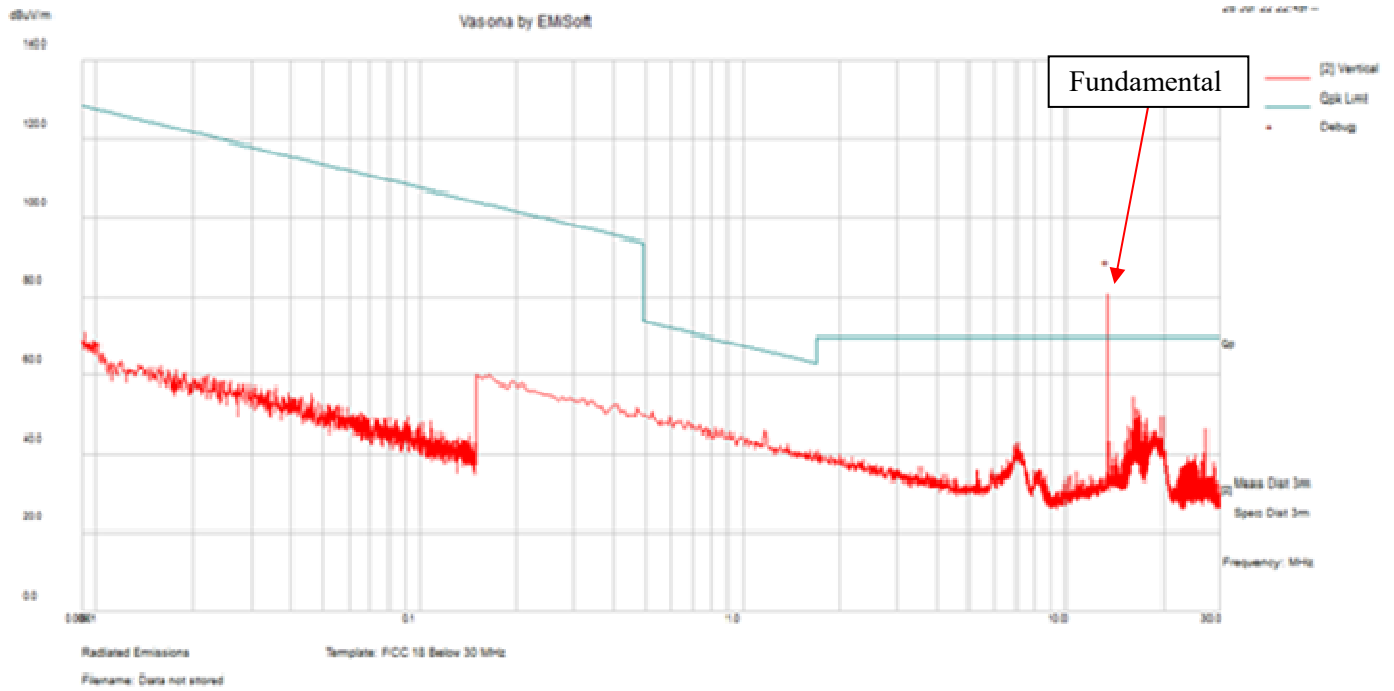

Below 30 MHz Radiated Field Strength (Perpendicular):

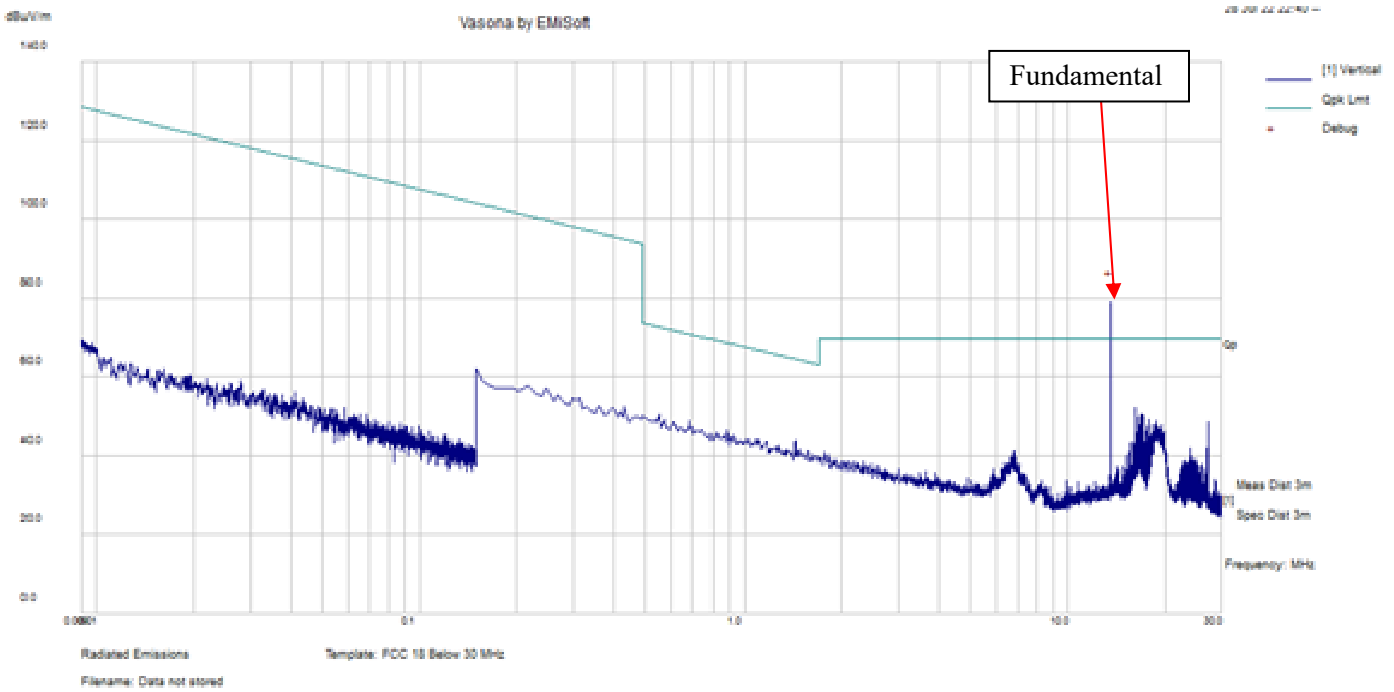

30 MHz – 1000 MHz Radiated Field Strength measured at 3 meters:

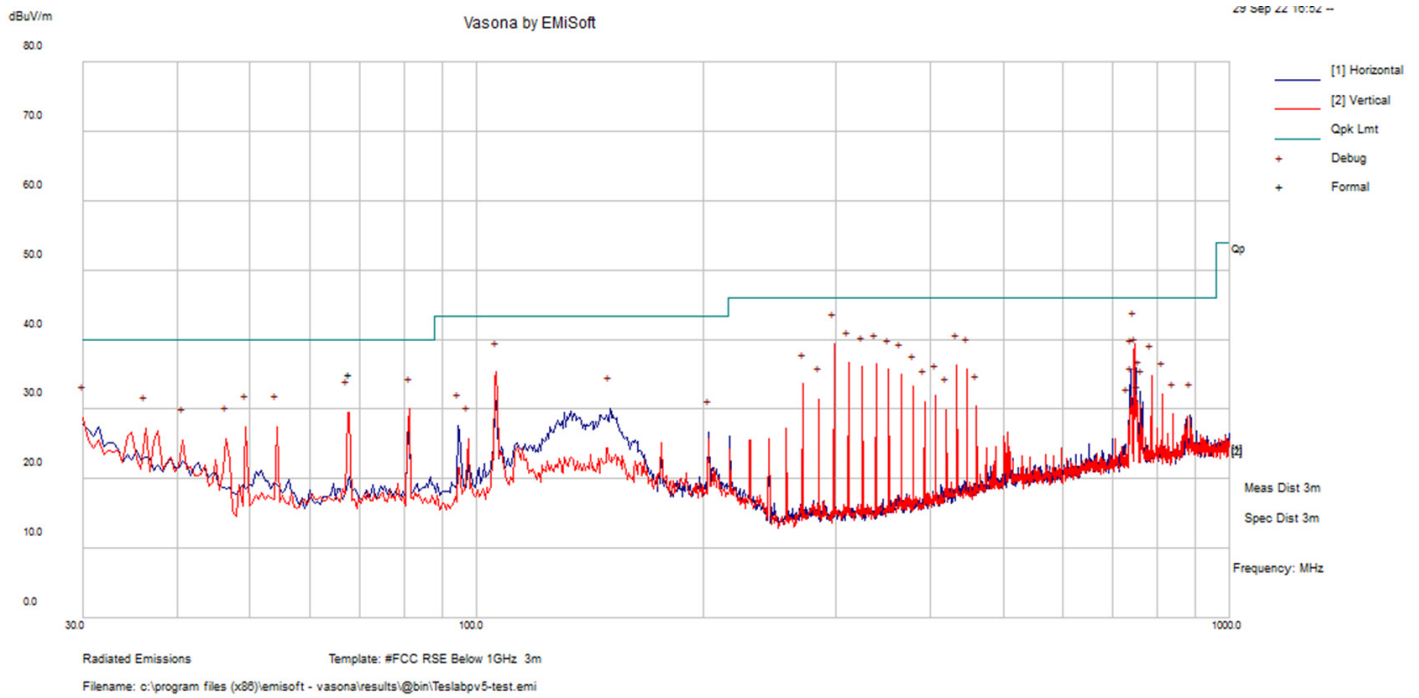

Frequency (MHz)	SA Reading (dBµV)	Correction Factor (dB/m)	Cord. Reading (dBµV/m)	Antenna Height (cm)	Polar. (H/V)	Turntable Azimuth (degrees)	Limit (dBuV/m)	Margin (dB)	Comment
746.83	48.35	-8.88	39.47	200	V	291	46	-6.53	QP
298.205	57.1	-17.74	39.36	200	V	319	46	-6.64	QP
106.145	54.8	-19.56	35.24	100	V	279	43.5	-8.26	QP
311.785	54.11	-17.41	36.7	200	V	322	46	-9.3	QP
338.945	53.57	-17.22	36.35	200	V	311	46	-9.65	QP
434.005	50.73	-14.46	36.27	100	V	251	46	-9.73	QP

6 FCC §15.225(e) & ISEDC RSS-210, Annex B.6 – Frequency Tolerance

6.1 Applicable Standards

As per FCC §15.225(e): Operation within the band 13.110-14.010 MHz

(e) The frequency tolerance of the carrier signal shall be maintained within $\pm 0.01\%$ of the operating frequency over a temperature variation of -20 degrees to $+ 50$ degrees C at normal supply voltage, and for a variation in the primary supply voltage from 85% to 115% of the rated supply voltage at a temperature of 20 degrees C. For battery operated equipment, the equipment tests shall be performed using a new battery.

As per ISEDC RSS-210 Annex B.6 Band 13.110 – 14.010 MHz:

- a. the carrier frequency stability shall not exceed ± 100 ppm

6.2 Test Setup Block Diagram

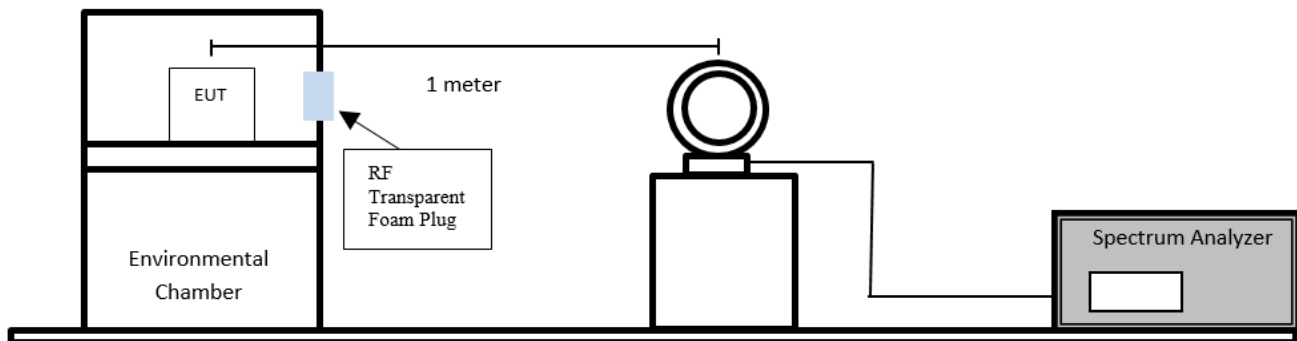

6.3 Test Equipment List and Details

BACL No.	Manufacturer	Description	Model No.	Serial No.	Calibration Date	Calibration Interval
912	Rhode & Schwarz	Signal Analyzer	FSV40	1321.3008k39 -101203-UW	2022-05-05	1 year
1060	BACL	Temp and Humi Chamber	BTH-150-40	30078	2021-09-23	1 year
393	Com-Power	Active Loop Antenna	AL-130	17043	2021-05-05	2 years
-	-	RF Cable	-	-	Each time ¹	N/A

Note¹: cable included in the test set-up will be checked each time before testing.

Statement of Traceability: BACL Corp. attests that all of the calibrations on the equipment items listed above were traceable to NIST or to another internationally recognized National Metrology Institute (NMI), and were compliant with the latest version of A2LA policy P102 "A2LA Policy on Metrological Traceability".

6.4 Test Environmental Conditions

Temperature:	25° C
Relative Humidity:	48 %
ATM Pressure:	101.2 kPa

The testing was performed by Deepak Mishra on 2022-08-17 at RF Site.

6.5 Test Results

Normal Voltage 16 V_{DC}

Temperature °C	Operating Frequency (MHz)	Measured Frequency (MHz)	Frequency Tolerance (ppm)	Limit (ppm)	Result
-20	13.56	13.5602225	16.40855457	±100	Pass
-10	13.56	13.5601875	13.82743363	±100	Pass
0	13.56	13.5601475	10.87758112	±100	Pass
10	13.56	13.5600625	4.609144543	±100	Pass
20	13.56	13.5599825	-1.290560472	±100	Pass
30	13.56	13.5599075	-6.821533923	±100	Pass
40	13.56	13.5598275	-12.72123894	±100	Pass
50	13.56	13.5597675	-17.1460177	±100	Pass

Normal Temperature 20°C

Voltage (V _{DC})	Operating Frequency (MHz)	Measured Frequency (MHz)	Frequency Tolerance (ppm)	Limit (ppm)	Result
13.6	13.56	13.5599775	-1.659292035	±100	Pass
18.4	13.56	13.5599725	-2.028023599	±100	Pass

Please refer to the following plots for detail

-20 °C

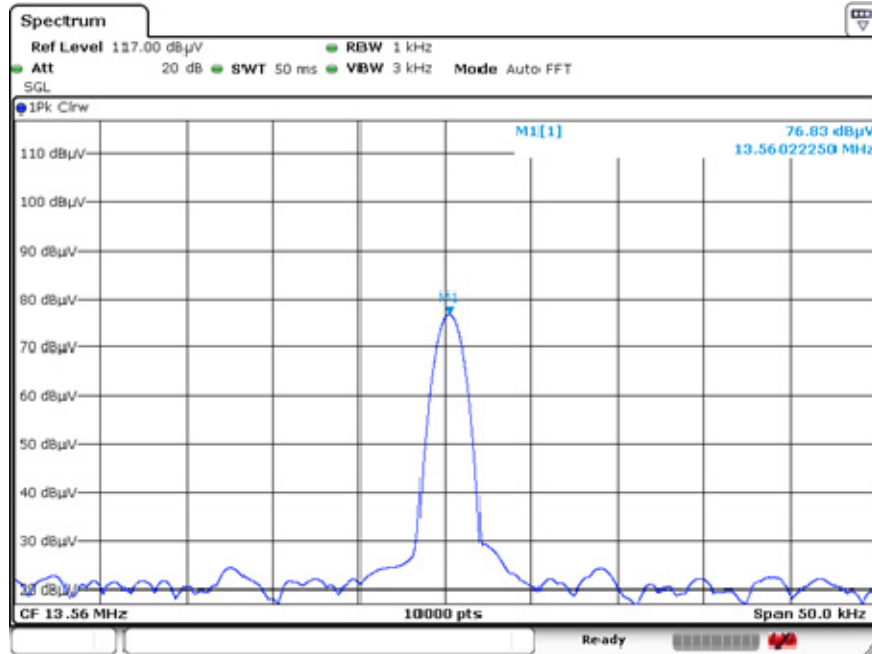

Date: 17.AUG 2022 16:45:29

-10 °C

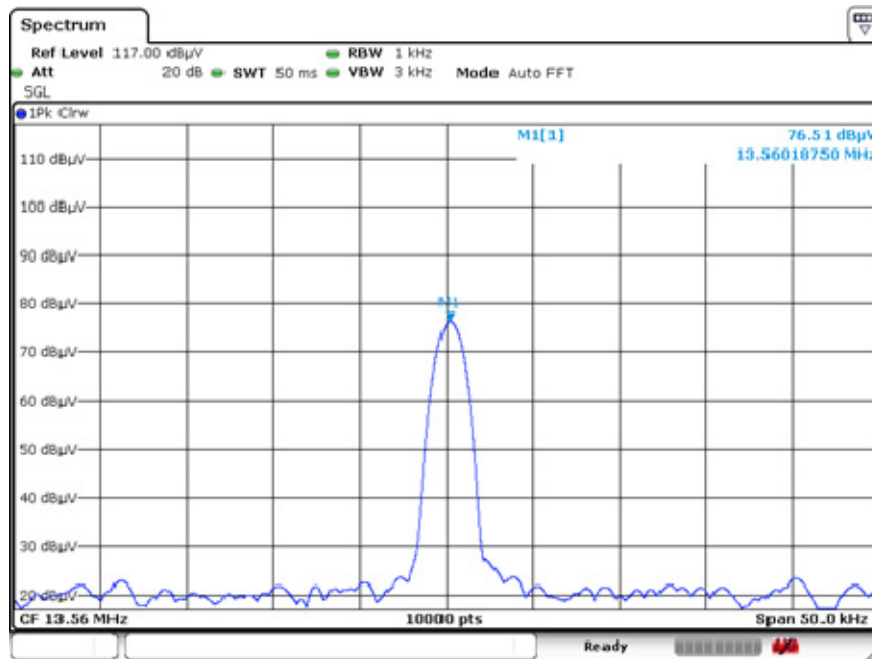

Date: 17.AUG 2022 17:20:55

0 °C

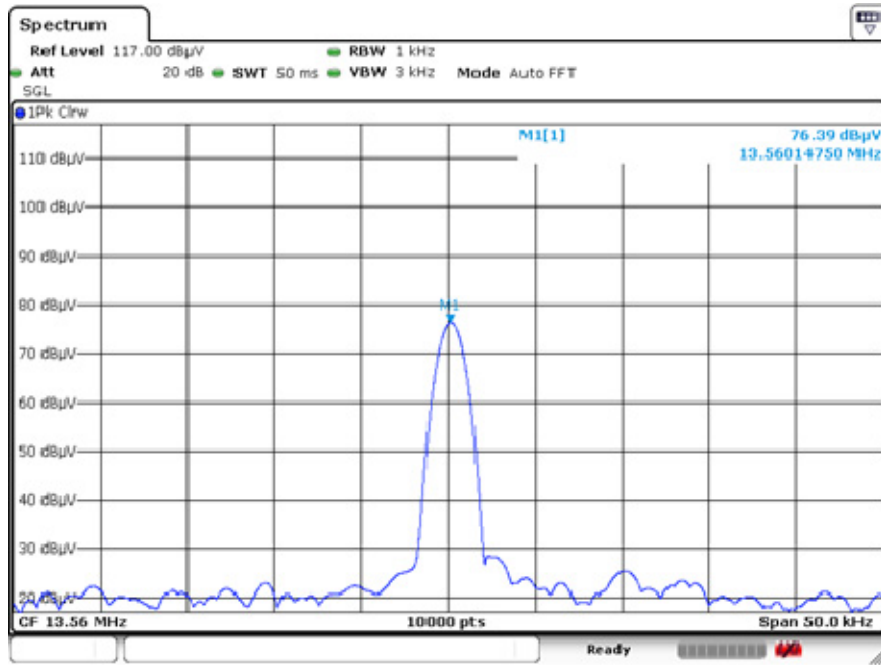

Date: 17.AUG 2022 17:28:10

10 °C

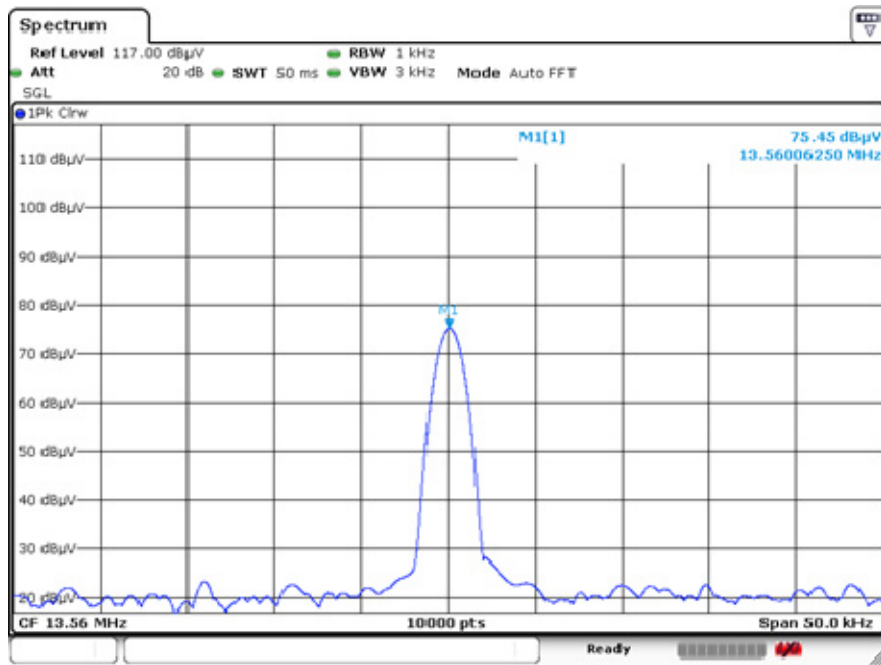

Date: 17.AUG 2022 17:37:56

20 °C

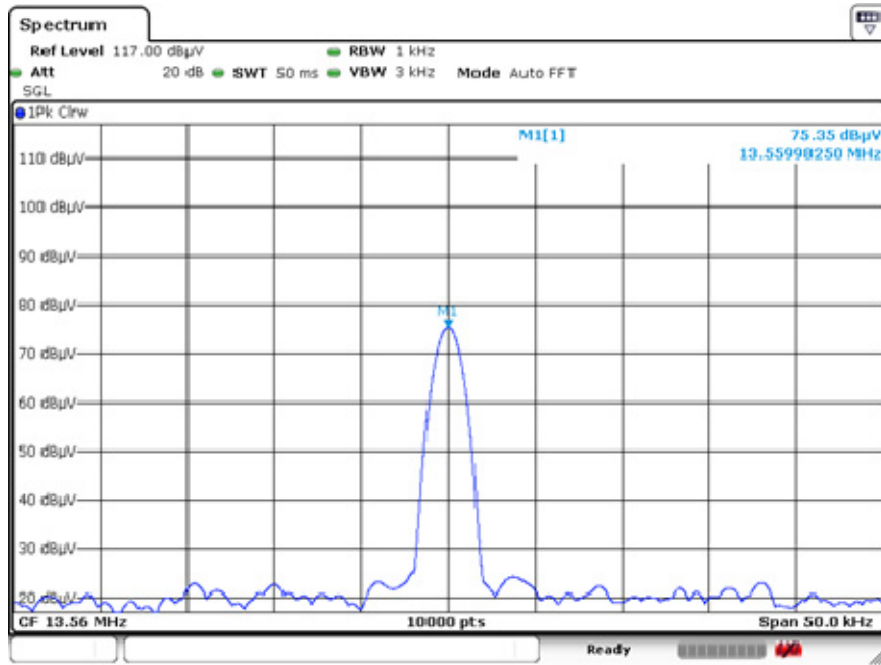

Date: 17.AUG.2022 17:46:35

30 °C

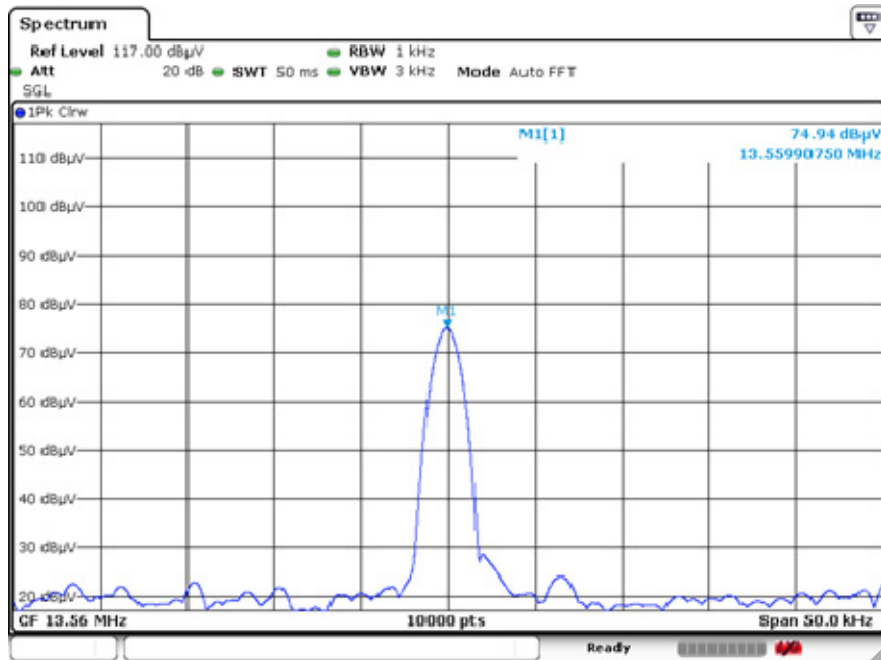

Date: 17.AUG.2022 17:56:23

40 °C

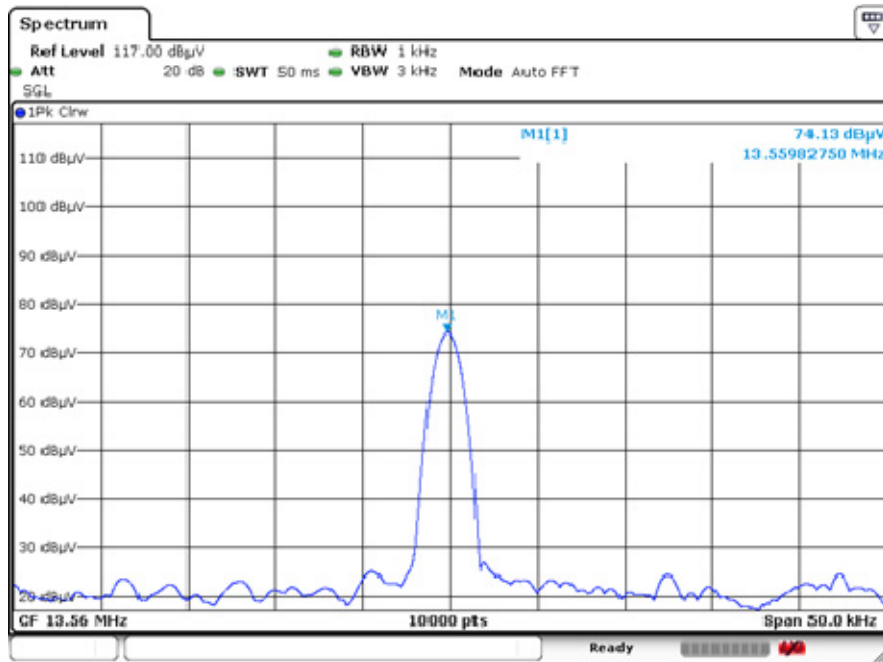

Date: 17.AUG.2022 18:04:45

50 °C

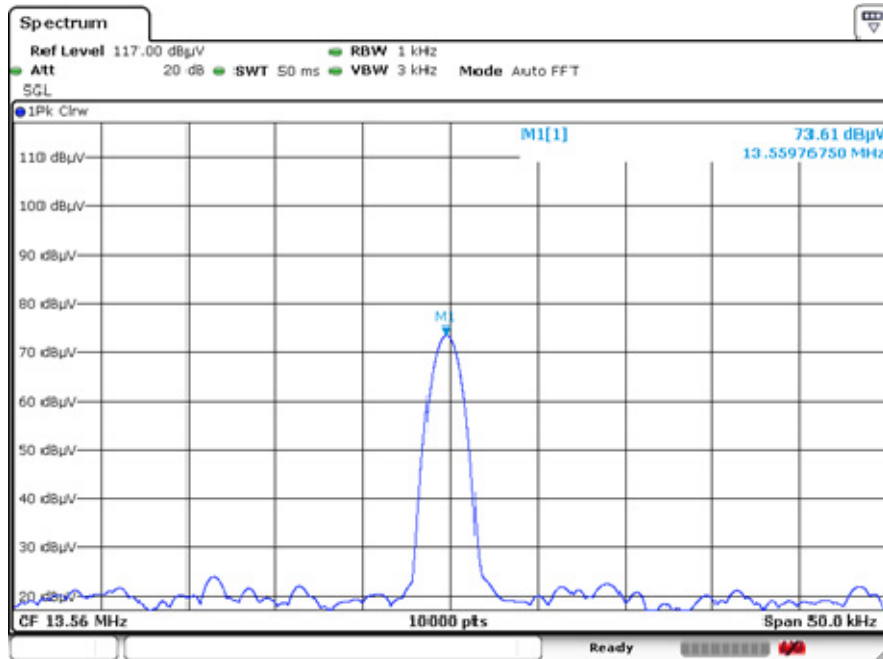

Date: 17.AUG.2022 18:30:15

Low Voltage 13.6 V_{DC}

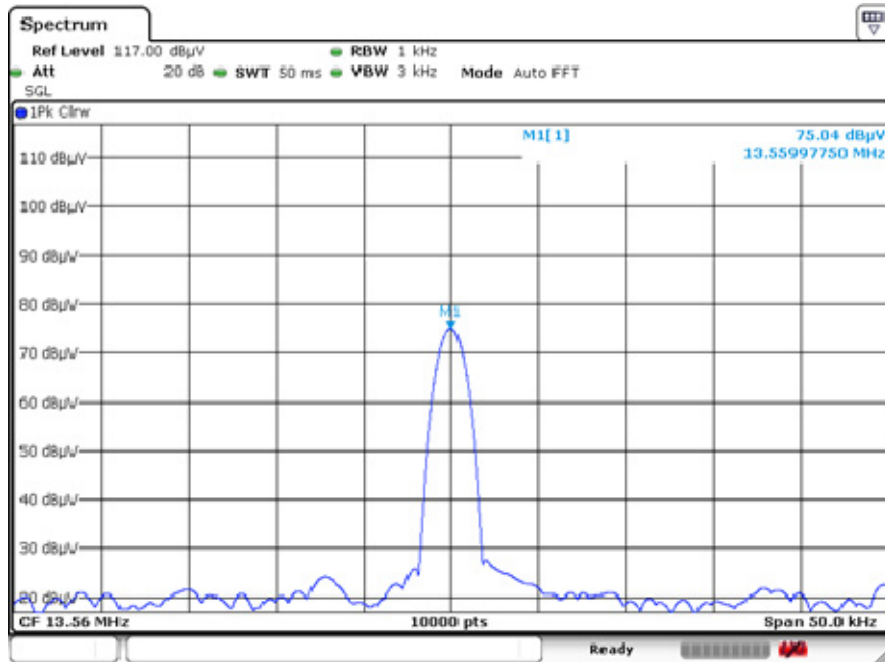

Date: 17.AUG.2022 17:47:31

High Voltage 18.4 V_{DC}

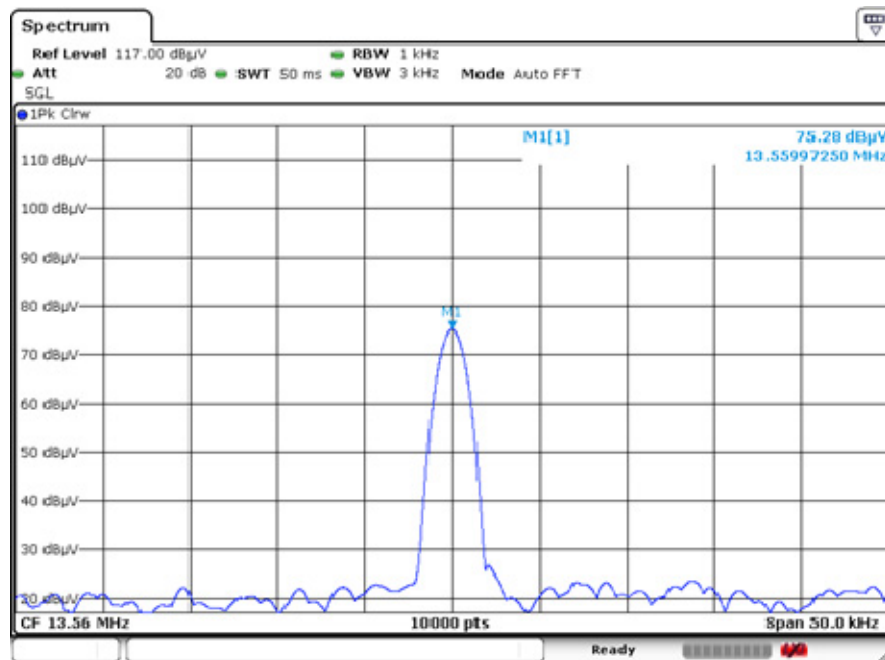

Date: 17.AUG.2022 17:48:17

7 FCC §15.215(c) & ISEDC RSS-GEN §6.7 - Occupied Bandwidth

7.1 Applicable Standards

As per FCC §15.215(c):

Intentional radiators operating under the alternative provisions to the general emission limits, as contained in §§15.217 through 15.257 and in subpart E of this part, must be designed to ensure that the 20 dB bandwidth of the emission, or whatever bandwidth may otherwise be specified in the specific rule section under which the equipment operates, is contained within the frequency band designated in the rule section under which the equipment is operated. In the case of intentional radiators operating under the provisions of subpart E, the emission bandwidth may span across multiple contiguous frequency bands identified in that subpart. The requirement to contain the designated bandwidth of the emission within the specified frequency band includes the effects from frequency sweeping, frequency hopping and other modulation techniques that may be employed as well as the frequency stability of the transmitter over expected variations in temperature and supply voltage. If a frequency stability is not specified in the regulations, it is recommended that the fundamental emission be kept within at least the central 80% of the permitted band in order to minimize the possibility of out-of-band operation.

As per ISEDC RSS-GEN §6.7:

The occupied bandwidth or the “99% emission bandwidth” is defined as the frequency range between two points, one above and the other below the carrier frequency, within which 99% of the total transmitted power of the fundamental transmitted emission is contained. The occupied bandwidth shall be reported for all equipment in addition to the specified bandwidth required in the applicable RSSs.

In some cases, the “x dB bandwidth” is required, which is defined as the frequency range between two points, one at the lowest frequency below and one at the highest frequency above the carrier frequency, at which the maximum power level of the transmitted emission is attenuated x dB below the maximum in-band power level of the modulated signal, where the two points are on the outskirts of the in-band emission.

The following conditions shall be observed for measuring the occupied bandwidth and x dB bandwidth:

- The transmitter shall be operated at its maximum carrier power measured under normal test conditions.
- The span of the spectrum analyzer shall be set large enough to capture all products of the modulation process, including the emission skirts, around the carrier frequency, but small enough to avoid having other emissions (e.g. on adjacent channels) within the span.
- The detector of the spectrum analyzer shall be set to “Sample”. However, a peak, or peak hold, may be used in place of the sampling detector since this usually produces a wider bandwidth than the actual bandwidth (worst-case measurement). Use of a peak hold (or “Max Hold”) may be necessary to determine the occupied / x dB bandwidth if the device is not transmitting continuously.

The resolution bandwidth (RBW) shall be in the range of 1% to 5% of the actual occupied / x dB bandwidth and the video bandwidth (VBW) shall not be smaller than three times the RBW value. Video averaging is not permitted

7.2 Test Setup

The radiated emissions tests were performed in the 5-meter Chamber, using the setup in accordance with ANSI C63.10-2014. The specification utilized was the FCC §15.225, §15.209 limits.

The spacing between the peripherals was 10 centimeters.

External I/O cables were draped along the edge of the test table and bundle when necessary.

7.3 Test Setup Block Diagram

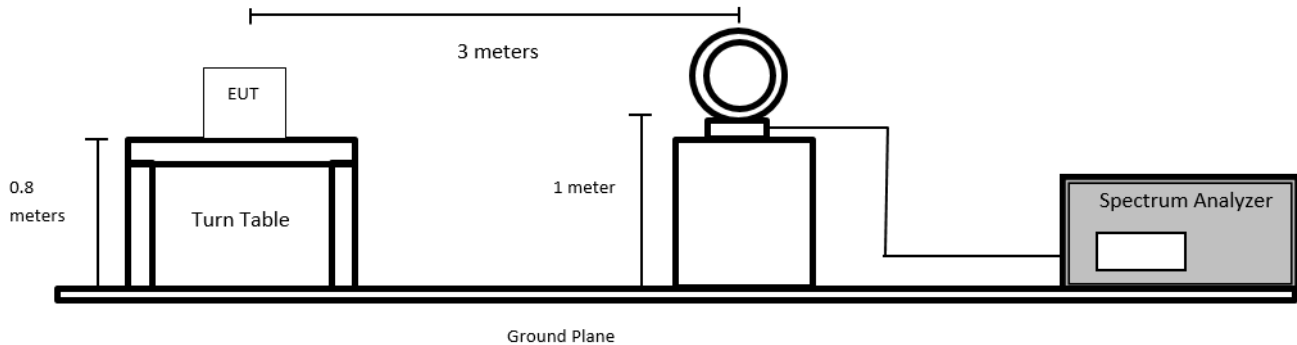

7.4 Test Equipment List and Details

BACL No.	Manufacturer	Description	Model No.	Serial No.	Calibration Date	Calibration Interval
912	Rhode & Schwarz	Signal Analyzer	FSV40	1321.3008k39-101203-UW	2022-05-05	1 year
1060	BACL	Temp and Humi Chamber	BTH-150-40	30078	2021-09-23	1 year
393	Com-Power	Active Loop Antenna	AL-130	17043	2021-05-05	2 years
-	-	RF Cable	-	-	Each time ¹	N/A

Note¹: cable included in the test set-up will be checked each time before testing.

Statement of Traceability: BACL Corp. attests that all of the calibrations on the equipment items listed above were traceable to NIST or to another internationally recognized National Metrology Institute (NMI), and were compliant with the latest version of A2LA policy P102 "A2LA Policy on Metrological Traceability".

7.5 Test Environmental Conditions

Temperature:	25° C
Relative Humidity:	48 %
ATM Pressure:	101.2 kPa

The testing was performed by Deepak Mishra on 2022-08-18 at RF Site.

7.6 Test Results

20 dB Bandwidth: 777 Hz

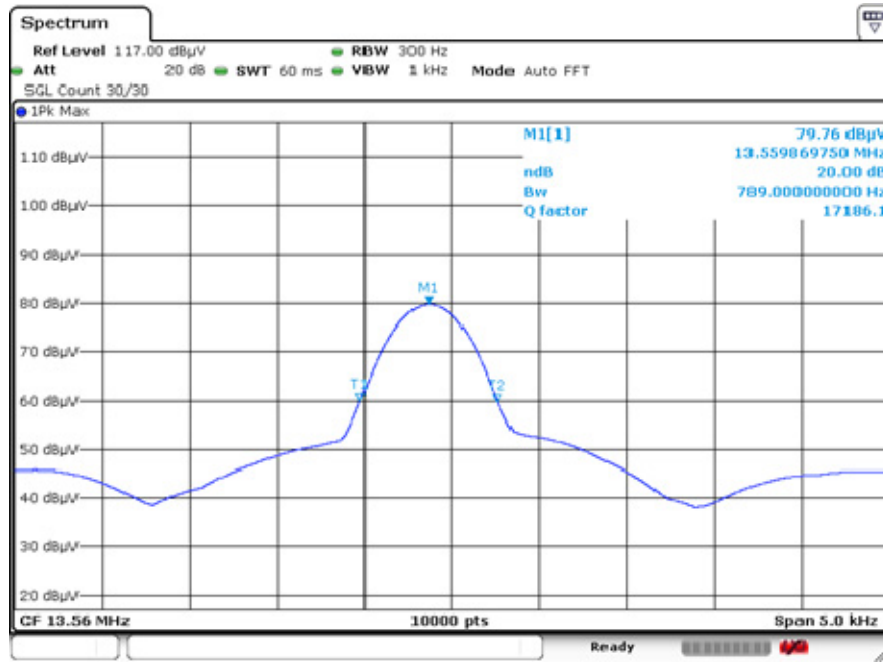

Date: 17.AUG.2022 15:53:23

8 Annex A (Normative) - Test Setup Photographs

Please refer to the attachment

9 Annex B (Normative) - EUT External Photographs

Please refer to the attachment

10 Annex C (Normative) - EUT Internal Photographs

Please refer to the attachment

11 Annex D (Normative) - A2LA Electrical Testing Certificate



Accredited Laboratory

A2LA has accredited

BAY AREA COMPLIANCE LABORATORIES CORP.

Sunnyvale, CA

for technical competence in the field of

Electrical Testing

This laboratory is accredited in accordance with the recognized International Standard ISO/IEC 17025:2017 *General requirements for the competence of testing and calibration laboratories*. This laboratory also meets A2LA R222 - *Specific Requirements EPA ENERGY STAR Accreditation Program*. This accreditation demonstrates technical competence for a defined scope and the operation of a laboratory quality management system (refer to joint ISO-ILAC-IAF Communiqué dated April 2017).



Presented this 10th day of March 2021.

A handwritten signature in blue ink, appearing to read 'Trace McInturf'.

Trace McInturf, Vice President, Accreditation Services
 For the Accreditation Council
 Certificate Number 3297.02
 Valid to November 30, 2022
 Revised September 16, 2022

For the tests to which this accreditation applies, please refer to the laboratory's Electrical Scope of Accreditation.

Please follow the web link below for a full ISO 17025 scope

<https://www.a2la.org/scopepdf/3297-02.pdf>

--- END OF REPORT ---