



FCC PART 15, SUBPART C ISED C RSS-247, ISSUE 2, FEBRUARY 2017



TEST AND MEASUREMENT REPORT

For

Tesla, Inc

3500 Deer Creek Road, Palo Alto, CA 94304

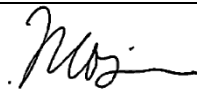
FCC ID: 2AEIM-1555258
IC: 20098-1555258

Report Type: Original Report	Product Type: Door Handle Endpoint
Prepared By: Marc Jean Test Technician	
Report Number: R2109222-02	
Report Date: 2022-07-29	
Reviewed By: Christian McCaig RF Lead Engineer	
Bay Area Compliance Laboratories Corp. 1274 Anvilwood Avenue, Sunnyvale, CA 94089, USA Tel: +1 (408) 732-9162, Fax: +1 (408) 732-9164	



Note: This test report is prepared for the customer shown above and for the device described herein. It may not be duplicated or used in part without prior written consent from Bay Area Compliance Laboratories Corp. This report **must not** be used by the customer to claim product certification, approval, or endorsement by A2LA*, NIST, or any agency of the Federal Government.

* This report may contain data that are not covered by the A2LA accreditation and are marked with an asterisk "*" (Rev.2)

TABLE OF CONTENTS

1	General Description.....	5
1.1	Product Description for Equipment Under Test (EUT)	5
1.2	Mechanical Description of EUT	5
1.3	Objective.....	5
1.4	Related Submittal(s)/Grant(s)	5
1.5	Test Methodology	5
1.6	Measurement Uncertainty	6
1.7	Test Facility Registrations	6
1.8	Test Facility Accreditations	7
2	System Test Configuration.....	9
2.1	Justification	9
2.2	EUT Exercise Software.....	9
2.3	Duty Cycle Correction Factor	9
2.4	Equipment Modifications.....	10
3	Summary of Test Results	12
4	FCC §15.203 & ISEDC RSS-Gen §6.8 - Antenna Requirements	13
4.1	Applicable Standards	13
4.2	Antenna Description	13
5	FCC §15.209, §15.247(d) & ISEDC RSS-247 §5.5, RSS-Gen §8.9, §8.10 - Spurious Radiated Emissions.....	14
5.1	Applicable Standards	14
5.2	Test Setup	15
5.3	Test Setup Block Diagrams	16
5.4	Test Procedure	17
5.5	Corrected Amplitude & Margin Calculation.....	18
5.6	Test Equipment List and Details.....	19
5.7	Test Environmental Conditions	19
5.8	Summary of Test Results	20
5.9	Radiated Emissions Test Results	20
6	FCC §15.247(a) (2) & ISEDC RSS-247 §5.2, RSS-Gen §6.7 - Emission Bandwidth.....	24
6.1	Applicable Standards	24
6.2	Measurement Procedure.....	24
6.3	Test Setup Diagram	24
6.4	Test Equipment List and Details.....	24
6.5	Test Environmental Conditions	24
6.6	Test Results.....	25
7	FCC §15.247(b) (3) & ISEDC RSS-247 §5.4 - Maximum Output Power	29
7.1	Applicable Standards	29
7.2	Measurement Procedure.....	29
7.3	Test Setup Diagram	29
7.4	Test Equipment List and Details.....	29
7.5	Test Environmental Conditions	30
7.6	Test Results.....	30
8	FCC §15.247(e) & ISEDC RSS-247 §5.2(2) - Peak Power Spectral Density.....	32
8.1	Applicable Standards	32
8.2	Measurement Procedure.....	32
8.3	Test Setup Diagram	32
8.4	Test Equipment List and Details.....	32
8.5	Test Environmental Conditions	32
8.6	Test Results.....	33
9	FCC §15.247(d) & ISEDC RSS-247 §5.5 - 100 kHz Bandwidth of Band Edges.....	35
9.1	Applicable Standards	35
9.2	Measurement Procedure.....	35
9.3	Test Setup Diagram	35
9.4	Test Equipment List and Details.....	36
9.5	Test Environmental Conditions	36

9.6 Test Results..... 36

10 FCC §15.247(d) & ISEDC RSS-247 §5.5 - Spurious Emissions at Antenna Terminals 38

10.1 Applicable Standards 38

10.2 Test Procedure 38

10.3 Test Setup Diagram 38

10.4 Test Equipment List and Details..... 38

10.5 Test Environmental Conditions 39

10.6 Test Results..... 39

11 Annex A (Normative) - Test Setup Photographs 41

12 Annex B (Normative) - EUT External Photographs..... 42

13 Annex C (Normative) - EUT Internal Photographs 43

14 Annex D (Normative) - A2LA Electrical Testing Certificate..... 44

DOCUMENT REVISION HISTORY

Revision Number	Report Number	Description of Revision	Date of Revision
0	R2109222-02	Original Report	2022-07-29

1 General Description

1.1 Product Description for Equipment Under Test (EUT)

This test report was prepared on behalf of *Tesla, Inc*, and their product model: 1555258 with FCC ID: 2AEIM-1555258, IC: 20098-1555258. The device will be referred to as the “EUT” throughout this report. It is a Door Handle Endpoint with BLE and NFC functionality.

1.2 Mechanical Description of EUT

1555258 measures approximately 114 mm (Length), 130 mm (Width), and 24 mm (Height) and weighs approximately 0.1kg.

*The data gathered are from production samples provided by Tesla, Inc with BACL assigned serial numbers:
Conducted Sample S/N: R2109222-1
Radiated Sample S/N: R2109222-2*

1.3 Objective

This report was prepared on behalf of *Tesla, Inc*, in accordance with Part 2, Subpart J, and Part 15, Subpart C of the Federal Communication Commission’s rules and ISEDC RSS-247 Issue 2, February 2017.

The objective was to determine compliance with FCC Part 15.247 and ISEDC RSS-247 for Antenna Requirement, RF Exposure, AC Line Conducted Emissions, Emission Bandwidth, Radiated & Conducted Spurious Emissions, 100 kHz Band Edges, Maximum Output Power, and Peak Power Spectrum Density

1.4 Related Submittal(s)/Grant(s)

FCC Part 15, Subpart C, Equipment Class: DXX with FCC ID: 2AEIM-1555258; IC: 20098-1555258

1.5 Test Methodology

All measurements contained in this report were conducted in accordance with ANSI C63.10-2013, American National Standard of Procedures for Compliance Testing of Unlicensed Wireless Devices.

1.6 Measurement Uncertainty

All measurements involve certain levels of uncertainties, especially in the field of EMC. The factors contributing to uncertainties are spectrum analyzer, cable loss, antenna factor calibration, antenna directivity, antenna factor variation with height, antenna phase center variation, antenna factor frequency interpolation, measurement distance variation, site imperfections, mismatch (average), and system repeatability.

Parameter	Measurement uncertainty
Occupied Channel Bandwidth	±5 %
RF output power, conducted	±0.57 dB
Power Spectral Density, conducted	±1.48dB
Unwanted Emissions, conducted	±1.57dB
All emissions, radiated	±4.0 dB
AC power line Conducted Emission	±2.0 dB
Temperature	±2 ° C
Humidity	±5 %
DC and low frequency voltages	±1.0 %
Time	±2 %
Duty Cycle	±3 %

1.7 Test Facility Registrations

BACLs test facilities that are used to perform Radiated and Conducted Emissions tests are currently recognized by the Federal Communications Commission as Accredited with NIST Designation Number US1129.

BACL's test facilities that are used to perform Radiated and Conducted Emissions tests are currently registered with Industry Canada under Registration Numbers: 3062A-1, 3062A-2, and 3062A-3.

BACL is a Chinese Taipei Bureau of Standards Metrology and Inspection (BSMI) validated Conformity Assessment Body (CAB), under Appendix B, Phase I Procedures of the APEC Mutual Recognition Arrangement (MRA). BACL's BSMI Lab Code Number is: SL2-IN-E-1002R

BACL's test facilities that are used to perform AC Line Conducted Emissions, Telecommunications Line Conducted Emissions, Radiated Emissions from 30 MHz to 1 GHz, and Radiated Emissions from 1 GHz to 6 GHz are currently recognized as Accredited in accordance with the Voluntary Control Council for Interference [VCCI] Article 15 procedures under Registration Number A-0027.

1.8 Test Facility Accreditations

Bay Area Compliance Laboratories Corp. (BACL) is:

A- An independent, 3rd-Party, Commercial Test Laboratory accredited to ISO/IEC 17025:2017 by A2LA (Test Laboratory Accreditation Certificate Number 3297.02), in the fields of: Electromagnetic Compatibility and Telecommunications. Unless noted by an Asterisk (*) in the Compliance Matrix (See Section 3 of this Test Report), BACL's ISO/IEC 17025:2017 Scope of Accreditation includes all of the Test Method Standards and/or the Product Family Standards detailed in this Test Report.

BACL's ISO/IEC 17025:2017 Scope of Accreditation includes a comprehensive suite of EMC Emissions, EMC Immunity, Radio, RF Exposure, Safety and wireline Telecommunications test methods applicable to a wide range of product categories. These product categories include Central Office Telecommunications Equipment [including NEBS - Network Equipment Building Systems], Unlicensed and Licensed Wireless and RF devices, Information Technology Equipment (ITE); Telecommunications Terminal Equipment (TTE); Medical Electrical Equipment; Industrial, Scientific and Medical Test Equipment; Professional Audio and Video Equipment; Industrial and Scientific Instruments and Laboratory Apparatus; Cable Distribution Systems, and Energy Efficient Lighting.

B- A Product Certification Body accredited to ISO/IEC 17065:2012 by A2LA (Product Certification Body Accreditation Certificate Number 3297.03) to certify

- For the USA (Federal Communications Commission):

- 1- All Unlicensed radio frequency devices within FCC Scopes A1, A2, A3, and A4;
- 2- All Licensed radio frequency devices within FCC Scopes B1, B2, B3, and B4;
- 3- All Telephone Terminal Equipment within FCC Scope C.

- For the Canada (Industry Canada):

- 1 All Scope 1-Licence-Exempt Radio Frequency Devices;
- 2 All Scope 2-Licensed Personal Mobile Radio Services;
- 3 All Scope 3-Licensed General Mobile & Fixed Radio Services;
- 4 All Scope 4-Licensed Maritime & Aviation Radio Services;
- 5 All Scope 5-Licensed Fixed Microwave Radio Services
- 6 All Broadcasting Technical Standards (BETS) in the Category I Equipment Standards List.

- For Singapore (Info-Communications Development Authority (IDA)):

- 1 All Line Terminal Equipment: All Technical Specifications for Line Terminal Equipment – Table 1 of IDA MRA Recognition Scheme: 2011, Annex 2
2. All Radio-Communication Equipment: All Technical Specifications for Radio-Communication Equipment – Table 2 of IDA MRA Recognition Scheme: 2011, Annex 2

- For the Hong Kong Special Administrative Region:

- 1 All Radio Equipment, per KHCA 10XX-series Specifications;
- 2 All GMDSS Marine Radio Equipment, per HKCA 12XX-series Specifications;
- 3 All Fixed Network Equipment, per HKCA 20XX-series Specifications.

- For Japan:

- 1 MIC Telecommunication Business Law (Terminal Equipment):
 - All Scope A1 - Terminal Equipment for the Purpose of Calls;
 - All Scope A2 - Other Terminal Equipment
- 2 Radio Law (Radio Equipment):
 - All Scope B1 - Specified Radio Equipment specified in Article 38-2-2, paragraph 1, item 1 of the Radio Law
 - All Scope B2 - Specified Radio Equipment specified in Article 38-2-2, paragraph 1, item 2 of the Radio Law
 - All Scope B3 - Specified Radio Equipment specified in Article 38-2-2, paragraph 1, item 3 of the Radio Law

C- A Product Certification Body accredited to ISO/IEC 17065:2012 by A2LA (Product Certification Body Accreditation Certificate Number 3297.01) to certify Products to USA's Environmental Protection Agency (EPA) ENERGY STAR Product Specifications for:

- 1 Electronics and Office Equipment:
 - for Telephony (ver. 3.0)
 - for Audio/Video (ver. 3.0)
 - for Battery Charging Systems (ver. 1.1)
 - for Set-top Boxes & Cable Boxes (ver. 4.1)
 - for Televisions (ver. 6.1)
 - for Computers (ver. 6.0)
 - for Displays (ver. 6.0)
 - for Imaging Equipment (ver. 2.0)
 - for Computer Servers (ver. 2.0)
- 2 Commercial Food Service Equipment
 - for Commercial Dishwashers (ver. 2.0)
 - for Commercial Ice Machines (ver. 2.0)
 - for Commercial Ovens (ver. 2.1)
 - for Commercial Refrigerators and Freezers
- 3 Lighting Products
 - For Decorative Light Strings (ver. 1.5)
 - For Luminaires (including sub-components) and Lamps (ver. 1.2)
 - For Compact Fluorescent Lamps (CFLs) (ver. 4.3)
 - For Integral LED Lamps (ver. 1.4)
- 4 Heating, Ventilation, and AC Products
 - for Residential Ceiling Fans (ver. 3.0)
 - for Residential Ventilating Fans (ver. 3.2)
- 5 Other
 - For Water Coolers (ver. 3.0)

D- A NIST Designated Phase-I and Phase-II Conformity Assessment Body (CAB) for the following economies and regulatory authorities under the terms of the stated MRAs/Treaties:

- Australia: ACMA (Australian Communication and Media Authority) – APEC Tel MRA -Phase I;
- Canada: (Innovation, Science and Economic development Canada - ISEDC) Foreign Certification Body – FCB – APEC Tel MRA -Phase I & Phase II;
- Chinese Taipei (Republic of China – Taiwan):
 - o BSMI (Bureau of Standards, Metrology and Inspection) APEC Tel MRA -Phase I;
 - o NCC (National Communications Commission) APEC Tel MRA -Phase I;
- European Union:
 - o EMC Directive 2014/30/EU US-EU EMC & Telecom MRA CAB (NB)
 - o Radio Equipment (RE) Directive 2014/53/EU US-EU EMC & Telecom MRA CAB (NB)
 - o Low Voltage Directive (LVD) 2014/35/EU
- Hong Kong Special Administrative Region: (Office of the Telecommunications Authority – OFTA) APEC Tel MRA -Phase I & Phase II
- Israel – US-Israel MRA Phase I
- Republic of Korea (Ministry of Communications - Radio Research Laboratory) APEC Tel MRA -Phase I
- Singapore: (Infocomm Media Development Authority - IMDA) APEC Tel MRA -Phase I & Phase II;
- Japan: VCCI - Voluntary Control Council for Interference US-Japan Telecom Treaty VCCI Side Letter-
- USA:
 - o ENERGY STAR Recognized Test Laboratory – US EPA
 - o Telecommunications Certification Body (TCB) – US FCC;
 - o Nationally Recognized Test Laboratory (NRTL) – US OSHA
- Vietnam: APEC Tel MRA -Phase I;

2 System Test Configuration

2.1 Justification

The EUT was configured for testing in accordance to ANSI C63.10.

2.2 EUT Exercise Software

TeraTerm was used to transmit signals for all the channels. The software used are compliant with the standard requirements being tested against. The following channels and power settings were selected for testing.

Channel Frequency (MHz)	Power Settings Tested
2402	0xC
2440	0xC
2480	0xC

2.3 Duty Cycle Correction Factor

According to KDB 558074 D01 DTS Meas Guidance v05r02 section 6.0:

Preferably, all measurements of maximum conducted (average) output power will be performed with the EUT transmitting continuously (i.e., with a duty cycle of greater than or equal to 98%). When continuous operation cannot be realized, then the use of sweep triggering/signal gating techniques can be utilized to ensure that measurements are made only during transmissions at the maximum power control level. Such sweep triggering/signal gating techniques will require knowledge of the minimum transmission duration (T) over which the transmitter is on and is transmitting at its maximum power control level for the tested mode of operation. Sweep triggering/signal gating techniques can then be used if the measurement/sweep time of the analyzer can be set such that it does not exceed T at any time that data is being acquired (i.e., no transmitter off-time is to be considered).

Radio frequency (MHz)	On Time (ms)	Period (ms)	Duty Cycle (%)	Duty Cycle Correction Factor (dB)
2402	-	-	100	0

Duty Cycle = On Time (ms)/ Period (ms)

Duty Cycle Correction Factor (dB) = $10 \cdot \log(1/\text{Duty Cycle})$

Please refer to the following plots.

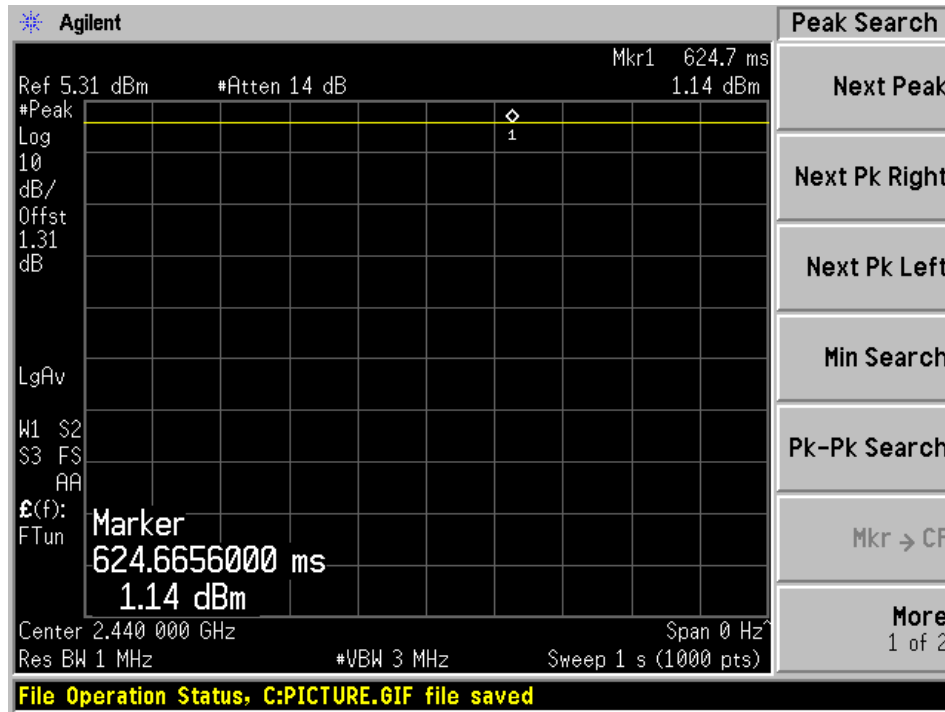

2.4 Equipment Modifications

N/A

2.5 Local Support Equipment

Manufacturer	Description	Model No.	Serial No.
Volteq	DC Power Supply	HY5003D	160402343

2.6 Remote Support Equipment

Manufacturer	Description	Model
HP	Laptop	ZBook Studio G3
Teensy	Microcontroller	-

2.7 Interface Ports and Cabling

Cable Descriptions	Length (m)	From	To
USB Type A to Micro USB Type B	< 1 m	Microcontroller	Laptop
Power cables	< 1 m	EUT	Power Supply
RS-232	< 1 m	EUT	Microcontroller

2.8 EUT Setup Block Diagram

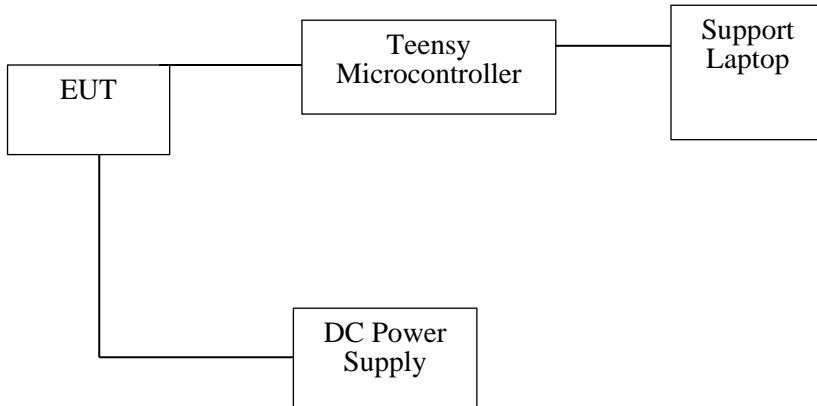

Note: Rated Input Voltage: 12V

3 Summary of Test Results

Results reported relate only to the product tested.

FCC & ISEDC Rules	Description of Test	Results
FCC §15.203 ISEDC RSS-Gen §6.8	Antenna Requirements	Compliant
FCC §2.1093, §15.247(i) ISEDC RSS-102	RF Exposure	Compliant ²
FCC §15.207 ISEDC RSS-Gen §8.8	AC Line Conducted Emissions	N/A ¹
FCC §15.209, §15.247(d) ISEDC RSS-247 §5.5 RSS-Gen §8.9, §8.10	Radiated Spurious Emissions	Compliant
FCC §15.247(a)(2) ISEDC RSS-247 §5.2 RSS-Gen §6.7	6 dB & 99% Emission Bandwidth	Compliant
FCC §15.247(b)(3) ISEDC RSS-247 §5.4	Maximum Output Power	Compliant
FCC §15.247(e) ISEDC RSS-247 §5.2(2)	Peak Power Spectral Density	Compliant
FCC §15.247(d) ISEDC RSS-247 §5.5	100 kHz Bandwidth of Frequency Band Edge	Compliant
FCC §2.1051, §15.247 (d) ISEDC RSS-247 §5.5	Spurious Emissions at Antenna Port	Compliant

Note¹: Device is DC powered by car battery.

Note²: Please refer to Test Report R2109222-03 for FCC RF Exposure Evaluation, Test Report R2109222-04 for IC RF Exposure Evaluation.

4 FCC §15.203 & ISEDC RSS-Gen §6.8 - Antenna Requirements

4.1 Applicable Standards

According to FCC §15.203:

An intentional radiator shall be designed to ensure that no antenna other than that furnished by the responsible party shall be used with the device. The use of a permanently attached antenna or of an antenna that uses a unique coupling to the intentional radiator shall be considered sufficient to comply with the provisions of this Section. The manufacturer may design the unit so that a broken antenna can be replaced by the user, but the use of a standard antenna jack or electrical connector is prohibited.

And according to FCC §15.247 (b) (4), if transmitting antennas of directional gain greater than 6 dBi are used the power shall be reduced by the amount in dB that the directional gain of the antenna exceeds 6 dBi.

According to ISEDC RSS-Gen §6.8: Transmitter Antenna

The applicant for equipment certification shall provide a list of all antenna types that may be used with the transmitter, where applicable (i.e. for transmitters with detachable antenna), indicating the maximum permissible antenna gain (in dBi) and the required impedance for each antenna. The test report shall demonstrate the compliance of the transmitter with the limit for maximum equivalent isotropically radiated power (e.i.r.p.) specified in the applicable RSS, when the transmitter is equipped with any antenna type, selected from this list.

For expediting the testing, measurements may be performed using only the antenna with highest gain of each combination of transmitter and antenna type, with the transmitter output power set at the maximum level. However, the transmitter shall comply with the applicable requirements under all operational conditions and when in combination with any type of antenna from the list provided in the test report (and in the notice to be included in the user manual, provided below).

When measurements at the antenna port are used to determine the RF output power, the effective gain of the device's antenna shall be stated, based on a measurement or on data from the antenna's manufacturer.

The test report shall state the RF power, output power setting and spurious emission measurements with each antenna type that is used with the transmitter being tested.

For license-exempt equipment with detachable antennas, the user manual shall also contain the following notice in a conspicuous location:

This radio transmitter has been approved by Innovation, Science and Economic Development Canada to operate with the antenna types listed below, with the maximum permissible gain indicated. Antenna types not included in this list that have a gain greater than the maximum gain indicated for any type listed are strictly prohibited for use with this device.

Immediately following the above notice, the manufacturer shall provide a list of all antenna types which can be used with the transmitter, indicating the maximum permissible antenna gain (in dBi) and the required impedance for each antenna type.

4.2 Antenna Description

External/Internal/ Integral	Frequency Range (MHz)	Antenna Type	Maximum Antenna Gain (dBi)
Integral	2400-2483.5 MHz	PCB	3.6

Antenna gain is information provided by customer.

5 FCC §15.209, §15.247(d) & ISEDC RSS-247 §5.5, RSS-Gen §8.9, §8.10 - Spurious Radiated Emissions

5.1 Applicable Standards

As per FCC §15.35(d): Unless otherwise specified, on any frequency or frequencies above 1000 MHz, the radiated emission limits are based on the use of measurement instrumentation employing an average detector function. Unless otherwise specified, measurements above 1000 MHz shall be performed using a minimum resolution bandwidth of 1 MHz.

As Per FCC §15.205(a) and RSS-Gen except as show in paragraph (d) of this section, only spurious emissions are permitted in any of the frequency bands listed below:

MHz	MHz	MHz	GHz
0.090 – 0.110	16.42 – 16.423	960 – 1240	4.5 – 5.15
0.495 – 0.505	16.69475 – 16.69525	1300 – 1427	5.35 – 5.46
2.1735 – 2.1905	25.5 – 25.67	1435 – 1626.5	7.25 – 7.75
4.125 – 4.128	37.5 – 38.25	1645.5 – 1646.5	8.025 – 8.5
4.17725 – 4.17775	73 – 74.6	1660 – 1710	9.0 – 9.2
4.20725 – 4.20775	74.8 – 75.2	1718.8 – 1722.2	9.3 – 9.5
6.215 – 6.218	108 – 121.94	2200 – 2300	10.6 – 12.7
6.26775 – 6.26825	123 – 138	2310 – 2390	13.25 – 13.4
6.31175 – 6.31225	149.9 – 150.05	2483.5 – 2500	14.47 – 14.5
8.291 – 8.294	156.52475 – 156.52525	2690 – 2900	15.35 – 16.2
8.362 – 8.366	156.7 – 156.9	3260 – 3267	17.7 – 21.4
8.37625 – 8.38675	162.0125 – 167.17	3332 – 3339	22.01 – 23.12
8.41425 – 8.41475	167.72 – 173.2	3345.8 – 3358	23.6 – 24.0
12.29 – 12.293	240 – 285	3600 – 4.400	31.2 – 31.8
12.51975 – 12.52025	322 – 335.4		36.43 – 36.5
12.57675 – 12.57725	399.9 – 410		Above 38.6
13.36 – 13.41	608 – 614		

As per FCC §15.209(a): Except as provided elsewhere in this Subpart, the emissions from an intentional radiator shall not exceed the field strength levels specified in the following table:

Frequency (MHz)	Field Strength (micro volts/meter)	Measurement Distance (meters)
0.009 - 0.490	2400/F(kHz)	300
0.490 - 1.705	24000/F(kHz)	30
1.705 - 30.0	30	30
30 - 88	100**	3
88 - 216	150**	3
216 - 960	200**	3
Above 960	500	3

** Except as provided in paragraph (g), fundamental emissions from intentional radiators operating under this Section shall not be located in the frequency bands 54-72 MHz, 76-88 MHz, 174-216 MHz or 470-806 MHz. However, operation within these frequency bands is permitted under other sections of this Part, e.g., Sections 15.231 and 15.241.

As per FCC §15.247 (d) In any 100 kHz bandwidth outside the frequency band in which the spread spectrum or digitally modulated intentional radiator is operating, the radio frequency power that is produced by the intentional radiator shall be at least 20 dB below that in the 100 kHz bandwidth within the band that contains the highest level of the desired power, based on either an RF conducted or a radiated measurement, provided the transmitter demonstrates compliance with the peak conducted power limits. If the transmitter complies with the conducted power limits based on the use of RMS averaging over a time interval, as permitted under paragraph (b)(3) of this section, the attenuation required under this paragraph shall be 30 dB instead of 20 dB. Attenuation below the general limits specified in §15.209(a) is not required. In addition, radiated emissions which fall in the restricted bands, as defined in §15.205(a), must also comply with the radiated emission limits specified in §15.209(a) (see §15.205(c)).

As per ISEDC RSS-Gen 8.9,

Except when the requirements applicable to a given device state otherwise, emission from licence-exempt transmitters shall comply with the field strength limits shown in the table below. Additionally, the level of any transmitter emission shall not exceed the level of the transmitter's fundamental emission.

General Field Strength Limits for Licence-Exemption Transmitters at Frequencies above 30 MHz

Frequency (MHz)	Field Strength ($\mu\text{V}/\text{m}$ at 3 meters)
30-88	100
88-216	150
216-960	200
Above 960*	500

* Unless otherwise specified, for all frequencies greater than 1 GHz, the radiated emission limits for licence-exempt radio apparatus stated in applicable RSSs (including RSS-Gen) are based on measurements using a linear average detector function having a minimum resolution bandwidth of 1 MHz. If an average limit is specified for the EUT, then the peak emission shall also be measured with instrumentation properly adjusted for such factors as pulse desensitization to ensure the peak emission is less than 20 dB above the average limit.

Note: Transmitting devices are not permitted in restricted frequency bands unless stated otherwise in the specific RSS.

As per ISEDC RSS-247 §5.5, in any 100 kHz bandwidth outside the frequency band in which the spread spectrum or digitally modulated device is operating, the RF power that is produced shall be at least 20 dB below that in the 100 kHz bandwidth within the band that contains the highest level of the desired power, based on either an RF conducted or a radiated measurement, provided that the transmitter demonstrates compliance with the peak conducted power limits. If the transmitter complies with the conducted power limits based on the use of root-mean-square averaging over a time interval, as permitted under Section 5.4(4), the attenuation required shall be 30 dB instead of 20 dB. Attenuation below the general field strength limits specified in RSS-Gen is not required.

5.2 Test Setup

The radiated emissions tests were performed in the 5-meter Chamber, using the setup in accordance with ANSI C63.10-2013. The specification used was the FCC 15 Subpart C and ISEDC RSS-247 limits.

The spacing between the peripherals was 10 centimeters.

External I/O cables were draped along the edge of the test table and bundle when necessary.

5.3 Test Setup Block Diagrams

Below 1 GHz:

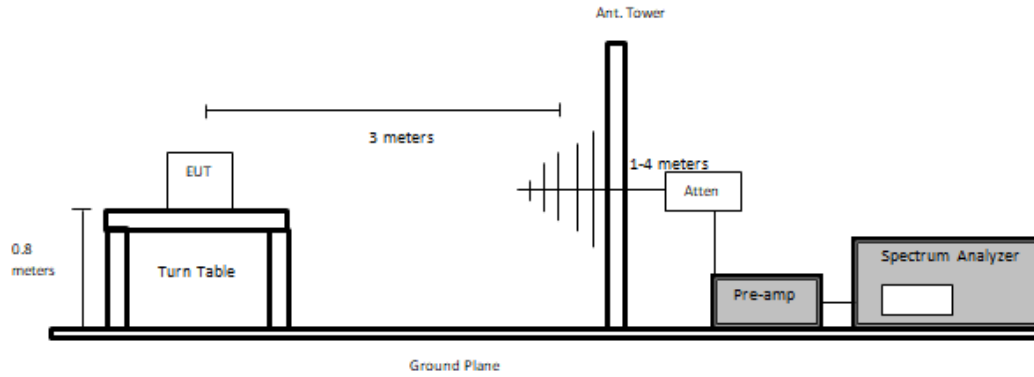

Above 1 GHz:

At 3 meters:

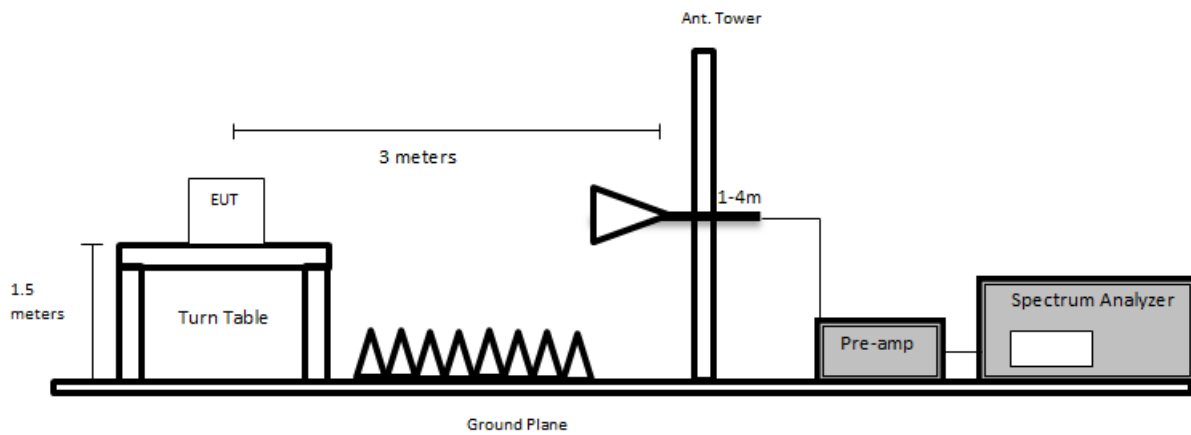

At 1 meter:
Using Asset#1192

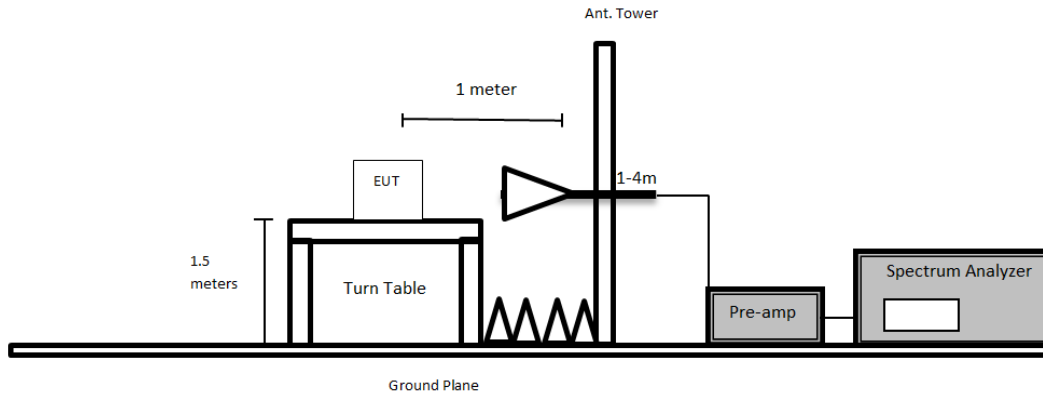

Using Asset#91

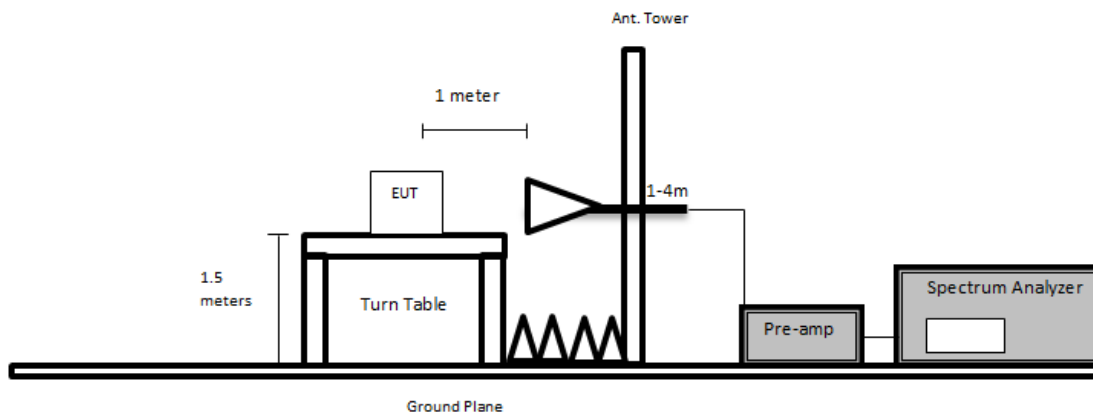

5.4 Test Procedure

For the radiated emissions test, the EUT host, and all support equipment power cords was connected to the AC floor outlet.

Maximizing procedure was performed on the highest emissions to ensure that the EUT complied with all installation combinations.

The EUT was set 3 meter away from the testing antenna, which was varied from 1-4 meter, and the EUT was placed on a turntable, which was 0.8 meter and 1.5 meter above the ground plane for below and above 1000 MHz measurements, the table shall be rotated for 360 degrees to find out the highest emission. The receiving antenna should be changed the polarization both of horizontal and vertical.

The spectrum analyzer or receiver is set as:

Below 1000 MHz:

RBW = 100 kHz / VBW = 300 kHz / Sweep = Auto

Above 1000 MHz:

- (1) Peak: RBW = 1MHz / VBW = 1MHz / Sweep = Auto
- (2) Average: RBW = 1MHz / VBW = 10Hz / Sweep = Auto

5.5 Corrected Amplitude & Margin Calculation

For emissions below 1 GHz,

The Corrected Amplitude (CA) is calculated by adding the Correction Factor to the S.A. Reading. The basic equation is as follows:

$$CA = \text{S.A. Reading} + \text{Correction Factor}$$

For example, a corrected amplitude of 40.3 dBuV/m = S.A. Reading (32.5 dBuV) + Correction Factor (7.8 dB/m)

The Correction Factor is calculated by adding the Antenna Factor (AF), the Cable Loss (CL), the Attenuator Factor (Atten) and subtracting the Amplifier Gain (Ga) together. This calculation is done in the measurement software, and reported in the test result section. The basic equation is as follows:

$$\text{Correction Factor} = AF + CL + \text{Atten} - Ga$$

The “**Margin**” column of the following data tables indicates the degree of compliance within the applicable limit. For example, a margin of -7 dB means the emission is 7 dB below the maximum limit. The equation for margin calculation is as follows:

$$\text{Margin} = \text{Corrected Amplitude} - \text{Limit}$$

For emission above 1 GHz,

The Corrected Amplitude (CA) is calculated by adding the Antenna Factor (AF), the Cable Loss (CL), the Attenuator Factor (Atten) and subtracting the Amplifier Gain (Ga) to indicated Amplitude (Ai) reading. The basic equation is as follows:

$$CA = Ai + AF + CL + \text{Atten} - Ga$$

For example, a corrected amplitude of 40.3 dBuV/m = Indicated Reading (32.5 dBuV) + Antenna Factor (+23.5dB) + Cable Loss (3.7 dB) + Attenuator (10 dB) - Amplifier Gain (29.4 dB)

The “**Margin**” column of the following data tables indicates the degree of compliance within the applicable limit. For example, a margin of -7 dB means the emission is 7 dB below the maximum limit. The equation for margin calculation is as follows:

$$\text{Margin} = \text{Corrected Amplitude} - \text{Limit}$$

5.6 Test Equipment List and Details

BACL No	Manufacturer	Description	Model	Serial Number	Calibration Date	Calibration Interval
287	HP	Spectrum Analyzer	E4446A	US44300386	2022-05-05	1 year
310	Rohde & Schwarz	Receiver, EMI Test	ESCI 1166.5950.03	100338	2021-11-18	1 year
-	Sunol Science Corp	System Controller	SC99V	011003-1	N/R	N/A
321	Sunol Sciences	Biconilog Antenna	JB3	A020106-2	2021-11-22	2 years
91	Wisewave	Antenna, Horn	ARH-4223-02	10555-02	2022-03-08	2 years
827	AH Systems	Preamplifier	PAM 1840 VH	170	2021-08-03	1 year
1077	Insulated Wire Corp	157 Series 2.92 SM (x2) Armored 33 ft. Cable	KPS-1571AN-3960-KPS	DC 1917	2022-03-03	1 year
1228	Pasternack	Coaxial Cable, RG213	PE3496-800CM	2111301	2021-11-30	1 year
459	HP	Amplifier, Pre	8447D	2443A04374	2021-11-02	1 year
658	Agilent	Pre-Amplifier	8449B	3008A0113	2022-05-05	1 year
1192	ETS Lindgren	Antenna, Horn	3117	00218973	2021-09-14	2 years
-	-	Notch filter	-	-	Each time ¹	N/A
-	-	SMA cable	-	-	Each time ¹	N/A

Note¹: equipment included in the test set-up will be checked each time before testing.

Statement of Traceability: *BACL Corp.* attests that all of the calibrations on the equipment items listed above were traceable to NIST or to another internationally recognized National Metrology Institute (NMI), and were compliant with the latest version of A2LA policy P102 "A2LA Policy on Metrological Traceability".

5.7 Test Environmental Conditions

Temperature:	19 °C
Relative Humidity:	34 %
ATM Pressure:	102.2 kPa

The testing was performed by Deepak Mishra from 2022-06-21 to 2022-07-22 at 5 meter chamber 3.

5.8 Summary of Test Results

According to the data hereinafter, the EUT complied with FCC Part 15C and ISEDC RSS-247 standard's radiated emissions limits, and had the worst margin of:

Mode: Transmitting			
Margin (dB)	Frequency (MHz)	Polarization (Horizontal/Vertical)	Transmitting Channel (MHz)
-6.32	26149.37	H	2402

Please refer to the following table and plots for specific test result details.

5.9 Radiated Emissions Test Results

- 1) 30 MHz – 1 GHz Worst Case, Measured at 3 meters
BLE, 2402MHz

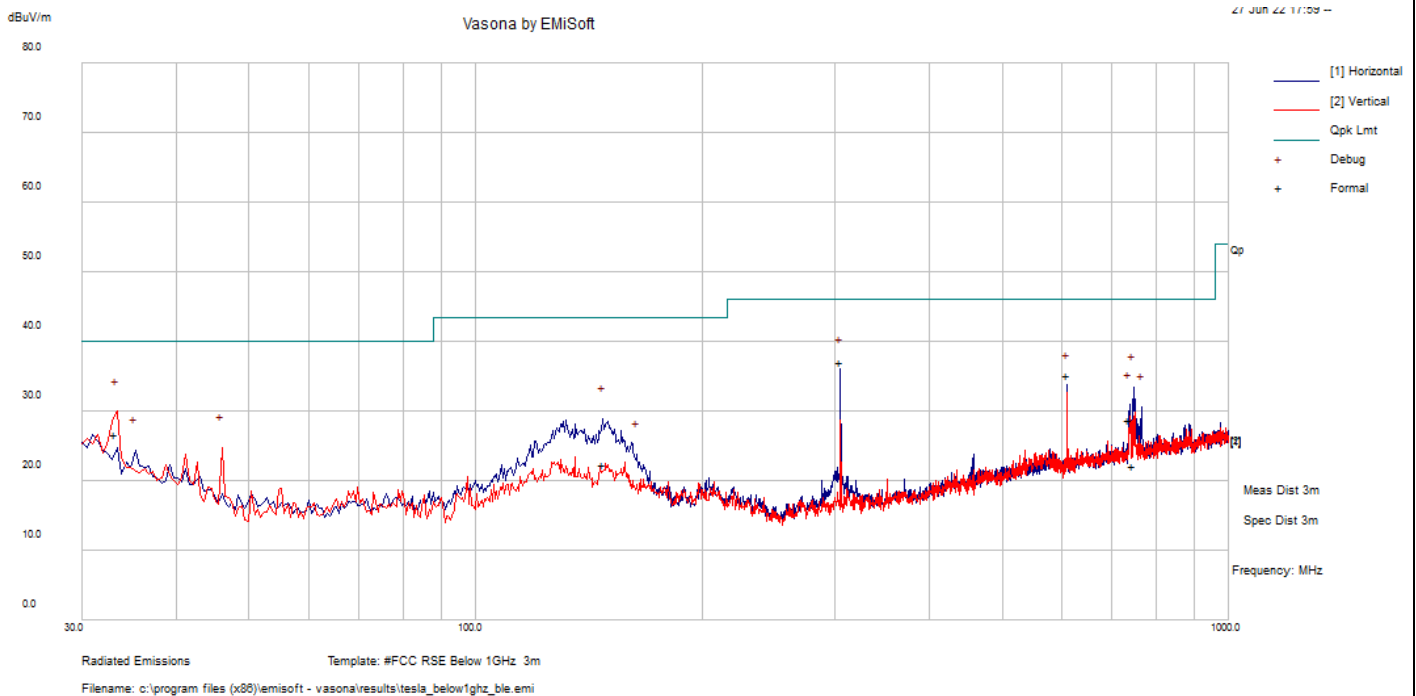

Frequency (MHz)	S.A. Reading (dBuV)	Correction Factor (dB/m)	Corrected Amplitude (dBuV/m)	Antenna Height (cm)	Antenna Polarity (H/V)	Turntable Azimuth (degrees)	Limit (dBuV/m)	Margin (dB)	Comment
304.98725	42.12	-5.15	36.97	100	H	245	46	-9.03	Pass
33.2355	27.13	-0.54	26.59	117	V	121	40	-13.41	Pass
610.036	34.61	0.61	35.22	110	H	233	46	-10.78	Pass
746.645	19.33	2.73	22.06	180	H	7	46	-23.94	Pass
147.441	28.74	-6.34	22.4	219	H	220	43.5	-21.1	Pass
737.9	26.17	2.59	28.76	295	H	316	46	-17.24	Pass

2) 1–26.5 GHz, Measured at 3 Meters

Frequency (MHz)	S.A. Reading (dBµV)	Turntable Azimuth (degrees)	Test Antenna			Cable Loss (dB)	Pre-Amp. (dB)	Cord. Reading (dBµV/m)	FCC/ISED		Note
			Height (cm)	Polarity (H/V)	Factor (dB/m)				Limit (dBµV/m)	Margin (dB)	
Low Channel Frequency: 2402 MHz											
2390	48.610	179	272	H	32.228	6.011	34.360	52.489	74	-21.511	Peak
2390	48.360	331	109	V	32.228	6.011	34.360	52.239	74	-21.761	Peak
2390	36.774	179	272	H	32.228	6.011	34.360	40.653	54	-13.347	Ave
2390	37.103	331	109	V	32.228	6.011	34.360	40.982	54	-13.018	Ave
4804	46.000	45	289	H	34.709	8.542	33.810	55.441	74	-18.559	Peak
4804	45.410	136	120	V	34.709	8.542	33.810	54.851	74	-19.149	Peak
4804	34.877	45	289	H	34.709	8.542	33.810	44.318	54	-9.682	Ave
4804	34.403	136	120	V	34.709	8.542	33.810	43.844	54	-10.156	Ave
Middle Channel Frequency: 2440 MHz											
4880	45.500	316	251	H	34.709	8.562	33.590	55.181	74	-18.819	Peak
4880	44.680	65	113	V	34.709	8.562	33.590	54.361	74	-19.639	Peak
4880	32.805	316	251	H	34.709	8.562	33.590	42.486	54	-11.514	Ave
4880	32.868	65	113	V	34.709	8.562	33.590	42.549	54	-11.451	Ave
High Channel Frequency: 2480 MHz											
2483.5	48.750	259	280	H	32.665	6.099	34.760	52.754	74	-21.246	Peak
2483.5	47.380	297	204	V	32.665	6.099	34.760	51.384	74	-22.616	Peak
2483.5	36.902	259	280	H	32.665	6.099	34.760	40.906	54	-13.094	Ave
2483.5	37.099	297	204	V	32.665	6.099	34.760	41.103	54	-12.897	Ave
4960	45.240	280	119	H	34.709	8.720	33.500	55.169	74	-18.831	Peak
4960	45.230	142	102	V	34.709	8.720	33.500	55.159	74	-18.841	Peak
4960	33.779	280	119	H	34.709	8.720	33.500	43.708	54	-10.292	Ave
4960	33.705	142	102	V	34.709	8.720	33.500	43.634	54	-10.366	Peak

3) 1 – 18 GHz Worst Case scan, Measured at 1 meter
BLE, 2402MHz

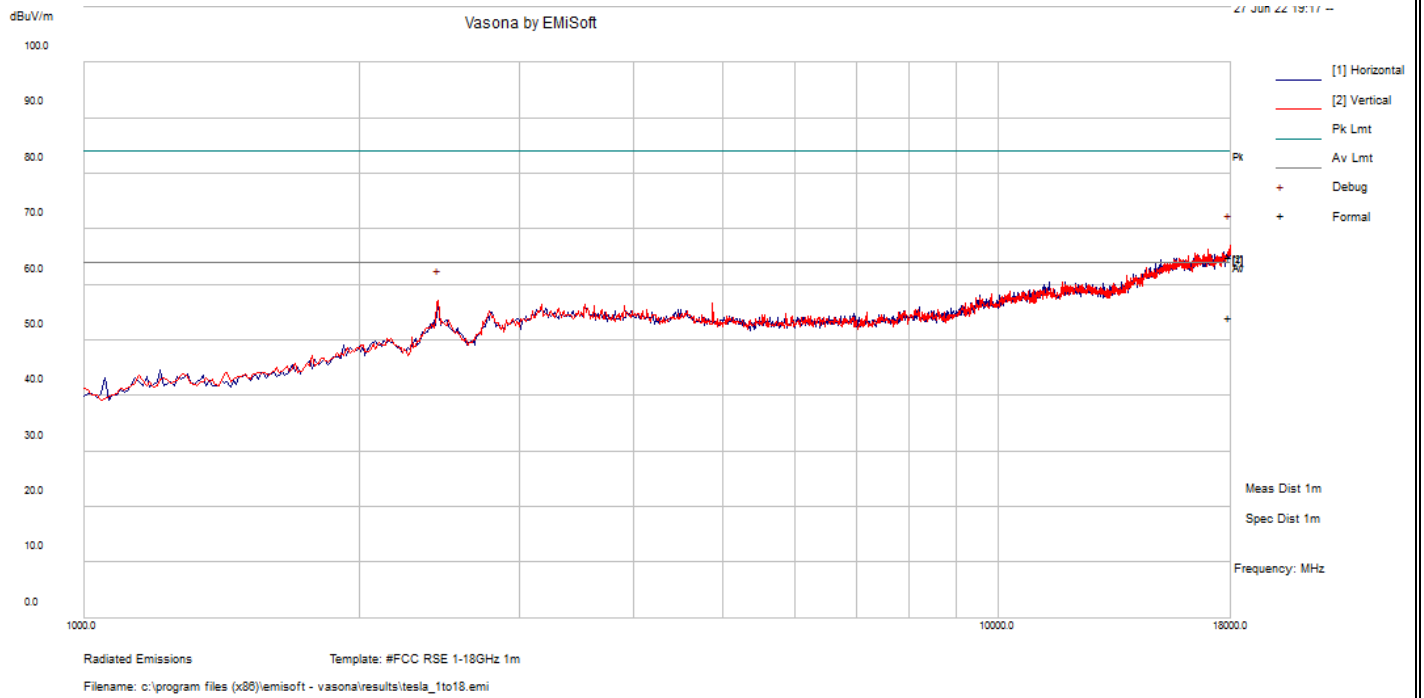

Frequency (MHz)	S.A. Reading (dBuV)	Correction Factor (dB/m)	Corrected Amplitude (dBµV/m)	Antenna Height (cm)	Antenna Polarity (H/V)	Turntable Azimuth (degrees)	Limit (dBµV/m)	Margin (dB)	Comment
17945.485	45.87	19.17	65.04	234	V	68	84	-18.96	Peak
17945.485	34.86	19.18	54.04	234	V	68	64	-9.96	Ave

4) 18 – 26.5 GHz Worst Case scan, Measured at 1 meter
BLE, 2402MHz

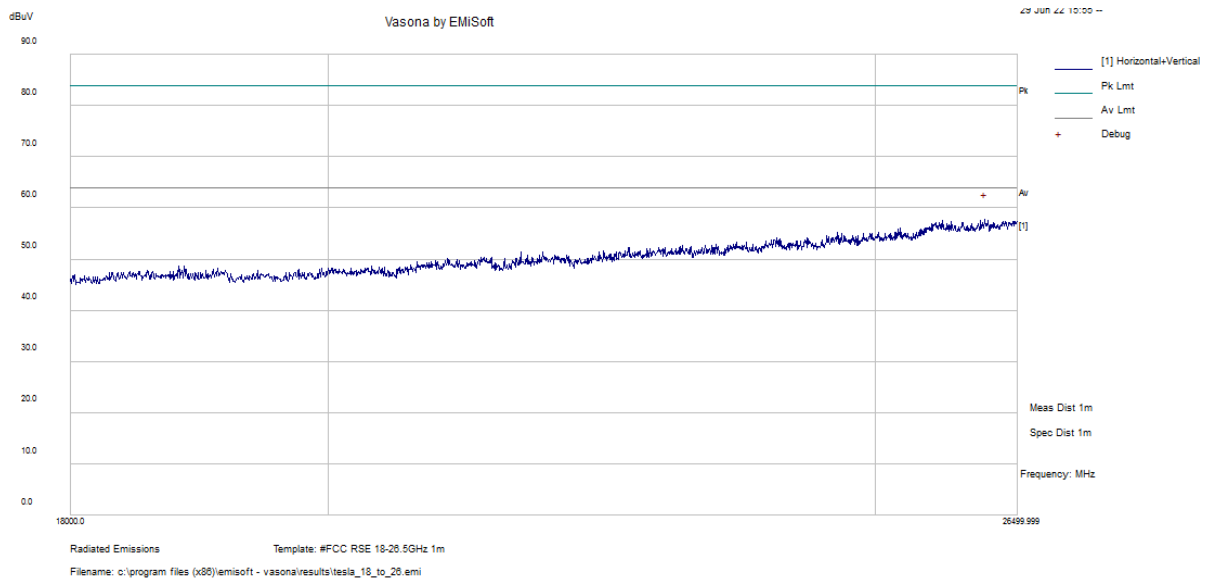

Frequency (MHz)	S.A. Reading (dBuV)	Correction Factor (dB/m)	Corrected Amplitude (dBµV/m)	Antenna Height (cm)	Antenna Polarity (H/V)	Turntable Azimuth (degrees)	Limit (dBµV/m)	Margin (dB)	Comment
26149.37	35.24	22.44	57.68	0	V	300	64	-6.32	Peak

Note: Worst case Peak emission was measured to be lower than average limit to show compliance.

6 FCC §15.247(a) (2) & ISEDC RSS-247 §5.2, RSS-Gen §6.7 - Emission Bandwidth

6.1 Applicable Standards

According to FCC §15.247(a) (2) and ISEDC RSS-247 §5.2: the minimum 6 dB bandwidth shall be 500 kHz.

6.2 Measurement Procedure

The measurements are based on FCC KDB 558074 D01 DTS Meas Guidance v05r02: Guidance for Performing Compliance Measurements on Digital Transmission Systems (DTS) Operating Under §15.247 section 8: DTS bandwidth.

6.3 Test Setup Diagram

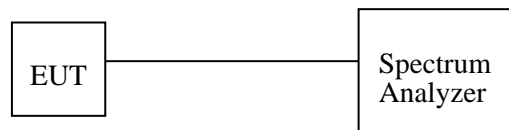

6.4 Test Equipment List and Details

BACL No.	Manufacturer	Description	Model No.	Serial No.	Calibration Date	Calibration Interval
287	Agilent	Spectrum Analyzer	E4446A	US44300386	2022-05-05-	1 year
-	-	RF cable	-	-	Each time ¹	N/A
-	-	10 dB Attenuator	-	-	Each time	N/A

Note¹: equipment included in the test set-up will be checked each time before testing.

Statement of Traceability: *BACL Corp. attests that all of the calibrations on the equipment items listed above were traceable to NIST or to another internationally recognized National Metrology Institute (NMI), and were compliant with the latest version of A2LA policy P102 "A2LA Policy on Metrological Traceability".*

6.5 Test Environmental Conditions

Temperature:	21° C
Relative Humidity:	39 %
ATM Pressure:	102.0 kPa

The testing was performed by Marc Jean on 2022-06-30 at RF test site.

6.6 Test Results

Channel	Frequency (MHz)	99% OBW (MHz)	6 dB OBW (kHz)	6 dB OBW Limit (kHz)
Low	2402	1.052	711.973	> 500
Middle	2440	1.057	671.680	> 500
High	2480	1.071	715.503	> 500

Please refer to the following plots for detailed test results.

99% OBW, Low Channel: 2402 MHz

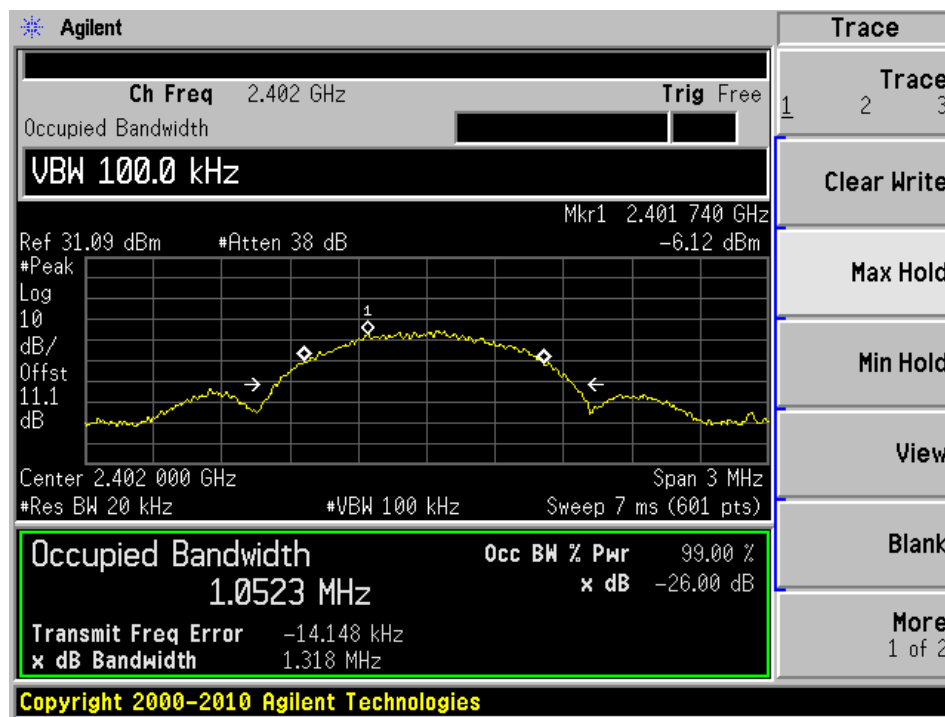

6dB OBW, Low Channel: 2402 MHz

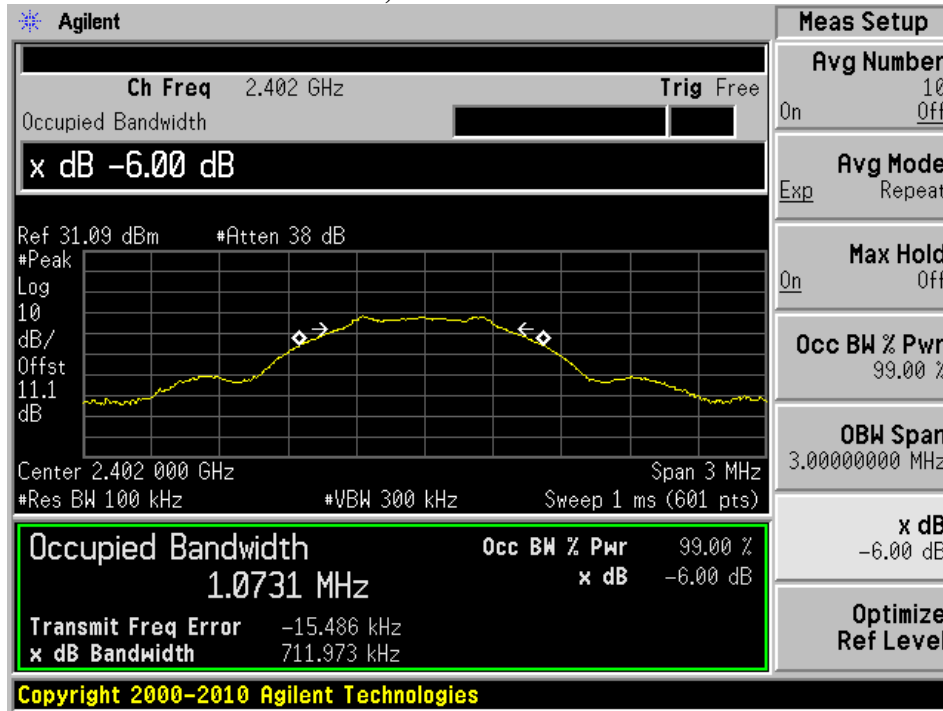

99% OBW, Middle Channel: 2440 MHz

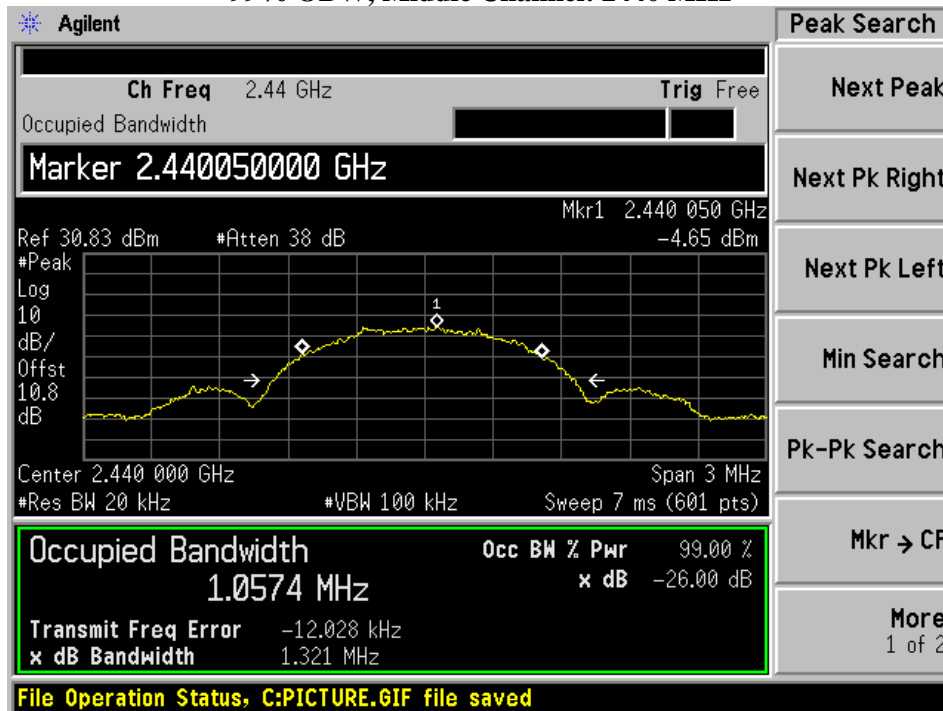

6dB OBW, Middle Channel: 2440 MHz

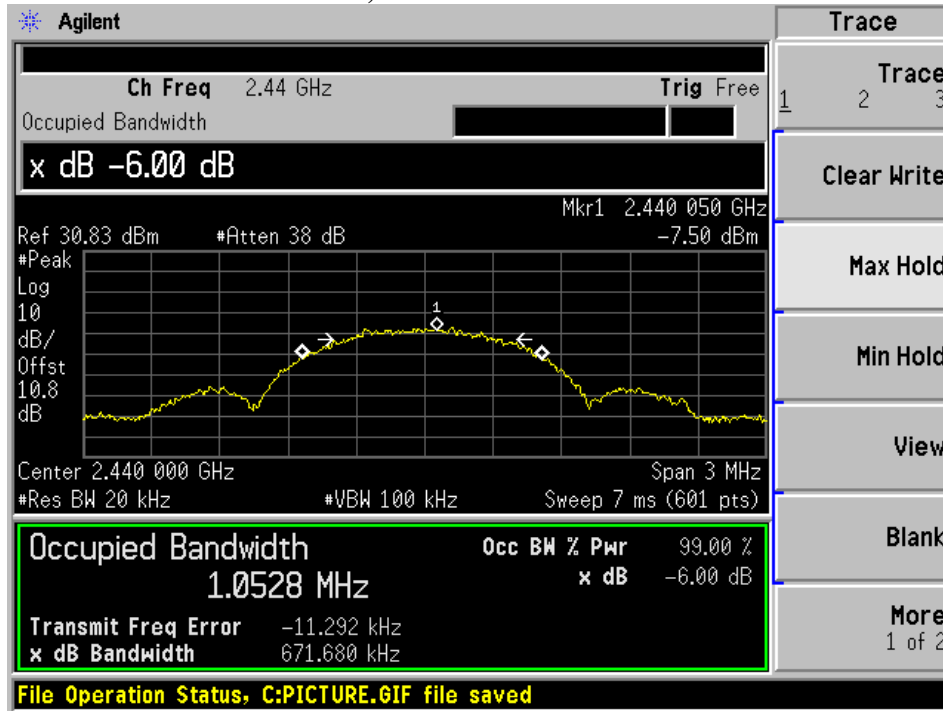

99% OBW, High Channel: 2480 MHz

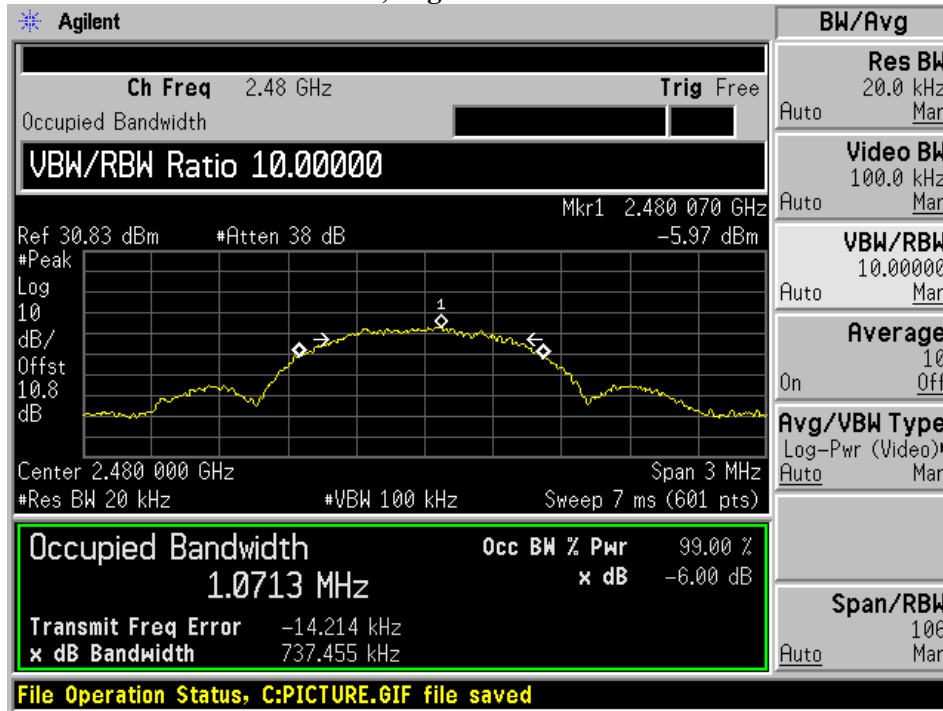

6 dB OBW, High Channel: 2480 MHz

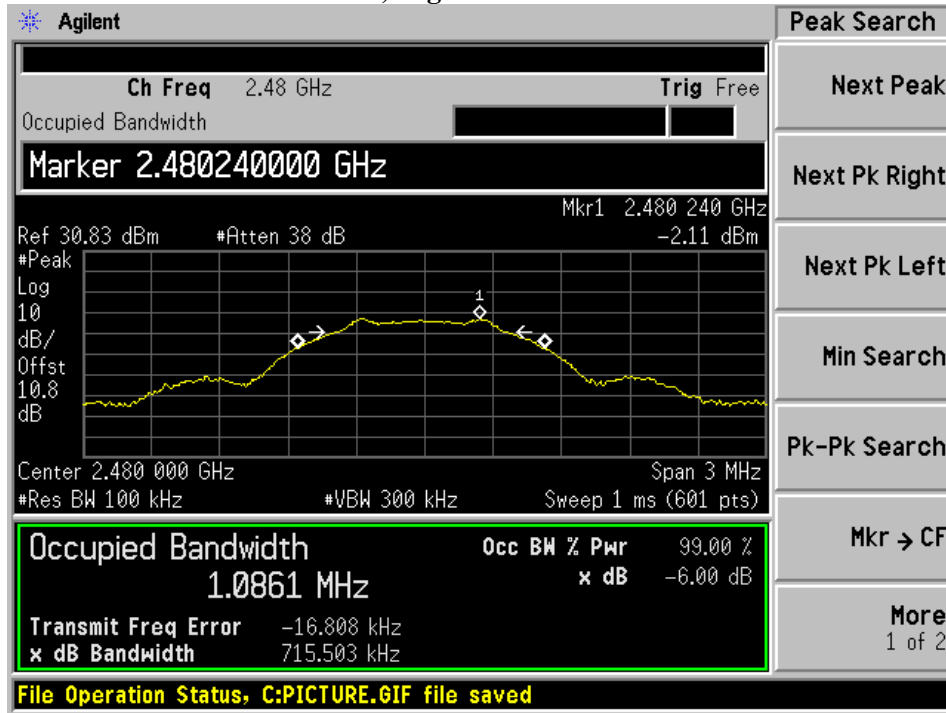

7 FCC §15.247(b) (3) & ISEDC RSS-247 §5.4 - Maximum Output Power

7.1 Applicable Standards

According to FCC §15.247(b) (3): For systems using digital modulation in the 902-928 MHz, 2400-2483.5 MHz, and 5725-5850 MHz bands: 1 Watt. As an alternative to a peak power measurement, compliance with the one Watt limit can be based on a measurement of the maximum conducted output power. Maximum Conducted Output Power is defined as the total transmit power delivered to all antennas and antenna elements averaged across all symbols in the signaling alphabet when the transmitter is operating at its maximum power control level. Power must be summed across all antennas and antenna elements. The average must not include any time intervals during which the transmitter is off or is transmitting at a reduced power level. If multiple modes of operation are possible (e.g., alternative modulation methods), the maximum conducted output power is the highest total transmit power occurring in any mode.

According to RSS-247 §5.4: For DTSs employing digital modulation techniques operating in the bands 902-928 MHz and 2400-2483.5 MHz, the maximum peak conducted output power shall not exceed 1 W. The e.i.r.p. shall not exceed 4 W, except as provided in section 5.4(e).

7.2 Measurement Procedure

The measurements are based on ANSI C63.10-2013, Section 11.9.2.2.2.

7.3 Test Setup Diagram

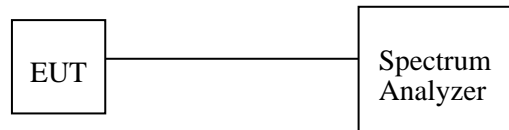

7.4 Test Equipment List and Details

BACL No.	Manufacturer	Description	Model No.	Serial No.	Calibration Date	Calibration Interval
287	Agilent	Spectrum Analyzer	E4446A	US44300386	2022-05-05-	1 year
-	-	RF cable	-	-	Each time ¹	N/A
-	-	10 dB Attenuator	-	-	Each time	N/A

Note¹: equipment included in the test set-up will be checked each time before testing.

Statement of Traceability: *BACL Corp.* attests that all of the calibrations on the equipment items listed above were traceable to NIST or to another internationally recognized National Metrology Institute (NMI), and were compliant with the latest version of A2LA policy P102 "A2LA Policy on Metrological Traceability".

7.5 Test Environmental Conditions

Temperature:	21° C
Relative Humidity:	39 %
ATM Pressure:	102.0 kPa

The testing was performed by Marc Jean on 2022-07-22 at RF test site.

7.6 Test Results

Channel	Frequency (MHz)	Conducted Output Power (dBm)	FCC/ISED Limit (dBm)
Low	2402	4.89	< 30
Middle	2440	4.52	< 30
High	2480	4.60	< 30

Low Channel: 2402 MHz

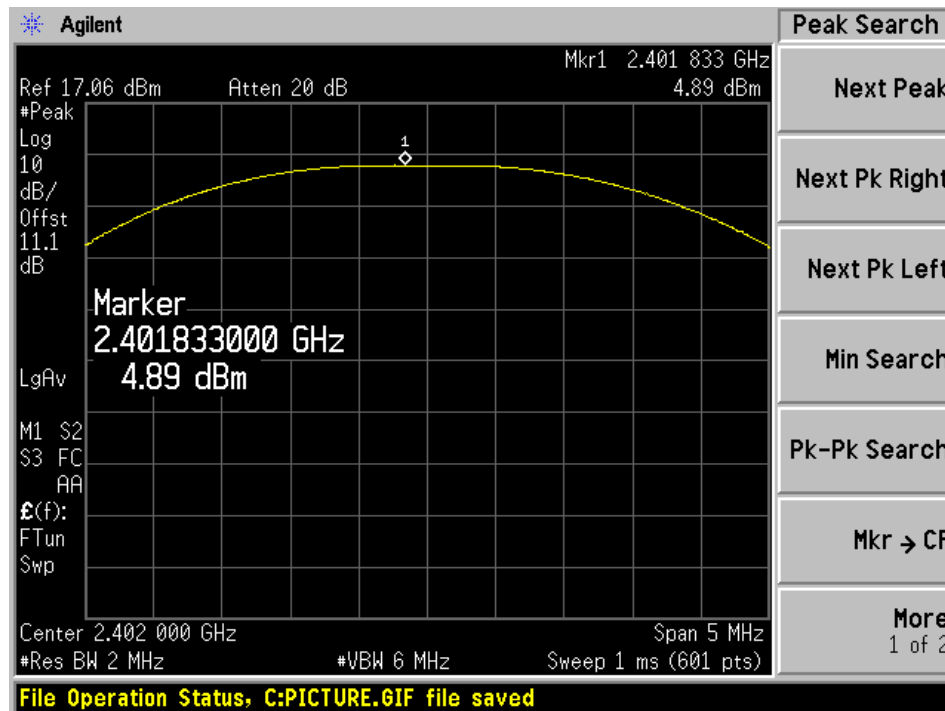

Middle Channel: 2440 MHz

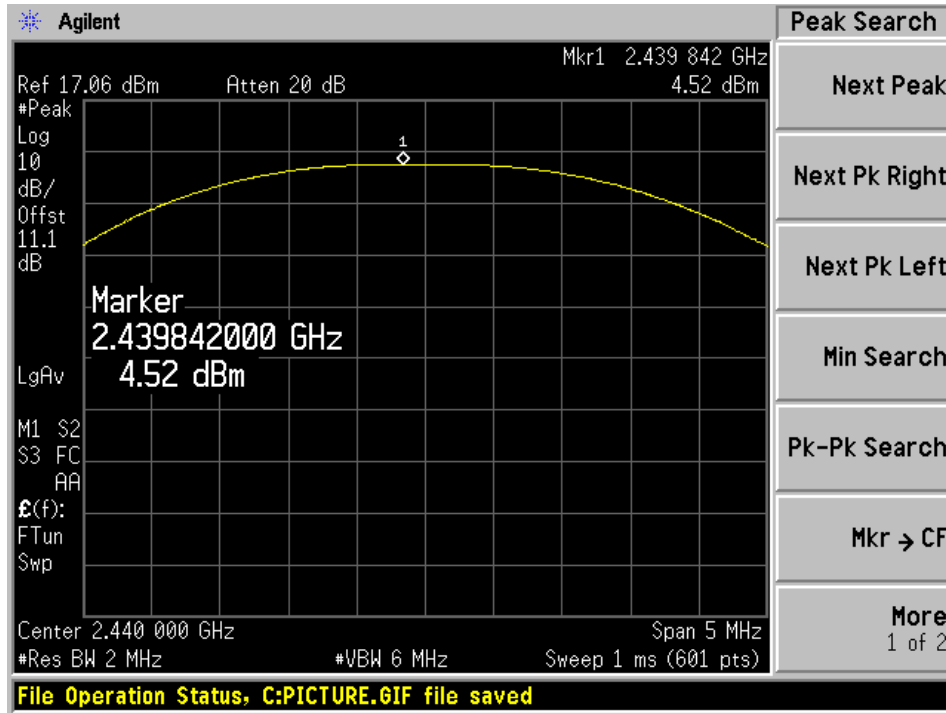

High Channel: 2480 MHz

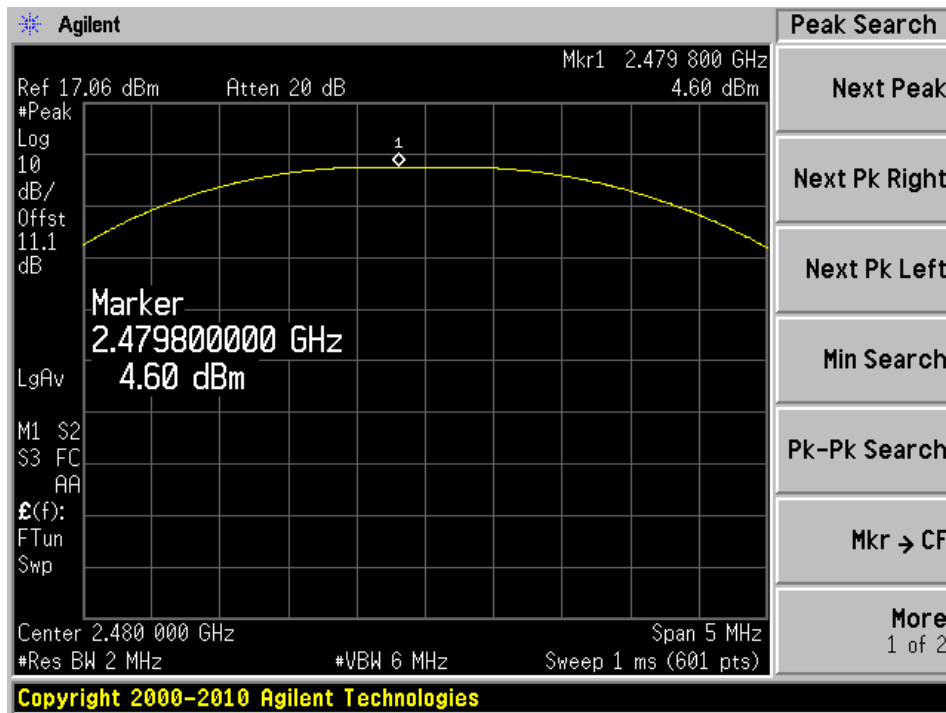

8 FCC §15.247(e) & ISEDC RSS-247 §5.2(2) - Peak Power Spectral Density

8.1 Applicable Standards

According to ECFR §15.247(e) and RSS-247 §5.2 (2) , for digitally modulated systems, the power spectral density conducted from the intentional radiator to the antenna shall not be greater than 8 dBm in any 3 kHz band during any time interval of continuous transmission.

8.2 Measurement Procedure

The measurements are based on FCC KDB 558074 D01 DTS Meas Guidance v05r02: Guidance for Performing Compliance Measurements on Digital Transmission Systems (DTS) Operating Under §15.247 section 10: Maximum power spectral density level in the fundamental emission.

8.3 Test Setup Diagram

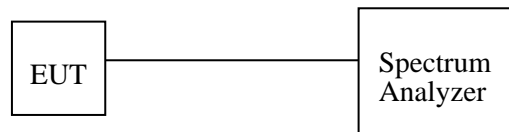

8.4 Test Equipment List and Details

BACL No.	Manufacturer	Description	Model No.	Serial No.	Calibration Date	Calibration Interval
287	Agilent	Spectrum Analyzer	E4446A	US44300386	2022-05-05-	1 year
-	-	RF cable	-	-	Each time ¹	N/A
-	-	10 dB Attenuator	-	-	Each time	N/A

Note¹: equipment included in the test set-up will be checked each time before testing.

Statement of Traceability: *BACL Corp. attests that all of the calibrations on the equipment items listed above were traceable to NIST or to another internationally recognized National Metrology Institute (NMI), and were compliant with the latest version of A2LA policy P102 "A2LA Policy on Metrological Traceability".*

8.5 Test Environmental Conditions

Temperature:	23° C
Relative Humidity:	42 %
ATM Pressure:	102.7 kPa

The testing was performed by Marc Jean on 2022-07-22 at RF test site.

8.6 Test Results

Channel	Frequency (MHz)	Conducted PSD (dBm/3 kHz)	FCC/ISED Limit (dBm/3 kHz)
Low	2402	-4.60	< 8
Middle	2440	-7.54	< 8
High	2480	-6.27	< 8

Low Channel: 2402 MHz

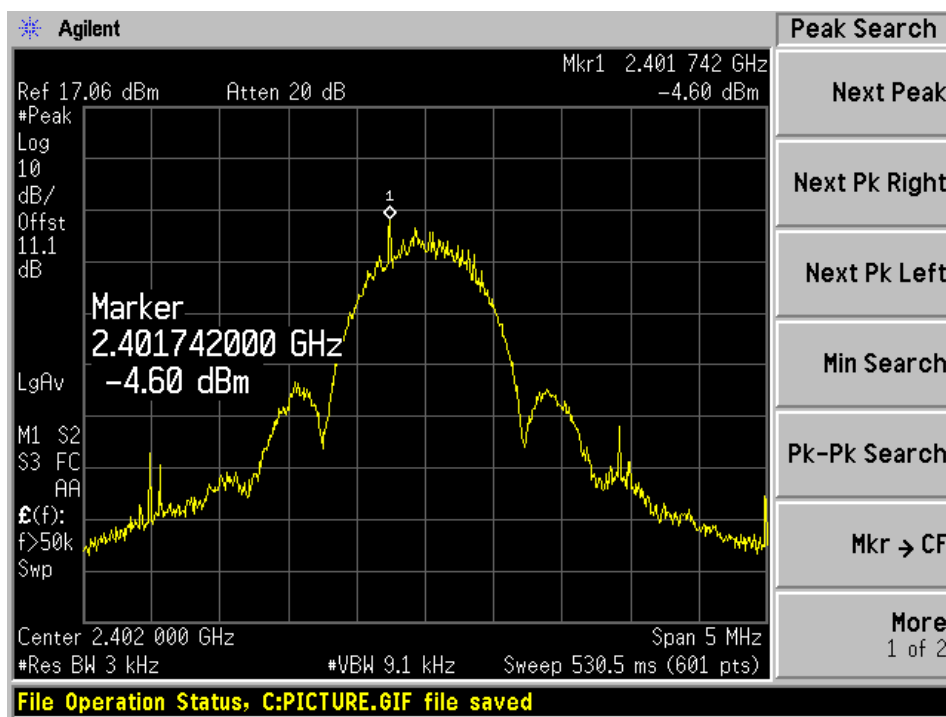

Middle Channel: 2440 MHz

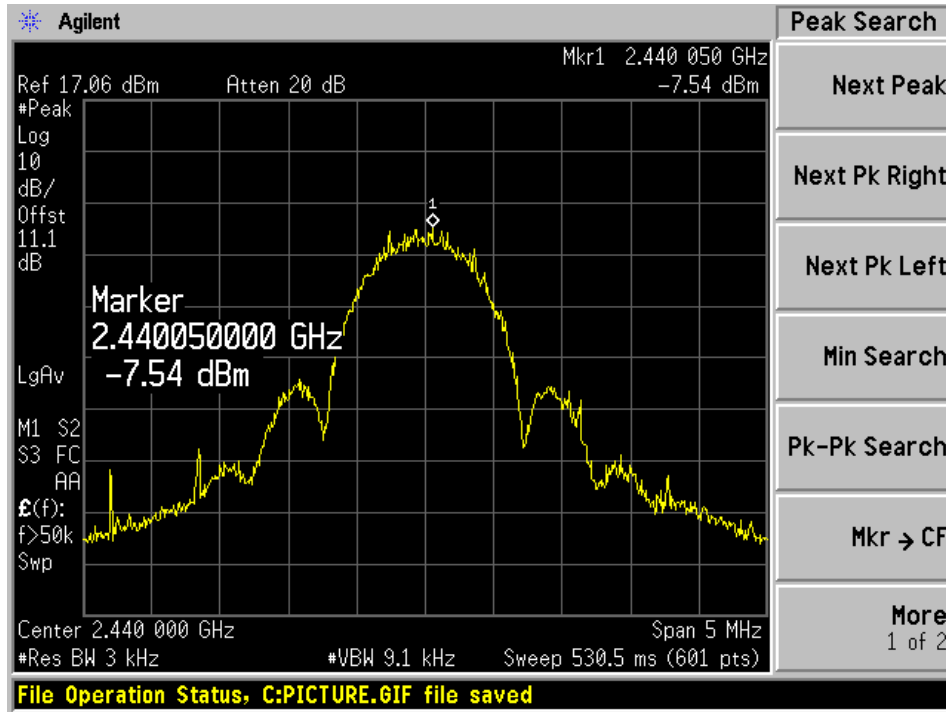

High Channel: 2480 MHz

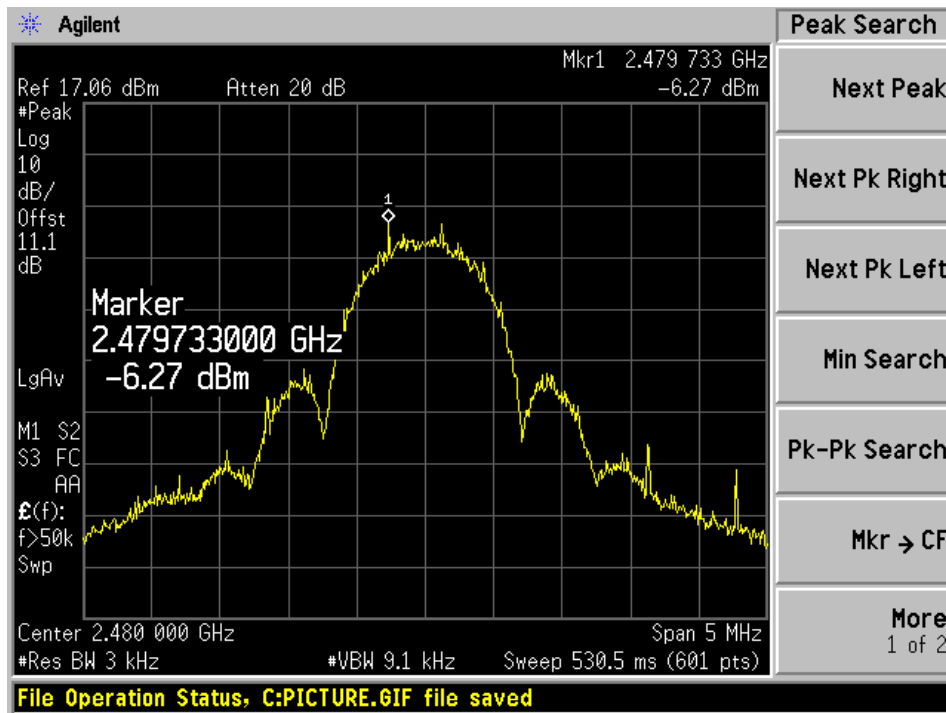

9 FCC §15.247(d) & ISEDC RSS-247 §5.5 - 100 kHz Bandwidth of Band Edges

9.1 Applicable Standards

According to FCC §15.247(d), in any 100 kHz bandwidth outside the frequency bands in which the spread spectrum intentional radiator is operating, the radio frequency power that is produced by the intentional radiator shall be at least 20 dB below that in the 100 kHz bandwidth within the band that contains the highest level of the desired power, based on either an RF conducted or a radiated measurement. In addition, radiated emissions which fall in the restricted bands, as defined in §15.205(a), must also comply with the radiated emissions limits specified in §15.209(a) see §15.205(c).

According to ISEDC RSS-247 §5.5. In any 100 kHz bandwidth outside the frequency band in which the spread spectrum or digitally modulated device is operating, the RF power that is produced shall be at least 20 dB below that in the 100 kHz bandwidth within the band that contains the highest level of the desired power, based on either an RF conducted or a radiated measurement, provided that the transmitter demonstrates compliance with the peak conducted power limits. If the transmitter complies with the conducted power limits based on the use of root-mean-square averaging over a time interval, as permitted under Section 5.4(4), the attenuation required shall be 30 dB instead of 20 dB. Attenuation below the general field strength limits specified in RSS-Gen is not required.

9.2 Measurement Procedure

Span = wide enough to capture the peak level of the emission operating on the channel closest to the band edge, as well as any modulation products which fall outside of the authorized band of operation

RBW = 100 kHz

VBW = 300 kHz

Sweep = coupled

Detector function = peak

Trace = max hold

9.3 Test Setup Diagram

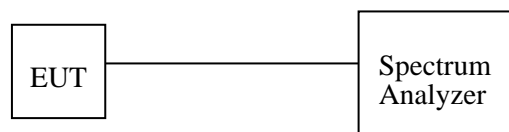

9.4 Test Equipment List and Details

BACL No.	Manufacturer	Description	Model No.	Serial No.	Calibration Date	Calibration Interval
287	Agilent	Spectrum Analyzer	E4446A	US44300386	2022-05-05-	1 year
-	-	RF cable	-	-	Each time ¹	N/A
-	-	10 dB Attenuator	-	-	Each time	N/A

Note¹: equipment included in the test set-up will be checked each time before testing.

Statement of Traceability: *BACL Corp.* attests that all of the calibrations on the equipment items listed above were traceable to NIST or to another internationally recognized National Metrology Institute (NMI), and were compliant with the latest version of A2LA policy P102 "A2LA Policy on Metrological Traceability".

9.5 Test Environmental Conditions

Temperature:	21° C
Relative Humidity:	39 %
ATM Pressure:	102.0 kPa

The testing was performed by Marc Jean on 2022-07-22 at RF test site.

9.6 Test Results

Please refer to the following plots.

Low Channel: 2402 MHz

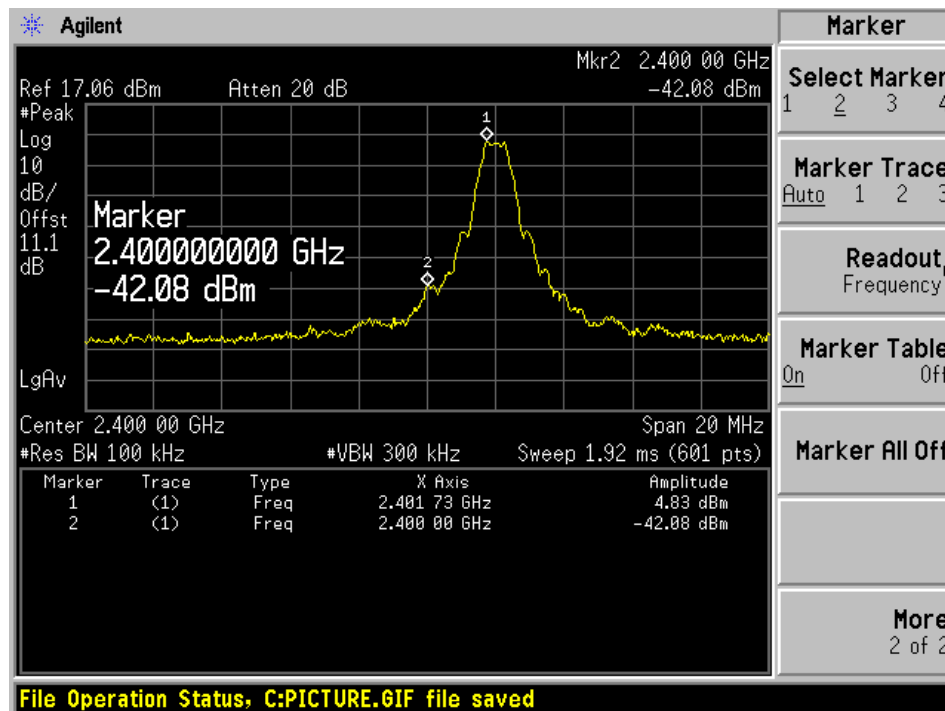

High Channel: 2480 MHz

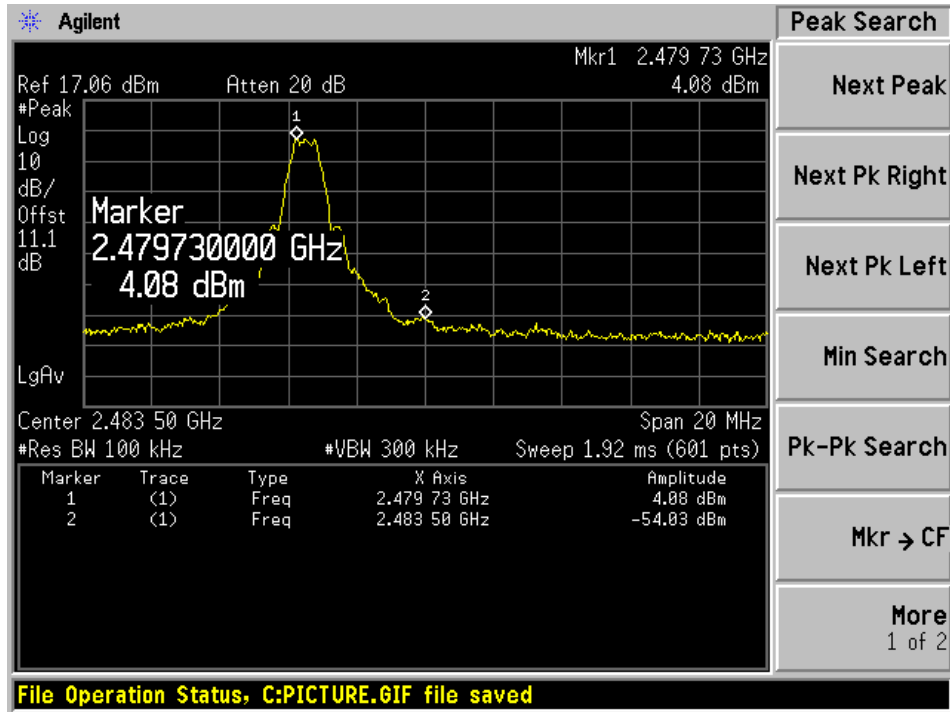

10 FCC §15.247(d) & ISEDC RSS-247 §5.5 - Spurious Emissions at Antenna Terminals

10.1 Applicable Standards

For FCC §15.247(d) and ISEDC RSS-247 §5.5, in any 100 kHz bandwidth outside the frequency band in which the spread spectrum or digitally modulated intentional radiator is operating, the radio frequency power that is produced by the intentional radiator shall be at least 20 dB below that in the 100 kHz bandwidth within the band that contains the highest level of the desired power, based on either an RF conducted or a radiated measurement, provided the transmitter demonstrates compliance with the peak conducted power limits. If the transmitter complies with the conducted power limits based on the use of RMS averaging over a time interval, as permitted under paragraph (b)(3) of this section, the attenuation required under this paragraph shall be 30 dB instead of 20 dB. Attenuation below the general limits specified in §15.209(a) is not required. In addition, radiated emissions which fall in the restricted bands, as defined in §15.205(a), must also comply with the radiated emission limits specified in §15.209(a) (see §15.205(c)).

10.2 Test Procedure

The RF output of the EUT was connected to a spectrum analyzer through appropriate attenuation. The resolution bandwidth of the spectrum analyzer was set at 100 kHz. Sufficient scans were taken to show any out of band emissions up to 10th harmonic.

10.3 Test Setup Diagram

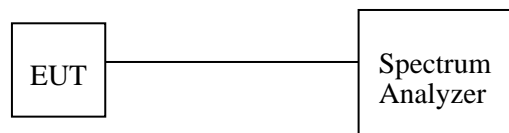

10.4 Test Equipment List and Details

BACL No.	Manufacturer	Description	Model No.	Serial No.	Calibration Date	Calibration Interval
287	Agilent	Spectrum Analyzer	E4446A	US44300386	2022-05-05-	1 year
-	-	RF cable	-	-	Each time ¹	N/A
-	-	10 dB Attenuator	-	-	Each time	N/A

Note¹: equipment included in the test set-up will be checked each time before testing.

Statement of Traceability: *BACL Corp.* attests that all of the calibrations on the equipment items listed above were traceable to NIST or to another internationally recognized National Metrology Institute (NMI), and were compliant with the latest version of A2LA policy P102 "A2LA Policy on Metrological Traceability".

10.5 Test Environmental Conditions

Temperature:	21° C
Relative Humidity:	39 %
ATM Pressure:	102.0 kPa

The testing was performed by Marc Jean on 2022-06-30 at RF test site.

10.6 Test Results

Please refer to the following plots.

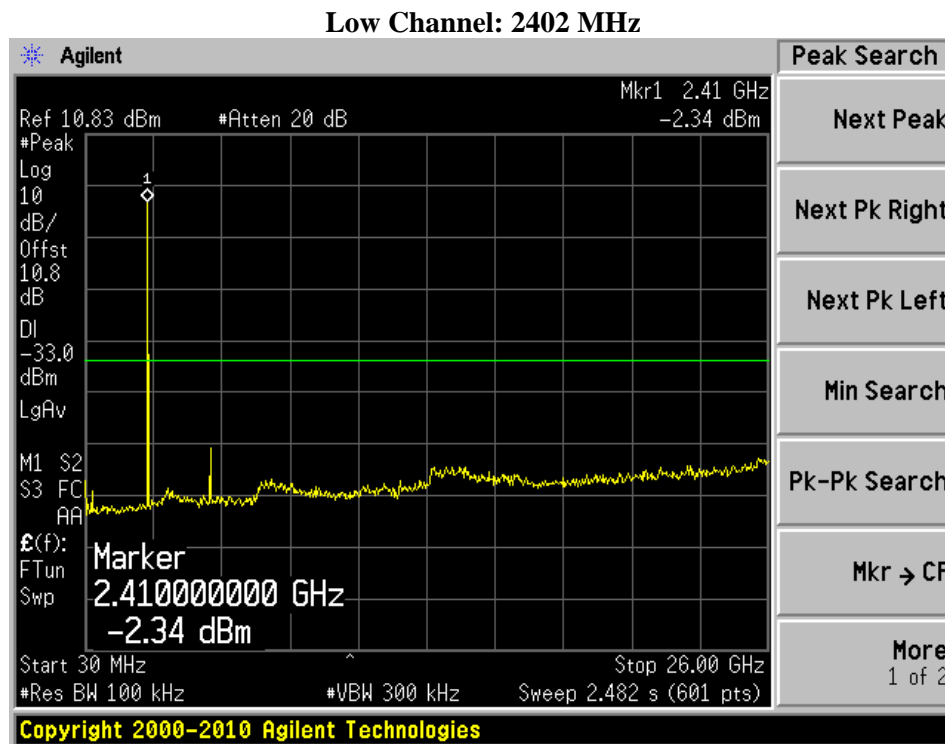

Middle Channel: 2440 MHz

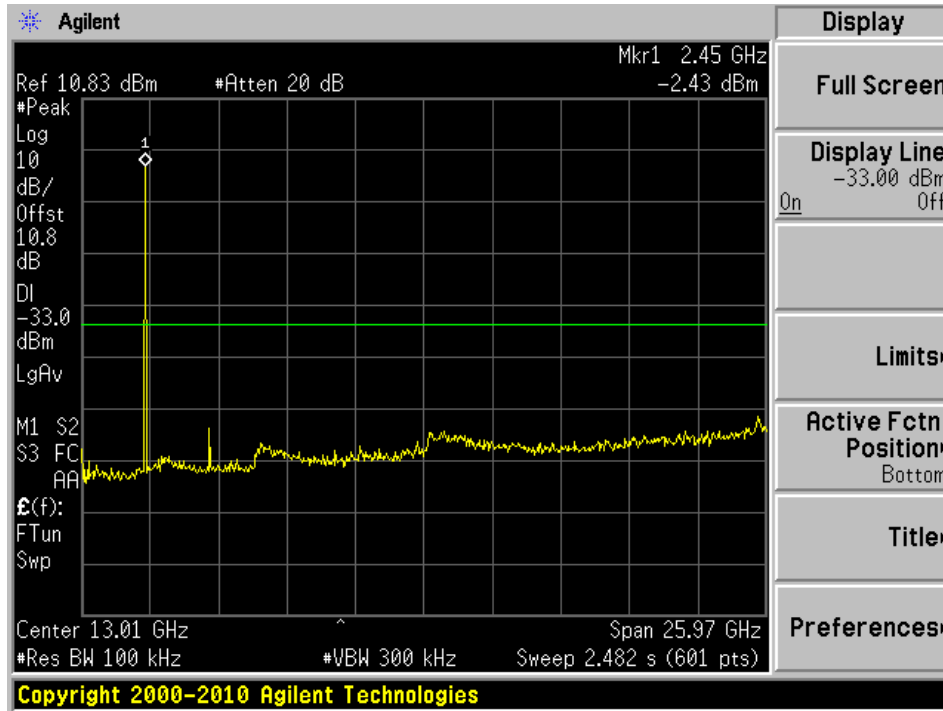

High Channel: 2480 MHz

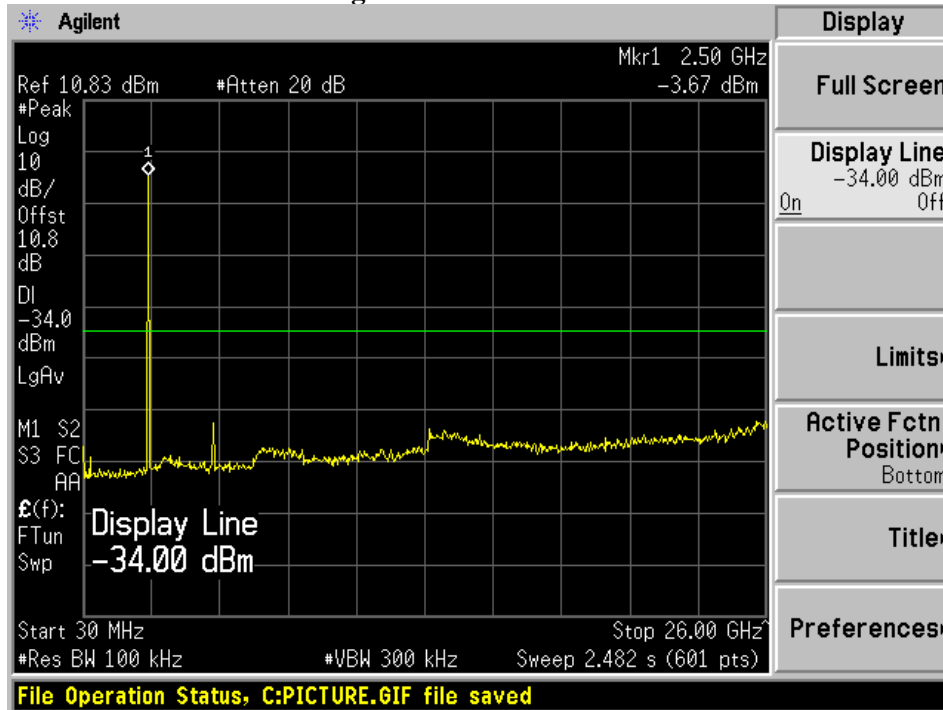

11 Annex A (Normative) - Test Setup Photographs

Please refer to the attachment

12 Annex B (Normative) - EUT External Photographs

Please refer to the attachment

13 Annex C (Normative) - EUT Internal Photographs

Please refer to the attachment

14 Annex D (Normative) - A2LA Electrical Testing Certificate



Accredited Laboratory

A2LA has accredited

BAY AREA COMPLIANCE LABORATORIES CORP.

Sunnyvale, CA

for technical competence in the field of

Electrical Testing

This laboratory is accredited in accordance with the recognized International Standard ISO/IEC 17025:2017 General requirements for the competence of testing and calibration laboratories. This laboratory also meets A2LA R222 - Specific Requirements EPA ENERGY STAR Accreditation Program. This accreditation demonstrates technical competence for a defined scope and the operation of a laboratory quality management system (refer to joint ISO-ILAC-IAF Communiqué dated April 2017).



Presented this 10th day of March 2021.

Trace McInturf, Vice President, Accreditation Services
For the Accreditation Council
Certificate Number 3297.02
Valid to September 30, 2022

For the tests to which this accreditation applies, please refer to the laboratory's Electrical Scope of Accreditation.

Please follow the web link below for a full ISO 17025 scope

<https://www.a2la.org/scopepdf/3297-02.pdf>

--- END OF REPORT ---