



# FCC Test Report

**FCC ID** : 2AEIM-1509518D  
**Equipment** : B-pillar Endpoint  
**Brand Name** : Tesla  
**Model Name** : 1509518D  
**Applicant/  
Manufacturer** : Tesla Motors, Inc.  
3500 Deer Creek Road Palo Alto, California US 94304  
United States Of America  
**Standard** : 47 CFR FCC Part 15.225

The product was received on Dec. 26, 2019, and testing was started from Jan. 14, 2020 and completed on Jan. 14, 2020. We, SPORTON INTERNATIONAL INC. EMC & Wireless Communications Laboratory, would like to declare that the tested sample has been evaluated in accordance with the procedures given in ANSI C63.10-2013 and shown compliance with the applicable technical standards.

The report must not be used by the client to claim product certification, approval, or endorsement by TAF or any agency of United States government.

The test results in this report apply exclusively to the tested model / sample. Without written approval of SPORTON INTERNATIONAL INC. EMC & Wireless Communications Laboratory, the test report shall not be reproduced except in full.

Approved by: Phoenix Chen

**SPORTON INTERNATIONAL INC. EMC & Wireless Communications Laboratory**

No. 52, Huaya 1st Rd., Guishan Dist., Taoyuan City, Taiwan (R.O.C.)



# Table of Contents

**HISTORY OF THIS TEST REPORT .....3**

**SUMMARY OF TEST RESULT .....4**

**1 GENERAL DESCRIPTION .....5**

1.1 Information.....5

1.2 Testing Applied Standards .....7

1.3 Testing Location Information .....7

1.4 Measurement Uncertainty .....7

**2 TEST CONFIGURATION OF EUT.....8**

2.1 Test Condition .....8

2.2 The Worst Case Modulation Configuration .....8

2.3 Test Channel Frequencies Configuration.....8

2.4 The Worst Case Measurement Configuration .....9

2.5 Support Equipment.....10

2.6 Test Setup Diagram .....11

**3 TRANSMITTER TEST RESULT .....12**

3.1 AC Power-line Conducted Emissions .....12

3.2 Emission Bandwidth .....16

3.3 Field Strength of Fundamental Emissions and Spectrum Mask .....18

3.4 Transmitter Radiated Unwanted Emissions .....20

3.5 Frequency Stability .....29

**4 TEST EQUIPMENT AND CALIBRATION DATA.....33**

## Appendix A. Test Photos

### Photographs of EUT V01



### History of this test report

Report No.	Version	Description	Issued Date
FR9O2512-01AR	01	Initial issue of report	Jan. 22, 2020



### Summary of Test Result

Report Clause	Ref. Std. Clause	Test Items	Result (PASS/FAIL)	Remark
1.1.2	15.203	Antenna Requirement	PASS	FCC 15.203
3.1	15.207	AC Power-line Conducted Emissions	PASS	FCC 15.207
3.2	15.215(c)	Emission Bandwidth	PASS	Fall in band $F_L \geq 13.553$ MHz $F_H \leq 13.567$ MHz
3.3	15.225(a)-(d)	Field Strength of Fundamental Emissions and Spectrum Mask	PASS	124 dBuV/m at 3m
3.4	15.225(d)	Transmitter Radiated Unwanted Emissions	PASS	FCC 15.209
3.5	15.225(e)	Frequency Stability	PASS	$\pm 0.01\%$ (100ppm)

**Declaration of Conformity:**

The test results with all measurement uncertainty excluded are presented in accordance with the regulation limits or requirements declared by manufacturers.

**Comments and explanations:**

None

Reviewed by: Sam Tsai

Report Producer: Kate Lo



# 1 General Description

## 1.1 Information

### 1.1.1 RF General Information

RF General Information				
Frequency Range	Modulation Mode	Ch. Frequency (MHz)	Channel Number	Field Strength (dBuV/m)
13.553 – 13.567 MHz	ISO 14443-3A (ASK)	13.56	1	78.56
Note 1: Field strength performed peak level at 3m.				

### 1.1.2 Antenna Information

Antenna Category	
<input type="checkbox"/>	Equipment placed on the market without antennas
<input checked="" type="checkbox"/>	Integral antenna (antenna permanently attached)
<input type="checkbox"/>	Temporary RF connector provided
<input checked="" type="checkbox"/>	No temporary RF connector provided Transmit chains bypass antenna and soldered temporary RF connector provided for connected measurement. In case of conducted measurements the transmitter shall be connected to the measuring equipment via a suitable attenuator and correct for all losses in the RF path.
<input type="checkbox"/>	External antenna (dedicated antennas)

Antenna General Information		
No.	Ant. Cat.	Ant. Type
1	Integral	Loop

### 1.1.3 EUT Information

Operational Condition	
EUT Power Type	From DC Power supply
Type of EUT	
<input checked="" type="checkbox"/>	Stand-alone
<input type="checkbox"/>	Combined (EUT where the radio part is fully integrated within another device)
	Combined Equipment - Brand Name / Model No.:
<input type="checkbox"/>	Plug-in radio (EUT intended for a variety of host systems)
	Host System - Brand Name / Model No.:
<input type="checkbox"/>	Other:

1.1.4 Test Signal Duty Cycle

Duty Cycle Operation Restriction	
The transmitter is used for	The transmitter is operated
<input checked="" type="checkbox"/> Inductive applications	<input checked="" type="checkbox"/> Automatically triggered
<input type="checkbox"/> Duty cycle fixed mode	<input checked="" type="checkbox"/> Duty cycle random mode
<input checked="" type="checkbox"/> <b>Duty cycle mode - NFC-A (ISO 14443-3A)</b>	
Declare transmitter duty cycle / 1 hour =	100%
<input type="checkbox"/> <b>Duty cycle mode - NFC-B (ISO 14443-3B)</b>	
Declare transmitter duty cycle / 1 hour =	100%
<input type="checkbox"/> <b>Duty cycle mode - NFC-F (ISO 18092)</b>	
Declare transmitter duty cycle / 1 hour =	100%
<input type="checkbox"/> <b>Duty cycle mode - NFC-V (ISO 15693)</b>	
Declare transmitter duty cycle / 1 hour =	100%

## 1.2 Testing Applied Standards

According to the specifications of the manufacturer, the EUT must comply with the requirements of the following standards:

- ◆ 47 CFR FCC Part 15
- ◆ ANSI C63.10-2013
- ◆ KDB 174176 D01 v01r01
- ◆ KDB 414788 D01 v01r01

## 1.3 Testing Location Information

Testing Location					
<input checked="" type="checkbox"/>	HWA YA	ADD	:	No. 52, Huaya 1st Rd., Guishan Dist., Taoyuan City, Taiwan (R.O.C.)	
		TEL	:	886-3-327-3456	FAX : 886-3-327-0973
Test site Designation No. TW1190 with FCC.					

Test Condition	Test Site No.	Test Engineer	Test Environment	Test Date
AC Conduction	CO04-HY	Edward	22.2~23.5°C / 53~55%	14/Jan/2020
RF Conducted	TH01-HY	Barry	23.5~24.3°C / 61~64%	14/Jan/2020
Radiated Emission	03CH03-HY	Patrick	25.3~26.6°C / 52.9~55.1%	14/Jan/2020

## 1.4 Measurement Uncertainty

ISO/IEC 17025 requires that an estimate of the measurement uncertainties associated with the emissions test results be included in the report. The measurement uncertainties given below are based on a 95% confidence level (based on a coverage factor (k=2))

Test Items	Uncertainty	Remark
Conducted Emission (150kHz ~ 30MHz)	3.54 dB	Confidence levels of 95%
Radiated Emission (9kHz ~ 30MHz)	1.6 dB	Confidence levels of 95%
Radiated Emission (30MHz ~ 1,000MHz)	4.3 dB	Confidence levels of 95%
Conducted Emission	1.3 dB	Confidence levels of 95%
Temperature	0.7 °C	Confidence levels of 95%
Humidity	4 %	Confidence levels of 95%

## 2 Test Configuration of EUT

### 2.1 Test Condition

Condition Item	Abbreviation/Remark	Remark
Frequency Stability	Tnom	20°C
-	Tmin	-40°C
-	Tmax	85°C
-	Vnom	12V
-	Vmin	10.8V
-	Vmax	13.2V

### 2.2 The Worst Case Modulation Configuration

Modulation Used for Conformance Testing	
Modulation Mode	Field Strength (dBuV/m at 3 m)
NFC	78.56

### 2.3 Test Channel Frequencies Configuration



Modulation Mode	Test Channel Frequencies (MHz)
NFC	13.56



## 2.4 The Worst Case Measurement Configuration

The Worst Case Mode for Following Conformance Tests	
<b>Tests Item</b>	AC power-line conducted emissions
<b>Condition</b>	AC power-line conducted measurement for line and neutral
<b>Operating Mode</b>	DC Power Supply mode

The Worst Case Mode for Following Conformance Tests	
<b>Tests Item</b>	Emission Bandwidth, Frequency Stability
<b>Test Condition</b>	Conducted measurement

The Worst Case Mode for Following Conformance Tests			
<b>Tests Item</b>	Field Strength of Fundamental Emissions Spectrum Mask, Transmitter Radiated Unwanted Emissions		
<b>Test Condition</b>	Radiated measurement		
<b>Operating Mode</b>	DC Power Supply mode		
<b>Orthogonal Planes of EUT</b>	<b>X Plane</b>	<b>Y Plane</b>	<b>Z Plane</b>
			
<b>Worst Planes of EUT</b>	V		

## 2.5 Support Equipment

Support Equipment - AC Conduction			
No.	Equipment	Brand Name	Model Name
1	AC Power Cable	Power sync	PW-GPC180-3
2	DC Power Supply	GW	GPS-3030DD

Support Equipment - RF Conducted			
No.	Equipment	Brand Name	Model Name
1	Notebook	HP	-
2	Adapter for NB	HP	-
3	DC Power Supply	GW	GPS-3030DD
4	Fixture	-	-

Note: Support equipment No.1 & No.2 & No.4 were provided by customer.

Support Equipment - Radiated			
No.	Equipment	Brand Name	Model Name
1	AC Power Cable	Power sync	PW-GPC180-3
2	DC Power Supply	GW	GPS-3030DD

## 2.6 Test Setup Diagram

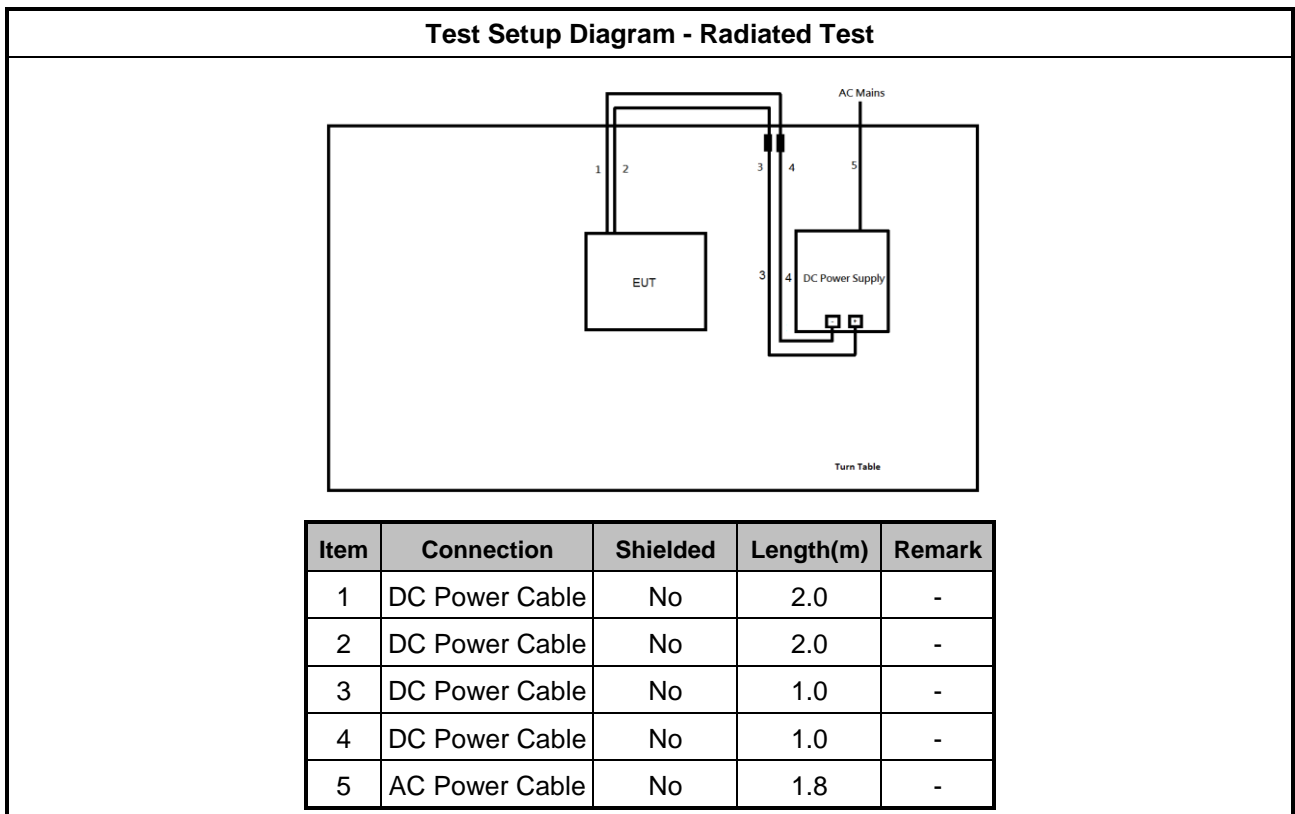
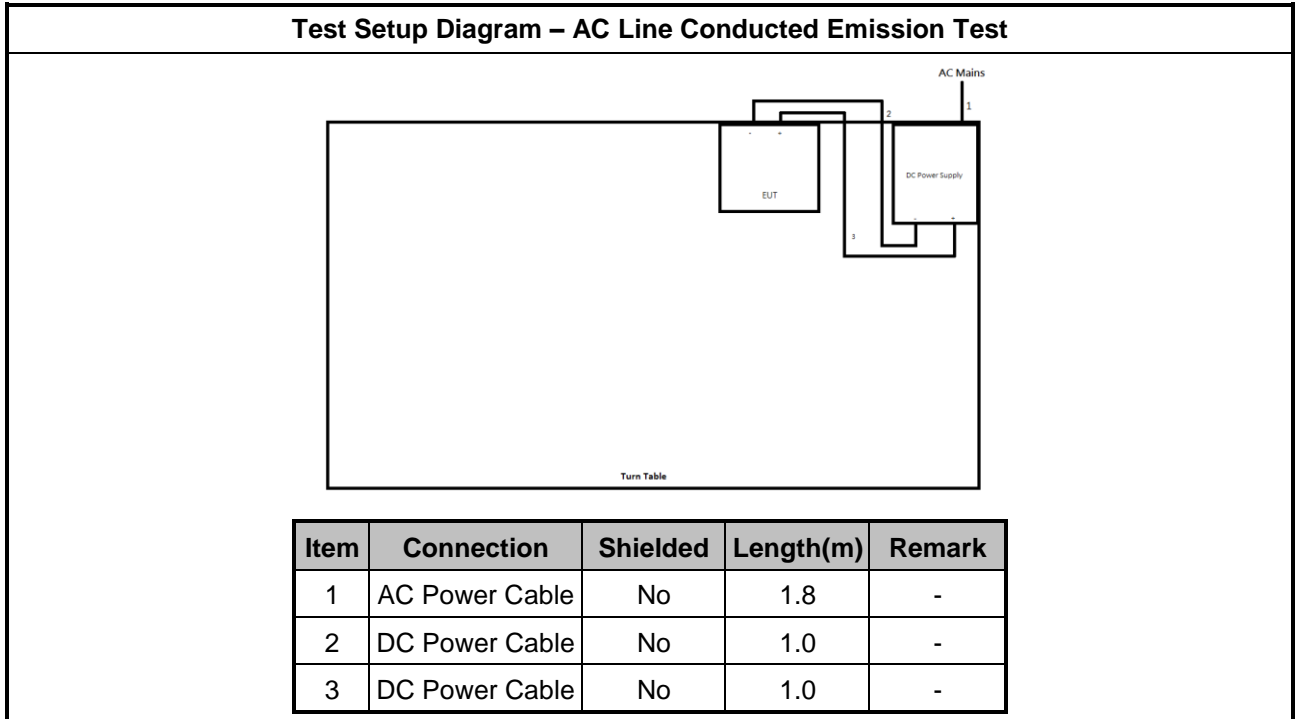

### 3 Transmitter Test Result

#### 3.1 AC Power-line Conducted Emissions

##### 3.1.1 AC Power-line Conducted Emissions Limit

AC Power-line Conducted Emissions Limit		
Frequency Emission (MHz)	Quasi-Peak	Average
0.15-0.5	66 - 56 *	56 - 46 *
0.5-5	56	46
5-30	60	50

Note 1: \* Decreases with the logarithm of the frequency.

##### 3.1.2 Measuring Instruments

Refer a test equipment and calibration data table in this test report.

##### 3.1.3 Test Procedures

Test Method	
<input checked="" type="checkbox"/>	Refer as ANSI C63.10-2013, clause 6.2 for AC power-line conducted emissions.
<input checked="" type="checkbox"/>	If AC conducted emissions fall in operating band, then following below test method confirm final result.
<input type="checkbox"/>	Accept measurements done with a suitable dummy load replacing the antenna under the following conditions: (1) Perform the AC line conducted tests with the antenna connected to determine compliance with FCC 15.207 limits outside the transmitter's fundamental emission band; (2) Retest with a dummy load to determine compliance with FCC 15.207 limits within the transmitter's fundamental emission band.
<input checked="" type="checkbox"/>	For a device with a permanent antenna operating at or below 30 MHz, accept measurements done with a suitable dummy load, in lieu of the permanent antenna under the following conditions: (1) Perform the AC line conducted tests with the permanent antenna to determine compliance with the FCC 15.207 limits outside the transmitter's fundamental emission band; (2) Retest with a dummy load in lieu of the permanent antenna to determine compliance with the FCC 15.207 limits within the transmitter's fundamental emission band.

### 3.1.4 Test Setup

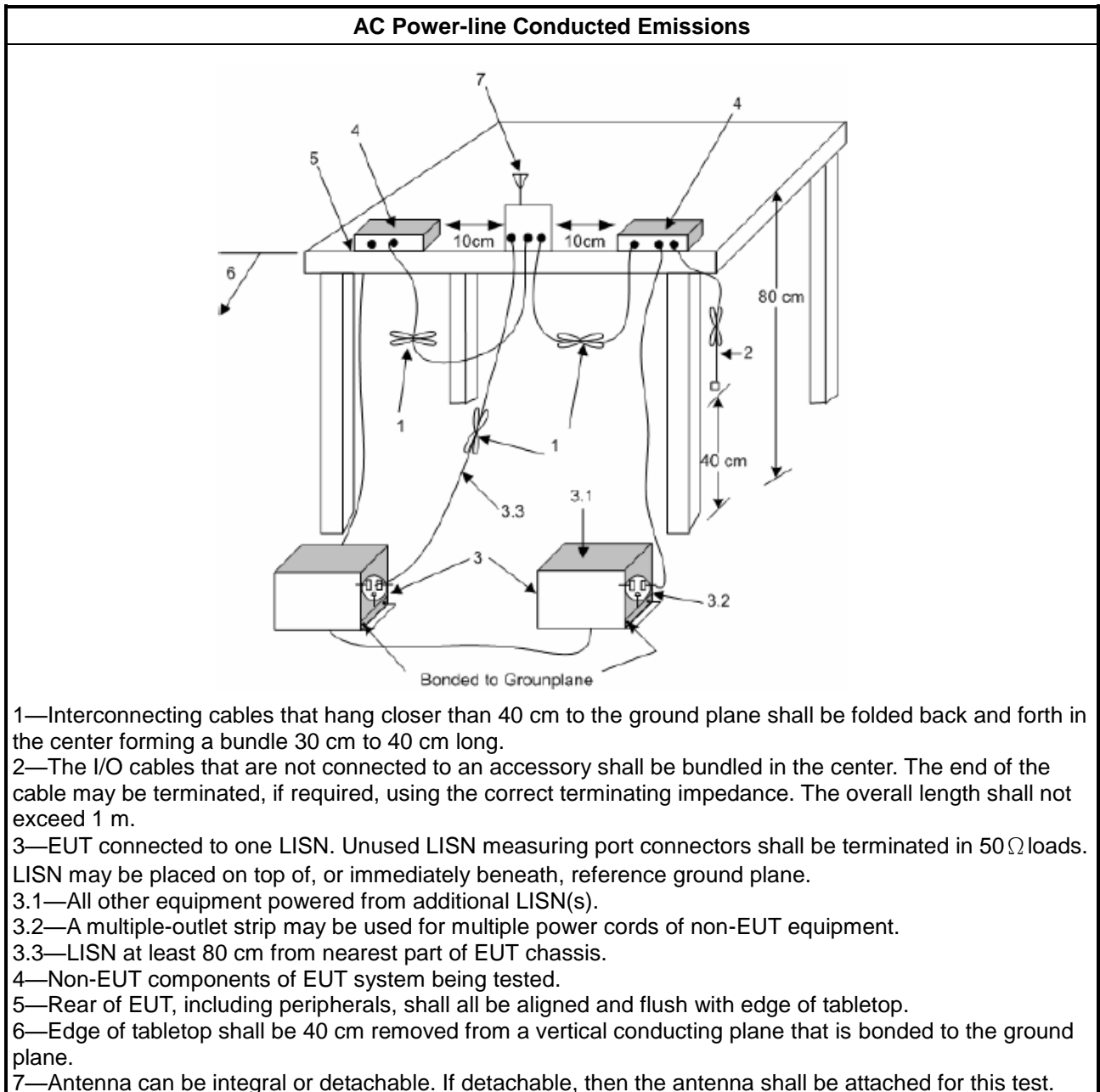

### 3.1.5 Test Result of AC Power-line Conducted Emissions

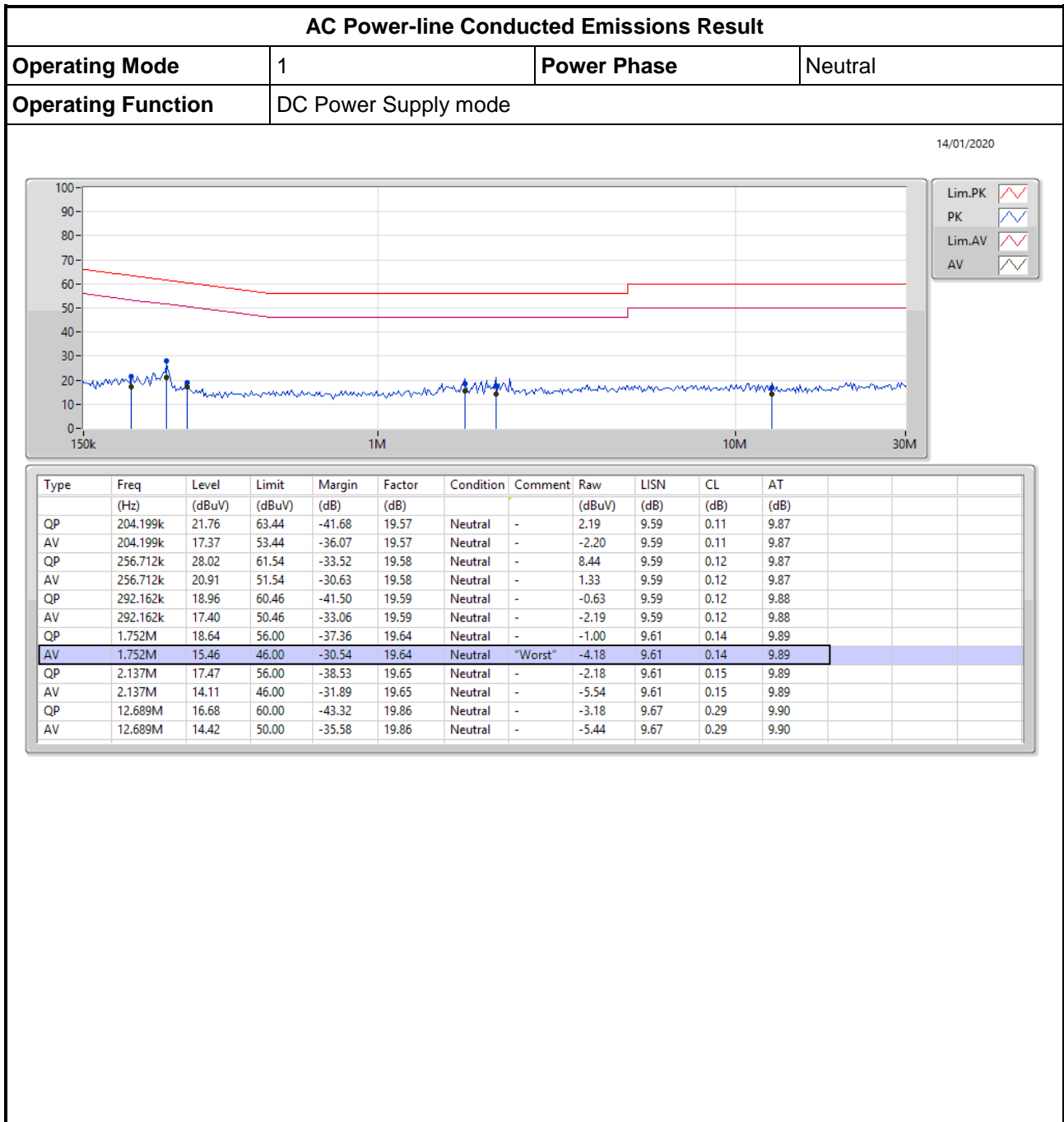

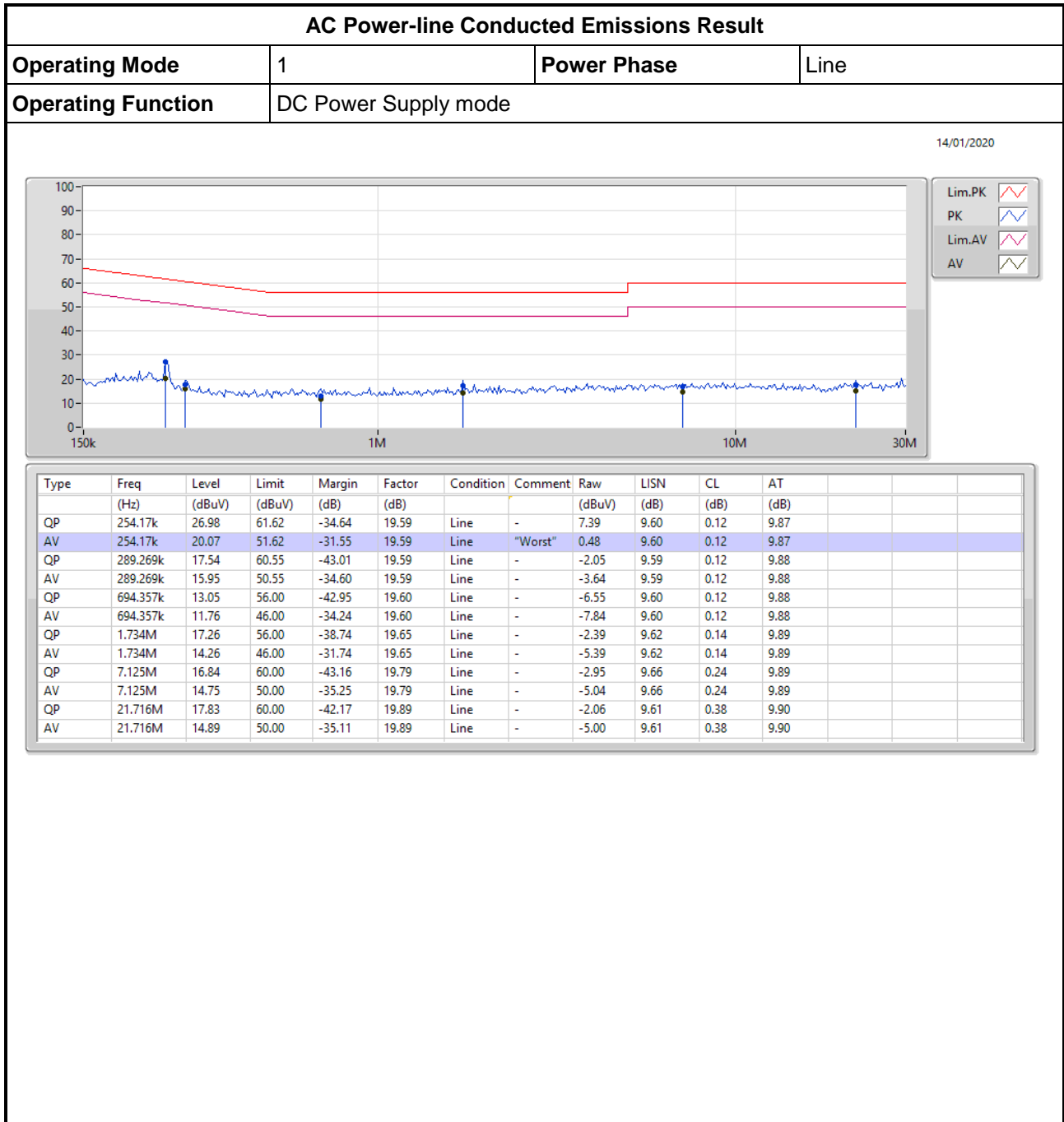

### 3.2 Emission Bandwidth

#### 3.2.1 Emission Bandwidth Limit

20dB Bandwidth Limit	
<input checked="" type="checkbox"/>	Intentional radiators must be designed to ensure that the 20 dB bandwidth of the emissions in the specific band (13.553 – 13.567 MHz).

#### 3.2.2 Measuring Instruments

Refer a test equipment and calibration data table in this test report.

#### 3.2.3 Test Procedures

Test Method	
<input checked="" type="checkbox"/>	Because the measured signal is CW or CW-like adjusting the RBW per C63.10 would not be practical since measured bandwidth will always follow the RBW and the result will be approximately twice the RBW.
<input checked="" type="checkbox"/>	For radiated measurement. Loop antenna was rotated about the horizontal and vertical axis and the equipment to be measured and the test antenna shall be oriented to obtain the maximum emitted field strength level.

#### 3.2.4 Test Setup

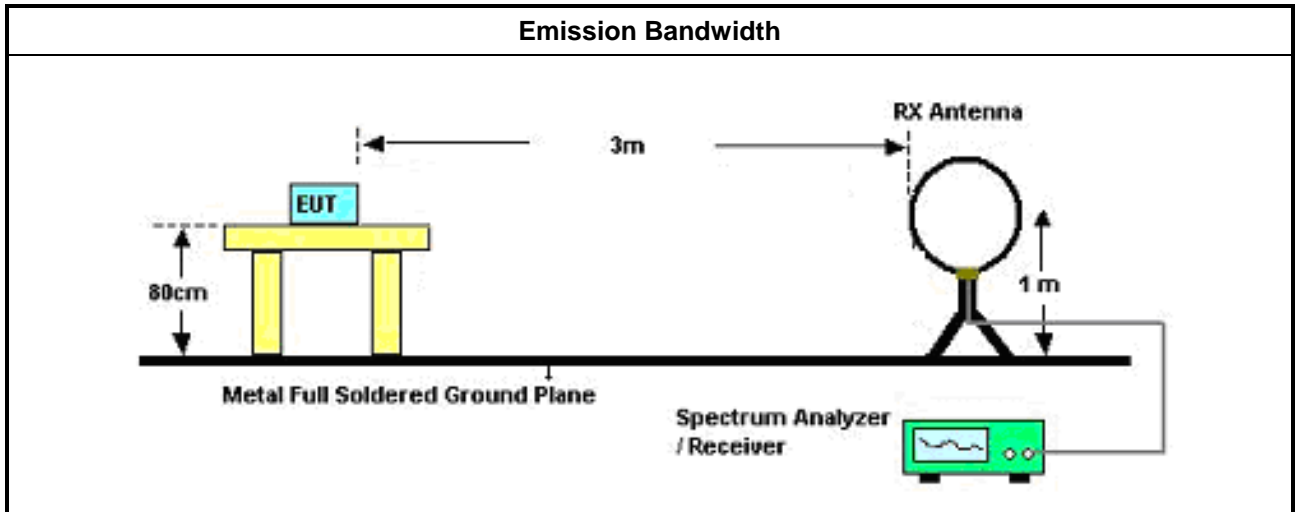



### 3.2.5 Test Result of Emission Bandwidth

#### Summary

Mode	20dB (Hz)	OBW (Hz)
13.553-13.567MHz	-	-
NFC	2.583k	2.193k

#### Result

Mode	Result	20dB (Hz)	FI-20dB (Hz)	Fh-20dB (Hz)	OBW (Hz)	FI-OBW (Hz)	Fh-OBW (Hz)	Limit (Range)
NFC	-	-	-	-	-	-	-	-
13.56MHz_TnomVnom	Pass	2.583k	13.55845M	13.56103M	2.193k	13.55864M	13.56083M	13.553-13.567

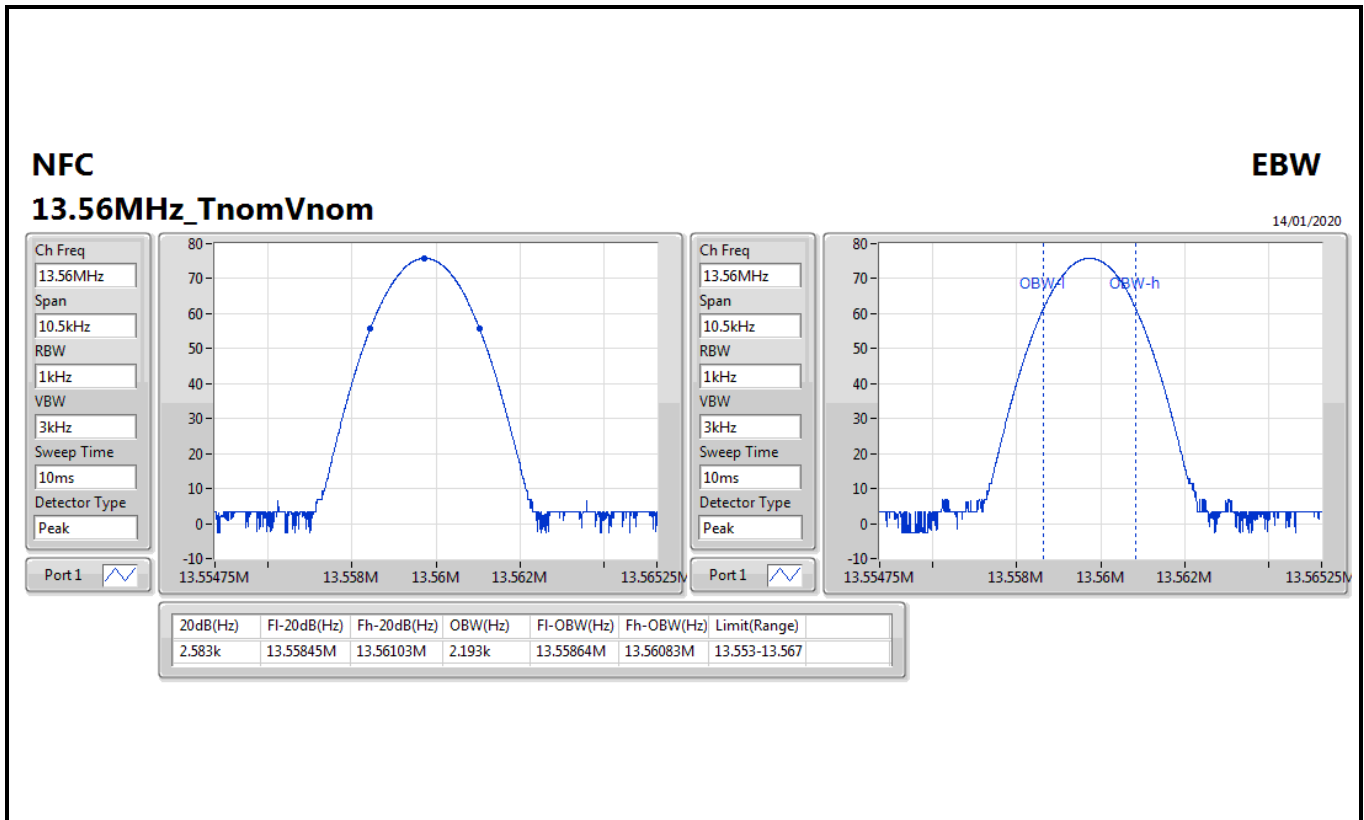

### 3.3 Field Strength of Fundamental Emissions and Spectrum Mask

#### 3.3.1 Field Strength of Fundamental Emissions and Spectrum Mask Limit

Field Strength of Fundamental Emissions For FCC					
Emissions	(uV/m)@30m	(dBuV/m)@30m	(dBuV/m)@10m	(dBuV/m)@3m	(dBuV/m)@1m
fundamental	15848	84.0	103.1	124.0	143.1
Quasi peak measurement of the fundamental.					

Spectrum Mask For FCC					
Freq. of Emission (MHz)	(uV/m)@30m	(dBuV/m)@30m	(dBuV/m)@10m	(dBuV/m)@3m	(dBuV/m)@1m
1.705~13.110	30	29.5	48.6	69.5	88.6
13.110~13.410	106	40.5	59.6	80.5	99.6
13.410~13.553	334	50.5	69.6	90.5	109.6
13.553~13.567	15848	84.0	103.1	124.0	143.1
13.567~13.710	334	50.5	69.6	90.5	109.6
13.710~14.010	106	40.5	59.6	80.5	99.6
14.010~30.000	30	29.5	48.6	69.5	88.6

#### 3.3.2 Measuring Instruments

Refer a test equipment and calibration data table in this test report.

#### 3.3.3 Test Procedures

Test Method	
<input checked="" type="checkbox"/>	Refer as ANSI C63.10, clause 6.4 for radiated emissions from below 30 MHz and test distance is 3m.
<input checked="" type="checkbox"/>	At frequencies below 30 MHz, measurements may be performed at a distance closer than that specified in the requirements; however, an attempt should be made to avoid making measurements in the near field. Pending the development of an appropriate measurement procedure for measurements performed below 30 MHz, when performing measurements at a closer distance than specified, the results shall be following below methods.
<input type="checkbox"/>	The results shall be extrapolated to the specified distance by making measurements at a minimum of two distances on at least one radial to determine the proper extrapolation factor.
<input checked="" type="checkbox"/>	The results shall be by using the square of an inverse linear distance extrapolation factor (40 dB/decade).
<input checked="" type="checkbox"/>	For radiated measurement. Loop antenna was rotated about the horizontal and vertical axis and the equipment to be measured and the test antenna shall be oriented to obtain the maximum emitted field strength level.

### 3.3.4 Test Setup

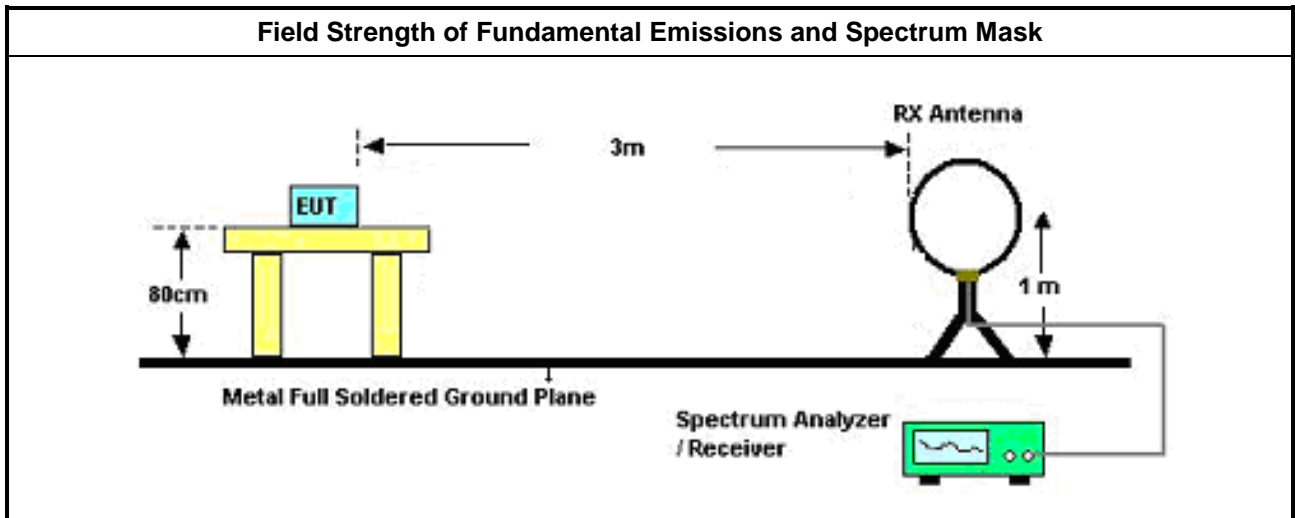

### 3.3.5 Test Result of Field Strength of Fundamental Emissions and Spectrum Mask

Field Strength of Fundamental Emissions Result					
Modulation Mode	Frequency (MHz)	Fundamental (dBuV/m)@3m	Polarization	Margin (dB)	Limit (dBuV/m)@3m
NFC	13.56	78.56	H	45.44	124.00
<b>Result</b>		<b>Complied</b>			

Note 1: Measurement worst emissions of receive antenna polarization: H(Horizontal).

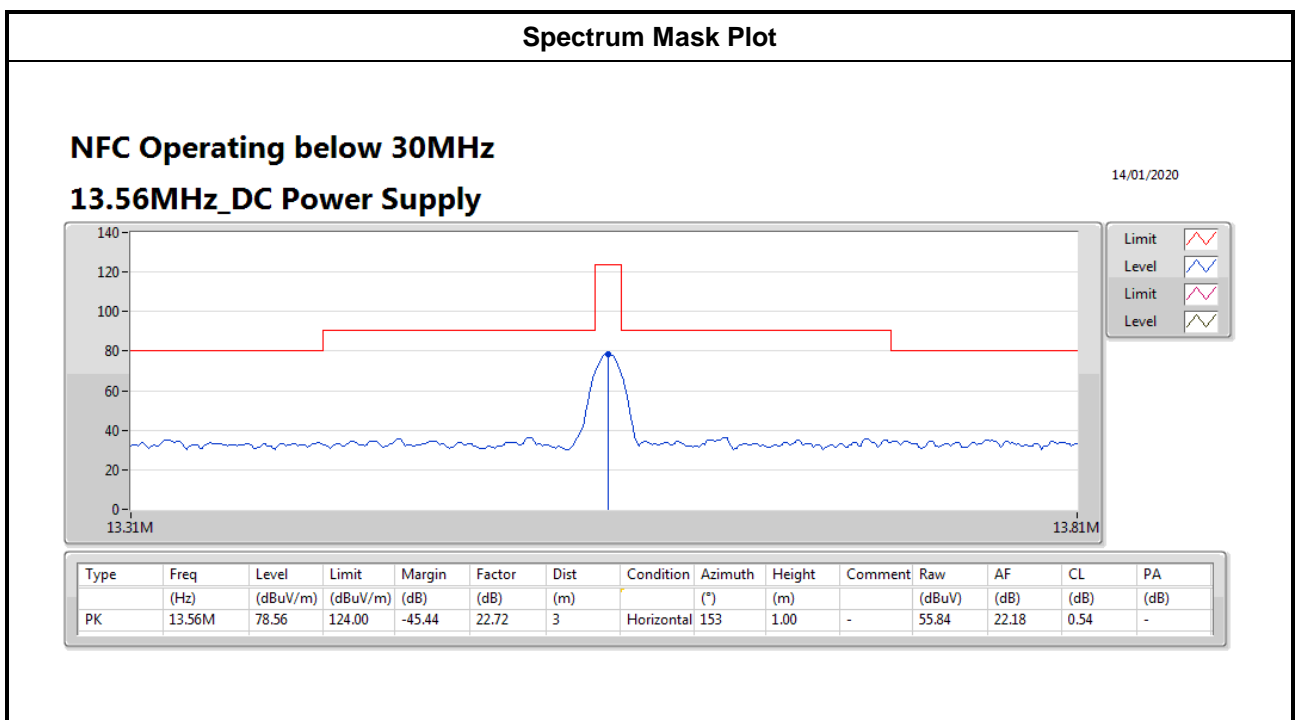

### 3.4 Transmitter Radiated Unwanted Emissions

#### 3.4.1 Transmitter Radiated Unwanted Emissions Limit

Transmitter Radiated Unwanted Emissions Limit			
Frequency Range (MHz)	Field Strength (uV/m)	Field Strength (dBuV/m)	Measure Distance (m)
0.009~0.490	2400/F(kHz)	48.5 - 13.8	300
0.490~1.705	24000/F(kHz)	33.8 - 23	30
1.705~30.0	30	29	30
30~88	100	40	3
88~216	150	43.5	3
216~960	200	46	3
Above 960	500	54	3

Note 1: Test distance for frequencies at or above 30 MHz, measurements may be performed at a distance other than the limit distance provided they are not performed in the near field and the emissions to be measured can be detected by the measurement equipment. When performing measurements at a distance other than that specified, the results shall be extrapolated to the specified distance using an extrapolation factor of 20 dB/decade (inverse of linear distance for field-strength measurements, inverse of linear distance-squared for power-density measurements).

Note 2: Test distance for frequencies at below 30 MHz, measurements may be performed at a distance closer than the EUT limit distance; however, an attempt should be made to avoid making measurements in the near field. When performing measurements below 30 MHz at a closer distance than the limit distance, the results shall be extrapolated to the specified distance by either making measurements at a minimum of two or more distances on at least one radial to determine the proper extrapolation factor or by using the square of an inverse linear distance extrapolation factor (40 dB/decade). The test report shall specify the extrapolation method used to determine compliance of the EUT.

#### 3.4.2 Measuring Instruments

Refer a test equipment and calibration data table in this test report.

### 3.4.3 Test Procedures

Test Method	
<input checked="" type="checkbox"/>	Refer as ANSI C63.10, clause 6.5 for radiated emissions from 30 MHz to 1 GHz and test distance is 3m.
<input checked="" type="checkbox"/>	Refer as ANSI C63.10, clause 6.4 for radiated emissions from below 30 MHz and test distance is 3m.
<input checked="" type="checkbox"/>	At frequencies below 30 MHz, measurements may be performed at a distance closer than that specified in the requirements; however, an attempt should be made to avoid making measurements in the near field. Pending the development of an appropriate measurement procedure for measurements performed below 30 MHz, when performing measurements at a closer distance than specified, the results shall be following below methods.
<input type="checkbox"/>	The results shall be extrapolated to the specified distance by making measurements at a minimum of two distances on at least one radial to determine the proper extrapolation factor.
<input checked="" type="checkbox"/>	The results shall be by using the square of an inverse linear distance extrapolation factor (40 dB/decade).
<input checked="" type="checkbox"/>	For radiated measurement. Loop antenna was rotated about the horizontal and vertical axis and the equipment to be measured and the test antenna shall be oriented to obtain the maximum emitted field strength level.
<input checked="" type="checkbox"/>	The any unwanted emissions level shall not exceed the fundamental emission level.
<input checked="" type="checkbox"/>	All amplitude of spurious emissions that are attenuated by more than 20 dB below the permissible value has no need to be reported.
<input checked="" type="checkbox"/>	KDB 414788 D01 v01r01 Open-Field Test Sites and Chamber Correlation Justification.
<input type="checkbox"/>	<ul style="list-style-type: none"> <li>▪ Based on FCC 15.31 (f) (2): measurements may be performed at a distance closer than that specified in regulations; however, an attempt should be made to avoid making measurements in the near field.</li> </ul>
<input type="checkbox"/>	<ul style="list-style-type: none"> <li>▪ Open-field site and chamber correlation testing had been performed and chamber measured test result is the worst case test result.</li> </ul>

### 3.4.4 Test Setup

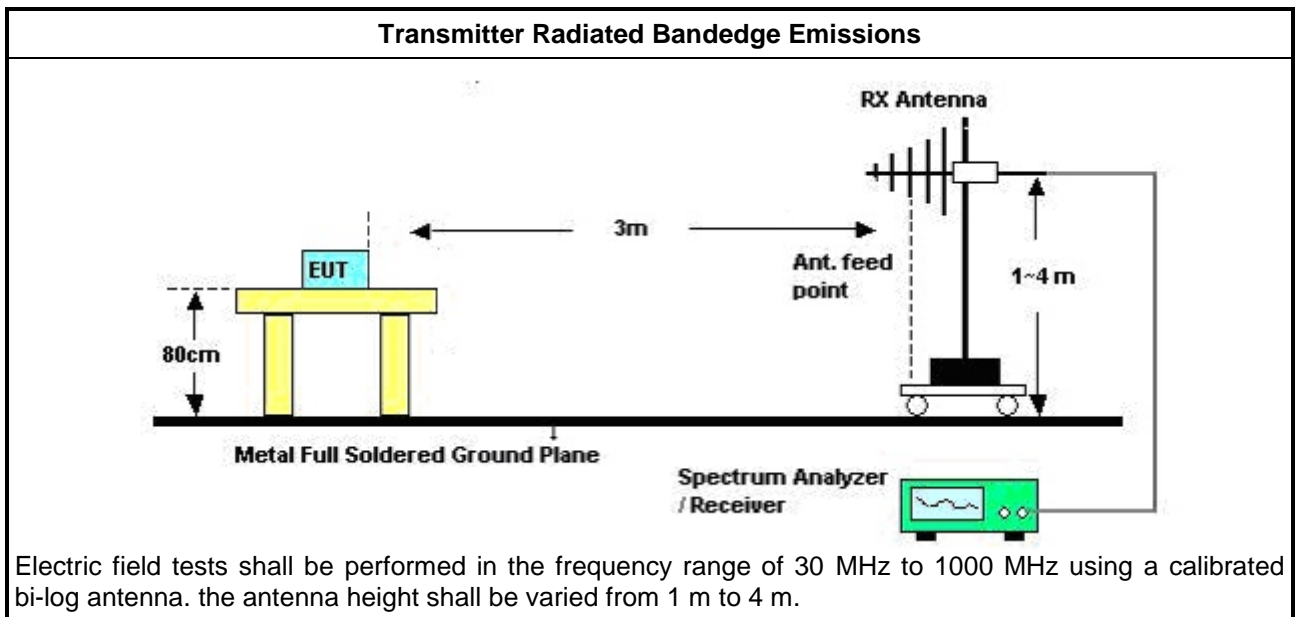
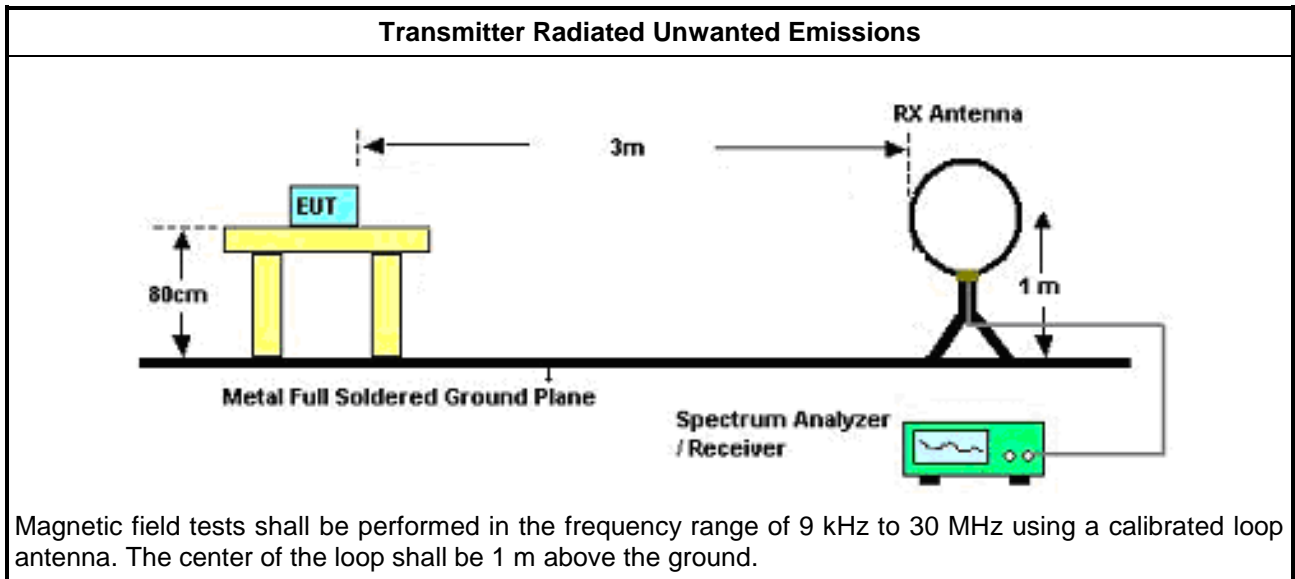



### 3.4.5 Transmitter Radiated Unwanted Emissions (Below 30MHz)

#### Summary

Mode	Result	Type	Freq (Hz)	Level (dBuV/m)	Limit (dBuV/m)	Margin (dB)	Factor (dB)	Dist (m)	Azimuth (°)	Height (m)	Comments
13.553-13.567MHz	-	-	-	-	-	-	-	-	-	-	-
NFC	Pass	PK	1.225M	41.21	65.87	-24.66	20.27	3	0	1.00	-

#### Result

Mode	Result	Type	Freq (Hz)	Level (dBuV/m)	Limit (dBuV/m)	Margin (dB)	Factor (dB)	Dist (m)	Azimuth (°)	Height (m)	Comments
NFC	-	-	-	-	-	-	-	-	-	-	-
13.56MHz_DC Power Supply	Pass	PK	13.56M	78.56	124.00	-45.44	22.72	3	153	1.00	-
13.56MHz_DC Power Supply	Pass	PK	9.564k	44.72	127.96	-83.24	19.42	3	360	1.00	-
13.56MHz_DC Power Supply	Pass	PK	14.358k	40.72	124.44	-83.72	19.69	3	360	1.00	-
13.56MHz_DC Power Supply	Pass	PK	21.126k	37.71	121.08	-83.37	19.97	3	360	1.00	-
13.56MHz_DC Power Supply	Pass	PK	388.8k	49.96	95.80	-45.84	20.19	3	0	1.00	-
13.56MHz_DC Power Supply	Pass	PK	1.225M	41.21	65.87	-24.66	20.27	3	0	1.00	-
13.56MHz_DC Power Supply	Pass	PK	8.21M	42.36	69.50	-27.14	21.81	3	0	1.00	-



NFC Operating below 30MHz

14/01/2020

13.56MHz\_DC Power Supply

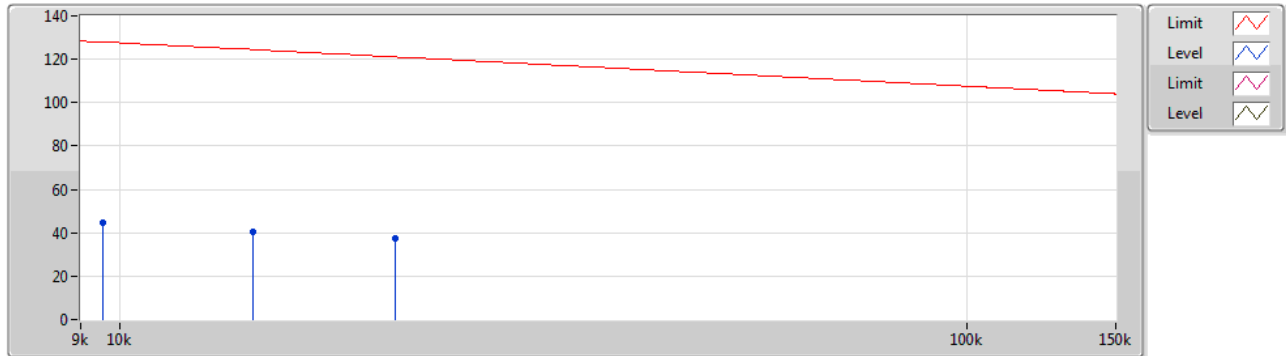

Type	Freq (Hz)	Level (dBuV/m)	Limit (dBuV/m)	Margin (dB)	Factor (dB)	Dist (m)	Condition	Azimuth (°)	Height (m)	Comment	Raw (dBuV)	AF (dB)	CL (dB)	PA (dB)
PK	9.564k	44.72	127.96	-83.24	19.42	3	Horizontal	360	1.00	-	25.30	19.37	0.05	-
PK	14.358k	40.72	124.44	-83.72	19.69	3	Horizontal	360	1.00	-	21.03	19.63	0.06	-
PK	21.126k	37.71	121.08	-83.37	19.97	3	Horizontal	360	1.00	-	17.74	19.91	0.06	-





### NFC Operating below 30MHz

14/01/2020

### 13.56MHz\_DC Power Supply

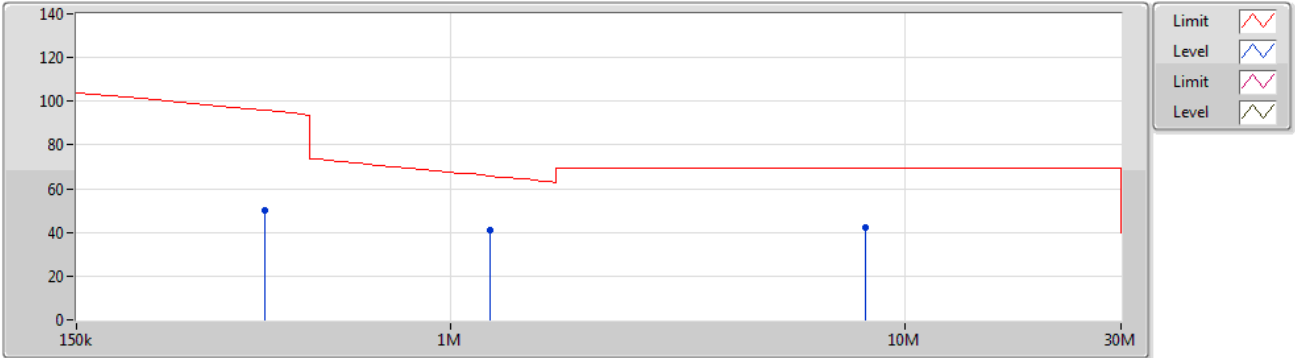

Type	Freq (Hz)	Level (dBuV/m)	Limit (dBuV/m)	Margin (dB)	Factor (dB)	Dist (m)	Condition	Azimuth (°)	Height (m)	Comment	Raw (dBuV)	AF (dB)	CL (dB)	PA (dB)
PK	388.8k	49.96	95.80	-45.84	20.19	3	Horizontal	0	1.00	-	29.77	20.07	0.12	-
PK	1.225M	41.21	65.87	-24.66	20.27	3	Horizontal	0	1.00	-	20.94	20.10	0.17	-
PK	8.21M	42.36	69.50	-27.14	21.81	3	Horizontal	0	1.00	-	20.55	21.42	0.39	-



3.4.6 Transmitter Radiated Unwanted Emissions (Above 30MHz)

Summary

Mode	Result	Type	Freq (Hz)	Level (dBuV/m)	Limit (dBuV/m)	Margin (dB)	Factor (dB)	Dist (m)	Azimuth (°)	Height (m)	Comments
13.553-13.567MHz	-	-	-	-	-	-	-	-	-	-	-
NFC	Pass	QP	365.62M	42.88	46.00	-3.12	-4.18	3	159	1.00	-

Result

Mode	Result	Type	Freq (Hz)	Level (dBuV/m)	Limit (dBuV/m)	Margin (dB)	Factor (dB)	Dist (m)	Azimuth (°)	Height (m)	Comments
NFC	-	-	-	-	-	-	-	-	-	-	-
13.56MHz_DC Power Supply	Pass	PK	66.86M	31.49	40.00	-8.51	-14.92	3	360	1.00	-
13.56MHz_DC Power Supply	Pass	PK	148.34M	25.21	43.50	-18.29	-9.66	3	360	1.00	-
13.56MHz_DC Power Supply	Pass	PK	202.66M	28.77	43.50	-14.73	-10.33	3	360	1.00	-
13.56MHz_DC Power Supply	Pass	PK	311.3M	28.63	46.00	-17.37	-5.34	3	360	1.00	-
13.56MHz_DC Power Supply	Pass	PK	365.62M	34.49	46.00	-11.51	-4.18	3	360	1.00	-
13.56MHz_DC Power Supply	Pass	PK	474.26M	32.56	46.00	-13.44	-1.69	3	360	1.00	-
13.56MHz_DC Power Supply	Pass	PK	66.86M	29.27	40.00	-10.73	-14.92	3	0	1.00	-
13.56MHz_DC Power Supply	Pass	PK	121.18M	29.95	43.50	-13.55	-8.37	3	0	1.00	-
13.56MHz_DC Power Supply	Pass	PK	202.66M	36.75	43.50	-6.75	-10.33	3	0	1.00	-
13.56MHz_DC Power Supply	Pass	PK	474.26M	35.58	46.00	-10.42	-1.69	3	0	1.00	-
13.56MHz_DC Power Supply	Pass	PK	528.58M	32.61	46.00	-13.39	-1.46	3	0	1.00	-
13.56MHz_DC Power Supply	Pass	QP	365.62M	42.88	46.00	-3.12	-4.18	3	159	1.00	-



NFC Operating above 30MHz

14/01/2020

13.56MHz\_DC Power Supply

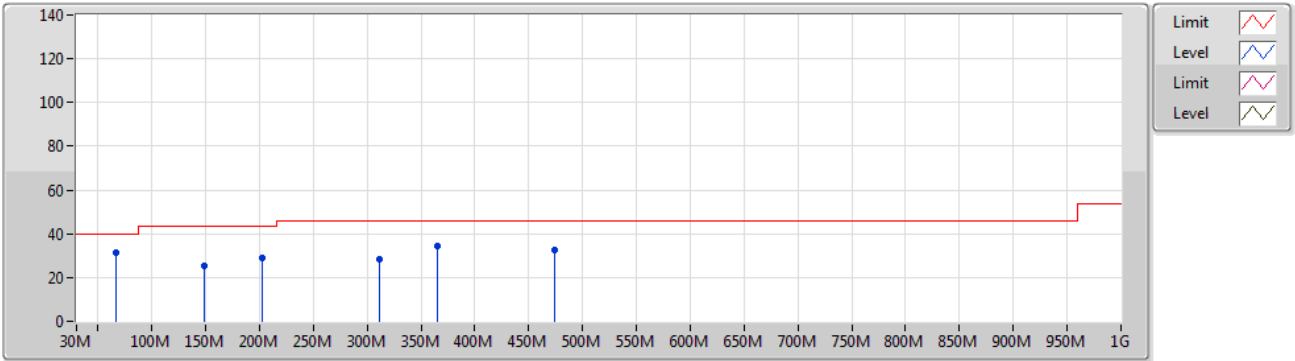

Type	Freq (Hz)	Level (dBuV/m)	Limit (dBuV/m)	Margin (dB)	Factor (dB)	Dist (m)	Condition	Azimuth (°)	Height (m)	Comment	Raw (dBuV)	AF (dB)	CL (dB)	PA (dB)
PK	66.86M	31.49	40.00	-8.51	-14.92	3	Vertical	360	1.00	-	46.41	11.32	1.23	27.47
PK	148.34M	25.21	43.50	-18.29	-9.66	3	Vertical	360	1.00	-	34.87	15.65	1.88	27.19
PK	202.66M	28.77	43.50	-14.73	-10.33	3	Vertical	360	1.00	-	39.10	14.37	2.22	26.92
PK	311.3M	28.63	46.00	-17.37	-5.34	3	Vertical	360	1.00	-	33.97	18.63	2.80	26.77
PK	365.62M	34.49	46.00	-11.51	-4.18	3	Vertical	360	1.00	-	38.67	19.86	3.03	27.07
PK	474.26M	32.56	46.00	-13.44	-1.69	3	Vertical	360	1.00	-	34.25	22.57	3.50	27.76



NFC Operating above 30MHz

14/01/2020

13.56MHz\_DC Power Supply

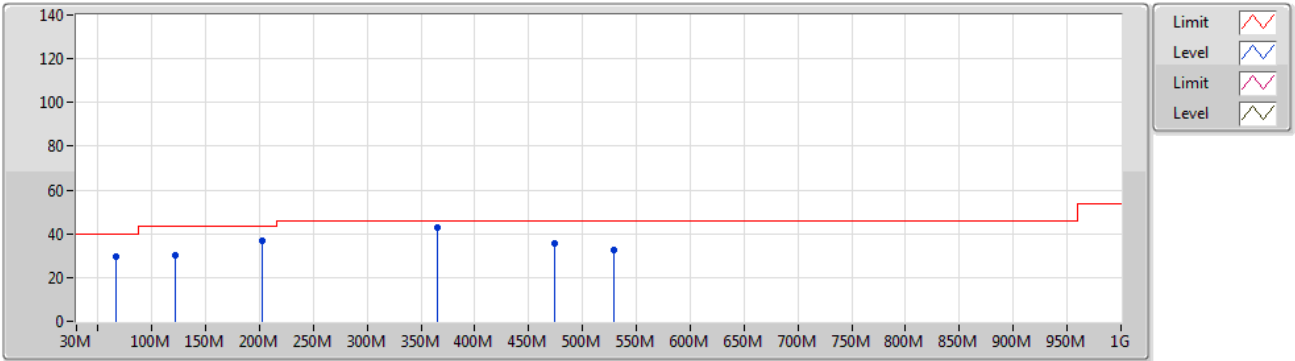

Type	Freq (Hz)	Level (dBuV/m)	Limit (dBuV/m)	Margin (dB)	Factor (dB)	Dist (m)	Condition	Azimuth (°)	Height (m)	Comment	Raw (dBuV)	AF (dB)	CL (dB)	PA (dB)
PK	66.86M	29.27	40.00	-10.73	-14.92	3	Horizontal	0	1.00	-	44.19	11.32	1.23	27.47
PK	121.18M	29.95	43.50	-13.55	-8.37	3	Horizontal	0	1.00	-	38.32	17.25	1.69	27.31
PK	202.66M	36.75	43.50	-6.75	-10.33	3	Horizontal	0	1.00	-	47.08	14.37	2.22	26.92
PK	474.26M	35.58	46.00	-10.42	-1.69	3	Horizontal	0	1.00	-	37.27	22.57	3.50	27.76
PK	528.58M	32.61	46.00	-13.39	-1.46	3	Horizontal	0	1.00	-	34.07	22.79	3.70	27.95
QP	365.62M	42.88	46.00	-3.12	-4.18	3	Horizontal	159	1.00	-	47.06	19.86	3.03	27.07

### 3.5 Frequency Stability

#### 3.5.1 Frequency Stability Limit

Frequency Stability Limit	
<input checked="" type="checkbox"/>	Carrier frequency stability shall be maintained to $\pm 0.01\%$ ( $\pm 100$ ppm).

#### 3.5.2 Measuring Instruments

Refer a test equipment and calibration data table in this test report.

#### 3.5.3 Test Procedures

Test Method	
<input checked="" type="checkbox"/>	Refer as ANSI C63.10, clause 6.8 for frequency stability tests
<input checked="" type="checkbox"/>	Frequency stability with respect to ambient temperature
<input checked="" type="checkbox"/>	Frequency stability when varying supply voltage
<input type="checkbox"/>	For conducted measurement.
<input checked="" type="checkbox"/>	For radiated measurement. The equipment to be measured and the test antenna shall be oriented to obtain the maximum emitted power level.

#### 3.5.4 Test Setup

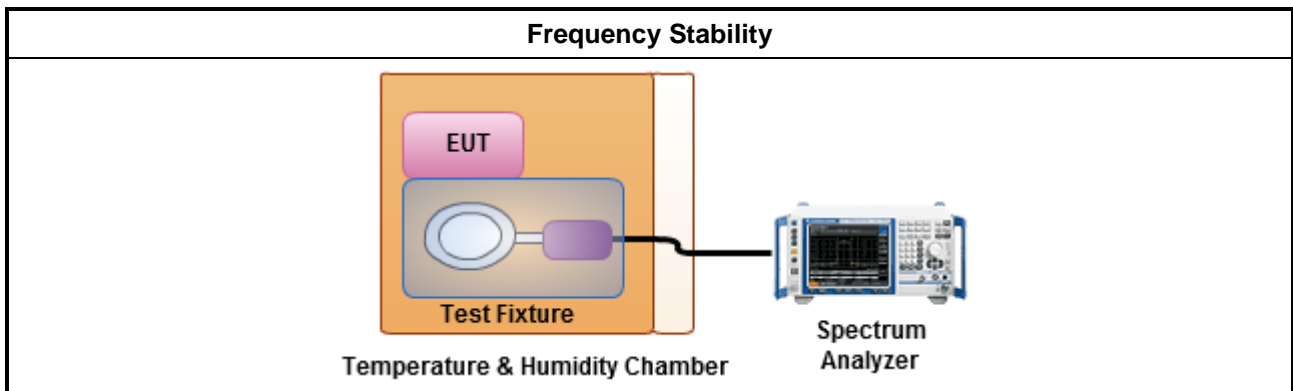



### 3.5.5 Test Result of Frequency Stability

#### Summary

Mode	Result	Ch (Hz)	Center (Hz)	ppm	Limit (ppm)	Port	Remark
13.553-13.567MHz	-	-	-	-	-	-	-
NFC	Pass	13.56M	13.559696M	22.3884	100	1	0 min



Result

Mode	Result	Ch (Hz)	Center (Hz)	ppm	Limit (ppm)	Port	Remark
NFC	-	-	-	-	-	-	-
13.56MHz_-40°C	Pass	13.56M	13.560171M	12.6459	100	1	0 min
13.56MHz_-40°C	Pass	13.56M	13.560173M	12.775	100	1	2 min
13.56MHz_-40°C	Pass	13.56M	13.560173M	12.775	100	1	5 min
13.56MHz_-40°C	Pass	13.56M	13.560172M	12.7104	100	1	10 min
13.56MHz_-30°C	Pass	13.56M	13.560173M	12.775	100	1	0 min
13.56MHz_-30°C	Pass	13.56M	13.560174M	12.8395	100	1	2 min
13.56MHz_-30°C	Pass	13.56M	13.560173M	12.775	100	1	5 min
13.56MHz_-30°C	Pass	13.56M	13.560174M	12.8395	100	1	10 min
13.56MHz_-20°C	Pass	13.56M	13.559915M	6.2584	100	1	0 min
13.56MHz_-20°C	Pass	13.56M	13.559916M	6.1939	100	1	2 min
13.56MHz_-20°C	Pass	13.56M	13.559915M	6.2584	100	1	5 min
13.56MHz_-20°C	Pass	13.56M	13.559915M	6.2584	100	1	10 min
13.56MHz_-10°C	Pass	13.56M	13.559858M	10.4522	100	1	0 min
13.56MHz_-10°C	Pass	13.56M	13.559859M	10.3877	100	1	2 min
13.56MHz_-10°C	Pass	13.56M	13.559858M	10.4522	100	1	5 min
13.56MHz_-10°C	Pass	13.56M	13.559859M	10.3877	100	1	10 min
13.56MHz_0°C	Pass	13.56M	13.55978M	16.259	100	1	0 min
13.56MHz_0°C	Pass	13.56M	13.559776M	16.5171	100	1	2 min
13.56MHz_0°C	Pass	13.56M	13.559775M	16.5816	100	1	5 min
13.56MHz_0°C	Pass	13.56M	13.559776M	16.5171	100	1	10 min
13.56MHz_10°C	Pass	13.56M	13.559774M	16.6461	100	1	0 min
13.56MHz_10°C	Pass	13.56M	13.559773M	16.7107	100	1	2 min
13.56MHz_10°C	Pass	13.56M	13.559774M	16.6461	100	1	5 min
13.56MHz_10°C	Pass	13.56M	13.559773M	16.7107	100	1	10 min
13.56MHz_20°C	Pass	13.56M	13.559727M	20.1302	100	1	0 min
13.56MHz_20°C	Pass	13.56M	13.55973M	19.9367	100	1	2 min
13.56MHz_20°C	Pass	13.56M	13.55973M	19.9367	100	1	5 min
13.56MHz_20°C	Pass	13.56M	13.559731M	19.8076	100	1	10 min
13.56MHz_30°C	Pass	13.56M	13.559763M	17.4849	100	1	0 min
13.56MHz_30°C	Pass	13.56M	13.559761M	17.6139	100	1	2 min
13.56MHz_30°C	Pass	13.56M	13.559761M	17.6139	100	1	5 min



Mode	Result	Ch (Hz)	Center (Hz)	ppm	Limit (ppm)	Port	Remark
13.56MHz_30°C	Pass	13.56M	13.55976M	17.6785	100	1	10 min
13.56MHz_40°C	Pass	13.56M	13.559743M	18.9689	100	1	0 min
13.56MHz_40°C	Pass	13.56M	13.559744M	18.9043	100	1	2 min
13.56MHz_40°C	Pass	13.56M	13.559743M	18.9689	100	1	5 min
13.56MHz_40°C	Pass	13.56M	13.559743M	18.9689	100	1	10 min
13.56MHz_50°C	Pass	13.56M	13.559696M	22.3884	100	1	0 min
13.56MHz_50°C	Pass	13.56M	13.559697M	22.3239	100	1	2 min
13.56MHz_50°C	Pass	13.56M	13.559698M	22.2594	100	1	5 min
13.56MHz_50°C	Pass	13.56M	13.559698M	22.2594	100	1	10 min
13.56MHz_60°C	Pass	13.56M	13.560173M	12.775	100	1	0 min
13.56MHz_60°C	Pass	13.56M	13.560176M	12.9685	100	1	2 min
13.56MHz_60°C	Pass	13.56M	13.560176M	12.9685	100	1	5 min
13.56MHz_60°C	Pass	13.56M	13.560176M	12.9685	100	1	10 min
13.56MHz_70°C	Pass	13.56M	13.560176M	12.9685	100	1	0 min
13.56MHz_70°C	Pass	13.56M	13.560176M	12.9685	100	1	2 min
13.56MHz_70°C	Pass	13.56M	13.560176M	12.9685	100	1	5 min
13.56MHz_70°C	Pass	13.56M	13.560171M	12.5814	100	1	10 min
13.56MHz_80°C	Pass	13.56M	13.560176M	12.9685	100	1	0 min
13.56MHz_80°C	Pass	13.56M	13.560176M	12.9685	100	1	2 min
13.56MHz_80°C	Pass	13.56M	13.560175M	12.904	100	1	5 min
13.56MHz_80°C	Pass	13.56M	13.560176M	12.9685	100	1	10 min
13.56MHz_85°C	Pass	13.56M	13.560176M	12.9685	100	1	0 min
13.56MHz_85°C	Pass	13.56M	13.560176M	12.9685	100	1	2 min
13.56MHz_85°C	Pass	13.56M	13.560176M	12.9685	100	1	5 min
13.56MHz_85°C	Pass	13.56M	13.560177M	13.033	100	1	10 min
13.56MHz_20°C-10.8V	Pass	13.56M	13.559729M	20.0012	100	1	0 min
13.56MHz_20°C-10.8V	Pass	13.56M	13.559729M	20.0012	100	1	2 min
13.56MHz_20°C-10.8V	Pass	13.56M	13.55973M	19.9367	100	1	5 min
13.56MHz_20°C-10.8V	Pass	13.56M	13.55973M	19.9367	100	1	10 min
13.56MHz_20°C-13.2V	Pass	13.56M	13.55973M	19.9367	100	1	0 min
13.56MHz_20°C-13.2V	Pass	13.56M	13.559734M	19.6141	100	1	2 min
13.56MHz_20°C-13.2V	Pass	13.56M	13.559729M	20.0012	100	1	5 min
13.56MHz_20°C-13.2V	Pass	13.56M	13.559729M	20.0012	100	1	10 min



## 4 Test Equipment and Calibration Data

### Instrument for AC Conduction

Instrument	Manufacturer	Model No.	Serial No.	Characteristics	Calibration Date	Calibration Due Date
EMC Receiver	R&S	ESR3	102052	9kHz~3.6GHz	09/Apr/2019	08/Apr/2020
LISN	R&S	ENV216	101295	9kHz~30MHz	04/Nov/2019	05/Nov/2020
RF Cable-CON	MTJ	RG142	CB002-CO	9kHz~200MHz	12/Sep/2019	11/Sep/2020
AC POWER	APC	AFC-11005G	F310050055	47Hz~63Hz 5~300V	NCR	NCR
Impuls Begrenzer Pulse Limiter	SCHWARZBECK	VTSD 9561-F	9561-F041	9kHz~30MHz	24/Sep/2019	23/Sep/2020

**NCR: Non-Calibration required.**

### Instrument for Conducted Test

Instrument	Manufacturer	Model No.	Serial No.	Characteristics	Calibration Date	Calibration Due Date
Spectrum Analyzer	R&S	FSV 40	101029	10KHz~40GHz	01/Oct/2019	30/Sep/2020
Loop Antenna	TESEQ	HLA 6120	31244	9kHz~30MHz	15/Mar/2019	14/Mar/2020

### Instrument for Radiated Test

Instrument	Manufacturer	Model No.	Serial No.	Characteristics	Calibration Date	Calibration Due Date
3m Semi Anechoic Chamber	SIDT FRANKONIA	SAC-3M	03CH03-HY	30MHz~1GHz 3m	30/ Aug/2019	29/ Aug/2020
Amplifier	HP	8447D	2944A08033	10kHz~1.3GHz	22/Apr/2019	21/Apr/2020
EMI Test Receiver	R&S	ESR3	102052	9kHz~3.6GHz	09/Apr/2019	08/Apr/2020
Bilog Antenna & 5dB Attenuator	SCHAFFNER / MTJ	CBL 6112B / MTJ6102-05	2723 / 2	30MHz~2GHz	11/Oct/2019	10/Oct//2020
Signal Analyzer	R&S	FSP40	100305	9kHz~40GHz; -140~+30dBm	10/Jun/2019	09/Jun/2020
RF Cable-R03m	Jye Bao	RG142	CB021	9kHz~1GHz	22/Mar/2019	21/Mar/2020
Loop Antenna	TESEQ	HLA 6120	31244	9k~30MHz	15/Mar/2019	14/Mar/2020