

Owners guide

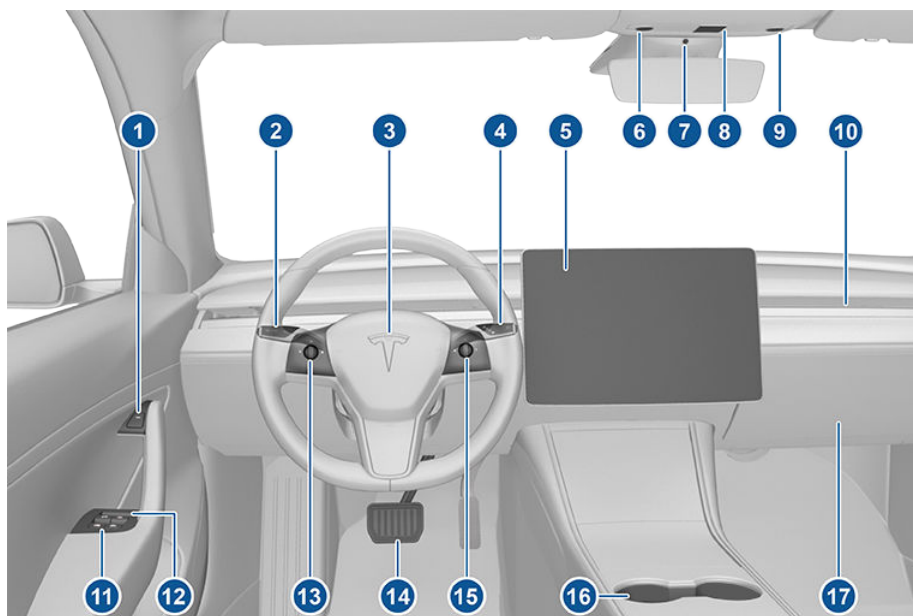

Overview.....	2	Maintenance.....	129
Interior Overview.....	2	Maintenance Schedule.....	129
Exterior Overview.....	3	Tire Care and Maintenance.....	130
Touchscreen Overview.....	4	Cleaning.....	137
Opening and Closing.....	7	Wiper Blades and Washer Jets.....	140
Keys.....	7	Fluid Reservoirs.....	141
Doors.....	12	Jacking and Lifting.....	143
Windows.....	14	Parts and Accessories.....	144
Rear Trunk.....	15	Specifications.....	146
Front Trunk.....	17	Identification Labels.....	146
Interior Storage and Electronics.....	20	Vehicle Loading.....	147
Seating and Safety Restraints.....	24	Dimensions and Weights.....	149
Front and Rear Seats.....	24	Subsystems.....	151
Seat Belts.....	27	Wheels and Tires.....	153
Child Safety Seats.....	30	Roadside Assistance.....	157
Airbags.....	36	Contacting Tesla Roadside Assistance.....	157
Driving.....	40	Instructions for Transporters.....	158
Driver Profiles.....	40	Consumer Information.....	162
Steering Wheel.....	42	Easter Eggs.....	162
Mirrors.....	44	About this Owner Information.....	163
Starting and Powering Off.....	46	Disclaimers.....	164
Gears.....	48	Reporting Safety Defects.....	165
Lights.....	49	Declarations of Conformity.....	166
Car Status.....	52		
Wipers and Washers.....	55		
Brakes.....	56		
Traction Control.....	58		
Park Assist.....	59		
Vehicle Hold.....	61		
Track Mode.....	62		
Getting Maximum Range.....	63		
Rear View Camera.....	64		
Dashcam.....	65		
Autopilot.....	66		
About Autopilot.....	66		
Traffic-Aware Cruise Control.....	69		
Autosteer.....	75		
Autopark.....	79		
Summon.....	81		
Lane Assist.....	84		
Collision Avoidance Assist.....	86		
Speed Assist.....	89		
Using the Touchscreen.....	91		
Controls.....	91		
Climate Controls.....	98		
Maps and Navigation.....	103		
Media and Audio.....	108		
Phone.....	111		
Calendar.....	113		
Using Voice Commands.....	114		
Security Settings.....	115		
HomeLink / Universal Transceiver.....	116		
Connecting to Wi-Fi.....	118		
Software Updates.....	119		
Charging.....	120		
Electric Vehicle Components.....	120		
Battery Information.....	122		
Charging Instructions.....	124		



1. Door open button ([Opening Doors from the Interior](#) on page 12)
2. High beams ([High Beam Headlights](#) on page 50), turn signals ([Turn Signals](#) on page 51), and wipers and washers ([Wipers and Washers](#) on page 55)
3. Horn ([Horn](#) on page 43)
4. Gear selector ([Shifting Gears](#) on page 48), Traffic-Aware Cruise Control ([Traffic-Aware Cruise Control](#) on page 69), and Autosteer ([Autosteer](#) on page 75)
5. Touchscreen ([Touchscreen Overview](#) on page 4)
6. Driver dome light ([Lights](#) on page 49)
7. Cabin camera ([Cabin Camera](#) on page 23)
8. Hazard warning flashers ([Hazard Warning Flashers](#) on page 51)
9. Passenger dome light ([Lights](#) on page 49)
10. Climate control vent (see [Climate Controls](#) on page 98)
11. Power window switches ([Windows](#) on page 14)
12. Manual door release ([Opening Doors from the Interior](#) on page 12)
13. Left scroll button ([Scroll Buttons](#) on page 42)
14. Brake pedal ([Brakes](#) on page 56)
15. Right scroll button ([Scroll Buttons](#) on page 42)
16. Center console ([Interior Storage and Electronics](#) on page 20)
17. Glovebox ([Glovebox](#) on page 20)

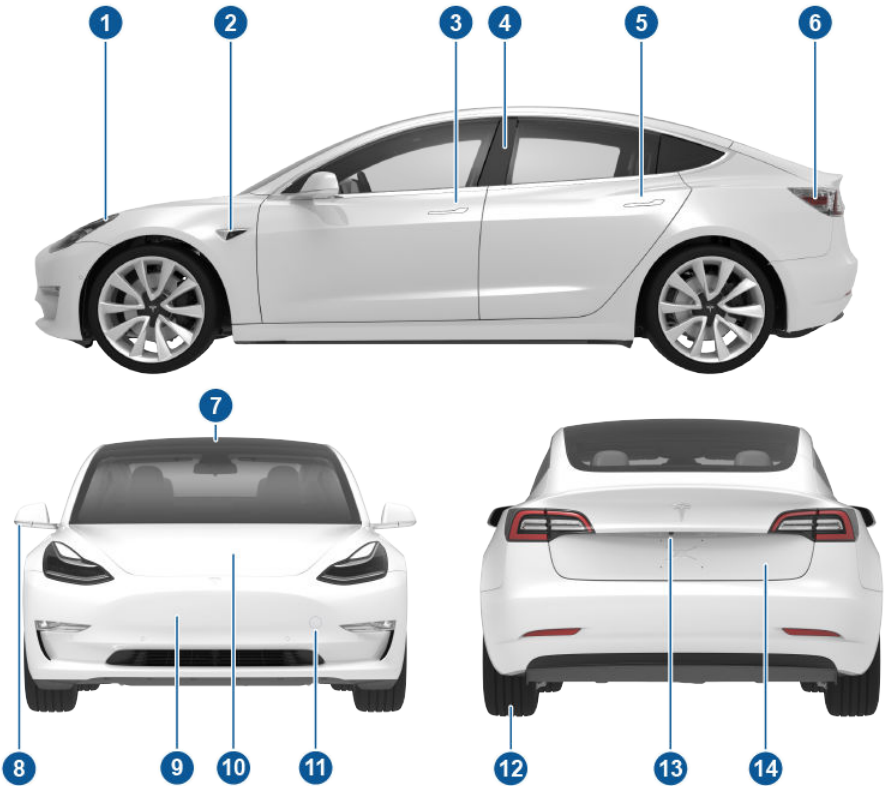

1. Exterior lights ([Lights](#) on page 49)
2. Autopilot camera ([About Autopilot](#) on page 66)
3. Front door handle ([Using Exterior Door Handles](#) on page 12)
4. Key card sensor ([Keys](#) on page 7), Autopilot camera ([About Autopilot](#) on page 66)
5. Rear door handle ([Using Exterior Door Handles](#) on page 12)
6. Charge port ([Charging Instructions](#) on page 124)
7. Autopilot cameras ([About Autopilot](#) on page 66)
8. Exterior mirrors ([Mirrors](#) on page 44)
9. Radar sensor (hidden from view) ([About Autopilot](#) on page 66)
10. Hood/front trunk ([Front Trunk](#) on page 17)
11. Tow eye cover ([Instructions for Transporters](#) on page 158)
12. Wheels and tires ([Wheels and Tires](#) on page 153)
13. Rear view camera ([Rear View Camera](#) on page 64)
14. Rear trunk ([Rear Trunk](#) on page 15)



Touchscreen Overview

The features and information you need to drive Model 3 are displayed on the touchscreen. When driving, the touchscreen displays driving-related information such as driving speed, vehicle range, warnings, etc. The touchscreen is used to control many features that, in traditional cars, are controlled using physical buttons (for example, adjusting mirrors). You can also use the touchscreen to customize Model 3 to suit your preferences.

Warning: Always pay attention to road and traffic conditions when driving. To minimize driver distraction and ensure the safety of vehicle occupants as well as other road users, avoid using the touchscreen to adjust settings while the vehicle is in motion.

Note: The image below is provided for demonstration purposes only. Depending on vehicle options, software version and market region, your touchscreen may appear slightly different.

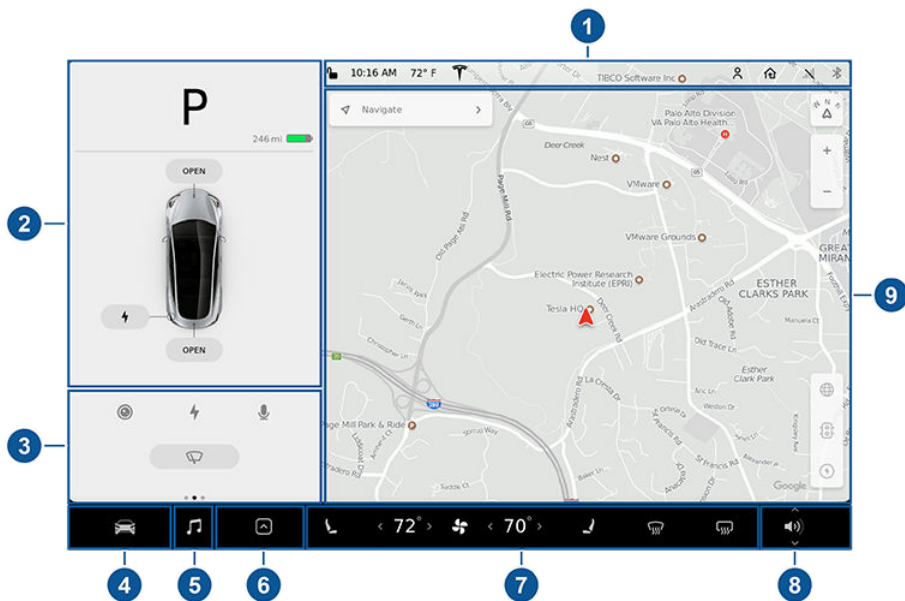

1. This area on the top of the touchscreen displays the time and provides shortcut to lock/unlock the vehicle, access vehicle information (the Tesla "T"), choose or set up a driver profile (see [Driver Profiles](#) on page 40), control HomeLink devices (if equipped) (see [HomeLink Universal Transceiver](#) on page 116), view network strength, and connect to Wi-Fi (see [Connecting to Wi-Fi](#) on page 118) and Bluetooth devices (see [Pairing a Bluetooth Phone](#) on page 111). If you see an exclamation mark, touch it to see warning messages that are in effect. If you see a yellow clock icon, a software update is available (see [Software Updates](#) on page 119).

Note: An airbag status symbol displays in the top right corner of the touchscreen only when Model 3 is powered on, ready to drive, and the airbag is turned off (see [Airbags](#) on page 36).

2. Car Status. This area dynamically displays the current status of Model 3 as you drive, park, open doors, turn lights on, etc. Monitor this area when driving as it displays important information such as driving speed and warning messages (see [Car Status](#) on page 52). When the car is in Park, you can open the trunks or charge port door.
3. Cards. This area automatically updates to display information such as incoming calls, seat belt reminders, current state of the wipers, etc. It also provides easy access to the rear view camera (see [Rear View Camera](#) on page 64), charging status (see [Charging Instructions](#) on page 124), voice commands (see [Using Voice Commands](#) on page 114), wiper controls (see



[Wipers](#) on page 55), and seat belt reminders (see [Seat Belt Reminders](#) on page 27). Swipe to the right or left to access:

- Trips. You can display distance driven, energy usage and energy efficiency starting at any time, or since Model 3 was last charged. You can also display this information for up to two trips. Touch ... in the top right corner of a trip to rename or reset a trip.
 - Tire Pressures. Display tire pressures or view cautions or warnings related to pressures that are not within acceptable limits (see [Tire Care and Maintenance](#) on page 130).
4. Controls. Touch to control features and customize Model 3 to suit your preferences (see [Controls](#) on page 91).
 5. Media Player (see [Media and Audio](#) on page 108).
 6. Touch the app launcher then choose from the following apps:

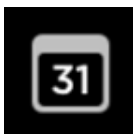

Calendar. See [Calendar](#) on page 113.



Energy. See [Getting Maximum Range](#) on page 63.



Web. Access the Internet using the web browser (if available and equipped with premium connectivity).



Camera. Display the area behind Model 3. This area also displays automatically whenever you shift into Reverse. See [Rear View Camera](#) on page 64.



Call. See [Phone](#) on page 111.

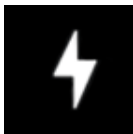

Charging. See [Charging Instructions](#) on page 124.

Note: Swiping up on the app launcher displays the most recently used app (provided an app is not currently being displayed).

Note: Depending on the market region and vehicle options, your vehicle may not be equipped with some features.



7. Climate Controls (see [Climate Controls](#) on page 98).
8. Volume Control (see [Volume Control](#) on page 108).
9. The map displays on the touchscreen at all times (see [Maps and Navigation](#) on page 103).

Note: When you touch **Controls**, choose an app, or expand Media Player, the window displays on top of the map. To close the Controls window, touch **Controls** again or touch the **X** in the top corner of the window. To close an app, touch the **X** in the top corner of the window. To close Media Player, drag it all the way down to the bottom of the touchscreen or touch the icon again.

The Tesla "T"

Touch the Tesla "T" at the top center of the touchscreen to display:

- Vehicle name (see [Naming Your Vehicle](#) on page 96).
- Battery size.
- Odometer.
- Vehicle Identification Number (VIN).
- Version of software currently installed on your Model 3.
- Release notes associated with the currently-installed software version.
- This owner's manual.
- One-touch access to call Tesla Customer Support and Roadside Assistance.
- One-touch access to all discovered Easter Eggs (see [Easter Eggs](#) on page 162).



Three Types of Keys

Model 3 supports three types of keys:

- **Authenticated phone** - You can set up your personal smartphone to communicate with Model 3 using Bluetooth. Supports automatic locking and unlocking as well as several other functions using the Tesla mobile app. An authenticated phone is the preferred key because you never need to remove it from your pocket or purse.
- **Key card** - Tesla provides a key card that communicates with Model 3 using short range radio-frequency identification (RFID) signals. The key card is used to "authenticate" your phone to work with Model 3 and to add or remove other key cards, phones, or key fobs. In situations where your authenticated phone has a dead battery, or is lost or stolen, use your key card to unlock, drive, and lock Model 3.
- **Key fob** - An accessory sold separately, similar to a traditional key fob, that allows you to press buttons to open the front and rear trunks, and unlock, lock, and drive Model 3.

A Model 3 supports a total of 19 keys, which can include authenticated phones, key cards, and up to four key fobs.

- ⚠ Caution:** Remember to bring a key with you when you drive. Although you can drive Model 3 away from its key, you will be unable to power it back on after it powers off.

Authenticated Phone

Using your phone is the most convenient way to access your Model 3. As you approach, your phone's Bluetooth signal is detected and doors unlock when you press a door handle. Likewise, when you exit and walk away with the phone, doors automatically lock (provided the **Walk-Away Door Lock** feature is turned on, as described in [Walk-Away Door Lock](#) on page 13).

Before you can use a phone to access Model 3, follow these steps to authenticate it:

1. Download the Tesla mobile app to your phone.

2. Log into the Tesla mobile app using your Tesla Account user name and password.

Note: You must remain logged in to your Tesla Account to use your phone to access Model 3.

3. Ensure that your phone's Bluetooth setting is turned on.

Note: Model 3 communicates with your phone using Bluetooth. To authenticate your phone or use it as a key, the phone must be powered on and Bluetooth must be enabled. Keep in mind that your phone must have enough battery power to run Bluetooth and that many phones disable Bluetooth when the battery is low.

4. Ensure that Allow Mobile Access (**Controls** > **Safety & Security** > **Allow Mobile Access**) is enabled.
5. In the Tesla mobile app, touch **PHONE KEY** then touch **START** to search for your Model 3.

When your Model 3 is detected, the mobile app asks you to tap your key card.

6. Tap the key card against the Model 3 card reader on the door pillar or center console (see [Key Card](#) on page 8).

When Model 3 detects your key card, the mobile app confirms that your phone has been successfully authenticated. Touch **DONE**.

If the key card is not successfully scanned within approximately 30 seconds, the mobile app displays an error message. Touch **PHONE KEY** on the app again to retry.

To view a list of keys that can currently access Model 3, or to remove a phone, touch **Controls** > **Locks** (see [Managing Keys](#) on page 10).

Note: Authenticating your phone allows you to use it as a key to access Model 3. To use the phone hands-free, access your phone's contacts, play media from it, etc., you must also pair and connect to it using the Bluetooth settings (see [Phone](#) on page 11).

Note: Model 3 can connect to three phones simultaneously. Therefore, if more than one phone is detected and you want to use, or authenticate, a different phone, move the other connected phone(s) out of range or turn off its Bluetooth setting.

Note: Unlike the mobile app, once a phone has been authenticated, it no longer requires an internet connection to communicate with Model 3. Authenticated phones communicate with Model 3 using Bluetooth.



Note: Although Bluetooth typically communicates over distances of up to approximately 9 meters, performance can vary based on the phone you are using, environmental interference, etc.

Note: If multiple vehicles are linked to the Tesla Account, you must switch the mobile app to the Model 3 that you want to access before you can use the phone as a key.

Key Card

Tesla provides you with two Model 3 key cards, designed to fit in your wallet. Model 3 reads a key card only when placed within very close proximity (a few cm) to one of its card readers. Card readers are located on the driver's side door pillar and on the center console.

To use a key card to unlock or lock Model 3, position the card as illustrated and tap it against the card reader located below the Autopilot camera on the driver's side door pillar. When Model 3 detects the key card, the exterior lights flash, the mirrors unfold or fold (if equipped with the premium package and Fold Mirrors is on), and the doors unlock or lock.

Note: You may need to physically touch the driver's side door pillar with the key card, and you may need to hold it against the transmitter for one or two seconds.

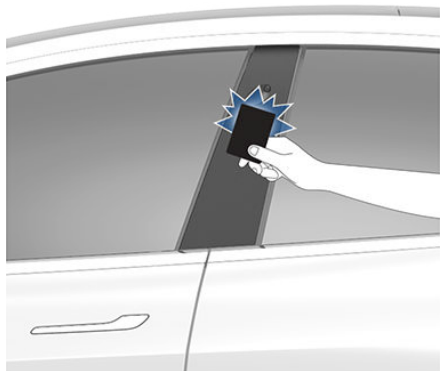

Once inside, power up Model 3 by pressing the brake pedal within two minutes of scanning the key card (see [Starting and Powering Off](#) on page 46). If you wait longer than two minutes, you must re-authenticate by placing the key card near the card reader located behind the cup holders on the center console. When your key card is detected, your two minute authentication period restarts.

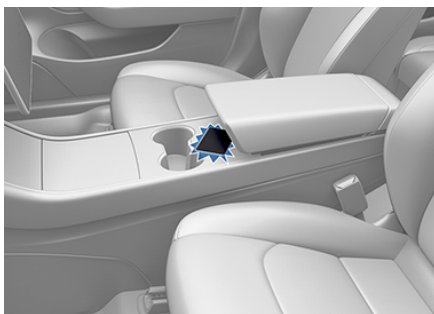

Note: You must position the key card within an inch or two of a card reader to allow Model 3 to read it. You may need to physically touch the center console or driver's side door pillar with the key card, and you may need to hold it against the transmitter for one or two seconds.

Note: Walk-Away Door Lock operates only when using an authenticated phone. When you walk away from Model 3 carrying your key card, Model 3 does not automatically unlock/lock, even if this feature is turned on (see [Walk-Away Door Lock](#) on page 13).

⚠ Caution: Always carry your key card with you in your purse or wallet to use as a backup in case your authenticated phone has a dead battery, or is lost or stolen.

Key fob

If you have purchased the key fob accessory (available for purchase from Tesla stores or online at www.tesla.com/shop), you can quickly familiarize yourself with this key by thinking of it as a miniature version of Model 3, with the Tesla badge representing the front. The key has three buttons that feel like softer areas on the surface.



1. Front trunk - Double-click to open the front trunk.
2. Lock/Unlock All - Single-click to lock doors and trunks (all doors and trunks must be closed). Double-click to unlock doors and trunks.
3. Trunk - Double-click to open the rear trunk. Hold down for one to two seconds to open the charge port door.

Once inside, power up Model 3 by pressing the brake pedal within two minutes of pressing the unlock button on the key fob (see [Starting and Powering Off](#) on page 46). If you wait longer than two minutes, you must press the unlock button again, or place the key fob near the card reader located behind the cup holders on the center console. When your key fob is detected, the two minute authentication period restarts.

When approaching or leaving Model 3 carrying the key fob, you do not need to point the key fob at Model 3 as you press a button, but you must be within operating range.

Radio equipment on a similar frequency can affect the key. If this happens, move the key at least 30 cm away from other electronic devices (phone, laptop, etc).

If the key fob does not work (for example, its battery is dead), you can touch its flat side against the card reader on the driver's side door pillar (like the key card). Instructions for changing the battery are provided below.

Note: Walk-Away Door Lock operates only when using an authenticated phone. When you walk away from Model 3 carrying your key fob, Model 3 does not automatically unlock/lock, even if this feature is turned on (see [Walk-Away Door Lock](#) on page 13).

Note: You can use the same key fob with multiple Model 3 vehicles provided you authenticate it (see [Managing Keys](#) on page 10). However, key fob works with only one Model 3 at a time. Therefore, to use a key fob for a different Model 3, touch its flat side against the card reader on the driver's side door pillar.

Note: A Model 3 supports up to four different key fobs.

⚠ Caution: Protect the key from impact, high temperatures, and damage from liquids. Avoid contact with solvents, waxes and abrasive cleaners.

Replacing the Key Fob Battery

Under normal use, the key fob battery lasts for approximately five years. When the battery is low, a message displays on the touchscreen.

To replace the key fob battery:

1. With the key fob placed button side down on a soft surface, release the bottom cover.



2. Remove the battery by lifting it away from the retaining clips.





3. While avoiding touching the battery's flat surfaces, insert the new battery (type CR2032) with the '+' side facing up.

Note: CR2032 batteries can be purchased through online retailers, local supermarkets, and drug stores.

4. Holding the bottom cover at an angle, align the tabs on the cover with the corresponding slots on the key fob, then press the cover firmly onto the key fob until it snaps into place.

Attaching a Lanyard

To attach a lanyard, release the bottom cover as described above. Place the lanyard over the pin located between the slots on the widest side of the key fob. Re-align the cover and snap into place.

Managing Keys

To display a key list that shows all keys (phones, key cards, and key fobs) that can access your Model 3, touch **Controls** > **Locks**. An icon displays next to each key to indicate whether the key is a phone, key card or key fob. Use this list to view, add or delete keys. To add or delete keys, you will need a key card that has already been authenticated.

To add a new key, touch **+**, then follow the onscreen prompts. When complete, the key list displays the new key. If the key is a phone, the key list displays the name of the phone. If the key is a card or key fob, you can customize its name by touching the associated pencil icon.

Note: Key fob pairing should be performed when the key fob is at room temperature. Pairing may be unsuccessful if the key fob is cold.

Note: To add a phone, the phone must be running the Tesla mobile app and connected to a Tesla account, and Bluetooth must be enabled. You can also use the mobile app to add a phone key. For details, see [Authenticated Phone](#) on page 7).

Note: You can use the same key for more than one Model 3. This prevents you from having to deal with multiple keys when you switch vehicles. If you customize the name of an authenticated key card or key fob on one Model 3, any other Model 3 to which the key card or key fob is authenticated also displays the customized name.

When you no longer want a key to access your Model 3 (for example, you lost your phone or key card, etc.), touch its associated trash icon on the key list, then follow the onscreen prompts to confirm the deletion. When complete, the key list no longer includes the deleted key.

Note: Model 3 requires at least one authenticated key card at all times. If only one key card is included on the key list, this key cannot be deleted.

Note: Model 3 supports up to 19 keys. When this limit is reached, you must delete a key before adding a new one.

Mobile App

In addition to using it to authenticate a phone as your Model 3 key, you can use the mobile app to communicate with Model 3 remotely using your iPhone® or Android™ phone. With this app, you can:

- View the vehicle's estimated range.
- Lock or unlock Model 3 doors and trunks remotely.
- Check charging progress, stop charging, and receive notifications when charging is started, interrupted, almost complete, or complete.

Note: When Supercharging, additional notifications alert you when you will be charged idle fees for parking at a supercharger after charging is complete. The idle fees are waived if your vehicle is moved within five minutes of when the vehicle finishes charging. See [Supercharger Usage Fees and Idle Fees](#) on page 127.

- Check the interior temperature and heat or cool the cabin before driving (even if it's in a garage).
- Locate Model 3 with directions, or monitor its movement across a map.
- Flash the exterior lights or honk the horn to find Model 3 when parked.
- Enable/disable Valet mode.
- Start Model 3 remotely.
- Park or unpark Model 3 using Summon.
- Enable/disable Speed Limit Mode and receive notifications when the vehicle's driving speed is within approximately 5 km/h of your selected maximum speed (see [Speed Limit Mode](#) on page 96).
- Support the Model 3 Calendar app by allowing the mobile app to send your phone's calendar data to Model 3.



- Receive notifications if the security alarm is triggered.
- Receive notifications when a software update is available or scheduled (see [Software Updates](#) on page 119).
- Start software updates from afar.
- Access your Tesla inbox and Loot Box.
- View the odometer, VIN, and current software version.

Note: To allow the mobile app to communicate with Model 3, the phone must be connected to the internet and mobile access must be enabled (touch **Controls > Safety & Security > Allow Mobile Access** on the touchscreen).

Note: If multiple vehicles are linked to the Tesla Account, you must switch to the Model 3 that you want to access in the mobile app before the phone can be used as a key.

Note: To take advantage of new and improved features, download updated versions of the mobile app as they become available.

 **Caution:** Tesla does not support the use of third party applications to contact Model 3.

Note: The above list may not represent an exhaustive list of the functions available on the Tesla mobile app. To ensure access to new and improved features, download updated versions of the mobile app as they become available.



Keyless Locking and Unlocking

Locking and unlocking Model 3 is easy and convenient. Just carry your authenticated phone with you. Model 3 recognizes the presence of an authenticated phone and automatically unlocks when you press a door handle, and locks when you leave (see [Walk-Away Door Lock](#) on page 13).

Note: If you don't have your authenticated phone with you (or if the phone's battery is dead or its Bluetooth setting is turned off), place the key card against the driver's side door pillar to manually unlock or lock Model 3 (see [Keys](#) on page 7).

Note: You can also purchase a key fob accessory (www.tesla.com/shop) which is similar to a traditional key fob that allows you to press buttons to lock and unlock Model 3.

Note: Walk-Away Door Lock operates only when using an authenticated phone. When you walk away from Model 3 carrying a key card or the key fob accessory, Model 3 does not automatically unlock/lock, even if this feature is turned on (see [Walk-Away Door Lock](#) on page 13).

Using Exterior Door Handles

Use your thumb to push the wide part of the door handle. The handle pivots toward you, and you can open the door by pulling the handle or pulling the edge of the door.



The handle retracts automatically.



When a door or trunk is open, the touchscreen displays the Door Open indicator light.

Opening Doors from the Interior

Model 3 doors are electrically powered. To open a door while sitting inside, press the button located at the top of the interior door handle.

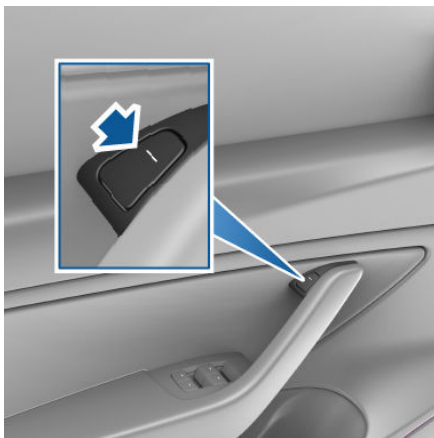

Note: To prevent children from opening the rear doors, turn on child-protection locks (see [Child-Protection Lock](#) on page 13).

In the unlikely situation that Model 3 has no power, these electrically powered buttons at the top of the door handles no longer work. Instead, pull up the manual door release located in front of the window switches on the front doors.

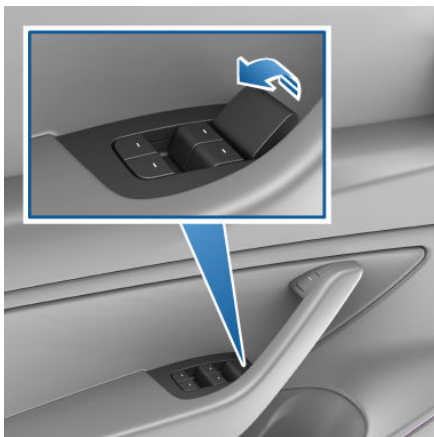

Note: Only front doors are equipped with a manual door release.



- ⚠ Caution:** The manual door release is designed to be used only in situations when Model 3 has no power. Whenever Model 3 has power, use the button located at the top of the interior door handle.

Interior Locking and Unlocking

While sitting inside Model 3, you can lock and unlock all doors and trunks by touching the lock icon on the touchscreen.



The icon changes to indicate whether doors are locked or unlocked.

You can also unlock the doors by pressing the Park button on the end of the gear selector a second time. Pressing this button once engages the Park gear and pressing it again unlocks the doors.

Walk-Away Door Lock

Doors and trunks can automatically lock whenever you walk away carrying your authenticated phone. To turn this feature on or off, touch **Controls > Locks > Walk-Away Door Lock**.

When the doors lock, the exterior lights flash once and the mirrors fold (if equipped with the premium package and Fold Mirrors is on). To also hear a confirmation sound whenever Model 3 locks, touch **Controls > Locks > Lock Confirmation Sound > ON**.

Model 3 does not automatically lock if:

- An authenticated phone is detected inside Model 3.
- You are not using an authenticated phone as the key and walk away carrying the key card or key fob. When using the key card you must manually lock Model 3 by tapping the key card against the door pillar. When using the key fob (sold as an accessory), you must manually lock Model 3 by pressing the lock button. See [Keys](#) on page 7.
- A door or trunk is not fully closed.

Note: If all doors are closed and Model 3 was automatically unlocked by your authenticated phone, walk-away locking is temporarily suspended for one minute. If you open a door within this minute, it will not re-lock until all the doors are closed and you have walked away with the authenticated phone.

Child-Protection Lock

Model 3 has child-protection locks on the rear doors to prevent them from being opened using the interior release buttons. On the touchscreen, touch **Controls > Locks > Child Lock**.

Note: It is recommended that you turn child-protection locks on whenever children are seated in the rear seats.

Unlock on Park

When you stop Model 3 and engage the Park gear, you can choose to unlock all doors. To turn this feature on or off, touch **Controls > Locks > Unlock on Park**.

Note: If set to **OFF**, you can unlock all doors by pressing the Park button a second time after engaging the Park gear.



Opening and Closing

Press down on a switch to lower the associated window. Window switches operate at two levels:

- To lower a window fully, press the switch all the way down and immediately release.
- To lower a window partially, press the switch gently and release when the window is where you want it.

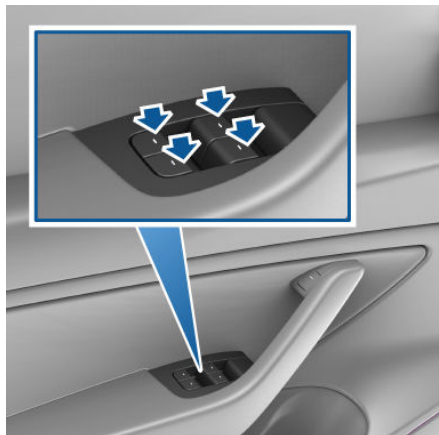

Similarly, pull a switch to raise the associated window:

- To raise a window fully, pull the switch all the way up and immediately release.
- To raise a window partially, pull the switch gently and release when the window is where you want it.

Warning: Before closing a window, it is the driver's responsibility to ensure that all occupants, especially children, do not have any body parts extended through the window's opening. Failure to do so can cause serious injury.

Locking Rear Windows

To prevent passengers from using the rear window switches, touch **Controls > Quick Controls > Window Lock**. To unlock the rear windows, touch **Window Lock** again.

Warning: To ensure safety, it is recommended that you lock the rear window switches whenever children are seated in the rear seats.

Warning: Never leave children unattended in Model 3.



Opening

To open the rear trunk, do one of the following then pull the rear trunk open:

- Touch the associated **OPEN** button on the touchscreen.
- Double-click the rear trunk button on the keyfob accessory.
- Touch the trunk button on the mobile app.
- With Model 3 unlocked, press the switch located under the rear trunk's exterior handle.

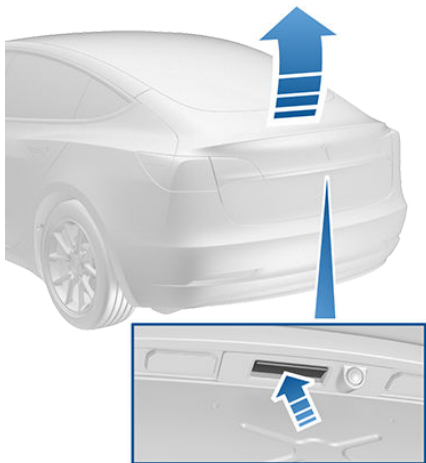

When a door or trunk is open, the touchscreen displays the Door Open indicator light.

To open the trunk from inside Model 3 in the unlikely situation that Model 3 has no power, see [Interior Emergency Trunk Release](#) on page 16.

Warning: Before opening or closing the rear trunk, it is important to check that the area around the trunk is free of obstacles (people and objects).

Load Limits

Secure all cargo before moving Model 3, and place heavy cargo in the lower trunk compartment.

Caution: To avoid damage, never load more than 130 lbs (60 kg) on the rear load floor (above the lower trunk compartment) or more than 285 lbs (130

kg) in the lower trunk compartment. Doing so can cause damage.

Closing

To close the rear trunk, push it downward until you hear the latch click into place.

Note: Model 3 is equipped with pull cups to assist with lowering the rear trunk.



Warning: Before driving, ensure that the trunk is securely latched in the fully-closed position by lifting up on the bottom edge and confirming there is no movement.

Accessing the Cargo Area

To access the cargo area inside the rear trunk, pull up the strap at the rear of the cargo cover. You can then fold the cargo cover forward or remove it from Model 3.



Caution: Never load more than 130 lbs (60 kg) on the rear load floor (above the lower trunk compartment) or more than 285 lbs (130 kg) in the lower trunk compartment. Doing so can cause damage.



Interior Emergency Trunk Release

An illuminated mechanical release located inside the rear trunk allows you to open the rear trunk from the inside if Model 3 has no electrical power. This mechanical release also allows a person locked inside to get out.

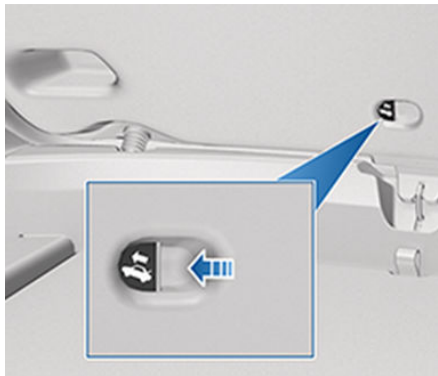

1. Firmly push the illuminated button in the direction of the arrow to release the latch.
2. Push the rear trunk open.

Note: The button glows for several hours after a brief exposure to ambient light.

Warning: Do not allow children to play inside the trunk or become locked inside. An unrestrained child could suffer serious injury or death in a crash. A child could suffer heat exhaustion if trapped in the vehicle, especially without climate control on.



Opening

To open the front trunk:

1. Ensure that the area around the hood is free of obstacles.
2. Touch the associated **OPEN** button on the touchscreen, double-click the front trunk button on the keyfob accessory, or touch the front trunk button on the mobile app.
3. Pull the hood up.

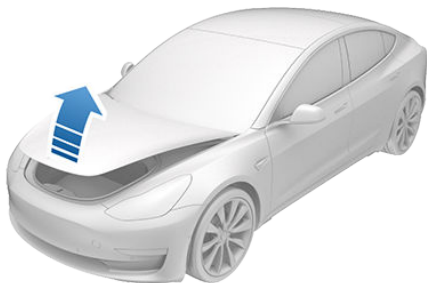

When a door or trunk is open, the touchscreen displays the Door Open indicator light.

Warning: Before opening or closing the hood, it is important to check that the area around the hood is free of obstacles (people and objects). Failure to do so may result in damage or serious injury.

Note: The front trunk locks whenever closed and you lock Model 3 using the touchscreen, mobile app, key card, you leave Model 3 carrying your authenticated phone (if Walk-Away Door Lock is turned on), or if Valet mode is active (see [Valet Mode](#) on page 40).

Closing

The Model 3 hood is not heavy enough to latch under its own weight and applying pressure on the front edge or center of the hood can cause damage.

To properly close the hood:

1. Lower the hood until the striker touches the latches.
2. Place both hands on the front of the hood in the areas shown (in green), then press down firmly to engage the latches.
3. Carefully try to lift the front edge of the hood to ensure that it is fully closed.

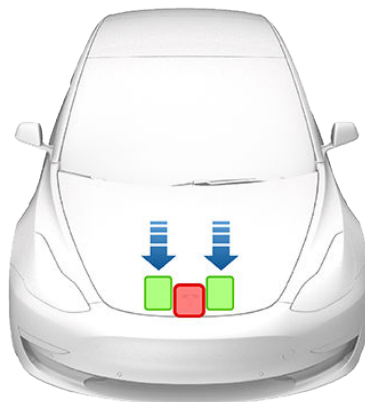

Caution: To prevent damage:

- Apply pressure only to the green areas shown. Applying pressure to the red areas can cause damage.
- Do not close the hood with one hand. Doing so applies concentrated force in one area and can result in a dent or crease.
- Do not apply pressure to the front edge of the hood. Doing so can crease the edge.
- Do not slam or drop the hood.

Warning: Before driving, you must ensure that the hood is securely latched in the fully closed position by carefully trying to lift the front edge of the hood upward and confirming there is no movement.

Interior Emergency Release

An illuminated interior release button inside the front trunk allows a person locked inside to get out.





Press the interior release button to open the front trunk, then push up on the hood.

Note: The interior release button glows following a brief exposure to ambient light.

- Warning:** People should never climb inside the front trunk. Never shut the front trunk when a person is inside.
- Warning:** Care should be taken to ensure that objects inside the front trunk do not bump against the release button, causing the trunk to accidentally open.

Opening with No Power

In the unlikely event that Model 3 has no 12V power, you will be unable to open the front trunk using the touchscreen or mobile app. To open the front trunk in this situation:

Note: The following will not open the front trunk if Model 3 is locked and has 12V power.

1. Locate an external 12V power supply (such as a portable jump starter).
2. Release the tow eye cover by pressing firmly on the top right perimeter of the cover until it pivots inward, then gently pulling the raised section toward you.

Note: The tow eye cover is connected to the vehicle's black negative (-) terminal.

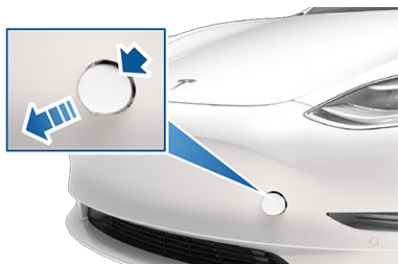

3. Pull the two wires out of the tow eye opening to expose both terminals.

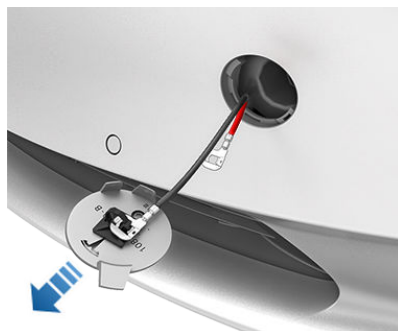

4. Connect the 12V power supply's red positive (+) cable to the red positive (+) terminal.
5. Connect the 12V power supply's black negative (-) cable to the black negative (-) terminal.

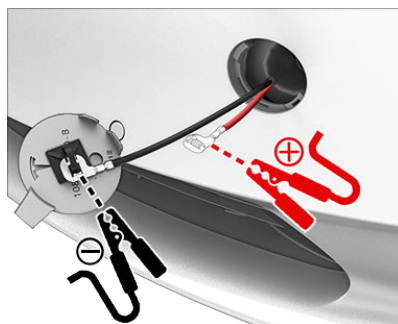

Note: Applying external 12V power to these terminals only releases the hood latches. You cannot charge the 12V battery using these terminals.

6. Turn on the external power supply (refer to the manufacturer's instructions). The hood latches are immediately released and you can now open the hood to access the front trunk area.
7. Disconnect both cables, beginning with the black negative (-) cable.



8. If pulling Model 3 onto a flatbed truck, do not replace the tow eye cover yet. Otherwise, replace the tow eye cover by inserting the wires into the tow eye opening and aligning the tow eye cover into position and turning it into place.

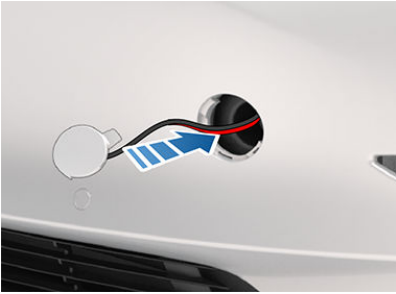



Glovebox

To open the glovebox, touch **Controls** > **Glovebox** on the bottom corner of the touchscreen. The glovebox automatically opens and its light turns on.

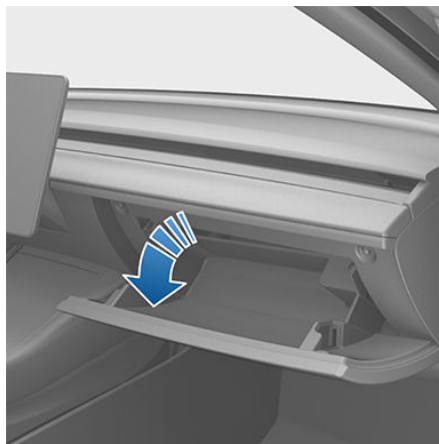

To close the glovebox, push it upward until it clicks into its closed position.

Note: If you leave the glovebox open for approximately five minutes, its light automatically turns off.

Note: The glovebox locks whenever closed and you lock Model 3 using the mobile app, key card, you leave Model 3 carrying your authenticated phone (if Walk-Away Door Lock is turned on), or if Valet mode is active (see [Valet Mode](#) on page 40). It does not lock when Model 3 is locked by touching the lock icon on the touchscreen.

Warning: When driving, keep the glovebox closed to prevent injury to a passenger if a collision or sudden stop occurs.

Center Console - Premium Package

In addition to housing an RFID transmitter that reads the key card (see [Key Card](#) on page 8), the center console includes cup holders, two storage compartments, and a phone dock for two phones (or other devices).

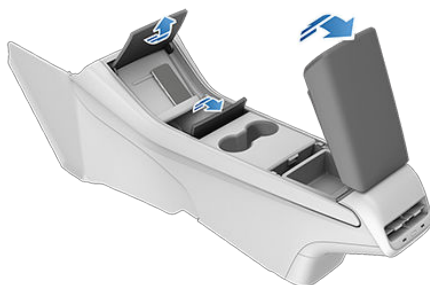

To open the main storage compartment, pull its cover upward.

Open the other storage compartment or access the phone dock by pressing firmly near the cover's opening edge. To close a storage compartment, push its cover down gently.

USB Ports - Premium Package

Model 3 has two USB ports located in the front compartment of the center console. These ports can be used to connect and charge your phone (see [Installing Phone Charging Cable](#) on page 21) as well as play audio files stored on the phone or on a USB device (see [Playing Media from Devices](#) on page 109).

Open the center console door below the touchscreen and lift the phone dock upward to access the USB ports.



Two additional USB ports are located in the rear of the center console. Passengers in the rear seats can use these ports to charge their USB-connected devices. Media Player does not communicate with the rear USB ports.



Note: Power is available whenever the vehicle is not asleep (for example, when Keep Climate On, Dog Mode, or Sentry Mode is enabled).

Note: Always use USB 2.0 compliant cables when connecting devices to the USB ports. Using non-compliant cables can result in slower charging and, if plugged into either of the front two ports, can result in potential connection problems when trying to access media files on the device.

Note: Do not connect multiple devices using a USB hub. This can prevent connected devices from charging or from being recognized by Media Player.

Installing Phone Charging Cable

To make it easy to connect your phone while keeping the console free of clutter, you can install a phone charging cable in Model 3.

Note: The phone dock supports two phones side-by-side.

To install a phone charging cable:

1. Open both center console doors in front of the cup holders.

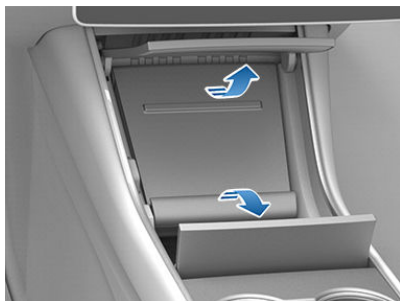

2. Remove the rubber mat from the phone dock.
3. Lift the phone dock to access the USB ports.

4. Release the cover from the base of the phone dock by sliding it to the left.



5. Plug the USB connector on the phone charging cable into a USB port.
6. Insert the phone end of the charging cable through the bottom of the phone dock and route the cable through the securing tabs towards the bottom of the phone dock.

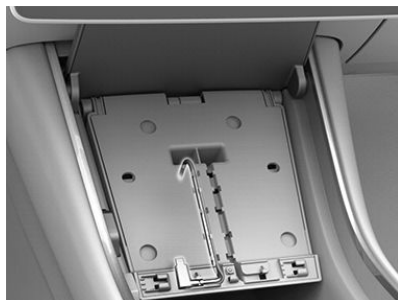

7. Reinstall the cover to the base of the phone dock by sliding it to the right.
8. Lower the phone dock and reinstall the rubber mat.

12V Power Socket

Your Model 3 has a power socket located in the center console's rear compartment. Power is available whenever the vehicle is not asleep (for example, when Keep Climate On, Dog Mode, or Sentry Mode is enabled).

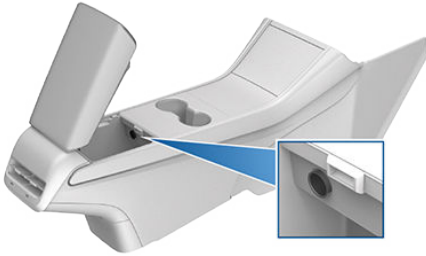

The power socket is suitable for accessories requiring up to 12A continuous draw (16A peak).

- Warning:** The power socket and an accessory's connector can become hot.
- Warning:** To prevent excessive interference with the vehicle's electronics, Tesla recommends that you do not plug any non-Tesla accessories, including power inverters, into the 12V power socket. However, if you do use a non-Tesla accessory and notice any malfunctions or unexpected behavior, such as indicator lights, alert messages, or excessive heat from the accessory, unplug the accessory from the 12V power socket immediately.
- Caution:** Do not attempt to jump start Model 3 using the 12V power socket. Doing so can result in damage.



Additional Interior Storage Areas

Your Model 3 has these additional storage areas:

- Storage compartments are located below the armrest on the door panels.
- If equipped with the premium package, storage pockets are located at the back of the front seats.

Rear Console

Your Model 3 has a rear console integrated in the center of the rear seat back. Pull the console down to access the rear cup holders, or use it as an armrest.



Coat Hangers

Your Model 3 has a coat hanger on each side of the vehicle in the rear row. Push the coat hanger to release it. Push it again to retract it.



Cabin Camera

Model 3 is equipped with a camera in the cabin. The camera is not currently active, but might be used in potential future features which could be added to Model 3 with software releases.

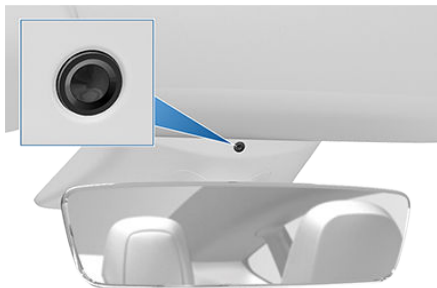

Keep the camera lens clean, and free of obstructions. Remove any buildup of dirt or dust by occasionally wiping the camera lens with a soft damp cloth.

⚠ Caution: Do not use chemical-based or abrasive cleaners. Doing so can damage the surface of the camera lens.



Correct Driving Position

The seat, head support, seat belt and airbags work together to maximize your safety. Using these correctly ensures greater protection.



Position the seat so you can wear the seat belt correctly, while being as far away from the front airbag as possible:

1. Sit upright with both feet on the floor and the seat back reclined no more than 30 degrees.
2. Make sure you can easily reach the pedals and that your arms are slightly bent when holding the steering wheel. Your chest should be at least 25 cm from the center of the airbag cover.
3. Place the shoulder section of the seat belt mid-way between your neck and your shoulder. Fit the lap section of the belt tightly across your hips, not across your stomach.

Model 3 seats include integrated head supports that cannot be adjusted or removed.

Adjusting the Front Seats - Premium Package (if Equipped)

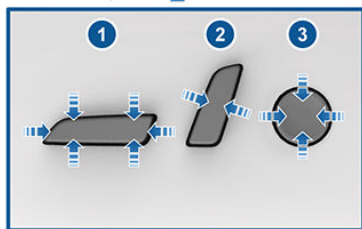

1. Move seat forward/backward and adjust the seat's height and tilt angle up/down.
2. Adjust backrest.
3. Adjust lumbar support.

Warning: Before adjusting a front seat, check that the area around the seat is free of obstacles (people and objects).

Warning: Do not adjust seats while driving. Doing so increases the risk of a collision.

Warning: Riding in a moving vehicle with the seat back reclined can result in serious injuries in a collision, as you could slide under the lap belt or be propelled into the seat belt. Ensure your seat back is reclined no more than 30 degrees when the vehicle is moving.



Folding Rear Seats

Model 3 has a split rear seat that can fold forward.

Before folding, remove items from the seats and the rear footwell. To allow the rear seat backs to fold completely flat, you may need to move the front seats forward.

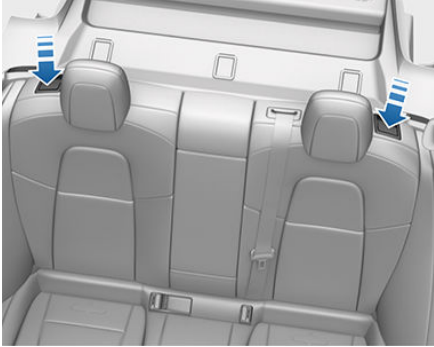

To fold a rear seat, pull the corresponding lever and fold the seat forward.



Raising Rear Seats

Before raising a rear seat, make sure that the seat belts are not trapped behind the backrest.

Pull the seat back upward until it locks into place.

To confirm that the seat back is locked in the upright position, try pulling it forward.

⚠ Warning: Always ensure the seat backs are locked in their upright position. Failure to do so increases the risk of injury.

Head Supports

The front seats and outer rear seats include integrated head supports that are not adjustable.

The rear center seat includes an adjustable head support that can be raised, lowered, or removed. The head support should always be raised and locked into position (so that the center is aligned with the center of the ears) when occupied by a passenger that is not in a child safety seat.

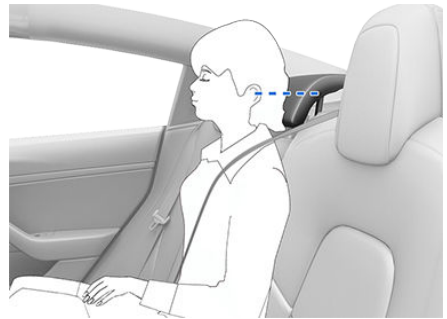

The head support in the rear center seat should always be lowered when a seat belt retained child safety seat is installed. See [Raising/Lowering the Rear Center Head Support](#) on page 25.

⚠ Warning: Ensure that all head supports are positioned correctly before sitting in, or operating, Model 3 to minimize the risk of severe injury or death in the event of a collision.

Raising/Lowering the Rear Center Head Support

To raise the head support, lift it until you hear it click into place. Push down on the head support to ensure that it is secure.

To lower the head support, press and hold the button on the outer base of the right post and press the head support down.

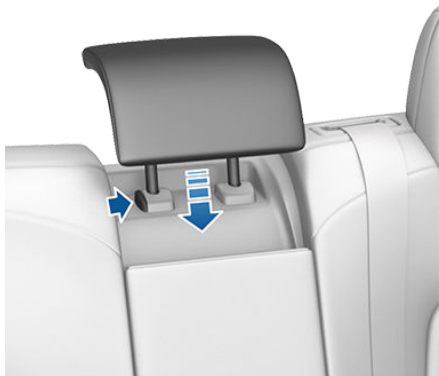

Removing/Installing the Rear Center Head Support

To remove the head support:

1. Raise the head support as described above.
2. Press and hold the button on the outer base of the right post.
3. Insert a short, flat object (such as a small flat-head screwdriver) into the opening on the inside base of the left post and pull the head support upward.



To re-install the head support:

1. With the front of the head support facing forward, insert both posts into the corresponding holes on the seat back.
2. Press down on the head support until it clicks into place.
3. Pull up on the head support to ensure that it is secure.

Warning: Ensure that the head support is correctly installed before seating an occupant in the rear center seat. Failure to do so increases the risk of injury or death if a collision occurs.

Seat Heaters

The front and rear seats are equipped with heating pads that operate at three levels from 3 (highest) to 1 (lowest). To operate the seat heaters, see [Climate Controls](#) on page 98.

Warning: To avoid burns resulting from prolonged use, individuals who have peripheral neuropathy, or whose capacity to feel pain is limited because of diabetes, age, neurological injury, or some other condition, should exercise caution when using the climate control system and seat heaters.

Seat Covers

Warning: Do not use seat covers in Model 3. Doing so could restrict deployment of the seat-mounted side air bags if a collision occurs. It can also reduce the accuracy of the occupant detection system.



Wearing Seat Belts

Using seat belts and child safety seats is the most effective way to protect occupants if a collision occurs. Therefore, wearing a seat belt is required by law in most jurisdictions.

Both the driver and passenger seats are equipped with three-point inertia reel seat belts. Inertia reel belts are automatically tensioned to allow occupants to move comfortably during normal driving conditions. To securely hold child safety seats, all passenger seating positions are equipped with an automatic locking retractor (ALR) that, by pulling the seat belt beyond the length needed for a typical adult occupant, locks the belt into place until the seat belt is unbuckled.

The seat belt reel automatically locks to prevent movement of occupants if Model 3 experiences a force associated with hard acceleration, braking, cornering, or an impact in a collision.

Seat Belt Reminders



The seat belt reminder on the touchscreen alerts you if a seat belt for an occupied seat is not fastened. If the belt remains unfastened, the reminder flashes and an intermittent chime sounds. If all occupants are buckled up and the reminder stays on, re-fasten seat belts to ensure they are correctly latched. Also remove any heavy objects (such as a briefcase) from an unoccupied seat. If the reminder light continues to stay on, contact Tesla.

You can temporarily mute a seat belt reminder associated with a rear seating position. This is useful in situations when you are carrying an object in a rear seat that triggers the seat belt reminder alert. To mute the reminder, touch the associated seat on the seat belt reminder card that displays on the touchscreen when a seat belt reminder alert is active. When a reminder is muted, the seat belt reminder icon is replaced by a seat icon. Touch the seat again to unmute the reminder. The reminder is disabled for the current drive only.

Warning: Seat belts must be worn by passengers in all seating positions. Do not disable a seat belt reminder when the seating position is occupied by a passenger.

To Fasten a Belt

1. Ensure correct positioning of the seat (see [Correct Driving Position](#) on page 24).
2. Draw the belt out smoothly, ensuring the belt lays flat across the pelvis, chest and mid-point of your collar bone, between the neck and shoulder.
3. Insert the latch plate into the buckle and press together until you hear a click indicating it is locked in place.

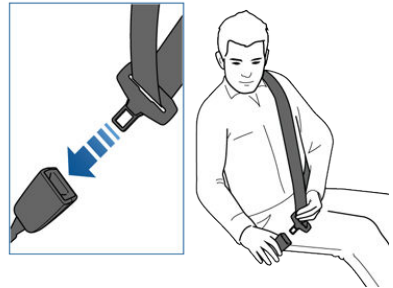

4. Pull the belt to check that it is securely fastened.
5. Pull the diagonal part of the belt toward the reel to remove excess slack.

To Adjust the Shoulder Anchor Height

Model 3 is equipped with an adjustable shoulder anchor for each front seat to ensure that the seat belt is positioned correctly. The seat belt should lay flat across the mid-point of your collar bone while in the correct driving position (see [Correct Driving Position](#) on page 24). Adjust the height of the shoulder anchor if the seat belt is not positioned correctly:

1. Press and hold the button on the shoulder anchor to release the locking mechanism.
2. While holding the button, move the shoulder anchor up or down as necessary so that the seat belt is positioned correctly.

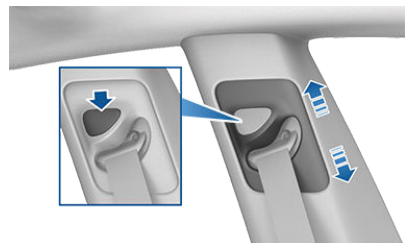



3. Release the button on the shoulder anchor so that it locks into position.
4. Without pressing the button, pull on the seat belt webbing and attempt to move the shoulder anchor downwards to check that it is locked into position.

Warning: Ensure that the seat belt is positioned correctly and that the shoulder anchor is locked into position before driving. Riding in a moving vehicle with the seat belt positioned incorrectly or with the shoulder anchor not locked into position can reduce the effectiveness of the seat belt in a collision.

To Release a Belt

Hold the belt near the buckle to prevent the belt from retracting too quickly, then press the button on the buckle. The belt retracts automatically. Ensure there is no obstruction that prevents the belt from fully retracting. The belt should not hang loose. If a seat belt does not fully retract, contact Tesla.

Wearing Seat Belts When Pregnant

Do not put the lap or shoulder sections of the seat belt over the abdominal area. Wear the lap section of the belt as low as possible across the hips, not the waist. Position the shoulder portion of the belt between the breasts and to the side of the abdomen. Consult your doctor for specific guidance.



Warning: Never place anything between you and the seat belt to cushion the impact in the event of a collision.

Seat Belt Pre-tensioners

The front seat belts are equipped with pre-tensioners that work in conjunction with the airbags in a severe frontal collision. The pre-tensioners automatically retract both the seat belt anchor and the seat belt webbing, reducing slack in both the lap and diagonal portions of the belts, resulting in reduced forward movement of the occupant.

The rear outboard seats are equipped with shoulder pre-tensioners to retract the seat belt webbing to reduce forward movement of the occupant.

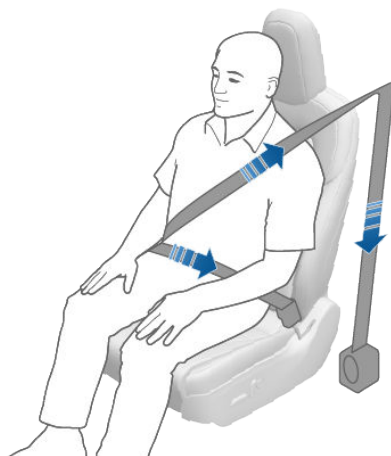

If the pre-tensioners and airbags did not activate in an impact, this does not mean they malfunctioned. It usually means that the strength or type of force needed to activate them was not present.

Warning: Once the seat belt pre-tensioners have been activated, they must be replaced. After any collision, have the airbags, seat belt pre-tensioners and any associated components checked and, if necessary, replaced.

Testing Seat Belts

To confirm that seat belts are operating correctly, perform these three simple checks on each seat belt.

1. With the seat belt fastened, give the webbing nearest the buckle a quick pull. The buckle should remain securely locked.











2. With the belt unfastened, unreel the webbing to its limit. Check that unreeling is free from snags, and visually check the webbing for wear. Allow the webbing to retract, checking that retraction is smooth and complete.
3. With the webbing half unreeled, hold the tongue plate and pull forward quickly. The mechanism should lock automatically and prevent further unreeling.



If a seat belt fails any of these tests, contact Tesla immediately.

For information about cleaning seat belts, see [Seat Belts](#) on page 138.

Seat Belt Warnings

-  **Warning:** Seat belts should be worn by all occupants at all times, even if driving for a very short distance. Failure to do so increases the risk of injury or death if a collision occurs.
-  **Warning:** Secure small children in a suitable child safety seat (see [Child Safety Seats](#)). Always follow the child safety seat manufacturer's instructions when installing.
-  **Warning:** Ensure that all seat belts are worn correctly. An improperly worn seat belt increases the risk of injury or death if a collision occurs.
-  **Warning:** Do not wear seat belts over hard, fragile or sharp items in clothing, such as pens, keys, eyeglasses, etc. The pressure from the seat belt on such items can cause injury.
-  **Warning:** Seat belts should not be worn with any part of the strap twisted.
-  **Warning:** Each seat belt assembly must be used by one occupant only. It is dangerous to put a seat belt around a child being carried on an occupant's lap.
-  **Warning:** Seat belts that have been worn in a collision must be inspected or replaced by Tesla, even if damage to the assembly is not obvious.
-  **Warning:** Seat belts that show signs of wear (such as fraying), or have been cut or damaged in any way, must be replaced by Tesla.
-  **Warning:** Avoid contaminating a seat belt's components with any chemicals, liquids, grit, dirt or cleaning products. If a seat belt fails to retract or latch into the

buckle, it must be replaced immediately. Contact Tesla.

-  **Warning:** Do not make modifications or additions that can prevent a seat belt mechanism from taking up slack, or that can prevent a seat belt from being adjusted to remove slack. A slack belt greatly reduces occupant protection.
-  **Warning:** Do not make modifications that can interfere with the operation of a seat belt, or that can cause a seat belt to become inoperable.
-  **Warning:** When seat belts are not in use, they should be fully retracted and not hanging loose. If a seat belt does not fully retract, contact Tesla.



Guidelines for Seating Children

Your Model 3 seat belts are designed for adults and larger children. You must restrain infants and small children in the seats only, and you must use a suitable child safety seat appropriate for the child's age, weight, and size.

Never use child safety seats in the front row passenger seat.

Warning: Never seat a child on a seat with an ACTIVE AIRBAG in front of it. DEATH or SERIOUS INJURY to the child can occur.

Refer to the following label fitted to the sun visors.

Note: The image shown below is representative only and may not be identical to the label in your vehicle.





Choosing a Child Safety Seat

All children age 12 and under should ride in the rear (second row) seats. Always use a child safety seat suitable for a young child's age and weight. The following table is based on child safety seat recommendations determined by National Highway Traffic Safety Administration (NHTSA). For more information, go to www.nhtsa.gov/ChildSafety/Guidance.

	Infants	Toddlers	Young children
Age	Birth to 1 year*	Over 1 year*	4 years and older, and less than 57 in. (145 cm) tall
Weight	Up to at least 20 lbs (9 kg)*	Over 20 lbs (9 kg) (minimum) and up to 40 lbs (18 kg)*	Over 40 lbs (18 kg)
Type of child safety seat	Rear facing (or convertible)	Forward facing (or convertible)*	Seat belt retained booster seat
Seat position	Rear facing only*	Forward facing*	Forward facing
Recommended attachment method	If combined weight of child and safety seat is up to 65 lbs (29 kg), attach using either LATCH** (lower anchor only) or the seat belt only.*** If combined weight of child and safety seat is over 65 lbs (29 kg), attach using the seat belt only.***	If combined weight of child and safety seat is up to 65 lbs (29 kg), attach using either LATCH** (both lower anchors and top tether anchor), or the seat belt and upper tether strap.*** If combined weight of child and safety seat is over 65 lbs (29 kg), attach using the seat belt and upper tether strap.***	Attach booster seats using the seat belt only.
<p>* Many child safety seats currently available allow children to ride rear-facing using the child safety seat's integrated 5-point harness for a longer period of time BASED UPON SPECIFIC HEIGHT AND WEIGHT LIMITS. Keep your child in a rear facing seat for as long as possible. CHECK THE CHILD SAFETY SEAT MANUFACTURER'S INSTRUCTIONS AND CAREFULLY FOLLOW ALL INSTRUCTIONS</p> <p>** LATCH - Lower Anchors and Tethers for Children. In Canada, this is also called Lower Universal Anchorage System (LUAS), or CANFIX.</p> <p>*** Subject to instructions provided by the child safety seat manufacturer.</p>			

⚠ Warning: Laws that govern how and where children should be carried when traveling in a vehicle are subject to change. It is the driver's responsibility to keep up to date on, and comply with, all current regulations in the region(s) where Model 3 is driven.

⚠ Warning: Do not use Isofix/i-Size anchors with child restraint system or booster seats that have an integral safety belt where the combined weight of the child plus the child restraint system exceeds 65 lbs (29.5 kg).



Seating Larger Children

If a child is too large to fit into a child safety seat, but too small to safely fit into the standard seat belts, use a booster seat appropriate for the child's age and size. Carefully follow the manufacturer's instructions to secure the booster seat.

Installing Child Safety Seats

There are two general methods used to install child safety seats:

- Seat belt retained - these seats are secured using the vehicle's seat belts (see [Installing Seat Belt Retained Child Seats](#)).
- LATCH retained - these seats can attach to anchor bars built into the vehicle's rear seats (see [Installing LATCH Child Seats](#)).

Check the child safety seat manufacturer's instructions and the table at [Child Safety Seats](#) to determine which installation method to use. Some child safety seats can be installed using either method. Always follow the child safety seat manufacturer's instructions.

Installing Seat Belt Retained Child Seats

First, make sure that the child safety seat is appropriate for the weight, height, and age of the child.

Avoid dressing the child in bulky clothing and do not place any objects between the child and the restraint system.

Adjust harnesses for every child, every trip.

To securely hold child safety seats, all passenger seating positions are equipped with an automatic locking retractor (ALR) that, by pulling the seat belt beyond the length needed for a typical adult occupant, locks the belt into place until the seat belt is unbuckled and the webbing is fully retracted. The ALR mechanism operates as a ratchet, winding in slack and preventing the seat belt from extending any further until it has been completely rewound. When installing a child safety seat, engage the belt's automatic locking retractor by pulling the seat belt webbing until it is fully extended. The ALR system engages only when the seat belt is at its maximum extension point.

Note: An automatic locking retractor disengages only when the seat belt is unbuckled and fully retracted. The belt can

then be worn as a normal belt, sliding freely in and out and locking tight only in an emergency. Once disengaged, the belt must be fully extended to re-engage the locking mechanism whenever you install a child safety seat.

Always follow the detailed instructions provided by the child safety seat manufacturer. General guidelines are provided below.

1. Place the child safety seat in Model 3, and fully extend the seat belt. Route and buckle the seat belt in accordance with the child safety seat manufacturer's instructions.



2. Allow the seat belt to retract, and remove all slack in the seat belt while firmly pushing the child safety seat into the Model 3 seat.
3. If the seat belt retained child safety seat has an upper tether, attach it to the back of the seat (see [Attaching Upper Tether Straps](#)).

Installing LATCH Child Seats

Lower LATCH anchors are provided in the second row outboard seats. The anchors are located between the seat's back rest and rear cushion. The exact location of each anchor is identified by a child safety seat identification button, illustrated below. The button is located on the seat back, directly above its associated anchor.



In the second row, install LATCH child safety seats in the outboard seating positions only. Use only a seat belt retained seat in the center position.



To install a LATCH child safety seat, slide the safety seat latches onto the anchor bars until they click into place. Carefully read and follow the instructions provided by the child safety seat manufacturer.



Once installed, test the security of the installation before seating a child. Attempt to twist the child safety seat from side to side and try to pull it away from the seat, then check to ensure the anchors remain securely in place.

Note: Lower LATCH anchors should not be used with child seats or booster seats that have an integrated safety belt in situations where the combined weight of the child plus the child restraint is more than 65 lbs (29.5 kg). In these situations, use the safety belt instead.

Attaching Upper Tether Straps

If an upper tether strap is provided, attach its hook to the anchor point located on the shelf behind the rear seats.

Note: The location of anchor points may not be readily visible but can be found by identifying a slice in the seat's material.

Warning: Tighten upper tether straps according to the instructions provided by the manufacturer of the child safety seat.

Warning: USE ONLY SEAT BELT RETAINED CHILD SAFETY SEATS IN THE CENTER SEATING POSITION.

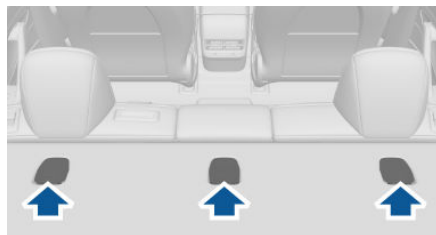

To access an anchor point, press down on the back of its cover.

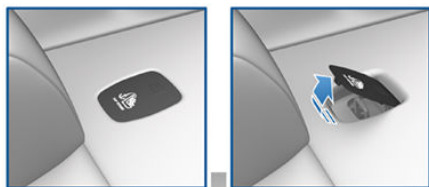

For dual-strap tethers, position a strap on each side of the head support.

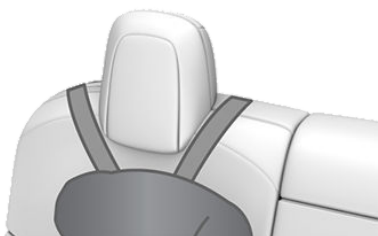

For single-strap tethers at the outboard seating positions, run the strap over the outside-facing side of the head support (i.e. same side of the head support as the seat belt retraction mechanism).

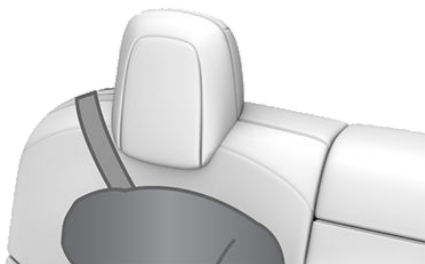

For a single-strap tether in the center seating position, fully lower the head support (see [Raising/Lowering the Rear Center Head Support](#) on page 25) and run the strap over the top center of the head support.

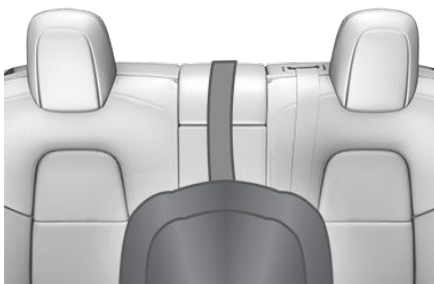

Testing a Child Safety Seat

Before seating a child, always make sure the child safety seat is not loose:











1. Hold the child safety seat by the belt path and try to slide the safety seat from side to side and front to back.
2. If the seat moves more than 2.5 cm, it is too loose. Tighten the belt or reconnect the LATCH retained child safety seat.
3. If you are unable to reduce slack, try a different seat location or try another child safety seat.

Child Safety Seat Warnings

- ⚠ Warning:** Extreme hazard! Do not seat a child on the front passenger seat even if you are using a child safety seat. This seat has an airbag in front of it. Although this airbag is disabled when Model 3 detects a lightweight passenger, do not rely on technology to protect your child.
- ⚠ Warning:** Child restraint systems are designed to be secured in vehicle seats by lap belts or the lap-shoulder belt. Children could be endangered in a crash if their child restraints are not properly secured in the vehicle.
- ⚠ Warning:** According to collision statistics, children are safer when properly restrained in the rear seating positions than in the front seating positions.
- ⚠ Warning:** Do not use a forward facing child safety seat until your child weighs over 9 kg and can sit independently. Up to the age of two, a child's spine and neck



are not sufficiently developed to avoid injury in a frontal impact.

-  **Warning:** Do not allow a baby or infant to be held on a lap. All children should be restrained in an appropriate child safety seat at all times.
-  **Warning:** To ensure children are safely seated, follow all instructions provided in this document and by the manufacturer of the child safety seat.
-  **Warning:** Children should ride in a rear facing child safety seat using the seat's integrated 5-point harness for as long as possible.
-  **Warning:** Do not use seat belt extenders on a seat belt that is being used to install a child safety seat or booster seat.
-  **Warning:** When seating larger children, make sure the child's head is supported and the child's seat belt is properly adjusted and fastened. The shoulder portion of the belt must be away from the face and neck, and the lap portion must not be over the stomach.
-  **Warning:** Never attach two child safety seats to one anchor point. In a collision, one anchor point may be incapable of securing both seats.
-  **Warning:** Child restraint anchors are designed to withstand only those loads imposed by correctly fitted child restraints. Under no circumstances are they to be used for adult seat belts, harnesses, or for attaching other items or equipment to the vehicle.
-  **Warning:** Always check harnesses and tether straps for damage and wear.
-  **Warning:** Never leave a child unattended, even if the child is secured in a child safety seat.
-  **Warning:** Never use a child safety seat that has been involved in a collision. Have the seat inspected or replaced as described in the child safety seat manufacturer's instructions.



Location of Airbags

Airbags are located in the approximate areas shown here. Airbag warning information is printed on the sun visors.

Model 3 is equipped with an airbag and lap/shoulder belt at both front outboard seating positions. The airbag is a supplemental restraint at those seating positions. All occupants, including the driver, should always wear their seat belts whether or not an airbag is also provided at their seating position to minimize the risk of severe injury or death in the event of a crash.

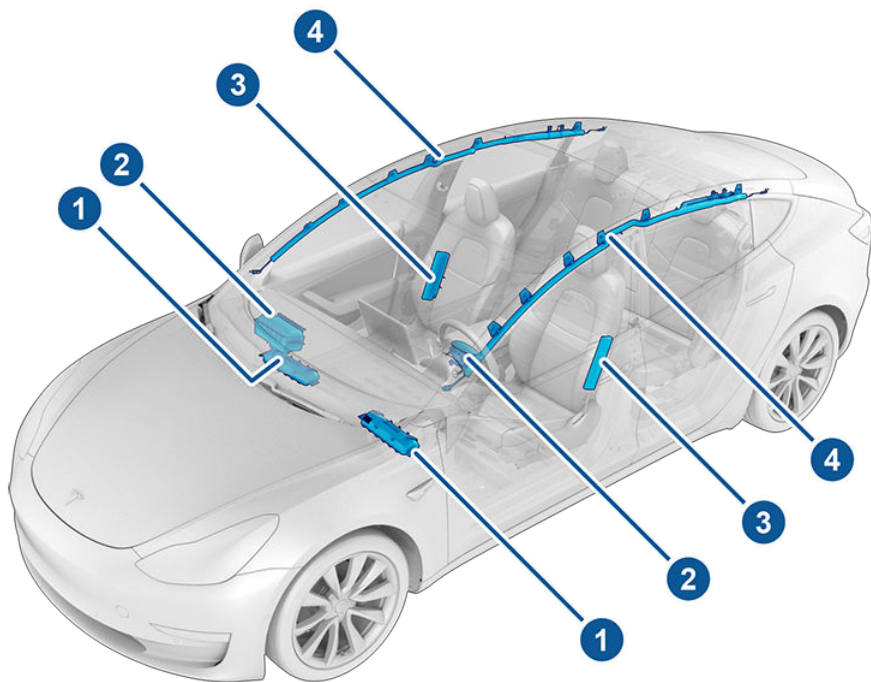

1. Knee airbags
2. Front airbags
3. Seat-mounted side airbags
4. Curtain airbags



How the Airbags Work

Airbags inflate when sensors detect an impact that exceeds deployment thresholds. These thresholds are designed to predict the severity of a crash in time for the airbags to help protect the vehicle's occupants.

Airbags inflate instantly with considerable force accompanied by a loud noise. The inflated bag, together with the seat belts, limits movement of occupants to reduce the risk of injury.

Front airbags are not ordinarily designed to inflate in rear collisions, rollovers, side collisions and when braking heavily or driving over bumps and potholes. Likewise, front airbags may not inflate in all frontal collisions, such as minor front collisions, underride collisions, or impacts with narrow objects (such as poles or trees). Significant superficial damage can occur to the vehicle without the airbags inflating and, conversely, a relatively small amount of structural damage can cause airbags to inflate. Therefore, the external appearance of the vehicle after a collision does not represent whether or not the front airbags should have inflated.

⚠ Warning: Before modifying your vehicle to accommodate a person with disabilities in a way that may affect the airbag system, contact Tesla.

Types of Airbags

Model 3 has the following types of airbags:

- **Advanced front airbags:** The front airbags are designed to reduce airbag related injuries if children or small adults are riding in the front seats. On the driver's side, the front airbag works with a seat position sensor that adjusts the inflation level based on the seating position of the occupant. On the passenger's side, the airbag responds to a sensing system in the seat that determines whether or not the passenger side front airbag inflates, and optimizes the inflation level based on the weight of the occupant. Follow all warnings related to seating a child on the front passenger seat.
- **Knee airbags:** Knee airbags and the front airbags work together. The knee airbags limit the forward motion of the front seat occupants by restricting leg movement, thereby positioning the occupants so that the front airbags work more effectively.
- **Seat-mounted side airbags:** A seat-mounted side airbag in the front seats helps protect the pelvis and the thorax region of the torso. The seat-mounted side airbags on both the impacted and non-impacted side of the vehicle will inflate in the event of severe side impact or severe offset frontal impact.
- **Curtain airbags:** Curtain airbags help protect the head. Curtain airbags on both the impacted and non-impacted side of the vehicle will inflate only if a severe side impact occurs, or if the vehicle rolls over.



Passenger Front Airbag

Model 3 has an occupancy sensor in the front passenger seat that controls the status of the airbags based on the weight of the occupant. If the passenger airbag is OFF, it will not inflate when a collision occurs, and the passenger airbag off indicator displays in the top right corner of the touchscreen. If the passenger airbag is ON, it will inflate when a collision occurs, and its status does not display in the top right corner of the touchscreen.



The Passenger Airbag Off indicator displays in the top right corner of the touchscreen only when the front passenger airbag is turned off.

Note: The occupancy sensor system meets the regulatory requirement of FMVSS 208 and automatically detects when inflating the passenger front airbag would be unnecessary or potentially harmful.

Weight in front passenger seat	Passenger airbag status
Empty	OFF
Up to 20 lbs/9 kg	OFF
20-100 lbs/9-45 kg*	OFF* or ON**
Over 100 lbs/45 kg	ON**
*Values are approximate. A weight detected near the threshold can cause the airbag status to occasionally turn on and off depending on seating position and physique.	
**The absence of the passenger airbag off indicator in the top right corner of the touchscreen indicates that the passenger airbag is ON and will inflate in the event of a collision.	

Note: It takes approximately six seconds after you power on Model 3 for the occupancy sensor to report accurate status of the front passenger airbag. As a result, when you first power on Model 3, even in situations when it should be OFF because the passenger seat is either empty or carrying a weight of 20 lbs (9 kg) or less, the touchscreen can take up to six seconds to display the passenger airbag off indicator. If it fails to do so, contact Tesla

service immediately and seat passengers in the rear seating positions only.

If the passenger airbag is permanently on, even when the seat is empty, contact Tesla immediately.

To make sure the sensing system can correctly detect occupancy status, eliminate the following:

- Objects lodged under the seat.
- Heavy objects sitting on the seat (briefcase, large purse).
- Objects wedged between the seat back and seat cushion.
- Cargo interfering with the seat.
- After market items attached to, or sitting on, the seat (covers, mats, blankets, etc.).

These conditions can interfere with the occupancy sensor. If you have eliminated the above possibilities, and the airbag status is still incorrect, ask passengers to ride in the rear seats and contact Tesla to have the airbag system checked.

Note: The front passenger seat's sensing system affects the operation of the passenger front and side airbags only. The other passenger airbags are not affected.

Warning: Never seat a child on the front passenger seat, even if the passenger airbag is off. All occupants age 12 and under must ride in the rear seats (see [Child Safety Seats](#)).

Warning: To ensure accuracy of the occupant detection system, do not make any modifications to the front passenger seat.

Warning: Do not use seat covers on Model 3. Doing so could restrict deployment of the seat-mounted side air bags if a collision occurs. It can also reduce the accuracy of the occupant detection system, if equipped.

Inflation Effects

Warning: When airbags inflate, a fine powder is released. This powder can irritate the skin and should be thoroughly flushed from the eyes and from any cuts or abrasions.

After inflation, the airbags deflate to provide a gradual cushioning effect for the occupants and to ensure the driver's forward vision is not obscured.



If airbags have inflated, or if your vehicle has been in a collision, your vehicle requires servicing before it will power up. In addition, your airbags, seat belt pre-tensioners and any associated components must be checked, and if necessary, replaced. Contact Tesla Service immediately.

In a collision, in addition to the airbags inflating:

- Doors unlock.
- Hazard warning lights turn on.
- Interior lights turn on.
- High voltage is disabled.

Note: In some collision situations, even if airbags have not inflated, your vehicle's high voltage Battery may be disabled and you will be unable to power up and drive. Contact Tesla Service immediately.

Airbag Warning Indicator



The airbag indicator on the touchscreen remains lit if the airbag system is malfunctioning. The only time this indicator should light up is briefly when Model 3 first powers up, in which case it turns off within a few seconds. If it remains lit, contact Tesla immediately and do not drive.

Airbag Warnings

- Warning:** Do not use a child safety seat or seat young children on a seat with an operational airbag in front of it. Doing so can cause injury or death if the airbag inflates.
- Warning:** To ensure correct inflation of the side airbags, maintain an unobstructed gap between an occupant's torso and the side of Model 3.
- Warning:** Passengers shouldn't lean their heads against doors. Doing so can cause injury if a curtain airbag inflates.
- Warning:** Do not allow passengers to obstruct the operation of an airbag by placing feet, knees or any other part of the body on or near an airbag.
- Warning:** Do not attach or place objects on or near the front airbags, the side of the front seats, the headliner at the side of the vehicle, or any other airbag cover that could interfere with inflation of an airbag. Objects can cause serious injury if the vehicle is in a collision severe enough to cause the airbag to inflate.
- Warning:** Following inflation, some airbag components are hot. Do not touch until they have cooled.
- Warning:** Do not place objects over or near airbags because any such objects could cause harm if the vehicle is in a crash severe enough to cause the airbag to inflate.
- Warning:** All occupants, including the driver, should always wear their seat belts, whether or not an airbag is also provided at their seating position, to minimize the risk of severe injury or death in the event of a collision.
- Warning:** Front seat occupants should not place their arms over the airbag module, as an inflating airbag can cause fractures or other injuries.
- Warning:** Airbags inflate with considerable speed and force, which can cause injury. To limit injuries, ensure that occupants are wearing seat belts and are correctly seated, with the seat positioned as far back as possible.



Creating a Driver Profile

When you first adjust the driver's seat, steering wheel, or driver's side mirror, the touchscreen prompts you to create a driver profile to save these adjustments. Your profile also saves some of the preferences you make using the touchscreen's **Controls** window.



To add a new driver profile, touch the driver profile icon at the top of the touchscreen. Then touch **Add New Driver**, type the driver's name and touch **Create Profile**. Follow the onscreen instructions to save the seating position to the driver profile. You can also check the **Use Easy Entry** checkbox if you want to save (or use existing) Easy Entry settings (described below) in which the driver's seat and the steering wheel are automatically adjusted to make it easy to enter and exit Model 3.

If you change the position of the steering wheel, driver's seat, or driver's side mirror after you have saved or chosen a driver profile, the touchscreen prompts you to save the new position or restore the previously saved position (other settings are automatically saved). To change a setting without saving or restoring, just ignore the prompt.

To adjust Model 3 based on a driver's profile, touch the driver profile icon and choose the driver name. The saved adjustments are automatically made.

Note: Valet mode is a built-in driver profile used to limit speed and restrict access to some Model 3 features (see [Valet Mode](#) on page 40).

Note: To stop automatic adjustments that are in process based on a driver's profile, touch Stop on the Driver Profile dropdown menu. Automatic adjustments also stop if you manually adjust a seat, mirror or the steering wheel.

Easy Entry

You can define an Easy Entry setting that moves the steering wheel and driver's seat to make it easy to enter and exit Model 3. Any driver can use the Easy Entry setting by associating it with their driver's profile. When the Easy Entry setting is associated with a driver's profile, the steering wheel and driver's seat automatically adjust when the park gear is engaged and the driver's seat belt is unbuckled, allowing an easy exit from the vehicle. When returning to the vehicle and stepping on the brake pedal, settings automatically adjust back to the settings used by the most recent driver profile.

To use **Easy Entry** with a driver profile, ensure the **Use Easy Entry** box is checked.

Restoring a Driver's Profile



To adjust Model 3 based on a driver's profile, touch the driver profile icon on the touchscreen's status bar. Then choose the driver and Model 3 is adjusted based on the settings that have been saved to the chosen driver profile.

See What's Saved

To see what settings are associated with a driver profile, touch the driver profile icon on the top of the touchscreen. Then touch **See what's saved**. A popup window lists all the settings that are saved to driver profiles.

Note: The settings that are associated with driver profiles may vary depending on the version of software currently installed on your Model 3.

Valet Mode

When Model 3 is in Valet mode, the following restrictions apply:

- Speed is limited to 113 km/h.
- Maximum acceleration and power are limited.
- Front trunk and glovebox are locked.
- Home and Work locations are not available in the navigation system.
- Voice commands are disabled.
- Autopilot convenience features are disabled.
- The Allow Mobile Access setting is disabled.



- HomeLink (if applicable in your market region) is not accessible.
- Driver Profiles are not accessible.
- The touchscreen does not display the list of keys that can access Model 3 (see [Managing Keys](#) on page 10).
- Wi-Fi and Bluetooth are disabled. When Model 3 is in Valet mode, you cannot pair new Bluetooth devices or view or delete existing paired devices.

Note: If a Bluetooth paired device or a known Wi-Fi network is within operating range (approximately 9 meters) of Model 3 in Valet mode, Model 3 will connect to it.

Starting Valet Mode

With Model 3 in Park, touch the driver profile icon on the top of the touchscreen, then touch **Valet Mode**.

The first time you enter Valet mode, you will be prompted to create a 4-digit PIN that you will use to cancel Valet mode.

When Valet mode is active, the touchscreen displays the word **Valet** above the driving speed and the Valet mode driver profile displays on the touchscreen.

You can also use the mobile app to start and cancel Valet mode (provided Model 3 is in Park). When using the mobile app, you do not need to enter a PIN because you are already required to log into the app using your Tesla Account credentials.

Note: If the **PIN to Drive** setting is enabled (see [PIN to Drive](#) on page 115), you must enter the driving PIN before you can define or enter a Valet PIN. Once in Valet mode, Model 3 can be driven without the valet needing to enter the driving PIN.

Note: The **PIN to Drive** setting is not available when Valet mode is active.

If you forget your valet PIN, reset it from inside Model 3 by entering your Tesla Account credentials (which also cancels Valet mode). You can also reset your PIN using the mobile app.

Canceling Valet Mode

With Model 3 in Park, touch the **Valet Mode** driver icon on the touchscreen's status bar, then enter your 4-digit PIN.

When you cancel Valet mode, all settings associated with the most recently used driver profile and climate control settings are restored, and all features are available.

Note: You do not need to enter a PIN to cancel Valet mode from the mobile app.



Scroll Buttons

A scroll button is located on each side of the steering wheel. Use your thumb to press this button to the right or left. You can also press the button or roll it up or down.

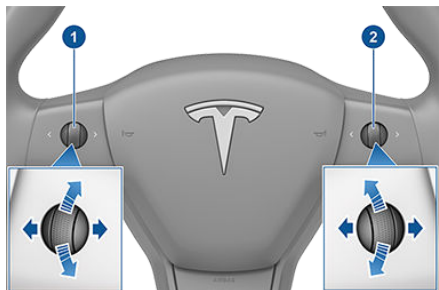

1. Use the left scroll button to:

- Control the volume. Press the scroll button to mute/unmute the volume, roll the scroll button up to increase the volume, or down to decrease the volume.
Note: The scroll button adjusts the volume for media, navigation instructions or phone calls based on what is currently in use. As you adjust volume, the touchscreen displays the volume level and whether you are adjusting volume for media, navigation or phone calls.
- Push the scroll button to the right to go to the next/previous song, station, or favorite (depending on what's playing). Push the scroll button to the left to go to the previous.
- Adjust the position of the exterior mirrors (see [Adjusting Exterior Mirrors](#) on page 44).
- If equipped with the premium package, adjust the position of the steering wheel (see [Adjusting Steering Wheel Position - Premium Package](#) on page 42).
- Adjust the angle of the headlights (see [Headlight Adjustments](#) on page 50).

2. Use the right scroll button to:

- Speak a voice command. Press the button to initiate a voice command (see [Using Voice Commands](#) on page 114).

- Adjust your set speed and the distance you want to maintain from a vehicle traveling ahead of you (see [Traffic-Aware Cruise Control](#) on page 69).

Note: The arrows associated with the scroll buttons are backlit in low ambient lighting conditions. To turn this backlighting on or off, touch **Controls > Lights > Steering Wheel Lights**.

To restart the touchscreen, press and hold both scroll buttons until after the touchscreen turns black, releasing when the Tesla logo appears. See [Restarting the Touchscreen](#) on page 46.

Adjusting Steering Wheel Position - Premium Package

To adjust the steering wheel, touch **Controls > Quick Controls > Adjustments > Steering Wheel**. Use the left scroll buttons on the steering wheel to move the steering wheel to the desired position:

- To adjust the height/tilt angle of the steering wheel, roll the left scroll button up or down.
- To move the steering wheel closer to you, or further away from you, press the left scroll button to the left or right.

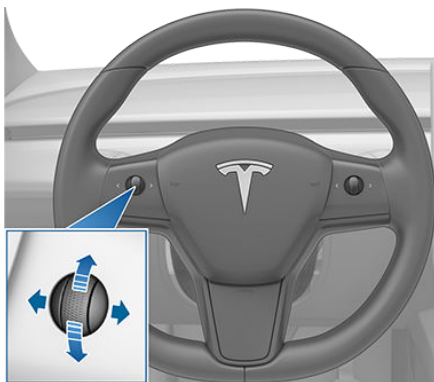

Warning: Do not make steering wheel adjustments while driving.

Adjusting Steering Effort

You can adjust the feel and sensitivity of the steering system to suit your personal preference:



1. On the touchscreen, touch **Controls** > **Driving** > **Steering Mode**.
2. Choose a steering option:
 - **Comfort** - Reduces the effort required to turn the wheel. In town, Model 3 feels easier to drive and park.
 - **Standard** - Tesla believes that this setting offers the best handling and response in all conditions.
 - **Sport** - Increases the effort required to turn the wheel. When driving at higher speeds, Model 3 feels more responsive.

The only way to really know which option you like best is to try them.

Horn

To sound the horn, press the center pad on the steering wheel.

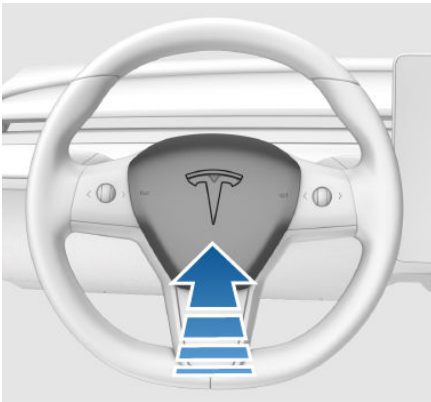



Adjusting Exterior Mirrors

Adjust the exterior mirrors by touching **Controls** > **Quick Controls** > **Mirrors**. You can choose which mirror you would like to adjust by selecting **Left** or **Right** on the touchscreen. Use the left scroll button on the steering wheel to adjust the mirror to its desired position:

Note: You can also press the left scroll button to change which mirror you are adjusting.

- To move the mirror up or down, roll the left scroll button up or down.
- To move the mirror inward or outward, press the left scroll button to the left or right.

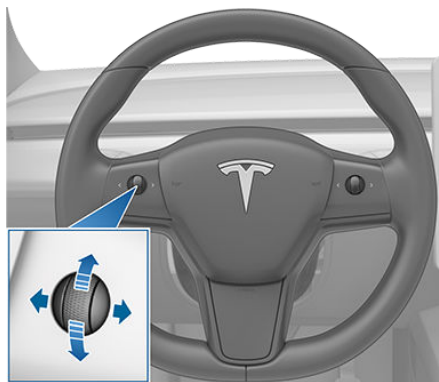

The driver's side mirror automatically dims in low lighting conditions (for example, when driving at night or through a tunnel) in proportion to the level of glare from the headlights of a vehicle behind you (except when in Reverse).

If equipped with the premium package, both exterior mirrors have heaters that turn on and off with the rear window defroster.

You can fold the mirrors inward for parking in tight spaces by touching **Controls** > **Quick Controls** > **Fold**. The mirrors remain folded until your driving speed reaches 50 km/h, or until you touch **Fold** again to unfold the mirrors.

Note: You cannot fold a mirror if your driving speed exceeds 50 km/h.

Auto-Fold Mirrors Based on Location

Model 3 can automatically fold and unfold the side mirrors based on location, which saves you from having to manually position them each time you need to fold or unfold the mirrors when at a frequented place (such as narrow garages, tight parking spaces, etc.).

To set up, Model 3 must be driving at a low speed (less than 3 mph/5 kph) or stopped at the location you want your vehicle to remember. Go to **Controls** > **Quick Controls** > **Mirrors** > **Always Fold Mirrors at this Location**. Next time you approach the saved location, your mirrors will fold and unfold within 25 feet (7.5 meters) of the specified location.

You can also integrate auto-folding mirrors with HomeLink (see [HomeLink Universal Transceiver](#) on page 116). To enable, go to **HomeLink** > **Auto-Fold Mirrors when Nearby**.

⚠ Caution: Mirrors may not automatically fold or unfold if you return to a saved location and are driving faster than 3 mph/5 kph.

Mirror Auto Tilt - Premium Package

If equipped with the premium package, both exterior mirrors can automatically tilt downward when Model 3 is shifted into Reverse. When you shift back into Drive, the mirrors return to their normal (upward) position.

To turn this feature on or off, touch **Controls** > **Quick Controls** > **Mirrors** > **Mirror Auto Tilt**.

Mirror Auto Fold - Premium Package

If equipped with the premium package, both exterior mirrors can automatically fold inward whenever you exit and lock Model 3. When you unlock Model 3, the exterior mirrors then automatically unfold.

To turn this feature on or off, touch **Controls** > **Quick Controls** > **Mirrors** > **Mirror Auto Fold**.

Rear View Mirror

The rear view mirror is adjusted manually. Except when in Reverse, the rear view mirror automatically dims in proportion to the level of glare from the headlights of a vehicle behind you.



Vanity Mirrors

To expose and illuminate the vanity mirror, fold the sun visor downwards, then use the tab to lower the mirror cover. When you close the mirror cover, the light turns off.

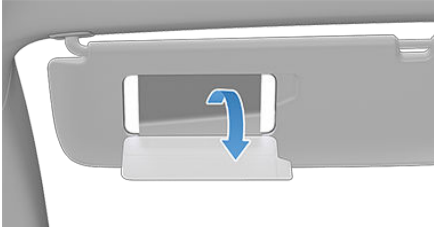



Starting

When you open a door, Model 3 powers on the touchscreen and you can operate all controls.

To drive Model 3:

1. **PRESS THE BRAKE PEDAL** - Model 3 powers on and is ready to drive.
2. **SELECT A GEAR** - Move the gear lever all the way down for Drive and all the way up for Reverse. See [Shifting Gears](#) on page 48.

Note: If the PIN to Drive feature is enabled (see [PIN to Drive](#) on page 115), you must also enter a valid PIN on the touchscreen before you can drive Model 3.

Note: If Passive Entry is off and you do not press the brake pedal to start Model 3 within approximately five minutes, a message displays on the touchscreen and you must use the key to lock then unlock Model 3 again before starting the vehicle.

Everything you need to know when driving Model 3 displays on the touchscreen.

Drive Disabled - Requires Authentication

If Model 3 does not detect a key when you press the brake (an authenticated phone is not detected, or 30 seconds has passed since you used the key card), the touchscreen displays a message telling you that driving requires authentication.

If you see this message, place the key card behind the cup holders on the top of the center console where the RFID transmitter can read it. The 30 second authentication window restarts and you can start Model 3 by pressing the brake pedal.



A number of factors can affect whether Model 3 can detect an authenticated phone (for example, the phone's battery is low or dead and is no longer able to communicate using Bluetooth).

Always keep your authenticated phone and a key card with you. After driving, your authenticated phone or key card is needed to restart Model 3 after it powers off. And when you leave Model 3, you must bring your authenticated phone or key card with you to lock Model 3, either manually or automatically.

Powering Off

When you finish driving, shift into Park by pressing the button on the end of the gear selector. The parking brake automatically engages and all systems keep operating. When you leave Model 3 with your authenticated phone and key card, it powers off automatically, turning off the touchscreen.

Model 3 also powers off automatically after being in Park for 15 minutes, even if you are sitting in the driver's seat.

Although usually not needed, you can power off Model 3 while sitting in the driver's seat, provided the vehicle is not moving. Touch **Controls > Safety & Security > Power Off**. Model 3 automatically powers back on again if you press the brake pedal or touch the touchscreen.

Note: Model 3 automatically shifts into Park whenever it is determined that you are exiting the vehicle, even when you shift into Neutral before exiting. To keep Model 3 in Neutral, you will need to activate Transport Mode (see [Instructions for Transporters](#) on page 158).

Restarting the Touchscreen

If your touchscreen is unresponsive or demonstrates unusual behavior, you can restart it. To ensure the safety of vehicle occupants as well as other road users, restarting the touchscreen should be done only when the vehicle is in Park.

To restart the touchscreen:

1. Shift into Park.



2. Hold down both scroll buttons on the steering wheel until the touchscreen turns black and the Tesla logo appears.

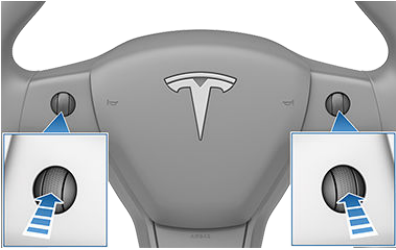

3. Wait approximately 30 seconds for the touchscreen to restart. If the touchscreen is still unresponsive or demonstrating unusual behavior after a few minutes, contact Tesla.

Note: Restarting the touchscreen does not power Model 3 off and on.



Shifting Gears

When Model 3 is in Park, you must press the brake to shift to another gear.

Move the lever up or down to change gears.



If you try to shift into a gear that the current driving speed prohibits, a chime sounds and the gear does not change.

Reverse

Push the lever all the way up and release. You can only shift into Reverse when Model 3 is stopped or moving less than 8 km/h. If moving less than 1.6 km/h, you must press the brake.

Neutral

Push the lever up or down to the first position and hold it there for more than 1 second to shift into Neutral. Neutral allows Model 3 to roll freely when you are not pressing the brake pedal.

If Model 3 is in Park and you use the touchscreen to release the parking brake (**Controls > Safety & Security**), Model 3 shifts into Neutral (see [Parking Brake](#) on page 57).

Model 3 automatically shifts into Park when you exit. To leave Model 3 in Neutral, use the touchscreen to engage Transport Mode (see [Instructions for Transporters](#) on page 158).

Drive

Push the lever all the way down and release. You can shift into Drive when Model 3 is stopped or moving less than 8 km/h in Reverse. If Model 3 is moving less than 1.6 km/h, you must press the brake to shift into Drive.

Note: When in Drive, push the lever all the way down and release to enable Traffic-Aware Cruise Control (see [Traffic-Aware Cruise Control](#) on page 69). Push the lever all the way down twice in quick succession to enable Autosteer (see [Autosteer](#) on page 75).

Park

Press the end of the gear selector while Model 3 is stopped. Whenever Model 3 is in Park, the parking brake is applied.



Model 3 automatically shifts into Park whenever you connect a charge cable or if two or more of the following conditions are met simultaneously:

- The driver's seat belt is unbuckled.
- The occupancy sensor in the driver's seat does not detect an occupant.
- The driver's door is opened.

Note: The above conditions do not reflect a comprehensive list of reasons why Model 3 may automatically shift into Park and, in certain scenarios, it is possible for your vehicle to shift into Park when only one of the above conditions is true.

To make it convenient to pick up passengers, you can also unlock all doors at any time by shifting into Park then pressing the Park button a second time.



Controlling Lights

Touch **Controls** > **Lights** on the touchscreen to control the lights.

In addition to the lights that you can control from the touchscreen, Model 3 has convenience lights that operate automatically based on what you are doing. For example, in low ambient lighting conditions, interior lights, marker lights, tail lights, and puddle lights turn on when you unlock Model 3, when you open a door, and when you shift into Park. They turn off after a minute or two or when you shift into a driving gear or lock Model 3.

Note: The image below is provided for demonstration purposes only. Depending on vehicle options, software version and market region, your touchscreen may appear slightly different.

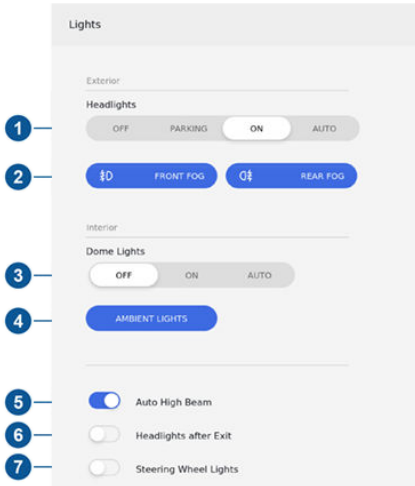

1. Exterior lights (headlights, tail lights, side marker lights, parking lights, and license plate lights) are set to **AUTO** each time you start Model 3. When set to **AUTO**, exterior lights automatically turn on when driving in low lighting conditions. If you change to a different setting, lights always revert to **AUTO** on your next drive.

Touch one of these options to temporarily change the exterior light setting:

- **OFF:** Exterior lights turn off until you manually turn them back on or until the next time you drive.
Note: Any exterior lights (for example, daytime running lights) that are required to remain on in your market region will turn on whenever a driving gear (Drive or Reverse) is engaged.
- **PARKING:** Only the exterior side marker lights, parking lights, tail lights and license plate lights turn on.
- **ON:** Exterior lights turn on.

Note: If equipped with the premium package, Model 3 has a series of LED lights along the rim of the headlights, also referred to as "signature" lights. These lights automatically turn on whenever Model 3 is powered on and a driving gear (Drive or Reverse) is engaged.

Warning: Always ensure that your headlights are on during low visibility conditions. Failure to do so may result in a collision.

2. A separate control is available to turn on fog lights (if equipped). When on, fog lights operate whenever low beam headlights are on. When headlights are turned off, fog lights also turn off.
3. Turn the interior dome (map) lights on or off. If set to **AUTO**, all interior dome lights turn on when you unlock Model 3, open a door upon exiting, or shift into Park.

You can also manually turn an individual dome light on or off by pressing its lens. If you manually turn a dome light on, it turns off when Model 3 powers off. If Model 3 was already powered off when you manually turned the light on, it turns off after 60 minutes.



4. If you turn on **AMBIENT LIGHTS**, interior ambient lights turn on whenever the headlights are on (if equipped).

Note: To control the backlighting on the steering wheel buttons, touch **Controls** > **Lights** > **Steering Wheel Lights**. If off, they do not turn on when headlights are on.



- If you turn on **Auto High Beam**, your vehicle automatically switches from high beam headlights to low beam headlights when light is detected in front of Model 3. See [High Beam Headlights](#) on page 50.
- If you turn on **Headlights after Exit**, the exterior lights remain on for a short period of time after you stop driving and park Model 3 in low lighting conditions. See [Headlights After Exit](#) on page 50.
- If you turn on **Steering Wheel Lights**, the arrows associated with the scroll buttons are backlit in low ambient lighting conditions.

High Beam Headlights

Push the left-hand steering column lever away from you and release to turn the high beam headlights on continuously. To cancel, push the lever away from you again.

To briefly flash the high beam headlights, pull the lever towards you and release.







The high beam headlights can automatically switch to low beam when there is light detected in front of Model 3 (for example, from an oncoming vehicle). To turn this feature on or off, touch **Controls > Lights > Auto High Beam**.

Note: Your chosen setting is retained until you manually change it.

In situations where Auto High Beam is turned on but the high beams are turned off because light is detected in front of Model 3, you can temporarily turn on the high beams by pulling the lever toward you.

The following indicator lights are visible on the touchscreen to show the status of the headlights:

-  Low beam headlights are on.
-  High beam headlights are on and Auto High Beam is disabled or currently unavailable.
-  Auto High Beam is enabled and high beams are on. Model 3 is ready to turn off the high beams if light is detected.
-  Auto High Beam is enabled but high beams are not on because light is detected in front of Model 3. When light is no longer detected, high beams automatically turn back on.

Warning: Auto High Beam is an aid only and is subject to limitations. It is the driver's responsibility to make sure that the headlights are appropriately adjusted for weather conditions and driving circumstances.

Headlights After Exit

When **Headlights after Exit** is on, the exterior headlights remain on when you stop driving and park Model 3 in low lighting conditions. They automatically turn off after one minute or when Model 3 locks. When off, headlights turn off when you engage the Park gear and open a door.

To turn this feature on or off, touch **Controls > Lights > Headlights after Exit**.

Headlight Adjustments

To adjust the angle of the headlights, touch **Controls > Service > Adjust Headlights**, then follow the onscreen instructions. You can choose which headlight you would like to adjust by selecting it on the touchscreen.

Warning: Proceed with caution when adjusting headlights. Tesla has carefully calibrated the position of the headlights to be in an optimum position for most driving scenarios. Tesla recommends that you do not adjust headlights unless you are familiar with how headlights should be adjusted. Once adjusted, you will be unable to automatically restore them to their originally calibrated position.





Contact Tesla for assistance when adjusting headlights.

Turn Signals

The turn signals flash three times or continuously, depending on how far up or down you move the lever. Lightly push the turn signal lever up or down for a three-flash sequence. For a continuous signal, push the lever fully up or down.



The turn signals stop operating when canceled by the steering wheel or after moving the lever in the opposite direction.

-  The corresponding turn signal indicator lights up on the touchscreen when a turn signal is operating. You also hear a clicking sound.
- 

Warning: If you have purchased the optional Enhanced Autopilot or Full Self-Driving Capability packages and Traffic-Aware Cruise Control is active, engaging a turn signal can cause Model 3 to accelerate when using Traffic-Aware Cruise Control in specific situations (see [Overtake Acceleration](#) on page 72). If Autosteer is active, engaging a turn signal may cause Model 3 to change lanes.

Hazard Warning Flashers

To turn on the hazard warning flashers, press the button located above the rear view mirror. All turn signals flash. Press the button again to turn off the hazard warning flashers.



Note: Hazard warning flashers operate even when Model 3 cannot detect a key (authenticated phone or key card).



Overview

The left side of the touchscreen displays the status of Model 3 at all times. What you see depends on whether the vehicle is:

- Parked (shown below).
- Driving (see [Driving Status](#) on page 53).
- Charging (see [Charging Status and Settings](#) on page 126).

When Model 3 is parked, the status area shows the gear, estimated range, and an overhead view of the car with buttons you can touch to open the trunks and charge port door. When you press the brake, Model 3 powers up and indicator lights flash briefly along the top. Unless an indicator light applies to the current situation (for example, a seat belt is not fastened), it should turn off. If an indicator light fails to turn on or off, contact Tesla.

Note: The following image is provided for demonstration purposes only. Depending on vehicle options, software version, and market region, the information displayed may be slightly different.

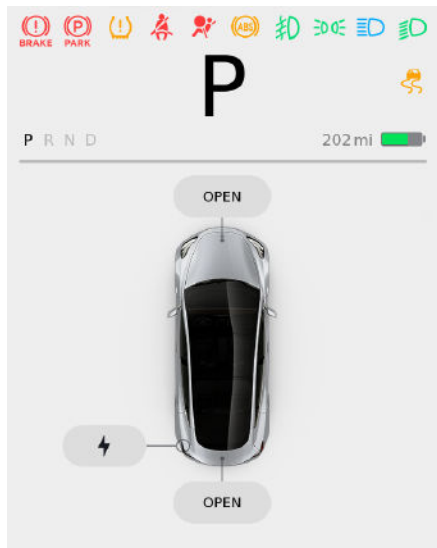

Indicator Lights

The following indicator lights illuminate to advise you or alert you of a specific status or condition.



A brake system fault is detected or the brake fluid level is low. See [Brakes](#) on page 56. Contact Tesla immediately.



The parking brake is manually applied. See [Parking Brake](#) on page 57.



A parking brake fault is detected. Contact Tesla. See [Parking Brake](#) on page 57.



Tire pressure warning. The pressure of a tire is out of range. If a fault with the Tire Pressure Monitoring System (TPMS) is detected, the indicator flashes. View tire pressures in the "Cards" area, located toward the bottom on the left side of the touchscreen, as described in [Touchscreen Overview](#) on page 4. For a TPMS fault, contact Tesla. See [Tire Care and Maintenance](#) on page 130.



A seat belt for an occupied seat is not fastened. See [Seat Belts](#) on page 27.



Airbag safety. If this indicator does not flash on briefly when Model 3 prepares to drive, or if it remains on, contact Tesla immediately. See [Airbag Warning Indicator](#) on page 39.



An ABS (Anti-lock Braking System) fault is detected. See [Brakes](#) on page 56. Contact Tesla immediately.



Front fog lights (if equipped). See [Lights](#) on page 49.



Parking lights (side marker lights, tail lights, and license plate lights) are on. See [Lights](#) on page 49.



Low beam headlights are on.



High beam headlights are on and Auto High Beam is disabled or currently unavailable.



Auto High Beam is enabled and high beams are on. Model 3 is ready to turn off the high beams if light is detected. See [High Beam Headlights](#) on page 50.



Auto High Beam is enabled but high beams are not on because light is detected in front of Model 3. When light is no longer detected, high beams automatically turn back on. See [High Beam Headlights](#) on page 50.



Electronic stability control systems are actively minimizing wheel spin by controlling brake pressure and motor power (indicator flashes). See [Traction Control](#) on page 58. If this indicator stays illuminated, a fault is detected (contact Tesla immediately).



Electronic stability control systems are no longer minimizing wheel spin. See [Traction Control](#) on page 58.



Vehicle Hold is actively applying the brakes. See [Vehicle Hold](#) on page 61.



A door or trunk is open. See [Doors](#) on page 12, [Rear Trunk](#) on page 15, or [Front Trunk](#) on page 17.



Flashes green when the left turn signal is operating. Both turn signal indicators flash green when the hazard warning flashers are operating.



Flashes green when the right turn signal is operating. Both turn signal indicators flash green when the hazard warning flashers are operating.

Driving Status

When Model 3 is driving (or ready to drive), the touchscreen shows your current driving status and a real-time visualization of the road as detected by the Autopilot components (see [About Autopilot](#) on page 66).

Note: The following illustration is provided for demonstration purposes only. Depending on vehicle options, software version, and market region, the information displayed may be slightly different.

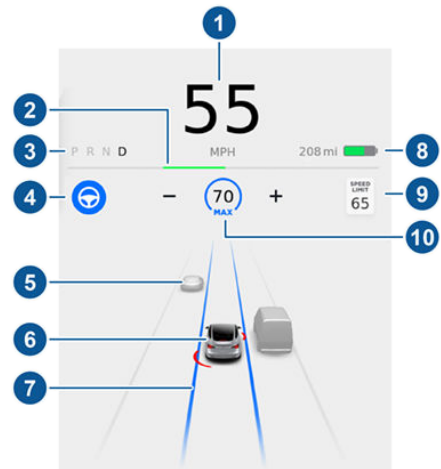

1. Driving speed.
2. On the energy bar, black (or white in night brightness) represents energy being used during acceleration and green indicates energy being gained through regenerative braking. A dashed line appears on the energy bar when power available for acceleration or power that can be gained by regenerative braking is being limited. Model 3 limits power for many reasons. Here are just a few examples:
 - Acceleration may be limited when the Battery is reaching a low state of charge or if the powertrain is hot.
 - Both acceleration and regenerative braking may be limited when the ambient temperature is either very warm or cool.
 - Regenerative braking may be limited when the Battery is fully charged.
3. Currently selected gear: Park, Reverse, Neutral, or Drive.



- Autosteer (if equipped). When Autosteer is available but you haven't activated it, the icon is gray. When Autosteer is actively steering Model 3, the icon is blue.
 - The car in front of you (if applicable).
 - Your Model 3. Colored lines radiate from the image of your Model 3 as objects are detected (other motorists, guard rails, etc.). The location of the lines correspond to the location of the detected object. The color of the lines (white, yellow, orange, or red) represents the object's proximity to Model 3, with white being the farthest and red being very close and requiring your immediate attention. See [Lane Assist](#) on page 84.
 - When Autosteer is active (if equipped) and detecting the driving lane, the lane is highlighted in blue (see [Autosteer](#) on page 75).
 - Total estimated driving distance (or energy) available. Instead of driving distance, you can display the percentage of battery energy remaining. To do so, touch **Controls** > **Display** > **Energy Display** > **Energy** (see [Controls](#) on page 91).
- Note:** When anticipating when you need to charge, use range estimates as a general guideline only.
- Note:** In cold weather, some of the stored energy in the Battery may not be available until the Battery warms up. When this happens, a portion of the Battery meter is blue and the driving distance value has a snowflake image next to it. If Model 3 is plugged in, you can heat your Battery using wall power by turning on climate control using the mobile app. When the Battery warms up, the blue portion on the meter and the snowflake image are no longer displayed.
- The detected speed limit (see [Speed Assist](#) on page 89).
 - The set cruising speed. When Traffic-Aware Cruise Control (if equipped) is available but you haven't set a cruising speed, the icon is gray and the speed is not shown (see [Traffic-Aware Cruise Control](#) on page 69).

Warning: Although the touchscreen shows surrounding traffic, some vehicles may not be displayed. Never rely on the touchscreen to determine if a vehicle is present (for example, in your blind spot). Always use your mirrors and perform shoulder checks.

Warning: Pay attention to important alert messages that display on the car status window. Ignoring these messages can result in serious injury or death.



Wipers

To perform a single wipe with the windshield wipers, press and immediately release the button on the end of the left-hand steering column lever.

To adjust the continuous wiper settings, touch the windshield wiper icon located in the "Cards" area on the touchscreen (see [Touchscreen Overview](#) on page 4). The wiper card displays the current state of the wipers.

Note: When you operate the wipers, the headlights automatically turn on (if they were not on already).

⚠ Caution: To avoid damaging the hood, ensure that the hood is fully closed before activating the windshield wipers.

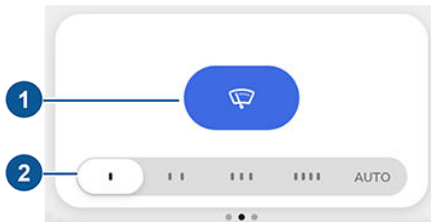

1. Turn the wipers on or off.
2. Adjust the speed of the wipers.
 - **1:** Intermittent, slow
 - **2:** Intermittent, fast
 - **3:** Continuous, slow
 - **4:** Continuous, fast
 - **AUTO:** Model 3 detects whether or not it is raining. When wipers are set to AUTO and liquid is detected on the windshield, Model 3 determines the optimal frequency at which they should wipe. If Model 3 does not detect liquid on the windshield, the wipers do not wipe.

Note: The AUTO setting is currently in BETA. If uncertain about using AUTO while in the BETA phase, Tesla recommends setting the wiper speed to one of the first four positions, as necessary.

Note: If the AUTO setting is selected but becomes unavailable, the wipers change to the manual setting (one of the first four positions) that is closest to the latest determined AUTO wiping frequency. If the latest wiping frequency cannot be determined, the wipers turn off.

⚠ Caution: Ensure the wipers are off before washing Model 3 to avoid the risk of damaging the wipers.

Periodically check and clean the edge of the wiper blades. If a blade is damaged, replace it immediately. For details on checking and replacing wiper blades, see [Wiper Blades and Washer Jets](#) on page 140.

⚠ Caution: Remove ice from the windshield before turning the wipers on. Ice has sharp edges that can damage the rubber on the blades.

⚠ Caution: In harsh climates, ensure that the wiper blades are not frozen or adhered to the windshield.

Washers

Fully press and hold the button on the end of the left-hand steering column lever to spray washer fluid onto the windshield. While spraying the windshield, the wipers turn on. After releasing the button, the wipers perform two additional wipes, then a third wipe a few seconds later.



Periodically top up washer fluid (see [Topping Up Windshield Washer Fluid](#) on page 142).



Braking Systems

Warning: Properly functioning braking systems are critical to ensure safety. If you experience a problem with the brake pedal, brake caliper, or any component of a Model 3 braking system, contact Tesla immediately.

Model 3 has an anti-lock braking system (ABS) that prevents the wheels from locking when you apply maximum brake pressure. This improves steering control during heavy braking in most road conditions.

During emergency braking conditions, the ABS constantly monitors the speed of each wheel and varies the brake pressure according to the grip available.

The alteration of brake pressure can be felt as a pulsing sensation through the brake pedal. This demonstrates that the ABS is operating and is not a cause for concern. Keep firm and steady pressure on the brake pedal while experiencing the pulsing.



The ABS indicator flashes briefly on the touchscreen when you first start Model 3. If this indicator lights up at any other time, an ABS fault has occurred and the ABS is not operating. Contact Tesla. The braking system remains fully operational and is not affected by an ABS failure. However, braking distances may increase.



If the touchscreen displays this indicator at any time other than displaying briefly when you first start Model 3, a brake system fault is detected or the brake fluid level is low. Contact Tesla immediately.

Emergency Braking

In an emergency, fully press the brake pedal and maintain firm pressure, even on low traction surfaces. The ABS varies the braking pressure to each wheel according to the amount of traction available. This prevents wheels from locking and ensures that you stop as safely as possible.

Warning: Do not pump the brake pedal. Doing so interrupts operation of the ABS and can increase braking distance.

Warning: Always maintain a safe distance from the vehicle in front of you and be

aware of hazardous driving conditions. While the ABS can improve stopping distance, it cannot overcome the laws of physics. It also does not prevent the danger of hydroplaning (where a layer of water prevents direct contact between the tires and the road).

Automatic Emergency Braking is designed to automatically brake in situations where a collision is considered imminent (see [Automatic Emergency Braking](#) on page 87).

Warning: Automatic Emergency Braking is not designed to prevent a collision. At best, it can minimize the impact of a frontal collision by attempting to reduce your driving speed. Depending on Automatic Emergency Braking to avoid a collision can result in serious injury or death.

Brake Wear

Model 3 brake pads are equipped with wear indicators. A wear indicator is a thin metal strip attached to the brake pad that squeals as it rubs against the rotor when the pad wears down. This squealing sound indicates that the brake pads have reached the end of their service life and require replacement. To replace the brake pads, contact Tesla Service.

Brakes must be periodically inspected visually by removing the tire and wheel. For detailed specifications and service limits for rotors and brake pads, see [Subsystems](#) on page 151.

Warning: Neglecting to replace worn brake pads damages the braking system and can result in a braking hazard.

Regenerative Braking

Whenever Model 3 is moving and your foot is off the accelerator, regenerative braking slows down Model 3 and feeds any surplus energy back to the Battery.

By anticipating your stops and reducing or removing pressure from the accelerator pedal to slow down, you can take advantage of regenerative braking to increase driving range. Of course, this is no substitute for regular braking when needed for safety.

Note: If regenerative braking is aggressively slowing Model 3 (such as when your foot is completely off the accelerator pedal at highway speeds), the brake lights turn on to alert others that you are slowing down.



Note: Installing winter tires with aggressive compound and tread design may result in temporarily-reduced regenerative braking power. However, your vehicle is designed to recalibrate itself to restore regenerative braking power after a short period of normal driving.

- Warning:** In snowy or icy conditions Model 3 may experience traction loss during regenerative braking, particularly when in the **Standard** setting and/or not using winter tires. Tesla recommends using the **Low** setting (see [To Set the Regenerative Braking Level](#) on page 57) in snowy or icy conditions to help maintain vehicle stability.

The amount of energy fed back to the Battery using regenerative braking can depend on the current state of the Battery and the charge level setting that you are using. For example, regenerative braking may be limited if the Battery is already fully charged or if the ambient temperature is too cold.

Note: If regenerative braking is limited, a dashed line displays on the energy bar (see [Driving Status](#) on page 53).

To Set the Regenerative Braking Level

You can use the touchscreen to change the level of regenerative braking:

1. Touch **Controls > Driving > Regenerative Braking**.
2. Choose from two levels:
 - **Standard:** Provides the maximum amount of regenerative braking. When you release the accelerator, Model 3 slows down, reducing the need to use the brakes.
 - **Low:** Limits regenerative braking. When you release the accelerator, Model 3 takes longer to slow down and coasts further than if set to Standard.

Parking Brake

The parking brake automatically engages when you shift Model 3 into Park, and releases when you shift into any other gear.



Note: The parking brake operates on the rear wheels only, and is independent of the pedal-operated brake system.

- Warning:** In snowy or icy conditions the rear wheels may not have sufficient traction to prevent Model 3 from sliding down a slope, particularly if not using winter tires. Avoid parking on hills in snowy or icy conditions. You are always responsible for parking safely.
- Warning:** Your Model 3 may display an alert if the road is too steep to safely park on or if the parking brakes have not properly engaged. These alerts are for guidance purposes only and are not a substitute for the driver's judgment of safe parking conditions, including specific road or weather conditions. Do not depend on these alerts to determine whether or not it is safe to park at any location. You are always responsible for parking safely.

Use the touchscreen to manually release the parking brake (which also shifts Model 3 into Neutral):

1. Touch **Controls > Safety & Security**.
2. Press the brake pedal, then touch **Parking Brake**. If Model 3 was previously in Park, it shifts into Neutral.



The parking brake indicator lights up on the touchscreen whenever you use the touchscreen to manually apply the parking brake.



If an electrical issue occurs with the parking brake, an amber parking brake fault message displays at the top of the touchscreen.

- Caution:** In the unlikely event that Model 3 loses electrical power, you cannot access the touchscreen and are therefore unable to release the parking brake without first jump starting Model 3 (see [Instructions for Transporters](#) on page 158).



How It Works

The traction control system constantly monitors the speed of the front and rear wheels. If Model 3 experiences a loss of traction, the system minimizes wheel spin by controlling brake pressure and motor power. By default, the traction control system is on. Under normal conditions, it should remain on to ensure maximum safety.



This indicator flashes on the touchscreen whenever the traction control system is actively controlling brake pressure and motor power to minimize wheel spin. If the indicator stays on, a fault is detected with the traction control system. Contact Tesla Service.

Warning: If the above indicator remains illuminated in situations in which you have not enabled Slip Start (described next), the traction control system may not be operating correctly. Contact Tesla Service immediately.

Warning: Traction control cannot prevent collisions caused by driving dangerously or turning too sharply at high speeds.

Allowing Wheel Slip

To allow the wheels to spin at a limited speed, you can enable Slip Start. Slip Start can be enabled at any speed, however it is less effective at higher speeds.

Under normal conditions, Slip Start should not be enabled. Enable it only in circumstances where you deliberately want the wheels to spin, such as:

- Starting on a loose surface, such as gravel or snow.
- Driving in deep snow, sand or mud.
- Rocking out of a hole or deep rut.

To allow the wheels to spin, touch **Controls** > **Driving** > **Traction Control** > **Slip Start**.



The touchscreen displays an alert message when Slip Start is enabled.

Although Slip Start is automatically disabled the next time you start Model 3, it is strongly recommended that you disable it immediately after the circumstances that required you to enable it have passed.

Note: Slip Start cannot be enabled when you are actively using Traffic-Aware Cruise Control.



How Park Assist Works

Model 3 has several sensors designed to detect the presence of objects. When driving slowly in Drive or Reverse (for example, when parking), the sensors alert you if an object is detected in close proximity of your Model 3. Objects are only detected in the direction of the gear you selected; front objects in Drive, rear objects in Reverse.

⚠ Warning: You may not be alerted if Model 3 rolls freely in the opposite direction of the gear you selected (for example, you will not receive an alert if Model 3 rolls backwards down a hill while in Drive).

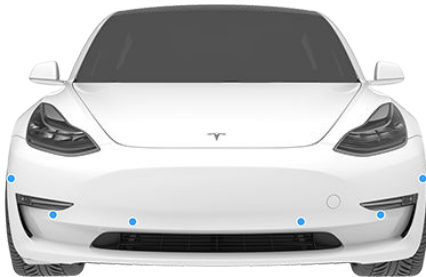

The sensors are activated when driving slower than 8 km/h.

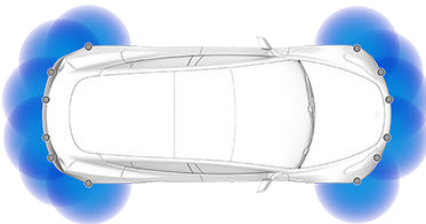

⚠ Warning: Never depend on Park Assist to inform you if an area you are approaching is free of objects and/or people. Several external factors can reduce the

performance of Park Assist, causing either no readings or false readings (see [Limitations and False Warnings](#) on page 60). Therefore, depending on Park Assist to determine if Model 3 is approaching an obstruction can result in damage to the vehicle and/or objects, and can potentially cause serious injury. Always inspect the area with your own eyes. When reversing, perform shoulder checks and use all mirrors. Park assist does not detect children, pedestrians, bicyclists, animals, or objects that are moving, protruding, located too far above or below the sensors, or too close or too far from the sensors. Park Assist is for guidance purposes only and is not intended to replace your own direct visual checks. It is not a substitute for careful driving.

Visual and Audio Feedback

When you shift to Reverse, the Park Assist view displays on the touchscreen, showing objects that are in close proximity to the front and rear of Model 3. This view closes when you shift into Drive unless an object is detected close to the front of Model 3, in which case the Park Assist view closes automatically when your driving speed exceeds 8 km/h. When reversing, visual feedback also displays on the touchscreen, immediately below the camera view (see [Rear View Camera](#) on page 64). You can manually close the park assist view on the touchscreen by touching the **X** in the upper left corner.

When driving with the Camera app displayed on the touchscreen, you can switch to the Park Assist view when driving at speeds below 8 km/h. Touch the button located in the upper left corner of the Camera app window. This is useful if you need assistance with parallel parking.

If chimes are turned on (see [Controlling Audible Feedback](#) on page 60), an audible beep sounds as you approach an object. You can temporarily mute the chime by pressing the scroll button on the left side of the steering wheel or by touching the mute button on the bottom left corner of the Park Assist view.

Note: If a sensor is unable to provide feedback, the touchscreen displays an alert message.

⚠ Caution: Keep sensors clean from dirt, debris, snow, and ice. Avoid using a high



pressure power washer on the sensors and do not clean a sensor with a sharp or abrasive object that can scratch or damage its surface.

- ⚠ **Caution:** Do not install accessories or stickers on or near the parking sensors.

Controlling Audible Feedback

You can use Park Assist with or without audible feedback. To turn chimes on or off, touch **Controls** > **Safety & Security** > **Park Assist Chimes**.

To mute the chimes temporarily, press the scroll button on the left side of the steering wheel or touch the mute button in the corner of the Park Assist view. The chimes are muted until you shift into a different gear or drive over 8 km/h.

Limitations and False Warnings

The parking sensors may not function correctly in these situations:

- One or more of the parking sensors is damaged, dirty, or covered (such as mud, ice, or snow).
- The object is located below approximately 20 cm (such as a curb or low barrier).

- ⚠ **Caution:** Shorter objects that are detected (such as curbs or low barriers) can move into the blind spot of the sensors. Model 3 cannot alert you about an object while it is in the blind spot of the sensors.

- Weather conditions (heavy rain, snow, or fog) are interfering with sensor operation.
- The object is thin (such as a sign post).
- A sensor's operating range has been exceeded.
- The object is sound-absorbing or soft (such as powder snow).
- The object is sloped (such as a sloped embankment).
- Model 3 has been parked in, or being driven in, extremely hot or cold temperatures.
- The sensors are affected by other electrical equipment or devices that generate ultrasonic waves.
- You are driving in a location where the sensors' ultrasonic waves are deflected away from the vehicle (such as driving next to a wall or pillar).

- The object is located too close to the bumper.
- A bumper is misaligned or damaged.
- An object that is mounted to Model 3 is interfering with and/or obstructing the sensor (such as a bike rack or bumper sticker).
- Model 3 rolls freely in the opposite direction of the gear you selected (for example, you will not receive an alert if Model 3 rolls backwards down a hill while in Drive).

Other Parking Aids

In addition to Park Assist, when shifted into Reverse, the backup camera displays a view of the area behind Model 3 (see [Rear View Camera](#) on page 64).



When Model 3 is stopped, Vehicle Hold can continue to apply the brakes even after you remove your foot from the brake pedal. When driving on a hill or on a flat surface, brake as you normally would. After coming to a complete stop, simply press the brake pedal again (until the touchscreen displays the Vehicle Hold indicator light) to enable Vehicle Hold. You can then release the brake pedal and remain stopped, even on a hill.



This indicator displays on the touchscreen whenever Vehicle Hold is actively braking Model 3.

To disengage Vehicle Hold, press the accelerator pedal or press and release the brake pedal.

Note: Shifting into Neutral also disengages Vehicle Hold.

Note: After actively braking Model 3 for approximately ten minutes, Model 3 shifts into Park and Vehicle Hold cancels. Model 3 also shifts into Park if it detects that the driver has left the vehicle.



Track Mode, available only on Performance Model 3 vehicles, modifies the vehicle's stability control, traction control, regenerative braking, and cooling system to increase performance and handling while driving on closed circuit courses. Track Mode improves cornering ability by intelligently using the vehicle's motors, and regenerative and traditional braking systems. When enabled, the cooling system runs at an increased level during and after aggressive driving sessions to allow your vehicle's systems to withstand the surplus heat.

Track Mode is always disabled when you start Model 3. To enable Track Mode for your current drive, shift into Park, then touch **Controls > Driving > Track Mode**. When enabled, **TRACK** displays on the touchscreen above the driving speed. You can disable Track Mode at any time by turning the setting off on the touchscreen.

Track Mode remains on even after you exit your vehicle to quickly cool powertrain systems between driving sessions. Track Mode automatically turns off when the vehicle is sufficiently cooled or if the vehicle is powered off and you power it back on again.

Warning: Track Mode is designed for use on closed circuit driving courses only. It is the driver's responsibility to drive safely and ensure that they do not endanger others.

Warning: Track Mode is designed to be used by experienced track drivers familiar with the course. Do not use on public roads. It is the driver's responsibility to be in control of the vehicle at all times, including on the race track. Because vehicle behavior (including Traction and Stability Control behavior) differs from typical use, drivers should use caution when using Track Mode.

Note: Track Mode was designed and calibrated for Performance Model 3 with the Performance Upgrade Package. Vehicles without performance brakes and tires may experience comparatively lower performance and endurance.

Note: When Track Mode is enabled, all Autopilot features are disabled or unavailable (including safety features such as Automatic Emergency Braking, Forward Collision Warning, etc.).

Note: Some settings, such as Slip Start and Regenerative Braking, are overridden and cannot be changed until Track Mode is

disabled. When Track Mode is disabled, the settings return to their previous state.



Driving Tips to Maximize Range

You can maximize your driving range using the same driving habits that you use to conserve fuel in a gasoline-powered vehicle. In addition to driving habits, energy consumption depends on environmental conditions (such as exceptionally cold or hot weather and driving on roads with steep hills). To get the maximum range from a charge:

- Slow down your driving and avoid frequent and rapid acceleration.
- If safe to do so, modulate the accelerator pedal instead of using the brake pedal when gradually slowing down. Whenever Model 3 is moving and you are not pressing the accelerator pedal, regenerative braking slows down Model 3 and feeds surplus energy back to the Battery (see [Regenerative Braking](#) on page 56).
- Keep tires at the recommended inflation pressures (see [Tire Care and Maintenance](#) on page 130).
- Lighten your load by removing any unnecessary cargo.
- Fully raise all windows.
- Limit the use of resources such as heating and air conditioning. Using seat heaters to keep warm is more efficient than heating the cabin.

The power meter on the touchscreen and the Energy app provides feedback on energy usage. With this feedback, you can become familiar with how driving habits and environmental conditions impact how much energy Model 3 is using.

Energy App

Use the Energy app to view real-time and projected energy usage. Choose from two types of charts:

- **Consumption:** display how much energy Model 3 has consumed over the past 10, 25 or 50 km.
Touch **Instant Range** or **Average Range** to adjust the projected range estimation. Instant Range uses only the latest few data points to estimate the projected range, whereas Average Range uses the past 10, 25 or 50 km of energy consumption to provide a more accurate projected range.

- **Trip:** monitor the amount of energy being used while navigating to a destination. You can track actual usage against the initial prediction. The green line represents the actual usage whereas the gray line represents predicted usage. To change the zoom level, touch the zoom icon located in the top right corner of the chart.

Note: The Trip chart displays energy usage only if you are currently navigating to a destination.

Range Assurance

Model 3 helps protect you against running out of energy. Model 3 continuously monitors its energy level and proximity to known charging locations.



Touch the map's charging icon to toggle between displaying superchargers only, and displaying all chargers, including destination chargers, and visited chargers.

When you are at risk of driving beyond the range of known charging locations, the touchscreen displays a message giving you the opportunity to display a list of charging locations that are within range. When you select a charging location from the list, Model 3 provides navigation instructions and the turn-by-turn direction list displays the predicted amount of energy that will remain when you arrive at the charging destination.



Camera Location

Model 3 is equipped with a rear view camera located above the rear license plate.

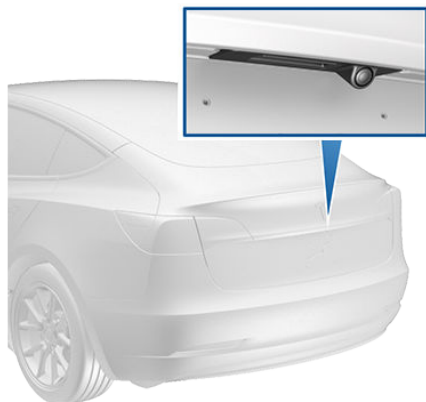

Whenever you shift into Reverse, the touchscreen displays the view from the camera. Lines show your driving path based on the position of the steering wheel. These lines adjust appropriately as you move the steering wheel.

Note: Visual feedback from the parking sensors displays on the touchscreen (see [Park Assist](#) on page 59).

To display the view from the camera at any time:



Touch the camera icon on the "Cards" area on the touchscreen.



Open the app launcher then touch the camera icon.

Warning: Never depend on the rear view camera to inform you if the area behind you is free of objects and/or people when reversing. The camera may not detect objects or barriers that can potentially cause damage or injury. In addition, several external factors can reduce the performance of the camera, including a dirty or obstructed lens. Therefore, depending on the rear view camera to determine if Model 3 is approaching an obstruction can result in damage to the

vehicle and/or objects, and can potentially cause serious injury. Always inspect the area with your own eyes. When reversing, perform shoulder checks and use all mirrors. Use the camera for guidance purposes only. It is not intended to replace your own direct visual checks and is not a substitute for careful driving.

Cleaning the Camera

To ensure a clear picture, keep the camera lens clean, and free of obstructions. Remove any buildup of dirt by occasionally wiping the camera lens with a soft damp cloth.

Caution: Do not use chemical-based or abrasive cleaners. Doing so can damage the surface of the camera lens.



About Dashcam

Note: Dashcam is a BETA feature.

In addition to supporting Autopilot features, cameras can record and store video footage on a USB flash drive. This can be convenient in situations where you want a video recording of a particular incident, such as a collision. You can pause, resume, or save video recording directly from your vehicle's touchscreen.

Note: You are responsible for complying with all local laws, regulations, and property restrictions regarding video recordings when using dashcam. Dashcam is external only and does not record audio.

Note: Dashcam may not be available in certain market regions or in vehicles built before approximately August 1, 2017.

Note: Dashcam only works when Model 3 is powered on (see [Starting and Powering Off](#) on page 46). Dashcam does not record video when your vehicle is powered off.

Using Dashcam

Dashcam requires a dedicated flash drive with FAT32 formatting (NTFS and exFAT are not currently supported). Before you can use the flash drive for dashcam, you must manually add a base-level folder in the flash drive called **"TeslaCam"** (without quotation marks). This folder is required for Model 3 to know where to store the video files; dashcam does not work without it.

After adding the required folder to your supported flash drive, insert it into one of your vehicle's front USB ports (see [Interior Storage and Electronics](#) on page 20). The rear USB ports are meant for charging mobile devices and do not support dashcam. When Model 3 recognizes the flash drive, which may take approximately 15 seconds, a dashcam icon appears in the status bar at the top of your touchscreen and dashcam automatically begins recording.

Touch the dashcam icon to control dashcam:



RECORDING. Tap the dashcam icon, when dashcam is paused, to start recording video on the flash drive. The dashcam temporarily stores approximately one hour of the most recent video footage on the flash drive before new video begins overwriting old video.



PAUSED. Press and hold the dashcam icon, when recording, to pause recording. Ensure that the dashcam is paused before removing the flash drive to avoid losing camera footage.



SAVED. Tap the dashcam icon, when recording, to archive the most recent ten minutes of video. The video files are saved on the flash drive with a unique timestamp. These saved video recordings are not overwritten by new recordings.

To access the video footage from dashcam, pause the dashcam, then remove the flash drive and use a personal computer to access the video files located in the "TeslaCam" folder.

⚠ Caution: You may lose up to the last 60 seconds of camera footage if you remove the flash drive before pausing dashcam or if your vehicle loses 12V power.

⚠ Caution: Use a flash drive that is dedicated to dashcam only. The flash drive cannot also be used to play media files, and Tesla is not responsible for any personal files becoming lost or corrupted.

Note: Tesla recommends using a flash drive with as much available storage as possible; saving the most recent ten-minutes of video requires approximately 300 MB, and the hour-long video footage loop requires approximately 1.8 GB of free space. If your flash drive does not have sufficient storage, an "X" displays on the dashcam icon and dashcam may be unable to save video files.

Note: Refer to [About Autopilot](#) on page 66 for information on limitations of the cameras and how to clean it. For best results, ensure that both the cameras and the windshield have good visibility.



How It Works

Your Model 3 includes the following Autopilot components that actively monitor the surrounding roadway:

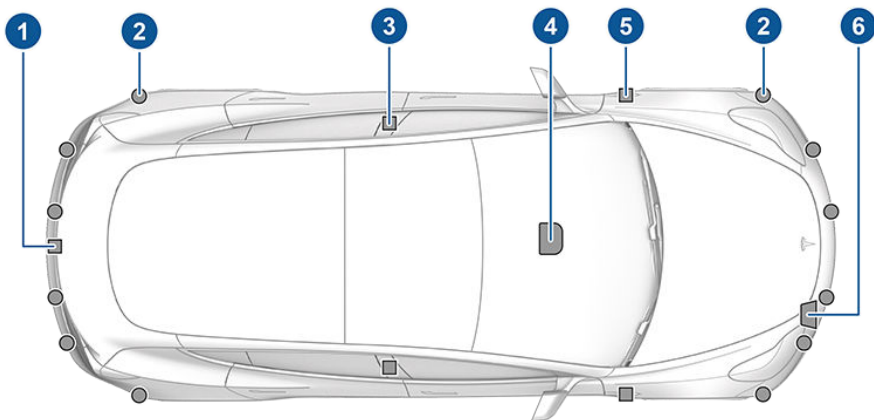

1. A camera is mounted above the rear license plate.
2. Ultrasonic sensors are located in the front and rear bumpers.
3. A camera is mounted in each door pillar.
4. Three cameras are mounted to the windshield above the rear view mirror.
5. A camera is mounted to each front fender.
6. Radar is mounted behind the front bumper on the side of the vehicle.

Model 3 is also equipped with high precision electronically-assisted braking and steering systems.



Features

These Autopilot safety features are available on all Model 3 vehicles:

- Lane Assist (see [Lane Assist](#) on page 84).
- Collision Avoidance Assist (see [Collision Avoidance Assist](#) on page 86).
- Speed Assist (see [Speed Assist](#) on page 89).
- Auto High Beam (see [High Beam Headlights](#) on page 50).

These convenience features, designed to reduce driver workload, are available only if your Tesla vehicle is equipped with the optional Enhanced Autopilot or Full Self-Driving Capability packages:

- Traffic-Aware Cruise Control (see [Traffic-Aware Cruise Control](#) on page 69).
- Autosteer (see [Autosteer](#) on page 75).
- Autopark (see [Autopark](#) on page 79).
- Summon (see [Summon](#) on page 81)

You can enable/disable Autopilot features and in some cases, control how they work. To access settings for Autopilot features, touch **Controls** > **Autopilot**.

Calibration

Model 3 must maneuver with a great deal of precision when Autopilot features are being used. Therefore, before some features (for example, Traffic-Aware Cruise Control or Autosteer) can be used for the first time, some cameras must complete a self-calibration process.

Calibration typically completes after driving 32-40 km, but the distance varies depending on road and environmental conditions. Driving on a straight road with highly-visible lane lines allows Model 3 to calibrate quicker. When calibration is complete, the features are available for use. Contact Tesla if your Model 3 has not completed the calibration process after driving 160 km.

Note: If you attempt to use a feature that is not available until the calibration process is complete, the feature will not be enabled and the touchscreen displays a message.

Note: Model 3 repeats the calibration process if the cameras are serviced by Tesla and in some cases, after a software update.

Limitations

Many factors can impact the performance of Autopilot components, causing them to be unable to function as intended. These include (but are not limited to):

- Poor visibility (due to heavy rain, snow, fog, etc.).
- Bright light (due to oncoming headlights, direct sunlight, etc.).
- Damage or obstructions caused by mud, ice, snow, etc.
- Interference or obstruction by object(s) mounted onto the vehicle (such as a bike rack).
- Obstruction caused by applying excessive paint or adhesive products (such as wraps, stickers, rubber coating, etc.) onto the vehicle.
- Narrow or winding roads.
- A damaged or misaligned bumper.
- Interference from other equipment that generates ultrasonic waves.
- Extremely hot or cold temperatures.

Warning: The list above does not represent an exhaustive list of situations that may interfere with proper operation of Autopilot components. Never depend on these components to keep you safe. It is the driver's responsibility to stay alert, drive safely, and be in control of the vehicle at all times.

Caution: If a windshield replacement is needed, take your vehicle to Tesla Service. This will ensure appropriate handling and mounting of the camera(s). Failure to do so can cause one or more Autopilot features to malfunction.

Cleaning Cameras and Sensors

To ensure the various Autopilot components can provide information that is as accurate as possible, keep them clean and free of obstructions or damage. Occasionally remove any buildup of dirt by wiping the components with a soft cloth dampened with warm water.

Caution: Do not use chemical-based or abrasive cleaners. Doing so can damage surfaces.

Caution: Avoid using a high-pressure power washer.

Caution: Do not clean an ultrasonic sensor or camera lens with a sharp or abrasive



About Autopilot

object that can scratch or damage its surface.



Note: Traffic-Aware Cruise Control is a BETA feature.

Note: If your vehicle is not equipped with the optional Enhanced Autopilot or Full Self-Driving Capability package, refer to the owner's manual on your vehicle's touchscreen for instructions on how to use Cruise Control.

If you have purchased the optional Enhanced Autopilot or Full Self-Driving Capability package, the forward looking cameras and the radar sensor are designed to determine when there is a vehicle in front of you in the same lane. If the area in front of Model 3 is clear, Traffic-Aware Cruise Control maintains a set driving speed. When a vehicle is detected, Traffic-Aware Cruise Control is designed to slow down Model 3 as needed to maintain a selected time-based distance from the vehicle in front, up to the set speed. Traffic-Aware Cruise Control does not eliminate the need to watch the road in front of you and to manually apply the brakes when needed.

Traffic-Aware Cruise Control is primarily intended for driving on dry, straight roads, such as highways and freeways. It should not be used on city streets.

Warning: Traffic-Aware Cruise Control is designed for your driving comfort and convenience and is not a collision warning or avoidance system. It is your responsibility to stay alert, drive safely, and be in control of the vehicle at all times. Never depend on Traffic-Aware Cruise Control to adequately slow down Model 3. Always watch the road in front of you and be prepared to take corrective action at all times. Failure to do so can result in serious injury or death.

Warning: Although Traffic-Aware Cruise Control is capable of detecting pedestrians and cyclists, never depend on Traffic-Aware Cruise Control to adequately slow Model 3 down for them. Always watch the road in front of you and be prepared to take corrective action at all times. Failure to do so can result in serious injury or death.

Warning: Do not use Traffic-Aware Cruise Control on city streets or on roads where traffic conditions are constantly changing.

Warning: Do not use Traffic-Aware Cruise Control on winding roads with sharp curves, on icy or slippery road surfaces, or when weather conditions (such as heavy rain, snow, fog, etc.) make it inappropriate to drive at a consistent speed. Traffic-

Aware Cruise Control does not adapt driving speed based on road and driving conditions.

To Use Traffic-Aware Cruise Control

To use Traffic-Aware Cruise Control, you must be driving at least 30 km/h, unless a vehicle is detected ahead of you. If a vehicle is detected ahead of you, you can use Traffic-Aware Cruise Control at any speed, even when stationary, provided Model 3 is at least 150 cm behind the detected vehicle.



When Traffic-Aware Cruise Control is available but is not actively cruising at a specified set speed, the touchscreen displays a gray speedometer icon below your current driving speed. The number shown in gray is your current driving speed, or the speed limit that is being determined by Speed Assist (see [Controlling Speed Assist](#) on page 89), whichever is greater. If you engage Traffic-Aware Cruise Control, this is the cruising speed that will be set.

Set the Cruising Speed

To set the cruising speed, move the cruise control lever fully down once then release. This sets the cruising speed to the detected speed limit (plus any offset you've specified using Speed Assist as described in [Controlling Speed Assist](#) on page 89) or your current driving speed, whichever is greater.

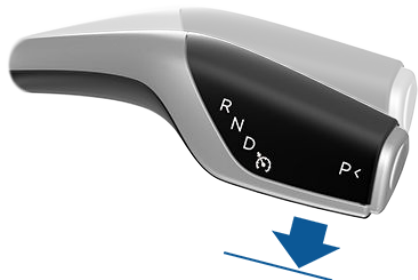

Release the accelerator pedal to allow Traffic-Aware Cruise Control to maintain your cruising speed.



When the cruising speed is set, the speedometer icon on the touchscreen turns blue and displays the set cruising speed.

Note: Moving the gear level fully down twice in quick succession engages Autosteer (assuming it has been enabled as described in [Autosteer](#) on page 75) and the set speed changes to either your current driving speed, or the current set speed (displayed in the icon), whichever is greater.

Note: The minimum speed you can set is 30 km/h and the maximum is 150 km/h. It is the driver's responsibility to cruise at a safe speed based on road conditions and speed limits.

Warning: When cruising at the speed limit, the cruising speed does not change when the speed limit changes. If your driving speed is at or below the new speed limit, move the lever up to cancel Traffic-Aware Cruise Control, then move it back down again to re-initiate and cruise at the new speed limit. You can also manually adjust your cruising speed (see [Changing the Set Speed](#) on page 71).

Warning: Do not rely on Traffic-Aware Cruise Control or Speed Assist to determine an accurate or appropriate cruising speed. Always cruise at a safe speed based on road conditions and applicable speed limits.

Cruising at the Set Speed

Traffic-Aware Cruise Control maintains your set cruising speed whenever a vehicle is not detected in front of Model 3. When cruising behind a detected vehicle, Traffic-Aware Cruise Control accelerates and decelerates Model 3 as needed to maintain a chosen following distance (see [Adjust the Following Distance](#) on page 72), up to the set speed.

Traffic-Aware Cruise Control also adjusts the cruising speed when entering and exiting curves.

You can manually accelerate at any time when cruising at a set speed, but when you release the accelerator, Traffic-Aware Cruise Control resumes cruising at the set speed.

Note: When Traffic-Aware Cruise Control is actively slowing down Model 3 to maintain the selected distance from the vehicle ahead,

brake lights turn on to alert other road users that you are slowing down. You may notice slight movement of the brake pedal. However, when Traffic-Aware Cruise Control is accelerating Model 3, the accelerator pedal does not move.

Warning: Traffic-Aware Cruise Control may occasionally cause Model 3 to brake when not required or when you are not expecting it. This can be caused by closely following a vehicle ahead, detecting vehicles or objects in adjacent lanes (especially on curves), etc.

Warning: Due to limitations inherent in the onboard GPS (Global Positioning System), you may experience situations in which Traffic-Aware Cruise Control slows down the vehicle, especially near highway exits where a curve is detected and/or you are actively navigating to a destination and not following the route.

Warning: Traffic-Aware Cruise Control cannot detect all objects and, especially in situations when you are driving over 80 km/h, may not brake/decelerate when a vehicle or object is only partially in the driving lane or when a vehicle you are following moves out of your driving path and a stationary or slow-moving vehicle or object is in front of you. Always pay attention to the road ahead and stay prepared to take immediate corrective action. Depending on Traffic-Aware Cruise Control to avoid a collision can result in serious injury or death. In addition, Traffic-Aware Cruise Control may react to vehicles or objects that either do not exist or are not in the lane of travel, causing Model 3 to slow down unnecessarily or inappropriately.

Warning: Traffic-Aware Cruise Control may be unable to provide adequate speed control because of limited braking capability and hills. It can also misjudge the distance from a vehicle ahead. Driving downhill can increase driving speed, causing Model 3 to exceed your set speed (and potentially the road's speed limit). Never depend on Traffic-Aware Cruise Control to slow down the vehicle enough to prevent a collision. Always keep your eyes on the road when driving and be prepared to take corrective action as needed. Depending on Traffic-Aware Cruise Control to slow the vehicle down enough to prevent a collision can result in serious injury or death.



Changing the Set Speed

To change the set speed while using Traffic-Aware Cruise Control, roll the right scroll wheel up (to increase) or down (to decrease) the set speed until your desired set speed is displayed. Slowly rolling the scroll wheel changes the set speed in 1 km/h increments and quickly rolling the scroll wheel changes the set speed to the closest 5 km/h increment.



You can also use the touchscreen to change the set speed by touching the plus (+) or minus (-) next to the displayed set speed. A quick tap changes the set speed by 1 km/h and a press and hold changes the set speed to the closest 5 km/h increment. To increase/decrease to the next increment, you must release the plus (+) or minus (-) then press it again.



Note: It may take a few seconds for Model 3 to reach the new cruising speed, assuming Model 3 does not detect a vehicle ahead driving slower than your set speed.

HOLD State

When following a vehicle, Traffic-Aware Cruise Control remains active at low speeds, even when Model 3 comes to a full stop. When the vehicle is moving again, Traffic-Aware Cruise Control resumes operating at the set speed. However, under the following circumstances, Traffic-Aware Cruise Control goes into a **HOLD** state, in which case, you need to briefly press the accelerator pedal to resume cruising. When the **HOLD** status is active, the touchscreen displays the **HOLD** icon and a message that indicates that you need to resume cruise control. The following circumstances can cause Traffic-Aware Cruise Control to go into the **HOLD** state:

- Model 3 has been at a standstill for 5 minutes.
- Model 3 detects a pedestrian (the **HOLD** state may clear when the pedestrian is no longer detected).
- Model 3 suddenly loses visibility of the vehicle in front of you.
- The ultrasonic sensors detect an obstacle in front of Model 3.

Cruising Near or On Freeway Exits

When cruising near an exit on a controlled access road (such as a highway or freeway) and engaging the turn signal toward the exit, Traffic-Aware Cruise Control assumes you are exiting and begins to slow down the vehicle. If you do not drive onto the exit, Traffic-Aware Cruise Control resumes cruising at the set speed. In a region with right hand traffic, this occurs only when you engage the right turn signal when driving in the right-most lane within 50 meters of an exit. Likewise in regions with left hand traffic; when engaging the left turn signal when driving in the left-most lane within 50 meters of an exit.

Note: The onboard Global Positioning System (GPS) determines if you are driving in a region with right or left hand traffic. In situations where GPS data is unavailable (for example, if there is inadequate signal), engaging the turn signal near an exit does not cause Traffic-Aware Cruise Control to slow down Model 3.



Adjust the Following Distance

To adjust the following distance you want to maintain between Model 3 and a vehicle traveling ahead of you, press the steering wheel's right scroll button to the left or right to choose a setting from 1 (the closest following distance) to 7 (the longest following distance). Each setting corresponds to a time-based distance that represents how long it takes for Model 3, from its current location, to reach the location of the rear bumper of the vehicle ahead of you.

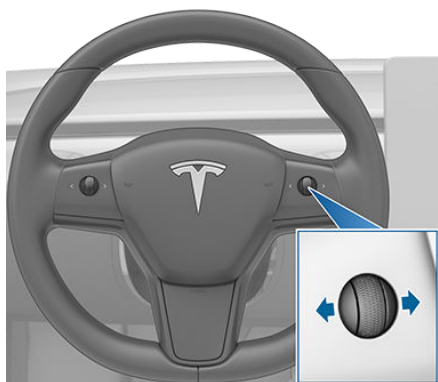

You can also display and adjust the setting for the following distance on the touchscreen at any time, even when Traffic-Aware Cruise Control is not active. Touch **Controls** > **Autopilot** > **Cruise Follow Distance**, then adjust the following distance by touching plus (+) or minus (-).



As you adjust the following distance, the touchscreen displays the current setting.



Note: Your setting is retained until you manually change it.

Warning: It is the driver's responsibility to determine and maintain a safe following distance at all times. Do not rely on Traffic-Aware Cruise Control to maintain an accurate or appropriate following distance.

Warning: Never depend on Traffic-Aware Cruise Control to adequately slow down Model 3 to avoid a collision. Always watch the road in front of you and stay prepared to take immediate corrective action.

Overtake Acceleration

When following a vehicle with Traffic-Aware Cruise Control active, briefly engaging the turn signal (to indicate a move into the passing lane) accelerates Model 3 towards the vehicle ahead. By momentarily holding the turn signal lever up or down, you can quickly accelerate up to your set speed without having to press the accelerator pedal. The turn signal causes acceleration only when all of the following conditions are met:

- Traffic-Aware Cruise Control is operating and detects a vehicle in front of you.
- No obstacles or vehicles are detected in the target lane.
- Model 3 is traveling below the set speed, but over 72 km/h.

Overtake Acceleration is intended as an aid when passing a vehicle ahead of you. When the turn signal is engaged, Traffic-Aware Cruise Control continues to maintain distance from the vehicle ahead, but allows you to drive slightly closer than your selected distance.

Acceleration cancels when one of the conditions happen:

- You reach your set cruising speed.
- Changing lanes takes too long.
- Model 3 gets too close to the vehicle ahead.

OR

- You disengage the turn signal.

Note: Overtake Acceleration occurs when you hold the turn signal in the momentary position (partially engaged). When you release the turn signal, Model 3 stops accelerating (in the same way as when you release the accelerator pedal) and resumes the set speed.

Warning: Overtake Acceleration can cancel for many unforeseen reasons in addition to those listed above (for example, lack of GPS data). Stay alert and never depend on Overtake Acceleration to increase your driving speed.

Warning: Overtake Acceleration increases your driving speed whenever the appropriate turn signal is engaged, and accelerates Model 3 closer to the vehicle



ahead. Although Traffic-Aware Cruise Control continues to maintain distance from the vehicle ahead, it is important to be aware that your selected following distance is reduced when Overtake Acceleration is active, particularly in cases where it may not be your intention to overtake the vehicle you are following.

Canceling and Resuming

To manually cancel Traffic-Aware Cruise Control, move the gear lever up and release or press the brake pedal. The speedometer icon on the touchscreen turns gray to indicate that Traffic-Aware Cruise Control is no longer active.

Warning: Do not hold the gear lever up for more than one second. Doing so cancels Traffic-Aware Cruise Control and shifts Model 3 into Neutral.



To re-enable cruising at the current driving speed, move the gear lever fully down once then release.

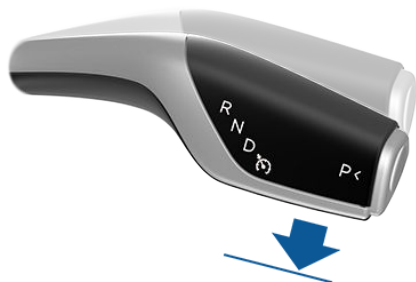

Note: When Traffic-Aware Cruise Control cancels, Model 3 does not coast. Instead, regenerative braking slows down Model 3 in the same way as when you move your foot off the accelerator when driving without Traffic-

Aware Cruise Control (see [Regenerative Braking](#) on page 56).

Warning: Traffic-Aware Cruise Control cancels, or may not be available, in the following situations:

- You press the brake pedal.
- Your driving speed exceeds the maximum cruising speed of 150 km/h.
- You shift Model 3 into a different gear.
- A door is opened.
- The view from the radar sensor or camera(s) is obstructed. This could be caused by dirt, mud, ice, snow, fog, etc.
- The traction control setting is manually disabled or is repeatedly engaging to prevent wheels from slipping.
- The wheels are spinning while at a standstill.
- The Traffic-Aware Cruise Control system is failing or requires service.

When Traffic-Aware Cruise Control is unavailable or cancels, Model 3 no longer drives consistently at a set speed and no longer maintains a specified distance from the vehicle ahead.

Warning: Traffic-Aware Cruise Control can cancel unexpectedly at any time for unforeseen reasons. Always watch the road in front of you and stay prepared to take appropriate action. It is the driver's responsibility to be in control of Model 3 at all times.

Summary of Cruise Indicators

50

Traffic-Aware Cruise Control is available but is not actively controlling your speed until you activate it. The number shown in gray is determined by Speed Assist (see [Controlling Speed Assist](#) on page 89).

61
MAX

Traffic-Aware Cruise Control is operating and is either maintaining the set speed (no vehicle in front) or is maintaining a chosen following distance from a vehicle ahead (up to the set speed).

(H)

HOLD

Model 3 has fully stopped but is in a **HOLD** state. If safe, press the accelerator pedal to resume cruising at the set speed.



Limitations

Traffic-Aware Cruise Control is particularly unlikely to operate as intended in the following types of situations:

- The road has sharp curves.
- Visibility is poor (due to heavy rain, snow, fog, etc.).
- Bright light (such as from oncoming headlights or direct sunlight) is interfering with the view of the camera(s).
- The radar sensor is obstructed (dirty, covered, etc.).
- The windshield is obstructing the view of the camera(s) (fogged over, dirty, covered by a sticker, etc.).



Warning: The list above does not represent an exhaustive list of situations that may interfere with proper operation of Traffic-Aware Cruise Control.



Note: Autosteer is a BETA feature.

If you have purchased the optional Enhanced Autopilot or Full Self-Driving Capability packages, you can use Autosteer to manage steering and speed under certain circumstances. Autosteer builds upon Traffic-Aware Cruise Control (see [Traffic-Aware Cruise Control](#) on page 69), intelligently keeping Model 3 in its driving lane when cruising at a set speed. Autosteer also allows you to use the turn signals to move Model 3 into an adjacent lane (see [Auto Lane Change](#) on page 77). Using the vehicle's camera(s), the radar sensor, and the ultrasonic sensors, Autosteer detects lane markings and the presence of vehicles and objects for steering Model 3.

Warning: Autosteer is a hands-on feature. You must keep your hands on the steering wheel at all times.

Warning: Autosteer is intended for use only on highways and limited-access roads with a fully attentive driver. When using Autosteer, hold the steering wheel and be mindful of road conditions and surrounding traffic. Do not use Autosteer on city streets, in construction zones, or in areas where bicyclists or pedestrians may be present. Never depend on Autosteer to determine an appropriate driving path. Always be prepared to take immediate action. Failure to follow these instructions could cause damage, serious injury or death.

Operating Autosteer

Before you can operate Autosteer, you must enable it by touching **Controls** > **Autopilot** > **Autosteer (Beta)**.



To indicate that Autosteer is available (but not actively steering Model 3), the touchscreen displays a gray Autosteer icon.

To initiate Autosteer, move the gear lever fully down twice in quick succession.



Autosteer briefly displays a message on the touchscreen reminding you to pay attention to the road and be ready to take over at any time. To indicate that Autosteer is now actively steering Model 3, the touchscreen displays the Autosteer icon in blue. When Autosteer is able to detect lane markings, it also displays the driving lane in blue.



Note: To initiate Autosteer when there is no vehicle in front of you, you must be driving at least 30 km/h on a roadway with visible lane markings. If a vehicle is detected ahead of you, you can initiate Autosteer at any speed under 150 km/h, even when stationary (if you are at least 150 cm away from the vehicle).

The touchscreen displays a message indicating that Autosteer is temporarily unavailable if you attempted to engage Autosteer when driving at a speed that is not within the speed required for Autosteer to operate. Autosteer may also be unavailable if it is not receiving adequate data from the camera(s) or sensors.

If Autosteer is unable to detect lane markings, the driving lane is determined based on the vehicle you are following.

In most cases, Autosteer attempts to center Model 3 in the driving lane. However, if the sensors detect the presence of an obstacle (such as a vehicle or guard rail), Autosteer may steer Model 3 in a driving path that is offset from the center of the lane.

Warning: Autosteer is not designed to, and will not, steer Model 3 around objects partially or completely in the driving lane. Always watch the road in front of you and stay prepared to take appropriate action. It is the driver's responsibility to be in control of Model 3 at all times.

Restricted Speed

Autosteer is intended for use only by a fully attentive driver on freeways and highways where access is limited by entry and exit ramps. If you choose to use Autosteer on residential roads, a road without a center divider, or a road where access is not limited, Autosteer may limit the maximum allowed cruising speed. The maximum allowed cruising speed on such roads is calculated based on the detected speed limit including a Speed Assist offset of up to +10 km/h. Any Speed Assist offset above +10 km/h is rounded down to +10 km/h. However, you can select a more restrictive cruising speed by reducing the speed limit offset (see [Controlling Speed Assist](#) on page 89) or by changing the set speed (see [Changing the Set Speed](#) on page 71).

In situations where the speed limit cannot be detected when Autosteer is engaged, Autosteer reduces your driving speed and limits the set speed to 70 km/h. Although you can manually accelerate to exceed the limited speed, Model 3 may not brake for detected obstacles. Autosteer will slow down to the limited speed when you release the accelerator pedal. When you leave the road, or disengage Autosteer by using the steering wheel, you can increase your set speed again, if desired.

Hold Steering Wheel

Autosteer uses data from the camera(s), sensors, and GPS to determine how best to steer Model 3. When active, Autosteer requires you to hold the steering wheel. If it does not detect your hands on the steering wheel for a period of time, a flashing blue light appears at the top of the car status section of the touchscreen and the following message displays:

 Apply light force to steering wheel

Autosteer detects your hands by recognizing light resistance as the steering wheel turns, or from you manually turning the steering wheel very lightly (without enough force to retake control).

Note: When your hands are detected, the message disappears and Autosteer resumes normal operation.

Note: Autosteer may also sound a chime at the same time that the message is initially displayed.

Autosteer requires that you pay attention to your surroundings and remain prepared to take control at any time. If Autosteer still does not detect your hands on the steering wheel, the request escalates by sounding chimes that increase in frequency.

If you repeatedly ignore hands-on prompts, Autosteer displays the following message and is disabled for the rest of the drive. If you don't resume manual steering, Autosteer sounds a continuous chime, turns on the warning flashers, and slows the vehicle to a complete stop.

 Autosteer unavailable for the rest of this drive
Hold steering wheel to drive manually

For the rest of the drive, you must steer manually. Autosteer is available again after you stop and shift the vehicle into Park.

Take Over Immediately

In situations where Autosteer is unable to steer Model 3, Autosteer sounds a warning chime and displays the following message on the touchscreen:

 Take over immediately

When you see this message, **TAKE OVER STEERING IMMEDIATELY.**

Canceling Autosteer

Autosteer cancels when:

- You start steering manually.
- You press the brake pedal.



- The maximum speed that Autosteer supports—150 km/h—is exceeded.
- You move the gear lever upwards.
- A door is opened.
- An Automatic Emergency Braking event occurs (see [Collision Avoidance Assist](#) on page 86).

When Autosteer cancels, it sounds chimes and the Autosteer icon either turns gray to indicate that Autosteer is no longer active, or disappears to indicate that it is not currently available.

Note: If Autosteer cancels because you started steering manually, Traffic-Aware Cruise Control remains active. Disengage Traffic-Aware Cruise Control as you normally would, by moving the gear lever upward or pressing the brake pedal.

Note: If you hold the gear lever upward for more than 1 second, Model 3 shifts into Neutral after canceling Autosteer.

To disable Autosteer so it is no longer available, touch **Controls** > **Autopilot** > **Autosteer (Beta)**.

Auto Lane Change

When Autosteer is active, you can use the turn signals to move Model 3 into an adjacent lane without moving the steering wheel (which would cancel Autosteer).

Warning: It is the driver's responsibility to determine whether a lane change is safe and appropriate. Therefore, before initiating a lane change, always check blind spots, lane markings, and the surrounding roadway to confirm it is safe and appropriate to move into the target lane.

Warning: Never depend on Auto Lane Change to determine an appropriate driving path. Drive attentively by watching the road and traffic ahead of you, checking the surrounding area, and monitoring the touchscreen for warnings. Always be prepared to take immediate action.

Warning: Do not use Auto Lane Change on city streets or on roads where traffic conditions are constantly changing and where bicycles and pedestrians are present.

Warning: The performance of Auto Lane Change depends on the ability of the camera(s) to recognize lane markings.

Warning: Do not use Auto Lane Change on winding roads with sharp curves, on icy or slippery roads, or when weather conditions (such as heavy rain, snow, fog, etc.) may be obstructing the view from the camera(s) or sensors.

Warning: Failure to follow all warnings and instructions can result in property damage, serious injury or death.

Operating Auto Lane Change

Auto Lane Change is available whenever Autosteer is active. To change lanes using Auto Lane Change:

1. Perform visual checks to make sure it is safe and appropriate to move into the target lane.
2. Engage the appropriate turn signal.
3. Disengage the turn signal after you are in the target lane.

Auto Lane Change moves Model 3 into the adjacent lane in the direction indicated by the turn signal, provided the following conditions are met:

- The turn signal is engaged.
- The ultrasonic sensors and Autopilot cameras do not detect a vehicle or obstacle up to the center of the target lane.
- The lane markings indicate that a lane change is permitted.
- The view of the camera(s) is not obstructed.
- Your vehicle does not detect another vehicle in its blind spot.
- Midway through the lane change, Auto Lane Change can detect the outside lane marking of the target lane.
- Driving speed is at least 45 km/h.

As the lane change is in progress, Overtake Acceleration is activated, allowing Model 3 to accelerate closer to a vehicle in front (see [Overtake Acceleration](#) on page 72). Midway through the lane change, Auto Lane Change must be able to detect the target lane's outside lane marking. If this lane marking cannot be detected, the lane change is aborted and Model 3 returns to its original driving lane.

Note: Auto Lane Change moves Model 3 one lane at a time. Moving into an additional lane requires you to engage the turn signal a second time after the first lane change is complete.



When using Auto Lane Change, it is important to monitor its performance by watching the driving path in front of you and the surrounding area. Stay prepared to take over steering at any time. As you are crossing over into the adjacent lane, the touchscreen displays the lane marking as a dashed blue line. Once in your new lane, lane markings are displayed as solid blue lines again.

In situations where Auto Lane Change is unable to operate at optimal performance, or cannot operate due to inadequate data, the touchscreen displays a series of warnings. Therefore, when using Auto Lane Change, always pay attention to the touchscreen and be prepared to manually steer Model 3.

Model 3 appropriately. Always drive attentively and be prepared to take immediate action.

Limitations

Autosteer and its associated functions are particularly unlikely to operate as intended when:

- Autosteer is unable to accurately determine lane markings. For example, lane markings are excessively worn, have visible previous markings, have been adjusted due to road construction, are changing quickly (lanes branching off, crossing over, or merging), objects or landscape features are casting strong shadows on the lane markings, or the road surface contains pavement seams or other high-contrast lines.
- Visibility is poor (heavy rain, snow, fog, etc.) or weather conditions are interfering with sensor operation.
- A camera(s) or sensor(s) is obstructed, covered, or damaged.
- Driving on hills.
- Approaching a toll booth.
- Driving on a road that has sharp curves or is excessively rough.
- Bright light (such as direct sunlight) is interfering with the view of the camera(s).
- The sensors are affected by other electrical equipment or devices that generate ultrasonic waves.
- A vehicle is detected in your blind spot when you engage the turn signal.
- Model 3 is being driven very close to a vehicle in front of it, which is blocking the view of the camera(s).

 **Warning:** Many unforeseen circumstances can impair the operation of Autosteer. Always keep this in mind and remember that as a result, Autosteer may not steer



If you have purchased the optional Enhanced Autopilot or Full Self-Driving Capability package, Autopark uses data from the ultrasonic sensors and GPS to simplify parking on public roads by maneuvering Model 3 into parallel and perpendicular parking spaces. See [To Use Autopark](#) on page 79.

Warning: Autopark's performance depends on the ability of the ultrasonic sensors to determine the vehicle's proximity to curbs, objects, and other vehicles.

To Use Autopark

When driving, follow these steps to allow Autopark to maneuver Model 3 into a parking space:

1. When driving slowly on a public road, monitor the touchscreen to determine when Autopark has detected a parking space. When Autopark detects a potential parking space, the touchscreen displays a parking icon. Autopark detects parallel parking locations when driving below 24 km/h and perpendicular parking locations when driving below 16 km/h.

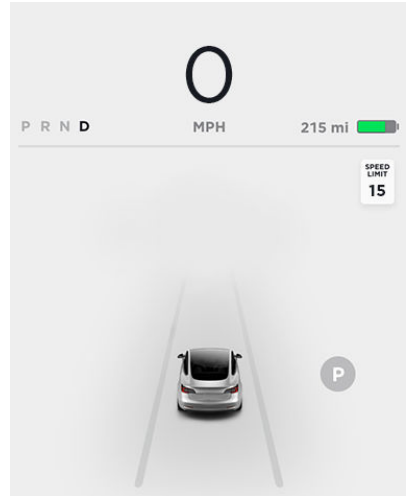

Note: The parking icon appears only if the vehicle's position and/or the circumstances of the surrounding area are such that Autopark can determine an appropriate driving path. If Autopark cannot determine an appropriate path (for example, when driving on a narrow street where moving into the parking space causes the front of the vehicle to extend into the adjacent lane), you can either reposition the vehicle, find a different parking space, or park manually.

2. Check to determine if the detected parking space is appropriate and safe. If so, pull forward and stop approximately a car length ahead of the parking space (as you normally would when parallel parking or when backing into a perpendicular parking space).
3. Release the steering wheel, shift Model 3 into Reverse, then touch **Start Autopark** on the touchscreen.
4. When parking is complete, Autopark displays the "Complete" message.



In situations where Autopark cannot operate due to inadequate sensor data, the touchscreen displays a message indicating that you must manually park Model 3.

Note: If you press the brake when Autopark is actively parking Model 3, the parking process pauses until you touch **Resume** on the touchscreen.

Note: Autopark detects potential perpendicular parking spaces that are at least 2.9 meters wide with a vehicle parked on each side. Autopark detects parallel parking spaces that are at least 6 meters, but less than 9 meters long. Autopark does not operate on angled parking spaces.

Warning: Never depend on Autopark to find a parking space that is legal, suitable, and safe. Autopark may not always detect objects in the parking space. Always perform visual checks to confirm that a parking space is appropriate and safe.

Warning: When Autopark is actively steering Model 3, the steering wheel moves in accordance with Autopark's adjustments. Do not interfere with the movement of the steering wheel. Doing so cancels Autopark.

Warning: During the parking sequence, continually check your surroundings. Be prepared to apply the brakes to avoid vehicles, pedestrians, or objects.

Warning: When Autopark is active, monitor the touchscreen to ensure that you are aware of the instructions that Autopark is providing.

To Pause Parking

To pause Autopark, press the brake pedal once. Model 3 stops and remains stopped until you touch **Resume** on the touchscreen.

To Cancel Parking

Autopark cancels the parking sequence when you manually move the steering wheel, change gears, or touch **Cancel** on the touchscreen. Autopark also cancels parking when:

- The parking sequence exceeds seven moves.
- Model 3 detects that the driver is exiting the vehicle.
- A door is opened.
- You press the accelerator pedal.
- You press the brake pedal while Autopark is paused.
- An Automatic Emergency Braking event occurs (see [Collision Avoidance Assist](#) on page 86).

Limitations

Autopark is particularly unlikely to operate as intended in these situations:

- The road is sloped. Autopark is designed to operate on flat roads only.
- Visibility is poor (due to heavy rain, snow, fog, etc.).
- The curb is constructed of material other than stone, or the curb cannot be detected.
- The target parking space is directly adjacent to a wall or pillar (for example, the last parking space of a row in an underground parking structure).
- One or more of the ultrasonic sensors is damaged, dirty, or obstructed (such as by mud, ice, or snow).
- Weather conditions (heavy rain, snow, fog, or extremely hot or cold temperatures) are interfering with sensor operation.
- The sensors are affected by other electrical equipment or devices that generate ultrasonic waves.

Warning: Many unforeseen circumstances can impair Autopark's ability to park Model 3. Keep this in mind and remember that as a result, Autopark may not steer Model 3 appropriately. Pay attention when parking Model 3 and stay prepared to immediately take control.



If you have purchased the optional , Summon allows you to automatically park and retrieve Model 3 while you are standing outside the vehicle. Summon uses data from the ultrasonic sensors to move Model 3 forward and reverse up to 12 meters in, or out of, a parking space.

Warning: Summon is designed and intended for use only on parking lots and driveways on private property where the surrounding area is familiar and predictable.

Warning: Summon is a BETA feature. You must continually monitor the vehicle and its surroundings and stay prepared to take immediate action at any time. It is the driver's responsibility to use Summon safely, responsibly, and as intended.

Warning: Summon's performance depends on the ability of the ultrasonic sensors to determine the vehicle's proximity to objects, people, animals, and other vehicles.

Before Using Summon

Before operating Summon, use the touchscreen to enable it and customize how you want it to work. Touch **Controls > Autopilot > Summon**, then touch **Customize** and adjust the following settings to suit your preferences:

- **Bumper Clearance:** Set the distance that you want Summon to stop from a detected object (for example, you may want Summon to stop within just a few inches of a garage wall). Note that this distance applies only to objects that Summon detects directly in front of Model 3 when moving forward, or directly behind Model 3 when reversing.
- **Summon Distance:** Set a maximum distance that Model 3 can travel when entering or exiting a parking space.
- **Side Clearance:** Choose an option to specify how much side clearance you want to allow. **Tight** allows Model 3 to enter and exit very narrow parking spaces.
 - Warning:** Parking in a narrow space limits the ability of the sensors to accurately detect the location of obstacles, increasing the risk of damage to Model 3 and/or surrounding objects.

- **Require Continuous Press:** By default, Summon requires that you press and hold a button on the mobile app or the key fob accessory to move Model 3 during the parking process. When **Require Continuous Press** is set to **NO**, you can press and release the button—you don't need to hold it down to keep the vehicle moving. Also, **Require Continuous Press** must be set to **NO** if you want to operate Summon using the key fob accessory instead of the mobile app (see [Operating Summon with the Key](#) on page 82), or if you want to start a parking sequence from inside the vehicle (see [Starting Summon Before Exiting the Vehicle](#) on page 82).
- **Use Auto HomeLink** (if equipped): Set to **ON** if you want to activate HomeLink to open/close a programmed HomeLink device (such as a gate or a garage door) during the parking process when using Summon . If enabled, the device automatically opens and closes when Model 3 enters or exits during a Summon session.

Warning: Always ensure that Model 3 is fully in or out of a garage before HomeLink lowers the garage door. Summon cannot detect where an overhead door will lower.

Note: When enabled, the HomeLink device automatically opens and closes only when using Summon. To automate HomeLink in other situations (such as normal driving), you must adjust the HomeLink device's main settings by touching the HomeLink icon at the top of the touchscreen (see [HomeLink Universal Transceiver](#) on page 116).

Note: All settings are retained until you manually change them.

Using Summon to Park and Retrieve your Vehicle

Follow these steps to use Summon to park your Model 3:

- Align Model 3 within 12 meters of the parking space so Model 3 can follow a straight path into or out of the space in either Drive or Reverse.



- From outside the vehicle, initiate the parking maneuver by touching **Summon** on the mobile app, then holding down the **FORWARD** or **REVERSE** button.

Note: If the **Require Continuous Press** setting is **NO**, you do not need to hold down the button, just press and release.

Note: You can also initiate the parking maneuver from inside the vehicle (see [Starting Summon Before Exiting the Vehicle](#) on page 82).

Summon shifts Model 3 into Drive or Reverse (based on the direction you specified) and drives into or out of the parking space. When parking is complete, or if an obstacle is detected, Summon shifts Model 3 into Park. Summon shifts Model 3 into Park when:

- Model 3 detects an obstacle in its driving path (within the **Bumper Clearance** setting that you specified).
- Summon has moved Model 3 the maximum distance of 12 meters.
- You release the **FORWARD** or **REVERSE** button (when **Require Continuous Press** is turned on).
- You press any button to manually stop Summon.

If you used Summon to park Model 3, you can then use Summon to return Model 3 back to its original position (provided the vehicle has remained in Park), or to the maximum **Summon Distance** that you have specified (whichever comes first). Simply specify the opposite direction on the mobile app and Summon moves the vehicle along the original path, provided no obstructions have been introduced. If the ultrasonic sensors detect an obstacle, Summon attempts to avoid the obstacle while staying very close to its original path (Summon does not steer around obstacles).

Note: To move Summon multiple times in the same direction (not to exceed the maximum of 12 meters, cancel Summon and then restart the parking process using the same direction.

Note: Although Summon can move Model 3 a short distance laterally to avoid an obstacle, it does not attempt to steer around an obstacle to return the vehicle to its original driving path.

Note: Summon requires that Model 3 can detect a valid key nearby.

Note: Summon requires that Model 3 can detect an authenticated phone nearby.

Warning: Model 3 cannot detect obstacles that are located lower than the bumper, are very narrow (i.e. bicycles), or are hanging from a ceiling. In addition, many unforeseen circumstances can impair Summon's ability to move in or out of a parking space and, as a result, Summon may not move Model 3 appropriately. Therefore, you must continually monitor the vehicle's movement and its surroundings and remain prepared to stop Model 3 at any time.

Operating Summon with the Key

Note: Summon may not operate if the key fob accessory's battery is low.

Follow these steps to park Model 3 from outside the vehicle using the key fob accessory:

- On the touchscreen, ensure that **Require Continuous Press** is disabled (touch **Controls > Autopilot > Summon > Require Continuous Press > NO**).
- With Model 3 in Park, stand within 3 meters and press and hold the top center button on the key fob accessory (Lock/Unlock All button) until the hazard lights blink continuously.

Note: The hazard lights flash once as Model 3 locks, then within five seconds, Model 3 powers on and the hazard lights flash continuously. Do not proceed to the next step until the hazard lights are flashing. If, after five seconds, the hazard lights are not flashing, release the button on the key fob accessory, move closer to Model 3, and try again. If Summon receives no further input within ten seconds, Summon cancels.
- Press the Front Trunk button on the key fob accessory to move Model 3 forward into the parking space, or press the Rear Trunk button to reverse Model 3 into the parking space.

Starting Summon Before Exiting the Vehicle

To start a Summon parking sequence before exiting Model 3:

- On the touchscreen, ensure that **Require Continuous Press** is disabled (touch **Controls > Autopilot > Summon > Require Continuous Press > NO**).
- Close all doors and trunks.



3. With Model 3 powered on and the Park gear engaged, double press the Park button on the gear stalk. The touchscreen displays a popup window.
4. On the touchscreen, choose the direction of travel.
5. Exit Model 3 and close the driver's door.

Summon now moves Model 3 according to the direction you specified on the touchscreen.

Note: To cancel the parking maneuver before exiting, touch **Cancel** on the popup window.

Note: If you do not choose a direction of travel on the touchscreen, Summon does not start a parking maneuver when you exit.

Stopping or Canceling Summon

You can stop Model 3 at any time while Summon is active by using the mobile app or by pressing any button on the key fob accessory. Summon also cancels when:

- A door handle is engaged or a door is opened.
- You interact with the steering wheel, brake pedal, accelerator pedal, or gear stalk.
- Model 3 detects an obstacle.
- Summon has moved Model 3 the maximum distance of approximately 12 meters.
- Your phone enters sleep mode or loses connectivity to Model 3.

Limitations

Summon is unlikely to operate as intended in the following types of situations:

- The driving path is sloped. Summon is designed to operate on flat roads only (up to 10% grade).
- A raised concrete edge is detected. Summon will not move the vehicle over an edge that is higher than approximately 2.5 cm.
- One or more of the ultrasonic sensors is damaged, dirty, or obstructed (such as by mud, ice, or snow, or by a vehicle bra, excessive paint, or adhesive products such as wraps, stickers, rubber coating, etc.).
- Weather conditions (heavy rain, snow, fog, or extremely hot or cold temperatures) are interfering with sensor operation.
- The sensors are affected by other electrical equipment or devices that generate ultrasonic waves.

Note: Summon is disabled if Model 3 is in Valet mode (see [Valet Mode](#) on page 40).

Warning: The list above does not represent an exhaustive list of situations that may interfere with proper operation of Summon. It is the driver's responsibility to remain in control of Model 3 at all times. Pay close attention whenever Summon is actively moving Model 3 and stay prepared to take immediate action. Failure to do so can result in serious property damage, injury or death.



The cameras monitor the markers on the lane you are driving in and the ultrasonic sensors and Autopilot cameras monitor the surrounding areas and the blind spot for the presence of a vehicle or other objects.

When an object is detected in your blind spot or close to the side of Model 3 (such as a vehicle, guard rail, etc.), colored lines radiate from the image of Model 3 on the touchscreen. The location of the lines correspond to the location of the detected object. The color of the lines (white, yellow, orange, or red) represents the object's proximity to Model 3, with white being the farthest and red being very close and requiring your immediate attention. These colored lines only display when driving between approximately 12 km/h and 140 km/h. When Autosteer is active, these colored lines also display if driving slower than 12 km/h. However, the colored lines do not display if Model 3 is at a standstill (for example, in heavy traffic).



Lane Assist warns you when a desired lane departure is not appropriate. When you engage the turn signal and a vehicle or object is detected in the adjacent lane you are planning to move into, the touchscreen displays a red lane line to indicate that a vehicle or object is detected. When the vehicle or object is no longer detected, the lane line returns to normal. If you want Lane Assist to sound a chime when detecting a possible collision in addition to displaying the red lane, touch **Controls > Autopilot > Blind Spot Collision Warning Chime**.

Warning: Lane Assist and Blind Spot Collision Warning Chime cannot detect every collision. It is the driver's responsibility to remain alert and check their blind spots often.

Lane Assist warns you of undesired lane departures by vibrating the steering wheel slightly if a front wheel passes over a lane marking and the associated turn signal is off. This warning is active only when driving between approximately 59 and 150 km/h. To turn this warning on or off, touch **Controls > Autopilot > Lane Departure Warning**. Your chosen setting is retained until you manually change it.

Lane Assist also provides steering interventions if Model 3 drifts into (or close to) an adjacent lane in which an object, such as a vehicle, is detected. In these situations, Model 3 automatically steers to a safer position in its driving lane. This steering is applied only when Model 3 is traveling between 48 and 140 km/h on major roadways with clearly visible lane markings. When Lane Assist applies a steering intervention, the touchscreen briefly displays a warning message.

Warning: Steering interventions are minimal and are not designed to move Model 3 out of its driving lane. Do not rely on steering interventions to avoid side collisions.

Warning: Lane Assist features are for guidance purposes only and are not intended to replace your own direct visual checks. Never depend on Lane Assist to inform you of unintentionally driving outside of the boundaries of the driving lane or informing you that an object or vehicle is in your blind spot or close to the side of your vehicle. Several external factors can reduce the performance of Lane Assist. It is the driver's responsibility to stay alert, pay attention to the driving lane and always be aware of other road users. Failure to do so can result in serious injury or death.

Warning: Lane Assist is designed to detect lane markings and may not detect the edge of a road, especially if the road has no curb. It is the driver's responsibility to drive attentively and stay within the boundaries of the driving lane.

Warning: Before changing lanes, always visually check the lane you are moving into by using side mirrors and performing the appropriate shoulder checks. Several factors can affect the performance of the Lane Assist warnings, resulting in lack of, or false, warnings (see [Limitations and Inaccuracies](#) on page 85).



Limitations and Inaccuracies

Lane Assist cannot always clearly detect lane markings and you may experience unnecessary or invalid warnings in these situations:

- Visibility is poor and lane markings are not clearly visible (due to heavy rain, snow, fog, etc.). The exact detection zone of the ultrasonic sensors varies depending on environmental conditions.
- Bright light (such as from oncoming headlights or direct sunlight) is interfering with the view of the camera(s).
- A vehicle in front of Model 3 is blocking the view of the camera(s).
- The windshield is obstructing the view of the camera(s) (fogged over, dirty, covered by a sticker, etc.).
- Lane markings are excessively worn, have visible previous markings, have been adjusted due to road construction, or are changing quickly (for example, lanes branching off, crossing over, or merging).
- The road is narrow or winding.
- Objects or landscape features are casting strong shadows on lane markers.

Lane Assist may not provide warnings, or may apply inappropriate warnings, in these situations:

- One or more of the ultrasonic sensors is damaged, dirty, or obstructed (such as by mud, ice, or snow).
- Weather conditions (heavy rain, snow, fog, or extremely hot or cold temperatures) are interfering with sensor operation.
- The sensors are affected by other electrical equipment or devices that generate ultrasonic waves.
- An object that is mounted to Model 3 is interfering with and/or obstructing a sensor (such as a bike rack or a bumper sticker).

In addition, Lane Assist may not steer Model 3 away from an adjacent vehicle, or may apply unnecessary or inappropriate steering, in these situations:

- You are driving Model 3 on sharp corners or on a curve at a relatively high speed.
- Bright light (such as from oncoming headlights or direct sunlight) is interfering with the view of the camera(s).
- You are drifting into another lane but an object (such as a vehicle) is not present.

- A vehicle in another lane cuts in front of you or drifts into your driving lane.
- Model 3 is traveling slower than 30 mph (48 km/h) or faster than 90 mph (145 km/h).
- One or more of the ultrasonic sensors is damaged, dirty, or obstructed (such as by mud, ice, or snow).
- Weather conditions (heavy rain, snow, fog, or extremely hot or cold temperatures) are interfering with sensor operation.
- The sensors are affected by other electrical equipment or devices that generate ultrasonic waves.
- An object mounted to Model 3 (such as a bike rack or a bumper sticker) is interfering with or obstructing a sensor.
- Visibility is poor and lane markings are not clearly visible (due to heavy rain, snow, fog, etc.).
- Lane markings are excessively worn, have visible previous markings, have been adjusted due to road construction or are changing quickly (for example, lanes branching off, crossing over, or merging).

⚠ Warning: The lists above do not represent every possible situation that may interfere with Lane Assist warnings. Lane Assist may not operate as intended for many other reasons. To avoid a collision, stay alert and always pay attention to the roadway when driving Model 3 so you can anticipate the need to take corrective action as early as possible.



The following collision avoidance features are designed to increase the safety of you and your passengers:

- **Forward Collision Warning** - provides visual and audible warnings in situations when Model 3 detects that there is a high risk of a frontal collision (see [Forward Collision Warning](#) on page 86).
- **Automatic Emergency Braking** - automatically applies braking to reduce the impact of a frontal collision (see [Automatic Emergency Braking](#) on page 87).
- **Obstacle-Aware Acceleration** - reduces acceleration if Model 3 detects an object in its immediate driving path (see [Obstacle-Aware Acceleration](#) on page 88).

Warning: Forward Collision Warning is for guidance purposes only and is not a substitute for attentive driving and sound judgment. Keep your eyes on the road when driving and never depend on Forward Collision Warning to warn you of a potential collision. Several factors can reduce or impair performance, causing either unnecessary, invalid, inaccurate, or missed warnings. Depending on Forward Collision Warning to warn you of a potential collision can result in serious injury or death.

Warning: Automatic Emergency Braking is not designed to prevent all collisions. In certain situations, it can minimize the impact of a frontal collision by attempting to reduce your driving speed. Depending on Automatic Emergency Braking to avoid a collision can result in serious injury or death.

Warning: Obstacle-Aware Acceleration is not designed to prevent a collision. In certain situations, it can minimize the impact of a collision. Depending on Obstacle-Aware Acceleration to avoid a collision can result in serious injury or death.

Forward Collision Warning

The forward looking camera(s) and the radar sensor monitor the area in front of Model 3 for the presence of an object such as a vehicle, motorcycle, bicycle, or pedestrian. If a collision is considered likely unless you take immediate corrective action, Forward Collision Warning is designed to sound a chime and highlight the vehicle in front of you in red on the touchscreen. If this happens, **TAKE IMMEDIATE CORRECTIVE ACTION!**



Warnings cancel automatically when the risk of a collision has been reduced (for example, you have decelerated or stopped Model 3, or the object in front of your vehicle has moved out of your driving path).

If immediate action is not taken when Model 3 issues a Forward Collision Warning, Automatic Emergency Braking (if enabled) may automatically apply the brakes if a collision is considered imminent (see [Automatic Emergency Braking](#) on page 87).

By default, Forward Collision Warning is turned on. To turn it off or adjust its sensitivity, touch **Controls** > **Autopilot** > **Forward Collision Warning**. Instead of the default warning level of **Medium**, you can turn the warning **Off**, or you can choose to be warned **Late** or **Early**.

Note: Your chosen setting for Forward Collision Warning is retained until you manually change it.

Warning: The camera(s) and sensors associated with Forward Collision Warning are designed to monitor an approximate area of up to 160 meters in your driving path. The area being



monitored by Forward Collision Warning can be adversely affected by road and weather conditions. Use appropriate caution when driving.

- ⚠ Warning:** Forward Collision Warning is designed only to provide visual and audible alerts. It does not attempt to apply the brakes or decelerate Model 3. When seeing and/or hearing a warning, it is the driver's responsibility to take corrective action immediately.
- ⚠ Warning:** Forward Collision Warning may provide a warning in situations where the likelihood of collision may not exist. Stay alert and always pay attention to the area in front of Model 3 so you can anticipate whether any action is required.
- ⚠ Warning:** Forward Collision Warning operates only when driving between approximately 10 km/h and 150 km/h.
- ⚠ Warning:** Forward Collision Warning does not provide a warning when the driver is already applying the brake.

Automatic Emergency Braking

The forward looking camera(s) and the radar sensor are designed to determine the distance from a detected object traveling in front of Model 3. When a frontal collision is considered unavoidable, Automatic Emergency Braking is designed to apply the brakes to reduce the severity of the impact.

When Automatic Emergency Braking applies the brakes, the touchscreen displays a visual warning and sounds a chime. You may also notice abrupt downward movement of the brake pedal. The brake lights turn on to alert other road users that you are slowing down.

Emergency braking in progress

If driving (56 km/h) or faster, the brakes are released after Automatic Emergency Braking has reduced your driving speed by (50 km/h). For example, if Automatic Emergency Braking applies braking when driving 90 km/h, it releases the brakes when your speed has been reduced to 40 km/h.

Automatic Emergency Braking operates only when driving between approximately 10 km/h and 150 km/h.

Automatic Emergency Braking does not apply the brakes, or stops applying the brakes, when:

- You turn the steering wheel sharply.
- You press and release the brake pedal while Automatic Emergency Braking is applying the brakes.
- You accelerate hard while Automatic Emergency Braking is applying the brakes.
- The vehicle, motorcycle, bicycle, or pedestrian is no longer detected ahead.

Automatic Emergency Braking is always enabled when you start Model 3. To disable it for your current drive, touch **Controls** > **Autopilot** > **Automatic Emergency Braking**.

⚠ Warning: It is strongly recommended that you do not disable Automatic Emergency Braking. If you disable it, Model 3 does not automatically apply the brakes in situations where a collision is considered likely.

⚠ Warning: Automatic Emergency Braking is designed to reduce the severity of an impact. It is not designed to avoid a collision.

⚠ Warning: Several factors can affect the performance of Automatic Emergency Braking, causing either no braking or inappropriate or untimely braking, such as when a vehicle is partially in the path of travel or there is road debris. It is the driver's responsibility to drive safely and remain in control of the vehicle at all times. Never depend on Automatic Emergency Braking to avoid or reduce the impact of a collision.

⚠ Warning: Automatic Emergency Braking is designed to reduce the impact of frontal collisions only and does not function when Model 3 is in Reverse.

⚠ Warning: Automatic Emergency Braking is not a substitute for maintaining a safe traveling distance between you and the vehicle in front of you.

⚠ Warning: The brake pedal moves downward abruptly during automatic braking events. Always ensure that the brake pedal can move freely. Do not place material under or on top of the Tesla-supplied driver's floor mat (including an additional mat) and always ensure that the driver's floor mat is properly secured. Failure to do so can impede the ability of the brake pedal to move freely.







Obstacle-Aware Acceleration

Obstacle-Aware Acceleration is designed to reduce the impact of a collision by reducing motor torque if Model 3 detects an object in its driving path. For example, Model 3, while parked in front of a closed garage door with the Drive gear engaged, detects that you have pressed hard on the accelerator pedal. Although Model 3 still accelerates and hits the garage door, the reduced torque may result in less damage.

Obstacle-Aware Acceleration is designed to operate only when all of these conditions are simultaneously met:

- A driving gear is engaged (Drive or Reverse).
- Model 3 is stopped or traveling less than 10 mph (16 km/h).
- Model 3 detects an object in its immediate driving path.

To disable Obstacle-Aware Acceleration, touch **Controls > Autopilot > Obstacle-Aware Acceleration**.

-  **Warning:** Obstacle-Aware Acceleration is designed to reduce the severity of an impact. It is not designed to avoid a collision.
-  **Warning:** Obstacle-Aware Acceleration may not limit torque in all situations. Several factors, including environmental conditions, distance from an obstacle, and a driver's actions, can limit, delay, or inhibit Obstacle-Aware Acceleration.
-  **Warning:** Obstacle-Aware Acceleration may not limit torque when performing a sharp turn, such as into a parking space.
-  **Warning:** Do not rely on Obstacle-Aware Acceleration to control acceleration or to avoid, or limit, the severity of a collision, and do not attempt to test Obstacle-Aware Acceleration. Doing so can result in serious property damage, injury, or death.
-  **Warning:** Several factors can affect the performance of Obstacle-Aware Acceleration, causing an inappropriate or untimely reduction in motor torque. It is the driver's responsibility to drive safely and remain in control of Model 3 at all times.

Limitations and Inaccuracies

Collision Avoidance features cannot always detect all objects, vehicles, bikes, or pedestrians, and you may experience unnecessary, inaccurate, invalid, or missed warnings for many reasons, particularly if:

- The road has sharp curves.
- Visibility is poor (due to heavy rain, snow, fog, etc.).
- Bright light (such as from oncoming headlights or direct sunlight) is interfering with the view of the camera(s).
- The radar sensor is obstructed (dirty, covered, etc.).
- The windshield is obstructing the view of the camera(s) (fogged over, dirty, covered by a sticker, etc.).

 **Warning:** The limitations previously described do not represent an exhaustive list of situations that may interfere with proper operation of Collision Avoidance Assist features. These features may fail to provide their intended function for many other reasons. It is the driver's responsibility to avoid collisions by staying alert, paying attention, and taking corrective action as early as possible.

 **Caution:** If a fault occurs with a Collision Avoidance Assist feature, Model 3 displays an alert. Contact Tesla Service.



How Speed Assist Works

When the Speed Limit Warning is turned on, the touchscreen displays a speed limit as determined by GPS data. You can touch this speed limit sign to automatically change the set speed to the detected speed limit (including any offsets that you have set). Warnings (described later) take effect when you exceed this limit.

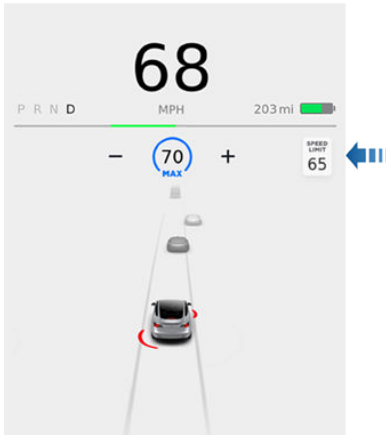

In situations where Speed Assist is unable to determine a speed limit (for example, speed limit signs and GPS data are not available at the current location), or if Speed Assist is uncertain that an acquired speed limit is accurate (for example, although a speed limit sign was initially detected, some time has passed before a subsequent sign has been detected), the touchscreen may not display a speed limit sign and warnings do not take effect.

If you set the speed limit warning to **Display** (see [Controlling Speed Assist](#) on page 89) and exceed the determined speed limit, the speed limit sign on the touchscreen increases in size.

If you set the speed limit warning to **Chime** (see [Controlling Speed Assist](#) on page 89) and exceed the determined speed limit, the speed limit sign on the touchscreen increases in size and Model 3 also sounds a warning chime.

Note: Speed limit warnings go away after ten seconds, or when Model 3 slows down below the specified limit.

Warning: Do not rely on Speed Assist to determine the appropriate speed limit or

driving speed. Always drive at a safe speed based on traffic and road conditions.

Controlling Speed Assist

To adjust the Speed Limit Warning setting, touch **Controls > Autopilot > Speed Limit Warning**, then choose one of these options:

- **Off** - Speed limit warnings do not display and chimes are not sounded.
- **Display** - Speed limit signs display on the touchscreen and the sign increases in size when you exceed the determined limit.
- **Chime** - In addition to the visual display, a chime is sounded whenever you exceed the determined speed limit.

You can also specify how the speed limit is determined:

- **Relative** - The speed limit is determined automatically based on detected traffic signs and GPS data. If desired, you can set a speed limit offset (+ or -) if you want to be alerted only when you exceed the offset speed limit by a specified amount. For example, you can increase the offset to +10 km/h if you only want to be warned when you exceed the speed limit by 10 km/h.
- **Absolute** - Manually specify any speed limit between 30 and 240 km/h.

Note: GPS data is not always accurate. The GPS can miscalculate a road's location and provide the speed limit for a directly adjacent road that may have a different speed limit. For example, the GPS can assume Model 3 is on a freeway or highway when it is actually on a nearby surface street, and vice versa.

Note: Your chosen setting is retained until you manually change it.

Limitations and Inaccuracies

Speed Assist may not be fully functional or may provide inaccurate information in these situations:

- The speed limits stored in the GPS database are incorrect or outdated.
- Model 3 is being driven in an area where GPS data is not available.
- A road or a speed limit has recently changed.

Warning: The list above does not represent an exhaustive list of situations that may interfere with proper operation



Speed Assist

of Speed Assist. Speed Assist may fail to provide warnings for many other reasons.



Overview

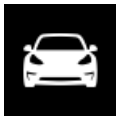

Touch **Controls** on the bottom corner of the touchscreen to control features and customize Model 3 to suit your preferences. The Controls window appears over the map. Touch an option on the left side of the window to display the associated controls and settings. By default, **Quick Controls** displays for quicker access to commonly used settings.



To close the Controls window, touch the **X** in the top left corner, touch **Controls** again, or swipe down on the window.



When an information icon displays beside a specific setting, touch it to display a popup that provides helpful details about the associated setting.

Note: The following illustrations are for demonstration purposes only. Depending on vehicle options, software version and market region, the options available may be different.

Summary of Controls

The screenshot shows the Tesla Controls interface. On the left, a list of controls is displayed, with 'Quick Controls' selected and highlighted. A blue circle with the number '1' points to this list. On the right, the detailed settings for the selected 'Quick Controls' category are shown. A blue circle with the number '2' points to this main viewing area. The settings include: Exterior Lights (OFF, PARKING, ON, AUTO), FRONT FOG (with an information icon), Adjustments (MIRRORS and STEERING WHEEL), FOLD, Windows (WINDOW LOCK), and Display Brightness (100%, AUTO).

1. List of available controls. When you select an item from this list, its associated controls display in the main viewing area.
2. Main viewing area. The options available for your chosen controls category display here.



Quick Controls

Quick Controls provides easy access to the following commonly-used features:

- Exterior lights (see [Lights](#) on page 49).
- Adjust the mirrors (see [Adjusting Exterior Mirrors](#) on page 44).
- Adjust the steering wheel (premium package) (see [Adjusting Steering Wheel Position - Premium Package](#) on page 42).
- Fold the mirrors (see [Mirrors](#) on page 44).
- Lock the rear window switches (see [Windows](#) on page 14).
- Adjust the brightness of the display.

Lights

Control exterior and interior lights (see [Lights](#) on page 49) and turn the following settings on or off:

- **Auto High Beam:** If on, the high beam headlights can automatically switch to low beam when there is light (for example, from an oncoming vehicle) detected in front of Model 3. See [High Beam Headlights](#) on page 50.
- **Headlights after Exit:** If on, the headlights remain on when you stop driving and park Model 3 in low lighting conditions. They automatically turn off after one minute or when you lock Model 3.
- **Steering Wheel Lights:** If on, the arrows associated with the scroll buttons on the steering wheel are backlit when the headlights are turned on.

Locks

Display a list of keys that can access Model 3, remove keys (see [Managing Keys](#) on page 10), and customize how you want door locks to behave:

- **Window Lock:** Lock the rear window switches (see [Windows](#) on page 14).
- **Child-Protection Lock:** If on, safety locks prevent the rear doors from being opened from inside the vehicle (see [Child-Protection Lock](#) on page 13).
- **Unlock on Park:** If on, doors automatically unlock when you engage the Park gear (see [Interior Locking and Unlocking](#) on page 13).
- **Lock Confirmation Sound:** If on, you will hear an audible sound when you lock Model 3.
- **Walk-Away Door Lock:** If on, doors automatically lock when you walk away from the vehicle, carrying your authenticated phone with you (see [Walk-Away Door Lock](#) on page 13).



Display

Manually control the brightness and the **DAY** (light background) or **NIGHT** (dark background) setting of the touchscreen. When set to **AUTO**, the brightness changes automatically between day and night brightness based on ambient lighting conditions.

Brightness: Drag the slider to manually control the brightness level of the touchscreen. When **Auto** brightness is on, the touchscreen is further adjusted based on both the surroundings and by learning your preferences (for example, it remembers the type of manual adjustments you make).

Screen Clean Mode: Disable the touchscreen momentarily for cleaning purposes.

Customize how units are displayed:

- **Time Format:** Choose if time is displayed in 12 or 24 hour format.
- **Energy Display:** Display remaining energy and charging units as either a percentage of battery energy remaining, or as an estimate of the distance that you can drive.
- **Distance:** Choose if miles or kilometers are used when displaying range, speed, energy, trip meters, map searches and navigation routes.
- **Temperature:** Choose if temperature is displayed in °C or °F.
- **Tire Pressure:** Choose if tire pressures are displayed in BAR or PSI.
- **Language:** Choose the language that is displayed on the touchscreen.

Note: Model 3 must be in Park to change the language. When you change the language, you experience a brief delay as the vehicle shuts down and restarts the touchscreen.



Driving

Acceleration: Adjust the amount of acceleration. **Chill** limits acceleration for a slightly smoother and gentler ride, whereas **Standard** provides the normal level of acceleration.

Note: When Chill is selected, **Chill** displays on the touchscreen above the driving speed.

Steering Mode: Adjust the amount of effort required to turn the steering wheel. Sport feels more responsive whereas Comfort feels easier to drive and park (see [Adjusting Steering Effort](#) on page 42).

Regenerative Braking: When you release the accelerator when driving, regenerative braking slows Model 3 and feeds any surplus energy back to the Battery. If set to **LOW**, Model 3 does not slow down as quickly, but also feeds less energy back to the Battery (see [Regenerative Braking](#) on page 56).

Note: Regardless of the setting selected, the energy gained by regenerative braking is reduced if the Battery is full, or is extremely cold or hot (in which case, surplus energy is used to heat or cool it).

Traction Control: Turn slip start on to allow wheels to spin (see [Traction Control](#) on page 58).

Creep: When on, Model 3 applies forward torque in Drive and backwards torque in Reverse when you release the brake pedal (similar to a conventional vehicle with an automatic transmission). The torque moves the vehicle slowly on flat roads, but may require you to press the accelerator pedal in some situations (for example, when on a steep hill or driveway). When off, Model 3 is free rolling when you let your foot off the brake pedal and the motor does not apply torque until the accelerator pedal is pressed. You can adjust this setting only when Model 3 is in Park.

▲ Warning: Never rely on Creep to apply enough torque to prevent your vehicle from rolling down a hill. Always apply brakes to remain stopped or the accelerator to proceed up the hill. Failure can result in property damage and/or a collision.



Autopilot

Control the features that provide a safer and more convenient driving experience (see [About Autopilot](#) on page 66).

- **Cruise Follow Distance:** Adjust the following distance you want to maintain between Model 3 and a vehicle traveling ahead of you (available only if your Model 3 is equipped with Enhanced Autopilot) (see [Traffic-Aware Cruise Control](#) on page 69).
- **Autosteer (Beta):** Enable the auto steering feature (available only if your Model 3 is equipped with Enhanced Autopilot) (see [Autosteer](#) on page 75).
- **Summon (Beta):** Automatically park and retrieve Model 3 from outside the vehicle. See [Summon](#) on page 81.
- **CUSTOMIZE SUMMON:** Specify how Summon operates whenever it parks or retrieves your vehicle.
- **Speed Limit Warning:** Specify the type of warnings, if any, you receive when you exceed the detected speed limit (see [Speed Assist](#) on page 89).
- **Speed Limit:** Specify if you want Speed Assist to use a relative (with offset) or an absolute speed limit (see [Speed Assist](#) on page 89).
- **Offset:** If relative speed limit is selected, set a speed limit offset if you want to be alerted only when you exceed the offset speed limit by a specified amount (see [Speed Assist](#) on page 89).
- **Forward Collision Warning:** Specify if and when you want to receive visual and audible warnings in situations where there is a high risk of a frontal collision (see [Collision Avoidance Assist](#) on page 86).
- **Lane Departure Warning:** Specify if you want the steering wheel to vibrate slightly if a front wheel passes over a lane marking and the associated turn signal is off (see [Lane Assist](#) on page 84).
- **Automatic Emergency Braking:** Specify if you want Model 3 to automatically apply braking when a frontal collision is imminent (see [Collision Avoidance Assist](#) on page 86).
- **Obstacle-Aware Acceleration:** Specify if you want to automatically reduce acceleration when an obstacle is detected in front of your vehicle while driving at low speeds (see [Collision Avoidance Assist](#) on page 86).

Navigation

Increase or decrease the volume of spoken navigation instructions by touching - or +, respectively. Decreasing all the way to the left mutes the instructions. You can also mute navigation instructions when a navigation route is active by touching the volume icon on the turn-by-turn direction list.

Customize how the navigation system works by adjusting these settings:

- Touch **Trip Planner** (if available in your market region) to minimize the time you spend driving and charging (see [Trip Planner](#) on page 106).
- Touch **Online Routing** to be automatically rerouted to avoid heavy traffic (see [Online Routing](#) on page 106).
- Touch **Avoid Ferries** to be automatically rerouted to avoid ferries.
- Touch **Avoid Tolls** to be automatically rerouted to avoid tolls.

Note: You can also display navigation settings by touching the settings icon on the map (see [Maps and Navigation](#) on page 103).

Note: The volume setting applies only to the navigation system's spoken instructions. Volume for Media Player and Phone remains unchanged.



Safety & Security

You can manually apply and release the parking brake (see [Parking Brake](#) on page 57), limit the acceleration and max speed (see [Speed Limit Mode](#) on page 96), and power off the vehicle (see [Powering Off](#) on page 46). You can also turn the following settings on or off:

- **Park Assist Chimes:** If on, you will hear an audible beep when approaching an object while parking (see [Park Assist](#) on page 59).
- **Security Alarm:** Enable the security alarm (see [Security Settings](#) on page 115).
- **Cabin Overheat Protection:** Reduce the temperature of the cabin in extremely hot ambient conditions for a period of up to twelve hours after you exit Model 3 (see [Cabin Overheat Protection](#) on page 101).
Note: Cabin Overheat Protection operates only when the energy remaining in the Battery is above 20%.
- **Allow Mobile Access:** Allow Tesla's mobile applications to access your Model 3 (see [Mobile App](#) on page 10).
Note: To disable Allow Mobile Access, enter your Tesla account credentials on the touchscreen.
- **Data Sharing:** Allow sharing of road measurement data (see [Data Sharing](#) on page 164).
- **PIN to Drive:** To increase security, you can prevent Model 3 from being driven until a 4-digit PIN (Personal Identification Number) is entered (see [PIN to Drive](#) on page 115).

Service

Wiper Service Mode: Make wiper blades easy to access (see [Wiper Blades and Washer Jets](#) on page 140).

Adjust Headlights: Make adjustments to the level of the headlights (see [Headlight Adjustments](#) on page 50).

⚠ Caution: Headlights should only be adjusted by Tesla Service.

Transporting: Prepare Model 3 for transporting by keeping it in Neutral (which disengages the parking brake and prevents damage to the rear motor that is caused by wheels turning as Model 3 is pulled onto a flatbed truck). See [Instructions for Transporters](#) on page 158.

Owner's Manual: Display this manual.

Note: You can also display this manual by touching the Tesla "T" at the top of the touchscreen.

Factory Reset: Erase all personal data (saved addresses, music favorites, etc.) and restore all customized settings to their factory defaults.

Glovebox

Open the glovebox (see [Glovebox](#) on page 20).

Naming Your Vehicle

To further personalize Model 3, you can name it. The name you give your Model 3 will appear in the mobile app. To name your vehicle, touch the Tesla "T" at the top center of the touchscreen, then touch **Name Your Vehicle** (or touch the vehicle's existing name). Enter the new name in the popup then touch **Save**.

Speed Limit Mode

Speed Limit Mode allows you to limit the acceleration and maximum speed – between 50 and 90 mph (80 and 145 km/h) – of your Model 3. This feature is protected by a 4-digit PIN that you create when enabling it for the first time, and which must be re-entered in order to disable and re-enable it.





If your Model 3 comes within approximately 3 mph (5 km/h) of the selected maximum speed, a chime sounds and text appears on the touchscreen above the driving speed. Additionally, your mobile app will send you a notification.

To enable Speed Limit Mode:

1. Ensure the vehicle is in Park.
2. Touch **Controls** > **Safety & Security** > **Speed Limit Mode** on the touchscreen or **CONTROLS** in your mobile app.
3. Select the maximum driving speed that you would like to limit the vehicle to.
4. Drag the slider to the on position.
5. Enter the 4-digit PIN that will be required to disable Speed Limit Mode.

Note: If you forget the PIN, you can enter your Tesla Account login credentials to disable Speed Limit Mode.

-  **Warning:** Driving downhill can increase driving speed, causing the vehicle to exceed the selected maximum speed.
-  **Warning:** Speed Limit Mode is not a replacement for good judgment, driver training, and monitoring roadway speed limits and driving conditions. Accidents can occur at any speed.

Erasing Personal Data

You can erase all personal data (saved addresses, music favorites, HomeLink programming, etc.) and restore all customized settings to their factory defaults. This is useful when transferring ownership of Model 3. Touch **Controls** > **Service** > **FACTORY RESET**. Before erasing, Model 3 verifies your credentials by prompting you to enter the user name and password associated with your Tesla Account.



Overview of Climate Controls

Climate controls are always available at the bottom of the touchscreen. To turn the climate control system on, touch the fan icon or adjust the cabin temperature. To turn it off, touch the fan icon and then touch the off button near the center of the popup window.

By default, climate control is set to the Auto setting, which maintains optimum comfort in all but the most severe weather conditions. When you adjust the cabin temperature in the Auto setting, the system automatically adjusts the heating, air conditioning, air distribution, and fan speed to maintain the cabin at your selected temperature. To override the Auto setting, touch the fan icon, turn off the Auto setting, then manually adjust your settings (see [Adjusting Climate Control Settings](#) on page 99). If you've manually adjusted individual settings, you can also revert back to Auto at any time by touching **AUTO** on the climate control popup window.

Note: The following illustration is provided for demonstration purposes only. Depending on vehicle options, software version, market region, and settings, the information displayed may be slightly different.

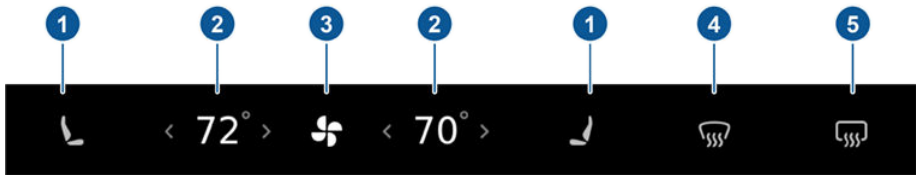

1. Seat heaters operate at three setting levels from 3 (highest) to 1 (lowest). When operating, the associated seat icon displays twisting lines that turn red to indicate the setting level. If equipped with the premium package, rear seats are also equipped with seat heaters (see [Operating Seat Heaters](#) on page 100).

Note: To conserve energy, a seat heater in a passenger seating position automatically turns off if an occupant is not detected when the Drive gear is engaged.

2. Touch an up or down arrow to change the cabin temperature. To apply a temperature setting to both the driver and passenger side, touch **SYNC** on the popup that appears when you touch an arrow. When you apply the same temperature to both sides, only one temperature setting displays. Touch **SYNC** again to display separate temperature settings for the driver and passenger.
3. Touch the fan icon to turn on climate control and to manually customize settings to suit your preferences (see [Adjusting Climate Control Settings](#) on page 99). Touch and hold the fan icon to quickly turn off climate control. If your vehicle is equipped with the premium package, touch this icon to access controls for the rear seat heaters.
4. The windshield defroster distributes air flow to the windshield. Touch once to defog the windshield (the icon turns blue). Touch a second time to defrost the windshield (the icon turns red and the heating and fan operate at maximum levels). Touch a third time to turn off and restore the air distribution, heating, and fan to their previous settings.
5. Touch to warm up the rear window. When operating, the icon turns red. After 15 minutes, the rear window defroster automatically turns off. If equipped with the premium package, the exterior side mirrors are also heated whenever the rear window defroster is operating.

Warning: To avoid burns resulting from prolonged use, individuals who have peripheral neuropathy, or whose capacity to feel pain is limited because of diabetes, age, neurological injury, or some other condition, should exercise caution when using the climate control system and seat heaters.

Note: The climate control system is powered by the high voltage battery. Therefore, prolonged use decreases driving range.



Adjusting Climate Control Settings

To override the Auto setting, touch the fan icon, turn off the Auto setting, then use the buttons that appear to manually adjust settings.

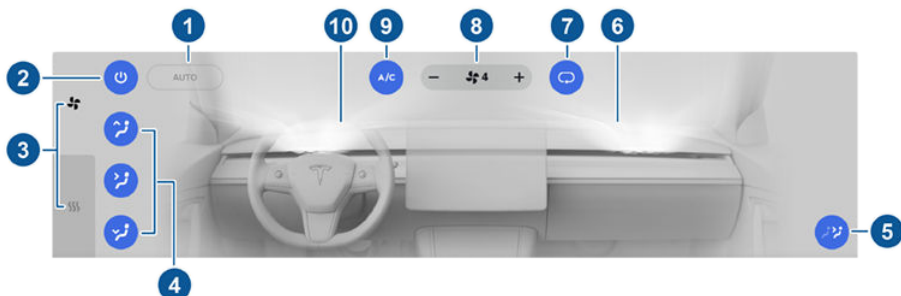

In addition to the settings shown, if Model 3 is in Park, the Keep Climate On setting displays when you touch the fan icon (see [Keep Climate On and Dog Mode](#) on page 101).

1. Touch **AUTO** to turn the Auto setting on or off.
2. Touch to turn the climate control system off.
3. If equipped with the premium package, the climate control settings window has two tabs. The general settings tab displays by default and is represented by the fan icon. Touch the seat heater icon to access controls for both the front and rear seat heaters (see [Operating Seat Heaters](#) on page 100).
4. Choose where air flows into the cabin (windshield, face-level, or foot-level vents). You can choose more than one location.

Note: When air is directed to the foot-level vents, air continues to flow to the windshield vents to assist in defogging. When air is directed to the face-level vents, air does not flow to the windshield.

5. Touch to turn air flow to the rear cabin area on or off. When on, air flows from the vents located at the back of the center console. See [Adjusting the Rear Vents](#) on page 100.
6. Touch to adjust air flow from the front passenger vent. See [Adjusting the Front Vents](#) on page 100.
7. Touch to choose how air is drawn into Model 3. If on, air inside Model 3 is recirculated. If off, outside air is drawn into Model 3.
8. Touch + or - to increase or decrease the fan speed.

Note: Adjusting the fan speed may change the selected setting for how air is drawn into Model 3 in order to increase or reduce air flow.

9. Touch to turn the air conditioning system on or off. Turning it off reduces cooling, but saves energy.

Note: Because Model 3 runs much quieter than a gasoline-powered vehicle, you may notice the sound of the air conditioning compressor as it is operating. To minimize noise, reduce the fan speed.

10. Touch to adjust air flow from the driver's vent. See [Adjusting the Front Vents](#) on page 100.



Operating Seat Heaters

To control the front seat heaters for the driver and passenger, touch the corresponding control on the main climate control area at the bottom of the touchscreen. To control the rear seat heaters (or access duplicate controls for the front seat heaters), touch the fan icon, then touch the seat heater icon followed by the seat for which you want to adjust heating. Seat heaters operate at three setting levels from 3 (highest) to 1 (lowest). When operating, the associated seat icon displays twisting lines that turn red to indicate the setting level. You can touch **All Off** to turn off all seat heaters simultaneously.

Adjusting the Front Vents

Model 3 has a unique horizontal face-level vent that spans the width of the dashboard. Using the touchscreen, you can pinpoint exactly where you want to direct the air flowing from this vent when heating or cooling the front cabin area.

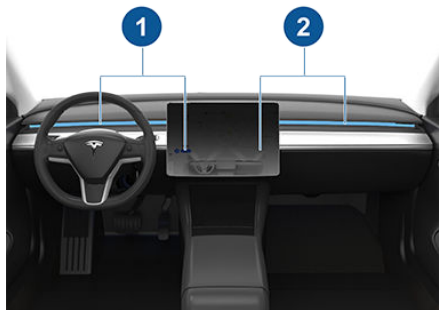

1. Driver vent and controls
2. Passenger vent and controls

When the face-level vent is on you can adjust the direction of the air flow from each vent. To adjust the direction of the air flow, simply touch the radiating air waves from the corresponding vent on the touchscreen. The air flows in a single stream when centered or splits into mirrored air streams when air is directed outward or inward from the center of the vent.

Note: When you split a vent into two separate air flows, the air flow in each direction is not as strong as when all air is flowing in a single direction.

Note: Outside air is drawn into Model 3 through the grill in front of the windshield.

Keep the grill clear of obstructions, such as leaves and snow.

Adjusting the Rear Vents

Model 3 has vents located at the back of the center console where air flows from when the setting is turned on from the touchscreen. To direct the flow of air in the rear cabin area, adjust the vents at the rear of the center console up, down, or from side to side as necessary.

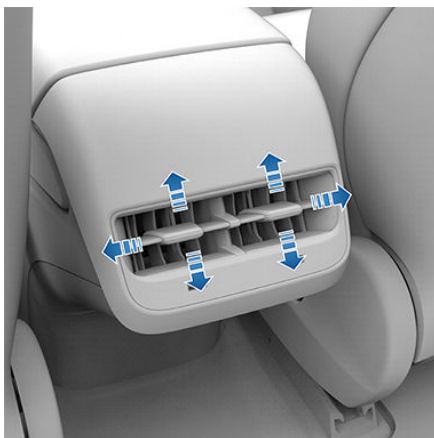



Keep Climate On and Dog Mode

The **Keep Climate On** and **Dog** settings allow you to keep the climate control system running when in Park, even after you've left Model 3. Both settings are useful when it is important to maintain the cabin temperature in hot or cold weather conditions (for example, when leaving groceries in Model 3 on hot days, you may want to use Keep Climate On to prevent spoilage). Dog mode keeps your pet comfortable while also displaying the current cabin temperature on the touchscreen so people nearby are informed that your pet does not need to be rescued.

Note: To initiate Keep Climate On or Dog Mode, the Battery's charge level must be at least 20%.

To operate Keep Climate On or Dog Mode:

1. Engage the Park gear. The **Keep Climate On** and **Dog** settings are available only when Model 3 is in Park.
2. If necessary, adjust the climate settings.
3. Touch the fan icon then touch **Keep Climate On** or **Dog**.

The climate control system maintains your climate settings until you shift out of Park or manually turn it off. If the Battery's charge level drops to ten percent, the climate control system automatically turns off and the Tesla mobile app sends you a notification reminding you to check on anything that you have left in Model 3.

The next time you drive Model 3, the climate control system continues operating using the previous settings from your most recent trip.

Note: Software updates can not be performed when Dog Mode or Keep Climate On is active.

- ⚠ Warning:** You can adjust the climate control system remotely using the mobile app. However, if you use the mobile app to turn off the climate control system, Keep Climate On and Dog Mode stop operating.
- ⚠ Warning:** Keep Climate On and Dog Mode turn off when the battery charge drops to 20%. Avoid using when the battery charge is low. When leaving a dog or pet in Model 3, you must ensure that you have your phone with you and that the Tesla mobile app is running. This allows you to proactively monitor the cabin temperature. To ensure the safety and comfort of your dog or pet, always make sure you have adequate cellular coverage

to receive notifications and allow enough time to return to Model 3 should the climate control system stop operating—on hot days, the cabin temperature can become dangerously high within a few minutes.

- ⚠ Warning:** Check local laws for any restrictions on leaving pets unattended in your vehicle.
- ⚠ Warning:** Never leave a child unattended in your vehicle.

Cabin Air Filter

Model 3 has an air filter that prevents pollen, industrial fallout, road dust and other particles from entering through the vents. The air filter should be replaced when necessary. Contact Tesla.

Cabin Overheat Protection

The climate control system can reduce the temperature of the cabin in extremely hot ambient conditions for a period of up to twelve hours after you exit Model 3. Touch **Controls > Safety & Security > Cabin Overheat Protection** and choose:

- **OFF:** Disable Cabin Overheat Protection.
- **NO A/C:** Only the fan operates when the cabin temperature exceeds 40° C. This option consumes less energy but the cabin temperature may exceed 40° C.
- **ON:** The air conditioning operates when the cabin temperature exceeds 40° C.

Note: Cabin Overheat Protection operates only when the energy remaining in the Battery is above 20% .

- ⚠ Warning:** Never leave children or pets in the vehicle unattended. Due to automatic shut-off or extreme outside conditions, the inside of the vehicle can become dangerously hot, even when Cabin Overheat Protection is enabled.

Climate Control Operating Tips

- You can direct the face-level vents toward the windows to help defrost or defog them.
- When you use the mobile app to turn on the climate control system, it automatically turns off after four hours or if the charge level drops to 20%. To cool or heat the cabin for a longer period, you must turn it on again.



- If the climate control system is louder than you prefer, manually reduce the fan speed.
- In addition to cooling the interior, the air conditioning compressor also cools the Battery. Therefore, in hot weather, the air conditioning compressor can turn on even if you turned it off. This is normal because the system's priority is to cool the Battery to ensure it stays within an optimum temperature range to support longevity and optimum performance.
- To ensure the climate control system operates efficiently, close all windows and ensure that the exterior grill in front of the windshield is free of ice, snow, leaves, and other debris.
- In very humid conditions, it is normal for the windshield to fog slightly when you first turn on the air conditioning.
- It is normal for a small pool of water to form under Model 3 when parked. Extra water produced by the dehumidifying process is drained underneath.
- To reduce the temperature in the cabin in hot weather conditions, the fan may turn on to vent the cabin when the vehicle is parked. This occurs only if the battery's charge level is above 20%.



Overview

The touchscreen displays a map at all times. Hold and drag a finger to move the map in any direction. Rotate the map in any direction by holding and turning two fingers.

Touch the icon in the top right corner of the map to set the map's orientation:



North Up - North is always at the top of the screen.



Heading Up - The direction you are driving is always at the top of the screen. The map rotates as you change direction. This icon has an integrated compass that indicates the direction you are driving.

Note: When navigating, this icon also allow you to toggle to the route overview which allows you to view an overview of your navigation route (see [Navigating](#) on page 104).

When you rotate or move the map, your current location is no longer tracked. The message "Tracking Disabled" displays briefly next to the map orientation icon and the icon turns gray. To re-enable tracking, touch the map's orientation icon to choose North Up or Heading Up.

Touch the + and - icons to zoom the map in and out on your current or chosen location. When you zoom in or out using these icons, tracking remains enabled.

Touch the following icons to customize what the map displays and to access navigation settings:

Note: These icons disappear after a few seconds when not in use. Touch anywhere on the map to re-display them.



Display/hide satellite imagery (if equipped with premium connectivity).



Display/hide traffic conditions (if equipped with premium connectivity). Green lines indicate no traffic; orange lines indicate light traffic; red lines indicate moderate traffic; and pink lines indicate heavy traffic. To ensure traffic is easy to identify along a navigation route, green traffic lines display under the blue route line, whereas orange, red, and pink traffic lines display on top of the blue route line.



Display/hide all charging locations and a popup list that includes the city and proximity of the corresponding stations on the map. Charging locations include Tesla Superchargers, destination chargers, and public chargers that you have used previously. See [Charging Locations](#) on page 105.

Note: Superchargers are always displayed on the map, even when charging locations are not displayed.



Increase or decrease the volume of spoken navigation instructions by touching - or +, respectively. Decreasing all the way to the left mutes the instructions. You can also mute navigation instructions when a navigation route is active by touching the volume icon on the turn-by-turn direction list.

Customize how the navigation system works by adjusting these settings:

- Touch **Trip Planner** (if available in your market region) to minimize the time you spend driving and charging (see [Trip Planner](#) on page 106).
- Touch **Online Routing** to be automatically rerouted to avoid heavy traffic (see [Online Routing](#) on page 106).
- Touch **Avoid Ferries** to be automatically rerouted to avoid ferries.
- Touch **Avoid Tolls** to be automatically rerouted to avoid tolls.

Note: You can also access the above navigation settings by touching **Controls > Navigation**.

Note: The volume setting applies only to the navigation system's spoken instructions. Volume for Media Player and Phone remains unchanged.

Drop a pin by pressing and holding your finger anywhere on the map. When you drop a pin, or touch an existing pin, the chosen location is centered on the map, and a popup window provides information about the location. From this popup, you can navigate to the location, call the location (if a phone number is available) and add or remove the location from your list of favorite destinations (see [Recent, Favorite, Home and Work Destinations](#) on page 106).

Navigating

To navigate to a location, touch **Navigate**, send the destination from your phone, or speak a voice command (see [Using Voice Commands](#) on page 114). You can enter or speak an address, landmark, business, etc. You can also choose a saved **Home** or **Work** location and select from a list of recently used locations (the most recent displays at the top of the list), including charging stations you have visited.

When you specify a location, the touchscreen zooms out to provide an overview of the route you need to travel, and, after calculating the route, zooms back in to your starting point and begins to provide instructions, and a turn-by-turn direction list that displays the first navigation instruction and an estimate of total mileage, driving time, and arrival time.

Note: You can remotely start navigation in your vehicle by using your iOS® or Android™ device's "share" functionality after giving access to the Tesla mobile app.

You can touch the instruction to expand the list to show each turn on your journey. Note the following about the turn-by-turn direction list:

- A battery displays below the destination to provide an estimate of how much battery energy will remain when you reach your destination. Touch to expand battery information to show a round trip estimate back to your starting point. See [Predicting Energy Usage](#) on page 106.
- If charging is needed to reach your destination and Trip Planner is enabled (and available in your market region), the navigation route automatically includes Supercharger stops (see [Trip Planner](#) on page 106) and you may need to touch **BEGIN TRIP** to initiate navigation.
- If you won't have enough energy to reach your destination and there is no Supercharger on the route, an alert tells you that charging is needed to reach your destination.
- Each turn is preceded by the distance to the maneuver.
- To see the bottom of the list, you may need to drag the list upward.
- Touch the top of the list again to minimize it.

While navigating, the map tracks your location and displays the current leg of your trip. You can display the entire route at any time.



The route overview icon displays when a navigation route is active. Touch this icon at any time to view an overview of your navigation route, or to change the orientation of the map (see [Overview](#) on page 103), which also zooms the map to show the current leg of your trip. The black pin at the end of the route line represents your destination.



Mute/unmute navigation volume.

Note: You can also mute the volume of the navigation system by pressing the scroll button on the left side of the steering wheel while navigation instructions are being spoken. A volume control specific to navigation instructions is also available by touching the settings icon on the map (see [Overview](#) on page 103).

To stop navigating, touch **CANCEL**, located below the turn-by-turn direction list.

Note: If a data connection is not available, onboard maps allow you to navigate to any location, but you must enter the location's exact and complete address.

Charging Locations

Superchargers always display on the map, represented by red pins that you can touch to display more information about the Supercharger location, navigate to it, or mark it as a favorite. When you touch the pin for a Supercharger location on the map, information about the Supercharger location is displayed, including the total number of Superchargers, the number of Superchargers available, the address of the Supercharger, and its approximate distance from you. The popup also displays amenities that are available at the Supercharger location, including restrooms, restaurants, lodging, shopping, and Wi-Fi.



The Supercharger location is operational. At locations that have multiple Superchargers, a row of bars displays above the icon, with each bar representing a Supercharger. This provides a quick visual to indicate how many superchargers are in use. If a Supercharger is in use, the bar is filled in.

Note: A supercharger pin is colored black if the supercharger is on your current navigation route.



The Supercharger location may be out of operation or is operating at a reduced capacity. Touch the pin to display details.

Touch the map's charging icon to display all nearby charging stations of the map. In addition to the Superchargers that are always displayed, the map shows destination chargers and any public charging stations that you have previously used. Display details about a charging location by touching its pin.



The location is equipped with a Tesla Wall Connector. Touch to display more information such as usage restrictions and available charge current. The charging list also displays your proximity to these charging stations.

Note: When the map is zoomed out and more than one Tesla Wall Connector is available in an area, the pin is round and displays the number of stations. Touch the pin to zoom in. Then you can touch an individual pins for detail about the charging location.



Predicting Energy Usage

When navigating to a destination, Model 3 helps you anticipate your charging needs by calculating the amount of energy that remains when you reach your destination. The calculation is an estimate based on driving style (predicted speed, etc.) and environmental factors (elevation changes, temperature, etc.). When navigating, the map displays this calculation at the bottom of the expanded turn-by-turn direction list (see [Navigating](#) on page 104). When the turn-by-turn direction list is compressed, touch the top of the list to expand it.

Throughout your route, Model 3 monitors energy usage and updates the calculation. A popup warning displays at the bottom of the turn-by-turn direction list in these situations:

- A yellow warning displays when you have very little energy remaining to reach your destination and should drive slowly to conserve energy. For tips on conserving energy, see [Getting Maximum Range](#) on page 63.
- A red warning displays when you must charge to reach your destination.

If you also want to know if you have enough energy for a round trip, touch the energy calculation to display an estimate of your round trip energy usage.

Online Routing

Model 3 detects real-time traffic conditions and automatically adjusts the estimated driving and arrival times based on traffic. In situations where traffic conditions will delay your estimated time of arrival and an alternate route is available, the navigation system can reroute you to your destination. To turn this feature on or off, touch the map's settings icon (see [Overview](#) on page 103), then touch **Online Routing**. You can also specify the minimum amount of minutes that must be saved before you are rerouted by touching the arrows associated with the **Re-Route if it saves more than** setting.

Trip Planner

Trip Planner (available in some market regions) helps you take longer road trips with confidence. If reaching your destination requires charging, Trip Planner routes you through the appropriate Supercharger locations. Trip Planner selects a route and provides charging times to minimize the amount of time you spend driving and charging. To enable Trip Planner, touch the map's settings icon (see [Overview](#) on page 103), then touch **Trip Planner**.

When Trip Planner is enabled and charging is required to reach your destination, the turn-by-turn direction list includes Supercharger stops and a recommended charging time at each Supercharger, and an estimate of how much energy will be available when you arrive at the Supercharger.

To remove Supercharger stops and display only directions, touch **Remove charging stops** at the bottom of the list of directions (if you remove charging stops, the turn-by-turn direction list may display an alert indicating that charging is needed to reach your destination). To add Supercharger stops to the directions, touch **Add charging stops**.

While charging at a Supercharger, the charging screen displays the remaining charging time needed to drive to your next Supercharger stop, or destination (if no further charging is needed). If you charge for a shorter or longer length of time, the charging time for subsequent Supercharger stops is adjusted.

Note: You can also monitor remaining charging time needed in the Tesla Mobile App.

Note: If a Supercharger located on your route experiences an outage, Trip Planner displays a notification and reroutes you to a different Supercharger location.

If Trip Planner estimates that you won't have enough energy for your round trip, and there are no Superchargers available on your route, Trip Planner displays an alert at the top of the turn-by-turn direction list notifying you that charging is needed to reach your destination.

Recent, Favorite, Home and Work Destinations

When you touch **Navigate** on the map, a list of **Recent** destinations appear and you can easily navigate to any recent destination by selecting it from the list.



If you frequently drive to a destination, you may want to add it as a favorite to avoid having to enter the location's name or address each time. When you add a destination as a Favorite, you can easily navigate to it by touching **Navigate > Favorites** and then selecting it from the list of favorites.



To add a destination to your Favorites list touch its pin on the map, then touch the heart icon on the popup window that appears. You will be prompted to name the Favorite. Enter a name (or leave as-is to accept the default name), then touch **Add to Favorites**. The heart becomes solid gray and the destination is included on the Favorites list.

To delete a Recent or Favorite destination, touch and hold it down briefly, then touch the **X** that appears.

The top of the navigation list also provides shortcuts for **Home** and **Work** locations. Touch to set an address to either of these locations. After entering the address, touch **SAVE AS HOME** or **SAVE AS WORK**. Then simply touch these shortcuts whenever you want to navigate home or to work.

To change the location associated with Home or Work, press and hold the shortcut icon and enter a new address in the popup window. To delete, press and hold the shortcut button, then touch **CLEAR HOME** or **CLEAR WORK**.

Note: Based on your usage patterns, you may be prompted to save a location as Home or Work.

Note: Once a Home or Work location is saved, Model 3 may prompt you to navigate to your Work location in the mornings and to your Home location in the evenings and tell you how long it will take to arrive based on current traffic conditions.

For security reasons, if you sell Model 3, it is recommended that you delete your Home and Work Locations. You can delete these individually or you can perform a factory reset to erase all personal data (see [Erasing Personal Data](#) on page 97).

Map Updates

As updated maps become available, they are automatically sent to Model 3 over Wi-Fi. To ensure you receive them, periodically connect Model 3 to a Wi-Fi network (see [Connecting to Wi-Fi](#) on page 118). The touchscreen displays a message informing you when new maps are installed.



Overview



Touch the Media Player icon at the bottom of the touchscreen to listen to FM or stream music (Tuneln) or podcasts (if available). You can also play audio files from a Bluetooth or USB-connected device.

Media Player provides three different levels of viewing that you can access by dragging the Media Player window upward or downward. Initially, just the Miniplayer displays. The Miniplayer, which occupies the least amount of space on the touchscreen, displays what's currently playing and provides only the basic functions, mostly associated with what's playing. Drag upward to display Recents and Favorites and access the icons you can use to change your media source (described next). Drag upward again to browse through all available options for the chosen type of source content.

Use the icons across the bottom of Media Player to change your media source (for example, FM, Streaming, or a Bluetooth-connected device). Use the tabs on the left to narrow down the type of content you want to browse through—the associated content displays on the right. For Radio, you can browse through Favorite Stations or you can touch **Direct Tune** to enter the frequency of a specific channel. For Streaming, you can browse through Favorites, Top Stations, DJ Series, and Genres. For Tuneln, you can browse through top podcasts, top stations or you can touch browse to filter by multiple options such as music, talk, sports, etc.

Volume Control

Roll the scroll button on the left side of the steering wheel up or down to increase or decrease volume respectively. The scroll button adjusts the volume for media, navigation instructions, or phone calls, based on what is currently being heard through the speakers. You can also adjust the volume by touching the arrows associated with the speaker icon on the bottom of the touchscreen.

To mute the volume, press the left scroll button. Press again to unmute.

Note: Pressing the left scroll button during a phone call mutes both the sound and your microphone.

Note: If you're playing media and you receive a phone call, or the navigation system is speaking directions, the volume of what you are listening to is temporarily muted.

Searching Media Content



Touch Media Player's magnifying glass icon to search for a particular song, album, artist, podcast, or station. Select a filter to narrow the scope of your search, or leave it at its default setting to include top results from all available source content.

Note: Use voice commands to search hands-free (see [Using Voice Commands](#) on page 114).

FM Radio



If available in your market region and location, Media Player provides FM radio stations that you can select from the Radio source. Touch the next or previous arrows to move from one frequency to the next (or previous). Or touch **Direct Tune** to enter a specific frequency.

For easy access to radio stations you listen to frequently, mark it as a favorite so it's readily available in the Favorites list (see [Favorites and Recents](#) on page 109).

Internet Radio

If equipped with premium connectivity, internet radio services are available over a data connection. To listen to Internet radio services, touch the Tune Internet radio, touch Media Player's streaming icon and choose the streaming service you want to listen (such as **Tuneln**).



By default, TuneIn uses a Tesla account that has been set up for you. To sign in to your own TuneIn account, scroll to the bottom of any **TuneIn** window, touch **Sign In**, and enter your sign in information.

Note: When playing a TuneIn podcast, you can rewind or fast forward to any location in the podcast. On the Miniplayer, drag the slider to the desired location or touch the rewind or fast forward icons to move back or forward 15 seconds at a time, respectively.

Browse through the available categories and/or stations, and then touch what you want to play. When browsing through a large category such as genres, you may need to drag the window upward. When you choose an option that displays multiple results on a new window, touch the **BACK** button at the top of the window to return to the main browse page.

You can also use voice commands (available when speaking the English language) to play a specific song, artist, or album from an Internet radio service (see [Using Voice Commands](#) on page 114).

When listening to internet radio, the options available on Miniplayer vary depending on what you are listening to:

- Touch the next (or previous) arrows to play the next (and in some cases previous) available station, episode, or track being provided by the Internet radio service.
- Touch the **thumbs up** or **thumbs down** icon to like or dislike a song or podcast. When you like a song, the radio station plays similar songs. When you dislike a song, the song won't be played again.
- Touch the **DJ** icon (if available) to include commentary for the content you are streaming. DJ commentary includes music history and behind-the-scenes stories.

Favorites and Recents

For most source content, your favorites display at the top of Media Player's expanded view for easy access (Streaming, TuneIn, Phone, or USB).



To add a currently playing radio station, podcast, or audio file to your Favorites list, touch the **Favorites** icon on Miniplayer.



To remove an item as a favorite, touch the highlighted **Favorites** icon on Miniplayer. You can also remove multiple favorites by expanding Miniplayer one level to show all favorites for the applicable type of source content. Then press and hold any favorite. An **X** appears on all favorites and you can then touch the **X** associated with any favorite you want to remove from your Favorites list.

To see selections that you have recently played, scroll up one level from Miniplayer and touch **Recent**. Your recently played selections are updated continuously so you don't need to remove them.

Note: Selections you play on FM radio stations do not display in your Recent selections.

Playing Media from Devices



You can play audio files from a Bluetooth-connected device (like a phone) or a USB-connected flash drive. When you connect a Bluetooth-capable device, the name of the device displays when you choose the Phone source. When you connect a USB flash drive, Media Player displays the USB source content.

To play the next song in a selected playlist or album, touch the previous or next arrows on the Miniplayer. You can also shuffle tracks in a playlist or repeat a playlist or track using the shuffle/repeat icons (if available).

USB Connected Flash Drives

Connect a flash drive to a front USB connection (see [Interior Storage and Electronics](#) on page 20). Touch **Media Player > USB**, and then touch the name of the folder that contains the song you want to play. After you display the contents of a folder on the USB connected flash drive, you can touch any song in the list to play it. Or use the previous and next arrows in Miniplayer to scroll through your songs.



Note: To play media from a USB connection, Model 3 recognizes flash drives only. You can play media from other types of devices (such as an iPod) by connecting to the device using Bluetooth.

Note: Media Player supports USB flash drives with FAT32 formatting (NTFS and exFAT are not currently supported).

Note: Use a USB connection located at the front of the center console. The USB connections at the rear of the console are for charging only.

Bluetooth[®] Connected Devices

If you have a Bluetooth-capable device such as a phone that is paired and connected to Model 3 (see [Pairing a Bluetooth Phone](#) on page 111), you can play audio files stored on it. You can also stream a music service from it (for example, Pandora or Spotify). Choose Media Player's **Phone** source, then touch the name of your Bluetooth-connected device, and then touch **CONNECT**.

Your Bluetooth device begins playing the audio file that is currently active on your device, and Media Player displays the Miniplayer view. If no audio file is playing on your device, use your device to choose the audio file you want to listen to. When the file begins to play, you can then use Miniplayer's next and previous icons to play other tracks.

Note: To play media from a Bluetooth-connected device, ensure that access to the device's media is turned on (see [Pairing a Bluetooth Phone](#) on page 111).

Audio Settings



Press the equalizer icon at the bottom corner of Media Player to access audio settings for tone and balance. Other settings may be available based on your vehicle features and market region. For example, if equipped with the premium package, you can turn immersive sound on and off.

To adjust any of the five frequency bands (Bass, Bass/Mid, Mid, Mid/Treble, and Treble) drag the corresponding slider up or down the decibel (dB) bar.

To adjust balance, touch **Balance** and drag the center circle of the cross bars to the location in Model 3 where you want to focus the sound.



Bluetooth® Compatibility

You can use your Bluetooth-capable phone hands-free in Model 3 provided your phone is within operating range. Although Bluetooth typically supports wireless communication over distances of up to approximately 9 meters, performance can vary based on the phone you are using.

Before using your phone with Model 3, you must pair it. Pairing sets up Model 3 to work with your Bluetooth-capable phone (see [Pairing a Bluetooth Phone](#) on page 111).

Note: Authenticating your phone to use as a Model 3 key (see [Keys](#) on page 7) does not also allow you to use the phone hands-free, play media from it, etc. You must also pair it as described below.

You can pair up to ten Bluetooth phones. Model 3 always automatically connects to the last phone that was used (provided it is within range). If you want to connect to a different phone, see [Connecting to a Paired Phone](#) on page 112.

Note: On many phones, Bluetooth turns off if the phone's battery is low.

Note: In addition to phones, you can also pair Bluetooth-enabled devices with Model 3. For example, you can pair an iPod Touch or an iPad or Android tablet to stream music.

Pairing a Bluetooth Phone

Pairing allows you to use your Bluetooth-capable phone hands-free to make and receive phone calls, access your contact list, recent calls, etc. It also allows you to play media files from your phone. Once a phone is paired, Model 3 can connect to it whenever the phone is within range.

To pair a phone, follow these steps while sitting inside Model 3:

1. Ensure both the touchscreen and the phone are powered on.
2. On your phone, enable Bluetooth and ensure it is discoverable.
Note: On some phones, this may require you to go to Bluetooth Settings for the remainder of the procedure.
3. Touch the Bluetooth icon on the top of the touchscreen.
4. On the touchscreen, touch **Add New Device** > **Start Search**. The touchscreen displays a list of all available Bluetooth devices within operating distance.

5. On the touchscreen, touch the phone with which you want to pair. Within a few seconds, the touchscreen displays a randomly generated number, and your phone should display the same number.
6. Check that the number displayed on your phone matches the number displayed on the touchscreen. Then, on your phone, confirm that you want to pair.
7. If prompted on your phone, specify whether you want to allow Model 3 to access your contacts and media files.

When paired, Model 3 automatically connects to the phone, and the touchscreen displays the Bluetooth symbol next to the phone's name to indicate that the connection is active.

Importing Contacts and Recent Calls

Once paired, you can use the Bluetooth settings screen (touch the Bluetooth icon on the touchscreen's top status bar) to specify whether you want to allow access to your phone's contacts and recent calls. If access is turned on, you can use the phone app to display, and make calls to, people in your list of contacts and on your recent calls lists (see [Using the Phone App](#) on page 112).

Note: Before contacts can be imported, you may need to either set your phone to allow syncing, or respond to a popup on your phone to confirm that you want to sync contacts. This varies depending on the type of phone you are using. For details, refer to the documentation provided with your phone.

Note: You can turn access to your contacts and recent calls on or off at any time by displaying the Bluetooth settings screen, choosing the phone, and then changing the setting associated with contacts and recent calls.

Unpairing a Bluetooth Phone

If you want to disconnect your phone and use it again later, simply touch **Disconnect** on the Bluetooth settings screen. If you do not want to use your phone with Model 3 again, touch **Forget This Device**. Once you forget a device, you need to pair it again if you want to use it with Model 3 (see [Pairing a Bluetooth Phone](#) on page 111).

Note: Your phone automatically disconnects whenever you leave Model 3.



Note: Unpairing the phone has no effect on using the phone as a key. To forget an authenticated phone, see [Keys](#) on page 7.

Connecting to a Paired Phone

Model 3 automatically connects with the last phone to which it was connected, provided it is within operating range and has Bluetooth turned on. If the last phone is not within range, it attempts to connect with the next phone that it has been paired with.

To connect to a different phone, touch the Bluetooth icon on the top of the touchscreen. The Bluetooth window displays a list of paired phones. Choose the phone you want to connect to, then touch **Connect**. If the phone you want to connect to is not listed, you must pair the phone. See [Pairing a Bluetooth Phone](#) on page 111.

When connected, the Model 3 touchscreen displays the Bluetooth symbol next to the phone name to show that the connection is active.

Using the Phone App

When your phone is connected to Model 3 using Bluetooth, and you have allowed access to your phone's contacts (see [Importing Contacts and Recent Calls](#) on page 111), you can use the phone app to display and make a hands-free call to anyone listed on your phone:

- **Recent Calls** list. The list displays calls in chronological order with the most recent call listed first. You can display all calls or just those that are missed, incoming, or outgoing.
- **Contacts**: Contacts are listed in alphabetical order and can be sorted by first name or last name. You can also choose a letter on the right side of the list to quickly scroll to the names that begin with the selected character. When you touch a name on your contacts list, the contact's available number(s) displays on the right pane, along with other available information (such as address). Touch the contact's number to make a call.

Making a Phone Call

You can make a phone call by:

- Speaking a voice command (see [Using Voice Commands](#) on page 114).

- Choosing a number from your contact or recent calls list in the phone app.
- Using the Model 3 on-screen dialer in the phone app.

Note: If it is safe and legal to do so, you can also initiate a call by dialing the number or selecting the contact directly from your phone.

Note: You can also make a phone call by touching a pin on the map and choosing the phone number (if available) on the popup window.

Receiving a Phone Call

When your phone receives an incoming call, the touchscreen displays the caller's number or name (if the caller is in your phone's contact list and Model 3 has access to your contacts).

Touch one of the options on the touchscreen to **Answer** or **Ignore** the call.

Note: Depending on the phone you are using and what speakers you used for your most recent call, your phone may prompt you to choose which speakers you want to use for the incoming call.

 **Warning:** Stay focused on the road at all times while driving. Using or programming a phone while driving, even with Bluetooth enabled, can result in serious injury or death.

 **Warning:** Follow all applicable laws regarding the use of phones while driving, including, but not limited to, laws that prohibit texting and require hands-free operation at all times.



Overview

The Calendar app allows you to view scheduled events from your phone's (iPhone® or Android™) calendar for the current and next day. The Calendar is conveniently integrated with navigation and the Phone app so you can navigate to, or dial into, your next meeting. The Calendar app requires that:

- The Tesla mobile app is running, you are logged in, and the Calendar Sync setting is enabled. The mobile app can then periodically (and automatically) send calendar data from your phone to Model 3.
Note: To ensure you have access to all features of the Calendar app, it is recommended that you use the most recent version of the mobile app.
- Your phone is connected to Model 3 via Bluetooth (for privacy reasons, calendar data displays only from a connected phone).
- Mobile access to Model 3 is turned on (touch **Controls** > **Safety & Security** > **Allow Mobile Access**).
- Both your phone and Model 3 have good connectivity.

When you enter Model 3, the touchscreen can display a reminder of the day's events. You can customize if and when your calendar events are displayed by touching the settings icon located in the top left corner of the Calendar app, then choosing from one of the options available for the **Show Calendar Upon Entry** setting.

If a calendar event includes an address, a navigation arrow displays to indicate that you can touch the address to navigate to the event's location. When an event on your Calendar takes place within the next hour and has a uniquely specified address, the touchscreen notifies you if there is a better route due to traffic, even when you're not currently using navigation.

Touch an event's information icon to display all notes associated with the event. If the notes include one or more phone numbers, the information icon shows a phone icon and the calendar displays the first phone number found. Touch to initiate a phone call. You can also initiate a phone call by touching any number in an event's notes popup window (this is especially useful for conference calls). If the notes contain a web link, you can touch the link to open it in the web browser (if equipped).

If events are displayed from multiple calendars, touch the list icon in the top right corner to filter the list of events to show only those from one or more specified calendars.



You can use voice commands to:

- Call a contact.
- Navigate to a location.
- Listen to Internet music.



To initiate a voice command, tap the microphone button on the touchscreen. When you hear the tone, speak your command. As you speak, the touchscreen displays an interpretation of your command. It also displays tips to remind you of the type of commands you can speak. When you finish speaking the command, tap the voice button again or simply wait.

Note: You can also initiate a voice command by pressing the right scroll button.

To call a contact on your Bluetooth-connected phone, say “Call” or “Dial”, followed by the contact’s first and/or last names. For example, “Call Joe” or “Call Joe Smith”.

To search for, or navigate to, a location, say “Where is”, “Drive to”, or “Navigate to”, followed by an address, business name, business category, or landmark. For example, “Where is Stanford University?”, “Drive to Tesla in Palo Alto”, or “Navigate to Starbucks on Homestead in Cupertino”.

If you defined a navigation address for your home or work location (see [Maps and Navigation](#) on page 103), you can use a voice command to navigate there by saying “Navigate home” or “Navigate to work”.

To listen to an Internet music service, say “Listen to” or “Play”, followed by the name of the song, album, artist, or combination. To improve voice recognition accuracy, provide multiple cues in your command, such as the artist plus the song (for example, “Listen to Yellow Brick Road” or “Play Yellow Brick Road by Elton John”).



About the Security System

If Model 3 does not detect an authenticated phone or the key card and a locked door or trunk is opened, an alarm sounds and the headlights and turn signals flash. To deactivate the alarm, press any button on the mobile app or tap your key card against the card reader located below the Autopilot camera on the driver's side door pillar.

To manually enable or disable the alarm system, touch **Controls > Safety & Security > Security Alarm**. When enabled, Model 3 activates its alarm one minute after you exit, the doors lock, and an authenticated phone or key card is no longer detected.

PIN to Drive

To increase security, you can prevent Model 3 from being driven until a 4-digit PIN (Personal Identification Number) is entered. To enable this setting, touch **Controls > Safety & Security > PIN to Drive** and follow the on-screen prompts to create a driving PIN.

Note: When enabled, in addition to having to enter the 4-digit driving PIN to drive, you must also use it to enter Valet mode for the first time and create the 4-digit valet PIN that you can use to enter and exit Valet mode. When in Valet mode, Model 3 can be driven without the need for the valet to enter a driving PIN. In addition, the **PIN to Drive** setting is disabled whenever Valet mode is active.

If you forget your driving PIN, or to disable **PIN to Drive**, return to this setting, touch the link to enter your Tesla login credentials, then follow the on-screen prompts.



About HomeLink

If your vehicle is equipped with the HomeLink® Universal Transceiver, you can operate up to three Radio Frequency (RF) devices, including garage doors, gates, lights, and security systems.

Note: Depending on date of manufacture, market region, and options selected at time of purchase, some vehicles are not equipped with a HomeLink Universal Transceiver.

Warning: Do not use the HomeLink Universal Transceiver with a device that does not have safety stop and reverse features. Using a device without these safety features increases the risk of injury or death.

Programming HomeLink

To program HomeLink:

1. Park Model 3 in front of the device you want to program, and have the device's remote control ready.
Caution: Your device might open or close during programming. Before programming, make sure that the device is clear of any people or objects.
2. Touch the HomeLink icon on the top of the touchscreen.
3. Touch **Create HomeLink**, then enter a name for your HomeLink device.
4. Touch **Program**.
5. Follow the onscreen instructions and then press **Start**.

Once programmed, you can operate the device by touching its corresponding HomeLink icon on the touchscreen's status bar. HomeLink remembers the location of your programmed devices. When you approach a known location, the HomeLink control on the touchscreen automatically drops down. When you drive away, it disappears.

Auto Opening and Closing

To operate a HomeLink device without touching the touchscreen, you can automate the device to open as you approach and close as you drive away:

- Touch the HomeLink icon on the top of the touchscreen and choose the device you want to automate.

- Select the **Auto-open when arriving** checkbox.
- Touch the arrows to specify the distance you want your vehicle to be from the device before it opens.
- Select the **Auto-close when leaving** checkbox if you want the device to close as you drive away.

As you approach (or drive away from) a device that is set to operate automatically, the HomeLink status icon displays a count-down message to let you know when the device will automatically open. In situations where you don't want the device to automatically open or close, touch **Skip Auto-Open** or **Skip Auto-Close** at any time during the count-down message.

Resetting the Location of the HomeLink Device

If you experience situations in which you sometimes drive up to your HomeLink device and it doesn't open, or the HomeLink icon on the touchscreen's status bar does not display the dropdown when you approach the device, you may need to reset the device's location. To do so, park as close as possible to the HomeLink device (garage door, gate, etc.) and display the HomeLink settings page by touching the HomeLink icon on the top of the touchscreen. Touch the name of the device you want to reset, then **Reset Location**.

Deleting a Device

To delete a HomeLink device, touch the HomeLink icon on the top of the touchscreen. Touch the name of the device you want to delete, then touch **Delete**.

Note: You can also perform a factory reset to erase your HomeLink settings, along with all other personal data (saved addresses, music favorites, imported contacts, etc.). See [Erasing Personal Data](#) on page 97.

Note: For security reasons, delete your HomeLink devices if you sell your Model 3.

Troubleshooting HomeLink

When programming a HomeLink device, the touchscreen walks you through a two-part programming process:



1. Model 3 records the signal from the remote. The touchscreen instructs you to stand in front of the vehicle, point the remote at the front bumper and press and hold the button until the headlights flash. When the headlights flash, Model 3 has learned the remote and you can touch **Continue** on the touchscreen. If the headlights do not flash, refer to the following guidelines.
 2. The device's receiver learns Model 3. The touchscreen instructs you to press the **LEARN** button on the device's receiver. If training the receiver does not work, refer to the following guidelines.

Note: Only devices that are equipped with a "rolling code" remote need to learn Model 3. If you have an old device that is not equipped with a "rolling code" remote, the device does not need to learn Model 3 and you can skip this part of the process. You can also skip this part if your receiver is "Quick-Train" compatible.
- Make sure you haven't reached the device receiver's limit of learned remotes/cars. Most receivers can learn up to five remotes/cars. If the receiver's memory is full, you must clear the memory and restart the programming process. For instructions on how to clear the receiver's memory, refer to the owner documentation provided with the HomeLink device.
 - Make sure you are pressing the receiver's **LEARN** button. Most receivers have two buttons and a LED. One button is a **RESET** button and the other is a **LEARN** button. Pressing the **LEARN** button usually causes the LED to flash. For instructions on how to put the receiver into learning mode, refer to the owner documentation provided with the HomeLink device.
 - Most devices stay in learning mode for only three to five minutes. Immediately after pressing the device's **LEARN** button, follow the instructions displayed on the touchscreen.

Headlights do not flash

- Check the batteries in the remote. It is a good idea to replace the batteries before you start programming.
- Hold the remote against the front bumper, with the button pressed, approximately 15 cm to the left of the Tesla emblem. In some cases you must hold the button on the remote for up to three minutes.
- Check compatibility of the remote by contacting the HomeLink manufacturer (www.homelink.com).
- Make sure you haven't reached the limit of learned remotes/vehicles. Most device receivers can learn up to five remotes/vehicles. If necessary, clear the receiver memory and restart the programming process. For information about clearing the receiver memory, refer to the owner documentation for your device.

After programming, the device does not work

- Park Model 3 with its front bumper as close as possible to the HomeLink device (garage door, gate, etc.).



Wi-Fi is available as a data connection method and is often faster than cellular data networks. Connecting to Wi-Fi is especially useful in areas with limited or no cellular connectivity. To ensure fast, reliable delivery of Model 3 updates (see [Software Updates](#) on page 119), Tesla recommends leaving Wi-Fi turned on and connected to a Wi-Fi network. To connect to a Wi-Fi network:

1. Touch the **LTE** (or **3G**) icon in the touchscreen status bar. Model 3 will start scanning and display the Wi-Fi networks that are within range.
2. Select the Wi-Fi network you want to use, enter the password (if necessary), then touch **Connect**.

You can also connect to a hidden network that isn't shown on the list of scanned networks. Just touch **Wi-Fi Settings** and enter the name of the network in the resulting dialog box.

Once you have connected to a network, Model 3 automatically connects whenever the network is within range. If more than one previously connected network is within range, Model 3 connects to the one most recently used.

Note: You can also use a mobile hotspot or your phone's Internet connection via Wi-Fi tethering.

Note: At Tesla Service Centers, Model 3 automatically connects to the Tesla Service Wi-Fi network.



Loading New Software

Model 3 updates its software wirelessly, providing new features throughout your term of ownership. Tesla recommends that you install software updates as soon as they are available. The first time you enter Model 3 after an update is made available, a scheduling window displays on the touchscreen. The scheduling window displays again at the end of your first driving session.

Note: Some software updates can take up to three hours to complete. Model 3 must be in Park while the new software is being installed. To ensure the fastest and most reliable delivery of software updates, leave the Wi-Fi turned on and connected whenever possible (see [Connecting to Wi-Fi](#) on page 118).

Note: Software updates using cellular data are also available if your vehicle is equipped with premium connectivity.

Warning: Do not attempt to use the vehicle while the software is being updated. Vehicle functions, including some safety systems, may be limited or disabled while a software update is in progress and you could damage the vehicle.

When a software update is available, a yellow clock icon appears on the touchscreen's status bar. Touch this clock icon to display the update window. You can then either:

- Schedule the update by setting the time you want the update to begin. Then touch **Set For This Time**. Once scheduled, the yellow clock icon changes to a white clock icon. You can reschedule the update any time before it begins.

OR

- Touch **Install Now** to immediately start the update process.

If Model 3 is charging when the software update begins, charging stops. Charging resumes automatically when the software update is complete. If you are driving Model 3 at the scheduled update time, the update is canceled and you need to reschedule it.

Note: Software updates are not performed when Keep Climate On is active.

Note: You can also start software updates using your Tesla mobile app.

Note: Over time, the touchscreen may display a software update window informing you to **SET FOR THIS TIME** or **INSTALL NOW**. This software update window will persist until you

complete the installation of the software update. You must install all software updates as soon as they are available and any harm relating to the failure to install a software update will not be covered by the vehicle's warranty. Failure or refusal to install such updates may result in the inaccessibility of certain vehicle features (including incompatibility with digital media devices) or in Tesla being unable to diagnose and service your vehicle.

Note: If software updates are not installed, some vehicle features may become inaccessible and digital media devices may become incompatible. Reverting to a previous software version is not possible.

If the touchscreen displays a message indicating that a software update was not successfully completed, contact Tesla.

Viewing Release Notes

When a software update is complete, learn about the new features by reading the release notes. To display release notes about your current software version at any time touch the Tesla "T" at the top center of the touchscreen, then touch **Release Notes**.

Tesla strongly recommends reading all release notes. They may contain important safety information or operating instructions regarding your Model 3.



High Voltage Components

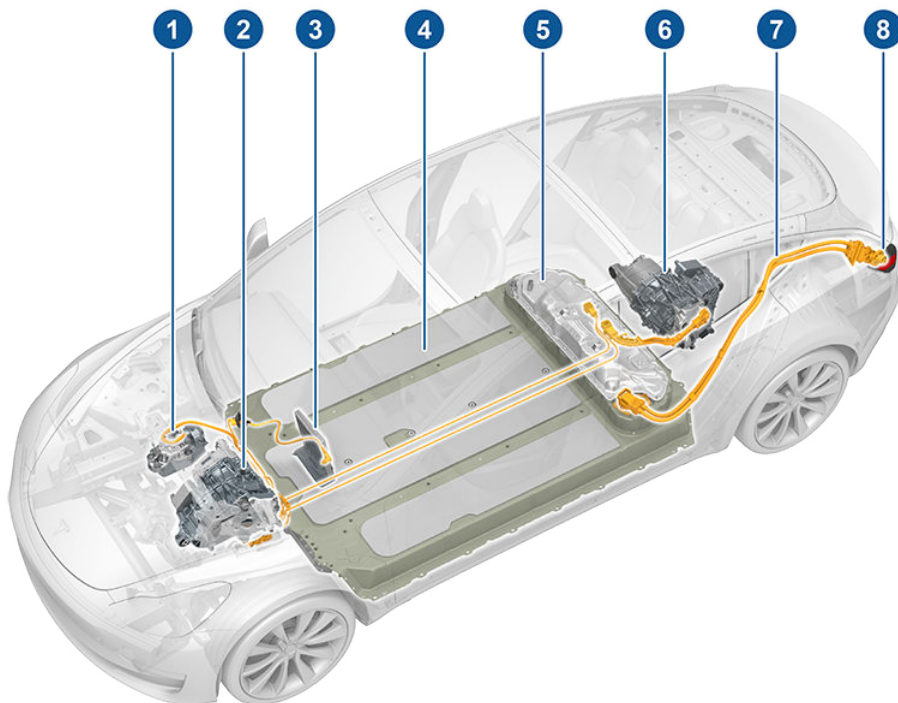

1. Air Conditioning Compressor
2. Front Motor (Dual Motor vehicles only)
3. Cabin Heater
4. High Voltage Battery
5. High Voltage Battery Service Panel
6. Rear Motor
7. High Voltage Cabling
8. Charge Port

- Warning:** The high voltage system has no user serviceable parts. Do not disassemble, remove or replace high voltage components, cables or connectors. High voltage cables are typically colored orange for easy identification.
- Warning:** Read and follow all instructions provided on the labels that are attached to Model 3. These labels are there for your safety.
- Warning:** In the unlikely event that a fire occurs, immediately contact your local fire emergency responders.



Charging Equipment

Charging equipment designed specifically to charge your Model 3 is available from Tesla. A Tesla Wall Connector, which installs in your garage, is the fastest way to charge Model 3 at home.

In most market regions, Model 3 is equipped with a Mobile Connector and the adapter(s) needed to plug into the most commonly used power outlets. When using the Mobile Connector, first plug the Mobile Connector into the power outlet, and then plug in Model 3. For more information about your Mobile Connector, see the Mobile Connector Owner's Manual (available on the touchscreen). Additional adapters can be purchased from Tesla.

Tesla offers additional adapters (for example, J1772 and CHAdeMO) to allow you to plug into the most commonly used public charging stations in your region. Connect the adapter to the charging station's charge cable, open the charge port door using the touchscreen (see [Charging Instructions](#) on page 124), and then plug in Model 3. For information on the charging equipment available for your region, go to www.tesla.com, and then view the available charging options.



About the Battery

Model 3 has one of the most sophisticated battery systems in the world. The most important way to preserve the Battery is to **LEAVE YOUR VEHICLE PLUGGED IN** when you are not using it. This is particularly important if you are not planning to drive Model 3 for several weeks. When plugged in, Model 3 wakes up when needed to automatically maintain a charge level that maximizes the lifetime of the Battery.

Note: When left idle and unplugged, your vehicle periodically uses energy from the Battery for system tests and recharging the 12V battery when necessary.

There is no advantage to waiting until the Battery's level is low before charging. In fact, the Battery performs best when charged regularly.

Note: If the Model 3 Battery becomes completely discharged in a situation in which transporting the vehicle is required, the owner is responsible for transporting expenses. Discharge-related transporting expenses are not covered under the Roadside Assistance policy.

The peak charging rate of the Battery may decrease slightly after a large number of DC Fast Charging sessions, such as those at Superchargers. To ensure maximum driving range and Battery safety, the Battery charge rate is decreased when the Battery is too cold, when the Battery's charge is nearly full, and when the Battery conditions change with usage and age. These changes in the condition of the Battery are driven by battery physics and may increase the total Supercharging duration by a few minutes over time.

Battery Care

Never allow the Battery to fully discharge. Even when Model 3 is not being driven, its Battery discharges very slowly to power the onboard electronics. The Battery can discharge at a rate of approximately 1% per day, though the discharge rate may vary depending on environmental factors (such as cold weather), vehicle configuration, and your selected settings on the touchscreen. Situations can arise in which you must leave Model 3 unplugged for an extended period of time (for example, at an airport when traveling). In these situations, keep the 1% in mind to ensure that you leave the Battery with a sufficient charge level. For example, over a two week period (14 days), the Battery may discharge by approximately 14%.

Discharging the Battery to 0% may result in damage to vehicle components. To protect against a complete discharge, Model 3 enters a low-power consumption mode when the displayed charge level drops to approximately 0%. In this mode, the Battery stops supporting the onboard electronics and auxiliary 12V battery. Once this low-power consumption mode is active, immediately plug in Model 3 to prevent a jump-start and 12V battery replacement.

Note: If the vehicle is unresponsive and will not unlock, open, or charge, then the 12V battery may have become discharged. In this situation, contact Tesla.

Temperature Limits

For better long-term performance, avoid exposing Model 3 to ambient temperatures above 60° C or below -30° C for more than 24 hours at a time.



Battery Warnings and Cautions

Warning: The Battery has no parts that an owner or a non-Tesla authorized service technician can service. Under no circumstances should you open or tamper with the Battery. Always contact Tesla to arrange for Battery servicing.

Caution: If the Battery's charge level falls to 0%, you must plug it in. If you leave it unplugged for an extended period, it may not be possible to charge or use Model 3 without jump starting or replacing the 12V battery (see [Instructions for Transporters](#) on page 158 for instructions on how to jump start the battery). Leaving Model 3 unplugged for an extended period can



also result in permanent Battery damage. If you are unable to charge Model 3, contact Tesla immediately.

-  **Caution:** The Battery requires no owner maintenance. Do not remove the coolant filler cap and do not add fluid. If the touchscreen warns you that the fluid level is low, contact Tesla immediately.
-  **Caution:** Do not use the Battery as a stationary power source. Doing so voids the warranty.



Opening the Charge Port

The charge port is located on the left side of Model 3, behind a door that is part of the rear tail light assembly. Before charging, park Model 3 to ensure that the charge cable easily reaches the charge port.

With Model 3 unlocked (or an authenticated phone is within range) and in Park, press and release the button on the Tesla charge cable to open the charge port door.



You can also open the charge port door using any of these methods:

- On the touchscreen, use the app launcher to open the Charging app, then touch **Open Charge Port**.
- On the car status on the touchscreen, touch the charging icon.
- On the "Cards" area on the touchscreen, touch the charging icon, then press **OPEN CHARGE PORT**.
- Press the bottom of the charge port door when Model 3 is unlocked or an authenticated phone is nearby.
- On the key fob accessory (sold separately), hold down the rear trunk button for 1-2 seconds.

Note: The following image is provided for demonstration purposes only. Depending on market region, your charge port may be slightly different.

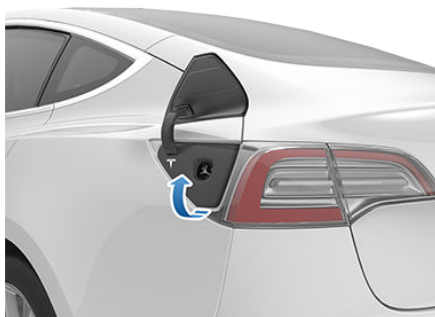

Note: The Tesla "T" lights up white when you open the charge port door. If you do not insert a charge cable into the charge port within a few minutes after opening the charge port door, the charge port door closes. If this happens, use the touchscreen to open the charge port door again

Caution: Do not try to force the charge port door open.

Plugging In

If desired, use the touchscreen to change the charge limit and the charging current (see [Charging Status and Settings](#) on page 126).

To charge at a public charging station, attach an adapter to the station's charging connector. The most commonly used adapter(s) for each market region are provided. Depending on the charging equipment you are using, you may need to start and stop charging using a control on the charging equipment.

If you are using the Mobile Connector, plug it into the power outlet before plugging it into Model 3.

Align the connector to the charge port and insert fully. When the connector is properly inserted, charging begins automatically after Model 3:

- Engages a latch that holds the connector in place;
- Shifts into Park (if it was in any other gear);
- Heats or cools the Battery, if needed. If the Battery requires heating or cooling, you may notice a delay before charging begins.

Note: Whenever Model 3 is plugged in but not actively charging, it draws energy from the wall outlet instead of using energy stored in the Battery. For example, if you are sitting in



Model 3 and using the touchscreen while parked and plugged in, Model 3 draws energy from the wall outlet instead of the Battery.

⚠ Caution: The connector end of the charge cable can damage the paint if dropped onto the vehicle.

During Charging

During charging, the charge port light (the Tesla "T" logo) pulses green, and the touchscreen displays the charging status. The frequency at which the charge port light pulses slows down as the charge level approaches full. When charging is complete, the light stops pulsing and is solid green.

Note: If Model 3 is locked, the charge port light does not light up.

If the charge port light turns red while charging, a fault is detected. Check the touchscreen for a message describing the fault. A fault can occur due to something as common as a power outage. If a power outage occurs, charging resumes automatically when power is restored.

Note: When charging, particularly at high currents, the refrigerant compressor and fan operate as needed to keep the Battery cool. Therefore, it is normal to hear sounds during charging.

Note: Air conditioning performance is generally not affected by charging. However, under certain circumstances (for example, you are charging at high currents during a particularly warm day), the air coming from the vents may not be as cool as expected and a message displays on the touchscreen. This is normal behavior and ensures that the Battery stays within an optimum temperature range while charging to support longevity and optimum performance.

⚠ Warning: Never spray liquid at a high velocity (for example, if using a pressure washer) towards the charge port while charging. Failure to follow these instructions can result in serious injury or damage to the vehicle, charging equipment, or property.

Stopping Charging

Stop charging at any time by disconnecting the charge cable or touching **Stop Charging** on the touchscreen.

Note: To prevent unauthorized unplugging of the charge cable, the charge cable latch

remains locked and Model 3 must be unlocked or able to recognize your authenticated phone before you can disconnect the charge cable. However, in cold ambient temperatures below 41° F (5° C), the charge port remains unlocked whenever the vehicle is not charging, even when Model 3 is locked.

To disconnect the charge cable:

1. Press and hold the button on the connector handle to release the latch. Alternatively, unlock the vehicle by opening a door, using a key card or key fob, or touching Stopping Charging on the touchscreen (see [Charging Status and Settings](#) on page 126). These methods unlock the charge port as well.
2. Pull the connector from the charge port.

Note: The charge port automatically closes within approximately 10 seconds of removing the connector from the charge port.

⚠ Caution: Tesla strongly recommends leaving Model 3 plugged in when not in use. This maintains the Battery at the optimum level of charge.

Manually Releasing Charge Cable

If the usual methods for releasing a charge cable from the charge port (using the charge handle release button, touchscreen, or mobile app) do not work, carefully follow these steps:

1. Ensure that Model 3 is not actively charging by displaying the charging screen on the touchscreen. If necessary, touch **Stop Charging**.
2. Open the rear trunk.
3. Pull the charge port's release cable downwards to unlatch the charge cable.



Note: The release cable may be recessed within the opening of the trim.



- Pull the charge cable from the charge port.

Caution: The release cable is designed for use only in situations where the charge cable cannot be released from the charge port using the usual methods. Continuous use may result in damage to the release cable or charging equipment.

Warning: Do not perform this procedure while your vehicle is charging or if any orange high voltage conductors are exposed. Failure to follow these instructions can result in electric shock and serious injury or damage to the vehicle. If you have any uncertainty as to how to safely perform this procedure, contact Tesla.

Warning: Do not attempt to remove the charge cable while simultaneously pulling the release cable. Always pull the release cable before attempting to remove the charge cable from the charge port. Failure to follow these instructions can result in electric shock and serious injury.

Charge Port Light

- WHITE:** The charge port door is open. Model 3 is ready to charge and the connector is not inserted, or the charge port latch is unlocked and the connector is ready to be removed.

Note: In cold ambient temperatures below 41° F (5° C), the charge port remains unlocked whenever the vehicle is not charging. In these situations, the charge port light is white.

- BLUE:** Model 3 detects that a connector has been plugged in.
- BLINKING BLUE:** Model 3 is communicating with the connector. Either Model 3 is preparing to charge, or a charging session is scheduled to begin at a specified future time.
- BLINKING GREEN:** Charging is in progress. As Model 3 approaches a full charge, the frequency of the blinking slows.
- SOLID GREEN:** Charging is complete.
- SOLID AMBER:** The connector is not fully plugged in. Realign the connector to the charge port and insert fully.
- BLINKING AMBER:** Model 3 is charging at a reduced current (AC charging only).
- RED:** A fault is detected and charging has stopped. Check the touchscreen for a fault message.

Charging Status and Settings

The charging screen displays on the touchscreen whenever the charge port door is open. To display the charging screen at any time:



Touch the charging icon on the "Cards" area on the touchscreen.

The charging screen displays a representative image of the status of the Battery and information about your charging session including:

- Charging rate (in kilowatt hours, miles per hour, or kilometers per hour, depending on your display setting).
- Added energy or estimated increase in driving distance achieved so far in this charging session (in kilowatt hours, miles per hour, or kilometers per hour, depending on your display setting).
- Current supplied/available from the connected power supply.
- Voltage supplied by the charge cable.

Note: To change how energy units are displayed, touch **Controls** > **Display** > **Energy Display**.

Note: The following illustration is provided for demonstration purposes only and may vary slightly depending on software version and market region.

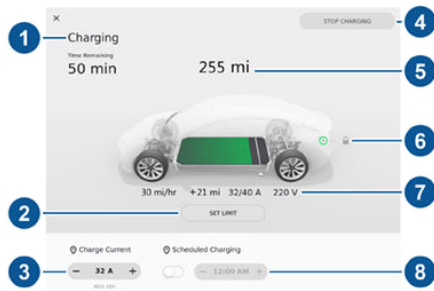

- Charge status messages (such as Charging, Charging Scheduled) display here. While charging, the estimated time remaining to achieve your set limit is also displayed.



2. Adjust the charge limit by touching **Set Limit**, and drag the arrow to move the charge limit setting. The setting you choose applies to immediate and scheduled charging sessions.
3. The current automatically sets to the maximum current available from the attached charge cable, unless it was previously reduced to a lower level. If needed, touch **-** or **+** to change the current (for example, you may want to reduce the current if you are concerned about overloading a domestic wiring circuit shared by other equipment). It is not possible to set the charging current to a level that exceeds the maximum available from the attached charge cable. When you change the current, Model 3 remembers the location. If you charge at the same location, you do not need to change it again.

Note: If Model 3 is charging and detects unexpected fluctuations in input power, the charging current is automatically reduced by 25%. For example, a 40 amp current is reduced to 30 amps. This automatic current reduction increases robustness and safety in situations when an external problem exists (for example, a home wiring system, receptacle, adapter or cord is unable to meet its rated current capacity). As a precaution, when Model 3 automatically reduces current, it saves the reduced current at the charging location. Although you can manually increase it, Tesla recommends charging at the lower current until the underlying problem is resolved and the charging location can provide consistent power.

4. Touch to open the charge port door or to start (or stop) charging.
5. Displays the total estimated driving distance or energy percentage (depending on your display setting) available.
6. Shows if the charge cable is locked in the charge port or not. If Model 3 is not charging, you can touch the lock icon to unlock the charge cable from the charge port.

Note: In cold ambient temperatures below 41° F (5° C), the charge cable remains unlocked whenever the vehicle is not charging.

7. Charging rate per hour, estimated increase in driving distance (or energy) achieved so far in this charging session, current supplied/available from the connected power supply, and voltage supplied by the charge cable.
8. Set a recurring charging schedule for the location. When you set a scheduled charging time, Model 3 displays the set time when you are parked at the scheduled location. If, at the scheduled time, Model 3 is not plugged in at the location, charging starts as soon as you plug it in, provided you plug it in within six hours of the scheduled time. If plugged in after six hours, charging does not start until the scheduled time on the next day. To override this setting, touch **Start Charging** or **Stop Charging** (see item 4).

Note: If charging at a Tesla Supercharger, the charging screen also displays information about your previous or current Supercharger session (see [Supercharger Usage Fees and Idle Fees](#) on page 127).

Note: To reduce congestion at high-usage supercharger sites, you may be automatically limited to a maximum charge of 80% when not using Trip Planner (see [Trip Information](#)). You can manually increase the limit by tapping “Set Limit” on the touchscreen or mobile app.

Supercharger Usage Fees and Idle Fees

When charging using a Tesla supercharger, **SUPERCHARGING** information displays at the bottom of the charging screen. This information includes the location, the time that charging started, and an estimate of how much the session will cost. When you stop supercharging, the estimated cost of that session displays until a new supercharging session begins.

Note: Estimated pricing is displayed for your convenience only and may not reflect the actual final price you will be charged for that supercharging session. Final pricing for supercharging sessions can be found in your Tesla Account.



When charging at a Tesla supercharger, you are subject to idle fees. Idle fees are designed to encourage drivers to move their vehicle from the Supercharger when charging is complete. Idle fees are in effect only when half of the Superchargers at a site are occupied. The Tesla mobile app notifies you when charging nears completion, and again when charging is complete. Additional notifications are sent if idle fees are incurred. Idle fees are waived if you move your vehicle within five minutes of charging completion.

Log into your Tesla Account to view fees and details about Supercharger sessions, set up a payment method, and make payments. Once a payment method is saved, fees are automatically paid from your account.



Service Intervals

Regular maintenance is the key to ensuring the continued reliability and efficiency of your Model 3.

Rotate the tires every 10,000 km. Maintain the correct tire pressures. It is also important to perform the daily and monthly checks described below.

Note: View tire pressures in the “Cards” area, located toward the bottom on the left side of the touchscreen, as described in [Touchscreen Overview](#) on page 4.

Model 3 should be serviced by Tesla-certified technicians. Damages or failures caused by maintenance or repairs performed by non-Tesla certified technicians are not covered by the warranty.

Daily Checks

- Check the Battery’s charge level, displayed on the touchscreen or mobile app.
- Check the condition and pressure of each tire (see [Tire Care and Maintenance](#) on page 130).
- Check that all exterior lights, horn, turn signals, and wipers and washers are working.
- Check the operation of the brakes, including the parking brake.
- Check the operation of the seat belts (see [Seat Belts](#) on page 27).
- Look for abnormal fluid deposits underneath Model 3 that might indicate a leak. It is normal for a small pool of water to form (caused by the air conditioning system’s dehumidifying process).

Monthly Checks

- Check the mileage to determine if the tires need to be rotated (every 10,000 km), and check the condition and pressure of each tire (see [Tire Care and Maintenance](#) on page 130).
- Check windshield washer fluid level and top up if necessary (see [Topping Up Windshield Washer Fluid](#) on page 142).
- Check that the air conditioning system is operating correctly (see [Climate Controls](#) on page 98).

Warning: Contact Tesla immediately if you notice any significant or sudden drop in fluid levels or uneven tire wear.

Fluid Replacement Intervals

Do not change or top up the Battery coolant or brake fluid. Tesla service technicians replace fluids at the regularly scheduled service intervals:

- Brake fluid. Every 2 years or 40,000 km, whichever comes first.
- Battery coolant. Every 4 years or 80,000 km, whichever comes first.

Note: Any damage caused by opening the Battery coolant reservoir is excluded from the warranty.

High Voltage Safety

Your Model 3 has been designed and built with safety as a priority. However, be aware of these precautions to protect yourself from the risk of injury inherent in all high-voltage systems:

- Read and follow all instructions provided on the labels that are attached to Model 3. These labels are there for your safety.
- The high voltage system has no user-serviceable parts. Do not disassemble, remove or replace high voltage components, cables or connectors. High voltage cables are colored orange for easy identification.
- If a collision occurs, do not touch any high voltage wiring, connectors, or components connected to the wiring.
- In the unlikely event that a fire occurs, immediately contact your local fire emergency responders.

Warning: Always disconnect the charge cable before working underneath Model 3, even if charging is not in progress.

Warning: Keep your hands and clothing away from cooling fans. Some fans operate even when Model 3 is powered off.

Warning: Some fluids (battery acid, Battery coolant, brake fluid, windshield washer additives, etc.) used in vehicles are poisonous and should not be inhaled, swallowed, or brought into contact with open wounds. For your safety, always read and follow instructions printed on fluid containers.



Maintaining Tire Pressures

Keep tires inflated to the pressures shown on the Tire and Loading Information label, even if it differs from the pressure printed on the tire itself. The Tire and Loading Information label is located on the center door pillar and is visible when the driver's door is open.

Note: If your Model 3 is fitted with Tesla accessory wheels or tires, some information may be different from the labels on the vehicle.



The Tire Pressure indicator light on the touchscreen alerts you if one or more tires is under- or over-inflated.

The Tire Pressure indicator light does not immediately turn off when you adjust tire pressure. After inflating the tire to the recommended pressure, you must drive over 25 km/h for more than 10 minutes to activate the Tire Pressure Monitoring System (TPMS), which turns off the Tire Pressure indicator light.

If the indicator light flashes for one minute whenever you power on Model 3, a fault with the TPMS is detected (see [TPMS Malfunction](#) on page 134).

Note: Display tire pressures in the "Cards" area, located toward the bottom on the left side of the touchscreen, as described in [Touchscreen Overview](#) on page 4. You can also choose whether you want to display tire pressures using BAR or PSI by touching **Controls > Display > Tire Pressure**.

Warning: Under-inflation is the most common cause of tire failures and can cause a tire to overheat, resulting in

severe tire cracking, tread separation, or blowout, which causes unexpected loss of vehicle control and increased risk of injury. Under-inflation also reduces the vehicle's range and tire tread life.

Warning: Check tire pressures using an accurate pressure gauge when tires are cold. It takes only about 1.6 kms of driving to warm up the tires sufficiently to affect tire pressures. Parking the vehicle in direct sunlight or in hot weather can also affect tire pressures. If you must check warm tires, expect increased pressures. Do not let air out of warm tires in an attempt to match recommended cold tire pressures. A hot tire at or below the recommended cold tire inflation pressure is dangerously under-inflated.

Warning: Do not use any tire sealant other than the type provided in a Tesla tire repair kit. Other types can cause tire pressure sensors to malfunction. If your Model 3 did not include a tire repair kit, you can purchase one from Tesla.



Checking and Adjusting Tire Pressures

Follow these steps when tires are cold and Model 3 has been stationary for over three hours:

1. Remove the valve cap.
2. Firmly press an accurate tire pressure gauge onto the valve to measure pressure.
3. If required, add or remove air to reach the recommended pressure.

Note: You can release air by pressing the metal stem in the center of the valve.

4. Re-check pressure using the accurate tire gauge.
5. Repeat steps 3 and 4 as necessary until the tire pressure is correct.
6. Reinstall the valve cap to prevent dirt from entering. Periodically check the valve for damage and leaks.

Inspecting and Maintaining Tires

Regularly inspect the tread and side walls for any sign of distortion (bulges), foreign objects, cuts or wear.

⚠ Warning: Do not drive Model 3 if a tire is damaged, excessively worn, or inflated to an incorrect pressure. Check tires regularly for wear, and ensure there are no cuts, bulges or exposure of the ply/cord structure.

Tire Wear

Adequate tread depth is important for proper tire performance. Tires with a tread depth less than 3 mm are more likely to hydroplane in wet conditions and should not be used. Tires with a tread depth less than 4 mm do not perform well in snow and slush and should not be used when driving in winter conditions.

Model 3 is originally fitted with tires that have wear indicators molded into the tread pattern. When the tread has been worn down to 3 mm, the indicators start to appear at the surface of the tread pattern, producing the effect of a continuous band of rubber across the width of the tire. For optimal performance and safety, Tesla recommends replacing tires before the wear indicators are visible.

Tire Rotation, Balance, and Wheel Alignment

Tesla recommends rotating the tires every 10,000 km.

Unbalanced wheels (sometimes noticeable as vibration through the steering wheel) affect vehicle handling and tire life. Even with regular use, wheels can get out of balance. Therefore, they should be balanced as required.

If tire wear is uneven (on one side of the tire only) or becomes abnormally excessive, check the alignment of wheels.

Note: When replacing only two tires, always install the new tires on the rear.



Punctured Tires

A puncture eventually causes the tire to lose pressure, which is why it is important to check tire pressures frequently. Permanently repair or replace punctured or damaged tires as soon as possible.

Your tubeless tires may not leak when penetrated, provided the object remains in the tire. If, however, you feel a sudden vibration or ride disturbance while driving, or you suspect a tire is damaged, immediately reduce your speed. Drive slowly, while avoiding heavy braking or sharp steering and, when safe to do so, stop the vehicle. Arrange to have Model 3 transported to a Tesla Service Center, or to a nearby tire repair center.

Note: In some cases, you can temporarily repair small tire punctures (under 6 mm) using an optional tire repair kit available from Tesla. This allows you to slowly drive Model 3 to Tesla or to a nearby tire repair facility.

Warning: Do not drive with a punctured tire, even if the puncture has not caused the tire to deflate. A punctured tire can deflate suddenly at any time.

Flat Spots

If Model 3 is stationary for a long period in high temperatures, tires can form flat spots. When Model 3 is driven, these flat spots cause a vibration which gradually disappears as the tires warm up and regain their original shape.

To minimize flat spots during storage, inflate tires to the maximum pressure indicated on the tire wall. Then, before driving, release air to adjust tire pressure to the recommended levels.

Improving Tire Mileage

To improve the mileage you get from your tires, maintain tires at the recommended tire pressures, observe speed limits and advisory speeds, and avoid:

- Pulling away quickly, or hard acceleration.
- Fast turns and heavy braking.
- Potholes and objects in the road.
- Hitting curbs when parking.
- Contaminating tires with fluids that can cause damage.

Replacing Tires and Wheels

Tires degrade over time due to the effects of ultraviolet light, extreme temperatures, high loads, and environmental conditions. It is recommended that tires are replaced every six years, or sooner if required.

Wheel and tires are matched to suit the handling characteristics of the vehicle. Replacement tires must comply with the original specification. If tires other than those specified are used, ensure that the load and speed ratings marked on the tire (see [Understanding Tire Markings](#) on page 154) equal or exceed those of the original specification.

Ideally, you should replace all four tires at the same time. If this is not possible, replace the tires in pairs, placing the new tires on the rear. Always balance the wheel after replacing a tire.

If you replace a wheel, the TPMS (Tire Pressure Monitoring System) sensors need to be reset to ensure they provide accurate warnings when tires are under- or over-inflated (see [Automatic Reset of TPMS Sensors](#) on page 134).

For the specification of the original wheels and tires installed on Model 3, see [Wheels and Tires](#) on page 153.

Warning: For your safety, use only tires and wheels that match the original specification. Tires that do not match the original specification can affect the operation of the TPMS.

Warning: Never exceed the speed rating of your vehicle's tires. The speed rating is shown on the sidewall of your tires (see [Understanding Tire Markings](#) on page 154).

Asymmetric Tires

Model 3 tires are asymmetric and must be mounted on the wheel with the correct sidewall facing outward. The sidewall of the tire is marked with the word OUTSIDE. When new tires are installed, make sure that the tires are correctly mounted on the wheels.





- ⚠ Warning:** Road holding is seriously impaired if the tires are incorrectly installed on the wheels.

Removing and Installing Aero Covers

If your Model 3 is equipped with aero covers, you must remove them to access the lug nuts. To remove an aero cover, grasp it firmly and pull it toward you.

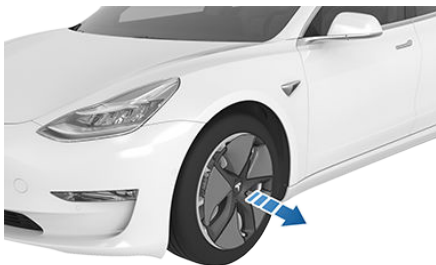

To install an aero cover, align it into position so that the notch is aligned with the tire's valve stem and then push firmly around its perimeter until it fully snaps into place.



Removing and Installing Lug Nut Covers

If your Model 3 is equipped with lug nut covers, you must remove them to access the lug nuts.

To remove a lug nut cover:

1. Insert the curved part of the lug nut cover tool (located in your glovebox) into the hole at the base of the Tesla "T".



2. Maneuver the lug nut cover tool so that it is fully inserted into the hole in the lug nut cover.
3. Twist the lug nut cover tool so that the curved part is touching the middle of the lug nut cover.
4. Firmly pull the lug nut tool away from the wheel until the lug nut cover is released.

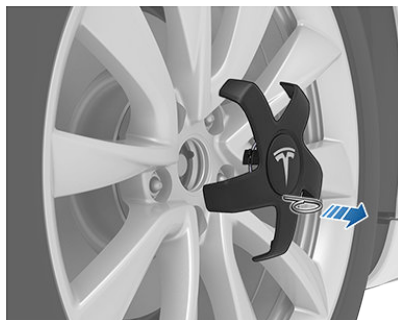

To install the lug nut cover, align it into position and push firmly until it fully snaps into place.



Tire Pressure Monitoring

Each tire should be checked monthly when cold and inflated to the recommended pressures that are printed on the Tire and Loading Information label located on the driver's door pillar (see [Maintaining Tire Pressures](#) on page 130). If your vehicle has tires of a different size than the size indicated on the vehicle placard or tire inflation pressure label, determine the proper tire inflation pressure for those tires.

As an added safety feature, your vehicle has been equipped with a TPMS that displays a tire pressure telltale (Tire Pressure Warning) on the touchscreen when one or more of your tires is significantly under- or over-inflated. Accordingly, when the Tire Pressure indicator light displays on the touchscreen to alert you about tire pressure, stop and check your tires as soon as possible, and inflate them to the proper pressure (see [Maintaining Tire Pressures](#) on page 130). Driving on a significantly under-inflated tire causes the tire to overheat and can lead to tire failure. Under-inflation also reduces range efficiency and tire tread life, and may affect the vehicle's handling and stopping ability.



If Model 3 detects a fault with the TPMS, this indicator flashes for one minute whenever you power on Model 3.

Note: Installing accessories that are not approved by Tesla can interfere with the TPMS.



Warning: The TPMS is not a substitute for proper tire maintenance, including manually checking tire pressures and regularly inspecting the condition of tires. It is the driver's responsibility to maintain correct tire pressure, even if under- or over-inflation has not reached the level for the TPMS to trigger the Tire Pressure Warning on the touchscreen.

Automatic Reset of TPMS Sensors

After replacing one or more wheels (but not after replacing a tire or rotating wheels), the TPMS sensors are reset to ensure tire pressure warnings are accurate. TPMS sensors reset automatically after driving over 25 km/h for longer than 10 minutes.

Note: After replacing a wheel, false tire pressure warnings may display before you've driven 25 km/h for longer than 10 minutes.

Replacing a Tire Sensor

If the Tire Pressure warning indicator displays frequently, contact Tesla to determine if a tire sensor needs to be replaced. If a non-Tesla Service Center repairs or replaces a tire, the tire sensor may not work until Tesla performs the setup procedure.

TPMS Malfunction

Model 3 has also been equipped with a TPMS malfunction indicator to indicate when the system is not operating properly.



The TPMS malfunction indicator is combined with the tire pressure indicator light. When the system detects a malfunction, the indicator flashes for approximately one minute after Model 3 powers on, and then remains continuously lit. This sequence continues upon subsequent vehicle start-ups as long as the malfunction exists. When the TPMS malfunction indicator is on, the system might not be able to detect or signal under- and over-inflated tires as intended.

TPMS malfunctions can occur for a variety of reasons, including installing replacement or alternate tires or wheels that prevent the TPMS from functioning properly. Always check the TPMS malfunction indicator light after replacing one or more tires or wheels on your vehicle to ensure that the replacement tires or wheels allow the TPMS to continue to function properly.

Note: If a tire has been replaced or repaired using a different tire sealant than the one available from Tesla, and a low tire pressure is detected, it is possible that the tire sensor has been damaged. Contact Tesla to have the fault repaired as soon as possible.



Seasonal Tire Types

Summer Tires

Your vehicle may be originally equipped with high performance summer tires or all season tires. Tesla recommends using winter tires if driving in cold temperatures or on roads where snow or ice may be present. Contact Tesla for winter tire recommendations.

Warning: In cold temperatures or on snow or ice, summer tires do not provide adequate traction. Selecting and installing the appropriate tires for winter conditions is important to ensure the safety and optimum performance of your Model 3.

All-Season Tires

Your Model 3 may be originally equipped with all-season tires. These tires are designed to provide adequate traction in most conditions year-round, but may not provide the same level of traction as winter tires in snowy or icy conditions. All-season tires can be identified by "ALL SEASON" and/or "M+S" (mud and snow) on the tire sidewall.

Winter Tires

Use winter tires to increase traction in snowy or icy conditions. When installing winter tires, always install a complete set of four tires at the same time. Winter tires must be the same size, brand, construction and tread pattern on all four wheels. Contact Tesla for winter tire recommendations.



Winter tires can be identified by a mountain/snowflake symbol on the tire's sidewall.

When driving with winter tires, you may experience more road noise, shorter tread life, and less traction on dry roads.

Note: Installing winter tires with aggressive compound and tread design may result in temporarily-reduced regenerative braking power. However, your vehicle is designed to recalibrate itself to restore regenerative braking power after a short period of normal driving.

Driving in Low Temperatures

Tire performance is reduced in low ambient temperatures, resulting in reduced grip and an increased susceptibility to damage from impacts. Performance tires can temporarily harden when cold, causing you to hear rotational noise for the first few kilometers until the tires warm up.

Using Tire Chains

Tesla has tested and approved the following tire chains to increase traction in snowy conditions. Tire chains should only be installed on the rear tires.

Tire Size	Recommended Chain
18"	PEWAG SERVO SPORT RSS 76
19"	PEWAG SERVO RS 77
20"	MAGGI TRAK SP214

Warning: If your Model 3 is equipped with aero covers, you must remove them before installing tire chains (see [Removing and Installing Aero Covers](#) on page 133). Failure to do so can cause damage not covered by the warranty.

When installing tire chains, follow the instructions provided by the tire chain manufacturer. Mount them as tightly as possible.

When using tire chains:

- Drive slowly. Do not exceed 48 km/h.
- Avoid heavily loading Model 3 (heavy loads can reduce the clearance between the tires and the body).
- Remove the tire chains as soon as conditions allow.

Note: Tire chains are prohibited in some jurisdictions. Check local laws before installing tire chains.

Warning: Using non-recommended tire chains, or using tire chains on other sized tires can damage the suspension, body, wheels, and/or brake lines. Damage caused by using non-recommended tire chains is not covered by the warranty.

Warning: Do not use tire chains on the front tires.



 **Caution:** Ensure that the tire chains cannot touch suspension components or brake lines. If you hear the chains making unusual noises that would indicate contact with Model 3, stop and investigate immediately.



Cleaning the Exterior

To prevent damage to the paint, immediately remove corrosive substances (bird droppings, tree resin, dead insects, tar spots, road salt, industrial fallout, etc.). Do not wait until Model 3 is due for a complete wash. If necessary, use denatured alcohol to remove tar spots and stubborn grease stains, then immediately wash the area with water and a mild, non-detergent soap to remove the alcohol.

Follow these steps when washing the exterior of Model 3:

1. Rinse Thoroughly

Before washing, flush grime and grit from the bodywork using a hose. Flush away accumulations of mud in areas where debris easily collects (such as wheel arches and panel seams). If salt has been used on the highways (such as during winter months), thoroughly rinse all traces of road salt from the underside of the vehicle.

2. Hand Wash

Hand wash Model 3 using a clean soft cloth and cold or lukewarm water containing a mild, high-quality car shampoo.

3. Rinse with Clean Water

After washing, rinse with clean water to prevent soap from drying on the surfaces.

4. Dry Thoroughly and Clean Exterior Glass

After washing and rinsing, dry thoroughly with a chamois.

Clean windows and mirrors using an automotive glass cleaner. Do not scrape, or use any abrasive cleaning fluid on glass or mirrored surfaces.

Cautions for Exterior Cleaning

 **Caution:** Do not use windshield treatment fluids. Doing so can interfere with wiper friction and cause a chattering sound.

 **Caution:** Do not use hot water or detergents.

 **Caution:** Do not wash in direct sunlight.

 **Caution:** If using a pressure washer, maintain a distance of at least 30 cm between the nozzle and the surface of Model 3. Keep the nozzle moving and do not concentrate the water jet on any one area.

 **Caution:** Do not aim water hoses directly at window, door or hood seals, or through wheel apertures onto brake components.

 **Caution:** Avoid using tight-napped or rough cloths, such as washing mitts.

 **Caution:** If washing in an automatic car wash, use Touchless car washes only. These car washes have no parts (brushes, etc.) that touch the surfaces of Model 3. Using any other type of car wash could cause damage that is not covered by the warranty.

 **Caution:** Ensure the wipers are off before washing Model 3 to avoid the risk of damaging the wipers.

 **Caution:** Do not use chemical based wheel cleaners. These can damage the finish on the wheels.

 **Caution:** Avoid using a high pressure power washer on the camera(s) or parking sensors (if equipped) and do not clean a sensor or camera lens with a sharp or abrasive object that can scratch or damage its surface.

 **Warning:** Never spray liquid at a high velocity (for example, if using a pressure washer) towards the charge port while Model 3 is charging. Failure to follow these instructions can result in serious injury or damage to the vehicle, charging equipment, or property.



Cleaning the Interior

Frequently inspect and clean the interior to maintain its appearance and to prevent premature wear. If possible, immediately wipe up spills and remove marks. For general cleaning, wipe interior surfaces using a soft cloth (such as microfiber) dampened with a mixture of warm water and mild non-detergent cleaner (test all cleaners on a concealed area before use). To avoid streaks, dry immediately with a soft lint-free cloth.

Interior Glass

Do not scrape, or use any abrasive cleaning fluid on glass or mirrored surfaces. This can damage the reflective surface of the mirror and the heating elements in the rear window.

Airbags

Do not allow any substance to enter an airbag cover. This could affect correct operation.

Dashboard and Plastic Surfaces

Do not polish the upper surfaces of the dashboard. Polished surfaces are reflective and could interfere with your driving view.

Polyurethane Seats

Wipe spills as soon as possible using a soft cloth moistened with warm water and non-detergent soap. Wipe gently in a circular motion. After cleaning, allow the seats to air dry.

Cloth Seats

Wipe spills as soon as possible using a soft cloth moistened with warm water and non-detergent soap. Wipe gently in a circular motion. Then wipe dry using a soft, lint-free cloth. Vacuum the seats as needed to remove any loose dirt.

Carpets

Avoid over-wetting carpets. For heavily soiled areas, use a diluted upholstery cleaner.

Seat Belts

Extend the belts to wipe. Do not use any type of detergent or chemical cleaning agent. Allow the belts to dry naturally while extended, preferably away from direct sunlight.





Touchscreen

Clean the touchscreen using a soft lint-free cloth specifically designed to clean monitors and displays. Do not use cleaners (such as a glass cleaner) and do not use a wet wipe or a dry statically-charged cloth (such as a recently washed microfiber). To wipe the touchscreen without activating buttons and changing settings, you can enable clean mode. Touch **Controls > Display > Screen Clean Mode**. The display darkens to make it easy to see dust and smudges.

Chrome and Metal Surfaces

Polish, abrasive cleaners or hard cloths can damage the finish on chrome and metal surfaces.

Cautions for Interior Cleaning

-  **Caution:** Using solvents (including alcohol), bleach, citrus, naphtha, or silicone-based products or additives on interior components can cause damage.
-  **Caution:** Statically-charged materials can cause damage to the touchscreen.
-  **Warning:** If you notice any damage on an airbag or seat belt, contact Tesla immediately.
-  **Warning:** Do not allow any water, cleaners, or fabric to enter a seat belt mechanism.
-  **Warning:** Exposure to chemical cleaners can be hazardous and can irritate eyes and skin. Read and observe the instructions provided by the manufacturer of the chemical cleaner.

Polishing, Touch Up, and Body Repair

To preserve the cosmetic appearance of the body, you can occasionally treat the paint surfaces with an approved polish containing:

- Very mild abrasive to remove surface contamination without removing or damaging the paint.
- Filling compounds that fill scratches and reduce their visibility.
- Wax to provide a protective coating between the paint and environmental elements.



Regularly inspect the exterior paint for damage. Treat minor chips and scratches using a paint touch-up pen (available for purchase from Tesla). Use the touch-up pen after washing but before polishing or waxing.

Repair rock chips, fractures or scratches. Body repairs should be performed only by a Tesla approved body shop. Contact Tesla for a list of approved body shops.

- ⚠ Caution:** Do not use cutting pastes, color restoration compounds, or polishes containing harsh abrasives. These can scour the surface and permanently damage the paint.
- ⚠ Caution:** Do not use chrome polish or other abrasive cleaners.

Using a Car Cover

To preserve the cosmetic appearance of the body when Model 3 is not being used, use a genuine Tesla car cover. Car covers can be purchased from Tesla. See [Parts and Accessories](#) on page 144.

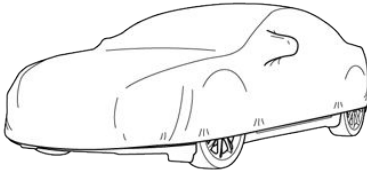

- ⚠ Caution:** Use only a Tesla-approved car cover when Model 3 is plugged in. Using a non-Tesla car cover can prevent the Battery from being adequately cooled during charging.

Floor Mats

To extend the life of your carpet and make them easier to clean, use genuine Tesla floor mats (see [Parts and Accessories](#) on page 144). Maintain floor mats by regularly cleaning them and checking that they are properly attached. Replace floor mats if they become excessively worn.

- ⚠ Warning:** To avoid potential interference with a foot pedal, ensure that the driver's floor mat is securely fastened, and never place an additional floor mat on top of it. Floor mats should always rest on top of the vehicle carpeting surface and not on another floor mat or other covering.



Checking and Cleaning Wiper Blades

Periodically clean the edge of the wiper blades and check the rubber for cracks, splits, and roughness. If damaged, replace the blade immediately to prevent damage to the glass.

Contaminants on the windshield, or on the wiper blades, can reduce the effectiveness of the wipers. Contaminants include ice, wax spray from car washes, washer fluid with bug and/or water repellent, bird droppings, tree sap, and other organic substances.

Follow these guidelines for cleaning:

- Clean the windshield and wiper blades using washer fluid, isopropyl (rubbing) alcohol, or non-abrasive glass cleaner approved for use on automotive glass and rubber. Inappropriate products can cause damage or smears, and create glare on the windshield.
- Lift the wiper arm a short distance away from the windshield, just far enough to access the wiper blade. Do not lift a wiper arm beyond its intended position.

If the wipers remain ineffective after cleaning, replace the wiper blades.

Replacing Wiper Blades

For optimum performance, replace the wiper blades at least once a year.

Note: Only install replacement blades that are identical to the original blades. Using inappropriate blades can damage the wiper system and windshield.

To replace the wiper blades:

1. Shift into Park and turn off the wipers.
2. Touch **Controls** > **Service** > **Wiper Service Mode** > **ON** to move the wipers to the service position.
3. Lift the wiper arm a short distance away from the windshield, just far enough to access the wiper blade.

⚠ Caution: Wiper blades do not lock into a lifted position. Do not lift a wiper arm beyond its intended position.

4. Hold the wiper arm (the wiper arm does not lock into a lifted position) and press the locking tab while sliding the blade down the arm.

Note: If necessary, temporarily place a towel under the wiper arm to avoid scratching the windshield.



5. Align the new blade on the wiper arm and slide it toward the hooked end of the arm until it locks into place.
6. Place the wiper arm against the windshield.
7. Turn Wiper Service Mode off to return the wipers to their normal position.

Cleaning Washer Jets

The position of the windshield washers is set at the factory and should never need adjusting.

If a windshield washer becomes blocked, use a thin strand of wire to clear any blockages from the nozzle.

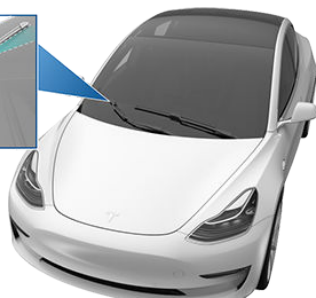
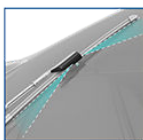

⚠ Warning: Do not operate the washers while cleaning Model 3. Windshield washer fluid can irritate eyes and skin. Read and observe the washer fluid manufacturer's instructions.



Removing the Maintenance Panel

To check fluid levels, remove the maintenance panel:

1. Open the hood.
2. Pull the maintenance panel upward to release the clips that hold it in place.

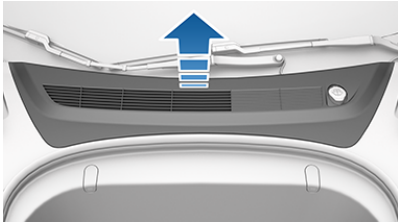

3. If checking the Battery coolant, remove the cabin intake trim panel by pulling it upwards to release the clips that hold it in place.

⚠ Caution: The maintenance panel protects the front trunk from water. When re-attaching, make sure it is fully seated.

Checking Battery Coolant

If the quantity of fluid in the cooling system drops below the recommended level, the touchscreen displays a warning message. Stop driving Model 3 as soon as safety permits and contact Tesla.

Fluid Level Check

DO NOT REMOVE THE FILLER CAP AND DO NOT ADD FLUID. Doing so can result in damage not covered by the warranty.

Do Not Top Up Battery Coolant

⚠ Warning: Battery coolant can be hazardous and can irritate eyes and skin. Under no circumstances should you remove the filler cap and/or add coolant. If the touchscreen warns you that the fluid level is low, contact Tesla immediately.

To maximize the performance and life of the Battery, the cooling system uses a specific mixture of G-48 ethylene-glycol coolant (HOAT). Contact Tesla for more specific information about the coolant.

Checking Brake Fluid

⚠ Warning: Contact Tesla immediately if you notice increased movement of the brake pedal or a significant loss of brake fluid. Driving under these conditions can result in extended stopping distances or complete brake failure.



The Brake indicator on the touchscreen alerts you if the quantity of fluid in the brake reservoir drops below the recommended level. If it displays while driving, stop as soon as safety permits by gently applying the brakes. Do not continue driving. Contact Tesla immediately.

Topping Up the Brake Fluid

Do not top up your brake fluid. The following instructions are provided for information purposes and future reference only:

1. Clean the filler cap before removing it to prevent dirt from entering the reservoir.
2. Unscrew the cap and remove it.
3. Top up the reservoir to the MAX mark using the appropriate brake fluid.
4. Replace the filler cap, ensuring it is fully secured.

⚠ Warning: Only use new fluid from a sealed air-tight container. Never use previously used fluid or fluid from a previously opened container—fluid absorbs moisture which decreases braking performance.

⚠ Warning: Brake fluid is highly toxic. Keep containers sealed and out of the reach of children. In the event of accidental consumption, seek medical attention immediately.

⚠ Caution: Brake fluid damages painted surfaces. Immediately soak up any spills with an absorbent cloth and wash the area with a mixture of car shampoo and water.



Topping Up Windshield Washer Fluid

The only reservoir into which you can add fluid is the windshield washer fluid reservoir, which is located behind the front trunk. When the level is low, a message displays on the touchscreen.

To top up the washer fluid:

1. Open the hood.
2. Clean around the filler cap before opening it to prevent dirt from entering the reservoir.
3. Open the filler cap.
4. While avoiding spilling, fill the reservoir until the fluid level is visible just below the filler neck.

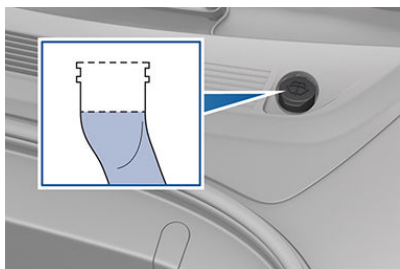

5. Wipe up any spills immediately and wash the affected area with water.
6. Replace the filler cap.

Note: Some national or local regulations restrict the use of Volatile Organic Compounds (VOCs). VOCs are commonly used as antifreeze in washer fluid. Use a washer fluid with limited VOC content only if it provides adequate freeze resistance for all climates in which you drive Model 3.

Caution: Do not add formulated washer fluids that contain water repellent or bug wash. These fluids can cause streaking, smearing, and squeaking or other noises.

Warning: In temperatures below 4° C, use a washer fluid with antifreeze. In cold weather, using a washer fluid without antifreeze can impair visibility through the windshield.

Warning: Windshield washer fluid can irritate eyes and skin. Read and observe the instructions provided by the washer fluid manufacturer.



Jacking Procedure

Follow the steps below to lift Model 3. Ensure that any non-Tesla repair facility is aware of these lifting points.

1. Position Model 3 centrally between the lift posts.
2. Position the lift arm pads under the designated body lift points at the locations shown.

Warning: DO NOT position the lift arm pads under the Battery or side rails, as shown in red.

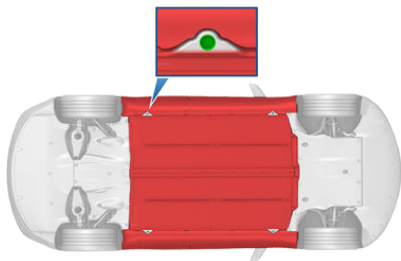

3. Adjust the height and position of the lift arm pads to ensure that they are correctly located.
4. With assistance, raise the lift, ensuring the lift arm pads remain in their correct positions.

Warning: Never raise Model 3 when the charge cable is connected, even if charging is not in progress.

Warning: Do not work on an incorrectly supported vehicle. Doing so can cause serious damage, bodily injury, or death.

Caution: DO NOT lift from under the Battery. Place the lift arm pads under the designated body lift points only. The locations shown are the only approved lifting points for Model 3. Lifting at any other points can cause damage. Damage caused by incorrectly lifting Model 3 is not covered by the warranty.



Parts, Accessories, and Modifications

Use only genuine Tesla parts and accessories. Tesla performs rigorous testing on parts to ensure their suitability, safety, and reliability. Purchase these parts from Tesla, where they are professionally installed and where you can receive expert advice about modifications to Model 3. Accessories are available for purchase from Tesla stores or online at www.tesla.com/shop.

Tesla is unable to assess parts manufactured by other distributors and therefore accepts no responsibility if you use non-Tesla parts on Model 3.

Warning: Installing non-approved parts and accessories, or performing non-approved modifications, can affect the performance of Model 3 and the safety of its occupants. Any damage caused by using or installing non-approved parts, or by performing non-approved modifications, is not covered by the warranty.

Warning: Tesla does not accept liability for death, personal injury or damage that occurs if you use or install non-approved accessories or make non-approved modifications.

Body Repairs

If Model 3 is in a collision, contact Tesla to ensure that it is repaired with genuine Tesla parts. Tesla has selected and approved body shops that meet strict requirements for training, equipment, quality, and customer satisfaction.

Some repair shops and insurance companies might suggest using non-original equipment or salvaged parts to save money. However, these parts do not meet Tesla's high standards for quality, fit and corrosion resistance. In addition, non-original equipment and salvaged parts (and any damage or failures they might cause) are not covered by the warranty.

Using RFID Transponders

When attaching an RFID transponder (used by many automated toll systems) inside Model 3, place the transponder on the right side of the rear view mirror as shown. This ensures best results and minimizes any obstruction to your driving view.

Note: You can also attach a weather-proof transponder to the front license plate.



Installing Front License Plate Bracket

To accommodate jurisdictions that require a license plate on the front of your vehicle, Model 3 is equipped with a license plate bracket. This bracket conforms to the shape of your vehicle's front bumper and is adhered to it using strong adhesive.

Note: Tesla recommends performing this procedure on a clean, dry vehicle during a warm day. Cold and/or wet conditions may result in reduced performance of the adhesive.

To install the front license plate bracket:



1. Get isopropyl alcohol and test it on a non-visible painted surface of your vehicle to confirm that it does not damage or remove the paint.
2. Clean the mounting site with isopropyl alcohol and allow to dry for at least one minute.
3. Fully remove the protective tape from the adhesive at the top of the bracket and partially remove the tape from the top of the adhesive on each side. Leave the bottom half of the tape on the sides in place and fold the unattached tape outward for easy removal after aligning the bracket to the bumper.

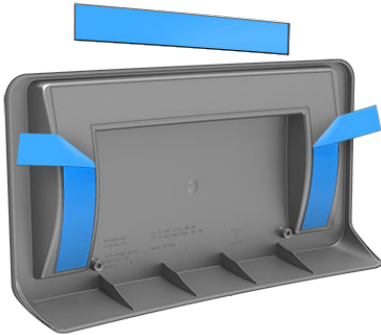

4. While tilting the top of the license plate bracket away from the bumper (to prevent adhering it to the wrong location), align the bottom center of the license plate bracket with the middle of the grille as shown.

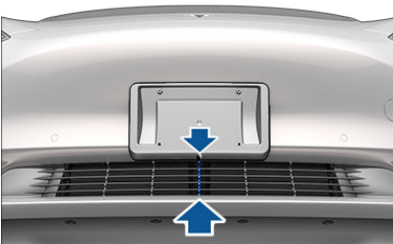

Note: Be as precise as possible when aligning the bracket because you will be unable to reposition it once adhered to the bumper.

5. While correctly aligned, move the top of the bracket against the bumper and apply pressure so that it is held in place by the adhesive.

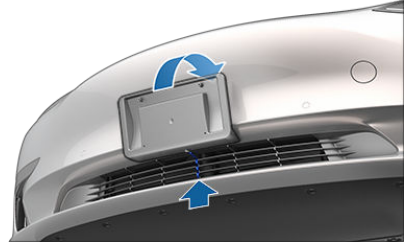

6. Remove the remaining tape from the sides of the bracket then press the entire bracket firmly against the bumper, ensuring the bracket is held in place by all adhesive areas.
7. Once the bracket is securely mounted, use the four supplied screws to attach your license plate to the bracket (tighten to 3 Nm/2.2 ft-lbs).





Vehicle Identification Number

You can find the VIN at the following locations:

- Touch the Tesla "T" at the top center of the touchscreen. The popup window displays the VIN.
- Stamped on a plate located at the top of the dashboard. Can be seen by looking through the windshield.



- Printed on the Vehicle Certification label, located on the door pillar. Can be seen when the driver's door is open.



Emission Control Label

The emission control label is located on the opening face of the rear trunk.





Load Capacity Labeling

It is important to understand how much weight your Model 3 can safely carry. This weight is called the vehicle capacity weight and includes the weight of all occupants, cargo and any additional equipment added to your Model 3 since it was manufactured.

Two labels attached to Model 3 indicate how much weight Model 3 can safely carry.

Both labels are visible on the door pillar when the driver's door is open.

Note: If your Model 3 is fitted with Tesla accessory wheels or tires, your Model 3 may include an additional label indicating that load capacity may differ from what is stated on the label. If this is the case, instead of referring to the label, refer to the Owners Manual.

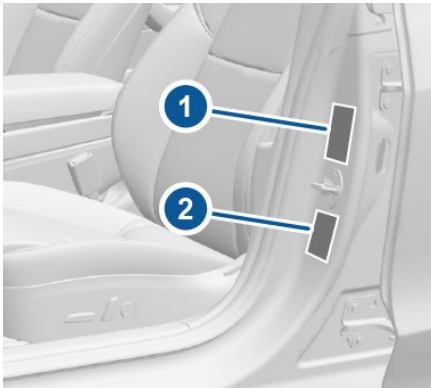

1. Tire and Loading Information Label
2. Vehicle Certification Label

Warning: Overloading Model 3 has an adverse effect on braking and handling, which can compromise your safety or cause damage.

Caution: Never load more than 55 lbs (25 kg) in the front trunk. Doing so can cause damage.

Caution: Never load more than 130 lbs (60 kg) on the rear load floor (above the lower trunk compartment) or more than 285 lbs (130 kg) in the lower trunk compartment. Doing so can cause damage.

Caution: Never store large amounts of liquid in Model 3. A significant spill can cause electrical components to malfunction.

Tire and Loading Information Label

The Tire and Loading Information label provides:

- The maximum number of occupant seating positions.
- The maximum vehicle capacity weight.
- The size of the original tires.
- The cold inflation pressures for the original front and rear tires. These pressures are recommended to optimize ride and handling characteristics.

Mexico:

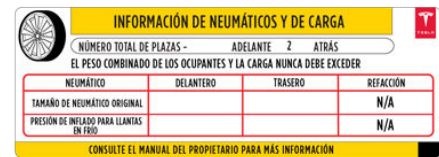

Never change this label, even if you use different tires in the future.

Note: If Model 3 is loaded to its full capacity, double check all tires to ensure they are inflated to their recommended pressure levels.

Vehicle Certification Label

The Vehicle Certification label provides:

- GVWR - Gross Vehicle Weight Rating. The maximum allowable total mass of Model 3. This is calculated as the weight of Model 3, all passengers, fluids, and cargo.
 - GAWR FRT and GAWR RR - Gross Axle Weight Rating for the front and rear axles. The GAWR is the maximum distributed weight that each axle can support.
- Caution:** To prevent damage, never load Model 3 so that it is heavier than GVWR or exceeds the individual GAWR weights.

Calculating Load Limits

1. Locate the statement "The combined weight of occupants and cargo should never exceed XXX lbs or XXX kg" on the "Tire and Loading Information" label.
2. Determine the combined weight of all occupants that will ride in the vehicle.
3. Subtract the combined weight of the occupants from XXX lbs or XXX kg (see Step 1).



- The resulting figure equals the available cargo load capacity. For example, if the “XXX” amount equals 1400 lbs (635 kg) and there will be five 150 lb (68 kg) passengers in the vehicle, the amount of available cargo capacity is 650 lbs (1400 - 750 (5 x 150) = 650 lbs) or 295 kg (635 - 340 (5 x 68) = 295 kg).
- Determine the combined cargo weight being loaded on the vehicle. That weight must not exceed the available cargo load capacity calculated in Step 4.

Warning: Trunks are the preferred places to carry objects. In a collision, or during hard braking and sharp turns, loose items in the cabin could injure occupants.

Example Load Limit Calculations

How much cargo Model 3 can carry depends on the number and weight of passengers. The following calculated load limit examples assume passengers weigh 150 lbs (68 kg). If passengers weigh more or less, available cargo weight decreases or increases respectively.

Driver and one passenger

Description	Total
Vehicle capacity weight	954 lbs (433 kg)
Subtract occupant weight (2 x 150 lbs/68 kg)	300 lbs (136 kg)
Available cargo weight	654 lbs (297 kg)

Driver and four passengers

Description	Total
Vehicle capacity weight	954 lbs (433 kg)
Subtract occupant weight (5 x 150 lbs/68 kg)	750 lbs (340 kg)
Available cargo weight	204 lbs (93 kg)

The cargo weight should be distributed between the front and rear trunks.

Caution: Do not exceed the maximum front trunk load weight of 55 lbs (25 kg).

Caution: Never load more than 130 lbs (60 kg) on the rear load floor (above the lower trunk compartment) or more than 285 lbs (130 kg) in the lower trunk compartment. Doing so can cause damage.

Towing a Trailer

Warning: Do not use Model 3 for towing purposes. Model 3 does not currently support towing. Towing can cause damage and increase the risk of a collision.

Caution: Using Model 3 for towing before Tesla-approved towing components and accessories are available may void the warranty.

Roof Racks

Model 3 supports the use of Tesla-approved roof racks using a Tesla mounting accessory. To install roof racks, you must use this accessory and you must use only roof rack systems that have been approved by Tesla (see [Parts and Accessories](#) on page 144). Failure to do so can cause significant damage.

Note: Mounting accessories and roof rack systems may not be available at time of vehicle purchase.



Exterior Dimensions

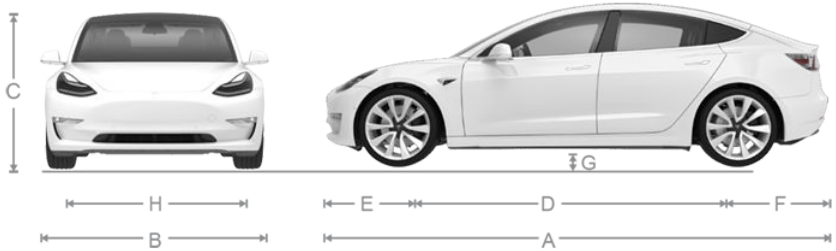

A	Overall Length	184.8 in	4,694 mm
B	Overall Width (including mirrors)	82.2 in	2,088 mm
	Overall Width (including folded mirrors)	76.1 in	1,933 mm
	Overall Width (excluding mirrors)	72.8 in	1,849 mm
C	Overall Height - coil suspension	56.8 in	1,443 mm
D	Wheel Base	113.2 in	2,875 mm
E	Overhang - Front	33 in	841 mm
F	Overhang - Rear	39 in	978 mm
G	Ground Clearance - coil suspension	5.5 in	140 mm
H	Track - Front	62.2 in	1,580 mm
	Track - Rear	62.2 in	1,580 mm

*Values are approximate. Dimensions can vary depending on a vehicle's options and various other factors.

Interior Dimensions

Head Room (Premium Package)	Front	40.3 in	1,024 mm
	Rear	37.7 in	958 mm
Leg Room	Front	42.7 in	1,085 mm
	Rear	35.2 in	894 mm
Shoulder Room	Front	56.3 in	1,430 mm
	Rear	54 in	1,372 mm
Hip Room	Front	53.4 in	1,356 mm
	Rear	52.4 in	1,331 mm



Cargo Volume

Total enclosed cargo volume	15 cu ft (425 L)
-----------------------------	------------------

Weights

Curb Weight* - Mid-Range Battery, Single Motor	3,686 lbs	1,672 kg
Curb Weight* - Long Range Battery, Single Motor	3,805 lbs	1,726 kg
Curb Weight* - Long Range Battery, Dual Motor	4,072 lbs	1,847 kg
Curb Weight* - Long Range Battery, Performance Dual Motor	4100 lbs	1,860 kg
GVWR** - Mid-Range Battery, Single Motor	4,687 lbs	2,126 kg
GVWR** - Long Range Battery, Single Motor	4,806 lbs	2,180 kg
GVWR** - Long Range Battery, Dual Motor	4,993 lbs	2,265 kg
GVWR** - Long Range Battery, Performance Dual Motor	5,073 lbs	2,301 kg
Gross Vehicle Weight Distribution - Single Motor	Front: 44%	Rear: 56%
Gross Vehicle Weight Distribution - Dual Motor	Front: 46%	Rear: 54%
Gross Axle Weight Rating - Front	2,447 lbs	1,110 kg
Gross Axle Weight Rating - Rear	2,771 lbs	1,257 kg
Trailer Towing	Not permissible	
*Curb Weight = weight of the vehicle with correct fluid levels, no occupants and no cargo		
**GVWR = Gross Vehicle Weight Rating		
Note: Values are approximate. Weights can vary depending on a vehicle's options.		



Transmission

Type	Single speed fixed gear
Gearbox Ratio	9:1

Brakes

Type	4-wheel anti-lock braking system (ABS) with Electronic Brake Force Distribution, Integrated Advanced Stability Control and Electronic Accelerator pedal actuated regenerative braking system
Calipers	Front: Four piston fixed Rear: Integrated Electronic Parking Brake Sliding
Rotor Diameter (ventilated)	Front (non-Performance): 12.6"/320 mm Front (Performance): 13.98"/355 mm Rear (non-Performance): 13.2"/335 mm Rear (Performance): 13.2"/335 mm
Front Rotor thickness	New: 0.98"/25 mm Service limit: 0.91"/23 mm
Rear Rotor thickness	New: 0.79"/20 mm Service limit: 0.71"/18 mm
Non-Performance Front Brake Pad Thickness (excluding back plate)	New: 0.393"/10 mm Service limit: 0.110"/2.8 mm
Non-Performance Rear Brake Pad Thickness (excluding back plate)	New: 0.354"/9 mm Service limit: 0.078"/2 mm
Performance Front Brake Pad Thickness (excluding back plate)	New: 0.63"/16 mm Service limit: 0.320"/8.15 mm
Performance Rear Brake Pad Thickness (excluding back plate)	New: 0.643"/16.33 mm Service limit: 0.320"/8.15 mm
Parking brake	Electrically actuated parking brake integrated into rear caliper

Suspension

Front	Independent, double wishbone, coil spring/telescopic damper, sway bar
Rear	Independent, multi-link, coil spring/telescopic damper



Battery - 12V

Rating	33 amp hour or higher
Voltage and Polarity	12V negative (-) ground

Battery - High Voltage

Type	Liquid-cooled lithium ion (Li-ion)
Nominal Voltage	360 V DC
Temperature Range	Do not expose Model 3 to ambient temperatures above 60° C or below -30° C for more than 24 hours at a time.



Wheel Specifications (Factory)

Wheel Diameter	Location	Width (in)	Offset (mm)
18"	Front/Rear	8.5	40
19"	Front/Rear	8.5	40
20" (non-Performance brakes)	Front/Rear	8.5	40
20" (Performance brakes)	Front/Rear	8.5	35

Lug Nut Torque	129 lb. ft (175 Nm)
Lug Nut Socket Size	21 mm
Note: For instructions on how to jack/lift Model 3, see Jacking and Lifting on page 143.	

Tire Specifications (Factory)

Tire Size	Location	Size
18"	Front/Rear	P235/45R18
19"	Front/Rear	P235/40R19
20"	Front/Rear	P235/35R20
Tire pressures vary depending on the type of tires fitted. Refer to the tire pressures printed on the Tire and Loading Information label. This label is located on the center door pillar and is visible when the driver's door is open (see Maintaining Tire Pressures on page 130).		
Winter tires can be purchased from a Tesla store.		



Understanding Tire Markings

Laws require tire manufacturers to place standardized information on the sidewall of all tires. This information identifies and describes the fundamental characteristics of the tire. It also provides the tire identification number (TIN) for certification of safety standards, and in case of a recall.

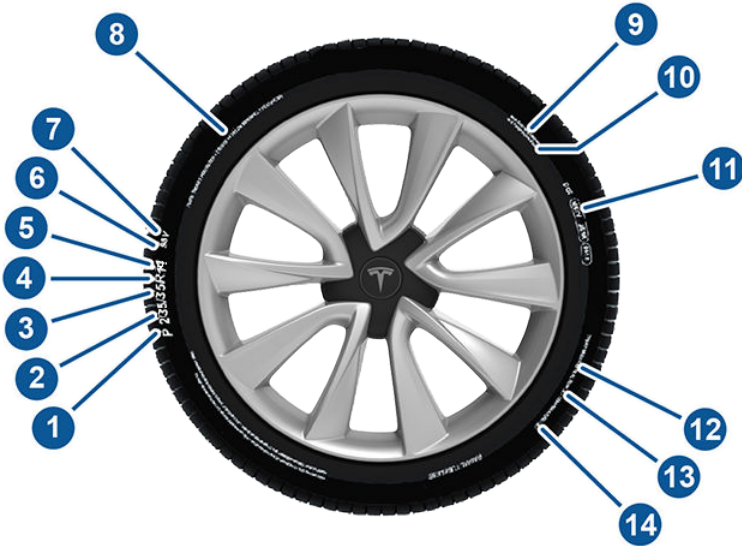

1	Tire category. P indicates that the tire is for passenger vehicles.
2	Tire width. This 3-digit number is the width (in millimeters) of the tire from sidewall edge to sidewall edge.
3	Aspect ratio. This 2-digit number is the sidewall height as a percentage of the tread width. So, if the tread width is 205 mm, and the aspect ratio is 50, the sidewall height is 102 mm.
4	Tire construction. R indicates that the tire is of Radial ply construction.
5	Wheel diameter. This 2-digit number is the diameter of the wheel rim in inches.
6	Load index. This 2 or 3-digit number is the weight each tire can support. This number is not always shown.
7	Speed rating. When stated, indicates the maximum speed (in mph) at which the tire can be used for extended periods. Q=99 mph (160 km/h), R=106 mph (170 km/h), S=112 mph (180 km/h), T=118 mph (190 km/h), U=124 mph (200 km/h), H=130 mph (210 km/h), V=149 mph (240 km/h), W=168 mph (270 km/h), Y=186 mph (300 km/h).
8	Tire composition and materials. The number of plies in both the tread area and the sidewall area indicates how many layers of rubber coated material make up the structure of the tire. Information is also provided on the type of materials used.
9	Maximum tire load. The maximum load which can be carried by the tire.
10	Maximum permissible inflation pressure. This pressure should not be used for normal driving.



11	U.S. DOT Tire Identification Number (TIN). Begins with the letters DOT and indicates that the tire meets all federal standards. The next 2 digits/letters represent the plant code where it was manufactured, and the last 4 digits represent the week and year of manufacture. For example, the number 1712 is used to represent the 17th week of 2012. The other numbers are marketing codes used at the manufacturer's discretion. This information can be used to contact consumers if a tire defect requires a recall.
12	Treadwear grade. This number indicates the tire's wear rate. The higher the treadwear number is, the longer it should take for the tread to wear down. A tire rated at 400, for example, lasts twice as long as a tire rated at 200.
13	Traction grade. Indicates a tire's ability to stop on wet roads. A higher graded tire should allow you to stop your vehicle in a shorter distance than a tire with a lower grade. Traction is graded from highest to lowest as AA, A, B, and C.
14	Temperature grade. The tire's resistance to heat is grade A, B, or C, with A indicating the greatest resistance. This grading is provided for a correctly inflated tire, which is being used within its speed and loading limits.



Uniform Tire Quality Grading

The following information relates to the tire grading system developed by the National Highway Traffic Safety Administration (NHTSA), which grades tires by tread wear, traction and temperature performance. Tires that have deep tread, and winter tires, are exempt from these marking requirements.

Where applicable, quality grades are found on the tire's sidewall between the tread shoulder and maximum section width. For example:

- TREADWEAR 180
- TRACTION AA
- TEMPERATURE A

The quality grades are described next.

Note: In addition to the marking requirements, passenger car tires must conform to Federal Safety Requirements.

Treadwear

The treadwear grade is a comparative rating based on the wear rate of the tire when tested under controlled conditions on a specified government test course.

For example, a tire graded 150 wears one and a half times better on a government test course than a tire graded 100. The relative performance of tires depends on the actual conditions of their use, however, and can depart significantly from the norm due to variations in driving habits, service practices, road characteristics, and climate.

Traction

The traction grades, from highest to lowest, are: AA, A, B, and C. These grades represent a tire's ability to stop on wet pavement as measured under controlled conditions on test surfaces of asphalt and concrete. A tire marked C might have poor traction performance.

Warning: Defective tires are dangerous. Do not drive if a tire is damaged, excessively worn, or is inflated to an incorrect pressure. The safety of the vehicle and occupants can be adversely affected. Check tires regularly for wear and to ensure there are no cuts, bulges or exposure of the ply/cord structure.

Warning: The traction grade assigned to the tire is based on straight-ahead braking tests, and does not include:

acceleration, cornering, hydroplaning or peak traction characteristics.

Temperature

The temperature grades are A (the highest), B, and C, representing the tire's resistance to the generation of heat and its ability to dissipate heat when tested under controlled conditions on a specified indoor laboratory test wheel. Sustained high temperature can cause the tire to degenerate and reduce tire life, and excessive temperature can lead to sudden tire failure.

The grade C corresponds to the minimum level of performance that all passenger car tires must meet under the Federal Motor Safety Standard No. 109. Grades B and A represent levels of performance on the laboratory test wheel that exceed the minimum requirements.

Warning: A tire's temperature grade is established for a tire that is properly inflated and not overloaded. Excessive speed, under-inflation, or excessive loading, either separately or in combination, can cause heat buildup and possible tire failure.



Tesla Roadside Assistance is available to you, 24 hours a day, 365 days a year, for the duration of your warranty period.

When contacting Tesla Roadside Assistance, please provide:

- The Vehicle Identification Number (VIN). The VIN is displayed when you touch the Tesla "T" at the top of the touchscreen. The VIN can also be seen on the upper dashboard by looking through the driver's side of the windshield.
- Your exact location.
- The nature of the problem.

Tesla Roadside Assistance is available to speak with roadside service professionals 24/7/365 to answer any questions and explain the proper procedure for transporting your Model 3.

Regional Phone Number(s)

Mexico: [1-800-228-8145](tel:1-800-228-8145)

Note: The phone number is also available by touching the Tesla "T" at the top center of the touchscreen.



When Transporting Model 3

Always transport Model 3 with all four tires off the ground. A flatbed truck or comparable transport vehicle is recommended. A wheel lift and dollies can be used only when transporting Model 3 for a maximum of 35 miles (55 km), not to exceed the manufacturer speed rating of the dollies. When transporting, whether on a flatbed truck or using a wheel lift and dolly, Model 3 can face either direction.

Do not transport Model 3 using any other method unless specified by Tesla. Follow the steps provided and observe all warnings and cautions. Damage caused by transporting your vehicle is not covered by the warranty.

Note: The following illustrations are for demonstration purposes only.



Never tow Model 3 with the tires in a position where they can spin, such as in contact with the ground, even for short distances. Doing so can cause significant damage. In addition, before pulling Model 3 onto a flatbed truck, you must use the touchscreen to enable Transport Mode. Transport Mode keeps the parking brake disengaged and monitors the vehicle for conditions (explained later) that could result in damage and automatically applies the parking brake if a condition is detected. Do not attempt to use Transport Mode to tow Model 3 with the tires on the ground. If you are unable to activate Transport Mode, you must use self-loading dollies or tire skates to prevent the tires from turning as you pull Model 3 onto a flatbed truck.

Warning: TOWING MODEL 3 WITH THE TIRES CONTACTING THE GROUND CAN CAUSE OVERHEATING AND DAMAGE TO THE REAR MOTOR.

Warning: To prevent damage and overheating of the rear motor when rolling or winching Model 3 onto a flatbed truck, you must either enable Transport Mode or use self-loading dollies or tire skates. Do not allow the tires to turn without Transport Mode enabled.

Note: Tesla is not responsible for any damage caused by transporting Model 3, including personal or property damage caused by using self-loading dollies or tire skates.

Warning: Model 3 is equipped with high voltage components (see [High Voltage Components](#) on page 120). Before transporting Model 3 as a result of an event (such as a collision) that may have compromised a high voltage component, it is important to assume that these components are energized. Always follow high voltage safety precautions (wearing personal protective equipment, etc.) until emergency response professionals have evaluated the vehicle and can accurately confirm that all high voltage systems are no longer energized. Failure to do so may result in serious injury or death.

Activate Transport Mode

Transport Mode is intended to keep the parking brake disengaged while winching Model 3 onto a flatbed truck. When active, Transport Mode monitors Model 3 for conditions that could result in damage to the vehicle (rolling speed exceeds 5 mph (8 km/h) or if 12V power is low). This applies the parking brake if a condition is detected. The following are required to enable Transport Mode:

- 12V power is required. You are unable to use the touchscreen to activate Transport Mode if Model 3 has no 12V power. See [Jump Starting the 12V Battery](#) on page 160 for instructions on how to jump start the 12V battery.
- Model 3 must detect a valid key (authenticated smartphone, key card, or key fob). If a key is not detected, the Transport Mode button on the touchscreen is grayed out. See [Keys](#) on page 7.

To activate Transport Mode:

1. Shift into Park.
2. Chock the tires or otherwise ensure Model 3 is stable.
3. Press and hold the brake pedal, then on the touchscreen touch **Controls** > **Service** > **Towing**. A message displays reminding you of how to properly transport Model 3.
4. Hold the **Transport Mode** button until it turns blue. Model 3 is now free-rolling and can be rolled or winched at very low speeds.



To cancel Transport Mode, shift Model 3 into Park.

⚠ Caution: Transport Mode automatically cancels and the parking brake is applied if Model 3 is rolled faster than 5 mph (8 km/h) or 12V power is low. Model 3 sounds its horn to warn you that Transport Mode is about to cancel.

Pull onto the Flatbed Truck

Note: If Model 3 has no 12V power, you need an external 12V power supply to open the hood or use the touchscreen. See [If Model 3 Has No Power](#) on page 160.

⚠ Caution: To avoid damage, only pull the vehicle onto a flatbed truck using a properly-installed tow eye. Using the chassis, frame, or suspension components to pull the vehicle can result in damage.

1. Activate Transport Mode.
2. Locate the tow eye. The tow eye is located under the carpet in the front trunk.



3. Release the tow eye cover by pressing firmly on the top right perimeter of the cover until it pivots inward, then gently pulling the raised section toward you.

Note: The tow eye cover is connected to the vehicle's black negative (-) terminal.



4. Fully insert the tow eye into the opening, then turn it **counter-clockwise** until securely fastened.

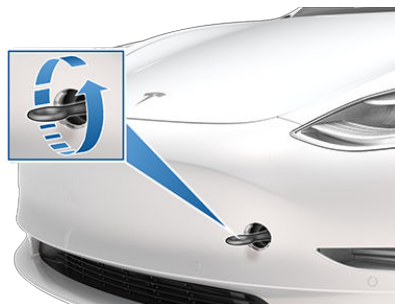

5. Attach the winch cable to the tow eye.
 - ⚠ Caution:** Before pulling, make sure the tow eye is securely tightened.
6. Pull Model 3 slowly onto the flatbed truck.
7. Shift Model 3 into Park by pressing the button on the end of the gear selector.
8. Remove the tow eye and return it to its location in the front trunk.

Note: The tow eye is required to pull Model 3 onto a flatbed truck. When not being used, always keep the tow eye in its storage location in the front trunk. If you lose the tow eye, contact Tesla.

9. Replace the tow eye cover by inserting the wires into the tow eye opening and aligning the tow eye cover into position and turning it into place.



Secure the Tires

The vehicle's tires must be secured onto the truck using the eight-point tie-down method.

- Ensure any metal parts on the tie-down straps do not contact painted surfaces or the face of the wheels.



- Do not place tie-down straps over body panels or through the wheels.



⚠ Caution: Attaching tie-down straps to the chassis, suspension or other parts of the vehicle's body may cause damage.

If Model 3 Has No Power

If Model 3 has no 12V power, perform the following steps to open the hood or jump start the auxiliary 12V battery.

Jump Starting the 12V Battery

⚠ Caution: Model 3 cannot be used to jump start another vehicle. Doing so can result in damage.

Note: If jump starting Model 3 using another vehicle, refer to that vehicle manufacturer's instructions. The following instructions assume an external 12V power supply (such as a portable jump starter) is used.

⚠ Caution: Avoid short circuits when jump starting Model 3. Connecting cables to the wrong terminals, touching leads together, etc. can result in damage to Model 3.

1. Open the hood (see [Opening with No Power](#) on page 18).

2. Remove the maintenance panel by pulling it upwards to release the trim clips that hold it in place.

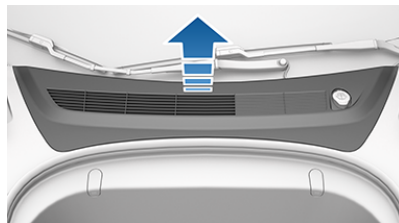

3. Remove the cabin intake trim panel by pulling it upwards to release the trim clips that hold it in place.



4. Connect the 12V power supply's red positive (+) cable to the red positive (+) terminal on the 12V battery.

⚠ Caution: To avoid damaging Model 3, do not allow the positive cable to contact other metal components, such as the battery tie-down bracket.

5. Connect the 12V power supply's black negative (-) cable to the black negative (-) terminal on the 12V battery.

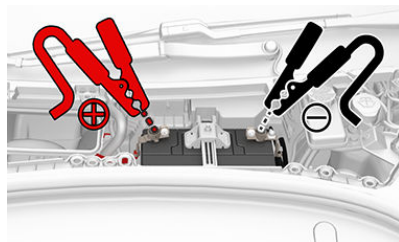

6. Turn on the external power supply (refer to the manufacturer's instructions). Touch the touchscreen to wake it up.

Note: It may take several minutes to receive enough power to wake up the touchscreen.



7. When external 12V power is no longer required, disconnect both cables from the terminals on the 12V battery, beginning with the black negative (-) cable.
8. Replace the cabin intake trim panel by placing it back in its original location and pressing down until it is secure.
9. Replace the maintenance panel by placing it back in its original location and pressing down until it is secure.
10. Close the hood.



But wait, there's more! Below is a list of the Easter Eggs that have been discovered so far and how to access them. Alternatively, touch the Tesla "T" (top center of the touchscreen) then drag the **About Your Tesla** box downwards for one-touch access to all discovered Easter Eggs.

For This...	Do This...
Atari Games	Feeling nostalgic? While in Park, access Atari games from your Easter Egg tray then select a game from the menu at the top, enter some quarters, and touch Start to play. Touch Full to enter full-screen and triple-tap your touchscreen to exit full-screen. Note that, depending on the game, you may need to use your steering wheel buttons to play.
Santa Mode	"What have you been longing for?" Enjoy the holidays year-round with this one! Simply initiate a voice command (see Using Voice Commands on page 114) and say "Ho Ho Ho". Or, if you are feeling extra sour, you can say "Ho Ho Ho Not Funny" instead.
Rainbow Road	Need more cowbell? Visit Rainbow Road by moving the gear lever fully down four times in quick succession while Autosteer is enabled.
Sketchpad	Triple-tap the Tesla "T" (top center of the touchscreen) and channel your inner Picasso. Show us what you got! Touch Publish to submit your artistic compositions to Tesla for critiquing.
Mars	Press and hold the Tesla "T" (top center of the touchscreen) then enter mars in the access code popup. The map shows your Model 3 as a rover on the Martian landscape, and the About Your Tesla box displays SpaceX's interplanetary spaceship.
The Answer to the Ultimate Question of Life, The Universe, and Everything	Rename your car to 42 (see Naming Your Vehicle on page 96) and notice the new name of your Model 3.
Romance Mode	You can't roast chestnuts by an open fire in your car, but you can still cozy up with your loved ones by this virtual fireplace. While in Park, access Romance Mode from your Easter Egg tray. Queue the music and get your romance on!
Emissions Testing Mode	Holiday fun can come in surprising ways. Access Emissions Testing Mode from your Easter Egg tray, then select your preferred fart style and a target seat. Activate by pressing the left scroll wheel button when you're ready to "release" your prank.



Document Applicability

Owner information is updated regularly to reflect updates to your vehicle. However, in some cases, recently released features may not be described. To display information about recently released features, view the Release Notes on the touchscreen. Release Notes are displayed on the touchscreen after a software update, and can be displayed at any time by touching the Tesla "T" at the top of the touchscreen, then touching the Release Notes link. If information related to how to use the touchscreen conflicts with information in the Release Notes, the Release Notes take precedence.

Illustrations

Illustrations are provided for demonstration purposes only. Depending on vehicle options, software version, region of purchase, and specific settings, your vehicle may appear slightly different. Although the owner information is applicable to both right-hand drive and left-hand drive vehicles, many illustrations show only left-hand drive vehicles. However, the essential information that the illustrations are providing is correct.

Errors or Inaccuracies

All specifications and descriptions are known to be accurate at time of publishing. However, because continuous improvement is a goal at Tesla, we reserve the right to make product modifications at any time. To communicate any inaccuracies or omissions, or to provide general feedback or suggestions regarding the quality of this owner information, send an email to OwnersManualFeedback@Tesla.com.

Location of Components

Owner information may specify the location of a component as being on the left or right side of the vehicle. As shown, left (1) and right (2) represent the side of the vehicle when sitting inside.

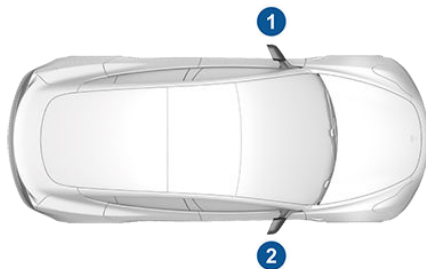

Copyrights and Trademarks

All information in this document and all vehicle software is subject to copyright and other intellectual property rights of Tesla, Inc. and its licensors. This material may not be modified, reproduced or copied, in whole or in part, without the prior written permission of Tesla, Inc. and its licensors. Additional information is available upon request. Tesla uses software created by the Open Source community. Please visit Tesla's Open Source software website at www.tesla.com/opensource. HD Radio is a registered trademark of iBiquity Digital Corporation. The following are trademarks or registered trademarks of Tesla, Inc. in the United States and other countries:

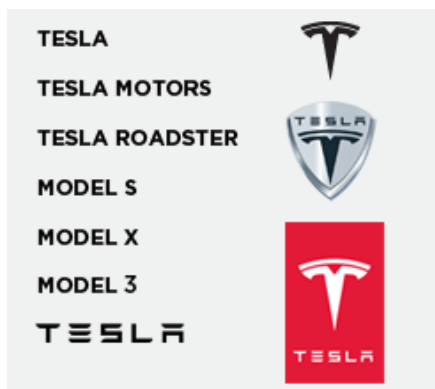

All other trademarks contained in this document are the property of their respective owners and their use herein does not imply sponsorship or endorsement of their products or services. The unauthorized use of any trademark displayed in this document or on the vehicle is strictly prohibited.



Vehicle Telematics

Model 3 is equipped with electronic modules that monitor and record data from various vehicle systems, including the motor, Autopilot components, Battery, braking and electrical systems. The electronic modules record information about various driving and vehicle conditions, including braking, acceleration, trip and other related information regarding your vehicle. These modules also record information about the vehicle's features such as charging events and status, the enabling/disabling of various systems, diagnostic trouble codes, VIN, speed, direction and location.

The data is stored by the vehicle and may be accessed, used and stored by Tesla service technicians during vehicle servicing or periodically transmitted to Tesla wirelessly through the vehicle's telematics system. This data may be used by Tesla for various purposes, including, but not limited to: providing you with Tesla telematics services; troubleshooting; evaluation of your vehicle's quality, functionality and performance; analysis and research by Tesla and its partners for the improvement and design of our vehicles and systems; and as otherwise may be required by law. In servicing your vehicle, Tesla can potentially resolve issues remotely simply by reviewing your vehicle's data log.

Tesla's telematics system wirelessly transmits vehicle information to Tesla on a periodic basis. The data is used as previously described and helps ensure the proper maintenance of your vehicle. Additional Model 3 features may use your vehicle's telematics system and the information provided, including features such as charging reminders, software updates, and remote access to, and control of, various systems of your vehicle.

Tesla does not disclose the data recorded in your vehicle to any third party except when:

- An agreement or consent from the vehicle's owner (or the leasing company for a leased vehicle) is obtained.
- Officially requested by the police or other authorities.
- Used as a defense for Tesla in a lawsuit.
- Ordered by a court of law.
- Used for research purposes without disclosing details of the vehicle owner or identification information.

- Disclosed to a Tesla affiliated company, including their successors or assigns, or our information systems and data management providers.

In addition, and subject to local law, Tesla does not disclose the data recorded to an owner unless it pertains to a non-warranty repair service and in this case, will disclose only the data that is related to the repair. For additional information regarding how Tesla processes data collected from your vehicle, please review Tesla's privacy policy at www.tesla.com/about/legal.

Data Sharing

For quality assurance and to support the continuous improvement of advanced features such as Autopilot, Tesla measures road segment data of all participating vehicles. All Tesla vehicles can learn from the experience of the billions of miles that Tesla vehicles have driven. Although Tesla shares this data with partners that contribute similar data, the data does not include any personally identifiable information about you or your vehicle. To allow data sharing, touch **Controls > Safety & Security > Data Sharing**, touch the **Yes** buttons to confirm that you agree to allow Tesla to collect the associated type of data, then submit your response.

Note: Although Model 3 uses GPS in connection with driving and operation, as discussed in this owner's manual, Tesla does not record or store vehicle-specific GPS information. Consequently, Tesla is unable to provide historical information about a vehicle's location (for example, Tesla is unable to tell you where Model 3 was parked/traveling at a particular date/time).

Quality Control

You might notice a few km on the odometer when you take delivery of your Model 3. This is a result of a comprehensive testing process that ensures the quality of your Model 3.

The testing process includes extensive inspections during and after production. The final inspection takes place at Tesla and includes a road test conducted by a technician.



Contacting Tesla

For detailed information about your Model 3, go to www.tesla.com, and log on to your Tesla Account, or sign up to get an account.

If you have any questions or concerns about your Model 3, call 1-800-228-8145.

Note: You can also use voice commands to provide feedback to Tesla. Say "Note", "Report", "Bug note", or "Bug report" followed by your brief comments. Model 3 takes a snapshot of its systems, including your current location, vehicle diagnostic data, and screen captures of the touchscreen. Tesla periodically reviews these notes and uses them to continue improving Model 3.



Passive Entry System

Certification Labels

Pillar Endpoint:

 Tesla, Inc.
Model: 1089773
FCC ID 2AEIM-1089773
IC: 20098-1089773
This device complies with Part 15 of the FCC Rules. Operation is subject to the following two conditions: (1) this device may not cause harmful interference, and (2) this device must accept any interference received, including interference that may cause undesired operation.
CAN ICES-3 (B)/NMB-3(B)

 Tesla, Inc.
Model: 1089773E
FCC ID 2AEIM-1089773E
IC: 20098-1089773E
This device complies with Part 15 of the FCC Rules. Operation is subject to the following two conditions: (1) this device may not cause harmful interference, and (2) this device must accept any interference received, including interference that may cause undesired operation.
CAN ICES-3 (B)/NMB-3(B)

Center Console:

 Tesla, Inc.
Model: 1089774
FCC ID 2AEIM-1089774
IC: 20098-1089774
This device complies with Part 15 of the FCC Rules. Operation is subject to the following two conditions: (1) this device may not cause harmful interference, and (2) this device must accept any interference received, including interference that may cause undesired operation.
CAN ICES-3 (B)/NMB-3(B)

Fascia Endpoint:

 Tesla, Inc.
Model: 1089775
FCC ID 2AEIM-1089775
IC: 20098-1089775
This device complies with Part 15 of the FCC Rules. Operation is subject to the following two conditions: (1) this device may not cause harmful interference, and (2) this device must accept any interference received, including interference that may cause undesired operation.
CAN ICES-3 (B)/NMB-3(B)



FCC Certification

Component	Mfr	Operating Freq (MHz)	Tested For	FCC ID
Pillar Endpoint 1089773 Pillar Endpoint 1089773E	Tesla	13.56 and 2400	US Canada	2AEIM-1089773 2AEIM-1089773E
Center Console 1089774	Tesla	13.56 and 2400	US Canada	2AEIM-1089774
Fascia Endpoint 1089775	Tesla	2400	US Canada	2AEIM-1089775

Per FCC IDs 2AEIM-1089773, 2AEIM-1089773E, 2AEIM-1089774, and 2AEIM-1089775 the Model 3 passive entry devices listed above comply with Part 15 of the FCC rules. Operation is subject to the following two conditions:

1. This device may not cause harmful interference, and
2. This device must accept any interference received, including interference that may cause undesired operation.

Changes or modifications not expressly approved by Tesla could void your authority to operate the equipment.

Important Note:

FCC Radiation Exposure: This equipment complies with FCC radiation exposure limits for an uncontrolled environment.

⚠ Caution: This equipment and its antennas must not be co-located or operated with any other antenna or transmitter.

Key and Passive Unlocking System

FCC Certification

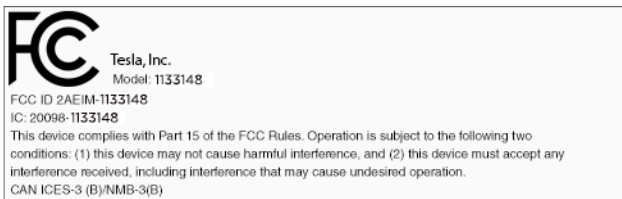

Model Number	Mfr	GHz	Tested For
Key fob 1133148	Tesla	2.4	USA Canada

Per FCC ID 2AEIM-1133148, the device(s) listed above complies with Part 15 of the FCC rules. Operation is subject to the following two conditions:

1. This device may not cause harmful interference, and
2. This device must accept any interference received, including interference that may cause undesired operation.



Changes or modifications not expressly approved by Tesla could void your authority to operate the equipment.

La Operación de Este Equipo no está Sujeta a las dos following conditions:

1. Es Posible Que Este Equipo o Dispositivo no causar interferencia perjudicial.
2. Este Equipo o Dispositivo debe Aceptar Cualquier interferencia. Incluyendo La Que Pueda causar do Operación no Deseada.

Tire Pressure Monitoring System

FCC ID: KR5S180052092

IC: 7812D-S180092

The tire pressure monitoring system (TPMS) complies with Part 15 of the FCC rules and RSS-210 of Innovation, Science and Economic Development Canada. Operation is subject to the following two conditions:

1. This device may not cause harmful interference, and
2. This device must accept any interference received, including interference that may cause undesired operation.

Changes or modifications not expressly approved by Tesla could void your authority to operate the equipment.

HomeLink

This device complies with Part 15 of the FCC rules, RSS-210 Industry Canada, and with EU Directive 2014/53/EU.

Operation is subject to the following conditions:

- This device may not cause harmful interference.
- This device must accept any interference received, including interference that may cause undesired operation.

Any changes or modifications to the device not expressly approved by the manufacturer or Tesla could void your authority to operate the equipment.

Radio Frequency Information

This equipment has been tested and found to comply with the limits for a Class B digital device, pursuant to Part 15 of the FCC Rules. These limits are designed to provide reasonable protection against harmful interference in a residential installation. This equipment generates, uses and can radiate radio frequency energy and, if not installed and used in accordance with the instructions, may cause harmful interference to radio communications. However, there is no guarantee that interference will not occur in a particular installation. If this equipment does cause harmful interference to radio or television reception, which can be determined by turning the equipment off and on, try to correct the interference by one or more of the following measures:

- Reorient or relocate the receiving antenna.
- Increase the separation between the equipment and receiver.
- Connect the equipment into an outlet on a circuit different from that to which the receiver is connected.
- Consult the dealer or an experienced radio/TV technician for help.



A

- ABS (Anti-lock Braking System) 56
- absolute speed limit 89
- access panel, removing 141
- accessories
 - plugging into power socket 21
- aero covers 133
- air circulation 99
- air conditioning 98
- air distribution 99
- air filter 101
- air vents 100
- airbags 36
- alarm 115
- all-season tires 135
- Always Show Estimated Round Trip Energy 106
- ambient lights 49
- anti-lock braking (ABS) 56
- audio
 - equalizer 110
 - immersive sound 110
 - playing files 108
 - steering wheel scroll button 42
 - volume control 108
- auto fold 44
- Auto High Beam 50
- Auto Lane Change 77
- auto tilt 44
- AUTO wipers 55
- automatic emergency braking 87
- Autopark 79
- Autopilot
 - Auto Lane Change 77
 - automatic emergency braking 86
 - Autopark 79
 - Autosteer 75
 - blind spot warning 84
 - collision avoidance assist 86
 - forward collision warning 86
 - overtake acceleration 69
 - overview 66
 - side collision warning 84
 - speed assist 89
 - speed limit warning 89
 - staying inside lane markings 84
 - staying within speed limits 89
 - Summon 81
 - Traffic-Aware Cruise Control 69
- Autopilot components 66
- Autosteer 75
- average range 63

B

- backup camera 64
- battery (12V)

- battery (12V) (*continued*)
 - complete discharge 122
 - specifications 152
- Battery (high voltage)
 - care of 122
 - coolant 141
 - specifications 152
 - temperature limits 122
- battery (key), replacing 9
- blind spot warning 84
- Bluetooth
 - devices, playing audio files from 110
 - general information 111
 - phone, pairing and using 111
- body repairs 144
- body touch up 138
- brake fluid replacement 129
- brakes
 - automatic in emergencies 87
 - fluid level 141
 - overview of 56
 - specifications 151
- Bumper Clearance (Summon) 81

C

- cabin camera 23
- cabin temperature control 98
- Calendar app 113
- camera (rear view) 64
- cameras (autopilot) 66
- car cover 139
- car washes 137
- card 8
- cargo area 15
- cargo volume 150
- carpets, cleaning 138
- CCS (Combo) 121
- CE certifications 166
- CHAdemo 121
- chains 135
- change of ownership 97
- charge port 124
- charge port light 126
- charge port manual release 125
- charge port release cable 125
- charging
 - charge settings 126
 - charging status 126
 - components and equipment 120
 - instructions 124
 - public charging stations 121
 - scheduling 126
- charging locations, finding 105
- child protection
 - disabling rear window switches 14
- child seats
 - installing and using 30



- child-protection locks 13
- cleaning 137
- climate controls 98
- coat hangers 22
- collision avoidance assist 86
- console
 - 12V power socket 21
 - opening (premium package) 20
 - rear 22
 - USB ports 20
- consumption chart 63
- contact information
 - roadside assistance 157
 - Tesla 165
- coolant
 - Battery, checking level of 141
 - Battery, replacement interval 129
- copyrights 163
- cruise control 69

D

- dashboard overview 2
- Dashcam 65
- data recording 164
- data sharing 164
- declarations of conformity 166
- delivery mileage 164
- devices
 - Bluetooth, playing audio files 110
 - connecting 20
 - playing audio files from 109
- dimensions 149
- Dog Mode 101
- dome (map) lights 49
- door handles 12
- door labels 147
- doors
 - Child Lock 13
 - exterior door handles 12
 - interior locking and unlocking 13
 - keyless entry 12
 - locking 12
 - opening from exterior 12
 - opening from interior 12
 - Unlock on Park 13
 - unlocking 12
- doorsfunction
 - Walk-Away Door Lock 13
- Drive gear 48
- driver
 - profiles 40
 - seat adjustment 24
- driving
 - seating position 24
 - starting 46
 - tips to maximize range 63

E

- Easter Eggs 162
- easy entry, driver profile 40
- electric parking brake 57
- emergency braking 86
- emergency flashers 51
- emission label 146
- energy
 - gained from regenerative braking 56
 - range information 52
- Energy app 63
- energy use predictions (navigating) 106
- Erase & Reset 97
- event data recording 164
- exterior
 - car cover 139
 - cleaning 137
 - dimensions 149
 - lights 49
 - overview 3
 - polishing, touch up, & repair 138

F

- factory defaults, restoring 97
- factory reset 97
- fan speed, interior 99
- Favorites (Media Player) 109
- Favorites (navigation) 104
- FCC certifications 166
- features, downloading new 119
- firmware (software) updates 119
- flash drives, playing audio files from 109
- flashers, warning 51
- floor mats 139
- fluids
 - replacement intervals 129
 - reservoirs, checking 141
- fog lights 49
- forward collision warning 86
- front license plate 144
- front passenger detection 38
- front trunk 17

G

- garage doors, opening 116
- gates, opening 116
- GAWR 147
- gears 48
- glovebox 20
- Gross Axle Weight Rating 147
- Gross Vehicle Weight Rating 147
- ground clearance 149
- GVWR 147



H

- hazard warning flashers [51](#)
- head supports [25](#)
- headlights
 - after exit [50](#)
 - controlling [49](#)
 - high beams [50](#)
- heating [98](#)
- high beam headlights [50](#)
- high voltage
 - Battery specifications [152](#)
 - components [120](#)
 - safety [129](#)
- hills, stopping on [61](#)
- hitches [148](#)
- Home location [106](#)
- HomeLink
 - FCC certification [168](#)
 - programming and using [116](#)
 - when using Summon [81](#)
- hood [17](#)
- horn [43](#)
- hub caps [133](#)

I

- IC certifications [166](#)
- identification labels [146](#)
- instant range [63](#)
- interior
 - cleaning [138](#)
 - dimensions [149](#)
 - lights [49](#)
 - overview [2](#)
 - temperature control [98](#)
- Internet radio [108](#)

J

- J1772 [121](#)
- jacking [143](#)
- jump starting [160](#)

K

- Keep Climate On [101](#)
- key
 - FCC and IC certifications [166](#)
 - replacing battery [9](#)
- key card [8](#)
- keyless entry [12](#)
- keys
 - adding key cards and phones [10](#)
 - deleting key cards and phones [10](#)

- keys (*continued*)
 - displaying a list of [10](#)
 - overview [7](#)

L

- label
 - Tire and Loading Information [147](#)
 - vehicle certification [147](#)
- lane assist [84](#)
- lane change, automatic [77](#)
- lane departure warning [84](#)
- LATCH child seats, installing [32](#)
- license plate bracket [144](#)
- lifting [143](#)
- lights
 - hazard warning [51](#)
 - headlights after exit [50](#)
 - turn signals [51](#)
- load limits [147](#)
- location tracking [103](#)
- locking [12](#)
- lug nut covers [133](#)
- lumbar adjustment (premium) [24](#)

M

- maintenance
 - brake fluid, checking [141](#)
 - cleaning [137](#)
 - daily and monthly checks [129](#)
 - fluid replacement intervals [129](#)
 - panel, removing [141](#)
 - replacing wiper blades [140](#)
 - service intervals [129](#)
 - tires [130](#)
 - washer fluid, topping up [142](#)
 - washer jets, cleaning [140](#)
- map orientation [103](#)
- map updates [107](#)
- mats [139](#)
- media [108](#)
- mileage upon delivery [164](#)
- mirrors [44](#)
- mobile app [10](#)
- Mobile Connector
 - description [121](#)
 - using [124](#)
- modifications [144](#)
- my car does what? [162](#)

N

- naming [96](#)
- navigating [103](#), [104](#)
- NCC certifications [166](#)



Neutral gear [48](#)

O

Obstacle-Aware Acceleration [86](#)
occupancy sensor [38](#)
odometer [6](#)
offset from speed limit [89](#)
Online Routing [106](#)
opening hood without power [160](#)
overhang dimensions [149](#)
overtake acceleration [69](#)
Owner Information, about [163](#)

P

Park Assist [59](#)
Park gear [48](#)
parking brake [57](#)
parking, using Autopark [79](#)
parking, using Summon [81](#)
parts replacement [144](#)
passenger detection [38](#)
passenger front airbag [38](#)
personal data, erasing [97](#)
phone
 adding as a key [10](#)
 authenticating as a key [7](#)
 removing as a key [10](#)
 using [111](#)
phone app [112](#)
phone key [7](#)
PIN [40](#)
PIN to Drive [115](#)
power socket [21](#)
power windows [14](#)
powering on and off [46](#)
public charging stations [121](#)

R

radar [66](#)
radio [108](#)
Radio Frequency information [166](#)
range
 driving tips to maximize [63](#)
 regenerative braking [56](#)
range assurance [63](#)
Re-route [106](#)
rear seats, folding and raising [25](#)
rear view camera [64](#)
rear window switches, disabling [14](#)
Recent (Media Player) [109](#)
Recents (navigation) [104](#)
regenerative braking [56](#)
relative speed limit [89](#)

release notes [119](#)
restarting the touchscreen [46](#)
Reverse gear [48](#)
RFID transponders [144](#)
roadside assistance [157](#)
roof racks [148](#)
rotating tires [131](#)
Round Trip Energy (navigating) [106](#)

S

safety defects, reporting [165](#)
safety information
 airbags [39](#)
 child seats [34](#)
 seat belts [29](#)
seat belts
 cleaning [138](#)
 in a collision [28](#)
 overview of [27](#)
 pre-tensioners [28](#)
 wearing when pregnant [28](#)
seat covers [26](#)
seat heaters [98, 100](#)
seating capacity [147](#)
seats
 adjusting [24](#)
 heaters [98](#)
security settings [115](#)
sensors [66](#)
service data recording [164](#)
service intervals [129](#)
Settings, erasing [97](#)
shifting gears [48](#)
Show Calendar Upon Entry [113](#)
Side Clearance (Summon) [81](#)
side collision warning [84](#)
slip start [58](#)
smartphone
 authenticating as a key [7](#)
 removing as a key [10](#)
software reset [97](#)
software updates [119](#)
software version [6](#)
specifications
 cargo volume [150](#)
 dimensions [149](#)
 exterior [149](#)
 interior [149](#)
 tires [153](#)
 weights [150](#)
 wheels [153](#)
speed assist [89](#)
Speed Limit Mode [96](#)
speed limit warning [89](#)
stability control [58](#)
starting [46](#)
steering wheel



- steering wheel (*continued*)
 - adjusting position [42](#)
 - adjusting sensitivity [42](#)
 - buttons [42](#)
 - lights, controlling [49](#)
 - scroll buttons [42](#)
- steering, automatic [75](#)
- summer tires [135](#)
- Summon Distance [81](#)
- supercharging
 - described [127](#)
 - idle fees [127](#)
 - pay-per-use fees [127](#)
- suspension specifications [151](#)

T

- telematics [164](#)
- temperature
 - Battery (high voltage), limits [122](#)
 - cabin, controls for [98](#)
 - outside [52](#)
 - tires [156](#)
- Teslacam [65](#)
- tie-down straps [159](#)
- Tire and Loading Information label [147](#)
- tire noise [135](#)
- Tire Pressure Monitoring System
 - FCC certification [168](#)
 - overview of [134](#)
- tire pressures, checking [130](#)
- tires
 - all-season [135](#)
 - balancing [131](#)
 - chains [135](#)
 - inspecting and maintaining [131](#)
 - pressures, how to check [130](#)
 - quality grading [156](#)
 - replacing [132](#)
 - replacing a tire sensor [134](#)
 - rotation [131](#)
 - specification [153](#)
 - summer [135](#)
 - temperature grades [156](#)
 - tire markings [154](#)
 - traction grade [156](#)
 - treadwear grade [156](#)
 - winter [135](#)
- toll system transponders, attaching [144](#)
- touch up body [138](#)
- touchscreen
 - clean mode [138](#)
 - cleaning [138](#)
 - overview [4](#)
 - restarting [42](#)
 - software updates [119](#)
- tow eye, locating [159](#)
- towing a trailer [148](#)

- towing instructions [158](#)
- TPMS
 - FCC certification [168](#)
 - overview of [134](#)
- Track Mode [62](#)
- Tracking Disabled [103](#)
- traction control [58](#)
- trademarks [163](#)
- Traffic-Aware Cruise Control [69](#)
- trailer hitches [148](#)
- transmission specifications [151](#)
- transponders, attaching [144](#)
- Transport Mode [158](#)
- transporting [158](#)
- trip chart [63](#)
- Trip Planner [106](#)
- trunk, front [17](#)
- trunk, rear [15](#)
- Tuneln radio [108](#)
- turn signals [51](#)

U

- ultrasonic sensors [66](#)
- uniform tire quality grading [156](#)
- Unlock On Park [13](#)
- unlocking [12](#)
- USB devices
 - connecting [20](#)
 - playing audio files from [109](#)
- USB ports [20](#)

V

- Valet mode [40](#)
- vehicle certification label [147](#)
- Vehicle Hold [61](#)
- Vehicle Identification Number (VIN) [146](#)
- vehicle loading [147](#)
- ventilation [100](#)
- VIN (Vehicle Identification Number) [146](#)
- volume control [4](#)
- volume control (media) [108](#)

W

- Walk-Away Door Lock [13](#)
- Wall Connector [121](#)
- warning flashers [51](#)
- washer fluid, topping up [142](#)
- washer jets, cleaning [140](#)
- washers, using [55](#)
- weight specifications [150](#)
- wheel chocks [159](#)
- wheels
 - aero covers, removing and installing [133](#)



- wheels *(continued)*
 - alignment [131](#)
 - lug nut covers, removing and installing [133](#)
 - replacing [132](#)
 - specifications [153](#)
 - torque [153](#)
- Wi-Fi, connecting to [118](#)
- windshield washer fluid, topping up [142](#)
- winter tires [135](#)
- wiper blades, replacing [140](#)
- wipers, using [55](#)
- Work location [106](#)