

# FCC Test Report

## (PART 95 Subpart L)

**Report No.:** RF150410C07

**FCC ID:** 2AEIFUMPZ2-EVK

**Test Model:** UMPZ2-EVK

**Received Date:** Apr. 10, 2015

**Tested Date:** May 22 ~ May 25, 2015

**Issued Date:** Jun. 10, 2015

**Applicant:** ALPS ELECTRIC CO., LTD. Furukawa Plant

**Address:** 6-3-36, Furukawanakazato, Osaki-city Miyagi-pref 989-6181, Japan

**Issued By:** Bureau Veritas Consumer Products Services (H.K.) Ltd., Taoyuan Branch

**Lab Address:** No. 47-2, 14th Ling, Chia Pau Vil., Lin Kou Dist., New Taipei City, Taiwan, R.O.C.

**Test Location:** No. 19, Hwa Ya 2nd Rd., Wen Hwa Vil., Kwei Shan Dist., Taoyuan City 33383, Taiwan, R.O.C.



This report is for your exclusive use. Any copying or replication of this report to or for any other person or entity, or use of our name or trademark, is permitted only with our prior written permission. This report sets forth our findings solely with respect to the test samples identified herein. The results set forth in this report are not indicative or representative of the quality or characteristics of the lot from which a test sample was taken or any similar or identical product unless specifically and expressly noted. Our report includes all of the tests requested by you and the results thereof based upon the information that you provided to us. You have 60 days from date of issuance of this report to notify us of any material error or omission caused by our negligence, provided, however, that such notice shall be in writing and shall specifically address the issue you wish to raise. A failure to raise such issue within the prescribed time shall constitute your unqualified acceptance of the completeness of this report, the tests conducted and the correctness of the report contents. Unless specific mention, the uncertainty of measurement has been explicitly taken into account to declare the compliance or non-compliance to the specification. The report must not be used by the client to claim product certification, approval, or endorsement by TAF or any government agencies

**Table of Contents**

<b>Release Control Record</b> .....	<b>3</b>
<b>1 Certificate of Conformity</b> .....	<b>4</b>
<b>2 Summary of Test Results</b> .....	<b>5</b>
2.1 Measurement Uncertainty.....	5
2.2 Test Instruments.....	6
<b>3 General Information</b> .....	<b>7</b>
3.1 General Description of EUT.....	7
3.2 Description of Test Modes.....	7
3.3 Configuration of System Under Test.....	8
3.3.1 Description Of Support Units.....	9
3.4 Test Mode Applicability and Tested Channel Detail.....	10
3.5 EUT Operating Conditions.....	11
3.6 General Description of Applied Standards.....	11
<b>4 Test Types and Results</b> .....	<b>12</b>
4.1 Output Power Measurement.....	12
4.1.1 Limits of Output Power Measurement.....	12
4.1.2 Test Procedures.....	12
4.1.3 Test Setup.....	13
4.1.4 Test Results.....	14
4.2 Frequency Stability Measurement.....	20
4.2.1 Limits of Frequency Stability Measurement.....	20
4.2.2 Test Procedure.....	20
4.2.3 Test Setup.....	20
4.2.4 Test Results.....	21
4.3 Emission Bandwidth Measurement.....	22
4.3.1 Limits of Emission Bandwidth Measurement.....	22
4.3.2 Test Procedure.....	22
4.3.3 Test Setup.....	22
4.3.4 Test Result.....	23
4.4 Emission Mask Measurement.....	24
4.4.1 Limits of Emission Mask Measurement.....	24
4.4.2 Test Procedures.....	25
4.4.3 Test Setup.....	25
4.4.4 Test Results.....	26
4.5 Peak To Average Ratio.....	32
4.5.1 Limits of Peak To Average Ratio Measurement.....	32
4.5.2 Test Setup.....	32
4.5.3 Test Procedures.....	32
4.5.4 Test Results.....	33
4.6 Conducted Spurious Emissions.....	35
4.6.1 Limits of Conducted Spurious Emissions Measurement.....	35
4.6.2 Test Setup.....	35
4.6.3 Test Procedure.....	35
4.6.4 Test Results.....	36
4.7 Radiated Emission Measurement.....	54
4.7.1 Limits of Radiated Emission Measurement.....	54
4.7.2 Test Procedure.....	54
4.7.3 Deviation from Test Standard.....	54
4.7.4 Test Setup.....	55
4.7.5 Test Results.....	56
<b>5 Pictures of Test Arrangements</b> .....	<b>72</b>
<b>Appendix – Information on the Testing Laboratories</b> .....	<b>73</b>



A D T

### Release Control Record

Issue No.	Description	Date Issued
RF150410C07	Original release.	Jun. 10, 2015

## 1 Certificate of Conformity

**Product:** V2X, GNSS module with host controller

**Brand:** ALPS

**Test Model:** UMPZ2-EVK

**Sample Status:** Engineering sample

**Applicant:** ALPS ELECTRIC CO., LTD. Furukawa Plant

**Tested Date:** May 22 ~ May 25, 2015

**Standards:** FCC Part 95, Subpart L  
FCC Part 2

The above equipment has been tested by **Bureau Veritas Consumer Products Services (H.K.) Ltd., Taoyuan Branch**, and found compliance with the requirement of the above standards. The test record, data evaluation & Equipment Under Test (EUT) configurations represented herein are true and accurate accounts of the measurements of the sample's EMC characteristics under the conditions specified in this report.

**Prepared by :** , **Date:** Jun. 10, 2015  
Pettie Chen / Senior Specialist

**Approved by :** , **Date:** Jun. 10, 2015  
Ken Liu / Senior Manager

## 2 Summary of Test Results

Applied Standard: FCC Part 95 & Part 2			
FCC Clause	Test Item	Result	Remarks
Part 95.639	Maximum Transmitter Power	PASS	Meet the requirement of limit.
Part 95.639	Effective Isotropic Radiated Power (EIRP)	PASS	Meet the requirement of limit.
Part 2.1055	Frequency Stability	PASS	Meet the requirement of limit.
Part 95.633	Emission Bandwidth	PASS	Meet the requirement of limit.
Part 95.635	Emission Mask	PASS	Meet the requirement of limit.
---	Peak To Average Ratio	PASS	Meet the requirement of limit.
Part 2.1051	Conducted Spurious Emissions	PASS	Meet the requirement of limit.
Part 2.1053	Radiated Spurious Emissions	PASS	Meet the requirement of limit. Minimum passing margin is -2.48dB at 11800.00MHz.

### 2.1 Measurement Uncertainty

Where relevant, the following measurement uncertainty levels have been estimated for tests performed on the EUT as specified in CISPR 16-4-2:

Measurement	Frequency	Expanded Uncertainty (k=2) ( $\pm$ )
Radiated Emissions up to 1 GHz	30MHz ~ 200MHz	3.86 dB
	200MHz ~1000MHz	3.87 dB
Radiated Emissions above 1 GHz	1GHz ~ 18GHz	2.29 dB
	18GHz ~ 40GHz	2.29 dB

## 2.2 Test Instruments

Description & Manufacturer	Model No.	Serial No.	Date Of Calibration	Due Date Of Calibration
Test Receiver ROHDE & SCHWARZ	ESIB7	100187	Apr. 10, 2015	Apr. 09, 2016
Spectrum Analyzer ROHDE & SCHWARZ	FSP40	100041	Aug. 29, 2014	Aug. 28, 2015
BILOG Antenna SCHWARZBECK	VULB9168	9168-160	Feb. 05, 2015	Feb. 04, 2016
HORN Antenna SCHWARZBECK	9120D	209	Feb. 09, 2015	Feb. 08, 2016
HORN Antenna SCHWARZBECK	BBHA 9170	BBHA9170241	Feb. 09, 2015	Feb. 08, 2016
Preamplifier Agilent	8447D	2944A10738	Oct.18, 2014	Oct. 17, 2015
Preamplifier Agilent	8449B	3008A01964	Aug. 22, 2014	Aug. 21, 2015
RF signal cable HUBER+SUHNNER	SUCOFLEX 104	214378/4	Aug. 22, 2014	Aug. 21, 2015
RF signal cable HUBER+SUHNNER	SUCOFLEX 106	12738/6 +309224/4	Aug. 22, 2014	Aug. 21, 2015
Software BV ADT	ADT_Radiated_ V7.6.15.9.4	NA	NA	NA
Antenna Tower inn-co GmbH	MA 4000	013303	NA	NA
Antenna Tower Controller BV ADT	AT100	AT93021702	NA	NA
Turn Table BV ADT	TT100	TT93021702	NA	NA
Turn Table Controller BV ADT	SC100	SC93021702	NA	NA
Mini-Circuits Power Splitter	ZN2PD-9G	NA	Jun. 09, 2015	Jun. 08, 2016
JFW 20dB attenuation	50HF-020-SMA	NA	NA	NA
RF Fliter MICRO-TRONICS	BRM50716	060	Dec, 12, 2014	Dec. 11, 2015

- NOTE: 1. The calibration interval of the above test instruments is 12 months and the calibrations are traceable to NML/ROC and NIST/USA.
2. The test was performed in HwaYa Chamber 3.
3. The horn antenna and HP preamplifier (model: 8449B) are used only for the measurement of emission frequency above 1GHz if tested.
4. The FCC Site Registration No. is 988962.
5. The IC Site Registration No. is IC 7450F-3.

### 3 General Information

#### 3.1 General Description of EUT

Product	V2X, GNSS module with host controller
Brand	ALPS
Test Model	UMPZ2-EVK
Status of EUT	Engineering sample
Power Supply Rating	12Vdc from power supply
Modulation Type	BPSK, QPSK, 16QAM, 64QAM for OFDM
RSU Class	RSU Class C
Channel Bandwidth	10MHz
Data Rate	3, 4.5, 6, 9, 12, 18, 24, 27Mbps
Operating Frequency	5860 ~ 5920MHz
Number of Channel	7
Max. EIRP Power	26.24dBm (0.421W)
Antenna Type	External antenna with 2.7dBi gain (Support unit)
Accessory Device	NA
Data Cable Supplied	NA

Note: The above EUT information is declared by manufacturer and for more detailed features description, please refer to the manufacturer's specifications or User's Manual.

#### 3.2 Description of Test Modes

7 channels are for the EUT:

Channel	Frequency (MHz)
172	5860
174	5870
176	5880
178	5890
180	5900
182	5910
184	5920

### 3.3 Configuration of System Under Test

For Test Mode A

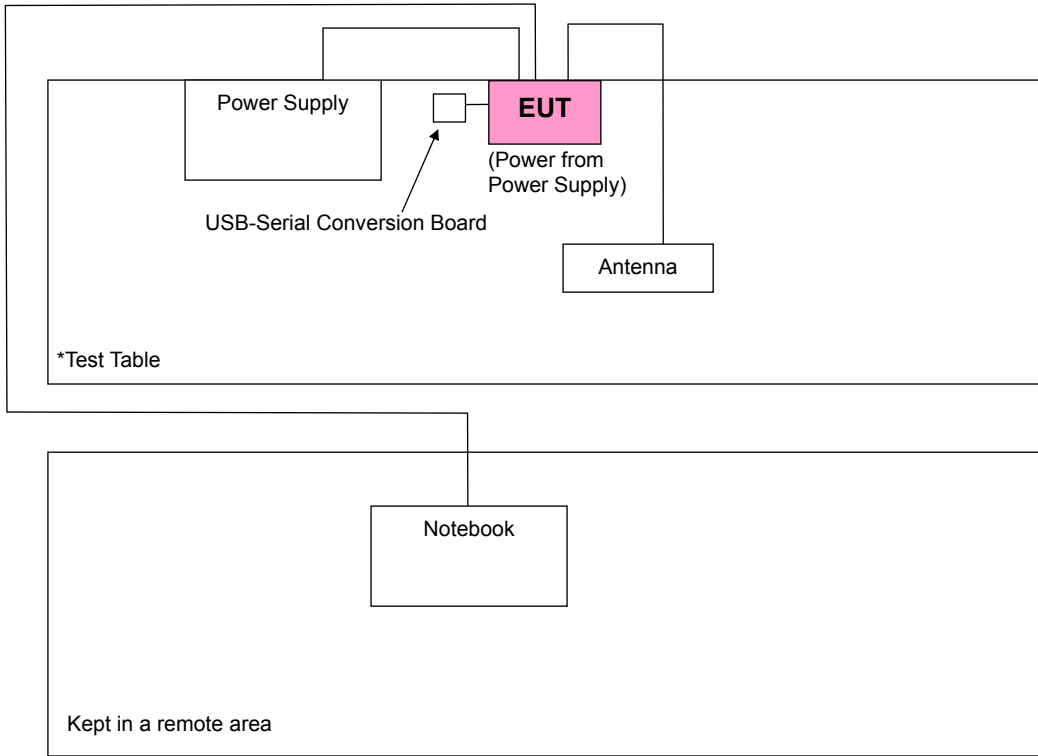



For Test Mode B

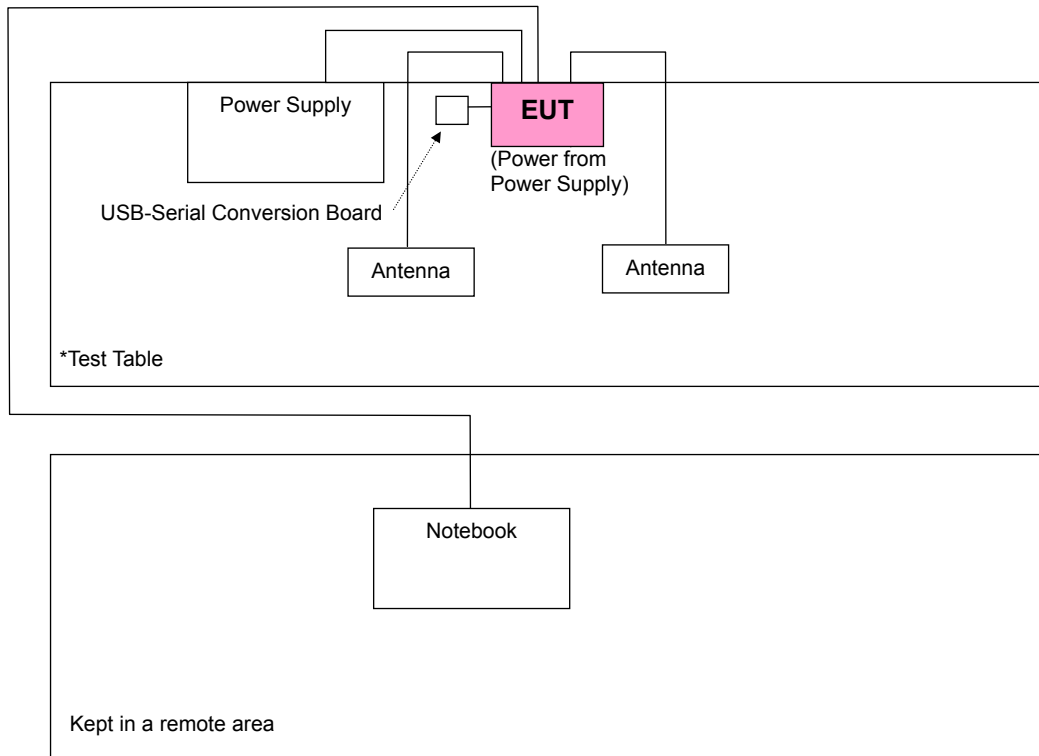

### 3.3.1 Description Of Support Units

The EUT has been tested as an independent unit together with other necessary accessories or support units. The following support units or accessories were used to form a representative test configuration during the tests.

No.	Product	Brand	Model No.	Serial No.	FCC ID
1	Notebook	DELL	E5410	1HC2XM1	NA
2	Power Supply	TOP WARD	6306A	713585	NA
3	GNSS/DSRC Antenna	NA	NA	NA	NA
4	USB-Serial Conversion Board	NA	NA	NA	NA

NO.	Signal Cable Description Of The Above Support Units
1	NA
2	NA
3	3 m non-shielded cable
4	NA

**NOTE:**

1. Item 3, 4 are provided by the client.
2. Item 1 acted as a communication partner to transfer data.

### 3.4 Test Mode Applicability and Tested Channel Detail

Pre-Scan has been conducted to determine the worst-case mode from all possible combinations between available modulations, data rates, XYZ axis and antenna ports.

The worst case was found when positioned on X-plane. Following channel(s) was (were) selected for the final test as listed below:

Test results are presented in the report as below.

Test Mode	TX Function
A	1TX
B	2TX

EUT Configure Mode	Test Item	Available Channel	Tested Channel	Data Rate (Mbps)
A, B	Maximum Transmitter Power	172 to 184	172, 178, 180, 182, 184	3, 27
A, B	Effective Isotropic Radiated Power (EIRP)	172 to 184	172, 178, 180, 182, 184	3, 27
B	Frequency Stability	172 to 184	172	27
A, B	Emission Bandwidth	172 to 184	172, 178, 184	3, 27
A, B	Emission Mask	172 to 184	172, 178, 180, 182, 184	3, 27
A, B	Peak To Average Ratio	172 to 184	172, 178, 180, 182, 184	3, 27
A, B	Conducted Spurious Emissions	172 to 184	172, 178, 184	3, 27
A, B	Radiated Spurious Emissions (Frequency range below 1GHz)	172 to 184	172	3, 27
A, B	Radiated Spurious Emissions (Frequency range above 1GHz)	172 to 184	172, 178, 180, 182, 184	3, 27

#### **Test Condition:**

Test Item	Environmental Conditions	Input Power	Tested By
Maximum Transmitter Power	24deg. C, 64%RH	12Vdc	Match Tsui
Effective Isotropic Radiated Power (EIRP)	24deg. C, 64%RH	12Vdc	Match Tsui
Emission Mask	24deg. C, 64%RH	12Vdc	Match Tsui
Emission Bandwidth	24deg. C, 64%RH	12Vdc	Match Tsui
Conducted Spurious Emissions	24deg. C, 64%RH	12Vdc	Match Tsui
Frequency Stability	24deg. C, 64%RH	12Vdc	Match Tsui
Peak To Average Ratio	24deg. C, 64%RH	12Vdc	Match Tsui
Radiated Emission	18deg. C, 70%RH	12Vdc	Nick Hsu

### 3.5 EUT Operating Conditions

The EUT makes a call to the communication simulator. The communication simulator station system controlled a EUT to export maximum output power under transmission mode and specific channel frequency

### 3.6 General Description of Applied Standards

The EUT is a RF Product. According to the specifications of the manufacturer, it must comply with the requirements of the following standards:

**FCC 47 CFR Part 2**

**FCC 47 CFR Part 95**

**KDB 971168 D01 Power Meas License Digital Systems v02r02**

**ANSI/TIA/EIA-603-D 2010**

**ASTM E2213-03**

**NOTE:** All test items have been performed and recorded as per the above standards.

## 4 Test Types and Results

### 4.1 Output Power Measurement

#### 4.1.1 Limits of Output Power Measurement

For portable DSRCS-OBUs device				
Frequency Range	Maximum Output Power			
5850–5925 MHz	1.0 mW			
For other device				
Frequency Range	Channel	Bandwidth (MHz)	Conducted Power (dBm)	EIRP (dBm)
5855-5865	172	5 /10	28.8	33
5865-5875	174	5 /10	28.8	33
5875-5885	176	5 /10	28.8	33
5885-5895	178	5 /10	28.8	33
5895-5905	180	5 /10	20	23
5905-5915	182	5 /10	20	23
5915-5925	184	5 /10	28.8	33
5855-5865	175	20	10	23
5865-5875	181	20	20	23

#### 4.1.2 Test Procedures

##### EIRP / ERP Measurement:

- a. The EUT was set up for the maximum power with data modulation. The power was measured with Agilent Spectrum Analyzer. All measurements were done at 1 channel.
- b. Substitution method is used for E.I.R.P measurement. In the semi-anechoic chamber, EUT placed on the 0.8m height of Turn Table, rotated the table around 360 degrees to search the maximum radiation power and receiver antenna shall be rotated vertical and horizontal polarization and moved height from 1m to 4m to find the maximum polar radiated power. The “Read Value” is the spectrum reading the maximum power value.
- c. The substitution horn antenna is substituted for EUT at the same position and signals generator export the CW signal to the substitution antenna via a TX cable. Rotated the Turn Table and moved receiving antenna to find the maximum radiation power. Adjust output power level of S.G to get a Value of spectrum reading equal to “Read Value“ of step b. Record the power level of S.G
- d.  $EIRP = \text{Output power level of S.G} - \text{TX cable loss} + \text{Antenna gain of substitution horn}$ . E.R.P power can be calculated form E.I.R.P power by subtracting the gain of dipole,  $E.R.P \text{ power} = E.I.R.P \text{ power} - 2.15\text{dBi}$ .

##### Conducted Power Measurement:

The EUT was set up for the maximum power with data modulation and link up with simulator. Set the EUT to transmit under low, middle and high channel and record the power level shown on simulator.

### 4.1.3 Test Setup

EIRP / ERP MEASUREMENT:

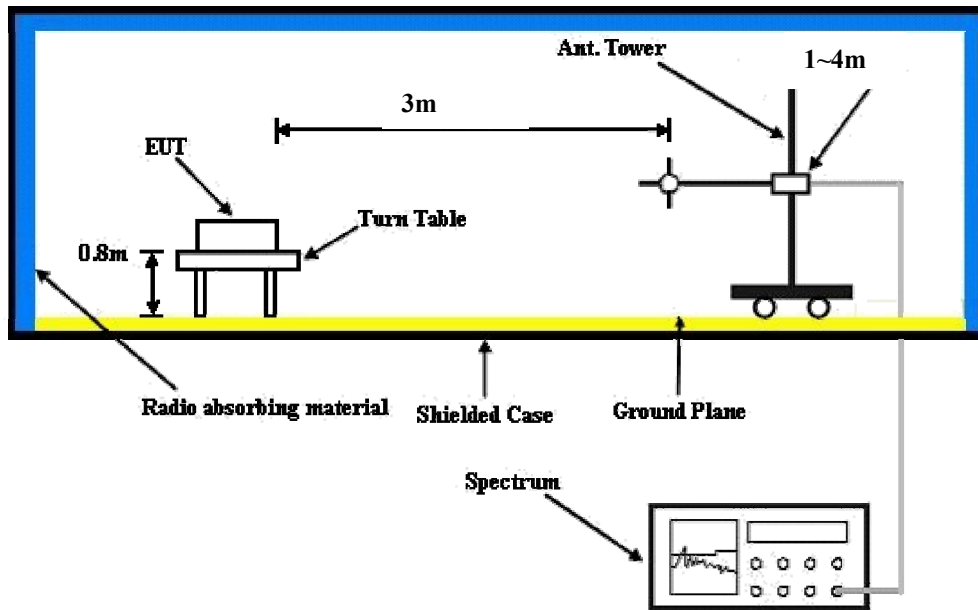

For the actual test configuration, please refer to the attached file (Test Setup Photo).

CONDUCTED POWER MEASUREMENT:

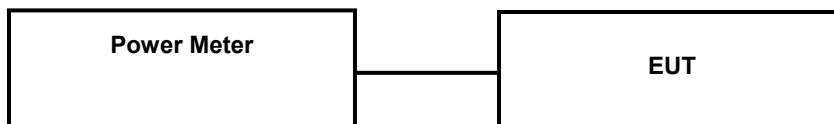

For the actual test configuration, please refer to the attached file (Test Setup Photo).

#### 4.1.4 Test Results

##### Conducted Output Power (dBm)

##### Test Mode A

Data Rate	CH	Frequency (MHz)	Power (dBm)
3Mbps	CH172	5860	19.81
	CH178	5890	19.13
	CH180	5900	16.11
	CH182	5910	15.28
	CH184	5920	19.55
27Mbps	CH172	5860	19.84
	CH178	5890	19.61
	CH180	5900	16.14
	CH182	5910	15.66
	CH184	5920	19.63

##### Test Mode B

Data Rate	CH	Frequency (MHz)	Power (dBm)		Total Power (dBm)
			Chain 0	Chain 1	
3Mbps	CH172	5860	17.37	16.54	19.99
	CH178	5890	16.98	16.14	19.59
	CH180	5900	15.03	14.69	17.87
	CH182	5910	13.95	13.40	16.69
	CH184	5920	16.90	15.87	19.43
27Mbps	CH172	5860	17.44	16.48	20.00
	CH178	5890	17.21	16.33	19.80
	CH180	5900	14.68	14.36	17.53
	CH182	5910	14.05	13.79	16.93
	CH184	5920	17.17	16.15	19.70

EIRP Power (dBm)

Test Mode A: Data rate: 3Mbps

MODE		TX channel 172					
Antenna Polarity & Test Distance: Horizontal at 3 M							
No.	Freq. (MHz)	Reading (dBm)	S.G Power Value (dBm)	Correction Factor (dB)	EIRP (dBm)	Limit (dBm)	Margin (dB)
1	5860.00	-33.14	18.32	0.68	19.00	33.00	-14.00
Antenna Polarity & Test Distance: Vertical at 3 M							
No.	Freq. (MHz)	Reading (dBm)	S.G Power Value (dBm)	Correction Factor (dB)	EIRP (dBm)	Limit (dBm)	Margin (dB)
1	5860.00	-28.04	21.83	0.68	22.51	33.00	-10.49

MODE		TX channel 178					
Antenna Polarity & Test Distance: Horizontal at 3 M							
No.	Freq. (MHz)	Reading (dBm)	S.G Power Value (dBm)	Correction Factor (dB)	EIRP (dBm)	Limit (dBm)	Margin (dB)
1	5890.00	-35.30	16.32	0.68	17.00	33.00	-16.00
Antenna Polarity & Test Distance: Vertical at 3 M							
No.	Freq. (MHz)	Reading (dBm)	S.G Power Value (dBm)	Correction Factor (dB)	EIRP (dBm)	Limit (dBm)	Margin (dB)
1	5890.00	-29.12	20.83	0.68	21.51	33.00	-11.49

MODE		TX channel 180					
Antenna Polarity & Test Distance: Horizontal at 3 M							
No.	Freq. (MHz)	Reading (dBm)	S.G Power Value (dBm)	Correction Factor (dB)	EIRP (dBm)	Limit (dBm)	Margin (dB)
1	5900.00	-36.86	14.82	0.68	15.50	23.00	-7.50
Antenna Polarity & Test Distance: Vertical at 3 M							
No.	Freq. (MHz)	Reading (dBm)	S.G Power Value (dBm)	Correction Factor (dB)	EIRP (dBm)	Limit (dBm)	Margin (dB)
1	5900.00	-28.75	21.23	0.68	21.91	23.00	-1.09

MODE		TX channel 182					
Antenna Polarity & Test Distance: Horizontal at 3 M							
No.	Freq. (MHz)	Reading (dBm)	S.G Power Value (dBm)	Correction Factor (dB)	EIRP (dBm)	Limit (dBm)	Margin (dB)
1	5910.00	-37.26	14.49	0.68	15.17	23.00	-7.83
Antenna Polarity & Test Distance: Vertical at 3 M							
No.	Freq. (MHz)	Reading (dBm)	S.G Power Value (dBm)	Correction Factor (dB)	EIRP (dBm)	Limit (dBm)	Margin (dB)
1	5910.00	-28.67	21.28	0.68	21.96	23.00	-1.04

<b>MODE</b>		<b>TX channel 184</b>					
<b>Antenna Polarity &amp; Test Distance: Horizontal at 3 M</b>							
No.	Freq. (MHz)	Reading (dBm)	S.G Power Value (dBm)	Correction Factor (dB)	EIRP (dBm)	Limit (dBm)	Margin (dB)
1	5920.00	-34.48	17.35	0.68	18.03	33.00	-14.97
<b>Antenna Polarity &amp; Test Distance: Vertical at 3 M</b>							
No.	Freq. (MHz)	Reading (dBm)	S.G Power Value (dBm)	Correction Factor (dB)	EIRP (dBm)	Limit (dBm)	Margin (dB)
1	5920.00	-26.91	23.01	0.68	23.69	33.00	-9.31

NOTE: EIRP (dBm) = S.G Power Value (dBm) + Correction Factor (dB).



Test Mode A: Data rate: 27Mbps

MODE		TX channel 172					
Antenna Polarity & Test Distance: Horizontal at 3 M							
No.	Freq. (MHz)	Reading (dBm)	S.G Power Value (dBm)	Correction Factor (dB)	EIRP (dBm)	Limit (dBm)	Margin (dB)
1	5860.00	-34.52	16.94	0.68	17.62	33.00	-15.38
Antenna Polarity & Test Distance: Vertical at 3 M							
No.	Freq. (MHz)	Reading (dBm)	S.G Power Value (dBm)	Correction Factor (dB)	EIRP (dBm)	Limit (dBm)	Margin (dB)
1	5860.00	-29.58	20.29	0.68	20.97	33.00	-12.03

MODE		TX channel 178					
Antenna Polarity & Test Distance: Horizontal at 3 M							
No.	Freq. (MHz)	Reading (dBm)	S.G Power Value (dBm)	Correction Factor (dB)	EIRP (dBm)	Limit (dBm)	Margin (dB)
1	5890.00	-34.64	16.98	0.68	17.66	33.00	-15.34
Antenna Polarity & Test Distance: Vertical at 3 M							
No.	Freq. (MHz)	Reading (dBm)	S.G Power Value (dBm)	Correction Factor (dB)	EIRP (dBm)	Limit (dBm)	Margin (dB)
1	5890.00	-28.38	21.57	0.68	22.25	33.00	-10.75

MODE		TX channel 180					
Antenna Polarity & Test Distance: Horizontal at 3 M							
No.	Freq. (MHz)	Reading (dBm)	S.G Power Value (dBm)	Correction Factor (dB)	EIRP (dBm)	Limit (dBm)	Margin (dB)
1	5900.00	-37.55	14.13	0.68	14.81	23.00	-8.19
Antenna Polarity & Test Distance: Vertical at 3 M							
No.	Freq. (MHz)	Reading (dBm)	S.G Power Value (dBm)	Correction Factor (dB)	EIRP (dBm)	Limit (dBm)	Margin (dB)
1	5900.00	-29.13	20.85	0.68	21.53	23.00	-1.47

MODE		TX channel 182					
Antenna Polarity & Test Distance: Horizontal at 3 M							
No.	Freq. (MHz)	Reading (dBm)	S.G Power Value (dBm)	Correction Factor (dB)	EIRP (dBm)	Limit (dBm)	Margin (dB)
1	5910.00	-37.19	14.56	0.68	15.24	23.00	-7.76
Antenna Polarity & Test Distance: Vertical at 3 M							
No.	Freq. (MHz)	Reading (dBm)	S.G Power Value (dBm)	Correction Factor (dB)	EIRP (dBm)	Limit (dBm)	Margin (dB)
1	5910.00	-28.86	21.09	0.68	21.77	23.00	-1.23

MODE		TX channel 184					
Antenna Polarity & Test Distance: Horizontal at 3 M							
No.	Freq. (MHz)	Reading (dBm)	S.G Power Value (dBm)	Correction Factor (dB)	EIRP (dBm)	Limit (dBm)	Margin (dB)
1	5920.00	-34.55	17.28	0.68	17.96	33.00	-15.04
Antenna Polarity & Test Distance: Vertical at 3 M							
No.	Freq. (MHz)	Reading (dBm)	S.G Power Value (dBm)	Correction Factor (dB)	EIRP (dBm)	Limit (dBm)	Margin (dB)
1	5920.00	-28.36	21.56	0.68	22.24	33.00	-10.76

NOTE: EIRP (dBm) = S.G Power Value (dBm) + Correction Factor (dB).

Test Mode B: Data rate: 3Mbps

MODE		TX channel 172					
Antenna Polarity & Test Distance: Horizontal at 3 M							
No.	Freq. (MHz)	Reading (dBm)	S.G Power Value (dBm)	Correction Factor (dB)	EIRP (dBm)	Limit (dBm)	Margin (dB)
1	5860.00	-32.84	18.62	0.68	19.30	33.00	-13.70
Antenna Polarity & Test Distance: Vertical at 3 M							
No.	Freq. (MHz)	Reading (dBm)	S.G Power Value (dBm)	Correction Factor (dB)	EIRP (dBm)	Limit (dBm)	Margin (dB)
1	5860.00	-27.23	22.64	0.68	23.32	33.00	-9.68

MODE		TX channel 178					
Antenna Polarity & Test Distance: Horizontal at 3 M							
No.	Freq. (MHz)	Reading (dBm)	S.G Power Value (dBm)	Correction Factor (dB)	EIRP (dBm)	Limit (dBm)	Margin (dB)
1	5890.00	-33.56	18.06	0.68	18.74	33.00	-14.26
Antenna Polarity & Test Distance: Vertical at 3 M							
No.	Freq. (MHz)	Reading (dBm)	S.G Power Value (dBm)	Correction Factor (dB)	EIRP (dBm)	Limit (dBm)	Margin (dB)
1	5890.00	-26.99	22.96	0.68	23.64	33.00	-9.36

MODE		TX channel 180					
Antenna Polarity & Test Distance: Horizontal at 3 M							
No.	Freq. (MHz)	Reading (dBm)	S.G Power Value (dBm)	Correction Factor (dB)	EIRP (dBm)	Limit (dBm)	Margin (dB)
1	5900.00	-37.57	14.11	0.68	14.79	23.00	-8.21
Antenna Polarity & Test Distance: Vertical at 3 M							
No.	Freq. (MHz)	Reading (dBm)	S.G Power Value (dBm)	Correction Factor (dB)	EIRP (dBm)	Limit (dBm)	Margin (dB)
1	5900.00	-28.94	21.04	0.68	21.72	23.00	-1.28

MODE		TX channel 182					
Antenna Polarity & Test Distance: Horizontal at 3 M							
No.	Freq. (MHz)	Reading (dBm)	S.G Power Value (dBm)	Correction Factor (dB)	EIRP (dBm)	Limit (dBm)	Margin (dB)
1	5910.00	-37.58	14.17	0.68	14.85	23.00	-8.15
Antenna Polarity & Test Distance: Vertical at 3 M							
No.	Freq. (MHz)	Reading (dBm)	S.G Power Value (dBm)	Correction Factor (dB)	EIRP (dBm)	Limit (dBm)	Margin (dB)
1	5910.00	-29.13	20.82	0.68	21.50	23.00	-1.50

MODE		TX channel 184					
Antenna Polarity & Test Distance: Horizontal at 3 M							
No.	Freq. (MHz)	Reading (dBm)	S.G Power Value (dBm)	Correction Factor (dB)	EIRP (dBm)	Limit (dBm)	Margin (dB)
1	5920.00	-33.40	18.43	0.68	19.11	33.00	-13.89
Antenna Polarity & Test Distance: Vertical at 3 M							
No.	Freq. (MHz)	Reading (dBm)	S.G Power Value (dBm)	Correction Factor (dB)	EIRP (dBm)	Limit (dBm)	Margin (dB)
1	5920.00	-24.36	25.56	0.68	26.24	33.00	-6.76

NOTE: EIRP (dBm) = S.G Power Value (dBm) + Correction Factor (dB).

Test Mode B: Data rate: 27Mbps

MODE		TX channel 172					
Antenna Polarity & Test Distance: Horizontal at 3 M							
No.	Freq. (MHz)	Reading (dBm)	S.G Power Value (dBm)	Correction Factor (dB)	EIRP (dBm)	Limit (dBm)	Margin (dB)
1	5860.00	-32.83	18.63	0.68	19.31	33.00	-13.69
Antenna Polarity & Test Distance: Vertical at 3 M							
No.	Freq. (MHz)	Reading (dBm)	S.G Power Value (dBm)	Correction Factor (dB)	EIRP (dBm)	Limit (dBm)	Margin (dB)
1	5860.00	-27.17	22.70	0.68	23.38	33.00	-9.62

MODE		TX channel 178					
Antenna Polarity & Test Distance: Horizontal at 3 M							
No.	Freq. (MHz)	Reading (dBm)	S.G Power Value (dBm)	Correction Factor (dB)	EIRP (dBm)	Limit (dBm)	Margin (dB)
1	5890.00	-34.97	16.65	0.68	17.33	33.00	-15.67
Antenna Polarity & Test Distance: Vertical at 3 M							
No.	Freq. (MHz)	Reading (dBm)	S.G Power Value (dBm)	Correction Factor (dB)	EIRP (dBm)	Limit (dBm)	Margin (dB)
1	5890.00	-27.18	22.77	0.68	23.45	33.00	-9.55

MODE		TX channel 180					
Antenna Polarity & Test Distance: Horizontal at 3 M							
No.	Freq. (MHz)	Reading (dBm)	S.G Power Value (dBm)	Correction Factor (dB)	EIRP (dBm)	Limit (dBm)	Margin (dB)
1	5900.00	-37.23	14.45	0.68	15.13	23.00	-7.87
Antenna Polarity & Test Distance: Vertical at 3 M							
No.	Freq. (MHz)	Reading (dBm)	S.G Power Value (dBm)	Correction Factor (dB)	EIRP (dBm)	Limit (dBm)	Margin (dB)
1	5900.00	-28.55	21.43	0.68	22.11	23.00	-0.89

MODE		TX channel 182					
Antenna Polarity & Test Distance: Horizontal at 3 M							
No.	Freq. (MHz)	Reading (dBm)	S.G Power Value (dBm)	Correction Factor (dB)	EIRP (dBm)	Limit (dBm)	Margin (dB)
1	5910.00	-37.73	14.02	0.68	14.70	23.00	-8.3
Antenna Polarity & Test Distance: Vertical at 3 M							
No.	Freq. (MHz)	Reading (dBm)	S.G Power Value (dBm)	Correction Factor (dB)	EIRP (dBm)	Limit (dBm)	Margin (dB)
1	5910.00	-29.12	20.83	0.68	21.51	23.00	-1.49

MODE		TX channel 184					
Antenna Polarity & Test Distance: Horizontal at 3 M							
No.	Freq. (MHz)	Reading (dBm)	S.G Power Value (dBm)	Correction Factor (dB)	EIRP (dBm)	Limit (dBm)	Margin (dB)
1	5920.00	-33.29	18.54	0.68	19.22	33.00	-13.78
Antenna Polarity & Test Distance: Vertical at 3 M							
No.	Freq. (MHz)	Reading (dBm)	S.G Power Value (dBm)	Correction Factor (dB)	EIRP (dBm)	Limit (dBm)	Margin (dB)
1	5920.00	-24.88	25.04	0.68	25.72	33.00	-7.28

NOTE: EIRP (dBm) = S.G Power Value (dBm) + Correction Factor (dB).

## 4.2 Frequency Stability Measurement

### 4.2.1 Limits of Frequency Stability Measurement

The transmitter center frequency stability shall be  $\pm 10$  ppm maximum for DSRC 5.9GHz band.

### 4.2.2 Test Procedure

- a. Device is placed at the oven room. The oven room could control the temperatures and humidity. Power warm up is at least 15 min and power applied should perform before recording frequency error.
- b. EUT is connected the external power supply to control the DC input power. The test voltage range is from minimum to maximum working voltage. Each step shall be record the frequency error rate.
- c. The temperature range step is 10 degrees in this test items. All temperature levels shall be hold the  $\pm 0.5$  °C during the measurement testing. The each temperature step shall be at least 0.5 hours, consider the EUT could be test under the stability condition.

**NOTE:** The frequency error was recorded frequency error from the communication simulator.

### 4.2.3 Test Setup

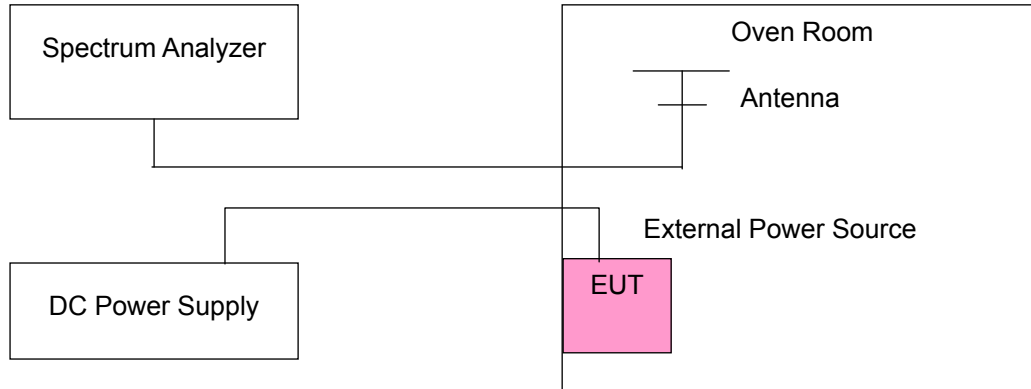

#### 4.2.4 Test Results

##### Frequency Error vs. Voltage

Voltage (Volts)	Frequency Error (ppm)	Limit (ppm)
13.8	1.16207	10
12	0.69452	10
10.2	0.87646	10

**NOTE:** The applicant defined the normal working voltage of the battery is from 10.2Vdc to 13.8Vdc.

##### Frequency Error vs. Temperature.

TEMP. (°C)	Frequency Error (ppm)	Limit (ppm)
85	1.25671	10
80	1.27563	10
70	1.26582	10
60	1.12423	10
50	0.86874	10
40	0.79542	10
30	0.71423	10
20	0.69452	10
10	0.62456	10
0	0.74652	10
-10	0.87961	10
-20	1.10566	10
-30	1.34571	10
-40	1.86541	10

### 4.3 Emission Bandwidth Measurement

#### 4.3.1 Limits of Emission Bandwidth Measurement

The width of a frequency band such that, below the lower and above the upper frequency limits, the signal power at the 99% channel power of occupied bandwidth when resolution bandwidth should be approximately 1 % to 5 % of the occupied bandwidth (OBW)

#### 4.3.2 Test Procedure

The EUT makes a call to the communication simulator. All measurements were done at low, middle and high operational frequency range. The communication simulator station system controlled a EUT to export maximum output power under transmission mode and specific channel frequency. Use OBW measurement function of Spectrum analyzer to measure 99 % occupied bandwidth.

#### 4.3.3 Test Setup

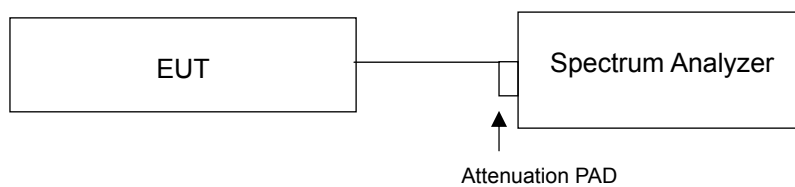

### 4.3.4 Test Result

#### Test Mode A

Channel	Frequency (MHz)	99% Occupied Bandwidth (MHz)	
		Data Rate: 3Mbps	Data Rate: 27Mbps
172	5860	8.03	8.09
178	5890	8.00	8.06
184	5920	8.03	8.03

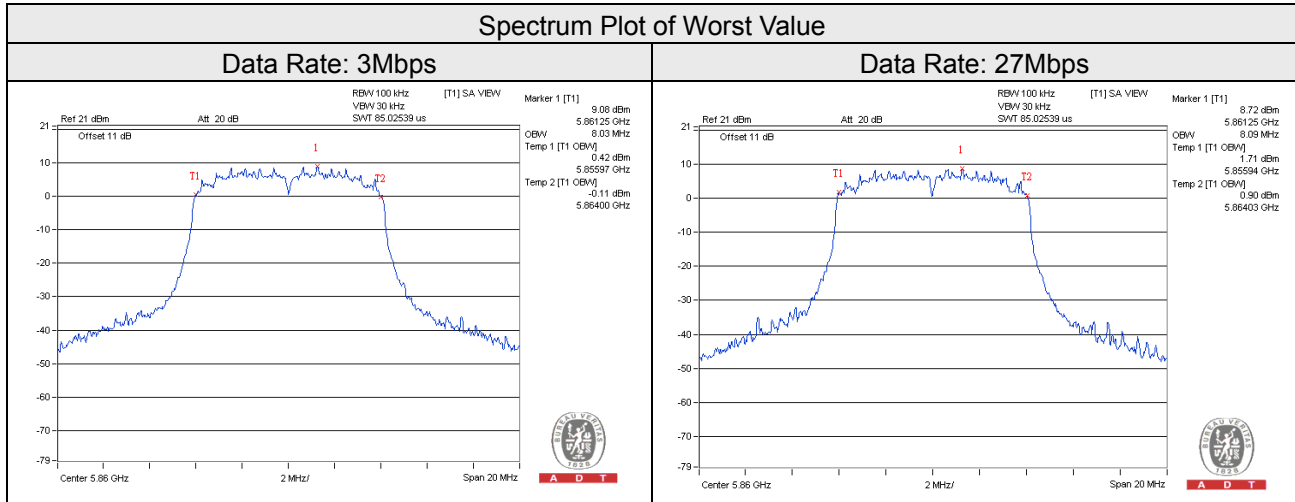

#### Test Mode B

Channel	Frequency (MHz)	99% Occupied Bandwidth (MHz)			
		Data Rate: 3Mbps		Data Rate: 27Mbps	
		Chain 0	Chain 1	Chain 0	Chain 1
172	5860	8.06	8.06	8.06	8.06
178	5890	8.03	8.06	8.06	8.06
184	5920	8.03	8.03	8.06	8.06

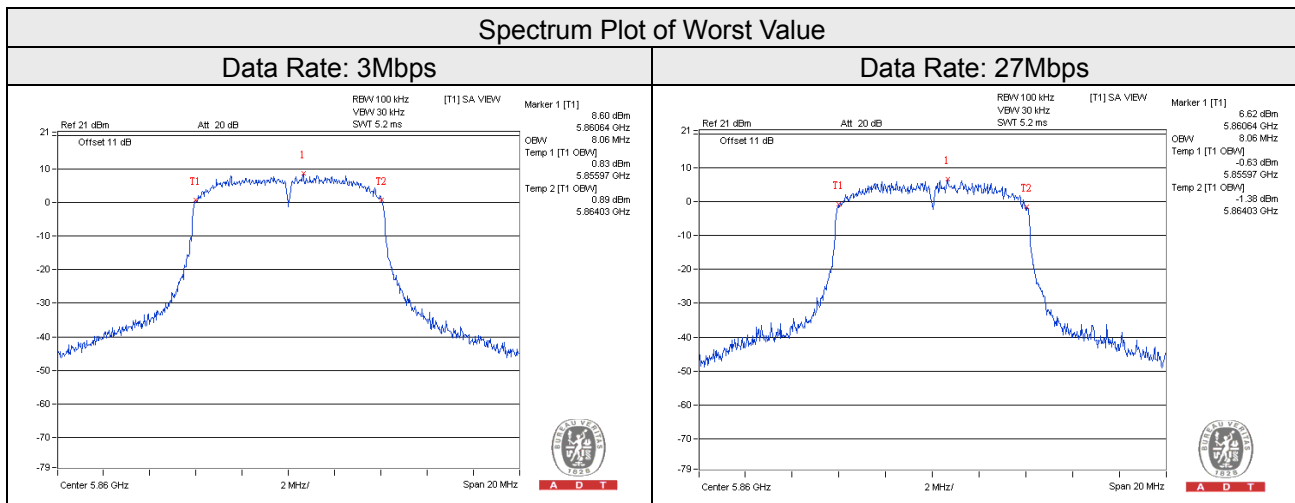

## 4.4 Emission Mask Measurement

### 4.4.1 Limits of Emission Mask Measurement

For portable DSRCS-OBUs device (5850–5925 MHz)					
Maximum Output Power			1.0 mW		
For other device (5850–5925 MHz)					
STA transmit power classification	Maximum STA transmit power (mW)		Maximum permitted EIRP (dBm)		
Class A	1		23		
Class B	10		23		
Class C	100		33		
Class D	760		33 for non-government / 44.8 for government		
STA transmit power classification	$\pm 4.5$ MHz offset ( $\pm f1$ )	$\pm 5.0$ MHz offset ( $\pm f2$ )	$\pm 5.5$ MHz offset ( $\pm f3$ )	$\pm 10$ MHz offset ( $\pm f4$ )	$\pm 15$ MHz offset ( $\pm f5$ )
Class A	0	-10	-20	-28	-40
Class B	0	-16	-20	-28	-40
Class C	0	-26	-32	-40	-50
Class D	0	-35	-45	-55	-65

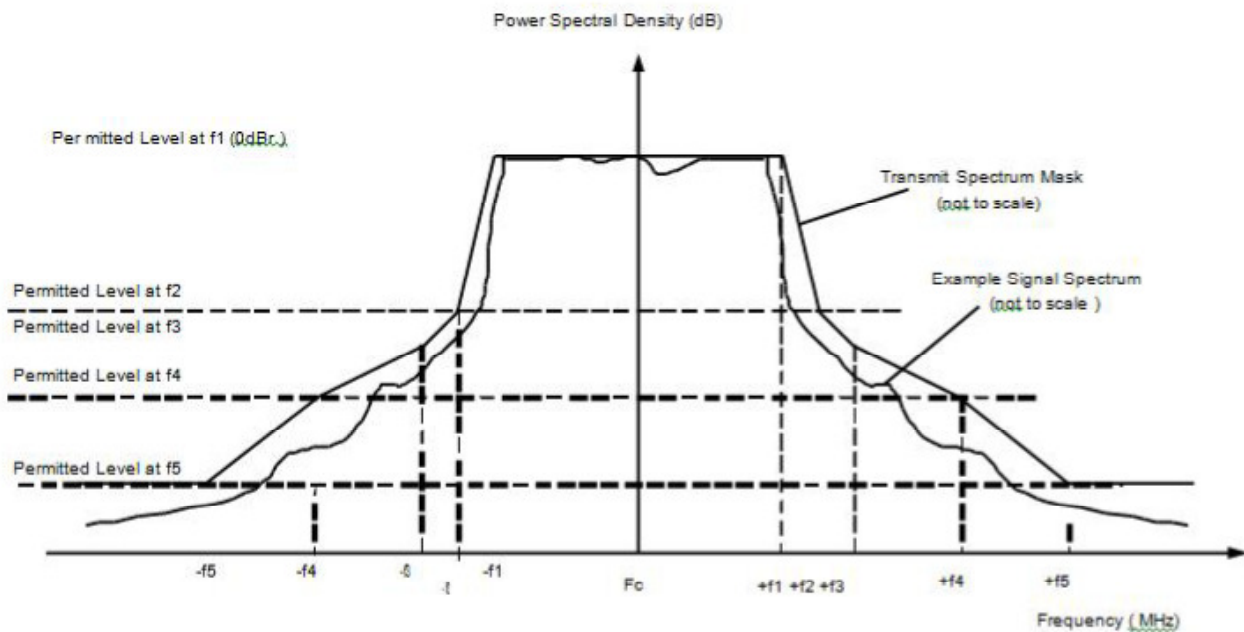



#### 4.4.2 Test Procedures

1. The power was measured with Agilent Spectrum Analyzer. All measurements were done at 1 channel.
2. The measurement used the power splitter via EUT RF power connector between signal generator and spectrum analyzer.
3. Record the test plot.

#### 4.4.3 Test Setup

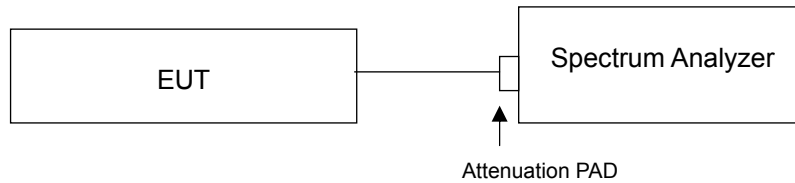

#### 4.4.4 Test Results

Test Mode A:

Data rate: 3Mbps

### CH172 5860MHz

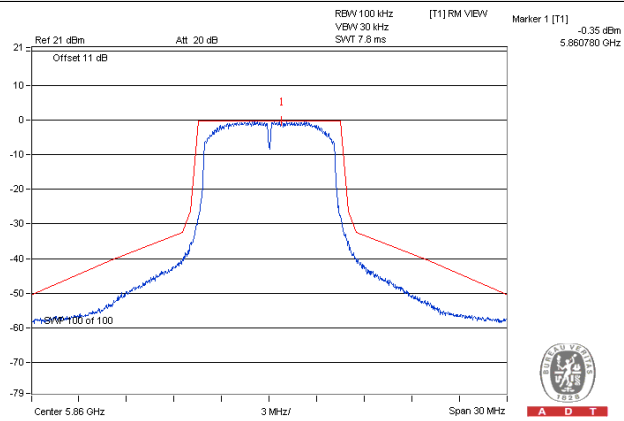

### CH178 5890MHz

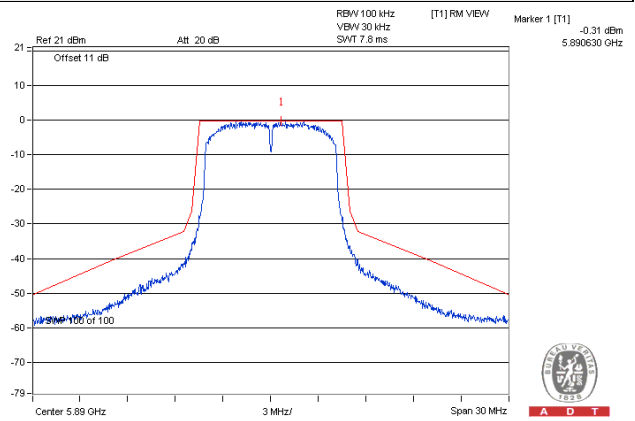

### CH180 5900MHz

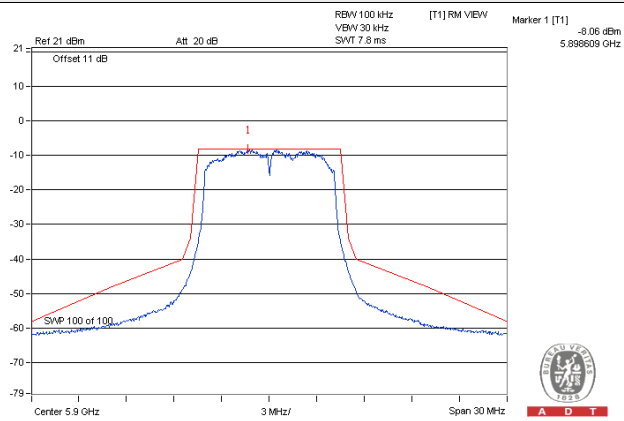

### CH182 5910MHz

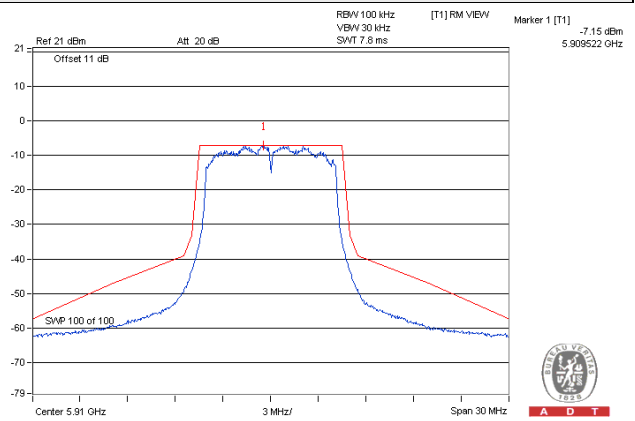

### CH184 5920MHz

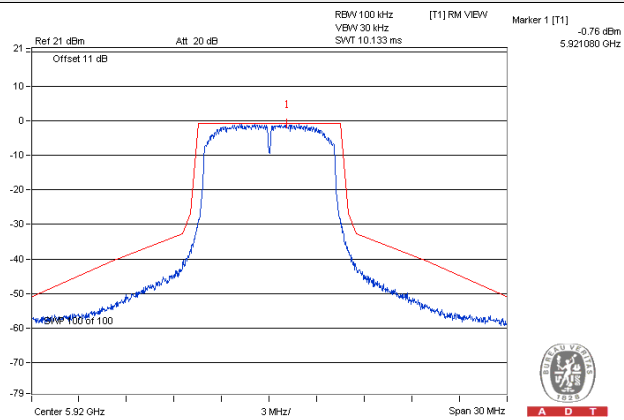

Data rate: 27Mbps

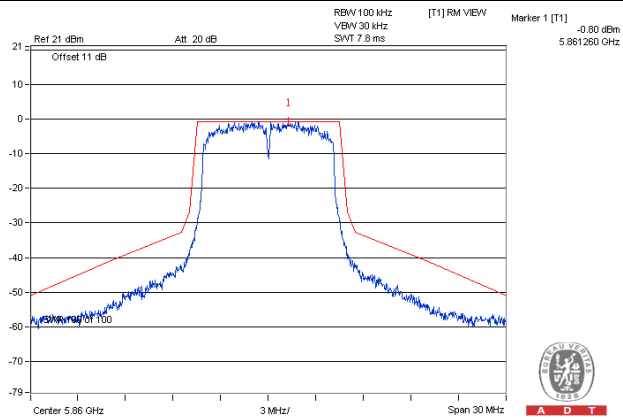
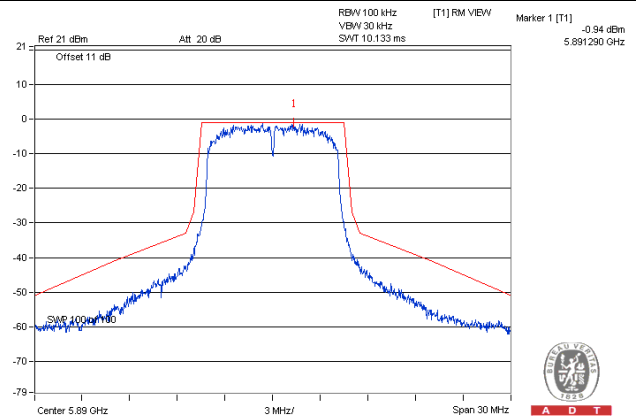
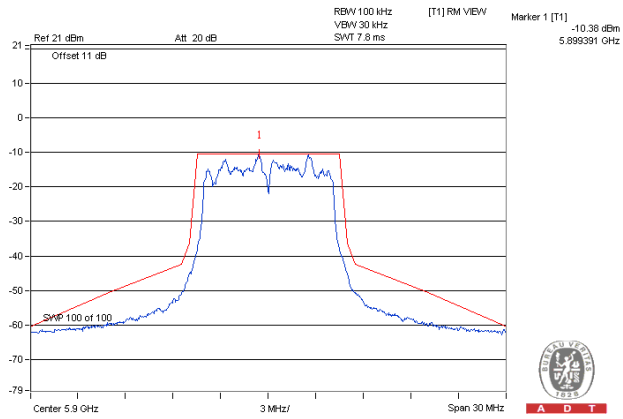
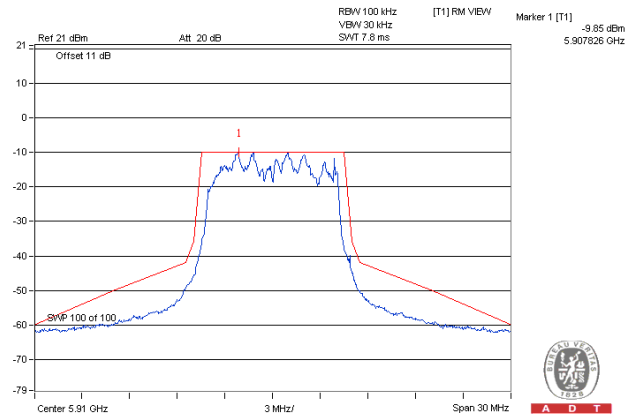
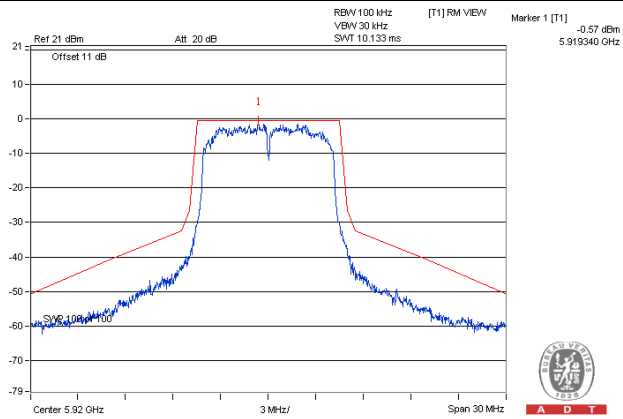
**CH172 5860MHz****CH178 5890MHz****CH180 5900MHz****CH182 5910MHz****CH184 5920MHz**

Test Mode B:

Data rate: 3Mbps, Chain 0

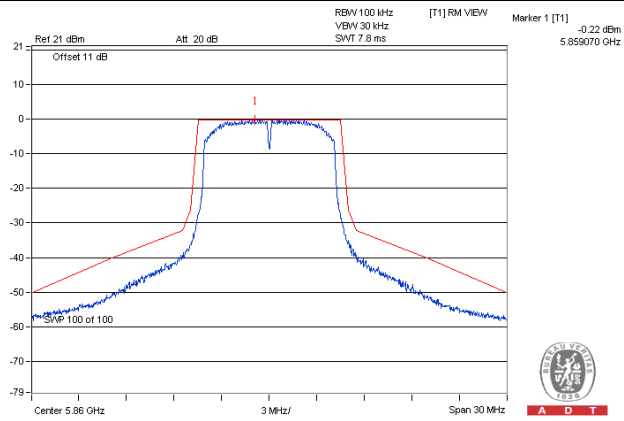
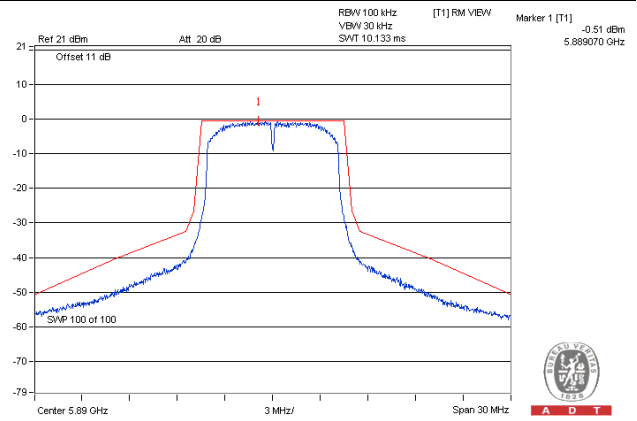
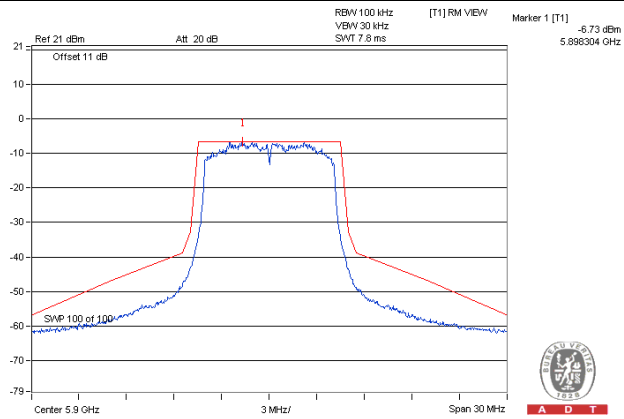
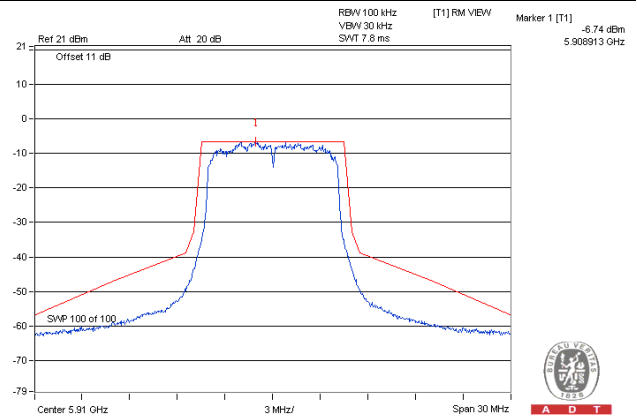
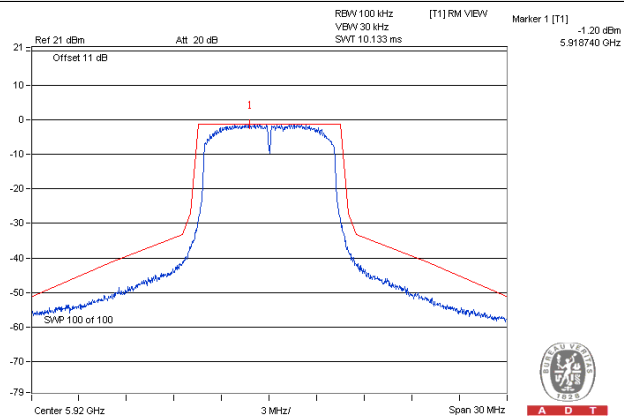
**CH172 5860MHz****CH178 5890MHz****CH180 5900MHz****CH182 5910MHz****CH184 5920MHz**

Test Mode B:

Data rate: 3Mbps, Chain 1

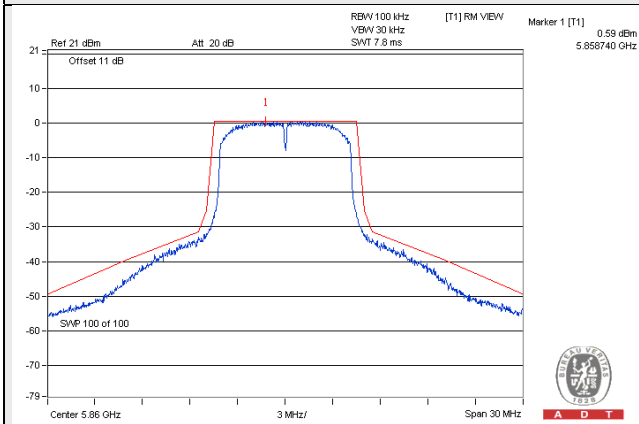
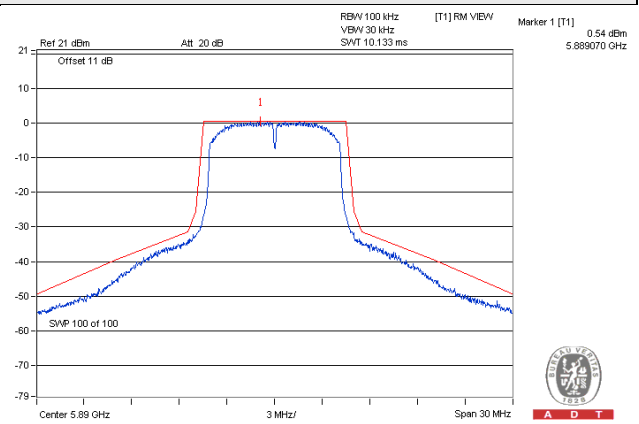
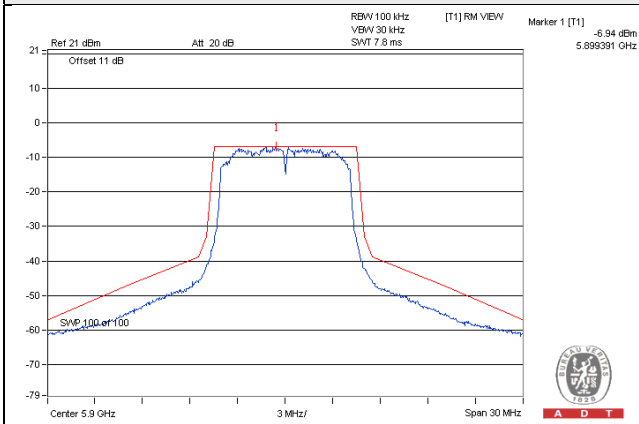
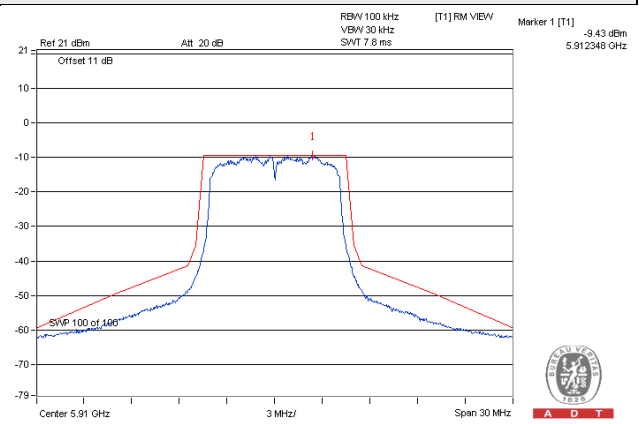
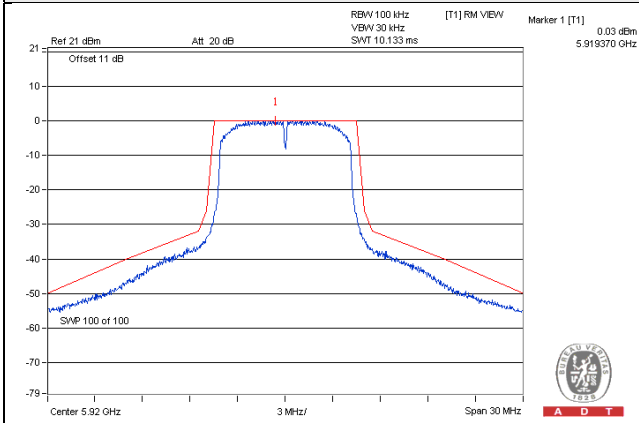
**CH172 5860MHz****CH178 5890MHz****CH180 5900MHz****CH182 5910MHz****CH184 5920MHz**

Data rate: 27Mbps, Chain 0

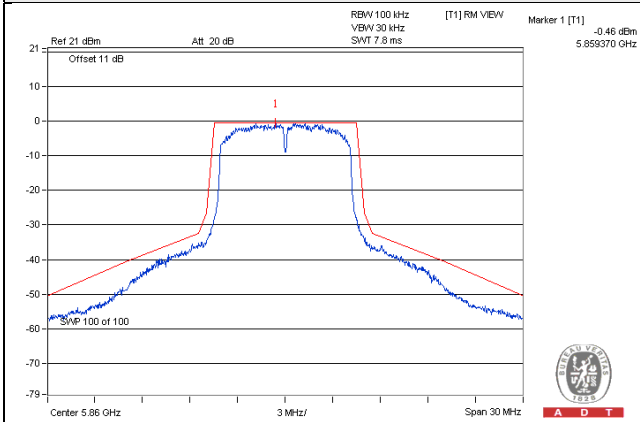
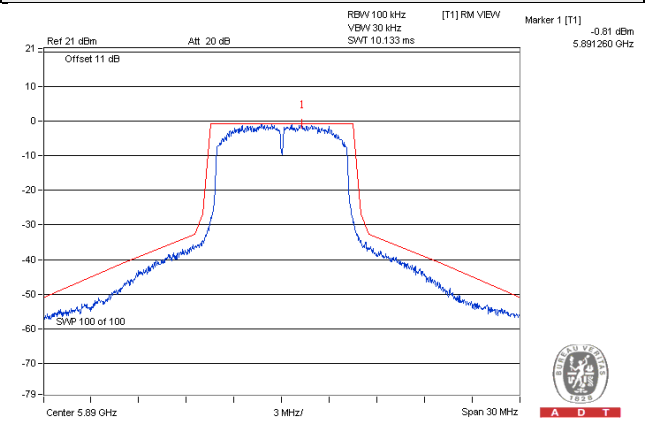
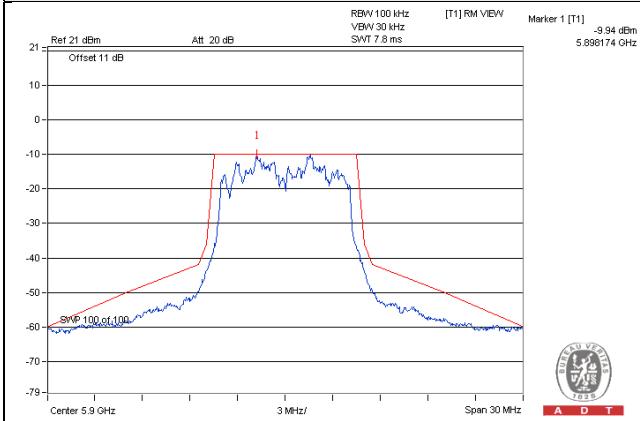
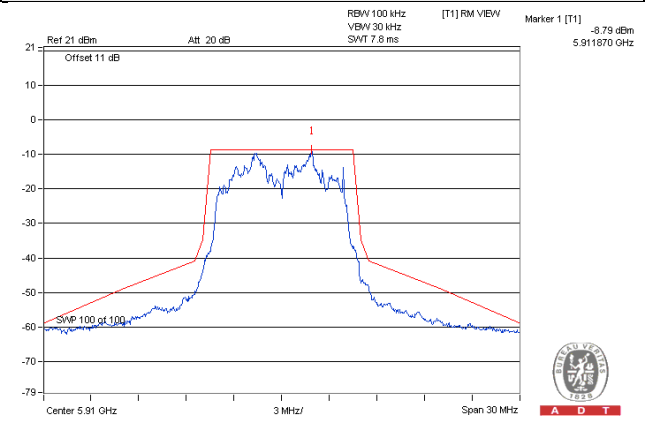
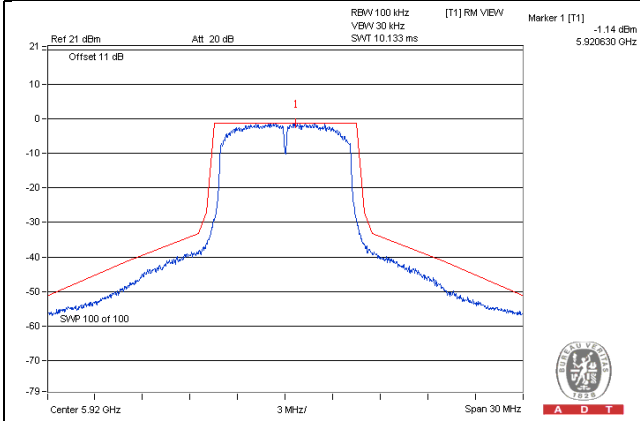
**CH172 5860MHz****CH178 5890MHz****CH180 5900MHz****CH182 5910MHz****CH184 5920MHz**

Data rate: 27Mbps, Chain 1

CH172 5860MHz

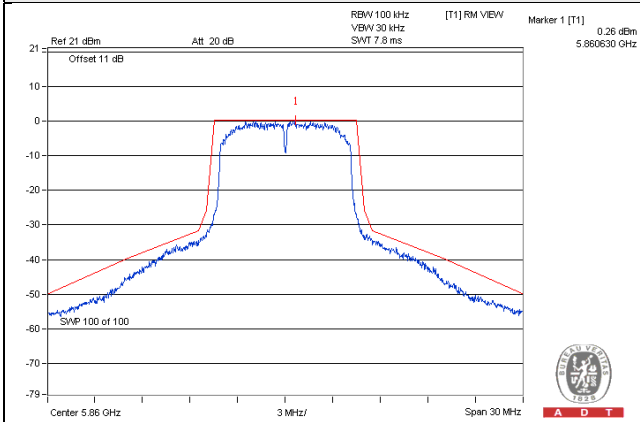

CH178 5890MHz

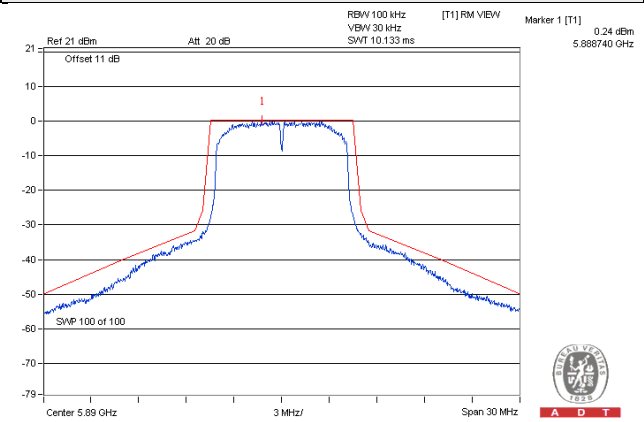

CH180 5900MHz

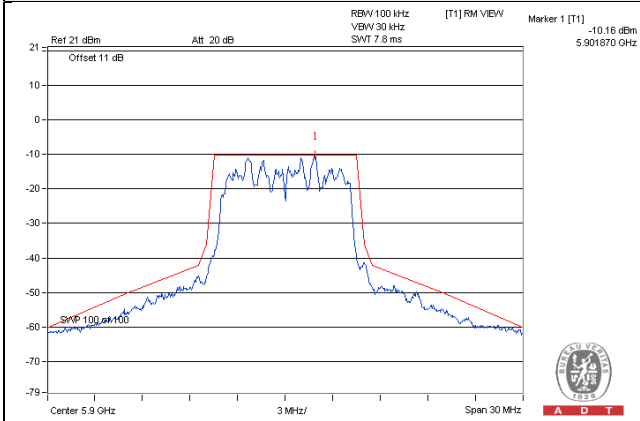

CH182 5910MHz

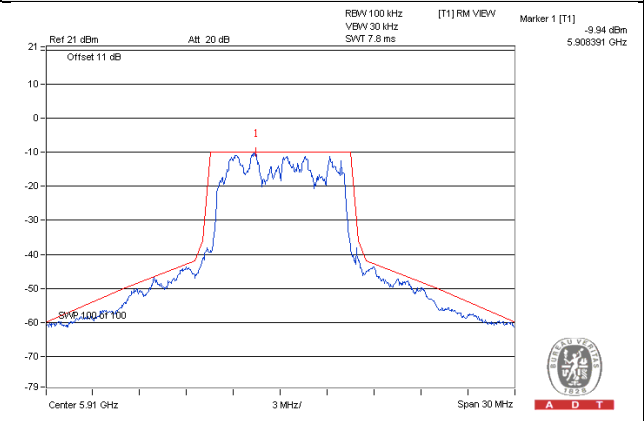

CH184 5920MHz

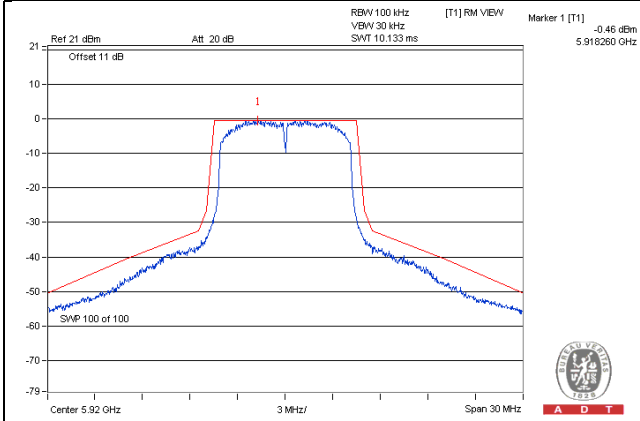

## 4.5 Peak To Average Ratio

### 4.5.1 Limits of Peak To Average Ratio Measurement

In measuring transmissions in this band using an average power technique, the peak to-average ratio (PAR) of the transmission may not exceed 13 dB

### 4.5.2 Test Setup

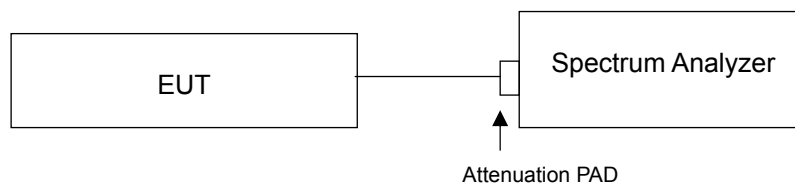

### 4.5.3 Test Procedures

1. Set resolution/measurement bandwidth  $\geq$  signal's occupied bandwidth;
2. Set the number of counts to a value that stabilizes the measured CCDF curve;
3. Record the maximum PAPR level associated with a probability of 0.1%.





### 4.5.4 Test Results

#### Test Mode A

Channel	Frequency (MHz)	Peak To Average Ratio (dB)	
		Data Rate: 3Mbps	Data Rate: 27Mbps
172	5860	7.05	7.65
178	5890	6.67	7.67
180	5900	7.98	7.98
182	5910	8.03	8.11
184	5920	7.14	7.62

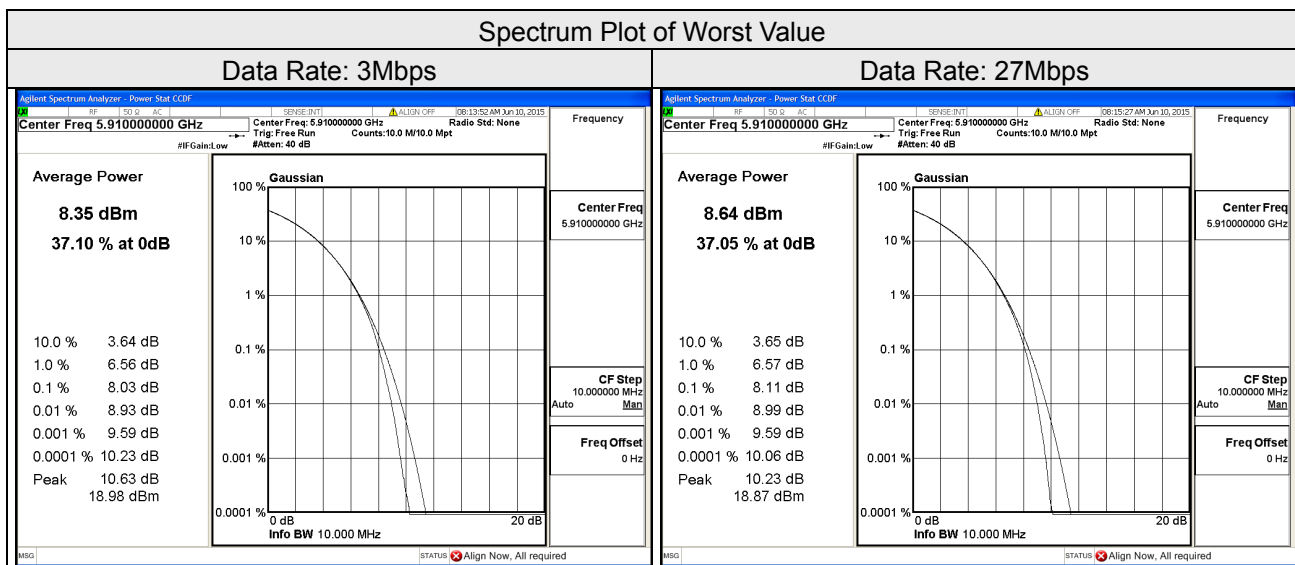

Test Mode B

Channel	Frequency (MHz)	Peak To Average Ratio (dB)			
		Data Rate: 3Mbps		Data Rate: 27Mbps	
		Chain 0	Chain 1	Chain 0	Chain 1
172	5860	8.00	7.99	7.91	7.89
178	5890	8.00	8.11	7.95	7.94
180	5900	8.02	7.94	7.96	7.96
182	5910	8.03	8.07	8.04	8.05
184	5920	7.93	8.03	8.00	7.99

Spectrum Plot of Worst Value

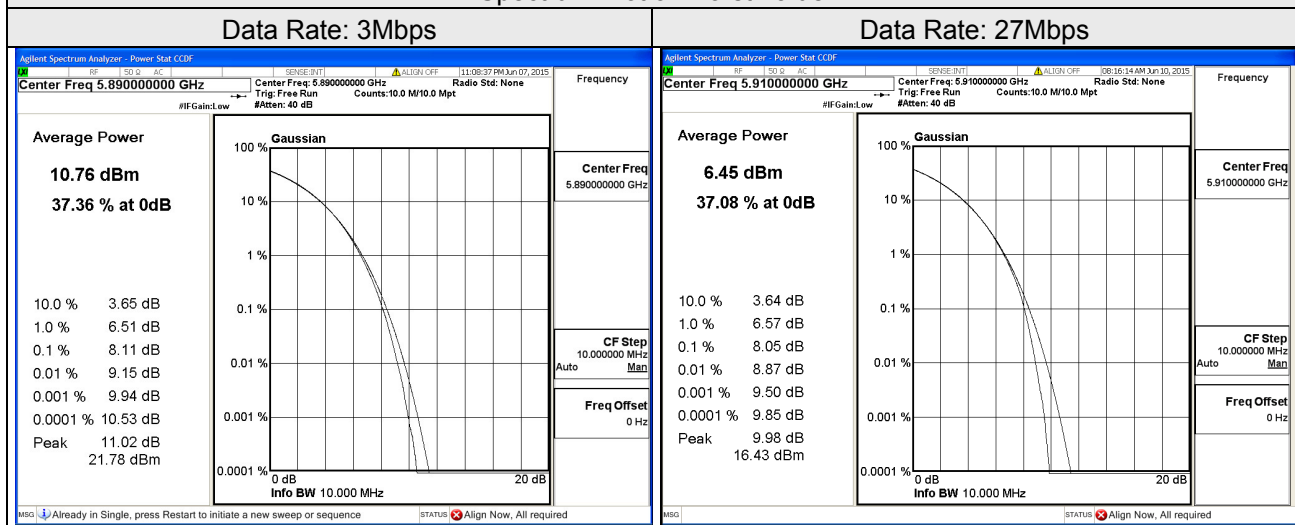

## 4.6 Conducted Spurious Emissions

### 4.6.1 Limits of Conducted Spurious Emissions Measurement

The power of any emission outside a licensee's frequency band(s) of operation shall be attenuated below the transmitter power (P) within the licensed band(s) of operation, measured in watts, by at least  $[55 + 10 \log(P)]$  (-25dBm).

### 4.6.2 Test Setup

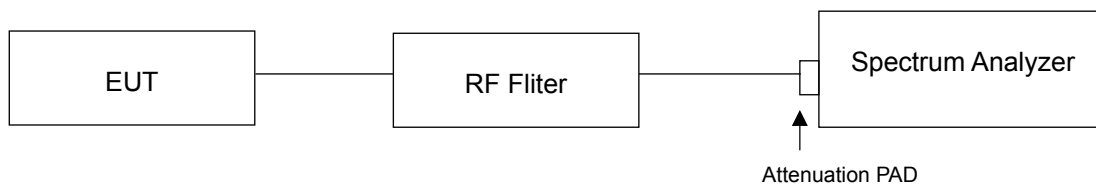

### 4.6.3 Test Procedure

- The EUT was set up for the maximum peak power with worst data modulation. The power was measured with Spectrum Analyzer.
- The conducted spurious emission used the RF cable via EUT RF power connector between spectrum analyzer.
- When the spectrum scanned from 9kHz to 40GHz, it shall be connected to the band reject filter attenuated the carried frequency.

4.6.4 Test Results  
Test Mode A

Data Rate: 3Mbps

Channel 172

Frequency Range : 9kHz~150kHz

Frequency Range : 150kHz~30MHz

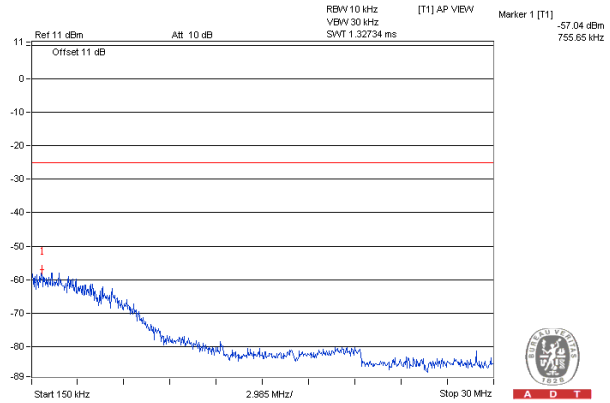
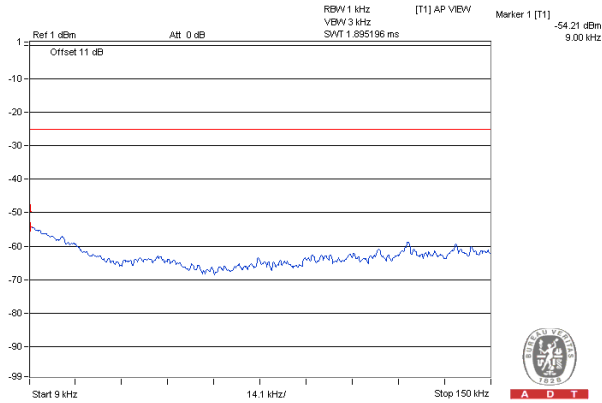

Frequency Range : 30MHz~1GHz

Frequency Range : 1GHz~12GHz

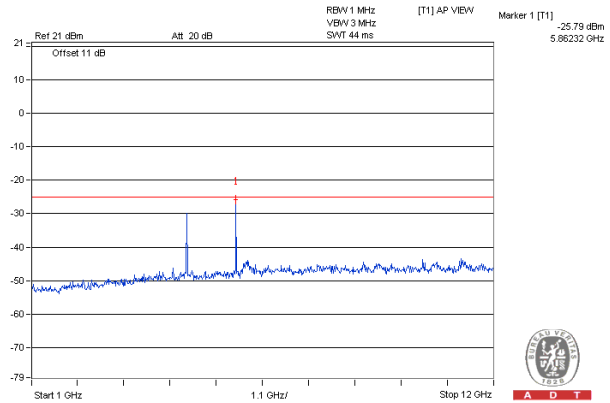
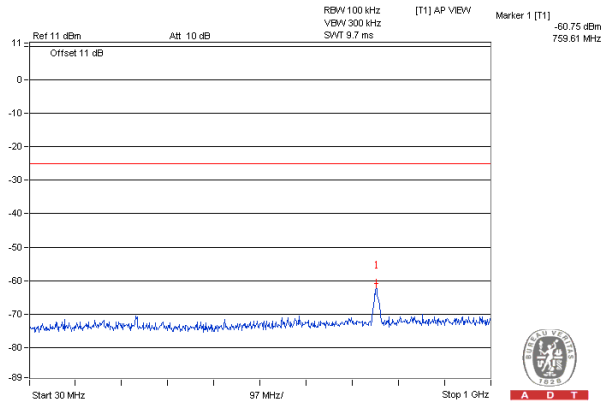

Frequency Range : 12GHz~25GHz

Frequency Range : 25GHz~40GHz

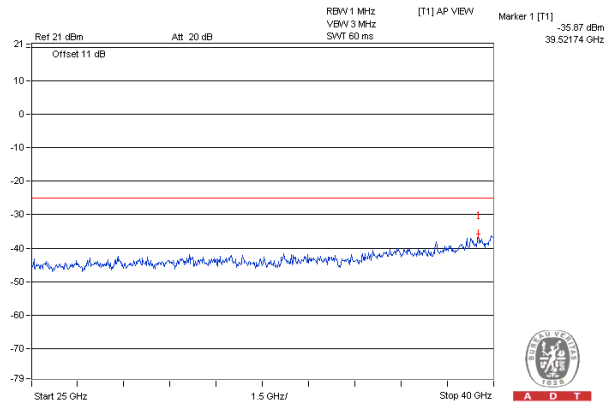
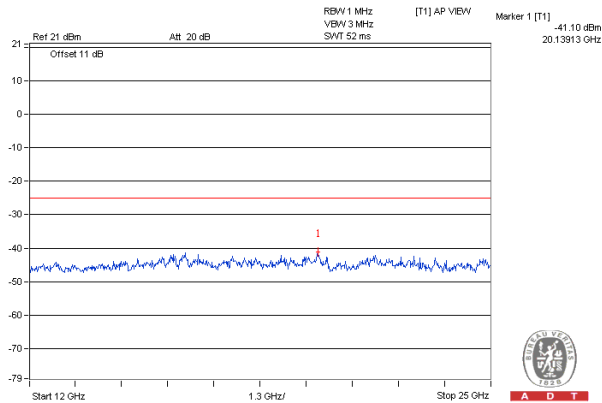

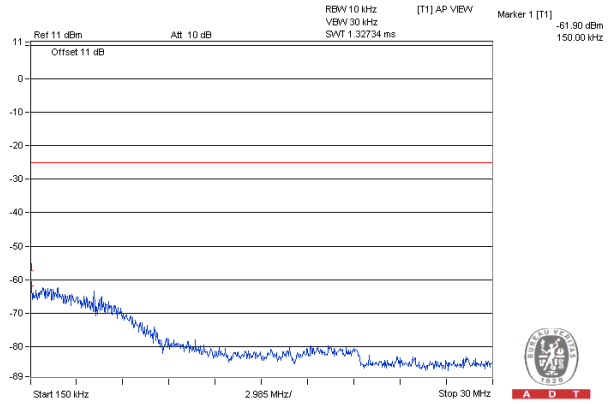
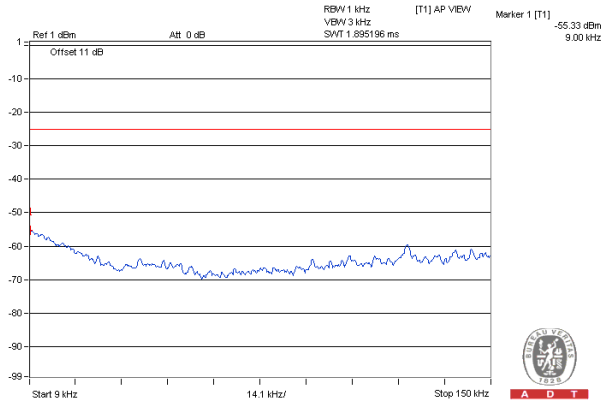
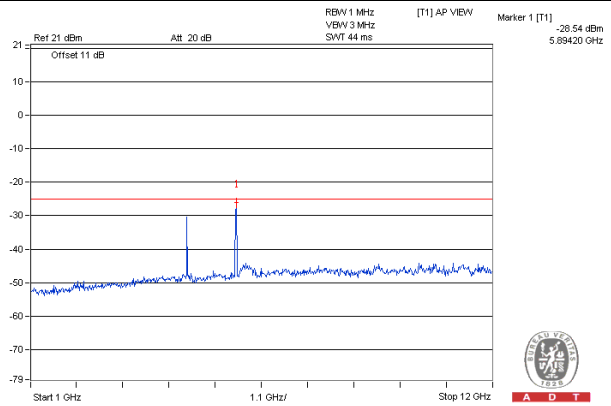
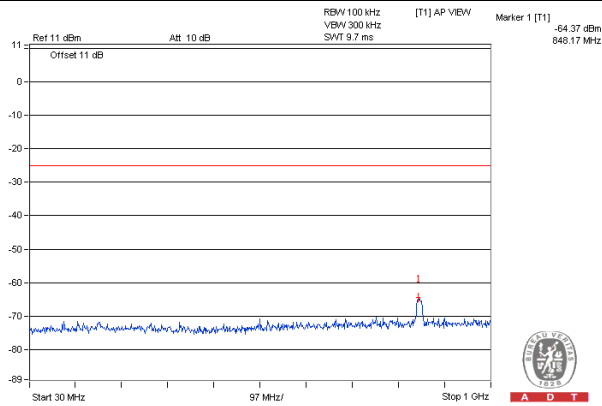
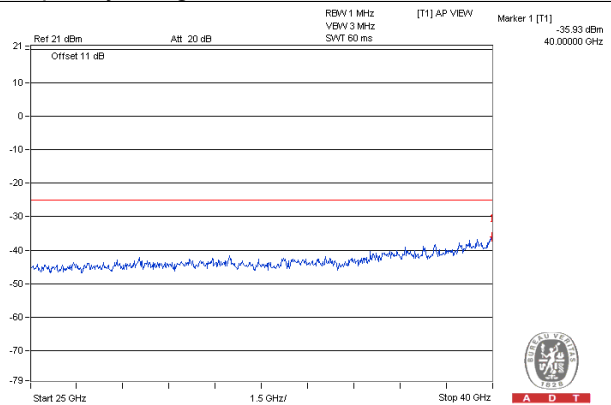
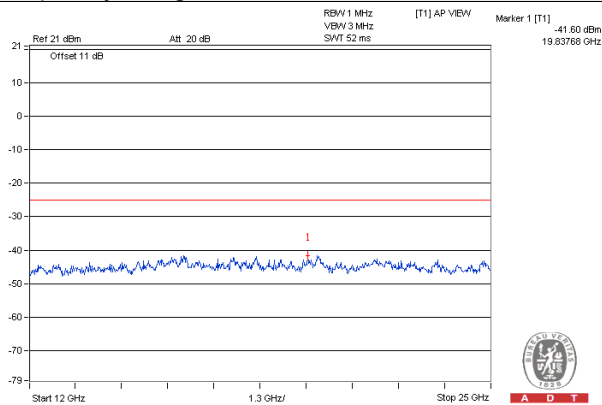
**Data Rate: 3Mbps****Channel 178****Frequency Range : 9kHz~150kHz****Frequency Range : 150kHz~30MHz****Frequency Range : 30MHz~1GHz****Frequency Range : 1GHz~12GHz****Frequency Range : 12GHz~25GHz****Frequency Range : 25GHz~40GHz**

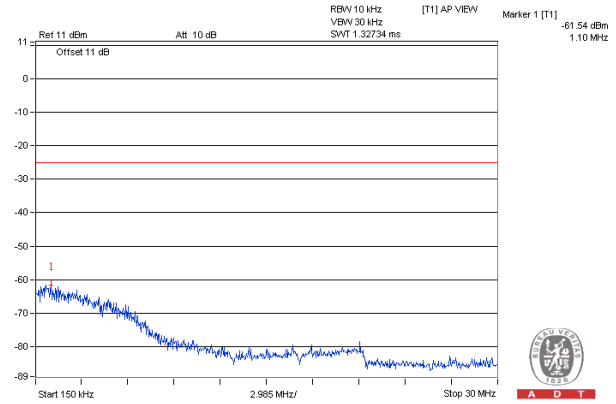
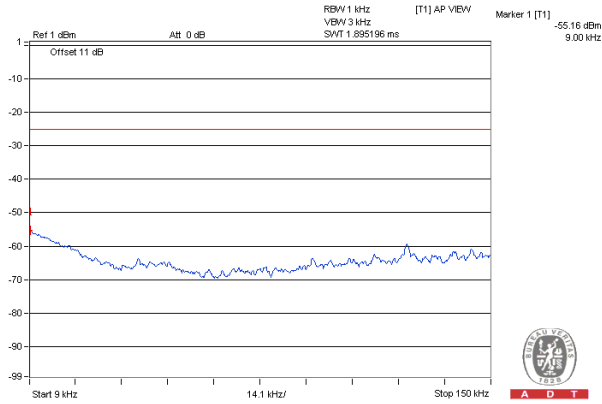
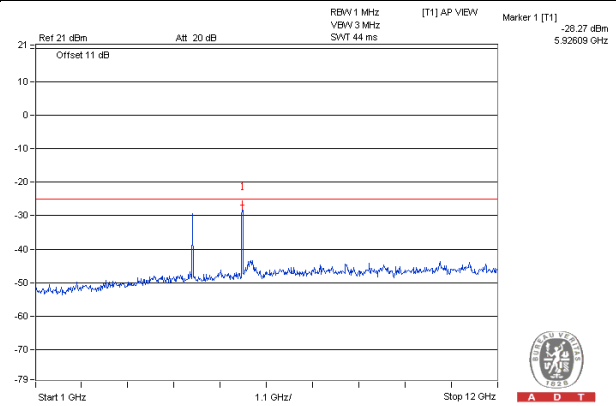
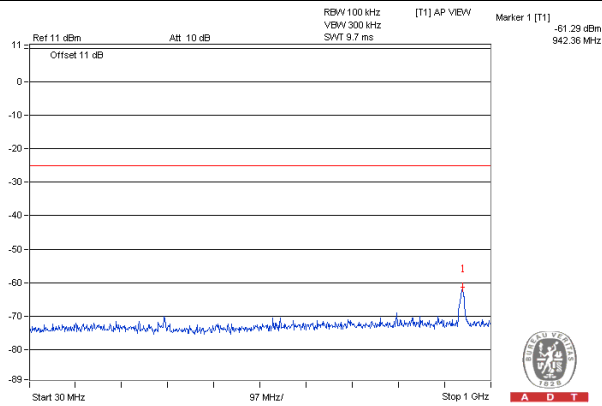
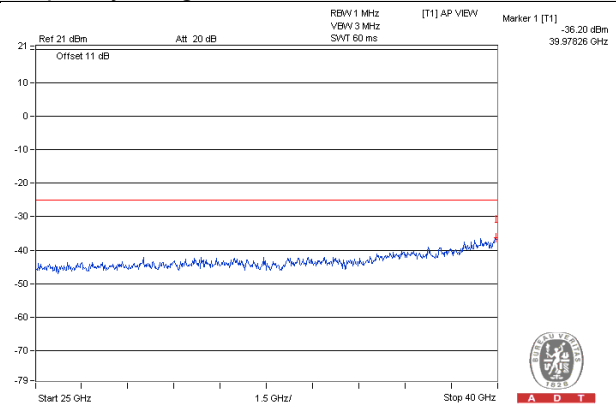
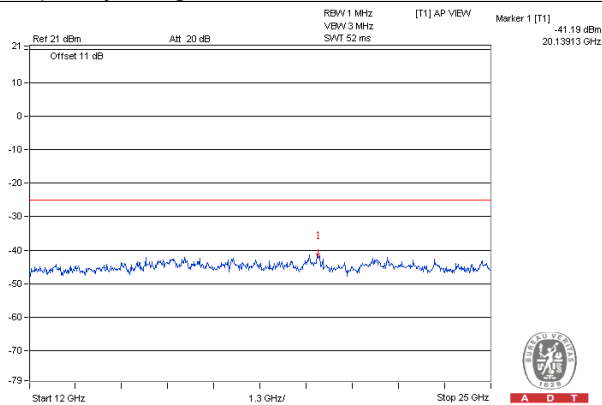
**Data Rate: 3Mbps****Channel 184****Frequency Range : 9kHz~150kHz****Frequency Range : 150kHz~30MHz****Frequency Range : 30MHz~1GHz****Frequency Range : 1GHz~12GHz****Frequency Range : 12GHz~25GHz****Frequency Range : 25GHz~40GHz**

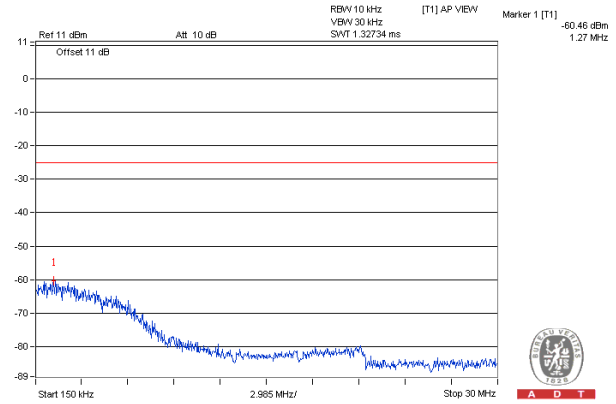
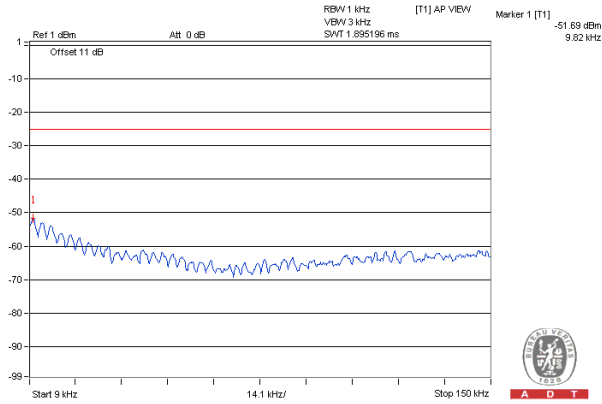
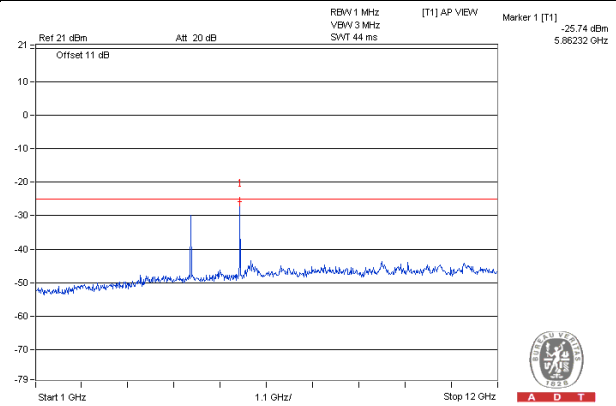
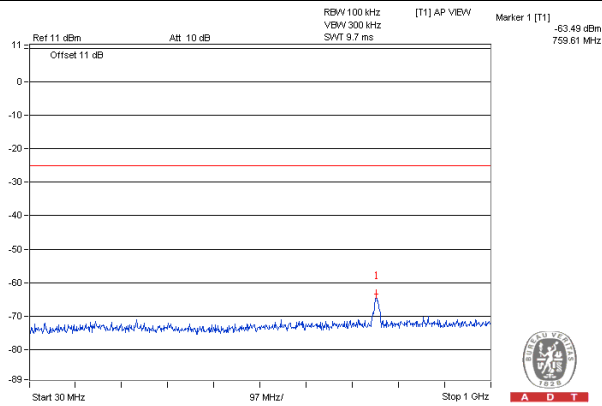
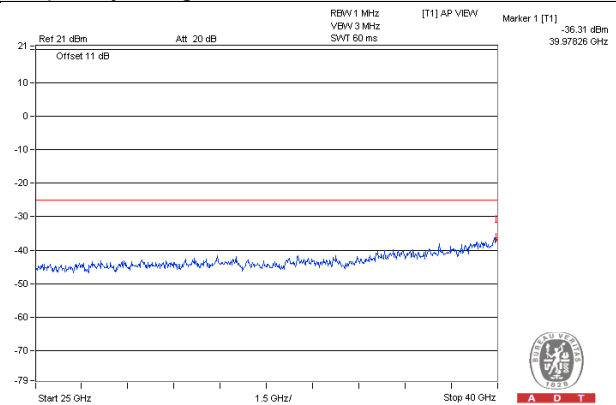
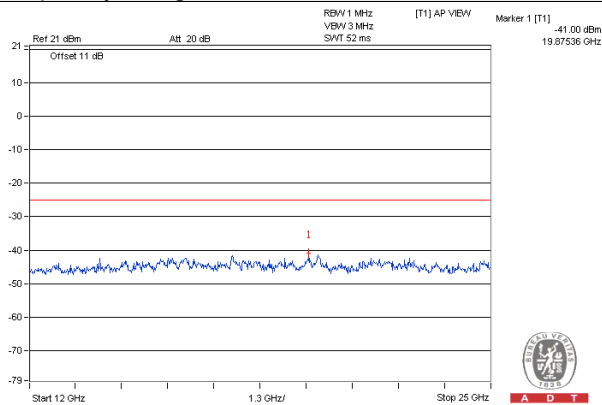
**Data Rate: 27Mbps****Channel 172****Frequency Range : 9kHz~150kHz****Frequency Range : 150kHz~30MHz****Frequency Range : 30MHz~1GHz****Frequency Range : 1GHz~12GHz****Frequency Range : 12GHz~25GHz****Frequency Range : 25GHz~40GHz**

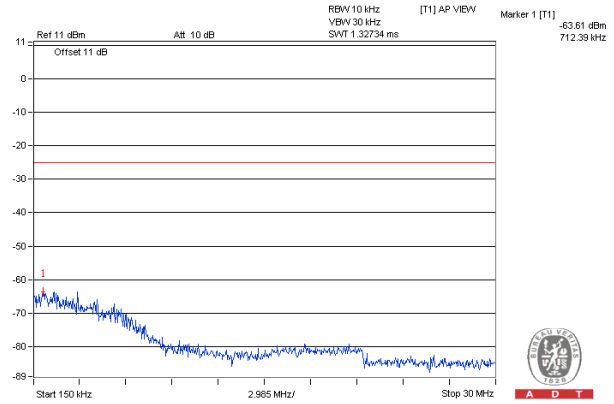
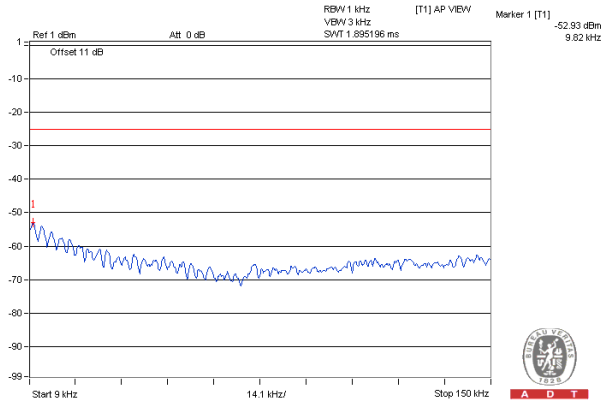
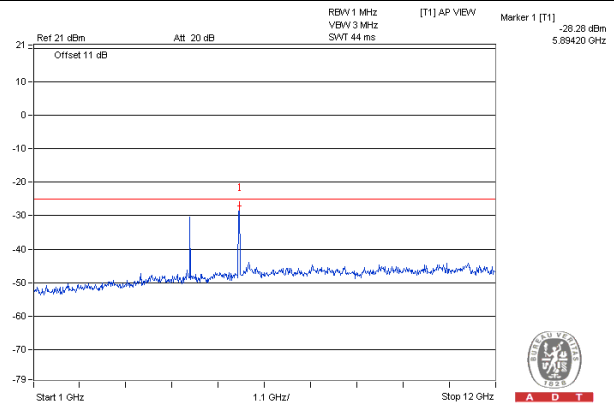
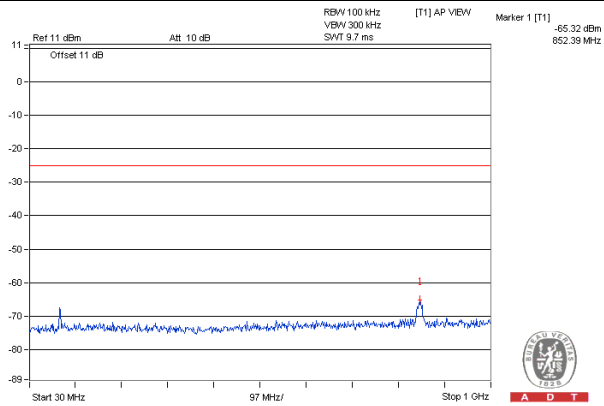
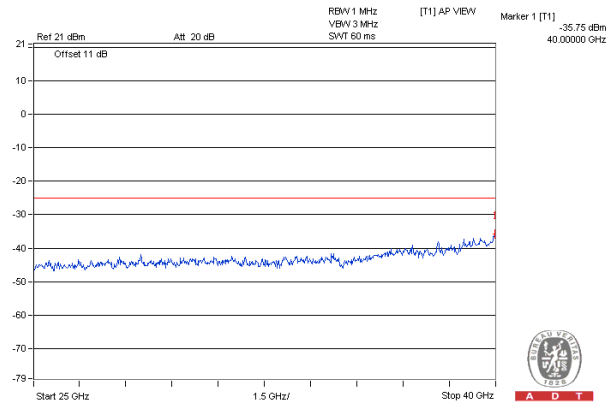
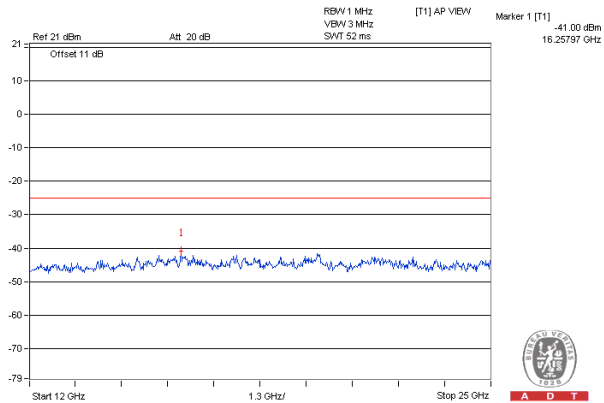
**Data Rate: 27Mbps****Channel 178****Frequency Range : 9kHz~150kHz****Frequency Range : 150kHz~30MHz****Frequency Range : 30MHz~1GHz****Frequency Range : 1GHz~12GHz****Frequency Range : 12GHz~25GHz****Frequency Range : 25GHz~40GHz**

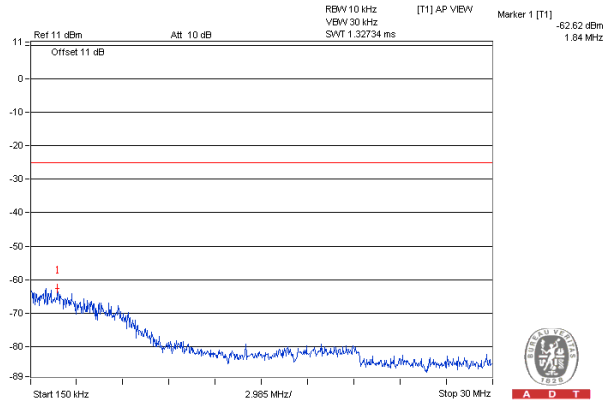
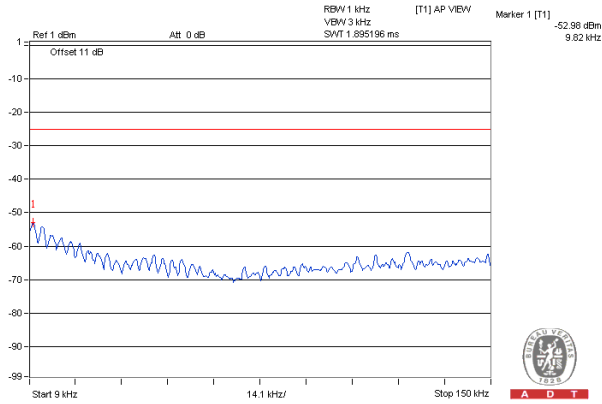
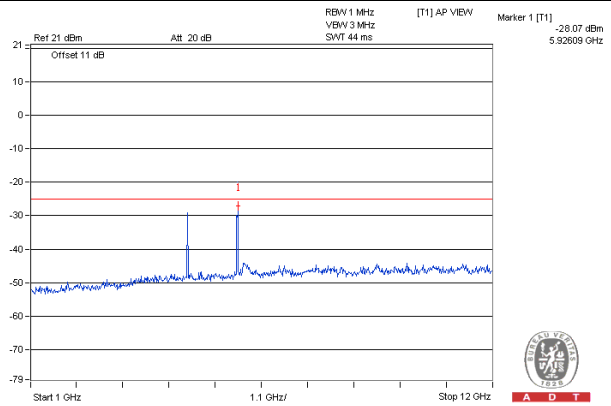
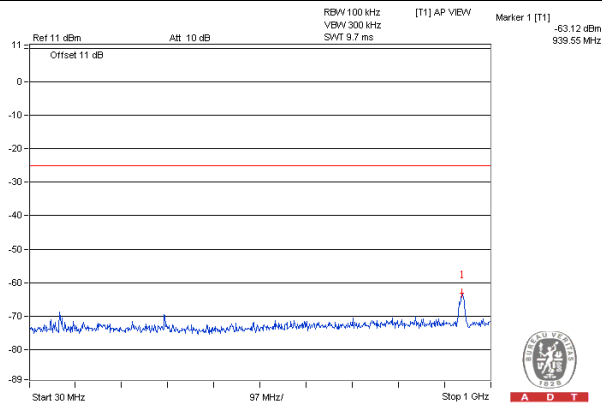
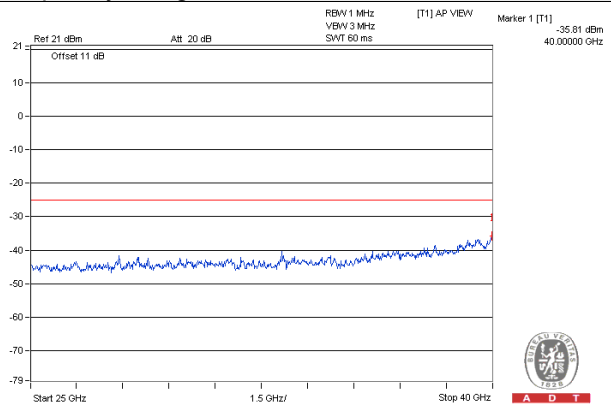
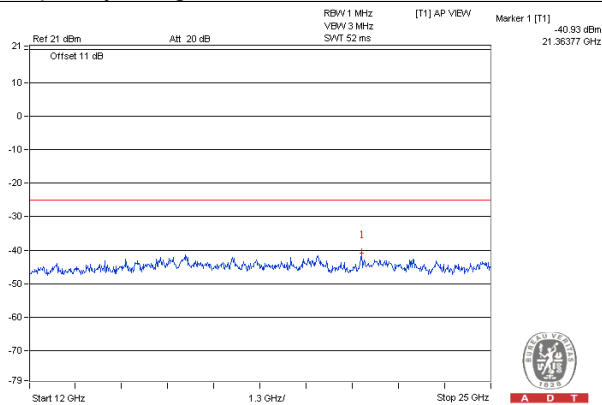

**Data Rate: 27Mbps****Channel 184****Frequency Range : 9kHz~150kHz****Frequency Range : 150kHz~30MHz****Frequency Range : 30MHz~1GHz****Frequency Range : 1GHz~12GHz****Frequency Range : 12GHz~25GHz****Frequency Range : 25GHz~40GHz**

Test Mode B

Data Rate: 3Mbps, Chain 0

Channel 172

Frequency Range : 9kHz~150kHz

Frequency Range : 150kHz~30MHz

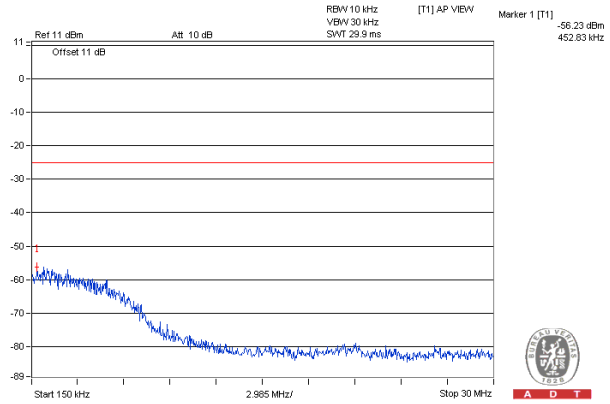
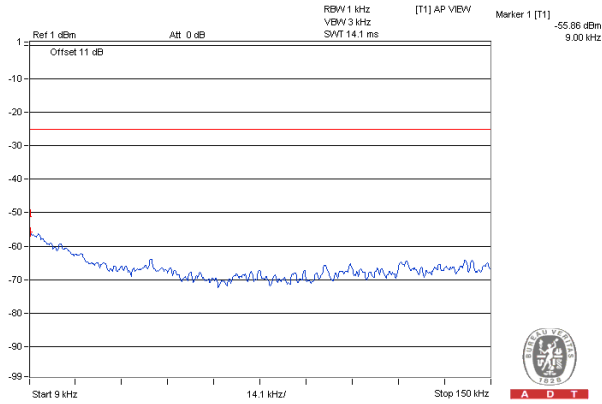

Frequency Range : 30MHz~1GHz

Frequency Range : 1GHz~12GHz

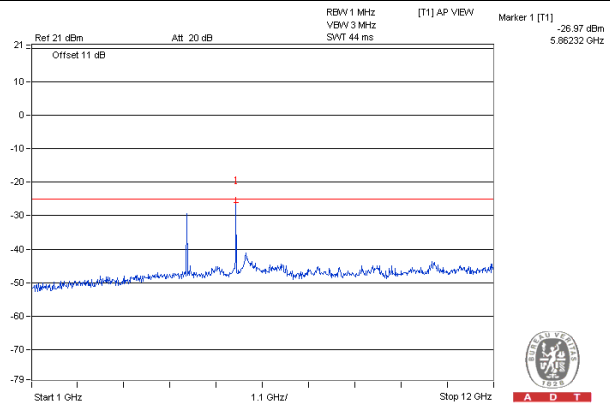
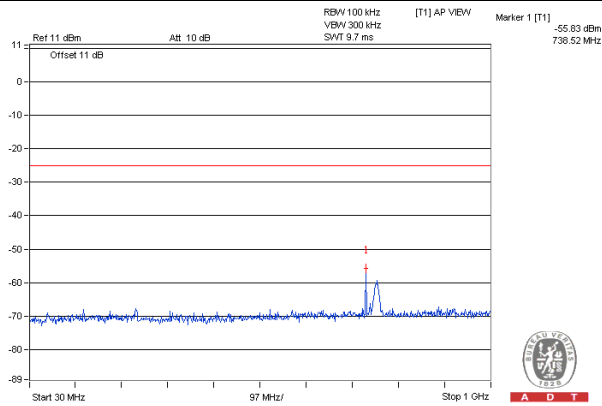

Frequency Range : 12GHz~25GHz

Frequency Range : 25GHz~40GHz

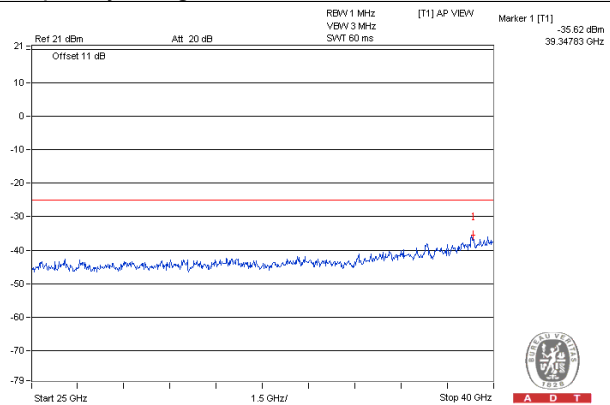
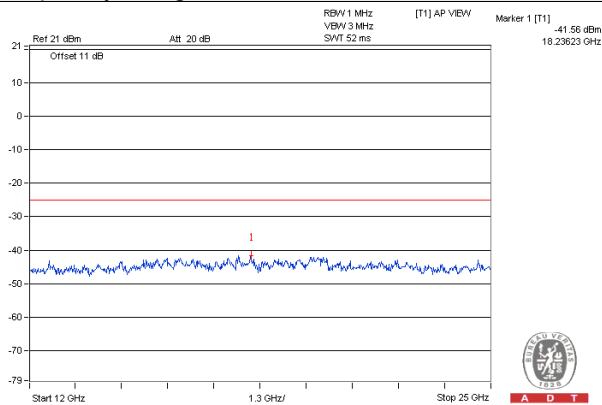

Data Rate: 3Mbps, Chain 0

Channel 178

Frequency Range : 9kHz~150kHz

Frequency Range : 150kHz~30MHz

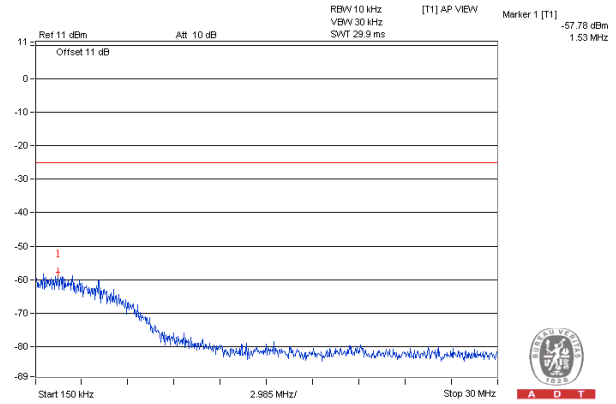
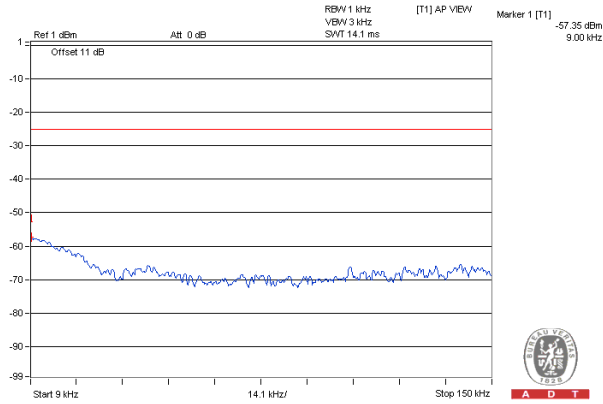

Frequency Range : 30MHz~1GHz

Frequency Range : 1GHz~12GHz

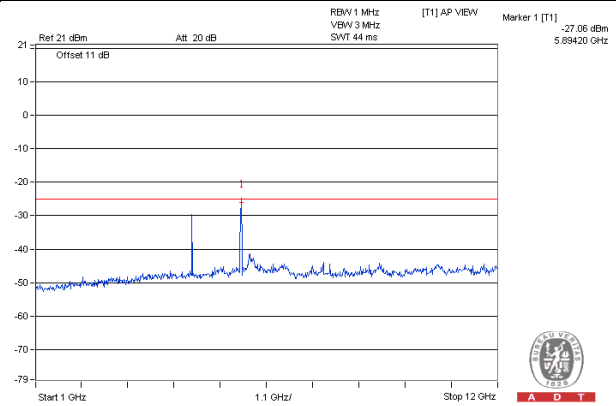
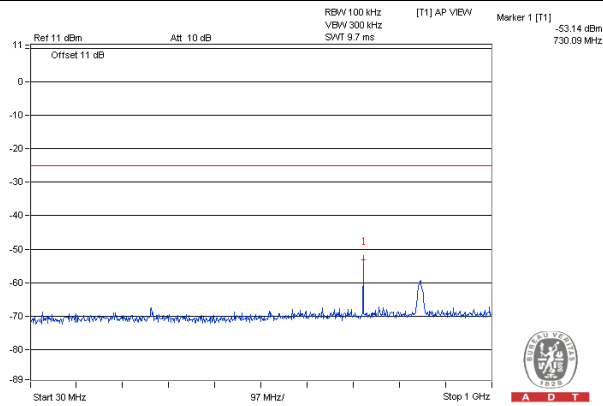

Frequency Range : 12GHz~25GHz

Frequency Range : 25GHz~40GHz

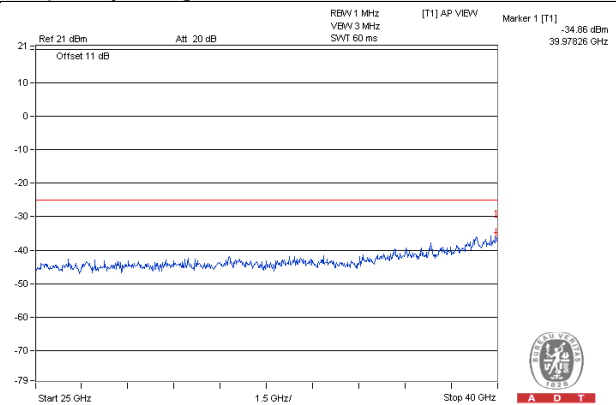
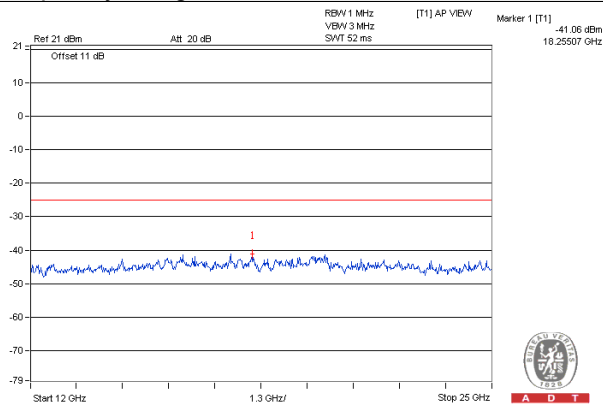

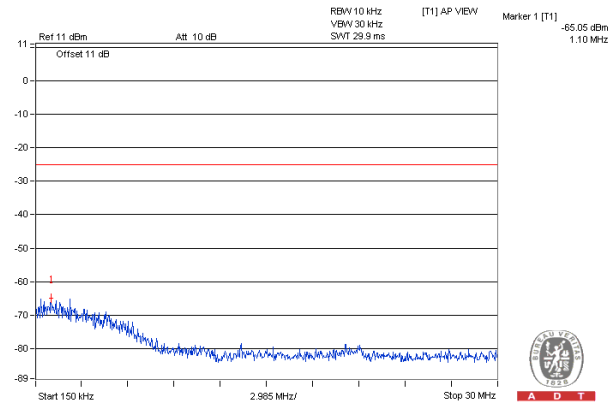
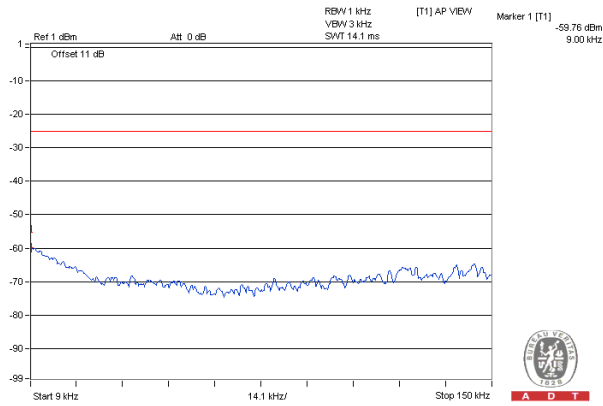
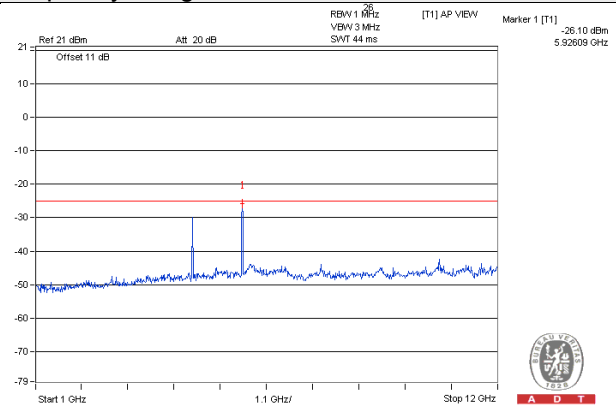
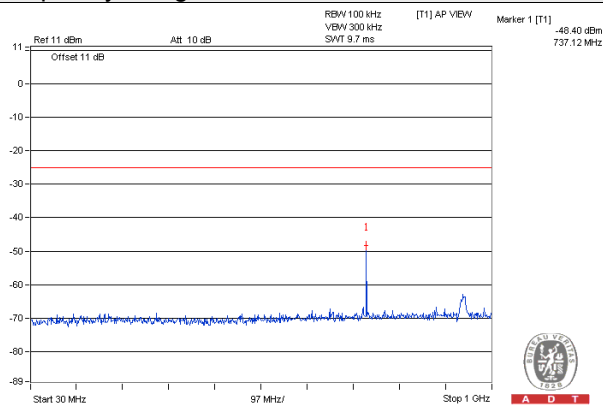
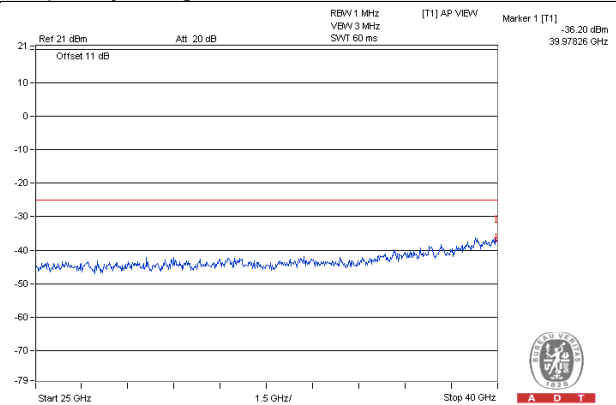
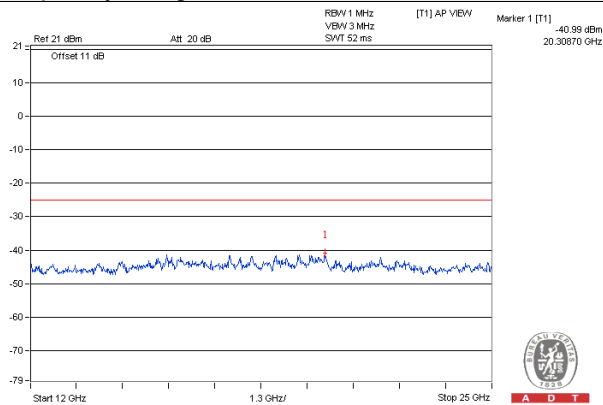
**Data Rate: 3Mbps, Chain 0****Channel 184****Frequency Range : 9kHz~150kHz****Frequency Range : 150kHz~30MHz****Frequency Range : 30MHz~1GHz****Frequency Range : 1GHz~12GHz****Frequency Range : 12GHz~25GHz****Frequency Range : 25GHz~40GHz**

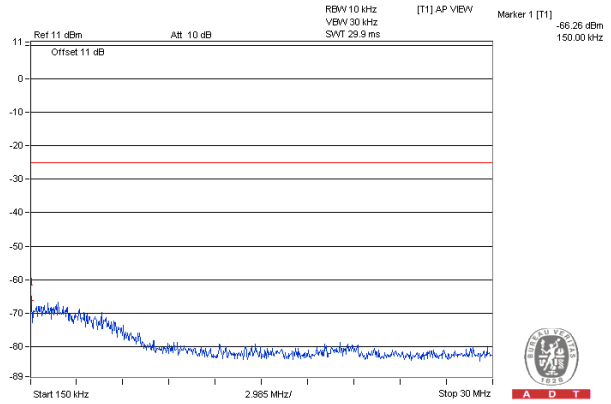
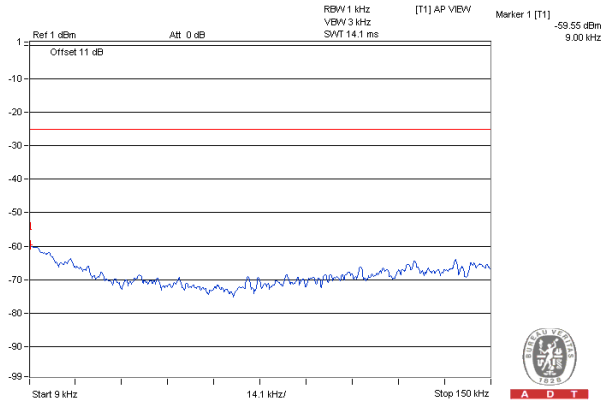
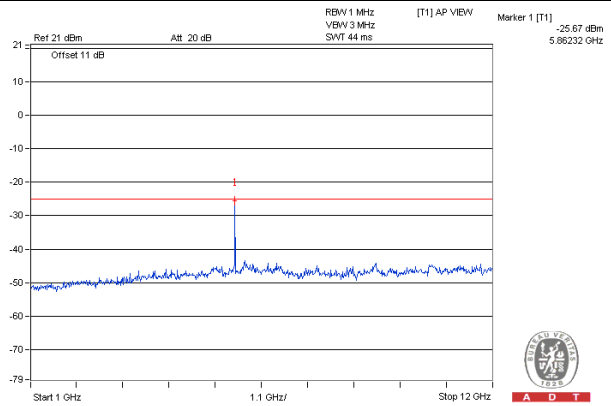
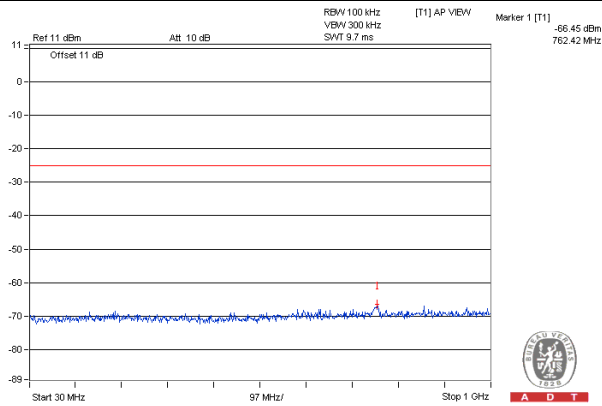
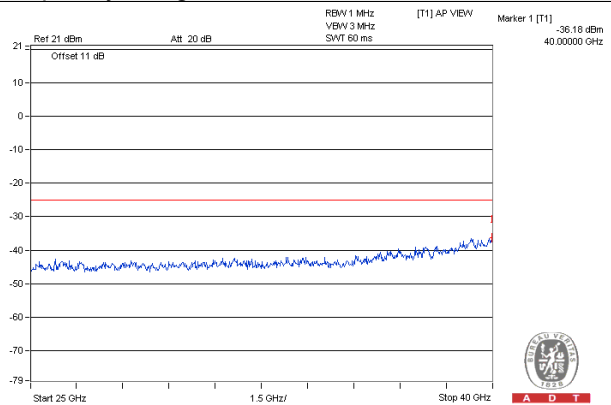
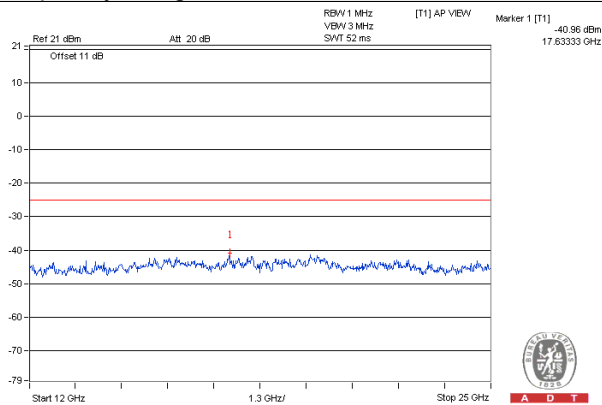
**Data Rate: 3Mbps, Chain 1****Channel 172****Frequency Range : 9kHz~150kHz****Frequency Range : 150kHz~30MHz****Frequency Range : 30MHz~1GHz****Frequency Range : 1GHz~12GHz****Frequency Range : 12GHz~25GHz****Frequency Range : 25GHz~40GHz**

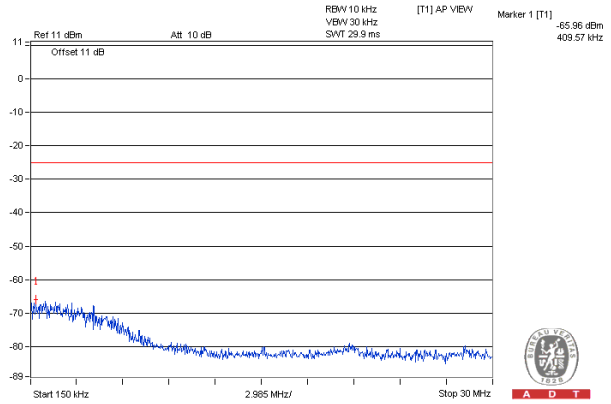
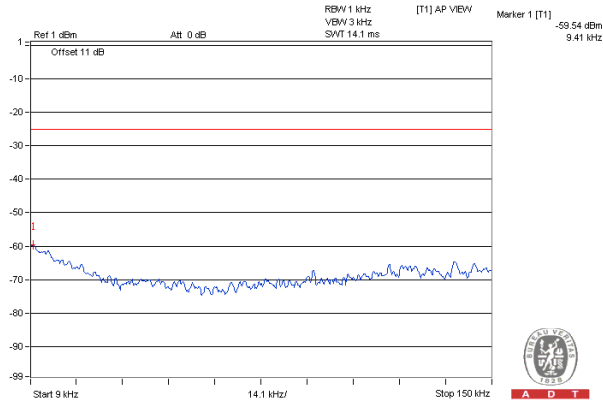
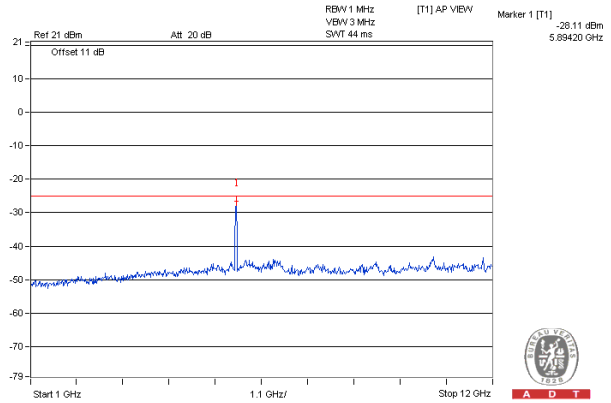
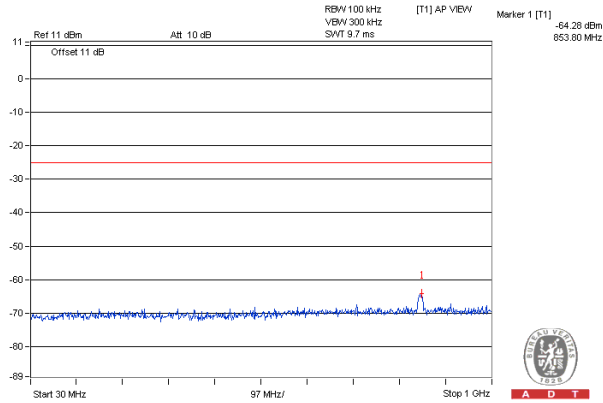
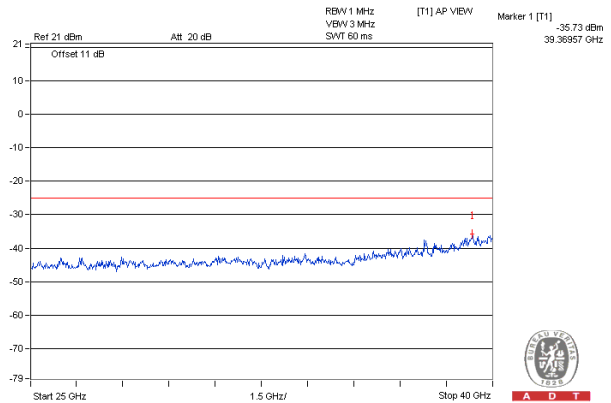
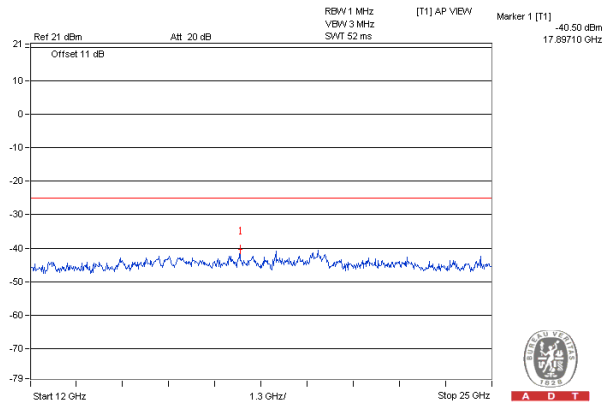
**Data Rate: 3Mbps, Chain 1****Channel 178****Frequency Range : 9kHz~150kHz****Frequency Range : 150kHz~30MHz****Frequency Range : 30MHz~1GHz****Frequency Range : 1GHz~12GHz****Frequency Range : 12GHz~25GHz****Frequency Range : 25GHz~40GHz**

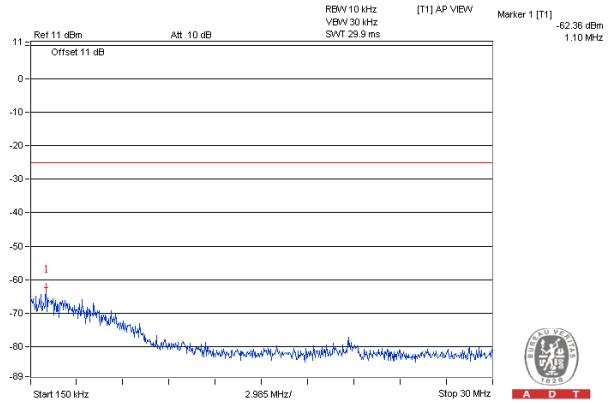
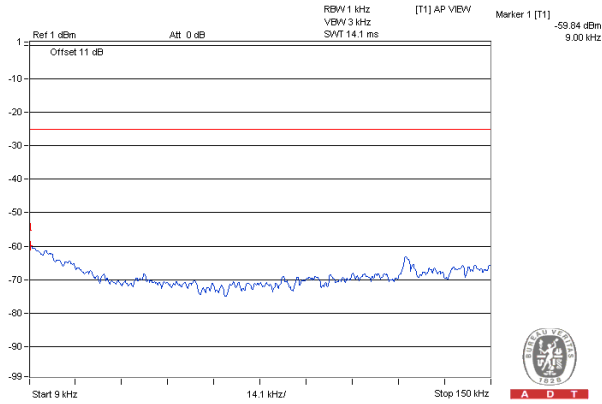
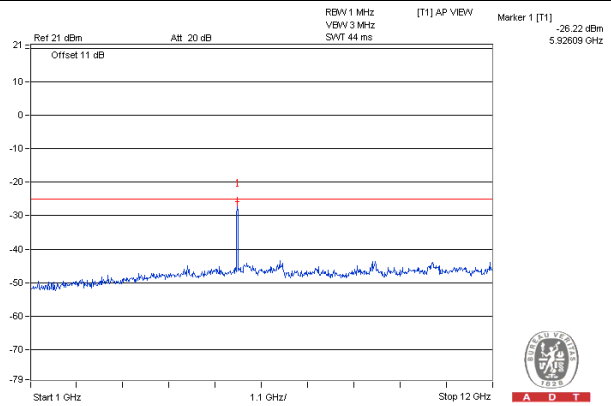
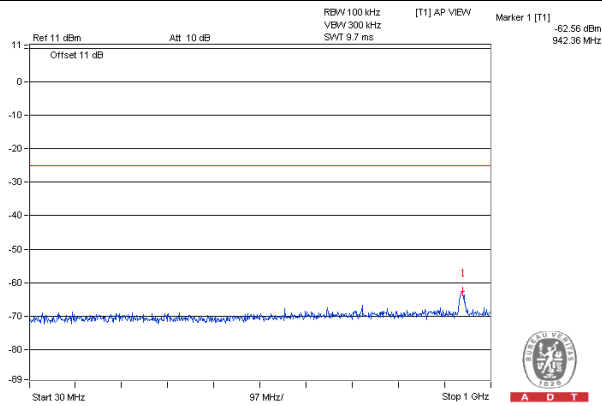
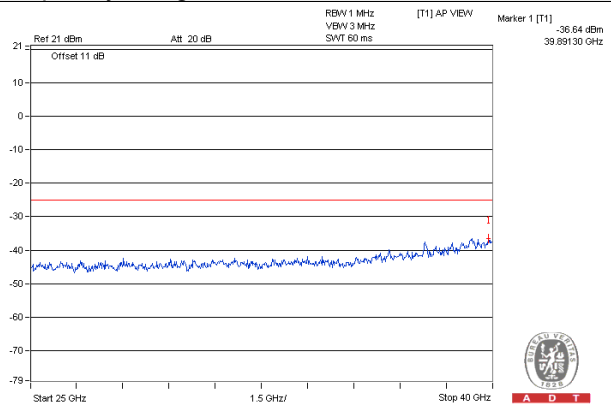
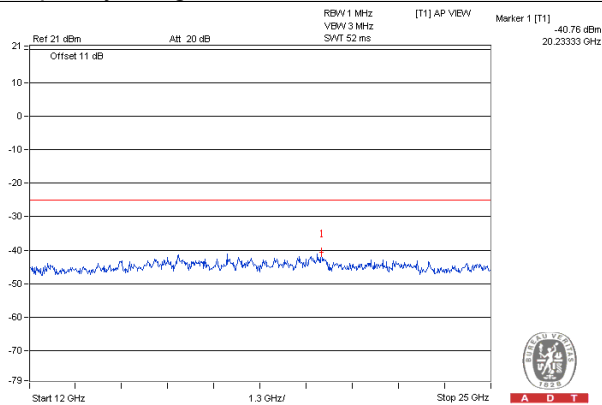
**Data Rate: 3Mbps, Chain 1****Channel 184****Frequency Range : 9kHz~150kHz****Frequency Range : 150kHz~30MHz****Frequency Range : 30MHz~1GHz****Frequency Range : 1GHz~12GHz****Frequency Range : 12GHz~25GHz****Frequency Range : 25GHz~40GHz**

Data Rate: 27Mbps, Chain 0

Channel 172

Frequency Range : 9kHz~150kHz

Frequency Range : 150kHz~30MHz

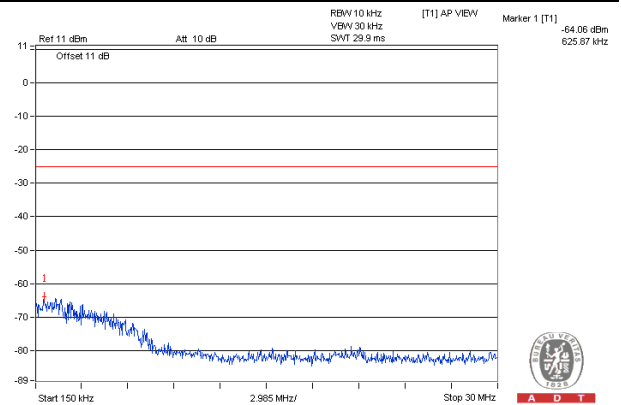
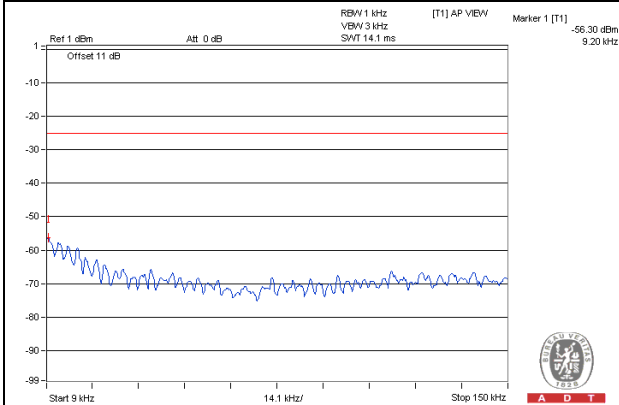

Frequency Range : 30MHz~1GHz

Frequency Range : 1GHz~12GHz

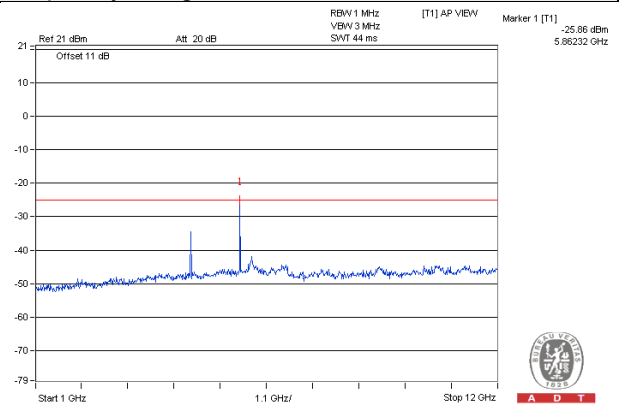
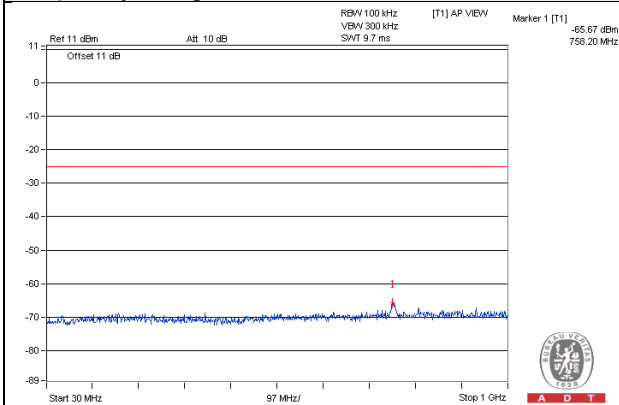

Frequency Range : 12GHz~25GHz

Frequency Range : 25GHz~40GHz

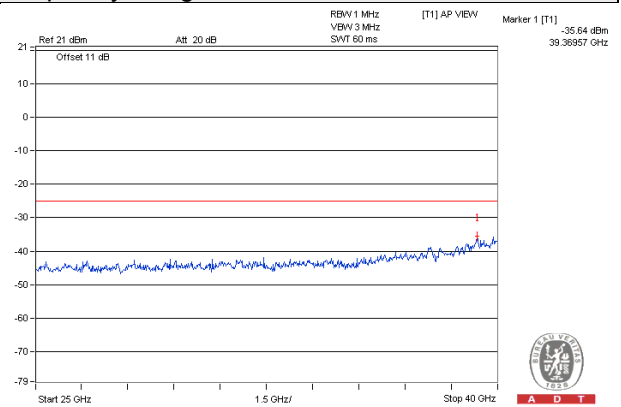
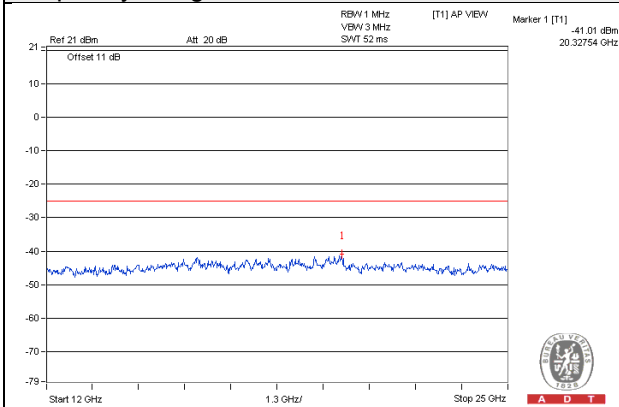



Data Rate: 27Mbps, Chain 0

Channel 178

Frequency Range : 9kHz~150kHz

Frequency Range : 150kHz~30MHz

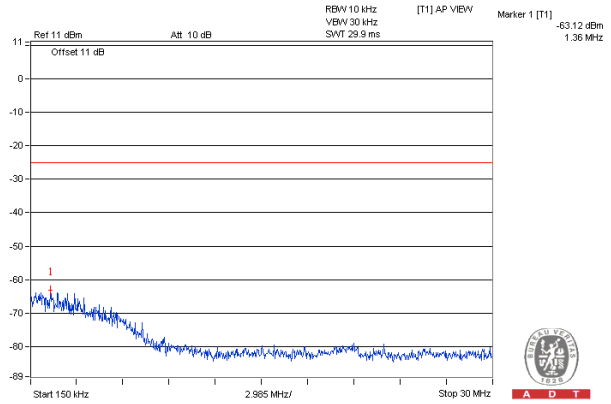
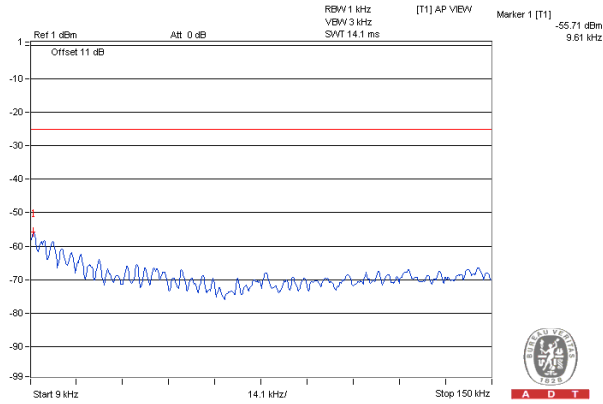

Frequency Range : 30MHz~1GHz

Frequency Range : 1GHz~12GHz

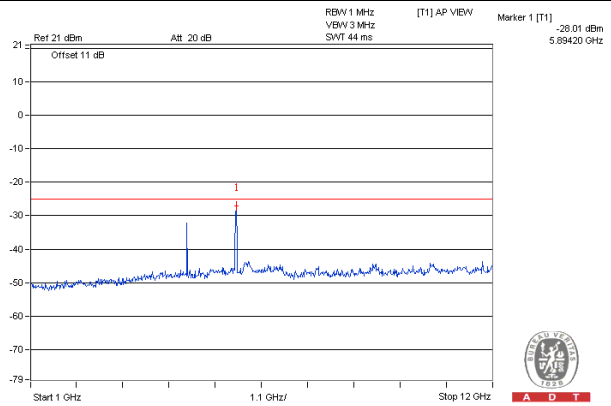
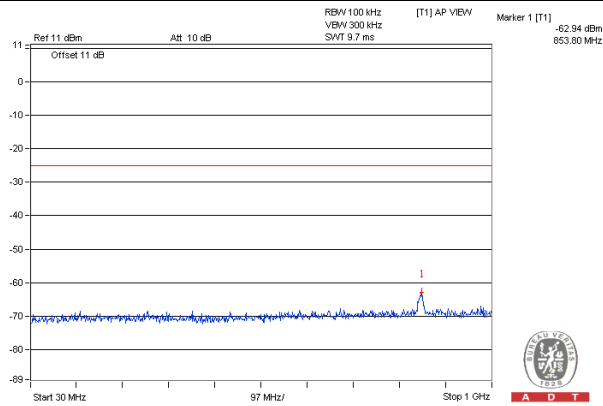

Frequency Range : 12GHz~25GHz

Frequency Range : 25GHz~40GHz

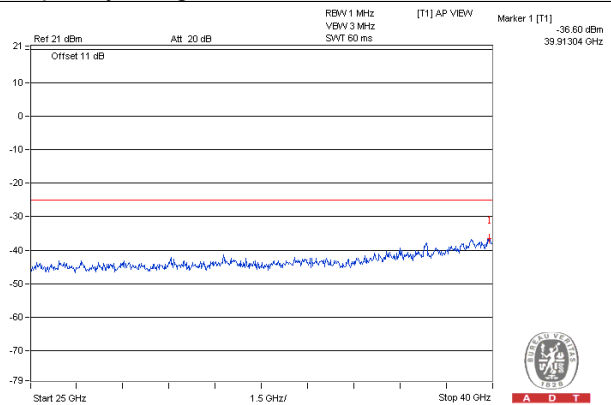
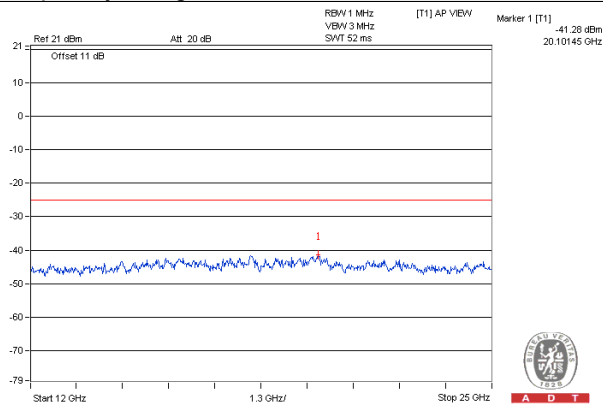

Data Rate: 27Mbps, Chain 0

Channel 184

Frequency Range : 9kHz~150kHz

Frequency Range : 150kHz~30MHz

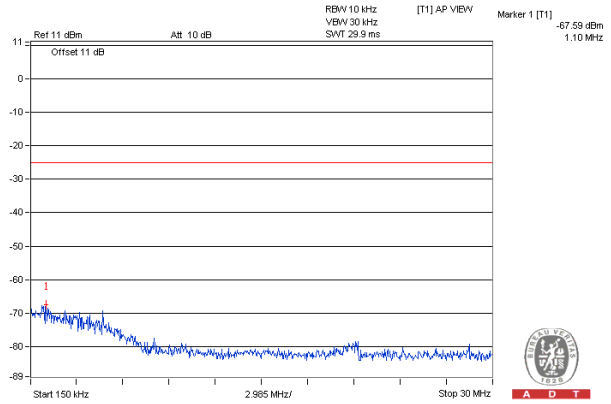
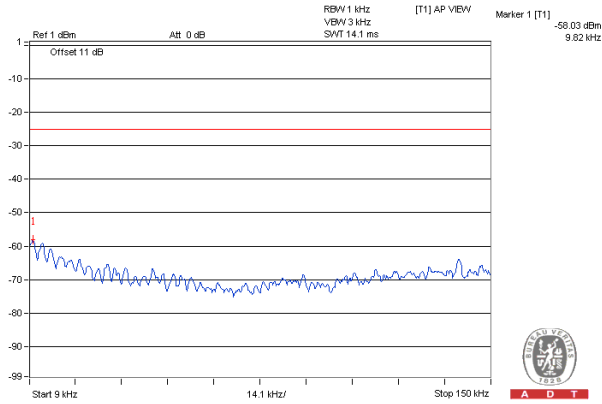

Frequency Range : 30MHz~1GHz

Frequency Range : 1GHz~12GHz

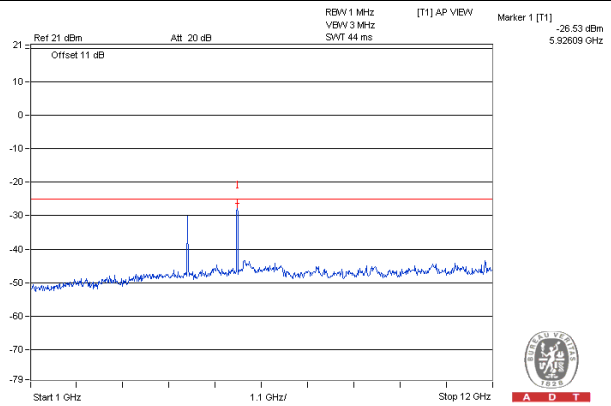
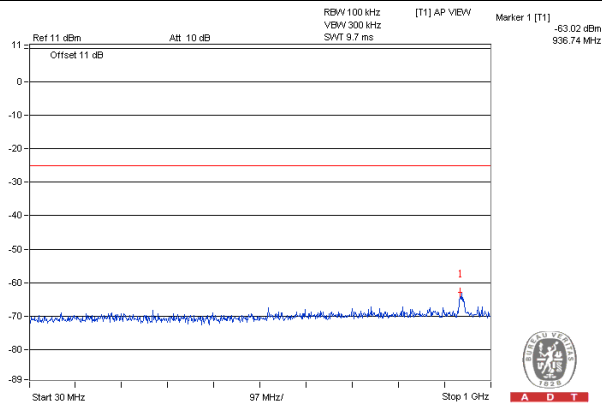

Frequency Range : 12GHz~25GHz

Frequency Range : 25GHz~40GHz

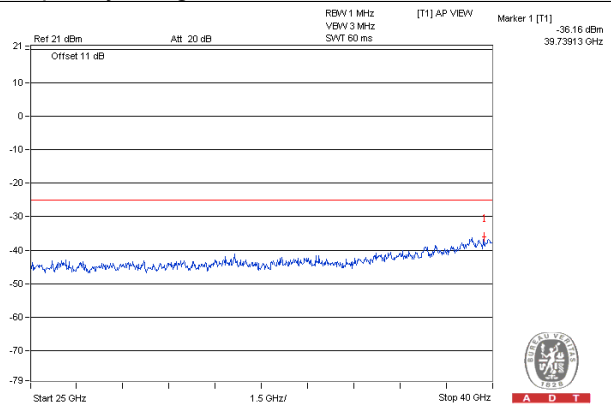
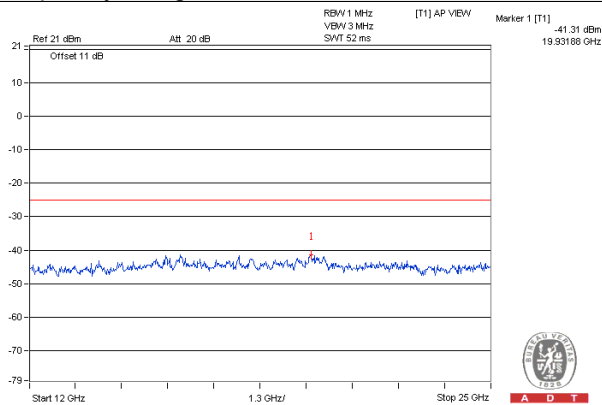

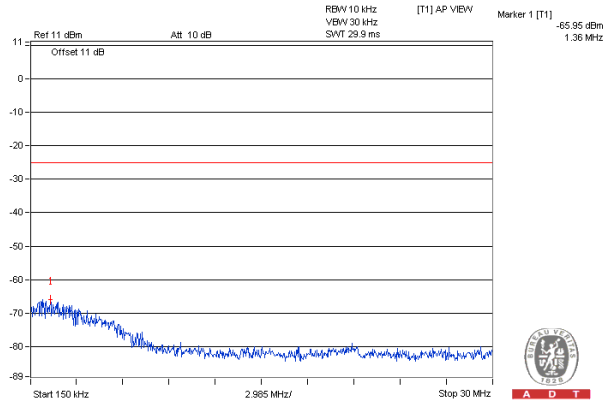
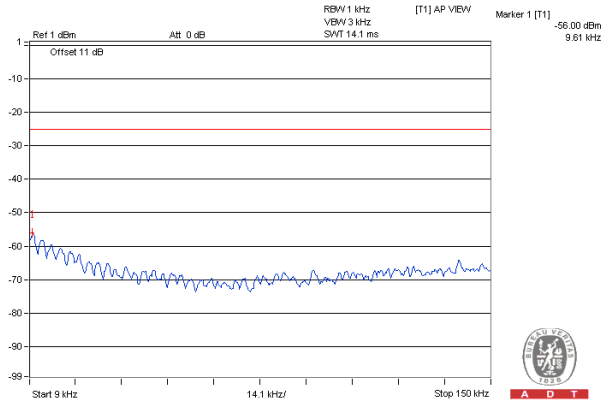
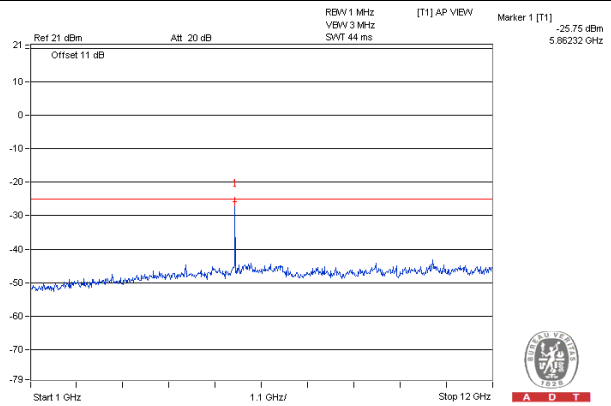
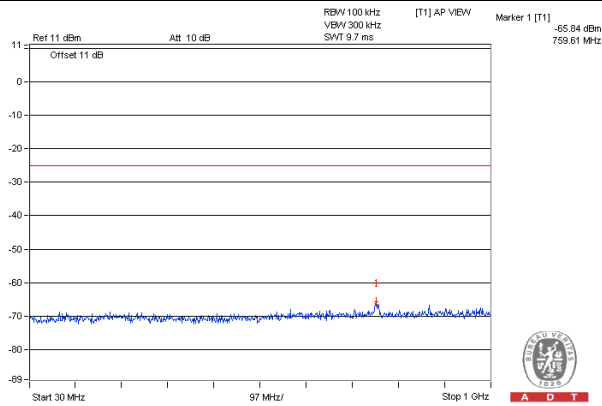
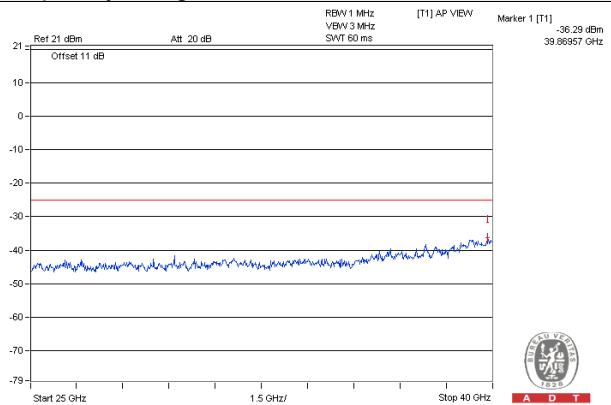
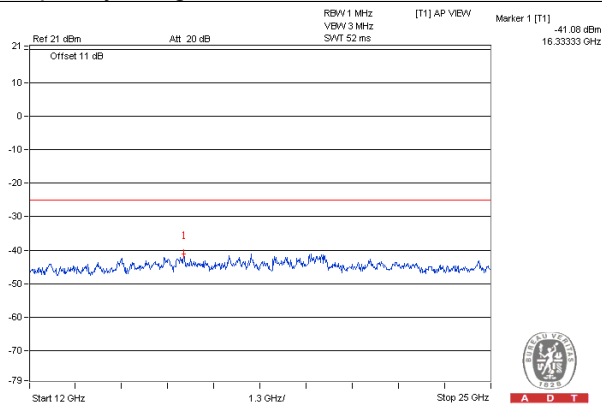
**Data Rate: 27Mbps, Chain 1****Channel 172****Frequency Range : 9kHz~150kHz****Frequency Range : 150kHz~30MHz****Frequency Range : 30MHz~1GHz****Frequency Range : 1GHz~12GHz****Frequency Range : 12GHz~25GHz****Frequency Range : 25GHz~40GHz**

Data Rate: 27Mbps, Chain 1

Channel 178

Frequency Range : 9kHz~150kHz

Frequency Range : 150kHz~30MHz

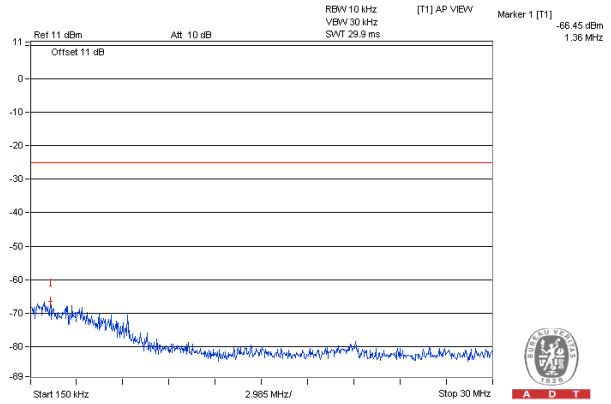
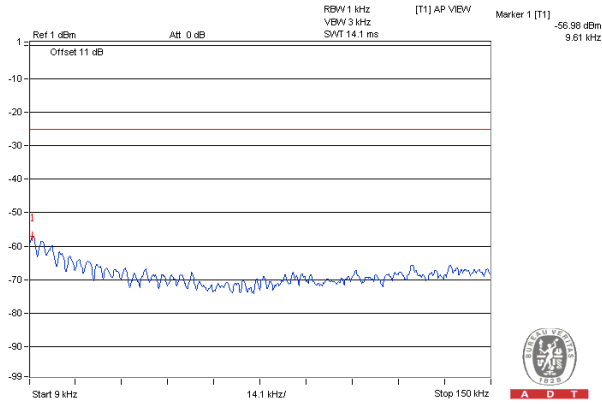

Frequency Range : 30MHz~1GHz

Frequency Range : 1GHz~12GHz

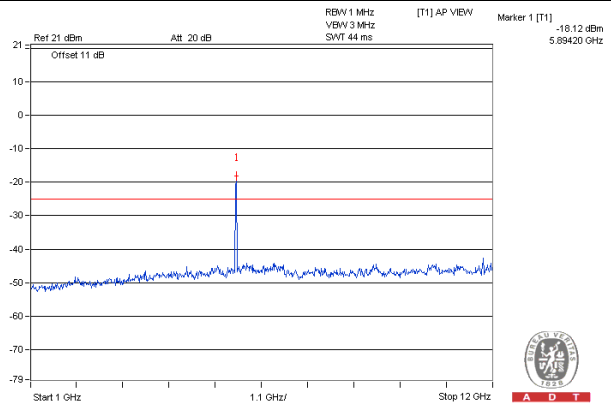
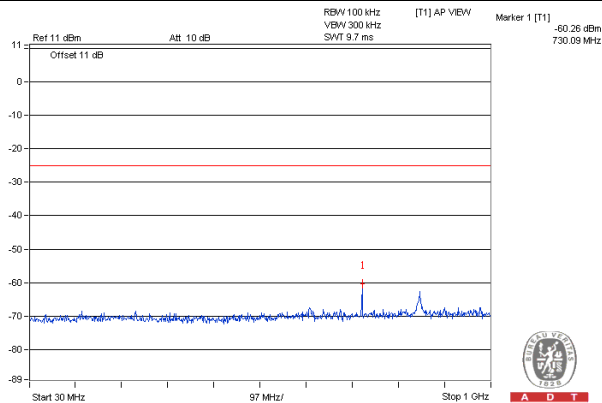

Frequency Range : 12GHz~25GHz

Frequency Range : 25GHz~40GHz

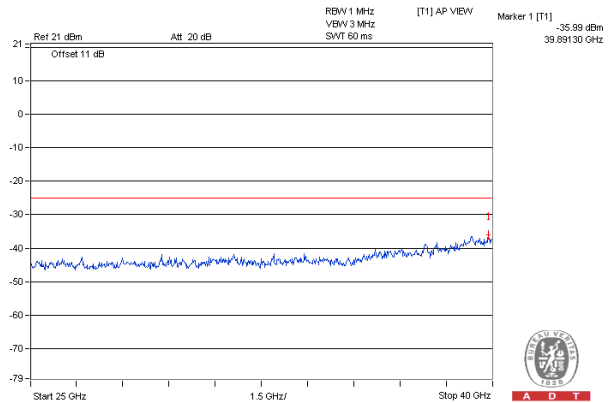
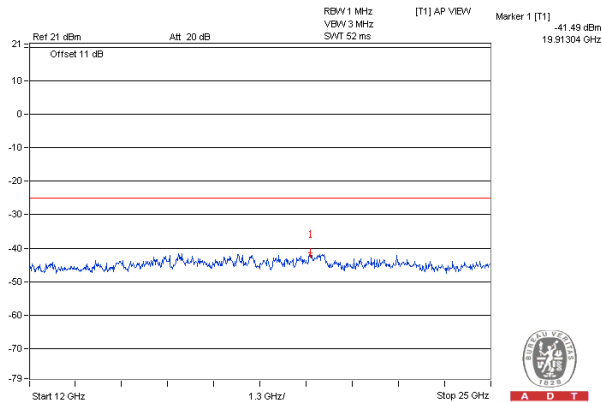

Note: The test figure (frequency range 1GHz ~ 12GHz) which measurement point over the limit was fundamental frequency.

Data Rate: 27Mbps, Chain 1

Channel 184

Frequency Range : 9kHz~150kHz

Frequency Range : 150kHz~30MHz

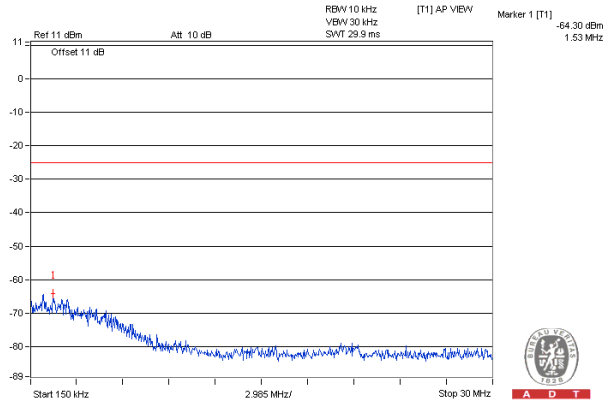
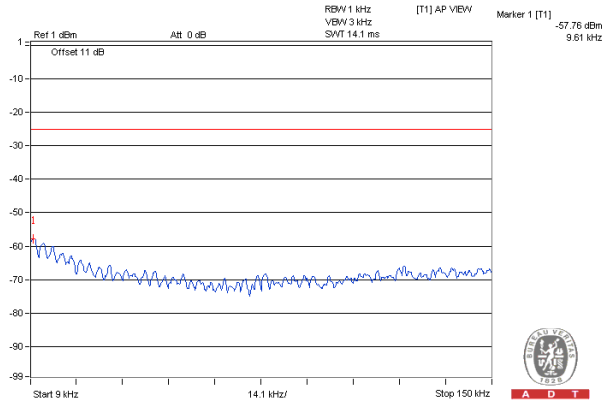

Frequency Range : 30MHz~1GHz

Frequency Range : 1GHz~12GHz

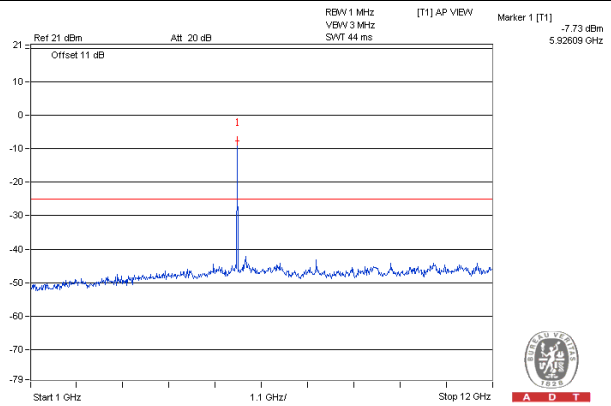
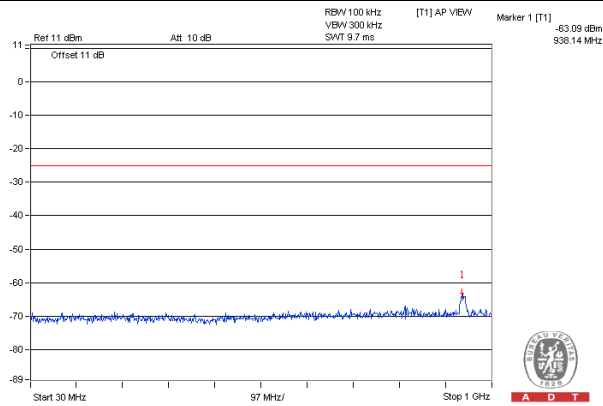

Frequency Range : 12GHz~25GHz

Frequency Range : 25GHz~40GHz

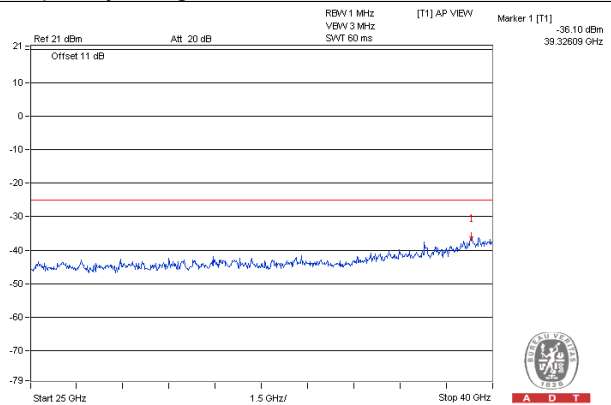
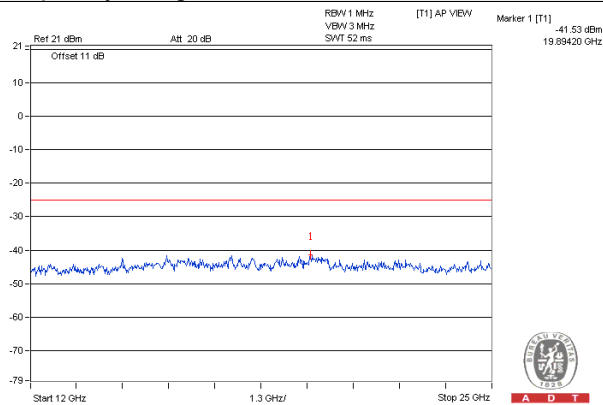

Note: The test figure (frequency range 1GHz ~ 12GHz) which measurement point over the limit was fundamental frequency.

## 4.7 Radiated Emission Measurement

### 4.7.1 Limits of Radiated Emission Measurement

The power of any emission outside a licensee's frequency band(s) of operation shall be attenuated below the transmitter power (P) within the licensed band(s) of operation, measured in watts, by at least  $[55 + 10 \log(P)]$  (e.i.r.p. -25dBm [70.2 dBuV/m at 3m]).

### 4.7.2 Test Procedure

- a. Substitution method is used for E.I.R.P measurement. In the semi-anechoic chamber, EUT placed on the 0.8m height of Turn Table, rotated the table around 360 degrees to search the maximum radiation power and receiver antenna shall be rotated vertical and horizontal polarization and moved height from 1m to 4m to find the maximum polar radiated power. The "Read Value" is the spectrum reading the maximum power value.
- b. The substitution horn antenna is substituted for EUT at the same position and signals generator export the CW signal to the substitution antenna via a TX cable. Rotated the Turn Table and moved receiving antenna to find the maximum radiation power. Adjust output power level of S.G to get a Value of spectrum reading equal to "Read Value" of step a. Record the power level of S.G
- c. EIRP = Output power level of S.G – TX cable loss + Antenna gain of substitution horn.
- d. E.R.P power can be calculated form E.I.R.P power by subtracting the gain of dipole, E.R.P power = E.I.R.P power - 2.15dBi.

**NOTE:** The resolution bandwidth and video bandwidth of test receiver/spectrum analyzer is 1MHz/3MHz.

### 4.7.3 Deviation from Test Standard

No deviation.

#### 4.7.4 Test Setup

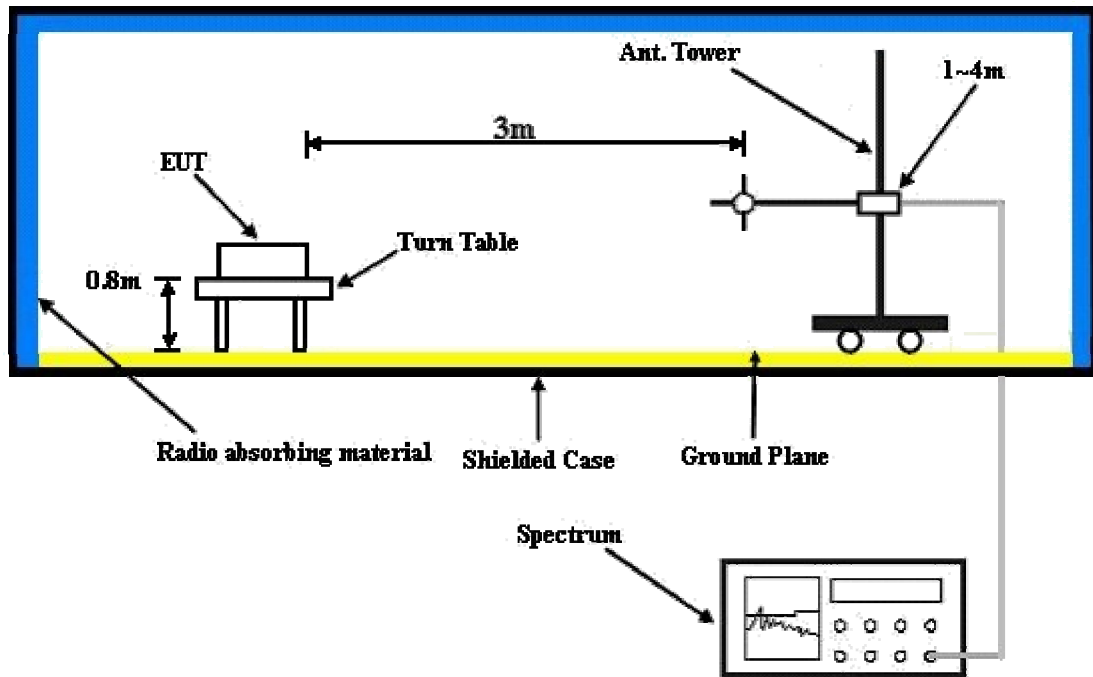

For the actual test configuration, please refer to the attached file (Test Setup Photo).

#### 4.7.5 Test Results

Below 1GHz

Test Mode A: Data rate: 3Mbps

Mode	TX channel 172	Frequency Range	Below 1000 MHz
Environmental Conditions	18deg. C, 70%RH	Input Power	120Vac, 60Hz
Tested By	Nick Hsu		

#### Antenna Polarity & Test Distance: Horizontal at 3 M

No.	Freq. (MHz)	Reading (dBm)	S.G Power Value (dBm)	Correction Factor (dB)	EIRP (dBm)	Limit (dBm)	Margin (dB)
1	103.72	-55.58	-54.83	0.73	-54.10	-25	-29.10
2	200.72	-49.83	-48.78	5.47	-43.31	-25	-18.31
3	276.38	-52.45	-51.23	5.25	-45.98	-25	-20.98
4	324.88	-54.31	-52.99	5.17	-47.82	-25	-22.82
5	400.54	-49.62	-48.15	5.28	-42.87	-25	-17.87
6	499.48	-55.85	-54.21	4.89	-49.32	-25	-24.32

#### Antenna Polarity & Test Distance: Vertical at 3 M

No.	Freq. (MHz)	Reading (dBm)	S.G Power Value (dBm)	Correction Factor (dB)	EIRP (dBm)	Limit (dBm)	Margin (dB)
1	64.92	-39.99	-39.4	-6.32	-45.72	-25	-20.72
2	200.72	-49.11	-48.06	5.47	-42.59	-25	-17.59
3	272.50	-54.94	-53.73	5.28	-48.45	-25	-23.45
4	350.10	-54.69	-53.32	5.21	-48.11	-25	-23.11
5	400.54	-53.66	-52.19	5.28	-46.91	-25	-21.91
6	476.20	-55.58	-53.97	4.97	-49.00	-25	-24.00

Remarks:

1. Output Power (dBm) = S.G Value (dBm) + Correction Factor (dB).
2. Correction Factor (dB) = Substitution Antenna Gain (dB) + Cable Loss (dB).





Test Mode A: Data rate: 27Mbps

Mode	TX channel 172	Frequency Range	Below 1000 MHz
Environmental Conditions	18deg. C, 70%RH	Input Power	120Vac, 60Hz
Tested By	Nick Hsu		

Antenna Polarity & Test Distance: Horizontal at 3 M

No.	Freq. (MHz)	Reading (dBm)	S.G Power Value (dBm)	Correction Factor (dB)	EIRP (dBm)	Limit (dBm)	Margin (dB)
1	200.72	-49.37	-48.32	5.47	-42.85	-25	-17.85
2	274.44	-52.37	-51.15	5.26	-45.89	-25	-20.89
3	324.88	-53.08	-51.76	5.17	-46.59	-25	-21.59
4	400.54	-49.45	-47.98	5.28	-42.70	-25	-17.70
5	425.76	-53.86	-52.34	5.17	-47.17	-25	-22.17
6	499.48	-56.41	-54.77	4.89	-49.88	-25	-24.88

Antenna Polarity & Test Distance: Vertical at 3 M

No.	Freq. (MHz)	Reading (dBm)	S.G Power Value (dBm)	Correction Factor (dB)	EIRP (dBm)	Limit (dBm)	Margin (dB)
1	64.92	-39.18	-38.59	-6.32	-44.91	-25	-19.91
2	99.84	-48.41	-47.67	0.87	-46.80	-25	-21.80
3	200.72	-48.30	-47.25	5.47	-41.78	-25	-16.78
4	241.46	-54.18	-53.04	5.41	-47.63	-25	-22.63
5	400.54	-52.81	-51.34	5.28	-46.06	-25	-21.06
6	476.20	-55.79	-54.18	4.97	-49.21	-25	-24.21

Remarks:

1. Output Power (dBm) = S.G Value (dBm) + Correction Factor (dB).
2. Correction Factor (dB) = Substitution Antenna Gain (dB) + Cable Loss (dB).

Test Mode B: Data rate: 3Mbps

Mode	TX channel 172	Frequency Range	Below 1000 MHz
Environmental Conditions	18deg. C, 70%RH	Input Power	120Vac, 60Hz
Tested By	Nick Hsu		

Antenna Polarity & Test Distance: Horizontal at 3 M

No.	Freq. (MHz)	Reading (dBm)	S.G Power Value (dBm)	Correction Factor (dB)	EIRP (dBm)	Limit (dBm)	Margin (dB)
1	200.72	-45.33	-44.28	5.47	-38.81	-25	-13.81
2	224.00	-54.18	-53.08	5.44	-47.64	-25	-22.64
3	274.44	-53.36	-52.14	5.26	-46.88	-25	-21.88
4	350.10	-54.41	-53.04	5.21	-47.83	-25	-22.83
5	400.54	-52.30	-50.83	5.28	-45.55	-25	-20.55
6	425.76	-55.17	-53.65	5.17	-48.48	-25	-23.48

Antenna Polarity & Test Distance: Vertical at 3 M

No.	Freq. (MHz)	Reading (dBm)	S.G Power Value (dBm)	Correction Factor (dB)	EIRP (dBm)	Limit (dBm)	Margin (dB)
1	45.52	-33.29	-33.29	-9.97	-43.26	-25	-18.26
2	68.80	-39.70	-39.09	-5.32	-44.41	-25	-19.41
3	101.78	-44.84	-44.09	0.80	-43.29	-25	-18.29
4	198.78	-45.25	-44.20	5.31	-38.89	-25	-13.89
5	350.10	-53.68	-52.31	5.21	-47.10	-25	-22.10
6	400.54	-51.14	-49.67	5.28	-44.39	-25	-19.39

Remarks:

1. Output Power (dBm) = S.G Value (dBm) + Correction Factor (dB).
2. Correction Factor (dB) = Substitution Antenna Gain (dB) + Cable Loss (dB).

Test Mode B: Data rate: 27Mbps

Mode	TX channel 172	Frequency Range	Below 1000 MHz
Environmental Conditions	18deg. C, 70%RH	Input Power	120Vac, 60Hz
Tested By	Nick Hsu		

**Antenna Polarity & Test Distance: Horizontal at 3 M**

No.	Freq. (MHz)	Reading (dBm)	S.G Power Value (dBm)	Correction Factor (dB)	EIRP (dBm)	Limit (dBm)	Margin (dB)
1	200.72	-45.72	-44.67	5.47	-39.20	-25	-14.20
2	225.94	-54.05	-52.95	5.44	-47.51	-25	-22.51
3	274.44	-53.54	-52.32	5.26	-47.06	-25	-22.06
4	350.10	-54.37	-53.00	5.21	-47.79	-25	-22.79
5	425.76	-54.95	-53.43	5.17	-48.26	-25	-23.26
6	499.48	-56.39	-54.75	4.89	-49.86	-25	-24.86

**Antenna Polarity & Test Distance: Vertical at 3 M**

No.	Freq. (MHz)	Reading (dBm)	S.G Power Value (dBm)	Correction Factor (dB)	EIRP (dBm)	Limit (dBm)	Margin (dB)
1	64.92	-40.6	-40.01	-6.32	-46.33	-25	-21.33
2	97.90	-48.80	-48.07	0.93	-47.14	-25	-22.14
3	200.72	-44.15	-43.10	5.47	-37.63	-25	-12.63
4	350.10	-54.13	-52.76	5.21	-47.55	-25	-22.55
5	400.54	-51.41	-49.94	5.28	-44.66	-25	-19.66
6	476.20	-57.94	-56.33	4.97	-51.36	-25	-26.36

Remarks:

1. Output Power (dBm) = S.G Value (dBm) + Correction Factor (dB).
2. Correction Factor (dB) = Substitution Antenna Gain (dB) + Cable Loss (dB).

Above 1GHz

Test Mode A: Data rate: 3Mbps

Mode	TX channel 172	Frequency Range	Above 1000MHz
Environmental Conditions	18deg. C, 70%RH	Input Power	120Vac, 60 Hz
Tested By	Nick Hsu		

**Antenna Polarity & Test Distance: Horizontal at 3 M**

No.	Freq. (MHz)	Reading (dBm)	S.G Power Value (dBm)	Correction Factor (dB)	EIRP (dBm)	Limit (dBm)	Margin (dB)
1	4688.00	-50.93	-45.71	6.72	-38.99	-25	-13.99
2	11720.00	-55.77	-47.20	2.90	-44.30	-25	-19.30

**Antenna Polarity & Test Distance: Vertical at 3 M**

No.	Freq. (MHz)	Reading (dBm)	S.G Power Value (dBm)	Correction Factor (dB)	EIRP (dBm)	Limit (dBm)	Margin (dB)
1	4688.00	-47.10	-41.88	6.72	-35.16	-25	-10.16
2	11720.00	-56.75	-48.18	2.90	-45.28	-25	-20.28

Remarks:

1. Output Power (dBm) = S.G Value (dBm) + Correction Factor (dB).
2. Correction Factor (dB) = Substitution Antenna Gain (dB) + Cable Loss (dB).

Mode	TX channel 178	Frequency Range	Above 1000MHz
Environmental Conditions	18deg. C, 70%RH	Input Power	120Vac, 60 Hz
Tested By	Nick Hsu		

**Antenna Polarity & Test Distance: Horizontal at 3 M**

No.	Freq. (MHz)	Reading (dBm)	S.G Power Value (dBm)	Correction Factor (dB)	EIRP (dBm)	Limit (dBm)	Margin (dB)
1	4712.00	-50.15	-44.91	6.70	-38.21	-25	-13.21
2	11780.00	-60.40	-51.85	3.08	-48.77	-25	-23.77

**Antenna Polarity & Test Distance: Vertical at 3 M**

No.	Freq. (MHz)	Reading (dBm)	S.G Power Value (dBm)	Correction Factor (dB)	EIRP (dBm)	Limit (dBm)	Margin (dB)
1	4712.00	-46.19	-40.95	6.70	-34.25	-25	-9.25
2	11780.00	-60.87	-52.32	3.08	-49.24	-25	-24.24

Remarks:

1. Output Power (dBm) = S.G Value (dBm) + Correction Factor (dB).
2. Correction Factor (dB) = Substitution Antenna Gain (dB) + Cable Loss (dB).

Mode	TX channel 180	Frequency Range	Above 1000MHz
Environmental Conditions	18deg. C, 70%RH	Input Power	120Vac, 60 Hz
Tested By	Nick Hsu		

**Antenna Polarity & Test Distance: Horizontal at 3 M**

No.	Freq. (MHz)	Reading (dBm)	S.G Power Value (dBm)	Correction Factor (dB)	EIRP (dBm)	Limit (dBm)	Margin (dB)
1	4720.00	-53.38	-43.02	6.69	-36.33	-25	-11.33
2	11800.00	-61.63	-34.70	3.13	-31.57	-25	-6.57

**Antenna Polarity & Test Distance: Vertical at 3 M**

No.	Freq. (MHz)	Reading (dBm)	S.G Power Value (dBm)	Correction Factor (dB)	EIRP (dBm)	Limit (dBm)	Margin (dB)
1	4720.00	-50.56	-41.23	6.69	-34.54	-25	-9.54
2	11800.00	-57.68	-31.30	3.13	-28.17	-25	-3.17

**Remarks:**

1. Output Power (dBm) = S.G Value (dBm) + Correction Factor (dB).
2. Correction Factor (dB) = Substitution Antenna Gain (dB) + Cable Loss (dB).

Mode	TX channel 182	Frequency Range	Above 1000MHz
Environmental Conditions	18deg. C, 70%RH	Input Power	120Vac, 60 Hz
Tested By	Nick Hsu		

**Antenna Polarity & Test Distance: Horizontal at 3 M**

No.	Freq. (MHz)	Reading (dBm)	S.G Power Value (dBm)	Correction Factor (dB)	EIRP (dBm)	Limit (dBm)	Margin (dB)
1	4728.00	-53.22	-42.85	6.69	-36.16	-25	-11.16
2	11820.00	-62.55	-35.67	3.15	-32.52	-25	-7.52

**Antenna Polarity & Test Distance: Vertical at 3 M**

No.	Freq. (MHz)	Reading (dBm)	S.G Power Value (dBm)	Correction Factor (dB)	EIRP (dBm)	Limit (dBm)	Margin (dB)
1	4728.00	-51.82	-42.46	6.69	-35.77	-25	-10.77
2	11820.00	-58.19	-31.63	3.15	-28.48	-25	-3.48

**Remarks:**

1. Output Power (dBm) = S.G Value (dBm) + Correction Factor (dB).
2. Correction Factor (dB) = Substitution Antenna Gain (dB) + Cable Loss (dB).

Mode	TX channel 184	Frequency Range	Above 1000MHz
Environmental Conditions	18deg. C, 70%RH	Input Power	120Vac, 60 Hz
Tested By	Nick Hsu		

**Antenna Polarity & Test Distance: Horizontal at 3 M**

No.	Freq. (MHz)	Reading (dBm)	S.G Power Value (dBm)	Correction Factor (dB)	EIRP (dBm)	Limit (dBm)	Margin (dB)
1	4736.00	-51.69	-46.42	6.68	-39.74	-25	-14.74
2	11840.00	-59.17	-50.56	3.17	-47.39	-25	-22.39

**Antenna Polarity & Test Distance: Vertical at 3 M**

No.	Freq. (MHz)	Reading (dBm)	S.G Power Value (dBm)	Correction Factor (dB)	EIRP (dBm)	Limit (dBm)	Margin (dB)
1	4736.00	-47.45	-42.18	6.68	-35.50	-25	-10.50
2	11840.00	-56.67	-48.06	3.17	-44.89	-25	-19.89

**Remarks:**

1. Output Power (dBm) = S.G Value (dBm) + Correction Factor (dB).
2. Correction Factor (dB) = Substitution Antenna Gain (dB) + Cable Loss (dB).

Test Mode A: Data rate: 27Mbps

Mode	TX channel 172	Frequency Range	Above 1000MHz
Environmental Conditions	18deg. C, 70%RH	Input Power	120Vac, 60 Hz
Tested By	Nick Hsu		

**Antenna Polarity & Test Distance: Horizontal at 3 M**

No.	Freq. (MHz)	Reading (dBm)	S.G Power Value (dBm)	Correction Factor (dB)	EIRP (dBm)	Limit (dBm)	Margin (dB)
1	4688.00	-52.46	-47.24	6.72	-40.52	-25	-15.52
2	11720.00	-56.87	-48.30	2.90	-45.40	-25	-20.40

**Antenna Polarity & Test Distance: Vertical at 3 M**

No.	Freq. (MHz)	Reading (dBm)	S.G Power Value (dBm)	Correction Factor (dB)	EIRP (dBm)	Limit (dBm)	Margin (dB)
1	4688.00	-49.46	-44.24	6.72	-37.52	-25	-12.52
2	11720.00	-55.48	-46.91	2.90	-44.01	-25	-19.01

Remarks:

1. Output Power (dBm) = S.G Value (dBm) + Correction Factor (dB).
2. Correction Factor (dB) = Substitution Antenna Gain (dB) + Cable Loss (dB).

Mode	TX channel 178	Frequency Range	Above 1000MHz
Environmental Conditions	18deg. C, 70%RH	Input Power	120Vac, 60 Hz
Tested By	Nick Hsu		

**Antenna Polarity & Test Distance: Horizontal at 3 M**

No.	Freq. (MHz)	Reading (dBm)	S.G Power Value (dBm)	Correction Factor (dB)	EIRP (dBm)	Limit (dBm)	Margin (dB)
1	4712.00	-55.73	-50.49	6.70	-43.79	-25	-18.79
2	11780.00	-58.58	-50.03	3.08	-46.95	-25	-21.95

**Antenna Polarity & Test Distance: Vertical at 3 M**

No.	Freq. (MHz)	Reading (dBm)	S.G Power Value (dBm)	Correction Factor (dB)	EIRP (dBm)	Limit (dBm)	Margin (dB)
1	4712.00	-50.07	-44.83	6.70	-38.13	-25	-13.13
2	11780.00	-58.74	-50.19	3.08	-47.11	-25	-22.11

Remarks:

1. Output Power (dBm) = S.G Value (dBm) + Correction Factor (dB).
2. Correction Factor (dB) = Substitution Antenna Gain (dB) + Cable Loss (dB).

Mode	TX channel 180	Frequency Range	Above 1000MHz
Environmental Conditions	18deg. C, 70%RH	Input Power	120Vac, 60 Hz
Tested By	Nick Hsu		

**Antenna Polarity & Test Distance: Horizontal at 3 M**

No.	Freq. (MHz)	Reading (dBm)	S.G Power Value (dBm)	Correction Factor (dB)	EIRP (dBm)	Limit (dBm)	Margin (dB)
1	4720.00	-53.46	-43.10	6.69	-36.41	-25	-11.41
2	11800.00	-63.54	-36.61	3.13	-33.48	-25	-8.48

**Antenna Polarity & Test Distance: Vertical at 3 M**

No.	Freq. (MHz)	Reading (dBm)	S.G Power Value (dBm)	Correction Factor (dB)	EIRP (dBm)	Limit (dBm)	Margin (dB)
1	4720.00	-51.93	-42.60	6.69	-35.91	-25	-10.91
2	11800.00	-58.87	-32.49	3.13	-29.36	-25	-4.36

**Remarks:**

1. Output Power (dBm) = S.G Value (dBm) + Correction Factor (dB).
2. Correction Factor (dB) = Substitution Antenna Gain (dB) + Cable Loss (dB).

Mode	TX channel 182	Frequency Range	Above 1000MHz
Environmental Conditions	18deg. C, 70%RH	Input Power	120Vac, 60 Hz
Tested By	Nick Hsu		

**Antenna Polarity & Test Distance: Horizontal at 3 M**

No.	Freq. (MHz)	Reading (dBm)	S.G Power Value (dBm)	Correction Factor (dB)	EIRP (dBm)	Limit (dBm)	Margin (dB)
1	4728.00	-53.13	-42.76	6.69	-36.07	-25	-11.07
2	11820.00	-62.92	-36.04	3.15	-32.89	-25	-7.89

**Antenna Polarity & Test Distance: Vertical at 3 M**

No.	Freq. (MHz)	Reading (dBm)	S.G Power Value (dBm)	Correction Factor (dB)	EIRP (dBm)	Limit (dBm)	Margin (dB)
1	4728.00	-50.79	-41.43	6.69	-34.74	-25	-9.74
2	11820.00	-59.53	-32.97	3.15	-29.82	-25	-4.82

**Remarks:**

1. Output Power (dBm) = S.G Value (dBm) + Correction Factor (dB).
2. Correction Factor (dB) = Substitution Antenna Gain (dB) + Cable Loss (dB).





Mode	TX channel 184	Frequency Range	Above 1000MHz
Environmental Conditions	18deg. C, 70%RH	Input Power	120Vac, 60 Hz
Tested By	Nick Hsu		

Antenna Polarity & Test Distance: Horizontal at 3 M

No.	Freq. (MHz)	Reading (dBm)	S.G Power Value (dBm)	Correction Factor (dB)	EIRP (dBm)	Limit (dBm)	Margin (dB)
1	4736.00	-54.15	-48.88	6.68	-42.20	-25	-17.20
2	11840.00	-57.61	-49.00	3.17	-45.83	-25	-20.83

Antenna Polarity & Test Distance: Vertical at 3 M

No.	Freq. (MHz)	Reading (dBm)	S.G Power Value (dBm)	Correction Factor (dB)	EIRP (dBm)	Limit (dBm)	Margin (dB)
1	4736.00	-50.53	-45.26	6.68	-38.58	-25	-13.58
2	11840.00	-56.65	-48.04	3.17	-44.87	-25	-19.87

Remarks:

1. Output Power (dBm) = S.G Value (dBm) + Correction Factor (dB).
2. Correction Factor (dB) = Substitution Antenna Gain (dB) + Cable Loss (dB).

Test Mode B: Data rate: 3Mbps

Mode	TX channel 172	Frequency Range	Above 1000MHz
Environmental Conditions	18deg. C, 70%RH	Input Power	120Vac, 60 Hz
Tested By	Nick Hsu		

**Antenna Polarity & Test Distance: Horizontal at 3 M**

No.	Freq. (MHz)	Reading (dBm)	S.G Power Value (dBm)	Correction Factor (dB)	EIRP (dBm)	Limit (dBm)	Margin (dB)
1	4688.00	-54.63	-49.41	6.72	-42.69	-25	-17.69
2	11720.00	-59.52	-50.95	2.90	-48.05	-25	-23.05

**Antenna Polarity & Test Distance: Vertical at 3 M**

No.	Freq. (MHz)	Reading (dBm)	S.G Power Value (dBm)	Correction Factor (dB)	EIRP (dBm)	Limit (dBm)	Margin (dB)
1	4688.00	-50.89	-45.67	6.72	-38.95	-25	-13.95
2	11720.00	-54.78	-46.21	2.90	-43.31	-25	-18.31

Remarks:

1. Output Power (dBm) = S.G Value (dBm) + Correction Factor (dB).
2. Correction Factor (dB) = Substitution Antenna Gain (dB) + Cable Loss (dB).

Mode	TX channel 178	Frequency Range	Above 1000MHz
Environmental Conditions	18deg. C, 70%RH	Input Power	120Vac, 60 Hz
Tested By	Nick Hsu		

**Antenna Polarity & Test Distance: Horizontal at 3 M**

No.	Freq. (MHz)	Reading (dBm)	S.G Power Value (dBm)	Correction Factor (dB)	EIRP (dBm)	Limit (dBm)	Margin (dB)
1	4712.00	-52.12	-46.88	6.70	-40.18	-25	-15.18
2	11780.00	-59.41	-50.86	3.08	-47.78	-25	-22.78

**Antenna Polarity & Test Distance: Vertical at 3 M**

No.	Freq. (MHz)	Reading (dBm)	S.G Power Value (dBm)	Correction Factor (dB)	EIRP (dBm)	Limit (dBm)	Margin (dB)
1	4712.00	-49.82	-44.58	6.70	-37.88	-25	-12.88
2	11780.00	-55.62	-47.07	3.08	-43.99	-25	-18.99

Remarks:

1. Output Power (dBm) = S.G Value (dBm) + Correction Factor (dB).
2. Correction Factor (dB) = Substitution Antenna Gain (dB) + Cable Loss (dB).

Mode	TX channel 180	Frequency Range	Above 1000MHz
Environmental Conditions	18deg. C, 70%RH	Input Power	120Vac, 60 Hz
Tested By	Nick Hsu		

**Antenna Polarity & Test Distance: Horizontal at 3 M**

No.	Freq. (MHz)	Reading (dBm)	S.G Power Value (dBm)	Correction Factor (dB)	EIRP (dBm)	Limit (dBm)	Margin (dB)
1	4720.00	-54.21	-43.85	6.69	-37.16	-25	-12.16
2	11800.00	-60.53	-33.6	3.13	-30.47	-25	-5.47

**Antenna Polarity & Test Distance: Vertical at 3 M**

No.	Freq. (MHz)	Reading (dBm)	S.G Power Value (dBm)	Correction Factor (dB)	EIRP (dBm)	Limit (dBm)	Margin (dB)
1	4720.00	-50.67	-41.34	6.69	-34.65	-25	-9.65
2	<b>11800.00</b>	<b>-56.99</b>	<b>-30.61</b>	<b>3.13</b>	<b>-27.48</b>	<b>-25</b>	<b>-2.48</b>

Remarks:

1. Output Power (dBm) = S.G Value (dBm) + Correction Factor (dB).
2. Correction Factor (dB) = Substitution Antenna Gain (dB) + Cable Loss (dB).

Mode	TX channel 182	Frequency Range	Above 1000MHz
Environmental Conditions	18deg. C, 70%RH	Input Power	120Vac, 60 Hz
Tested By	Nick Hsu		

**Antenna Polarity & Test Distance: Horizontal at 3 M**

No.	Freq. (MHz)	Reading (dBm)	S.G Power Value (dBm)	Correction Factor (dB)	EIRP (dBm)	Limit (dBm)	Margin (dB)
1	4728.00	-53.86	-43.49	6.69	-36.80	-25	-11.80
2	11820.00	-62.54	-35.66	3.15	-32.51	-25	-7.51

**Antenna Polarity & Test Distance: Vertical at 3 M**

No.	Freq. (MHz)	Reading (dBm)	S.G Power Value (dBm)	Correction Factor (dB)	EIRP (dBm)	Limit (dBm)	Margin (dB)
1	4728.00	-51.83	-42.47	6.69	-35.78	-25	-10.78
2	11820.00	-58.81	-32.25	3.15	-29.10	-25	-4.10

Remarks:

1. Output Power (dBm) = S.G Value (dBm) + Correction Factor (dB).
2. Correction Factor (dB) = Substitution Antenna Gain (dB) + Cable Loss (dB).

Mode	TX channel 184	Frequency Range	Above 1000MHz
Environmental Conditions	18deg. C, 70%RH	Input Power	120Vac, 60 Hz
Tested By	Nick Hsu		

**Antenna Polarity & Test Distance: Horizontal at 3 M**

No.	Freq. (MHz)	Reading (dBm)	S.G Power Value (dBm)	Correction Factor (dB)	EIRP (dBm)	Limit (dBm)	Margin (dB)
1	4736.00	-52.26	-46.99	6.68	-40.31	-25	-15.31
2	11840.00	-58.3	-49.69	3.17	-46.52	-25	-21.52

**Antenna Polarity & Test Distance: Vertical at 3 M**

No.	Freq. (MHz)	Reading (dBm)	S.G Power Value (dBm)	Correction Factor (dB)	EIRP (dBm)	Limit (dBm)	Margin (dB)
1	4736.00	-47.57	-42.3	6.68	-35.62	-25	-10.62
2	11840.00	-53.5	-44.89	3.17	-41.72	-25	-16.72

**Remarks:**

1. Output Power (dBm) = S.G Value (dBm) + Correction Factor (dB).
2. Correction Factor (dB) = Substitution Antenna Gain (dB) + Cable Loss (dB).

Test Mode B: Data rate: 27Mbps

Mode	TX channel 172	Frequency Range	Above 1000MHz
Environmental Conditions	18deg. C, 70%RH	Input Power	120Vac, 60 Hz
Tested By	Nick Hsu		

**Antenna Polarity & Test Distance: Horizontal at 3 M**

No.	Freq. (MHz)	Reading (dBm)	S.G Power Value (dBm)	Correction Factor (dB)	EIRP (dBm)	Limit (dBm)	Margin (dB)
1	4688.00	-53.73	-48.51	6.72	-41.79	-25	-16.79
2	11720.00	-60.47	-51.90	2.90	-49.00	-25	-24.00

**Antenna Polarity & Test Distance: Vertical at 3 M**

No.	Freq. (MHz)	Reading (dBm)	S.G Power Value (dBm)	Correction Factor (dB)	EIRP (dBm)	Limit (dBm)	Margin (dB)
1	4688.00	-51.29	-46.07	6.72	-39.35	-25	-14.35
2	11720.00	-56.47	-47.90	2.90	-45.00	-25	-20.00

Remarks:

1. Output Power (dBm) = S.G Value (dBm) + Correction Factor (dB).
2. Correction Factor (dB) = Substitution Antenna Gain (dB) + Cable Loss (dB).

Mode	TX channel 178	Frequency Range	Above 1000MHz
Environmental Conditions	18deg. C, 70%RH	Input Power	120Vac, 60 Hz
Tested By	Nick Hsu		

**Antenna Polarity & Test Distance: Horizontal at 3 M**

No.	Freq. (MHz)	Reading (dBm)	S.G Power Value (dBm)	Correction Factor (dB)	EIRP (dBm)	Limit (dBm)	Margin (dB)
1	4712.00	-50.25	-45.01	6.70	-38.31	-25.00	-13.31
2	11780.00	-60.96	-52.41	3.08	-49.33	-25.00	-24.33

**Antenna Polarity & Test Distance: Vertical at 3 M**

No.	Freq. (MHz)	Reading (dBm)	S.G Power Value (dBm)	Correction Factor (dB)	EIRP (dBm)	Limit (dBm)	Margin (dB)
1	4712.00	-50.02	-44.78	6.70	-38.08	-25.00	-13.08
2	11780.00	-56.21	-47.66	3.08	-44.58	-25.00	-19.58

Remarks:

1. Output Power (dBm) = S.G Value (dBm) + Correction Factor (dB).
2. Correction Factor (dB) = Substitution Antenna Gain (dB) + Cable Loss (dB).

Mode	TX channel 180	Frequency Range	Above 1000MHz
Environmental Conditions	18deg. C, 70%RH	Input Power	120Vac, 60 Hz
Tested By	Nick Hsu		

Antenna Polarity & Test Distance: Horizontal at 3 M							
No.	Freq. (MHz)	Reading (dBm)	S.G Power Value (dBm)	Correction Factor (dB)	EIRP (dBm)	Limit (dBm)	Margin (dB)
1	4720.00	-53.07	-42.71	6.69	-36.02	-25	-11.02
2	11800.00	-62.02	-35.09	3.13	-31.96	-25	-6.96
Antenna Polarity & Test Distance: Vertical at 3 M							
No.	Freq. (MHz)	Reading (dBm)	S.G Power Value (dBm)	Correction Factor (dB)	EIRP (dBm)	Limit (dBm)	Margin (dB)
1	4720.00	-50.25	-40.92	6.69	-34.23	-25	-9.23
2	11800.00	-57.62	-31.24	3.13	-28.11	-25	-3.11

Remarks:

1. Output Power (dBm) = S.G Value (dBm) + Correction Factor (dB).
2. Correction Factor (dB) = Substitution Antenna Gain (dB) + Cable Loss (dB).

Mode	TX channel 182	Frequency Range	Above 1000MHz
Environmental Conditions	18deg. C, 70%RH	Input Power	120Vac, 60 Hz
Tested By	Nick Hsu		

Antenna Polarity & Test Distance: Horizontal at 3 M							
No.	Freq. (MHz)	Reading (dBm)	S.G Power Value (dBm)	Correction Factor (dB)	EIRP (dBm)	Limit (dBm)	Margin (dB)
1	4728.00	-53.45	-43.08	6.69	-36.39	-25	-11.39
2	11820.00	-62.13	-35.25	3.15	-32.10	-25	-7.10
Antenna Polarity & Test Distance: Vertical at 3 M							
No.	Freq. (MHz)	Reading (dBm)	S.G Power Value (dBm)	Correction Factor (dB)	EIRP (dBm)	Limit (dBm)	Margin (dB)
1	4728.00	-51.18	-41.82	6.69	-35.13	-25	-10.13
2	11820.00	-58.33	-31.77	3.15	-28.62	-25	-3.62

Remarks:

1. Output Power (dBm) = S.G Value (dBm) + Correction Factor (dB).
2. Correction Factor (dB) = Substitution Antenna Gain (dB) + Cable Loss (dB).



Mode	TX channel 184	Frequency Range	Above 1000MHz
Environmental Conditions	18deg. C, 70%RH	Input Power	120Vac, 60 Hz
Tested By	Nick Hsu		

**Antenna Polarity & Test Distance: Horizontal at 3 M**

No.	Freq. (MHz)	Reading (dBm)	S.G Power Value (dBm)	Correction Factor (dB)	EIRP (dBm)	Limit (dBm)	Margin (dB)
1	4736.00	-52.98	-47.71	6.68	-41.03	-25.00	-16.03
2	11840.00	-58.00	-49.39	3.17	-46.22	-25.00	-21.22

**Antenna Polarity & Test Distance: Vertical at 3 M**

No.	Freq. (MHz)	Reading (dBm)	S.G Power Value (dBm)	Correction Factor (dB)	EIRP (dBm)	Limit (dBm)	Margin (dB)
1	4736.00	-48.9	-43.63	6.68	-36.95	-25.00	-11.95
2	11840.00	-54.97	-46.36	3.17	-43.19	-25.00	-18.19

## Remarks:

1. Output Power (dBm) = S.G Value (dBm) + Correction Factor (dB).
2. Correction Factor (dB) = Substitution Antenna Gain (dB) + Cable Loss (dB).

## 5 Pictures of Test Arrangements

Please refer to the attached file (Test Setup Photo).





## Appendix – Information on the Testing Laboratories

We, Bureau Veritas Consumer Products Services (H.K.) Ltd., Taoyuan Branch, were founded in 1988 to provide our best service in EMC, Radio, Telecom and Safety consultation. Our laboratories are accredited and approved according to ISO/IEC 17025.

If you have any comments, please feel free to contact us at the following:

**Linko EMC/RF Lab**

Tel: 886-2-26052180

Fax: 886-2-26051924

**Hsin Chu EMC/RF Lab/Telecom Lab**

Tel: 886-3-5935343

Fax: 886-3-5935342

**Hwa Ya EMC/RF/Safety**

Tel: 886-3-3183232

Fax: 886-3-3270892

**Email:** [service.adt@tw.bureauveritas.com](mailto:service.adt@tw.bureauveritas.com)

**Web Site:** [www.bureauveritas-adt.com](http://www.bureauveritas-adt.com)

The address and road map of all our labs can be found in our web site also.

--- END ---