



FCC RADIO TEST REPORT

FCC ID:2AEFF-M001U

Product : USB Dongle

Trade Name : TECKNET

Model Name : M001

Serial Model : N/A

Report No. : NTEK-2015NT0724364F1

Prepared for

SHENZHEN UNICHAIN TECHNOLOGY CO.,LTD.

5/F, Block17, Lishan Industrial Park, Nanshan District, Shenzhen,China.

Prepared by

Shenzhen NTEK Testing Technology Co., Ltd.

1/F, Building E, Fenda Science Park, Sanwei Community,Xixiang Street

Bao'an District, Shenzhen P.R. China

Tel.: +86-0755-61156588 Fax.: +86-0755-61156599

Website:www.ntek.org.cn

TEST RESULT CERTIFICATION

Applicant's name : SHENZHEN UNICHAIN TECHNOLOGY CO.,LTD.
Address : 5/F, Block17, Lishan Industrial Park, Nanshan District, Shenzhen,China.
Manufacture's Name..... : Eastern Times Technology Co.LTD.
Address : Building D,Nan An Industrial Area, Youganpu Village,Fenggang Town, Dongguan City,Guangdong, China

Product description

Product name : USB Dongle
Model and/or type reference : M001
Serial Model : N/A
Rating(s)..... : DC 5.0V

Standards : FCC Part15.249 01 Oct. 2014

Test procedure ANSI C63.10-2013

This device described above has been tested by NTEK, and the test results show that the equipment under test (EUT) is in compliance with the FCC requirements. And it is applicable only to the tested sample identified in the report.

This report shall not be reproduced except in full, without the written approval of NTEK, this document may be altered or revised by NTEK, personnel only, and shall be noted in the revision of the document.

Date of Test :
Date (s) of performance of tests : 24 Jul. 2015 ~02 Sep. 2015
Date of Issue..... : 02 Sep. 2015
Test Result..... : **Pass**

Testing Engineer : Eileen Liu.
(Eileen Liu)

Technical Manager : Brown Lu
(Brown Lu)

Authorized Signatory : Sam. Chen
(Sam Chen)

Table of Contents	Page
1 . SUMMARY OF TEST RESULTS	4
1.1 TEST FACILITY	5
1.2 MEASUREMENT UNCERTAINTY	5
2 . GENERAL INFORMATION	6
2.1 GENERAL DESCRIPTION OF EUT	6
2.2 DESCRIPTION OF TEST MODES	8
2.3 BLOCK DIGRAM SHOWING THE CONFIGURATION OF SYSTEM TESTED	9
2.4 DESCRIPTION OF SUPPORT UNITS(CONDUCTED MODE)	10
2.5 EQUIPMENTS LIST FOR ALL TEST ITEMS	11
3 . ANTENNA REQUIREMENT	12
3.1 STANDARD REQUIREMENT	12
3.2 EUT ANTENNA	12
3.3 CONDUCTED EMISSION MEASUREMENT	13
3.3.1 POWER LINE CONDUCTED EMISSION LIMITS	13
3.3.2 TEST PROCEDURE	14
3.3.3 DEVIATION FROM TEST STANDARD	14
3.3.4 TEST SETUP	14
3.2.5 TEST RESULT	15
3.4 RADIATED EMISSION MEASUREMENT	19
3.4.1 RADIATED EMISSION LIMITS	19
3.4.2 TEST PROCEDURE	20
3.4.3 DEVIATION FROM TEST STANDARD	20
3.4.4 TEST SETUP	21
3.4.5 TEST RESULTS (BLOW 30MHZ)	23
3.4.6 TEST RESULTS (BETWEEN 30 – 1000 MHZ)	24
3.4.7 TEST RESULTS (ABOVE 1000 MHZ)	26
3.4.8 TEST RESULTS (RESTRICTED BANDS REQUIREMENTS)	32
4 . BANDWIDTH TEST	36
4.1 TEST PROCEDURE	36
4.2 DEVIATION FROM STANDARD	36
4.3 TEST SETUP	36
4.4 TEST RESULTS	37
5 . EUT TEST PHOTO	39
APPENDIX-PHOTOGRAPHS OF EUT CONSTRUCTIONAL DETAILS	

1. SUMMARY OF TEST RESULTS

Test procedures according to the technical standards:

FCC Part15, Subpart C (15.249)			
Standard Section	Test Item	Judgment	Remark
15.207	Conducted Emission	Pass	
15.203	Antenna Requirement	Pass	
15.249	Radiated Spurious Emission	Pass	
15.205	Band Edge Emission	Pass	
15.249	Occupied Bandwidth	Pass	

1.1 TEST FACILITY

NTEK Testing Technology Co., Ltd

Add. : 1/F, Building E, Fenda Science Park, Sanwei Community, Xixiang Street, Bao'an District, Shenzhen P.R. China.

FCC FRN Registration No.:238937; IC Registration No.:9270A-1

CNAS Registration No.:L5516

1.2 MEASUREMENT UNCERTAINTY

The reported uncertainty of measurement $y \pm U$, where expanded uncertainty U is based on a standard uncertainty multiplied by a coverage factor of $k=2$, providing a level of confidence of approximately 95 %.

No.	Item	Uncertainty
1	Conducted Emission Test	$\pm 1.38\text{dB}$
2	RF power,conducted	$\pm 0.16\text{dB}$
3	Spurious emissions,conducted	$\pm 0.21\text{dB}$
4	All emissions,radiated(<1G)	$\pm 4.68\text{dB}$
5	All emissions,radiated(>1G)	$\pm 4.89\text{dB}$
6	Temperature	$\pm 0.5^{\circ}\text{C}$
7	Humidity	$\pm 2\%$

2. GENERAL INFORMATION

2.1 GENERAL DESCRIPTION OF EUT

Equipment	USB Dongle
Trade Name	TECKNET
Model Name	M001
Serial Model	N/A
Model Difference	N/A
Product Description	The EUT is a USB Dongle
	Operation Frequency: 2408-2474MHz
	Modulation Type: FSK
	Antenna Designation: PCB Antenna
	Antenna Gain(Peak) 1.0 dBi
Based on the application, features, or specification exhibited in User's Manual, the EUT is considered as an ITE/Computing Device. More details of EUT technical specification, please refer to the User's Manual.	
Channel List	Please refer to the Note 2.
Adapter	N/A
Battery	N/A

Note:

1. For a more detailed features description, please refer to the manufacturer's specifications or the User's Manual.

2.

Channel	Frequency (MHz)	Channel	Frequency (MHz)
01	2408	18	2442
02	2410	19	2444
03	2412	20	2446
04	2414	21	2448
05	2416	22	2450
06	2418	23	2452
07	2420	24	2454
08	2422	25	2456
09	2424	26	2458
10	2426	27	2460
11	2428	28	2462
12	2430	29	2464
13	2432	30	2466
14	2434	31	2468
15	2436	32	2470
16	2438	33	2472
17	2440	34	2474

3.

Table for Filed Antenna

Ant	Brand	Model Name	Antenna Type	Connector	Gain (dBi)	NOTE
1	N/A	N/A	PCB Antenna	N/A	1.0	Antenna

2.2 DESCRIPTION OF TEST MODES

To investigate the maximum EMI emission characteristics generates from EUT, the test system was pre-scanning tested base on the consideration of following EUT operation mode or test configuration mode which possible have effect on EMI emission level. Each of these EUT operation mode(s) or test configuration mode(s) mentioned above was evaluated respectively.

Pretest Mode	Description
Mode 1	CH 01
Mode 2	CH 17
Mode 3	CH 34
Mode 4	Link Mode

For Conducted Emission	
Final Test Mode	Description
Mode 4	Link Mode

For Radiated Emission	
Final Test Mode	Description
Mode 1	CH 01
Mode 2	CH 17
Mode 3	CH 34

Note:

- (1) The measurements are performed at the highest, middle, lowest available channels.
- (2) The EUT use new battery.

2.3 BLOCK DIGRAM SHOWING THE CONFIGURATION OF SYSTEM TESTED

E-1 EUT	E-2 Notebook
------------	-----------------

2.4 DESCRIPTION OF SUPPORT UNITS(CONDUCTED MODE)

The EUT has been tested as an independent unit together with other necessary accessories or support units. The following support units or accessories were used to form a representative test configuration during the tests.

Item	Equipment	Mfr/Brand	Model/Type No.	Series No.	Note
E-1	USB Dongle	TECKNET	M001	N/A	EUT
E-2	Notebook	Lenove	Thinkpad Edge E430	N/A	

Item	Shielded Type	Ferrite Core	Length	Note

Note:

- (1) The support equipment was authorized by Declaration of Confirmation.
- (2) For detachable type I/O cable should be specified the length in cm in 『Length』 column.

2.5 EQUIPMENTS LIST FOR ALL TEST ITEMS

Radiation Test equipment

Item	Kind of Equipment	Manufacturer	Type No.	Serial No.	Calibrated until
1	Spectrum Analyzer	Agilent	E4407B	160400005	Jul. 06. 2016
2	Test Receiver	R&S	ESPI	101318	Jul. 06. 2016
3	Bilog Antenna	TESEQ	CBL6111D	31216	Jul. 06. 2016
4	50Ω Coaxial Switch	Anritsu	MP59B	6200264416	Jul. 06. 2016
5	Spectrum Analyzer	ADVANTEST	R3132	150900201	Jul. 06. 2016
6	Horn Antenna	EM	EM-AH-10180	2011071402	Jul. 06. 2016
7	Horn Ant	Schwarzbeck	BBHA 9170	9170-181	Jul. 06. 2016
8	Amplifier	EM	EM-30180	060538	Jul. 06. 2016
9	Loop Antenna	ARA	PLA-1030/B	1029	Jul. 06. 2016
10	Power Meter	R&S	NRVS	100696	Jul. 06. 2016

Conduction Test equipment

Item	Kind of Equipment	Manufacturer	Type No.	Serial No.	Calibrated until
1	Test Receiver	R&S	ESCI	101160	Jul. 06. 2016
2	LISN	R&S	ENV216	101313	Jul. 06. 2016
3	LISN	EMCO	3816/2	00042990	Jul. 06. 2016
4	50Ω Coaxial Switch	Anritsu	MP59B	6200264417	Jul. 06. 2016
5	Passive Voltage Probe	R&S	ESH2-Z3	100196	Jul. 06. 2016
6	Absorbing clamp	R&S	MOS-21	100423	Jul. 06. 2016

3. ANTENNA REQUIREMENT

3.1 STANDARD REQUIREMENT

15.203 requirement: For intentional device, according to 15.203: an intentional radiator shall be designed to ensure that no antenna other than that furnished by the responsible party shall be used with the device.

3.2 EUT ANTENNA

The EUT antenna is permanent attached antenna. It comply with the standard requirement.

3.3 CONDUCTED EMISSION MEASUREMENT

3.3.1 POWER LINE CONDUCTED EMISSION Limits (Frequency Range 150KHz-30MHz)

FREQUENCY (MHz)	Class A (dBuV)		Class B (dBuV)		Standard
	Quasi-peak	Average	Quasi-peak	Average	
0.15 -0.5			66 - 56 *	56 - 46 *	CISPR
0.50 -5.0			56.00	46.00	CISPR
5.0 -30.0			60.00	50.00	CISPR

0.15 -0.5			66 - 56 *	56 - 46 *	LP002.
0.50 -5.0			56.00	46.00	LP002.
5.0 -30.0			60.00	50.00	LP002.

Note:

- (1) The tighter limit applies at the band edges.
- (2) The limit of " * " marked band means the limitation decreases linearly with the logarithm of the frequency in the range.

The following table is the setting of the receiver

Receiver Parameters	Setting
Attenuation	10 dB
Start Frequency	0.15 MHz
Stop Frequency	30 MHz
IF Bandwidth	9 kHz

3.3.2 TEST PROCEDURE

- a. The EUT was placed 0.4 meters from the horizontal ground plane with EUT being connected to the power mains through a line impedance stabilization network (LISN). All other support equipments powered from additional LISN(s). The LISN provide 50 Ohm/ 50uH of coupling impedance for the measuring instrument.
- b. Interconnecting cables that hang closer than 40 cm to the ground plane shall be folded back and forth in the center forming a bundle 30 to 40 cm long.
- c. I/O cables that are not connected to a peripheral shall be bundled in the center. The end of the cable may be terminated, if required, using the correct terminating impedance. The overall length shall not exceed 1 m.
- d. LISN at least 80 cm from nearest part of EUT chassis.
- e. For the actual test configuration, please refer to the related Item –EUT Test Photos.

3.3.3 DEVIATION FROM TEST STANDARD

No deviation

3.3.4 TEST SETUP

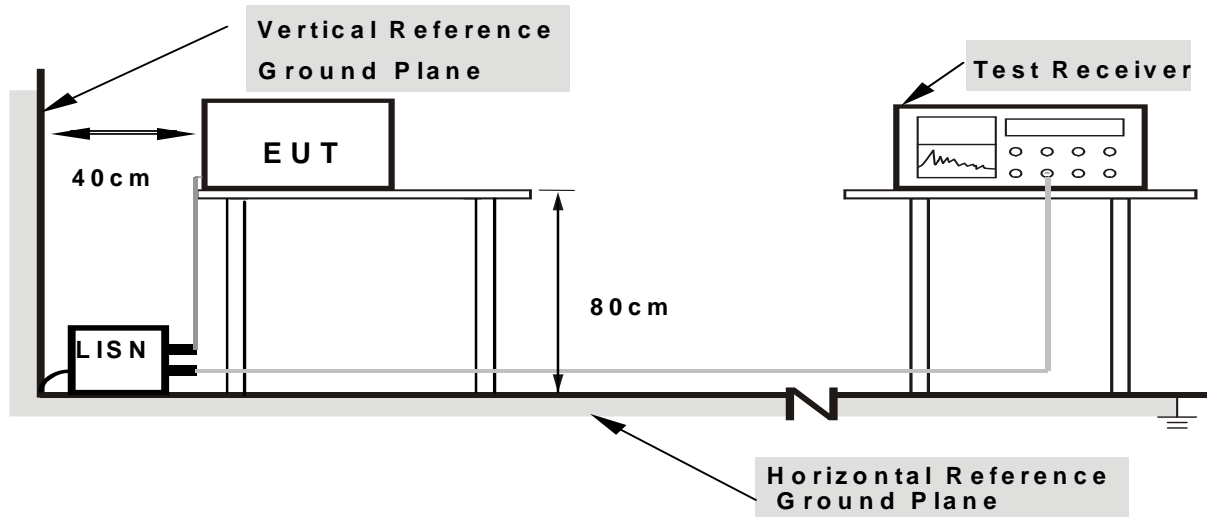

Note: 1. Support units were connected to second LISN.

2. Both of LISNs (AMN) are 80 cm from EUT and at least 80 cm from other units and other metal planes

3.2.5 TEST RESULT

EUT :	USB Dongle	Model Name. :	M001
Temperature :	26 °C	Relative Humidity :	54%
Pressure :	1010hPa	Phase :	L
Test Voltage :	DC 5.0V form PC AC 120V/60Hz	Test Mode :	Mode 4

Frequency (MHz)	Reading Level (dBμV)	Correct Factor (dB)	Measure-ment (dBμV)	Limits (dBμV)	Margin (dB)	Remark
0.1700	29.52	9.62	39.14	64.96	-25.82	QP
0.1700	18.66	9.62	28.28	54.96	-26.68	AVG
0.2300	27.04	9.65	36.69	62.45	-25.76	QP
0.2300	17.64	9.65	27.29	52.45	-25.16	AVG
0.3339	25.85	9.61	35.46	59.35	-23.89	QP
0.3339	15.42	9.61	25.03	49.35	-24.32	AVG
0.5540	27.87	9.78	37.65	56.00	-18.35	QP
0.5540	20.74	9.78	30.52	46.00	-15.48	AVG
1.6420	19.25	9.68	28.93	56.00	-27.07	QP
1.6420	11.15	9.68	20.83	46.00	-25.17	AVG
21.4740	35.22	9.95	45.17	60.00	-14.83	QP
21.4740	24.33	9.95	34.28	50.00	-15.72	AVG

Remark:

1. All readings are Quasi-Peak and Average values.
2. Factor = Insertion Loss + Cable Loss.

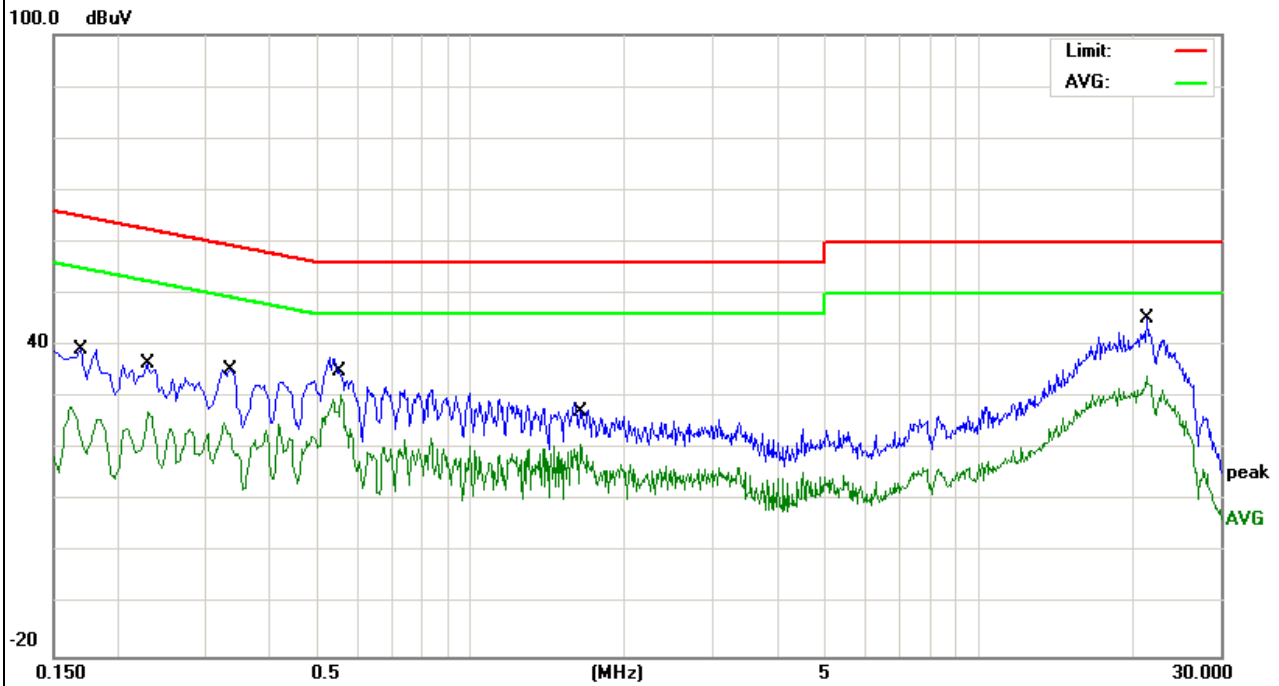

EUT :	USB Dongle	Model Name. :	M001
Temperature :	26 °C	Relative Humidity :	54%
Pressure :	1010hPa	Phase :	N
Test Voltage :	DC 5.0V form PC AC 120V/60Hz	Test Mode :	Mode 4

Frequency	Reading Level	Correct Factor	Measure-ment	Limits	Margin	Remark
(MHz)	(dBμV)	(dB)	(dBμV)	(dBμV)	(dB)	
0.1700	34.22	9.61	43.83	64.96	-21.13	QP
0.1700	19.31	9.61	28.92	54.96	-26.04	AVG
0.2300	27.68	9.61	37.29	62.45	-25.16	QP
0.2300	17.38	9.61	26.99	52.45	-25.46	AVG
0.3300	25.39	9.62	35.01	59.45	-24.44	QP
0.3300	14.62	9.62	24.24	49.45	-25.21	AVG
0.5340	26.35	9.67	36.02	56.00	-19.98	QP
0.5340	19.54	9.67	29.21	46.00	-16.79	AVG
1.6660	20.03	9.56	29.59	56.00	-26.41	QP
1.6660	14.44	9.56	24.00	46.00	-22.00	AVG
21.3620	33.66	9.86	43.52	60.00	-16.48	QP
21.3620	22.91	9.86	32.77	50.00	-17.23	AVG

Remark:

1. All readings are Quasi-Peak and Average values.
2. Factor = Insertion Loss + Cable Loss.

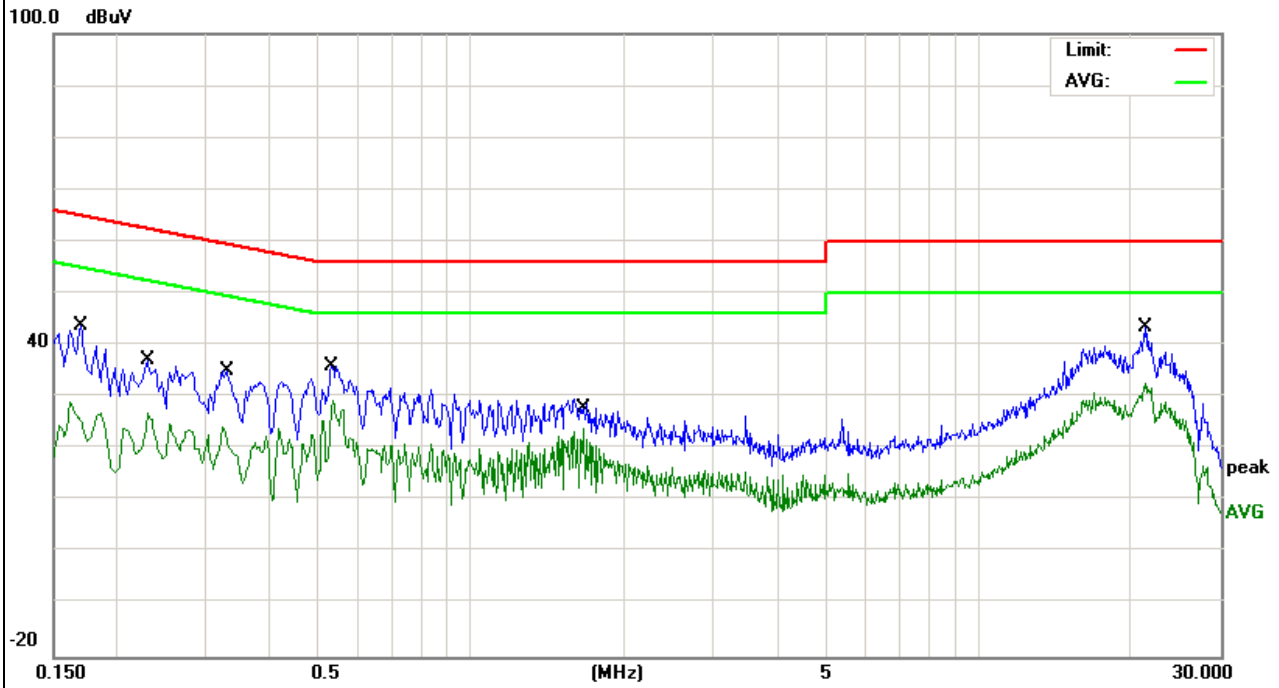

EUT :	USB Dongle	Model Name. :	M001
Temperature :	26 °C	Relative Humidity :	54%
Pressure :	1010hPa	Phase :	L
Test Voltage :	DC 5.0V form PC AC 240V/60Hz	Test Mode :	Mode 4

Frequency	Reading Level	Correct Factor	Measure-ment	Limits	Margin	Remark
(MHz)	(dBμV)	(dB)	(dBμV)	(dBμV)	(dB)	
0.1700	29.52	9.62	39.14	64.96	-25.82	QP
0.1700	19.16	9.62	28.78	54.96	-26.18	AVG
0.2300	27.54	9.65	37.19	62.45	-25.26	QP
0.2300	18.14	9.65	27.79	52.45	-24.66	AVG
0.3220	23.18	9.66	32.84	59.65	-26.81	QP
0.3220	11.87	9.66	21.53	49.65	-28.12	AVG
0.5349	25.69	9.77	35.46	56.00	-20.54	QP
0.5349	17.22	9.77	26.99	46.00	-19.01	AVG
3.0819	21.15	9.67	30.82	56.00	-25.18	QP
3.0819	11.93	9.67	21.60	46.00	-24.40	AVG
21.4740	29.72	9.95	39.67	60.00	-20.33	QP
21.4740	18.83	9.95	28.78	50.00	-21.22	AVG

Remark:

1. All readings are Quasi-Peak and Average values.
2. Factor = Insertion Loss + Cable Loss.

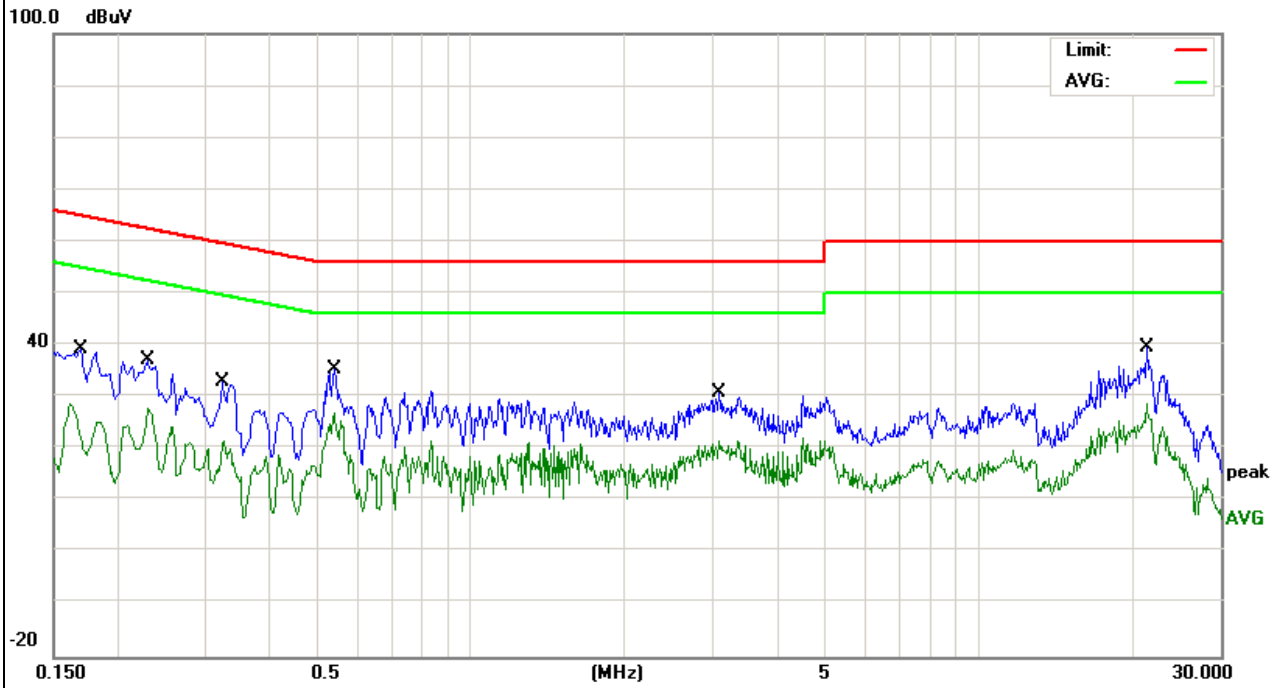

EUT :	USB Dongle	Model Name. :	M001
Temperature :	26 °C	Relative Humidity :	54%
Pressure :	1010hPa	Phase :	N
Test Voltage :	DC 5.0V form PC AC 240V/60Hz	Test Mode :	Mode 4

Frequency	Reading Level	Correct Factor	Measure-ment	Limits	Margin	Remark
(MHz)	(dBμV)	(dB)	(dBμV)	(dBμV)	(dB)	
0.1700	31.22	9.61	40.83	64.96	-24.13	QP
0.1700	16.31	9.61	25.92	54.96	-29.04	AVG
0.3300	24.39	9.62	34.01	59.45	-25.44	QP
0.3300	13.22	9.62	22.84	49.45	-26.61	AVG
0.5420	23.35	9.67	33.02	56.00	-22.98	QP
0.5420	16.54	9.67	26.21	46.00	-19.79	AVG
1.6626	20.03	9.56	29.59	56.00	-26.41	QP
1.6656	14.94	9.56	24.50	46.00	-21.50	AVG
3.3620	23.37	9.51	32.88	56.00	-23.12	QP
3.3620	13.85	9.51	23.36	46.00	-22.64	AVG
21.3616	26.16	9.86	36.02	60.00	-23.98	QP
21.3616	15.41	9.86	25.27	50.00	-24.73	AVG

Remark:

1. All readings are Quasi-Peak and Average values.
2. Factor = Insertion Loss + Cable Loss.

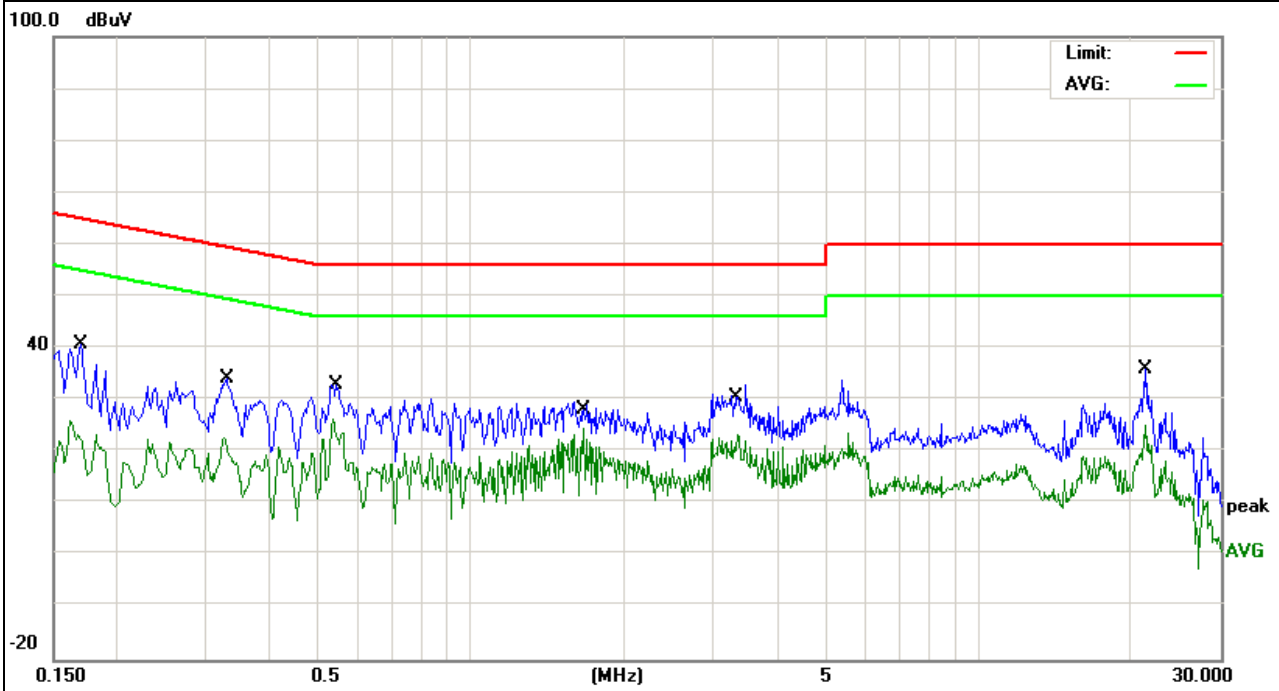

3.4 RADIATED EMISSION MEASUREMENT

3.4.1 Radiated Emission Limits (FCC 15.209)

Frequencies (MHz)	Field Strength (micorvolts/meter)	Measurement Distance (meters)
0.009~0.490	2400/F(KHz)	300
0.490~1.705	24000/F(KHz)	30
1.705~30.0	30	30
Frequency (MHz)	Limit (dBuV)	
30~88	40	3
88~216	43.5	3
216~960	46	3
960 -10000	54.00	3
*902 - 928	94.00	3

Note:

- (1) The tighter limit applies at the band edges.
- (2) Emission level (dBuV/m)=20log Emission level (uV/m).
- (3) *Note: This is the limit for the fundamental frequency.

LIMITS OF RADIATED EMISSION MEASUREMENT (FCC 15.249)

Frequency of Emission (MHz)	Field Strength of fundamental ((millivolts /meter)	Field Strength of Harmonics (microvolts/meter)
902-928	50	500

Notes:

- (1) Emissions radiated outside of the specified frequency bands, except for harmonics, shall be attenuated by at least 50 dB below the level of the fundamental or to the general radiated emission limits in Section 15.209, whichever is the lesser attenuation.

Spectrum Parameter	Setting
Attenuation	Auto
Start Frequency	1000 MHz
Stop Frequency	10th carrier harmonic
RB / VB (emission in restricted band)	1MHz / 1MHz for Peak

Receiver Parameter	Setting
Attenuation	Auto
Start ~ Stop Frequency	9kHz~150kHz / RB 200Hz for QP
Start ~ Stop Frequency	150kHz~30MHz / RB 9kHz for QP
Start ~ Stop Frequency	30MHz~1000MHz / RB 120kHz for QP

3.4.2 TEST PROCEDURE

- a. The measuring distance of at 3 m shall be used for measurements at frequency up to 1GHz. For frequencies above 1GHz, any suitable measuring distance may be used.
- b. The EUT was placed on the top of a rotating table 0.8 m for below 1GHz and 1.5m for above 1GHz the ground at a 3 meter open area test site. The table was rotated 360 degrees to determine the position of the highest radiation.
- c. The height of the equipment or of the substitution antenna shall be 0.8 m for below 1GHz and 1.5m for above 1GHz; the height of the test antenna shall vary between 1 m to 4 m. Both horizontal and vertical polarizations of the antenna are set to make the measurement.
- d. The initial step in collecting conducted emission data is a spectrum analyzer peak detector mode pre-scanning the measurement frequency range. Significant peaks are then marked and then Quasi Peak detector mode re-measured.
- e. If the Peak Mode measured value compliance with and lower than Quasi Peak Mode Limit, the EUT shall be deemed to meet QP Limits and then no additional QP Mode measurement performed.
- f. For the actual test configuration, please refer to the related Item –EUT Test Photos.

Note:

Both horizontal and vertical antenna polarities were tested and performed pretest to three orthogonal axis. The worst case emissions were reported

3.4.3 DEVIATION FROM TEST STANDARD

No deviation

3.4.4 TEST SETUP

(A) Radiated Emission Test-Up Frequency Below 30MHz

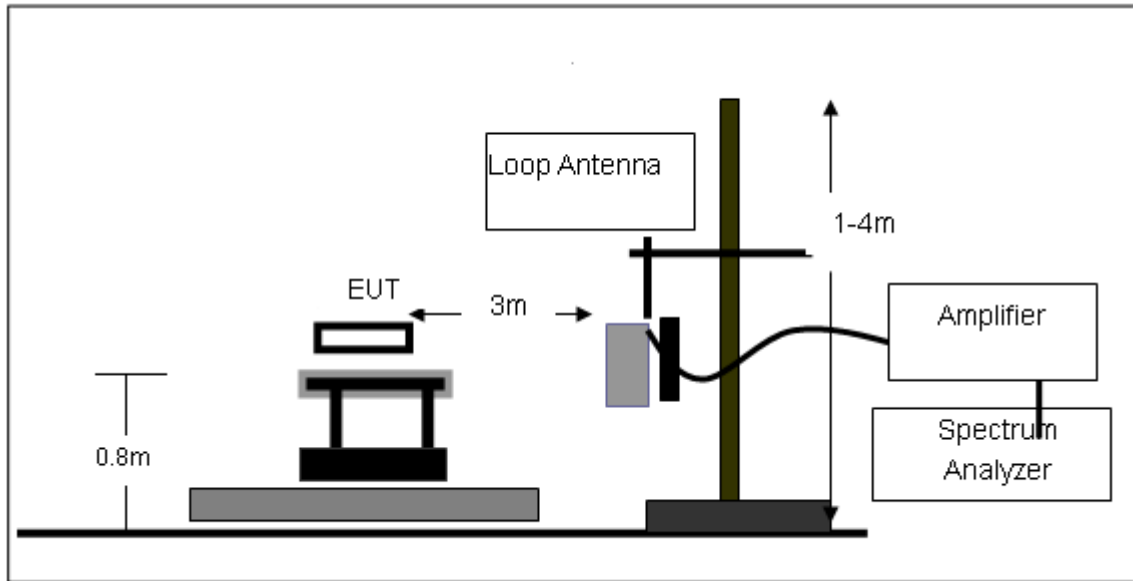

(B) Radiated Emission Test-Up Frequency 30MHz~1GHz

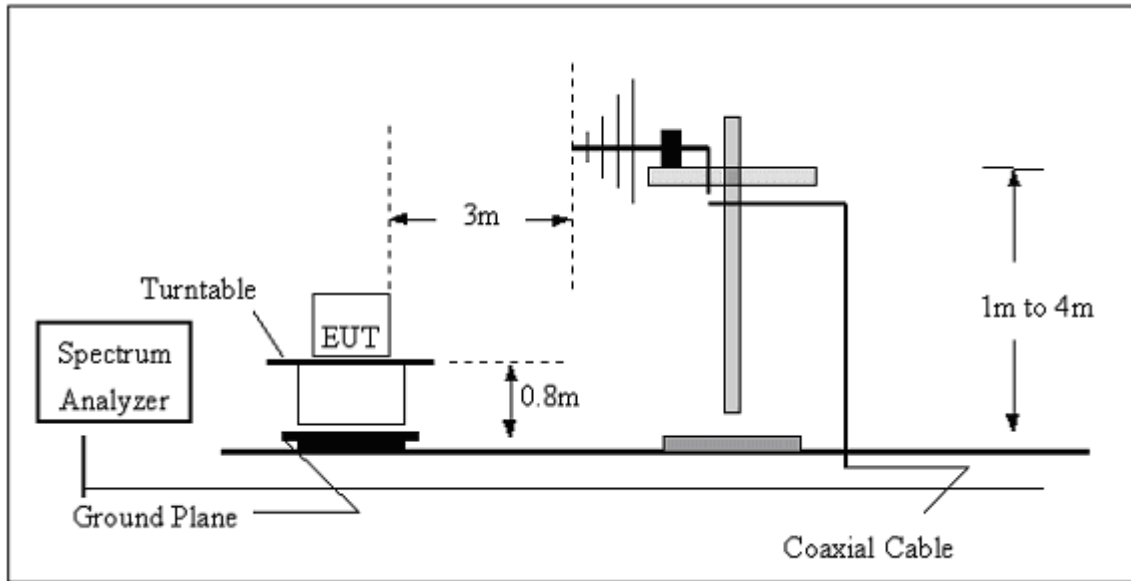

(C) Radiated Emission Test-Up Frequency Above 1GHz

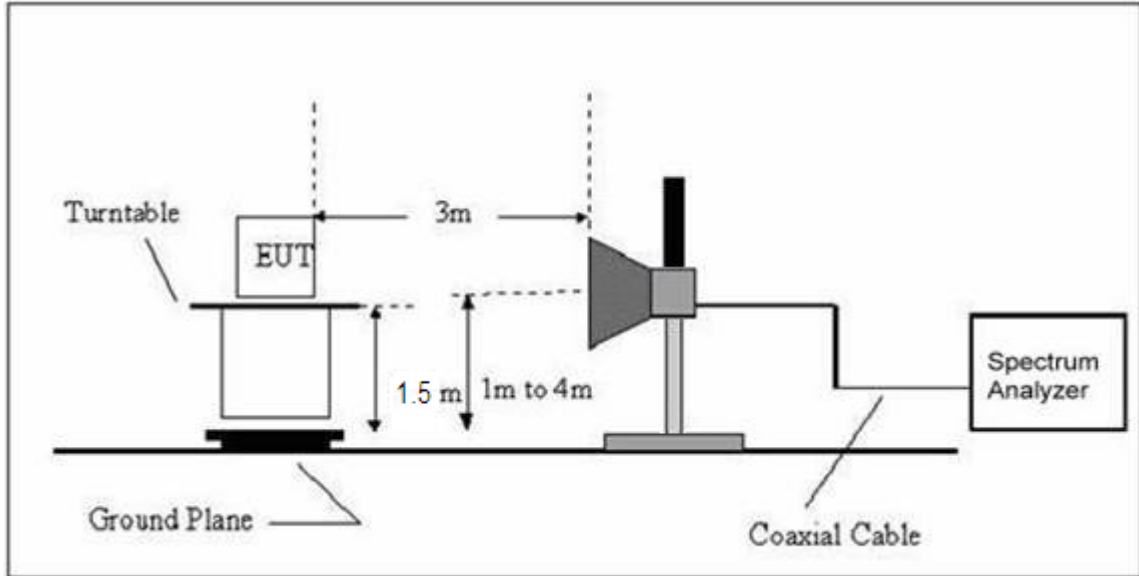

3.4.5 TEST RESULTS (BLOW 30MHz)

EUT :	USB Dongle	Model Name. :	M001
Temperature :	20 °C	Relative Humidity :	48%
Pressure :	1010 hPa	Test Voltage :	DC 5.0V
Test Mode :	TX	Polarization :	--

Freq.	Reading	Limit	Margin	State
(MHz)	(dBuV/m)	(dBuV/m)	(dB)	P/F
--	--	--	--	PASS
--	--	--	--	PASS

NOTE:

The amplitude of spurious emissions which are attenuated by more than 20dB below the permissible value has no need to be reported.

Distance extrapolation factor = $20 \log (\text{specific distance}/\text{test distance})(\text{dB})$;

Limit line = specific limits(dBuv) + distance extrapolation factor.

3.4.6 TEST RESULTS (BETWEEN 30 – 1000 MHZ)

EUT :	USB Dongle	Model Name :	M001
Temperature :	20 °C	Relative Humidity :	48%
Pressure :	1010 hPa	Test Voltage :	DC 5.0V
Test Mode :	TX	Polarization :	Vertical

Frequency (MHz)	Meter Reading (dBμV)	Factor (dB)	Emission Level (dBμV/m)	Limits (dBμV/m)	Margin (dB)	Detector Type
32.0667	6.82	18.30	25.12	40.00	-14.88	QP
63.0915	12.89	7.14	20.03	40.00	-19.97	QP
140.8351	9.39	11.32	20.71	43.50	-22.79	QP
204.9550	16.19	11.11	27.30	43.50	-16.20	QP
222.1698	13.67	12.28	25.95	46.00	-20.05	QP
599.3211	11.03	22.40	33.43	46.00	-12.57	QP

Remark:

- Factor = Antenna Factor + Cable Loss – Pre-amplifier.

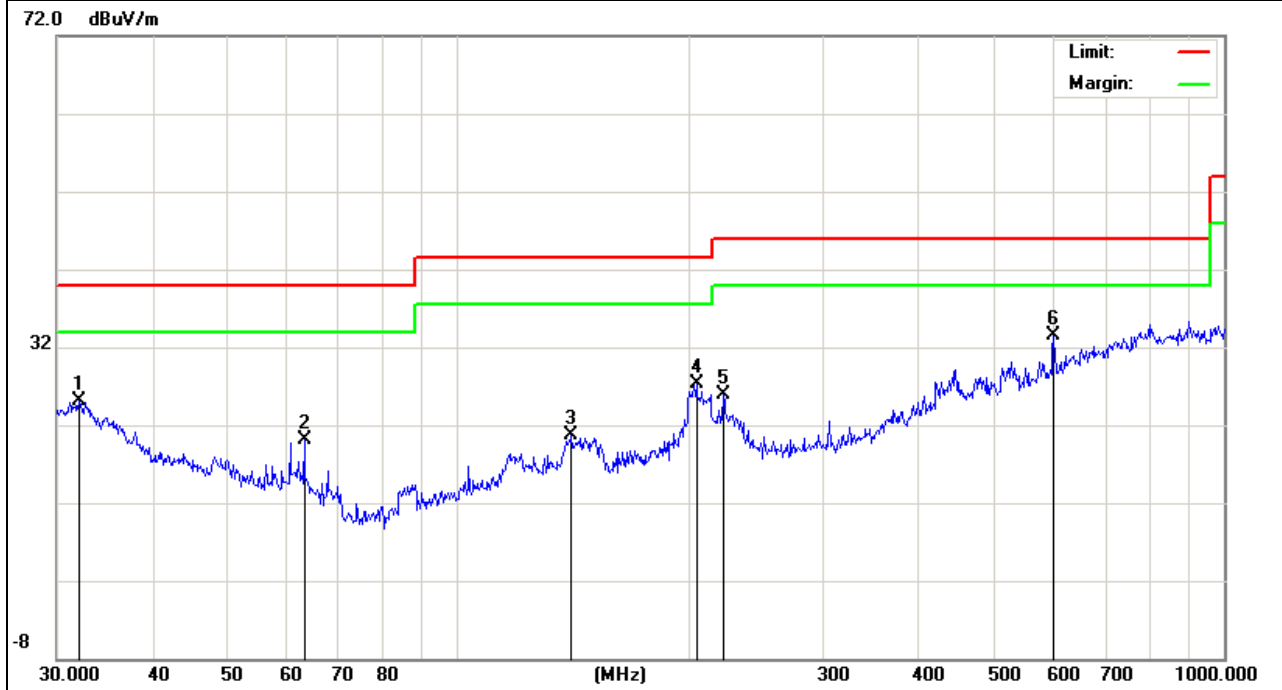

EUT :	USB Dongle	Model Name :	M001
Temperature :	20 °C	Relative Humidity :	48%
Pressure :	1010 hPa	Test Voltage :	DC 5.0V
Test Mode :	TX	Polarization :	Horizontal

Frequency (MHz)	Meter Reading (dBμV)	Factor (dB)	Emission Level (dBμV/m)	Limits (dBμV/m)	Margin (dB)	Detector Type
30.8535	5.90	18.97	24.87	40.00	-15.13	QP
38.0782	9.82	14.75	24.57	40.00	-15.43	QP
129.9225	12.71	11.89	24.60	43.50	-18.90	QP
220.6168	18.49	12.17	30.66	46.00	-15.34	QP
399.0300	13.02	18.27	31.29	46.00	-14.71	QP
909.6666	11.48	27.07	38.55	46.00	-7.45	QP

Remark:

1. Factor = Antenna Factor + Cable Loss – Pre-amplifier.

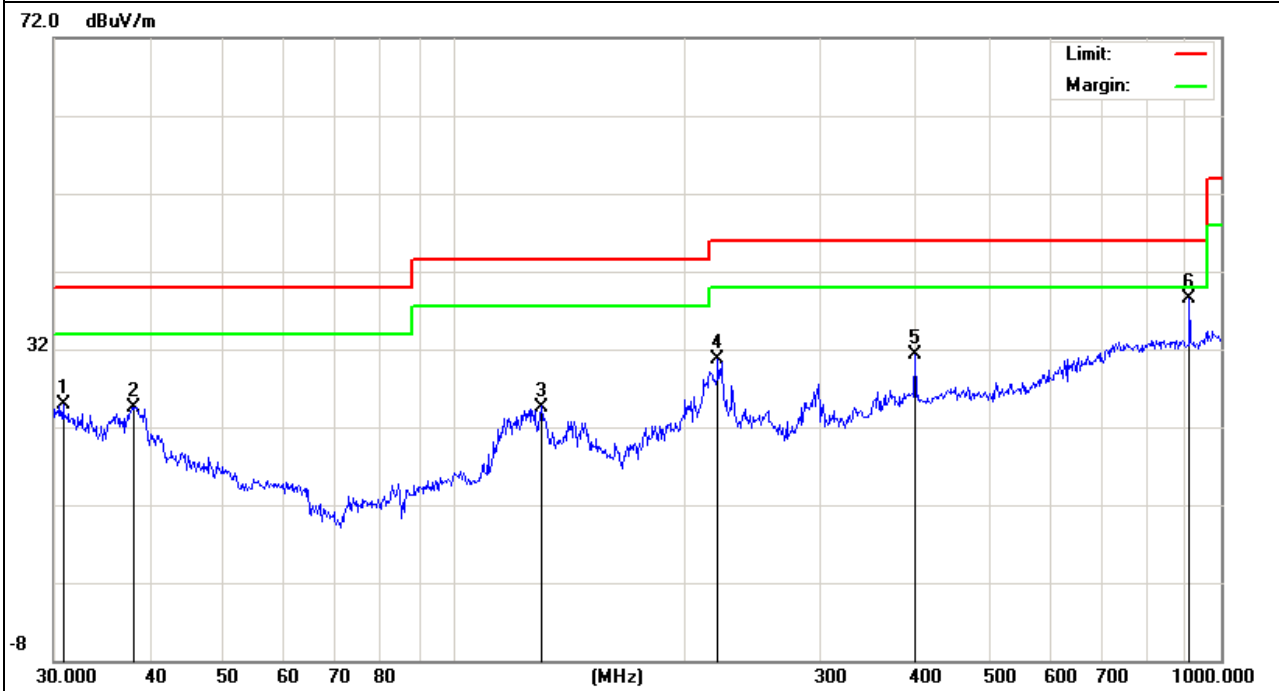

3.4.7 TEST RESULTS (ABOVE 1000 MHZ)

EUT :	USB Dongle	Model Name :	M001
Temperature :	20 °C	Relative Humidity :	48%
Pressure :	1010 hPa	Test Voltage :	DC 5.0V
Test Mode :	TX-2408MHz	Polarization :	Horizontal

Frequency (MHz)	Meter Reading (dBμV)	Factor (dB)	Emission Level (dBμV/m)	Limits (dBμV/m)	Margin (dB)	Detector Type
2408.00	93.41	-9.21	84.20	114.00	-29.80	peak
2408.00	79.41	-9.21	70.20	94.00	-23.80	AVG
4816.00	46.02	0.17	46.19	74.00	-27.81	peak
4816.00	32.43	0.17	32.60	54.00	-21.40	AVG

Remark:
 Factor = Antenna Factor + Cable Loss – Pre-amplifier.
 No emission above 18GHz.

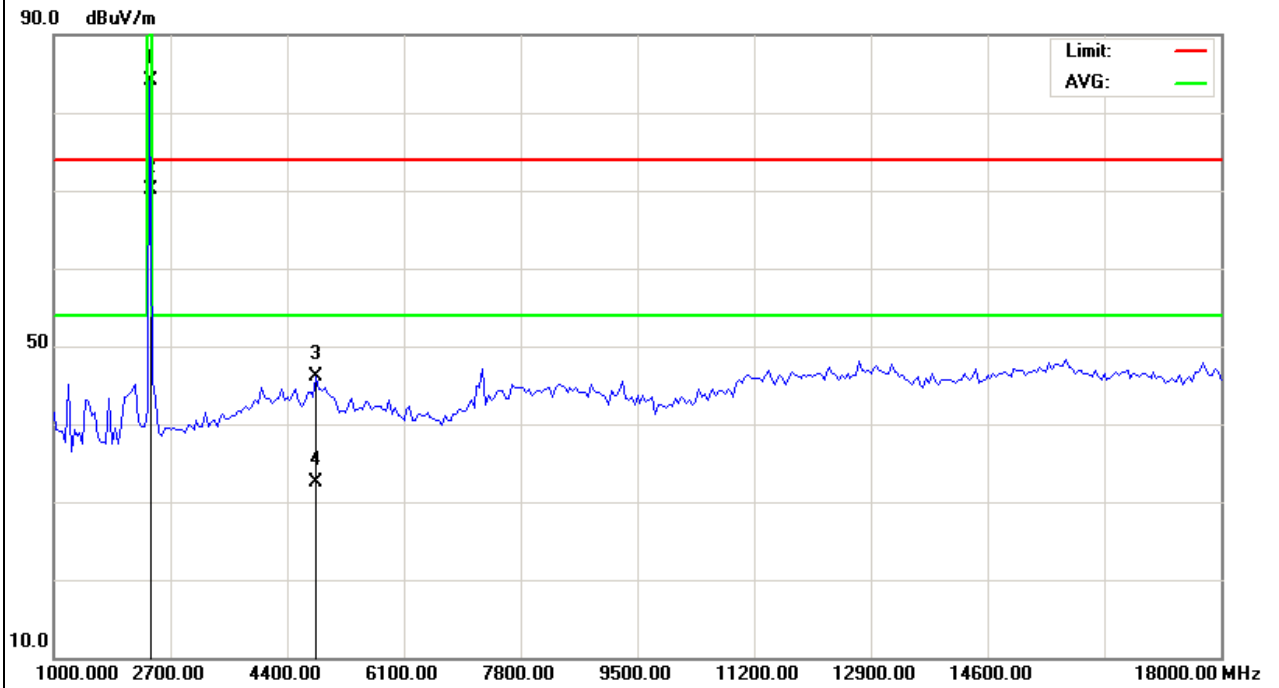

EUT :	USB Dongle	Model Name :	M001
Temperature :	20 °C	Relative Humidity :	48%
Pressure :	1010 hPa	Test Voltage :	DC 5.0V
Test Mode :	TX-2408MHz	Polarization :	Vertical

Frequency (MHz)	Meter Reading (dBμV)	Factor (dB)	Emission Level (dBμV/m)	Limits (dBμV/m)	Margin (dB)	Detector Type
2408.00	98.51	-9.21	89.30	114.00	-24.70	peak
2408.00	86.11	-9.21	76.90	94.00	-17.10	AVG
4816.00	50.85	0.17	51.02	74.00	-22.98	peak
4816.00	39.43	0.17	39.60	54.00	-14.40	AVG
7224.00	46.84	2.25	49.09	74.00	-24.91	peak
7224.00	30.65	2.25	32.90	54.00	-21.10	AVG

Remark:

Factor = Antenna Factor + Cable Loss – Pre-amplifier.

No emission above 18GHz.

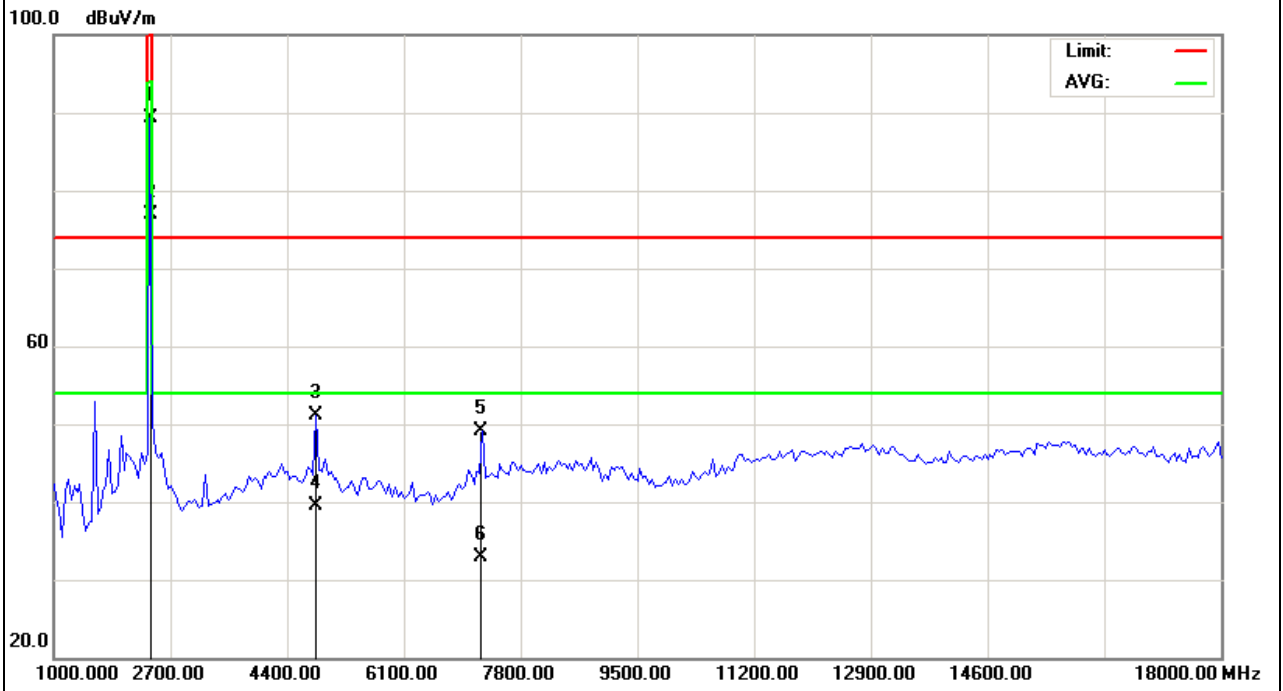

EUT :	USB Dongle	Model Name :	M001
Temperature :	20 °C	Relative Humidity :	48%
Pressure :	1010 hPa	Test Voltage :	DC 5.0V
Test Mode :	TX-2440MHz	Polarization :	Horizontal

Frequency (MHz)	Meter Reading (dBμV)	Factor (dB)	Emission Level (dBμV/m)	Limits (dBμV/m)	Margin (dB)	Detector Type
2440.00	110.24	-9.15	101.09	114.00	-12.91	peak
2440.00	95.85	-9.15	86.70	94.00	-7.30	AVG
4880.00	58.54	0.08	58.62	74.00	-15.38	peak
4880.00	46.12	0.08	46.20	54.00	-7.80	AVG

Remark:
 Factor = Antenna Factor + Cable Loss – Pre-amplifier.
 No emission above 18GHz.

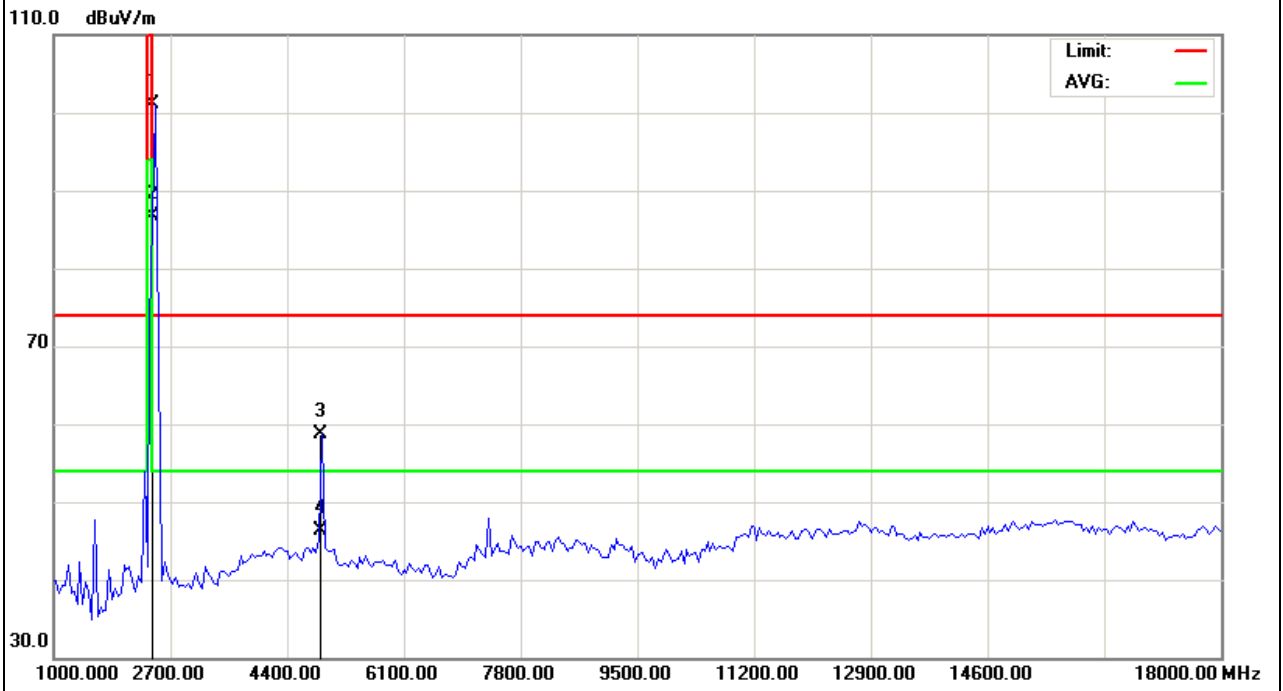

EUT :	USB Dongle	Model Name :	M001
Temperature :	20 °C	Relative Humidity :	48%
Pressure :	1010 hPa	Test Voltage :	DC 5.0V
Test Mode :	TX-2440MHz	Polarization :	Vertical

Frequency (MHz)	Meter Reading (dBμV)	Factor (dB)	Emission Level (dBμV/m)	Limits (dBμV/m)	Margin (dB)	Detector Type
2440.00	98.71	-9.15	89.56	114.00	-24.44	peak
2440.00	83.25	-9.15	74.10	94.00	-19.90	AVG
4880.00	48.07	0.08	48.15	74.00	-25.85	peak
4880.00	35.02	0.08	35.10	54.00	-18.90	AVG
7320.00	46.81	2.60	49.41	74.00	-24.59	peak
7320.00	33.90	2.60	36.50	54.00	-17.50	AVG

Remark:
 Factor = Antenna Factor + Cable Loss – Pre-amplifier.
 No emission above 18GHz.

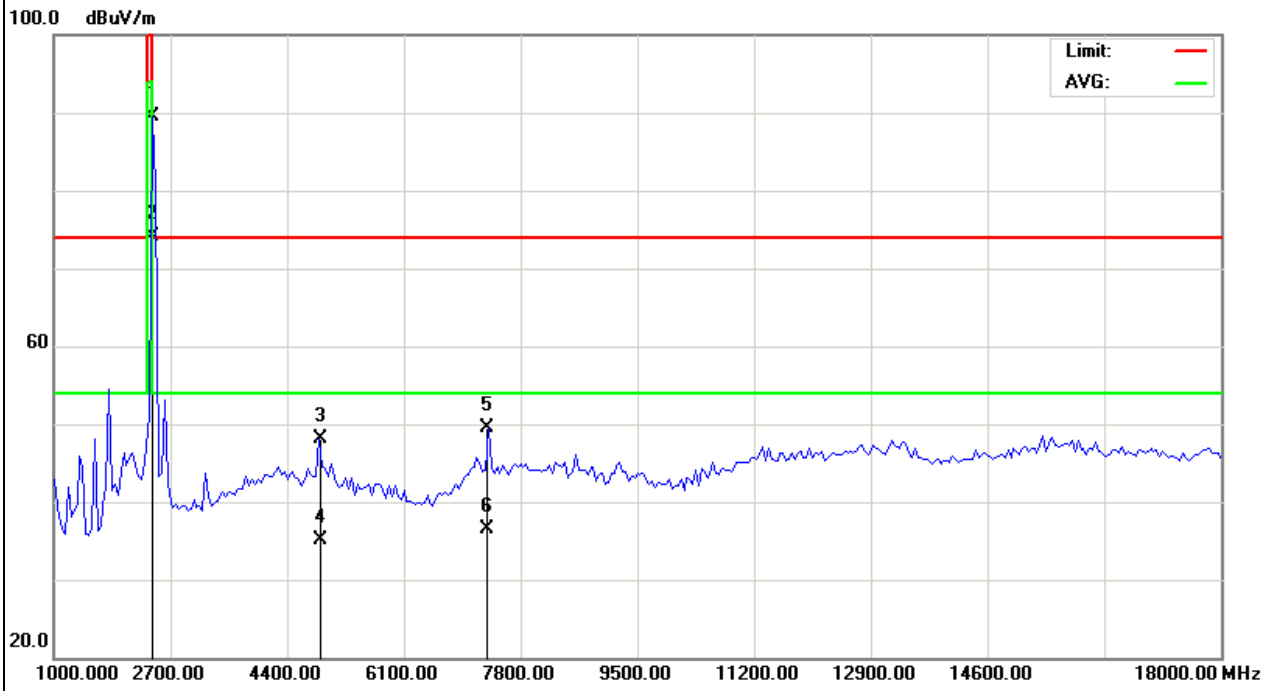

EUT :	USB Dongle	Model Name :	M001
Temperature :	20 °C	Relative Humidity :	48%
Pressure :	1010 hPa	Test Voltage :	DC 5.0V
Test Mode :	TX-2474MHz	Polarization :	Horizontal

Frequency (MHz)	Meter Reading (dBμV)	Factor (dB)	Emission Level (dBμV/m)	Limits (dBμV/m)	Margin (dB)	Detector Type
2474.00	92.74	-9.03	83.71	114.00	-30.29	peak
2474.00	79.43	-9.03	70.40	94.00	-23.60	AVG
4948.00	45.28	0.17	45.45	74.00	-28.55	peak
4948.00	32.33	0.17	32.50	54.00	-21.50	AVG

Remark:
 Factor = Antenna Factor + Cable Loss – Pre-amplifier.
 No emission above 18GHz.

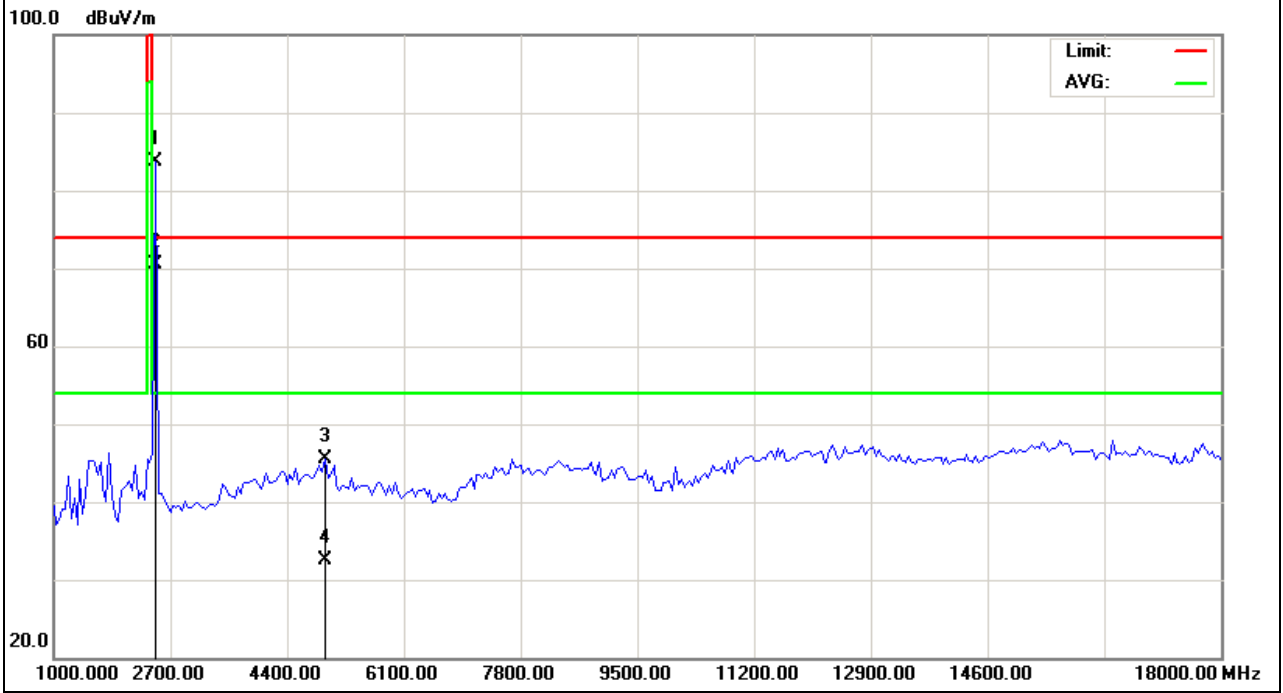

EUT :	USB Dongle	Model Name :	M001
Temperature :	20 °C	Relative Humidity :	48%
Pressure :	1010 hPa	Test Voltage :	DC 5.0V
Test Mode :	TX-2474MHz	Polarization :	Vertical

Frequency (MHz)	Meter Reading (dBμV)	Factor (dB)	Emission Level (dBμV/m)	Limits (dBμV/m)	Margin (dB)	Detector Type
2474.00	98.38	-9.03	89.35	114.00	-24.65	peak
2474.00	84.63	-9.03	75.60	94.00	-18.40	AVG
4948.00	48.56	0.17	48.73	74.00	-25.27	peak
4948.00	35.03	0.17	35.20	54.00	-18.80	AVG

Remark:
 Factor = Antenna Factor + Cable Loss – Pre-amplifier.
 No emission above 18GHz.

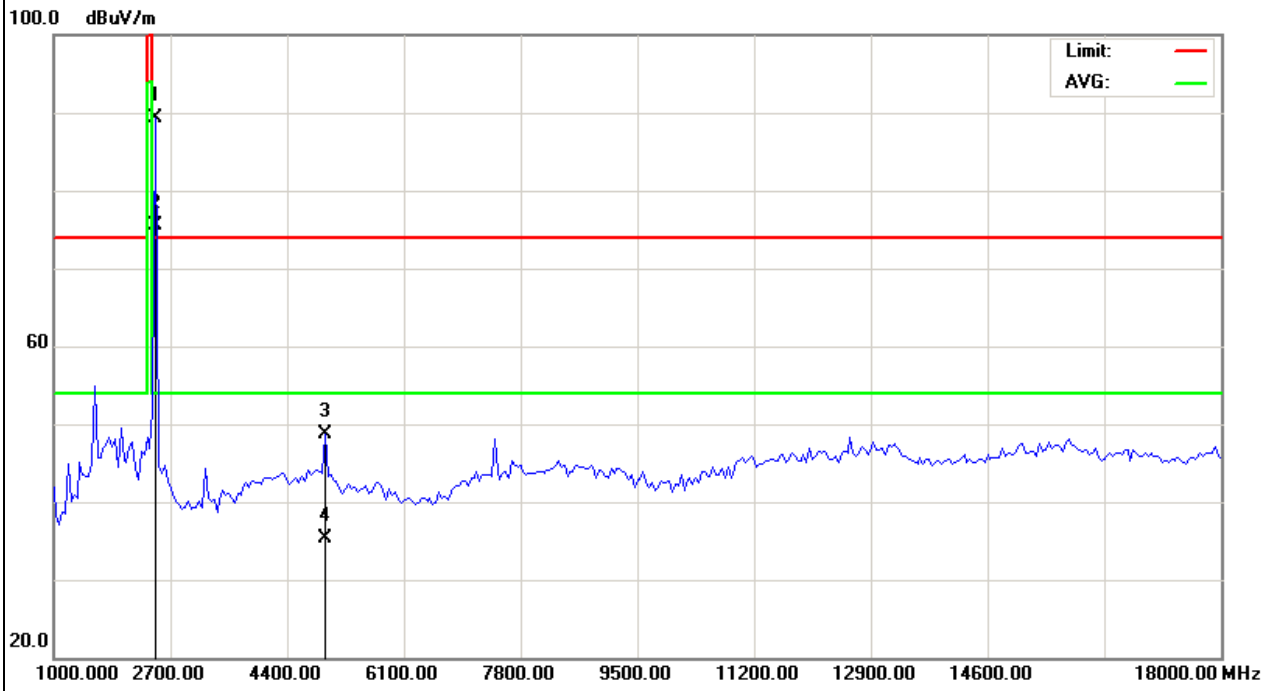

Note: EUT Pre-scan X/Y/Z orientation, only worst case is presented in the report(X orientation).

3.4.8 TEST RESULTS (RESTRICTED BANDS REQUIREMENTS)

EUT :	USB Dongle	Model Name :	M001
Temperature :	20 °C	Relative Humidity :	48%
Pressure :	1010 hPa	Test Voltage :	DC 5.0V
Test Mode :	TX-2408MHz	Polarization :	Horizontal

Frequency (MHz)	Meter Reading (dBμV)	Factor (dB)	Emission Level (dBμV/m)	Limits (dBμV/m)	Margin (dB)	Detector Type
2400.00	46.49	-9.22	37.27	74.00	-36.73	peak
2400.00	33.52	-9.22	24.30	54.00	-29.70	AVG

Remark:
Factor = Antenna Factor + Cable Loss – Pre-amplifier.

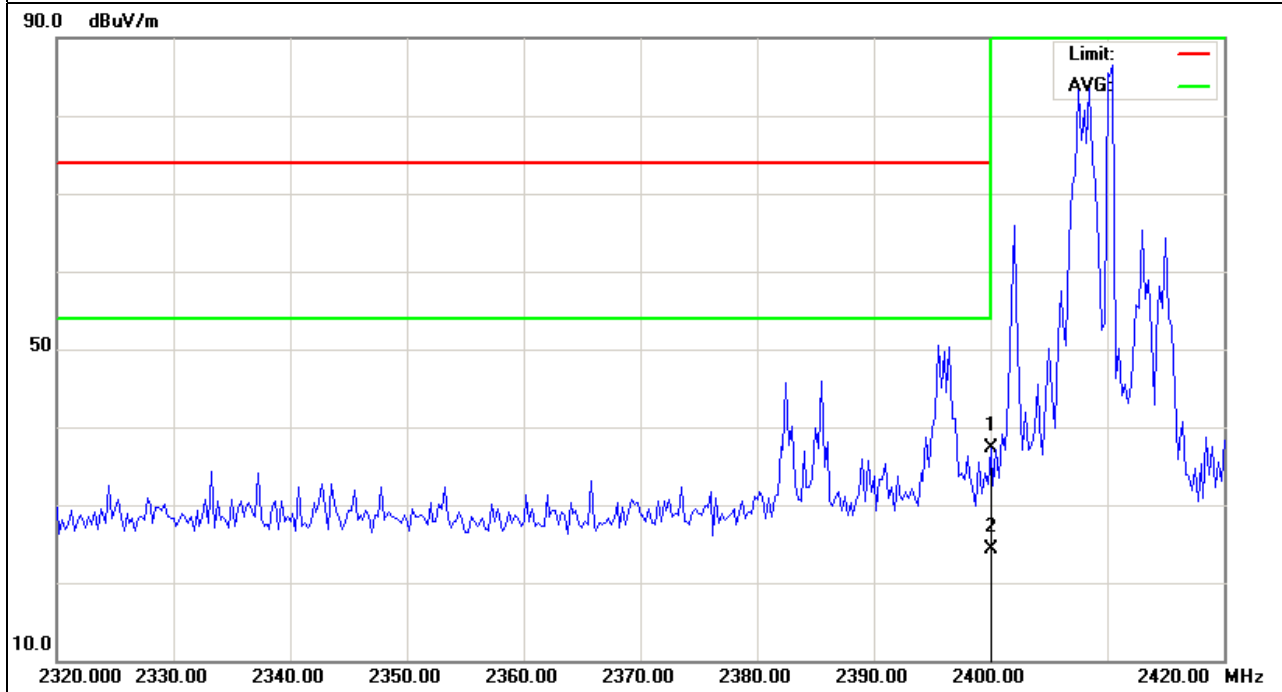

EUT :	USB Dongle	Model Name :	M001
Temperature :	20 °C	Relative Humidity :	48%
Pressure :	1010 hPa	Test Voltage :	DC 5.0V
Test Mode :	TX-2408MHz	Polarization :	Vertical

Frequency (MHz)	Meter Reading (dBμV)	Factor (dB)	Emission Level (dBμV/m)	Limits (dBμV/m)	Margin (dB)	Detector Type
2396.50	66.00	-9.25	56.75	74.00	-17.25	peak
2396.50	44.05	-9.25	34.80	54.00	-19.20	AVG
2400.00	51.10	-9.22	41.88	74.00	-32.12	peak
2400.00	37.92	-9.22	28.70	54.00	-25.30	AVG

Remark:
 Factor = Antenna Factor + Cable Loss – Pre-amplifier.

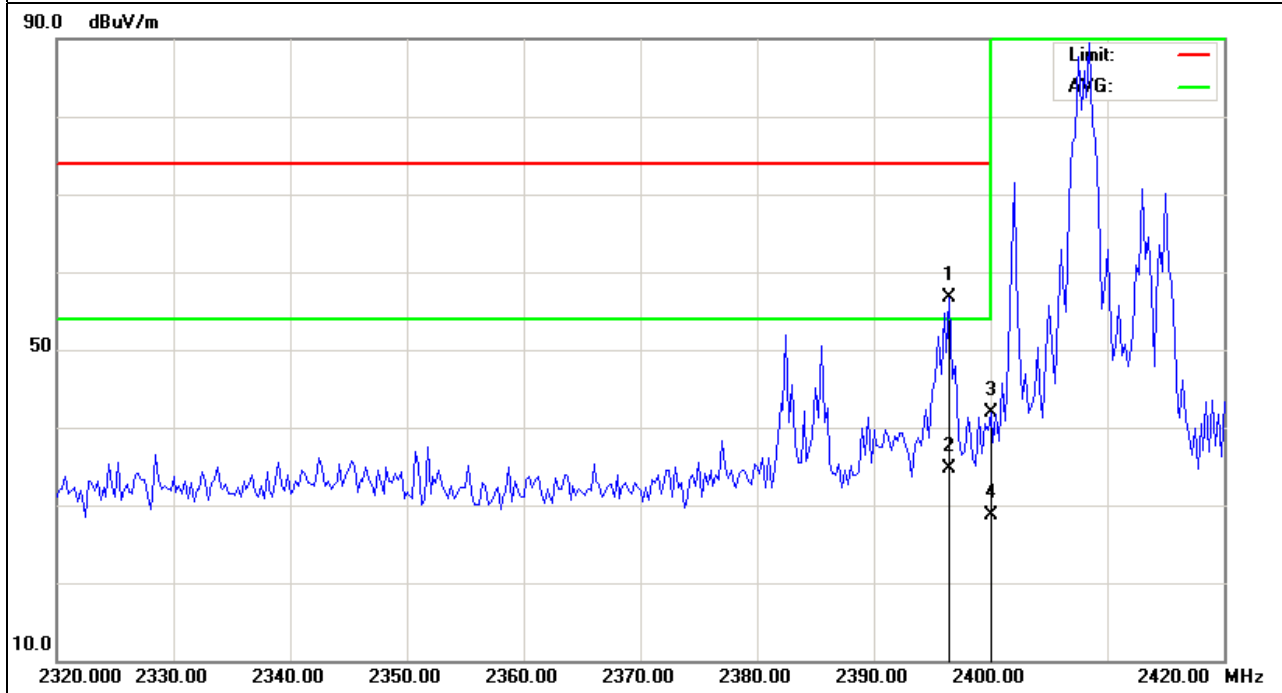

EUT :	USB Dongle	Model Name :	M001
Temperature :	20 °C	Relative Humidity :	48%
Pressure :	1010 hPa	Test Voltage :	DC 5.0V
Test Mode :	TX-2474MHz	Polarization :	Horizontal

Frequency (MHz)	Meter Reading (dBμV)	Factor (dB)	Emission Level (dBμV/m)	Limits (dBμV/m)	Margin (dB)	Detector Type
2483.500	43.16	-8.99	34.17	74.00	-39.83	peak
2483.500	30.79	-8.99	21.80	54.00	-32.20	AVG

Remark:
 Factor = Antenna Factor + Cable Loss – Pre-amplifier.

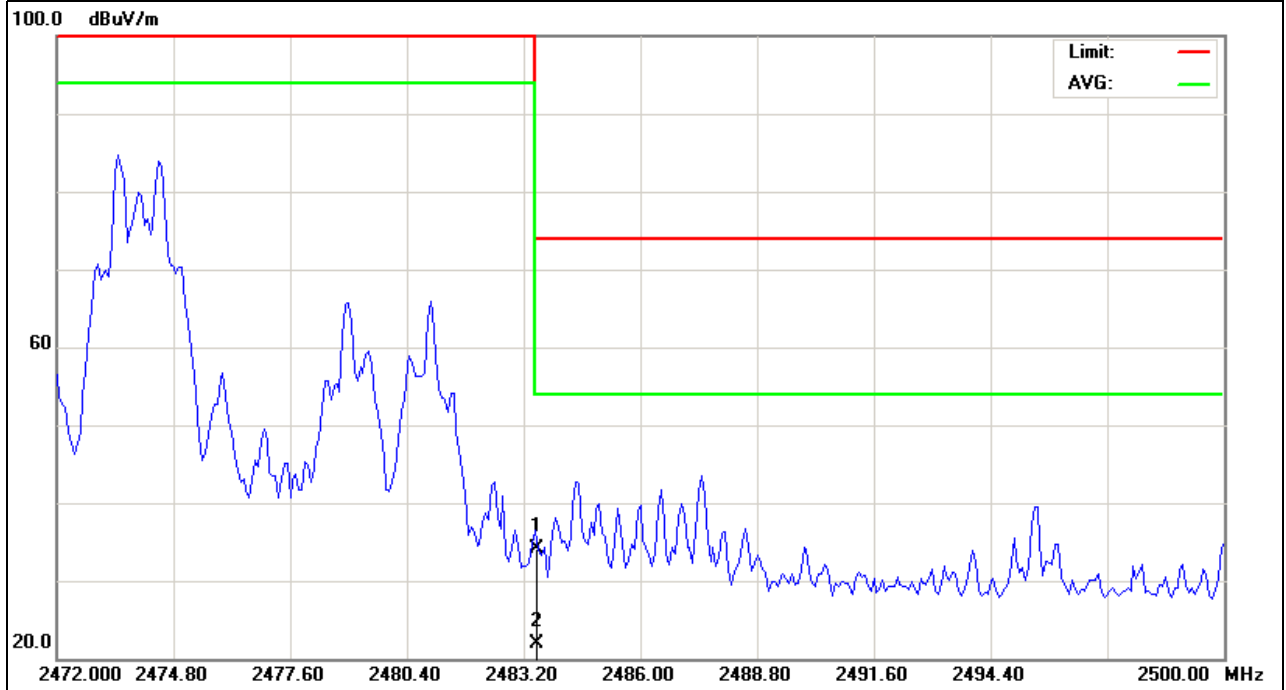

EUT :	USB Dongle	Model Name :	M001
Temperature :	20 °C	Relative Humidity :	48%
Pressure :	1010 hPa	Test Voltage :	DC 5.0V
Test Mode :	TX-2474MHz	Polarization :	Vertical

Frequency (MHz)	Meter Reading (dBμV)	Factor (dB)	Emission Level (dBμV/m)	Limits (dBμV/m)	Margin (dB)	Detector Type
2483.500	48.11	-8.99	39.12	74.00	-34.88	peak
2483.500	35.69	-8.99	26.70	54.00	-27.30	AVG

Remark:
 Factor = Antenna Factor + Cable Loss – Pre-amplifier.

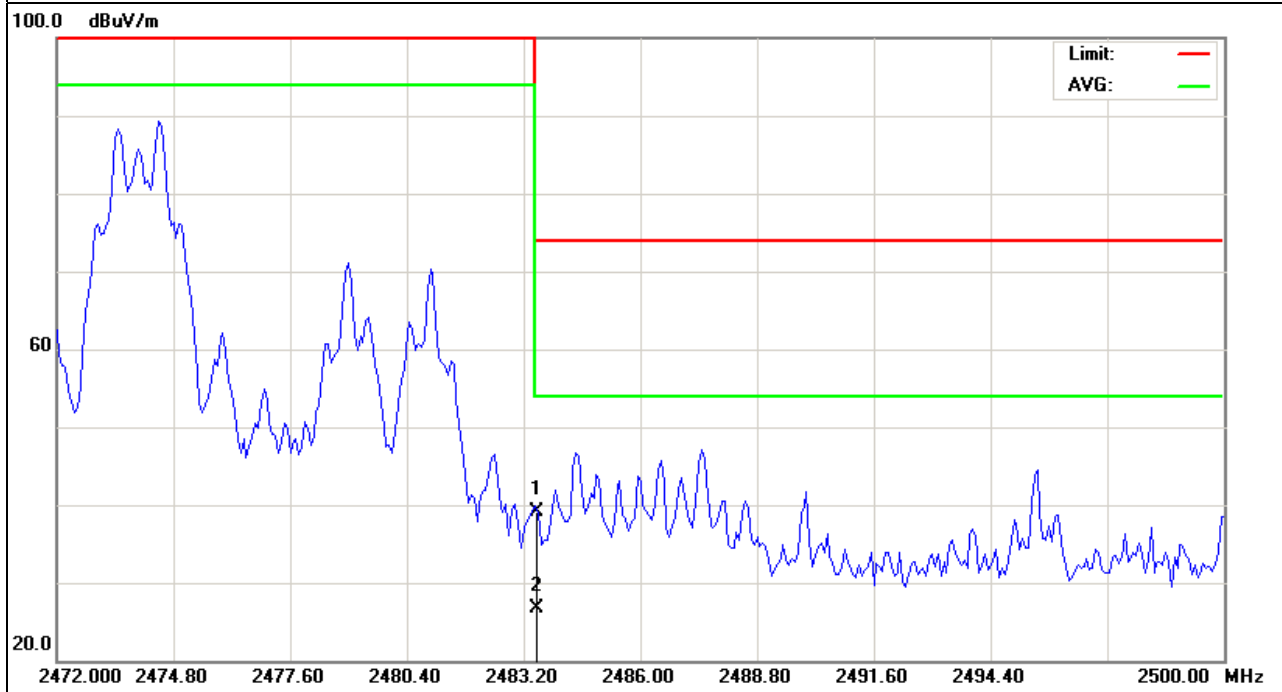

4. BANDWIDTH TEST

4.1 TEST PROCEDURE

- a. The EUT was directly connected to the spectrum analyzer and antenna output port as show in the block diagram below,
- b. Spectrum Setting : RBW= 100KHz, VBW \geq RBW, Sweep time = Auto.

4.2 DEVIATION FROM STANDARD

No deviation.

4.3 TEST SETUP



4.4 TEST RESULTS

EUT :	USB Dongle	Model Name :	M001
Temperature :	26 °C	Relative Humidity :	53%
Pressure :	1020 hPa	Test Power :	DC 5.0V
Test Mode :	TX		

Test Channel	Frequency (MHz)	20 dBc Bandwidth (MHz)
CH01	2408	2.262
CH17	2440	2.257
CH34	2474	2.245

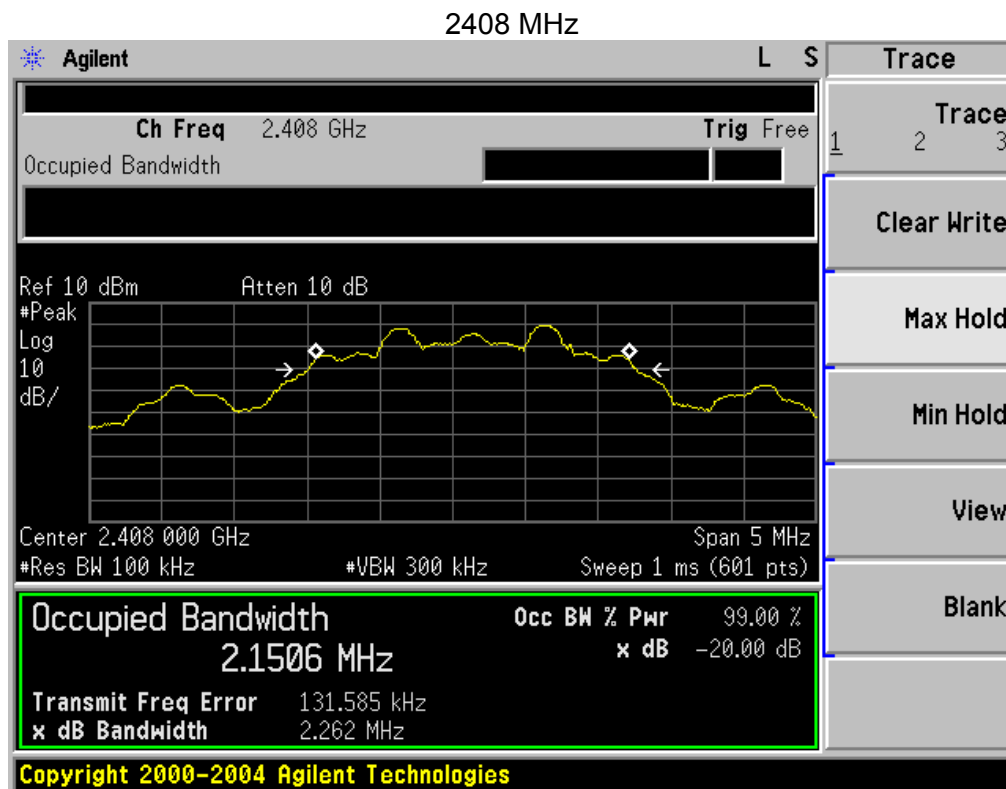

2440MHz

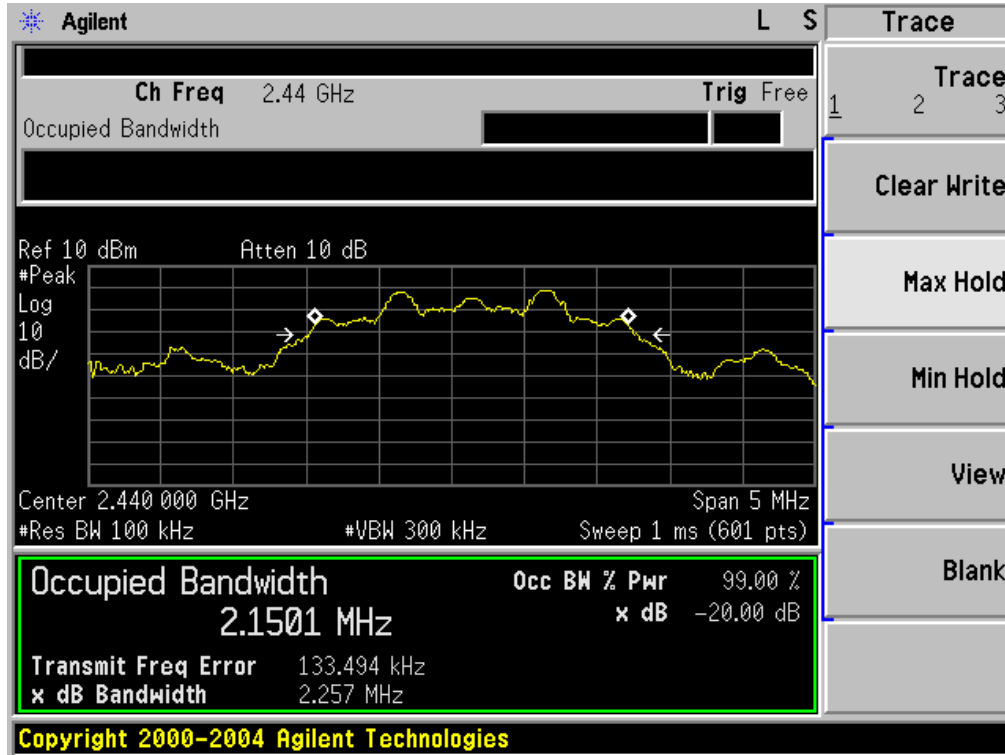

2474 MHz

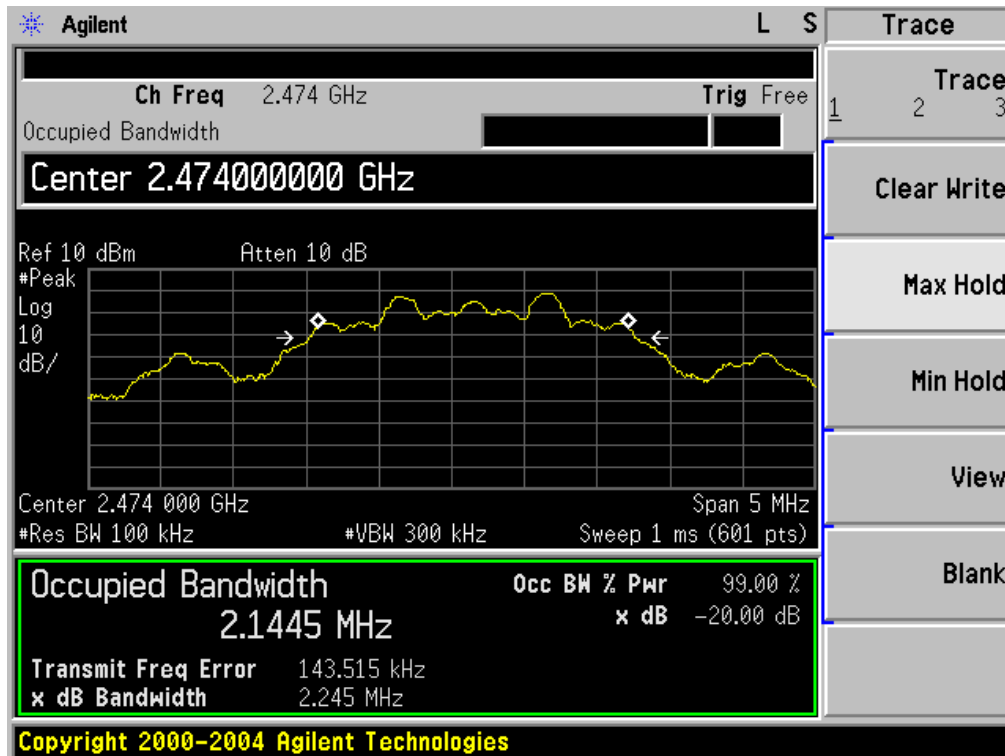

5. EUT TEST PHOTO

Radiated Measurement Photos

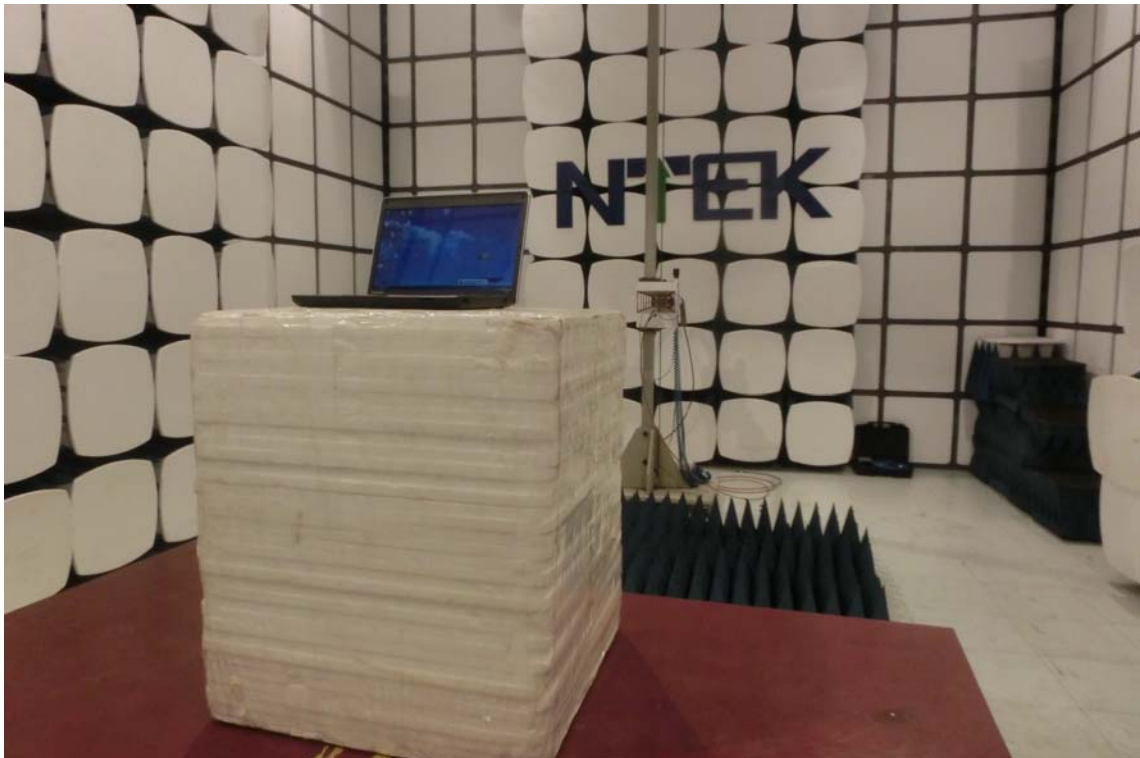
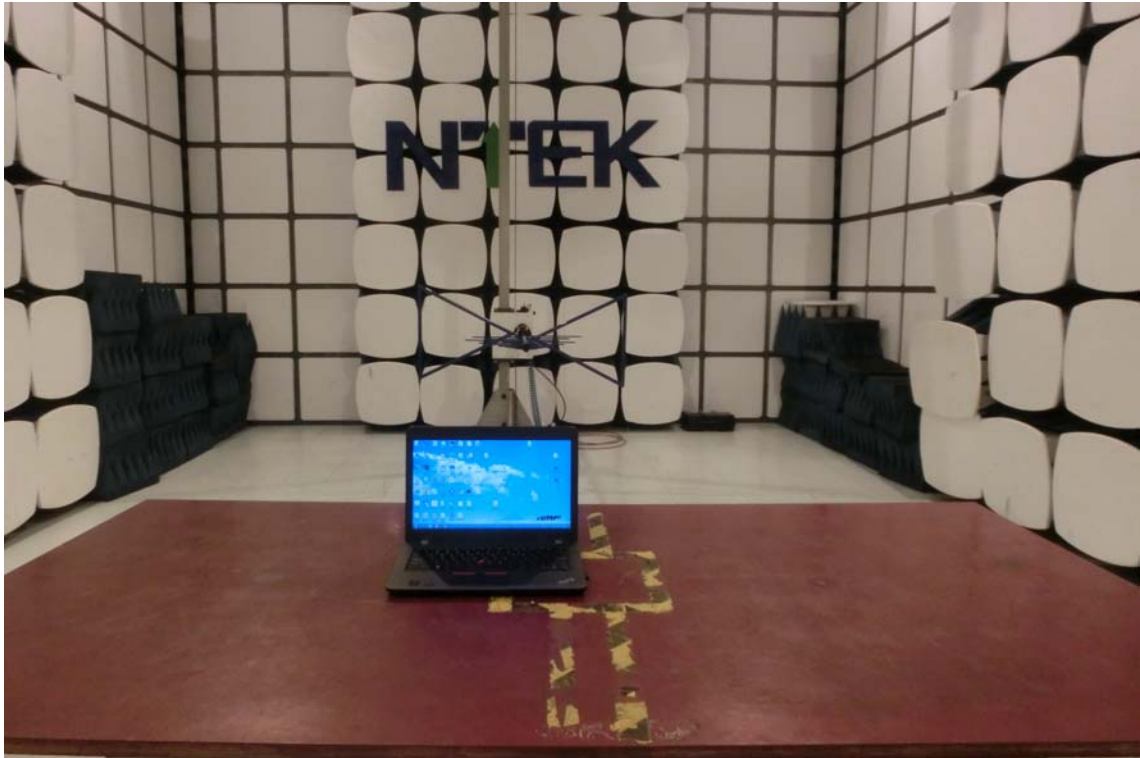

Conducted Measurement Photos

