



FCC RADIO TEST REPORT-BLE

FCC ID:2AEFF-F32

Product : TeckNet F32 Bluetooth FM Transmitter

Trade Name : TECKNET

Model Name : F32

Serial Model : N/A

Report No. : NTEK-2015NT0303400F2

Prepared for

SHENZHEN UNICHAIN TECHNOLOGY CO.,LTD.

5/F, Block17, Lishan Industrial Park, Nanshan District, Shenzhen,China.

Prepared by

Shenzhen NTEK Testing Technology Co., Ltd.

1/F, Building E, Fenda Science Park, Sanwei Community, Xixiang Street
Bao'an District, Shenzhen P.R. China

Tel.: +86-0755-61156588 Fax.: +86-0755-61156599

Website:www.ntek.org.cn

Table of Contents

	Page
1 . SUMMARY OF TEST RESULTS	5
1.1 TEST FACILITY	6
1.2 MEASUREMENT UNCERTAINTY	6
2 . GENERAL INFORMATION	7
2.1 GENERAL DESCRIPTION OF EUT	7
2.2 DESCRIPTION OF TEST MODES	9
2.3 BLOCK DIGRAM SHOWING THE CONFIGURATION OF SYSTEM TESTED	10
2.4 DESCRIPTION OF SUPPORT UNITS(CONDUCTED MODE)	11
2.5 EQUIPMENTS LIST FOR ALL TEST ITEMS	12
3 . EMC EMISSION TEST	13
3.1 CONDUCTED EMISSION MEASUREMENT	13
3.1.1 POWER LINE CONDUCTED EMISSION LIMITS	13
3.1.2 TEST PROCEDURE	14
3.1.3 DEVIATION FROM TEST STANDARD	14
3.1.4 TEST SETUP	14
3.1.5 EUT OPERATING CONDITIONS	14
3.1.6 TEST RESULTS	15
3.2 RADIATED EMISSION MEASUREMENT	16
3.2.1 RADIATED EMISSION LIMITS	16
3.2.2 TEST PROCEDURE	17
3.2.3 DEVIATION FROM TEST STANDARD	17
3.2.4 TEST SETUP	18
3.2.5 EUT OPERATING CONDITIONS	19
3.2.6 TEST RESULTS (BETWEEN 9KHZ – 30 MHZ)	20
3.2.7 TEST RESULTS (BETWEEN 30MHZ – 1GHZ)	21
3.2.8 TEST RESULTS (ABOVE 1000 MHZ)	23
4 . POWER SPECTRAL DENSITY TEST	24
4.1 APPLIED PROCEDURES / LIMIT	24
4.1.1 TEST PROCEDURE	24
4.1.2 DEVIATION FROM STANDARD	24
4.1.3 TEST SETUP	24
4.1.4 EUT OPERATION CONDITIONS	24
4.1.5 TEST RESULTS	25
5 . BANDWIDTH TEST	27
5.1 APPLIED PROCEDURES / LIMIT	27
5.1.1 TEST PROCEDURE	27

Table of Contents

	Page
TEST SETUP	27
5.1.2 EUT OPERATION CONDITIONS	27
5.1.3 TEST RESULTS	28
6 . PEAK OUTPUT POWER TEST	30
6.1 APPLIED PROCEDURES / LIMIT	30
6.1.1 TEST PROCEDURE	30
6.1.2 DEVIATION FROM STANDARD	30
6.1.3 TEST SETUP	30
6.1.4 EUT OPERATION CONDITIONS	30
6.1.5 TEST RESULTS	31
7 . 100 KHZ BANDWIDTH OF FREQUENCY BAND EDGE	32
7.1 DEVIATION FROM STANDARD	32
7.2 TEST SETUP	32
7.3 EUT OPERATION CONDITIONS	32
7.4 TEST RESULTS	33
8 . ANTENNA REQUIREMENT	35
8.1 STANDARD REQUIREMENT	35
8.2 EUT ANTENNA	35
9 . EUT TEST PHOTO	36
APPENDIX-PHOTOGRAPHS OF EUT CONSTRUCTIONAL DETAILS	

1. SUMMARY OF TEST RESULTS

Test procedures according to the technical standards:

FCC Part15 (15.247) , Subpart C			
Standard Section	Test Item	Judgment	Remark
15.207	Conducted Emission	N/A	
15.247 (a)(2)	6dB Bandwidth	PASS	
15.247 (b)	Peak Output Power	PASS	
15.247 (c)	Radiated Spurious Emission	PASS	
15.247 (d)	Power Spectral Density	PASS	
15.205	Band Edge Emission	PASS	
15.203	Antenna Requirement	PASS	

NOTE:

(1) "N/A" denotes test is not applicable in this Test Report

1.1 TEST FACILITY

NTEK Testing Technology Co., Ltd
 Add.:1/F, Building E, Fenda Science Park, Sanwei Community, Xixiang Street, Bao'an District, Shenzhen P.R. China.
 FCC Registration No.:238937; IC Registration No.:9270A-1
 CNAS Registration No.:L5516

1.2 MEASUREMENT UNCERTAINTY

The reported uncertainty of measurement $y \pm U$, where expanded uncertainty U is based on a standard uncertainty multiplied by a coverage factor of $k=2$, providing a level of confidence of approximately 95 %.

No.	Item	Uncertainty
1	Conducted Emission Test	$\pm 1.38\text{dB}$
2	RF power,conducted	$\pm 0.16\text{dB}$
3	Spurious emissions,conducted	$\pm 0.21\text{dB}$
4	All emissions,radiated(<1G)	$\pm 4.68\text{dB}$
5	All emissions,radiated(>1G)	$\pm 4.89\text{dB}$
6	Temperature	$\pm 0.5^\circ\text{C}$
7	Humidity	$\pm 2\%$

2. GENERAL INFORMATION

2.1 GENERAL DESCRIPTION OF EUT

Equipment	TeckNet F32 Bluetooth FM Transmitter	
Trade Name	TECKNET	
Model Name	F32	
Serial Model	N/A	
Model Difference	N/A	
Product Description	The EUT is a TeckNet F32 Bluetooth FM Transmitter BLE	
	Operation Frequency:	2402~2480MHz
	Modulation Type:	GFSK
	Number Of Channel	40CH
	Antenna Designation:	Please see Note 3.
	Antenna Gain (dBi)	1.0dBi
	BT	
	Operation Frequency:	2402~2480 MHz
	Modulation Type:	BT(1Mbps): GFSK BT EDR(2Mbps): $\pi/4$ -DQPSK BT EDR(3Mbps): 8-DPSK
	Bit Rate of Transmitter	1Mbps/2Mbps/3Mbps
	Number Of Channel	79 CH
	Antenna Gain (dBi)	1.0dBi
	FM	
	Operation Frequency:	88.1-107.9MHz
	Modulation Type:	FM
	Number Of Channel	199CH.
Antenna Designation:	Wire antenna	
Antenna Gain(Peak)	0 dBi	
Channel List	Please refer to the Note 2.	
Ratings	DC 12.0V	
Adapter	N/A	
Battery	N/A	
Connecting I/O Port(s)	Please refer to the User's Manual	

Note:

1. For a more detailed features description, please refer to the manufacturer's specifications or the User's Manual.

2.

Channel	Frequency (MHz)
00	2402
01	2404
.....
.....
...	...
.....
38	2478
39	2480

3.

Table for Filed Antenna

Ant	Brand	Model Name	Antenna Type	Connector	Gain (dBi)	NOTE
A	N/A	N/A	PCB Antenna	N/A	1.0	BT Antenna

2.2 DESCRIPTION OF TEST MODES

To investigate the maximum EMI emission characteristics generates from EUT, the test system was pre-scanning tested base on the consideration of following EUT operation mode or test configuration mode which possible have effect on EMI emission level. Each of these EUT operation mode(s) or test configuration mode(s) mentioned above was evaluated respectively.

Pretest Mode	Description
Mode 1	CH00
Mode 2	CH19
Mode 3	CH39
Mode 4	Link Mode

For Conducted Emission	
Final Test Mode	Description
Mode 4	Link Mode

For Radiated Emission	
Final Test Mode	Description
Mode 1	CH00
Mode 2	CH19
Mode 3	CH39
Mode 4	Link Mode

Note:

- (1) The measurements are performed at the highest, middle, lowest available channels.
- (2) The measurements are performed at all Bit Rate of Transmitter, the worst data was reported

2.3 BLOCK DIGRAM SHOWING THE CONFIGURATION OF SYSTEM TESTED

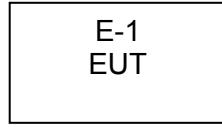

2.4 DESCRIPTION OF SUPPORT UNITS(CONDUCTED MODE)

The EUT has been tested as an independent unit together with other necessary accessories or support units. The following support units or accessories were used to form a representative test configuration during the tests.

Item	Equipment	Brand	Model/Type No.	Series No.	Note
E-1	TeckNet F32 Bluetooth FM Transmitter	TECKNET	F32	N/A	EUT

Item	Shielded Type	Ferrite Core	Length	Note

Note:

- (1) The support equipment was authorized by Declaration of Confirmation.
- (2) For detachable type I/O cable should be specified the length in cm in 『Length』 column.

2.5 EQUIPMENTS LIST FOR ALL TEST ITEMS

Radiation Test equipment

Item	Kind of Equipment	Manufacturer	Type No.	Serial No.	Last calibration	Calibrated until	Calibration period
1	Spectrum Analyzer	Agilent	E4407B	MY45108040	2014.07.06	2015.07.05	1 year
2	Test Receiver	R&S	ESPI	101318	2014.06.07	2015.06.06	1 year
3	Bilog Antenna	TESEQ	CBL6111D	31216	2014.07.06	2015.07.05	1 year
4	50Ω Coaxial Switch	Anritsu	MP59B	6200264416	2014.06.07	2015.06.06	1 year
5	Spectrum Analyzer	ADVANTEST	R3132	150900201	2014.06.07	2015.06.06	1 year
6	Horn Antenna	EM	EM-AH-10180	2011071402	2014.07.06	2015.07.05	1 year
7	Horn Ant	Schwarzbeck	BBHA 9170	9170-181	2014.07.06	2015.07.05	1 year
8	Amplifier	EM	EM-30180	060538	2014.12.22	2015.12.21	1 year
9	Loop Antenna	ARA	PLA-1030/B	1029	2014.06.08	2015.06.07	1 year
10	Power Meter	R&S	NRVS	100696	2014.07.06	2015.07.05	1 year
11	Power Sensor	R&S	URV5-Z4	0395.1619.05	2014.07.06	2015.07.05	1 year

Conduction Test equipment

Item	Kind of Equipment	Manufacturer	Type No.	Serial No.	Last calibration	Calibrated until	Calibration period
1	Test Receiver	R&S	ESCI	101160	2014.06.06	2015.06.05	1 year
2	LISN	R&S	ENV216	101313	2014.08.24	2015.08.23	1 year
3	LISN	EMCO	3816/2	00042990	2014.08.24	2015.08.23	1 year
4	50Ω Coaxial Switch	Anritsu	MP59B	6200264417	2014.06.07	2015.06.06	1 year
5	Passive Voltage Probe	R&S	ESH2-Z3	100196	2014.06.07	2015.06.06	1 year
6	Absorbing clamp	R&S	MOS-21	100423	2014.06.08	2015.06.07	1 year

1	Attenuation	MCE	24-10-34	BN9258	2014.06.08	2015.06.07	1 year
---	-------------	-----	----------	--------	------------	------------	--------

3. EMC EMISSION TEST

3.1 CONDUCTED EMISSION MEASUREMENT

3.1.1 POWER LINE CONDUCTED EMISSION Limits (Frequency Range 150KHz-30MHz)

FREQUENCY (MHz)	Class A (dBuV)		Class B (dBuV)		Standard
	Quasi-peak	Average	Quasi-peak	Average	
0.15 -0.5	79.00	66.00	66 - 56 *	56 - 46 *	CISPR
0.50 -5.0	73.00	60.00	56.00	46.00	CISPR
5.0 -30.0	73.00	60.00	60.00	50.00	CISPR

0.15 -0.5	79.00	66.00	66 - 56 *	56 - 46 *	FCC
0.50 -5.0	73.00	60.00	56.00	46.00	FCC
5.0 -30.0	73.00	60.00	60.00	50.00	FCC

Note:

- (1) The tighter limit applies at the band edges.
- (2) The limit of " * " marked band means the limitation decreases linearly with the logarithm of the frequency in the range.

The following table is the setting of the receiver

Receiver Parameters	Setting
Attenuation	10 dB
Start Frequency	0.15 MHz
Stop Frequency	30 MHz
IF Bandwidth	9 kHz

3.1.2 TEST PROCEDURE

- a. The EUT was placed 0.8 meters from the horizontal ground plane with EUT being connected to the power mains through a line impedance stabilization network (LISN). All other support equipments powered from additional LISN(s). The LISN provide 50 Ohm/ 50uH of coupling impedance for the measuring instrument.
- b. Interconnecting cables that hang closer than 40 cm to the ground plane shall be folded back and forth in the center forming a bundle 30 to 40 cm long.
- c. I/O cables that are not connected to a peripheral shall be bundled in the center. The end of the cable may be terminated, if required, using the correct terminating impedance. The overall length shall not exceed 1 m.
- d. LISN at least 80 cm from nearest part of EUT chassis.
- e. For the actual test configuration, please refer to the related Item –EUT Test Photos.

3.1.3 DEVIATION FROM TEST STANDARD

No deviation

3.1.4 TEST SETUP

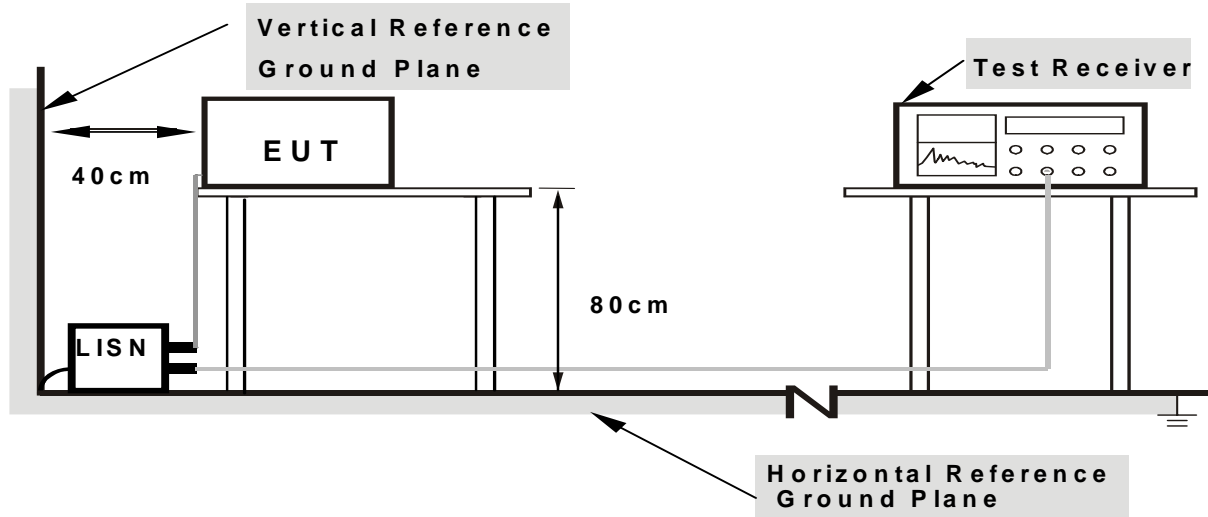

- Note:**
- 1. Support units were connected to second LISN.
 - 2. Both of LISNs (AMN) are 80 cm from EUT and at least 80 from other units and other metal planes

3.1.5 EUT OPERATING CONDITIONS

The EUT was configured for testing in a typical fashion (as a customer would normally use it). The EUT has been programmed to continuously transmit during test. This operating condition was tested and used to collect the included data.

3.1.6 TEST RESULTS

EUT :	TeckNet F32 Bluetooth FM Transmitter	Model Name. :	F32
Temperature :	26 °C	Relative Humidity :	56%
Pressure :	1010hPa	Phase :	N/A
Test Voltage :	N/A	Test Mode :	N/A

3.2 RADIATED EMISSION MEASUREMENT

3.2.1 RADIATED EMISSION LIMITS (Frequency Range 9kHz-1000MHz)

20dBc in any 100 kHz bandwidth outside the operating frequency band. In case the emission fall within the restricted band specified on 15.205(a), then the 15.209(a) limit in the table below has to be followed.

Frequencies (MHz)	Field Strength (microrvolts/meter)	Measurement Distance (meters)
0.009~0.490	2400/F(KHz)	300
0.490~1.705	24000/F(KHz)	30
1.705~30.0	30	30
30~88	100	3
88~216	150	3
216~960	200	3
Above 960	500	3

LIMITS OF RADIATED EMISSION MEASUREMENT (Above 1000MHz)

FREQUENCY (MHz)	Class B (dBuV/m) (at 3M)	
	PEAK	AVERAGE
Above 1000	74	54

Notes:

- (1) The limit for radiated test was performed according to FCC PART 15C.
- (2) The tighter limit applies at the band edges.
- (3) Emission level (dBuV/m)=20log Emission level (uV/m).

Spectrum Parameter	Setting
Attenuation	Auto
Start Frequency	1000 MHz
Stop Frequency	10th carrier harmonic
RB / VB (emission in restricted band)	1 MHz / 1 MHz for Peak, 1 MHz / 10Hz for Average

Receiver Parameter	Setting
Attenuation	Auto
Start ~ Stop Frequency	9kHz~150kHz / RB 200Hz for QP
Start ~ Stop Frequency	150kHz~30MHz / RB 9kHz for QP
Start ~ Stop Frequency	30MHz~1000MHz / RB 120kHz for QP

3.2.2 TEST PROCEDURE

- a. The measuring distance of at 3 m shall be used for measurements at frequency up to 1GHz. For frequencies above 1GHz, any suitable measuring distance may be used.
- b. The EUT was placed on the top of a rotating table 0.8 meters above the ground at a 3 meter test site. The table was rotated 360 degrees to determine the position of the highest radiation.
- c. The height of the equipment or of the substitution antenna shall be 0.8 m; the height of the test antenna shall vary between 1 m to 4 m. Both horizontal and vertical polarizations of the antenna are set to make the measurement.
- d. The initial step in collecting conducted emission data is a spectrum analyzer peak detector mode pre-scanning the measurement frequency range. Significant peaks are then marked and then Quasi Peak detector mode re-measured.
- e. If the Peak Mode measured value compliance with and lower than Quasi Peak Mode Limit, the EUT shall be deemed to meet QP Limits and then no additional QP Mode measurement performed.
- f. For the actual test configuration, please refer to the related Item –EUT Test Photos.

Note:

Both horizontal and vertical antenna polarities were tested and performed pretest to three orthogonal axis. The worst case emissions were reported

During the radiated emission test, the Spectrum Analyzer was set with the following configurations:

Frequency Band (MHz)	Function	Resolution bandwidth	Video Bandwidth
30 to 1000	QP	120 kHz	300 kHz
Above 1000	Peak	1 MHz	1 MHz
	Peak	1 MHz	10 Hz

3.2.3 DEVIATION FROM TEST STANDARD

No deviation

3.2.4 TEST SETUP

(A) Radiated Emission Test-Up Frequency Below 30MHz

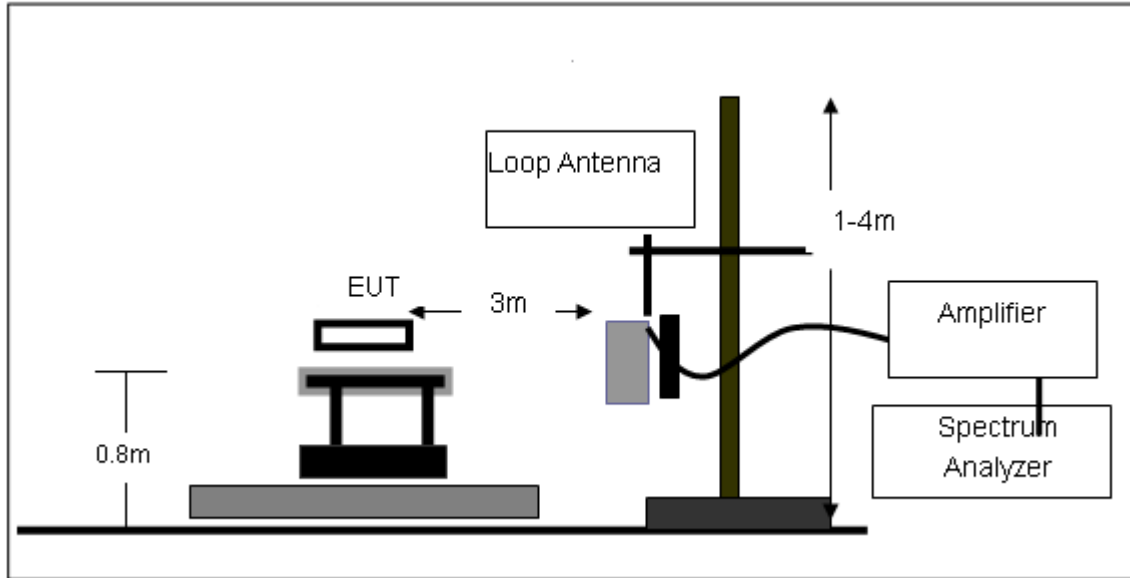

(B) Radiated Emission Test-Up Frequency 30MHz~1GHz

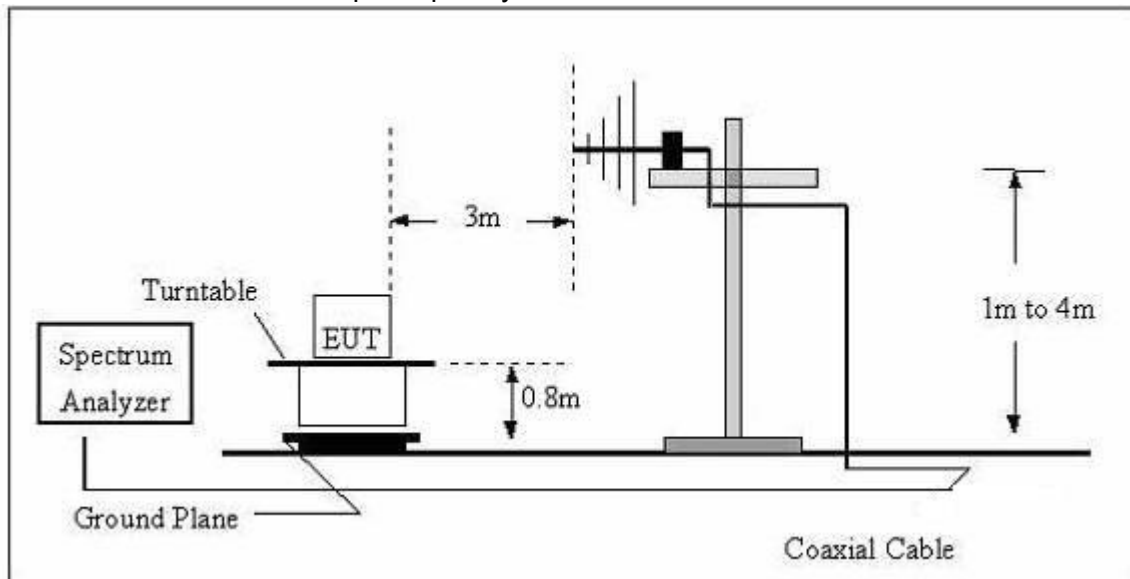

(C) Radiated Emission Test-Up Frequency Above 1GHz

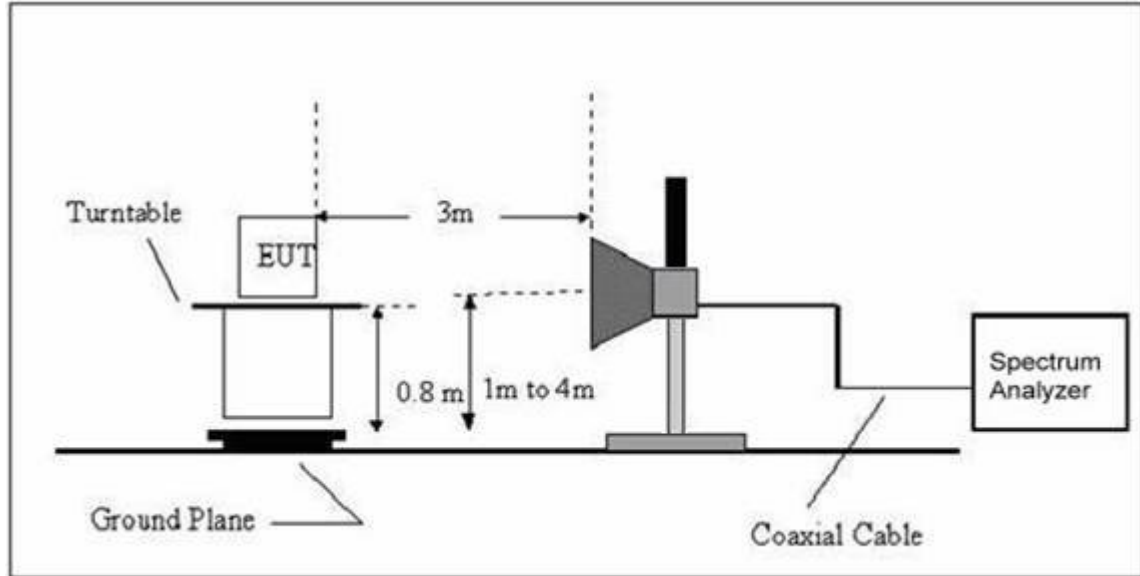

3.2.5 EUT OPERATING CONDITIONS

The EUT tested system was configured as the statements of 2.4 Unless otherwise a special operating condition is specified in the follows during the testing.

3.2.6 TEST RESULTS (BETWEEN 9KHZ – 30 MHZ)

EUT:	TeckNet F32 Bluetooth FM Transmitter	Model Name. :	F32
Temperature:	20 °C	Relative Humidity:	48%
Pressure:	1010 hPa	Test Voltage :	DC 12.0V
Test Mode :	TX	Polarization :	--

Freq.	Reading	Limit	Margin	State
(MHz)	(dBuV/m)	(dBuV/m)	(dB)	P/F
--	--	--	--	Pass
--	--	--	--	Pass

NOTE:

The amplitude of spurious emissions which are attenuated by more than 20dB below the permissible value has no need to be reported.

Distance extrapolation factor = $40 \log(\text{specific distance}/\text{test distance})$ (dB);

Limit line = specific limits(dBuv) + distance extrapolation factor.

3.2.7 TEST RESULTS (BETWEEN 30MHZ – 1GHZ)

EUT :	TeckNet F32 Bluetooth FM Transmitter	Model Name :	F32
Temperature :	20 °C	Relative Humidity :	48%
Pressure:	1010 hPa	Test Voltage :	DC 12.0V
Test Mode :	TX		

Polar (H/V)	Frequency	Meter Reading	Factor	Emission Level	Limits	Margin	Remark
	(MHz)	(dBuV)	(dB)	(dBuV/m)	(dBuV/m)	(dB)	
V	38.3462	20.95	14.58	35.53	40.00	-4.47	QP
V	49.8813	21.83	10.71	32.54	40.00	-7.46	QP
V	84.1098	17.67	6.69	24.36	40.00	-15.64	QP
V	122.4038	20.47	12.05	32.52	43.50	-10.98	QP
V	213.0149	22.96	11.66	34.62	43.50	-8.88	QP
V	389.3548	12.70	17.87	30.57	46.00	-15.43	QP

Remark:

Absolute Level= ReadingLevel+ Factor, Margin= Absolute Level - Limit

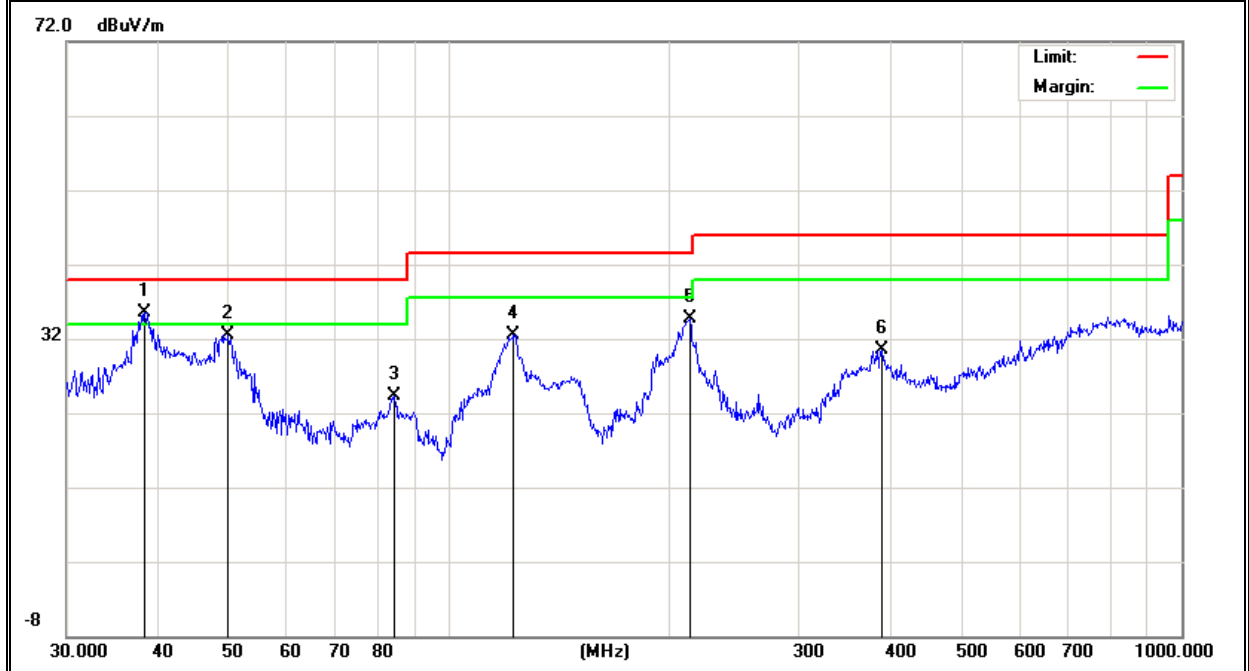

Polar (H/V)	Frequency	Meter Reading	Factor	Emission Level	Limits	Margin	Remark
	(MHz)	(dBuV)	(dB)	(dBuV/m)	(dBuV/m)	(dB)	
H	38.6160	14.79	14.41	29.20	40.00	-10.80	QP
H	85.2980	13.64	6.94	20.58	40.00	-19.42	QP
H	147.9214	19.64	10.63	30.27	43.50	-13.23	QP
H	210.7860	26.01	11.51	37.52	43.50	-5.98	QP
H	392.0951	13.60	17.98	31.58	46.00	-14.42	QP
H	869.1299	8.93	27.15	36.08	46.00	-9.92	QP

Remark:

Absolute Level= ReadingLevel+ Factor, Margin= Absolute Level - Limit

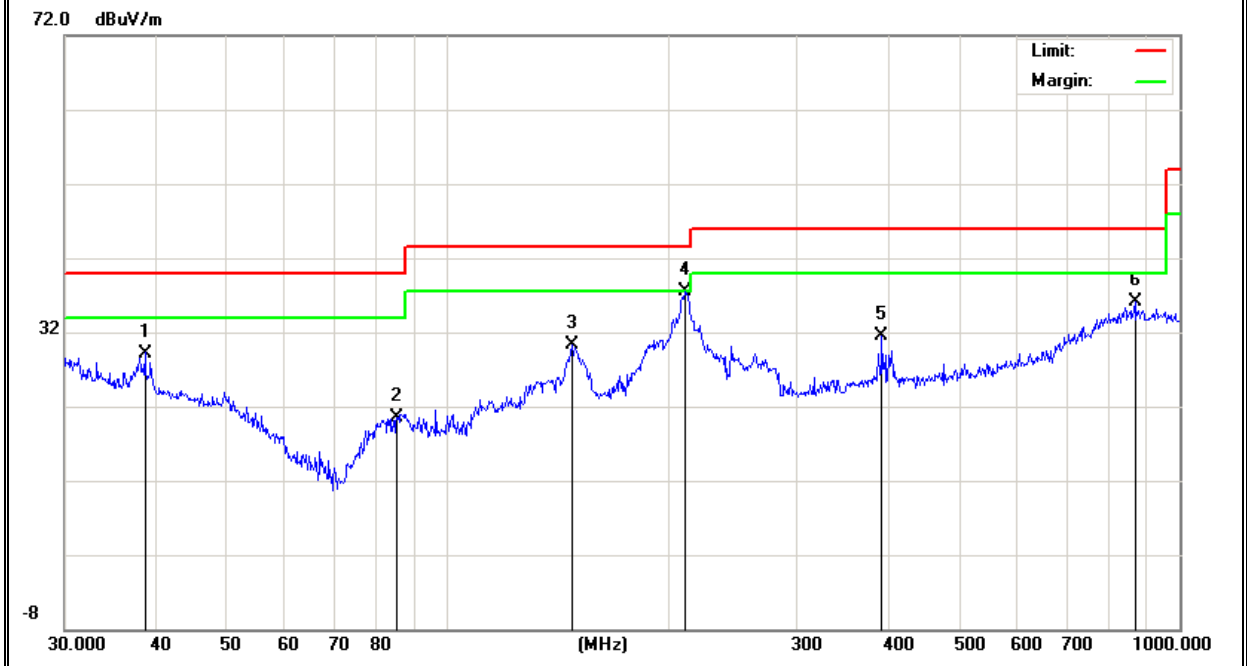

3.2.8 TEST RESULTS (ABOVE 1000 MHZ)

EUT :	TeckNet F32 Bluetooth FM Transmitter	Model Name :	F32
Temperature :	20 °C	Relative Humidity :	48%
Pressure:	1010 hPa	Test Voltage :	DC 12.0V
Test Mode :	TX		

Frequency (MHz)	Reading (dBµV)	Factor (dB)	Corrected Amplitude (dBµV/m)	Limit (dBµV/m)	Margin (dB)	Remark	Polar (H/V)
Low Channel (2402 MHz)-Above 1G							
4804.237	64.76	-3.64	61.12	74	-12.88	Pk	Vertical
4804.237	47.83	-3.64	44.19	54	-9.81	AV	Vertical
7206.088	55.61	-0.95	54.66	74	-19.34	Pk	Vertical
7206.088	47.52	-0.95	46.57	54	-7.43	AV	Vertical
4804.106	66.08	-3.64	62.44	74	-11.56	Pk	Horizontal
4804.106	54.41	-3.64	50.77	54	-3.23	AV	Horizontal
7206.813	55.38	-0.96	54.42	74	-19.58	Pk	Horizontal
7206.813	46.09	-0.96	45.13	54	-8.87	AV	Horizontal
Mid Channel (2440 MHz)-Above 1G							
4880.000	67.12	-3.67	63.45	74	-10.55	Pk	Vertical
4880.000	48.35	-3.67	44.68	54	-9.32	AV	Vertical
7320.000	55.74	-0.82	54.92	74	-19.08	Pk	Vertical
7320.000	46.58	-0.82	45.76	54	-8.24	AV	Vertical
4880.000	63.38	-3.67	59.71	74	-14.29	Pk	Horizontal
4880.000	47.76	-3.67	44.09	54	-9.91	AV	Horizontal
7320.000	56.78	-0.82	55.96	74	-18.04	Pk	Horizontal
7320.000	48.36	-0.82	47.54	54	-6.46	AV	Horizontal
High Channel (2480MHz)- Above 1G							
4960.000	55.14	-3.59	51.55	74	-22.45	Pk	Vertical
4960.000	46.37	-3.59	42.78	54	-11.22	AV	Vertical
7440.000	54.48	-0.68	53.80	74	-20.20	Pk	Vertical
7440.000	46.34	-0.68	45.66	54	-8.34	AV	Vertical
4960.000	64.42	-3.59	60.83	74	-13.17	Pk	Horizontal
4960.000	44.53	-3.59	40.94	54	-13.06	AV	Horizontal
7440.000	57.63	-0.68	56.95	74	-17.05	Pk	Horizontal
7440.000	46.23	-0.68	45.55	54	-8.45	AV	Horizontal

Remark: Absolute Level= ReadingLevel+ Factor, Margin= Absolute Level - Limit

4. POWER SPECTRAL DENSITY TEST

4.1 APPLIED PROCEDURES / LIMIT

FCC Part15 (15.247) , Subpart C				
Section	Test Item	Limit	Frequency Range (MHz)	Result
15.247	Power Spectral Density	8 dBm (in any 3KHz)	2400-2483.5	PASS

4.1.1 TEST PROCEDURE

1. Set analyzer center frequency to DTS channel center frequency.
2. Set the span to 1.5 times the DTS channel bandwidth.
3. 3 kHz ≤ Set the RBW ≤ 100 kHz.
4. Set the VBW ≥ 3 x RBW.
5. Detector = peak.
6. Sweep time = auto couple.
7. Trace mode = max hold.
8. Allow trace to fully stabilize.
9. Use the peak marker function to determine the maximum amplitude level within the RBW.
10. If measured value exceeds limit, reduce RBW (no less than 3 kHz) and repeat.

4.1.2 DEVIATION FROM STANDARD

No deviation.

4.1.3 TEST SETUP

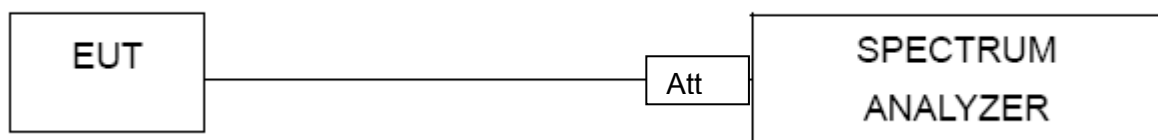

4.1.4 EUT OPERATION CONDITIONS

The EUT tested system was configured as the statements of 2.1 Unless otherwise a special operating condition is specified in the follows during the testing.

4.1.5 TEST RESULTS

EUT :	TeckNet F32 Bluetooth FM Transmitter	Model Name :	F32
Temperature :	25 °C	Relative Humidity :	56%
Pressure :	1015 hPa	Test Voltage :	DC 12.0V
Test Mode :	TX Mode /CH00, CH19, CH39		

Frequency	Power Density (dBm)	Limit (dBm)	Result
2402 MHz	-16.30	8	PASS
2440 MHz	-14.78	8	PASS
2480 MHz	-13.96	8	PASS

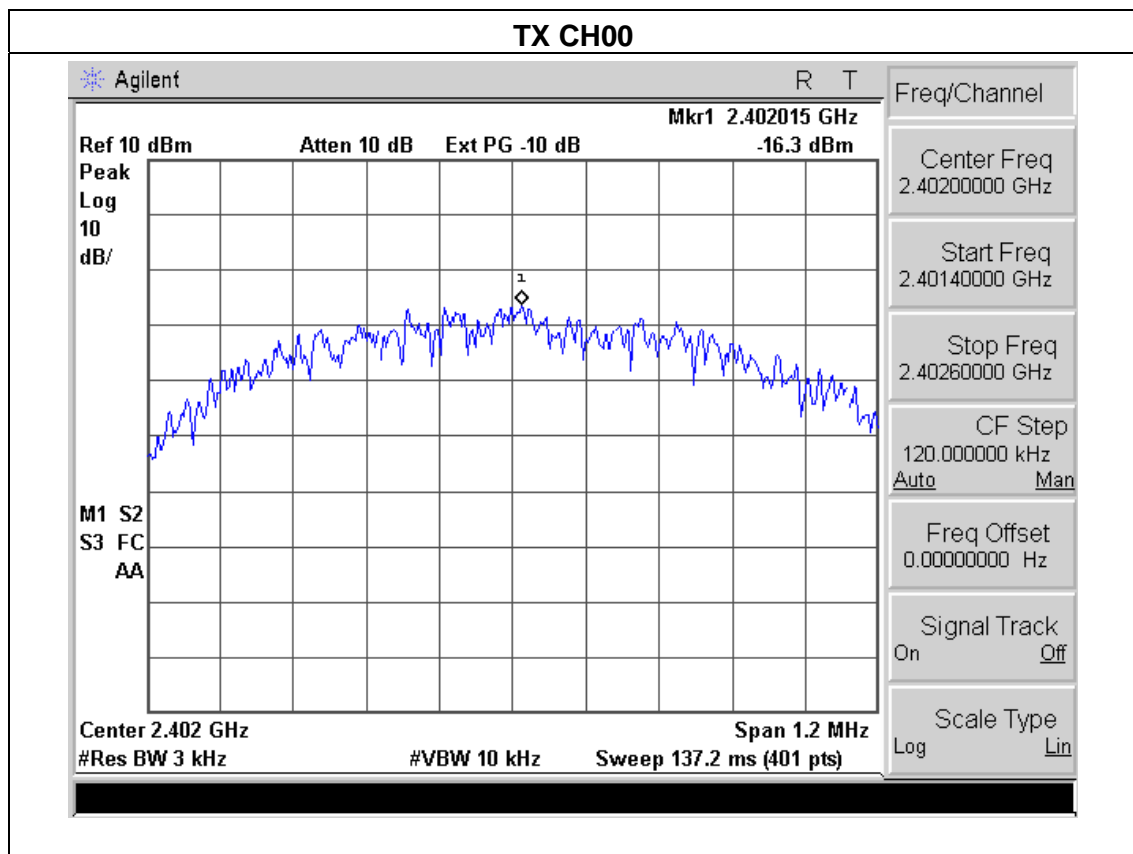

5. BANDWIDTH TEST

5.1 APPLIED PROCEDURES / LIMIT

FCC Part15 (15.247) , Subpart C				
Section	Test Item	Limit	Frequency Range (MHz)	Result
15.247(a)(2)	Bandwidth	$\geq 500\text{KHz}$ (6dB bandwidth)	2400-2483.5	PASS

5.1.1 TEST PROCEDURE

1. Set RBW = 100 kHz.
2. Set the video bandwidth (VBW) $\geq 3 \times$ RBW.
3. Detector = Peak.
4. Trace mode = max hold.
5. Sweep = auto couple.
6. Allow the trace to stabilize.
7. Measure the maximum width of the emission that is constrained by the frequencies associated with the two outermost amplitude points (upper and lower) that are attenuated by 6 dB relative to the maximum level measured in the fundamental emission.

TEST SETUP

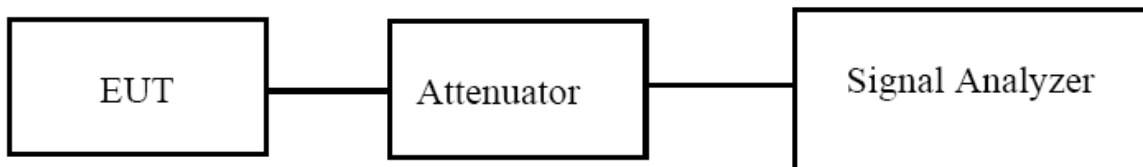

5.1.2 EUT OPERATION CONDITIONS

The EUT tested system was configured as the statements of 2.4 Unless otherwise a special operating condition is specified in the follows during the testing.

5.1.3 TEST RESULTS

EUT :	TeckNet F32 Bluetooth FM Transmitter	Model Name :	F32
Temperature :	25 °C	Relative Humidity :	56%
Pressure :	1012 hPa	Test Voltage :	DC 12.0V
Test Mode :	TX Mode /CH00, CH19, CH39		

Channel	Frequency (MHz)	6dB bandwidth (kHz)	Limit (kHz)	Result
Low	2402	738.062	500	Pass
Middle	2440	723.719	500	Pass
High	2480	725.947	500	Pass

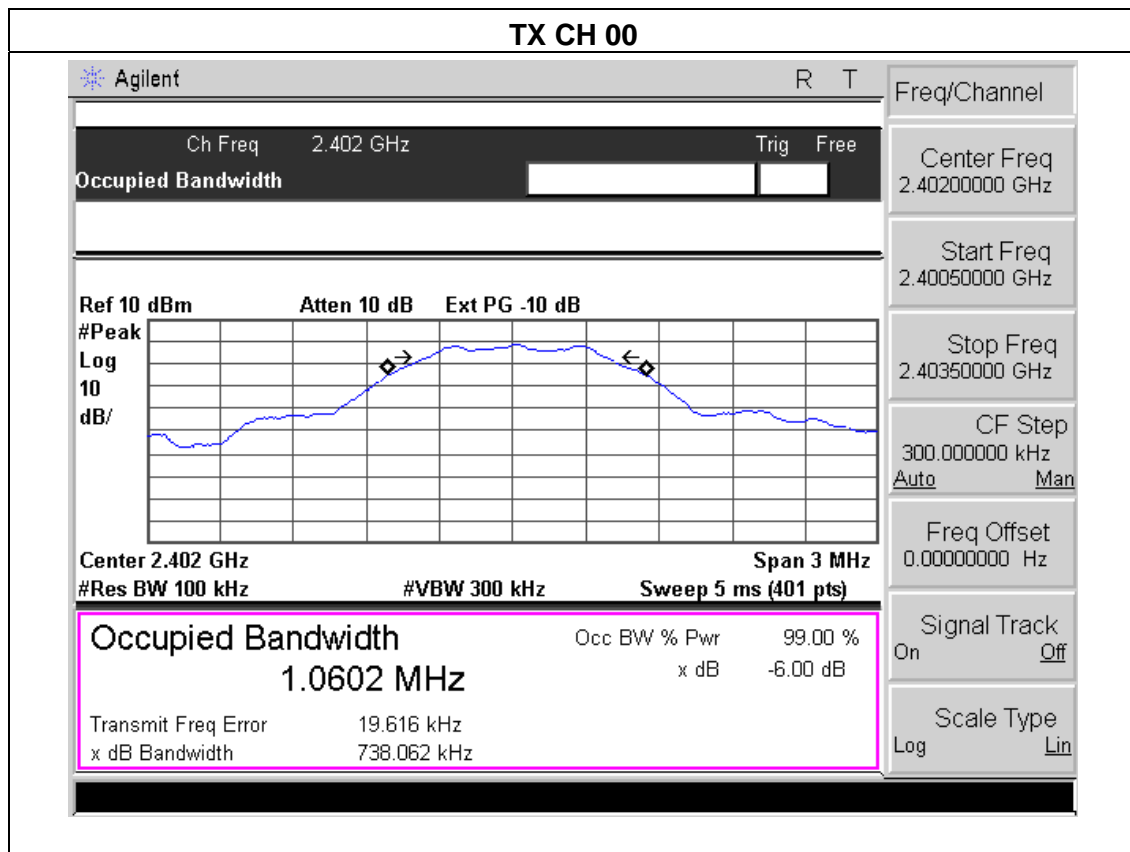

TX CH 19

Agilent
R T

Ch Freq 2.44 GHz
Trig Free

Occupied Bandwidth

Ref 10 dBm
Atten 10 dB
Ext PG -10 dB

#Peak
Log
10
dB/

Center 2.44 GHz

#Res BW 100 kHz

Span 3 MHz

#VBW 300 kHz

Sweep 5 ms (401 pts)

Occupied Bandwidth	Occ BW % Pwr	99.00 %
1.0601 MHz	x dB	-6.00 dB
Transmit Freq Error	17.998 kHz	
x dB Bandwidth	723.719 kHz	

Freq/Channel

Center Freq
2.44000000 GHz

Start Freq
2.43850000 GHz

Stop Freq
2.44150000 GHz

CF Step
300.000000 kHz
Auto Man

Freq Offset
0.00000000 Hz

Signal Track
On Off

Scale Type
Log Lin

TX CH 39

Agilent
R T

Ch Freq 2.48 GHz
Trig Free

Occupied Bandwidth

Ref 10 dBm
Atten 10 dB
Ext PG -10 dB

#Peak
Log
10
dB/

Center 2.48 GHz

#Res BW 100 kHz

Span 3 MHz

#VBW 300 kHz

Sweep 5 ms (401 pts)

Occupied Bandwidth	Occ BW % Pwr	99.00 %
1.0586 MHz	x dB	-6.00 dB
Transmit Freq Error	21.677 kHz	
x dB Bandwidth	725.947 kHz	

Freq/Channel

Center Freq
2.48000000 GHz

Start Freq
2.47850000 GHz

Stop Freq
2.48150000 GHz

CF Step
300.000000 kHz
Auto Man

Freq Offset
0.00000000 Hz

Signal Track
On Off

Scale Type
Log Lin

6. PEAK OUTPUT POWER TEST

6.1 APPLIED PROCEDURES / LIMIT

FCC Part15 (15.247) , Subpart C				
Section	Test Item	Limit	Frequency Range (MHz)	Result
15.247(b)(3)	Peak Output Power	1 watt or 30dBm	2400-2483.5	PASS

6.1.1 TEST PROCEDURE

- a. The EUT was directly connected to the Power meter

6.1.2 DEVIATION FROM STANDARD

No deviation.

6.1.3 TEST SETUP



6.1.4 EUT OPERATION CONDITIONS

The EUT tested system was configured as the statements of 2.4 Unless otherwise a special operating condition is specified in the follows during the testing.

6.1.5 TEST RESULTS

EUT :	TeckNet F32 Bluetooth FM Transmitter	Model Name :	F32
Temperature :	25 °C	Relative Humidity :	60%
Pressure :	1012 hPa	Test Voltage :	DC 12.0V
Test Mode :	TX Mode		

Test Channe	Frequency	Maximum Conducted Output Power(PK)	LIMIT
	(MHz)	(dBm)	dBm
CH00	2402	-0.377	30
CH19	2440	-0.076	30
CH39	2480	0.514	30

7. 100 KHZ BANDWIDTH OF FREQUENCY BAND EDGE

APPLICABLE STANDARD

In any 100 kHz bandwidth outside the frequency band in which the spread spectrum or digitally modulated intentional radiator is operating, the radio frequency power that is produced by the intentional radiator shall be at least 20 dB below that in the 100 kHz bandwidth within the band that contains the highest level of the desired power, based on either an RF conducted or a radiated measurement, provided the transmitter demonstrates compliance with the peak conducted power limits. If the transmitter complies with the conducted power limits based on the use of RMS averaging over a time interval, as permitted under paragraph (b)(3) of this section, the attenuation required under this paragraph shall be 30 dB instead of 20 dB. Attenuation below the general limits specified in §15.209(a) is not required. In addition, radiated emissions which fall in the restricted bands, as defined in §15.205(a), must also comply with the radiated emission limits specified in §15.209(a) (see §15.205(c)).

TEST PROCEDURE

- a) Check the calibration of the measuring instrument using either an internal calibrator or a known signal from an external generator.
- b) Position the EUT without connection to measurement instrument. Turn on the EUT and connect its antenna terminal to measurement instrument via a low loss cable. Then set it to any one measured frequency within its operating range, and make sure the instrument is operated in its linear range.
- c) Set RBW to 100 kHz and VBW of spectrum analyzer to 300 kHz with a convenient frequency span including 100 kHz bandwidth from band edge.
- d) Measure the highest amplitude appearing on spectral display and set it as a reference level. Plot the graph with marking the highest point and edge frequency.
- e) Repeat above procedures until all measured frequencies were complete.

7.1 DEVIATION FROM STANDARD

No deviation.

7.2 TEST SETUP

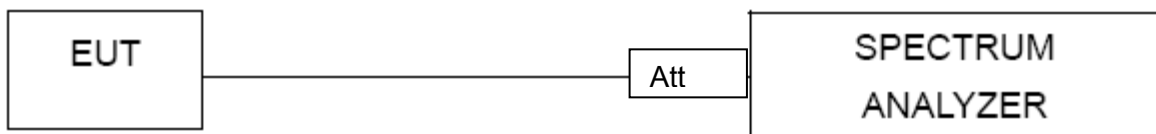

7.3 EUT OPERATION CONDITIONS

The EUT tested system was configured as the statements of 2.4 Unless otherwise a special operating condition is specified in the follows during the testing.

7.4 TEST RESULTS

EUT :	TeckNet F32 Bluetooth FM Transmitter	Model Name :	F32
Temperature :	25 °C	Relative Humidity :	56%
Pressure :	1012 hPa	Test Voltage :	DC 12.0V

Frequency Band	Delta Peak to band emission (dBc)	> Limit (dBc)	Result
Left-band	36.43	20	Pass
Right-band	51.16	20	Pass

Radiated band edge:

Frequency (MHz)	Meter Reading (dBµV)	Factor (dB)	Emission Level (dBµV/m)	Limits (dBµV/m)	Margin (dB)	Detector Type	Comment
2390	44.87	-13.06	31.81	74	-42.19	peak	Vertical
2390	46.02	-13.06	32.96	74	-41.04	peak	Horizontal
2483.5	48.77	-12.78	35.99	74	-38.01	peak	Vertical
2483.5	48.06	-12.78	35.28	74	-38.72	peak	Horizontal

Note: Test method to see chapter 3.2 . When PK value is lower than the Average value limit, average not record.

Left Side

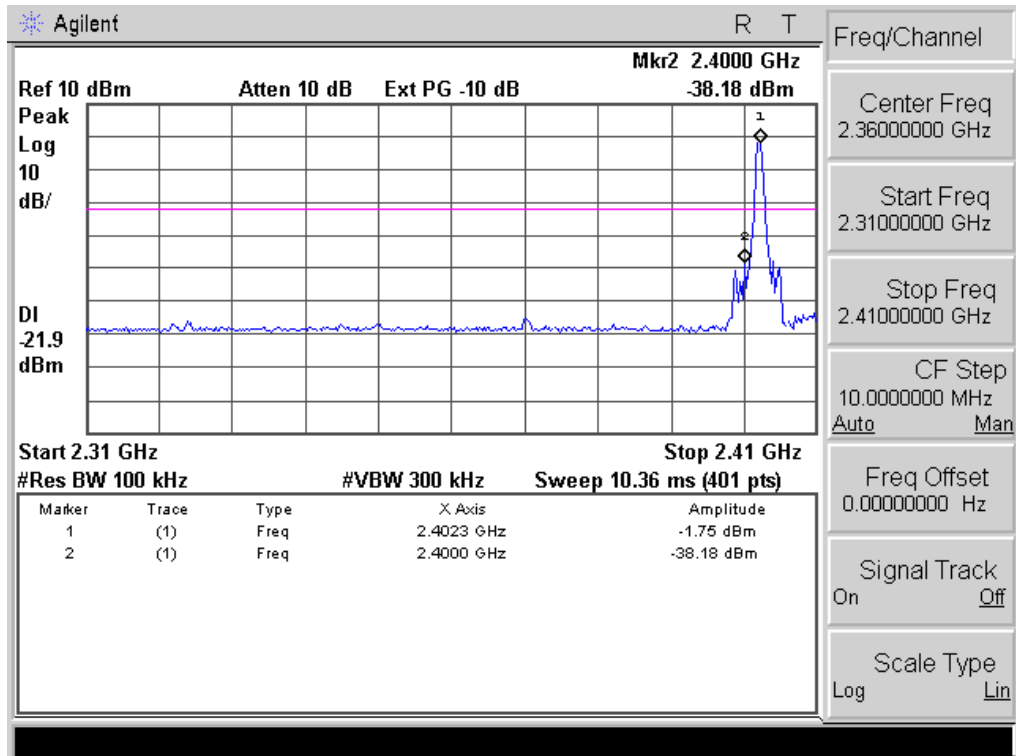

Right Side

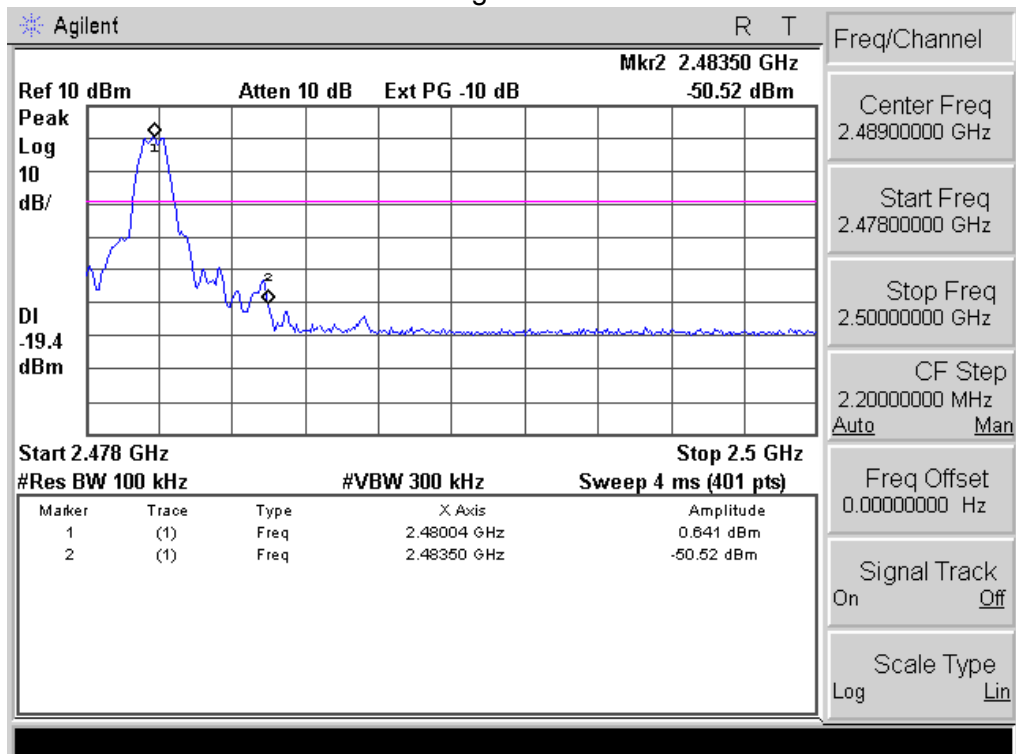

8. ANTENNA REQUIREMENT

8.1 STANDARD REQUIREMENT

15.203 requirement: For intentional device, according to 15.203: an intentional radiator shall be designed to ensure that no antenna other than that furnished by the responsible party shall be used with the device.

8.2 EUT ANTENNA

The EUT antenna is permanent attached antenna. It comply with the standard requirement.

9. EUT TEST PHOTO

Radiated Measurement Photos

