

**11.2. System Check Plots**

This appendix contains the following system validation distribution scans.

<b>Scan Reference Number</b>	<b>Title</b>
SYS/001	System Performance Check 2450MHz Body 23 05 16
SYS/002	System Performance Check 5250 MHz Body 23 05 16
SYS/003	System Performance Check 5600 MHz Body 23 05 16
SYS/004	System Performance Check 5750 MHz Body 23 05 16

SYS/001: System Performance Check 2450MHz Body 23 54 16

Date: 23/05/2016

DUT: Dipole 2450 MHz; SN725; Type: D2450V2; Serial: D2450V2 - SN:725

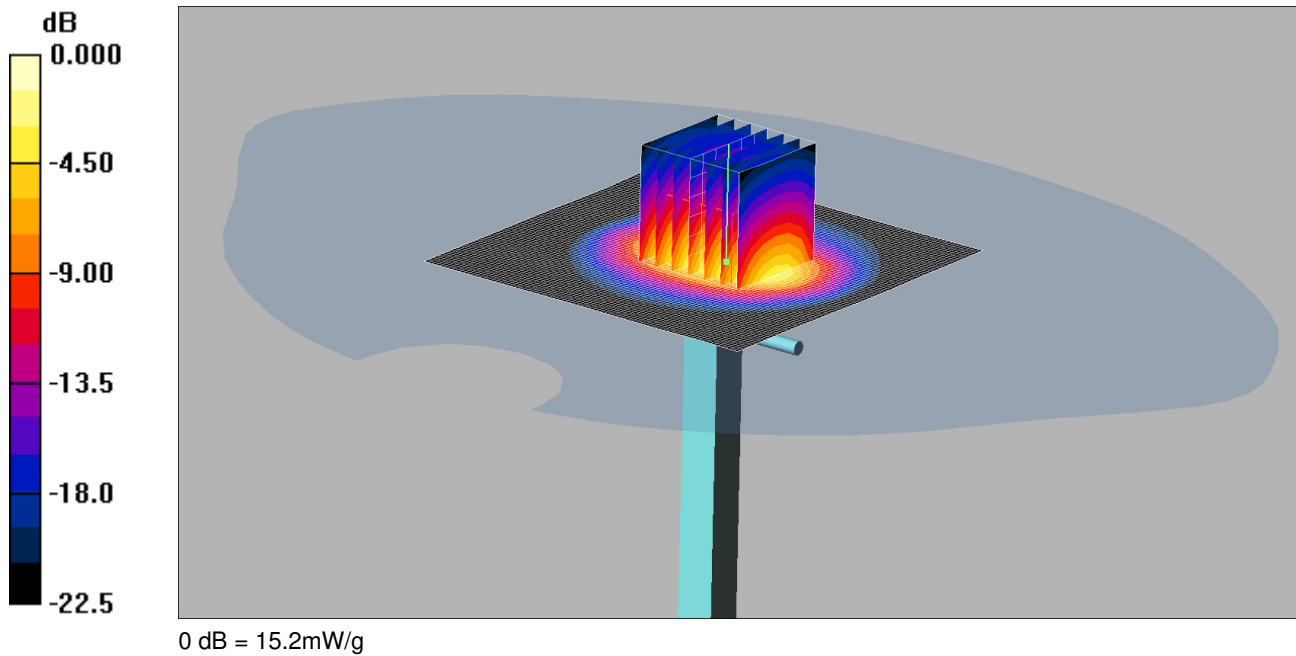

Communication System: CW; Frequency: 2450 MHz; Duty Cycle: 1:1  
 Medium: 2450 MHz MSL Medium parameters used:  $f = 2450 \text{ MHz}$ ;  $\sigma = 1.99 \text{ mho/m}$ ;  $\epsilon_r = 50.5$ ;  $\rho = 1000 \text{ kg/m}^3$   
 Phantom section: Flat Section

DASY4 Configuration:

- Probe: ES3DV3 - SN3341; ConvF(4.31, 4.31, 4.31);
- Sensor-Surface: 4mm (Mechanical Surface Detection)
- Electronics: DAE4 Sn432; Calibrated: 25/08/2015
- Phantom: SAM 12a (Site 57); Type: SAM 4.0; Serial: TP:1020
- Measurement SW: DASY4, V4.7 Build 80; Postprocessing SW: SEMCAD, V1.8 Build 186

$d=10\text{mm}$ ,  $P_{in}=250\text{mW}$  2/Area Scan (81x81x1): Measurement grid:  $dx=12\text{mm}$ ,  $dy=12\text{mm}$   
 Maximum value of SAR (interpolated) = 15.7 mW/g

$d=10\text{mm}$ ,  $P_{in}=250\text{mW}$  2/Zoom Scan (7x7x7) (7x7x7)/Cube 0: Measurement grid:  $dx=5\text{mm}$ ,  $dy=5\text{mm}$ ,  $dz=5\text{mm}$   
 Reference Value = 87.9 V/m; Power Drift = 0.070 dB  
 Peak SAR (extrapolated) = 28.3 W/kg  
 SAR(1 g) = 13.2 mW/g; SAR(10 g) = 5.99 mW/g  
 Maximum value of SAR (measured) = 15.2 mW/g

SYS/002: System Performance Check 5250 MHz Body 23 05 16

Date: 23/05/2016

DUT: 5GHz Dipole SN:1222; Type: D5GHzV2; Serial: SN 1222

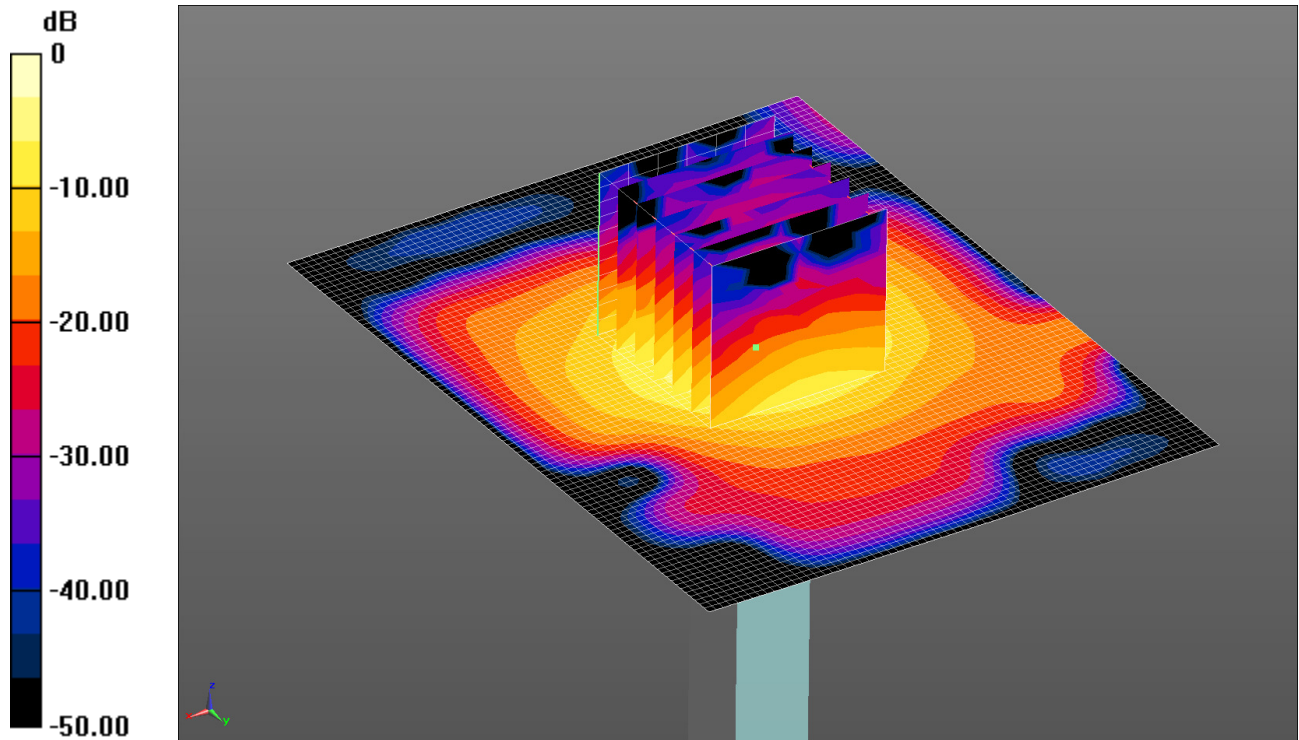

0 dB = 16.6 W/kg = 12.20 dBW/kg

Communication System: UID 0, CW (0); Frequency: 5250 MHz; Duty Cycle: 1:1  
 Medium: 5250/5600/5750 MHz MSL Medium parameters used:  $f = 5250$  MHz;  $\sigma = 5.352$  S/m;  $\epsilon_r = 47.364$ ;  $\rho = 1000$  kg/m<sup>3</sup>  
 Phantom section: Flat Section  
 DASY4 Configuration:  
 - Probe: EX3DV4 - SN3994; ConvF(4.38, 4.38, 4.38); Calibrated: 21/03/2016;  
 - Sensor-Surface: 2mm (Mechanical Surface Detection)  
 - Electronics: DAE4 Sn1438; Calibrated: 25/04/2016  
 - Phantom: ELI v5.0 (30deg probe tilt); Type: QDOVA002AA; Serial: 1253  
 - ; SEMCAD X Version 14.6.10 (7372)  
 Configuration/d=10mm, Pin=100mW 2 2/Area Scan (71x91x1): Interpolated grid: dx=1.000 mm, dy=1.000 mm  
 Maximum value of SAR (interpolated) = 16.8 W/kg  
 Configuration/d=10mm, Pin=100mW 2 2/Zoom Scan (7x7x12) 2 (7x7x12)/Cube 0: Measurement grid: dx=4mm, dy=4mm, dz=2mm  
 Reference Value = 43.55 V/m; Power Drift = 0.02 dB  
 Peak SAR (extrapolated) = 30.4 W/kg  
 SAR(1 g) = 8.12 W/kg; SAR(10 g) = 2.24 W/kg  
 Maximum value of SAR (measured) = 16.6 W/kg

SYS/003: System Performance Check 5600 MHz Body 23 05 16

Date: 23/05/2016

DUT: 5GHz Dipole SN:1222; Type: D5GHzV2; Serial: SN 1222

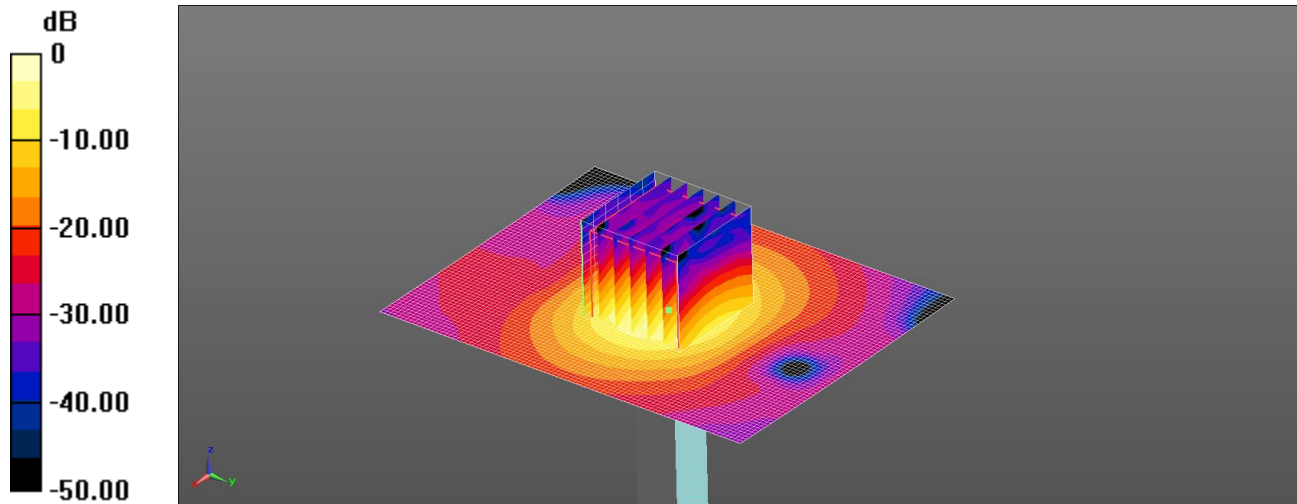

0 dB = 18.1 W/kg = 12.58 dBW/kg

Communication System: UID 0, CW (0); Frequency: 5600 MHz; Duty Cycle: 1:1  
 Medium: 5250/5600/5750 MHz MSL Medium parameters used:  $f = 5600$  MHz;  $\sigma = 5.867$  S/m;  $\epsilon_r = 46.615$ ;  $\rho = 1000$  kg/m<sup>3</sup>  
 Phantom section: Flat Section  
 DASY4 Configuration:  
 - Probe: EX3DV4 - SN3994; ConvF(3.76, 3.76, 3.76); Calibrated: 21/03/2016;  
 - Sensor-Surface: 2mm (Mechanical Surface Detection)  
 - Electronics: DAE4 Sn1438; Calibrated: 25/04/2016  
 - Phantom: ELI v5.0 (30deg probe tilt); Type: QDOVA002AA; Serial: 1253  
 - ; SEMCAD X Version 14.6.10 (7372)

Configuration/d=10mm, Pin=100mW 2 2 2 2/Area Scan (71x91x1): Interpolated grid: dx=1.000 mm, dy=1.000 mm  
 Maximum value of SAR (interpolated) = 18.9 W/kg  
 Configuration/d=10mm, Pin=100mW 2 2 2 2/Zoom Scan (7x7x12) (7x7x12)/Cube 0: Measurement grid: dx=4mm, dy=4mm, dz=2mm  
 Reference Value = 42.14 V/m; Power Drift = -0.03 dB  
 Peak SAR (extrapolated) = 33.7 W/kg  
 SAR(1 g) = 8.45 W/kg; SAR(10 g) = 2.35 W/kg  
 Maximum value of SAR (measured) = 18.1 W/kg

SYS/004: System Performance Check 5750 MHz Body 23 05 16

Date: 23/05/2016

DUT: 5GHz Dipole SN:1222; Type: D5GHzV2; Serial: SN 1222

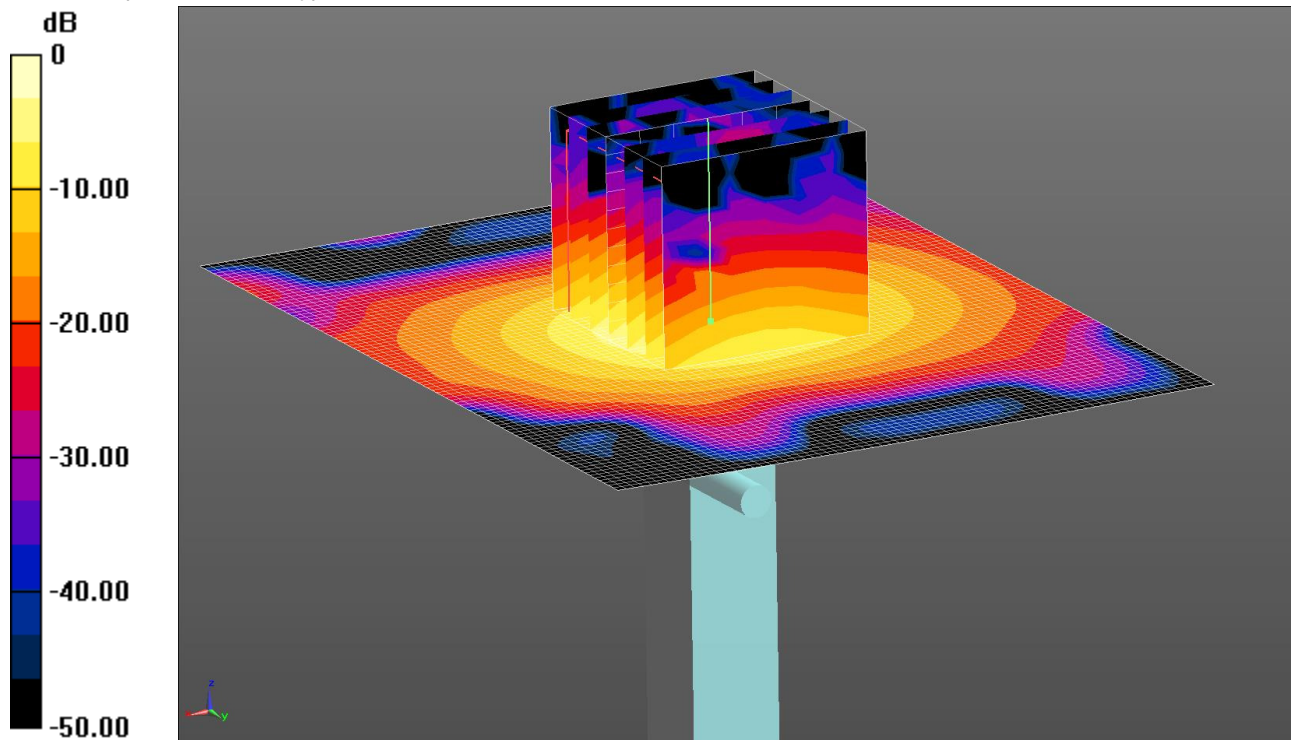

0 dB = 16.5 W/kg = 12.17 dBW/kg

Communication System: UID 0, CW (0); Frequency: 5750 MHz; Duty Cycle: 1:1  
 Medium: 5250/5600/5750 MHz MSL Medium parameters used:  $f = 5750$  MHz;  $\sigma = 6.121$  S/m;  $\epsilon_r = 46.264$ ;  $\rho = 1000$  kg/m<sup>3</sup>  
 Phantom section: Flat Section  
 DASY4 Configuration:  
 - Probe: EX3DV4 - SN3994; ConvF(3.99, 3.99, 3.99); Calibrated: 21/03/2016;  
 - Sensor-Surface: 2mm (Mechanical Surface Detection)  
 - Electronics: DAE4 Sn1438; Calibrated: 25/04/2016  
 - Phantom: ELI v5.0 (30deg probe tilt); Type: QDOVA002AA; Serial: 1253  
 - ; SEMCAD X Version 14.6.10 (7372)  
 Configuration/d=10mm, Pin=100mW 2/Area Scan (71x91x1): Interpolated grid: dx=1.000 mm, dy=1.000 mm  
 Maximum value of SAR (interpolated) = 16.6 W/kg  
 Configuration/d=10mm, Pin=100mW 2/Zoom Scan (7x7x12) (7x7x12)/Cube 0: Measurement grid: dx=4mm, dy=4mm, dz=2mm  
 Reference Value = 38.99 V/m; Power Drift = 0.09 dB  
 Peak SAR (extrapolated) = 31.8 W/kg  
 SAR(1 g) = 7.63 W/kg; SAR(10 g) = 2.11 W/kg  
 Maximum value of SAR (measured) = 16.5 W/kg

**11.3. SAR Test Plots**

This appendix contains the following SAR distribution scans.

Scan Reference Number	Title
SAR/001	Top of EUT Wi-Fi 2.4 GHz 802.11b Antenna 0 CH11
SAR/002	Top of EUT Wi-Fi 2.4 GHz 802.11b Antenna 1 CH1
SAR/003	Top of EUT Wi-Fi 2.4 GHz 802.11b Antenna 1 CH6
SAR/004	Top of EUT Wi-Fi 2.4 GHz 802.11b Antenna 1 CH11
SAR/005	Left of EUT Wi-Fi 5.0GHz 802.11a Antenna 0 CH52
SAR/006	Left of EUT Wi-Fi 5.0GHz 802.11a Antenna 0 CH104
SAR/007	Left of EUT Wi-Fi 5.0GHz 802.11a Antenna 0 CH56
SAR/008	Left of EUT Wi-Fi 5.0GHz 802.11a Antenna 0 CH64
SAR/009	Top of EUT Wi-Fi 5.0GHz 802.11a Antenna 0 CH52
SAR/010	Top of EUT Wi-Fi 5.0GHz 802.11a Antenna 0 CH104
SAR/011	Top of EUT Wi-Fi 5.0GHz 802.11a Antenna 0 CH149
SAR/012	Top of EUT Wi-Fi 5.0GHz 802.11a Antenna 1 CH48
SAR/013	Top of EUT Wi-Fi 5.0GHz 802.11a Antenna 1 CH52
SAR/014	Top of EUT Wi-Fi 5.0GHz 802.11a Antenna 1 CH108
SAR/015	Top of EUT Wi-Fi 5.0GHz 802.11a Antenna 1 CH165
SAR/016	Top of EUT Wi-Fi 5.0GHz 802.11a Antenna 0 CH56
SAR/017	Top of EUT Wi-Fi 5.0GHz 802.11a Antenna 0 CH64

DUT: Wedge; Type: Antenna 0; Serial: 05

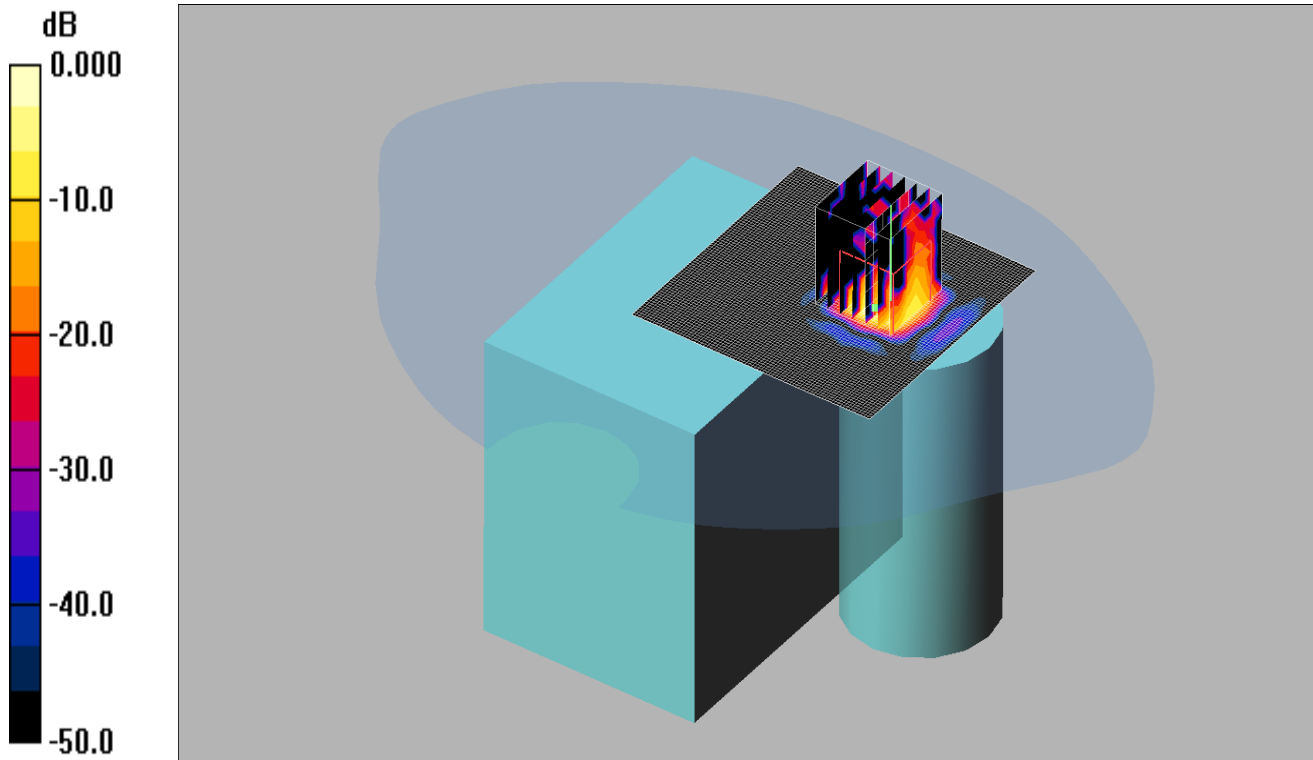

0 dB = 0.081mW/g

Communication System: WLAN; Frequency: 2462 MHz; Duty Cycle: 1:1  
 Medium: 2450 MHz MSL Medium parameters used (interpolated):  $f = 2462$  MHz;  $\sigma = 2.01$  mho/m;  $\epsilon_r = 50.5$ ;  $\rho = 1000$  kg/m<sup>3</sup>  
 Phantom section: Flat Section

DASY4 Configuration:

- Probe: ES3DV3 - SN3341; ConvF(4.31, 4.31, 4.31);

- Sensor-Surface: 3mm (Mechanical Surface Detection)
- Electronics: DAE4 Sn432; Calibrated: 25/08/2015
- Phantom: SAM 12a (Site 57); Type: SAM 4.0; Serial: TP:1020
- Measurement SW: DASY4, V4.7 Build 80; Postprocessing SW: SEMCAD, V1.8 Build 186

**Top of EUT/Area Scan (81x81x1):** Measurement grid: dx=12mm, dy=12mm

Maximum value of SAR (interpolated) = 0.061 mW/g

**Top of EUT/Zoom Scan (7x7x7) (7x7x7)/Cube 0:** Measurement grid: dx=5mm, dy=5mm, dz=5mm

Reference Value = 2.13 V/m; Power Drift = 1.41 dB

Peak SAR (extrapolated) = 0.373 W/kg

**SAR(1 g) = 0.053 mW/g; SAR(10 g) = 0.011 mW/g**

Maximum value of SAR (measured) = 0.081 mW/g

DUT: Wedge; Type: Antenna 1; Serial: 05

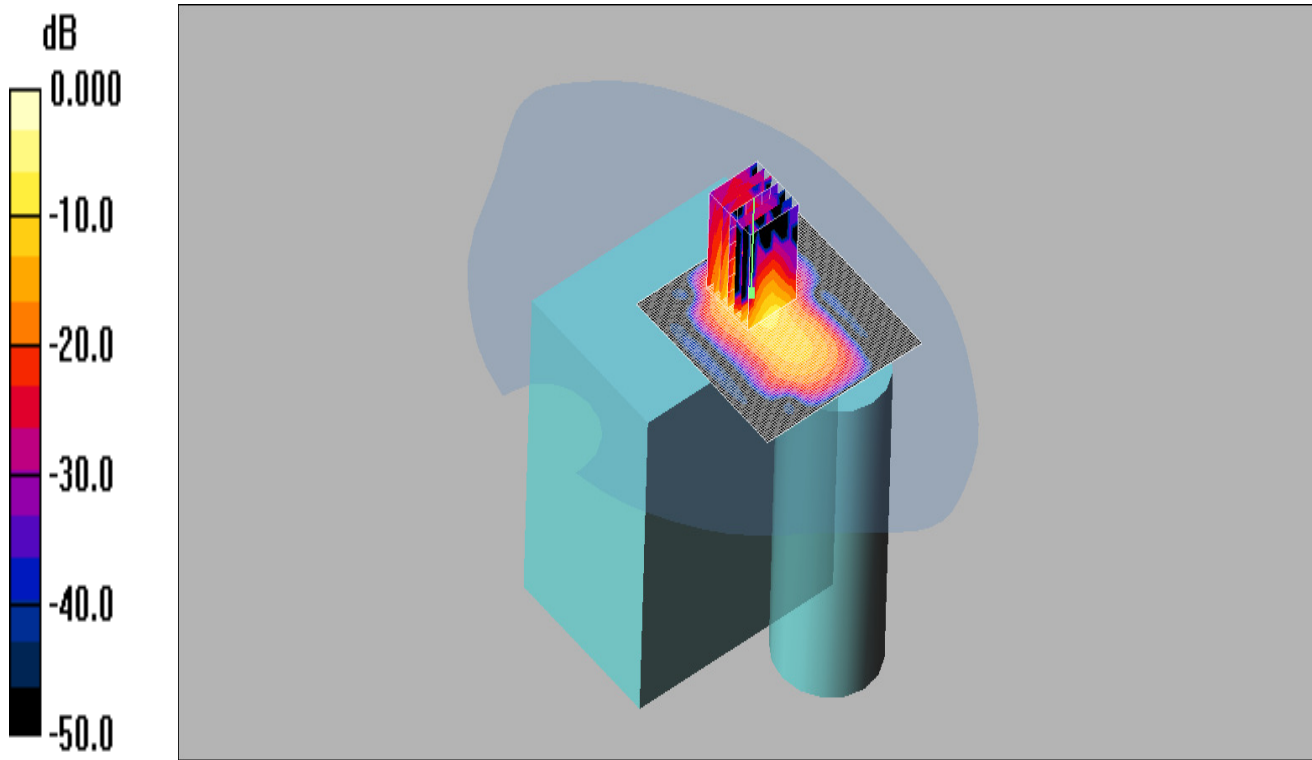

0 dB = 0.509mW/g

Communication System: WLAN; Frequency: 2412 MHz; Duty Cycle: 1:1  
 Medium: 2450 MHz MSL Medium parameters used (interpolated):  $f = 2412$  MHz;  $\sigma = 1.95$  mho/m;  $\epsilon_r = 50.6$ ;  $\rho = 1000$  kg/m<sup>3</sup>  
 Phantom section: Flat Section

DASY4 Configuration:

- Probe: ES3DV3 - SN3341; ConvF(4.31, 4.31, 4.31);
- Sensor-Surface: 3mm (Mechanical Surface Detection)
- Electronics: DAE4 Sn432; Calibrated: 25/08/2015
- Phantom: SAM 12a (Site 57); Type: SAM 4.0; Serial: TP:1020
- Measurement SW: DASY4, V4.7 Build 80; Postprocessing SW: SEMCAD, V1.8 Build 186

**Top of EUT/Area Scan (81x81x1):** Measurement grid: dx=12mm, dy=12mm  
 Maximum value of SAR (interpolated) = 0.413 mW/g  
**Top of EUT/Zoom Scan (7x7x7) (7x7x7)/Cube 0:** Measurement grid: dx=5mm, dy=5mm, dz=5mm  
 Reference Value = 1.72 V/m; Power Drift = 0.806 dB  
 Peak SAR (extrapolated) = 1.03 W/kg  
**SAR(1 g) = 0.268 mW/g; SAR(10 g) = 0.066 mW/g**  
 Maximum value of SAR (measured) = 0.509 mW/g



DUT: Wedge; Type: Antenna 1; Serial: 05

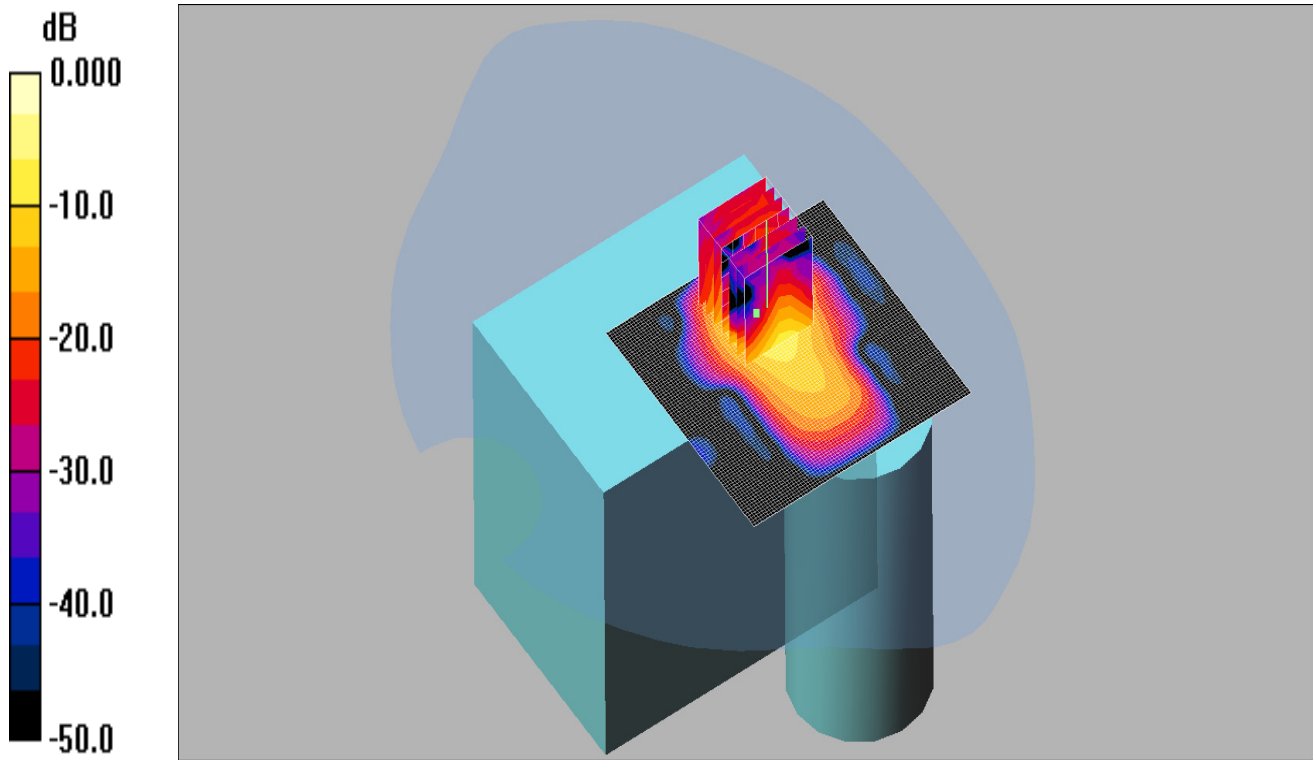

0 dB = 0.716mW/g

Communication System: WLAN; Frequency: 2437 MHz; Duty Cycle: 1:1  
 Medium: 2450 MHz MSL Medium parameters used (interpolated):  $f = 2437$  MHz;  $\sigma = 1.98$  mho/m;  $\epsilon_r = 50.5$ ;  $\rho = 1000$  kg/m<sup>3</sup>  
 Phantom section: Flat Section

DASY4 Configuration:

- Probe: ES3DV3 - SN3341; ConvF(4.31, 4.31, 4.31);
- Sensor-Surface: 3mm (Mechanical Surface Detection)
- Electronics: DAE4 Sn432; Calibrated: 25/08/2015
- Phantom: SAM 12a (Site 57); Type: SAM 4.0; Serial: TP:1020
- Measurement SW: DASY4, V4.7 Build 80; Postprocessing SW: SEMCAD, V1.8 Build 186

**Top of EUT/Area Scan (81x81x1):** Measurement grid: dx=12mm, dy=12mm

Maximum value of SAR (interpolated) = 0.529 mW/g

**Top of EUT/Zoom Scan (7x7x7) (7x7x7)/Cube 0:** Measurement grid: dx=5mm, dy=5mm, dz=5mm

Reference Value = 5.10 V/m; Power Drift = 0.679 dB

Peak SAR (extrapolated) = 1.77 W/kg

**SAR(1 g) = 0.450 mW/g; SAR(10 g) = 0.113 mW/g**

Maximum value of SAR (measured) = 0.716 mW/g

DUT: Wedge; Type: Antenna 1; Serial: 05

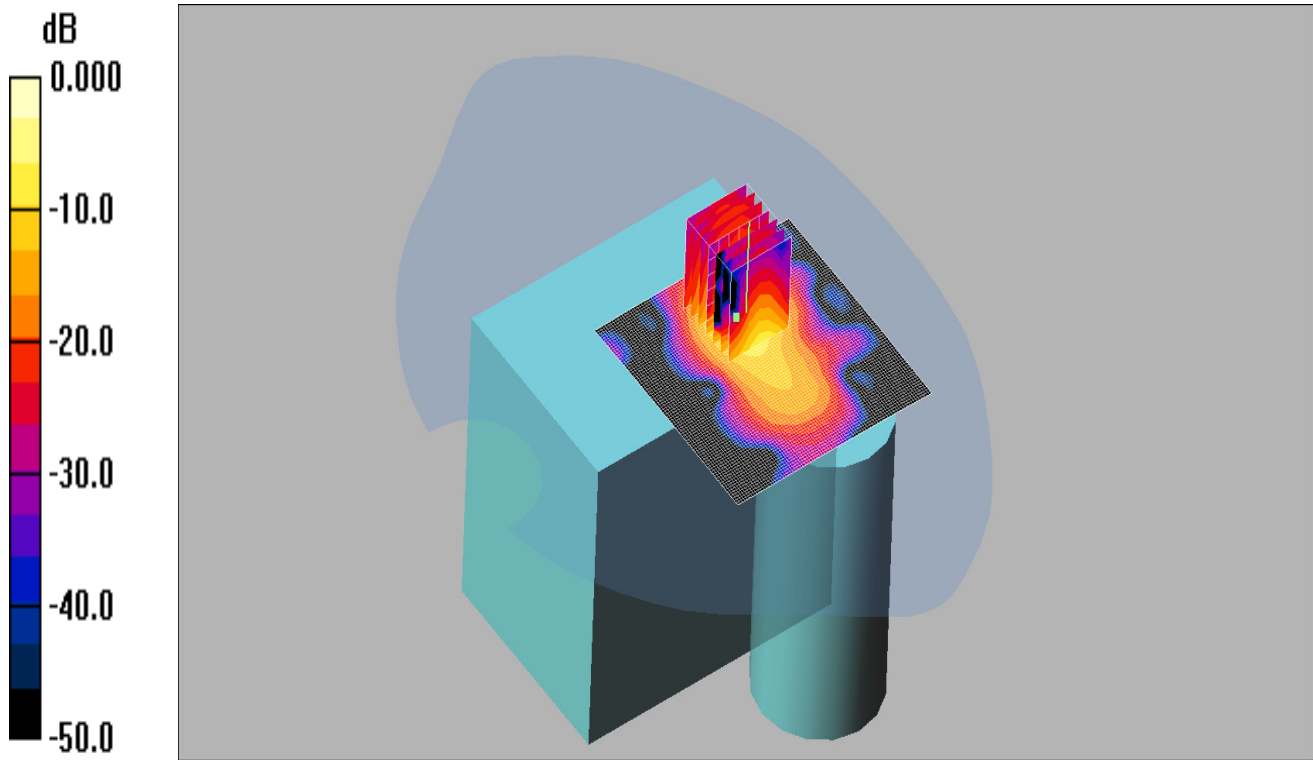

0 dB = 1.06mW/g

Communication System: WLAN; Frequency: 2462 MHz; Duty Cycle: 1:1  
 Medium: 2450 MHz MSL Medium parameters used (interpolated):  $f = 2462$  MHz;  $\sigma = 2.01$  mho/m;  $\epsilon_r = 50.5$ ;  $\rho = 1000$  kg/m<sup>3</sup>  
 Phantom section: Flat Section

DASY4 Configuration:

- Probe: ES3DV3 - SN3341; ConvF(4.31, 4.31, 4.31);
- Sensor-Surface: 3mm (Mechanical Surface Detection)
- Electronics: DAE4 Sn432; Calibrated: 25/08/2015
- Phantom: SAM 12a (Site 57); Type: SAM 4.0; Serial: TP:1020
- Measurement SW: DASY4, V4.7 Build 80; Postprocessing SW: SEMCAD, V1.8 Build 186

**Top of EUT/Area Scan (81x81x1):** Measurement grid: dx=12mm, dy=12mm

Maximum value of SAR (interpolated) = 0.707 mW/g

**Top of EUT/Zoom Scan (7x7x7) (7x7x7)/Cube 0:** Measurement grid: dx=5mm, dy=5mm, dz=5mm

Reference Value = 6.33 V/m; Power Drift = 0.205 dB

Peak SAR (extrapolated) = 2.87 W/kg

**SAR(1 g) = 0.719 mW/g; SAR(10 g) = 0.181 mW/g**

Maximum value of SAR (measured) = 1.06 mW/g

SAR/005: Left of EUT Wi-Fi 5.0GHz 802.11a Antenna 0 CH52

Date: 25/05/2016

DUT: Wedge; Type: Antenna 0; Serial: 05

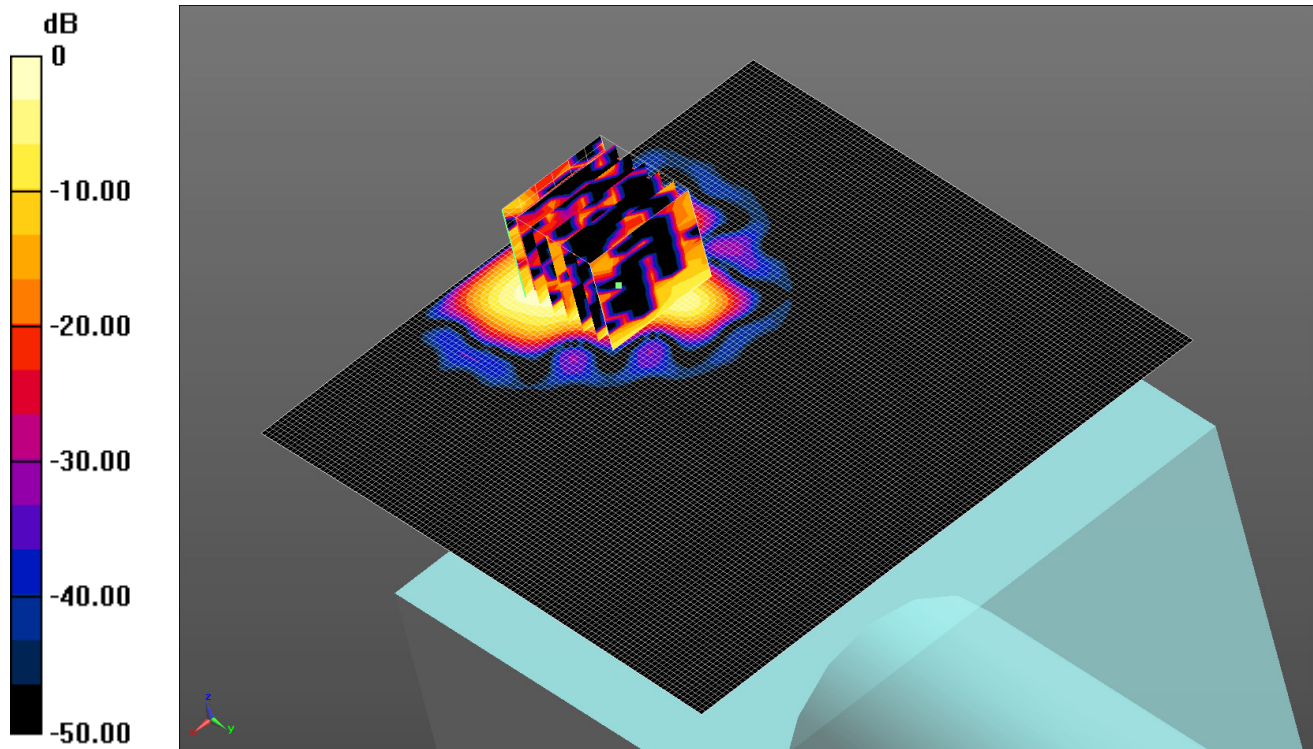

0 dB = 0.128 W/kg = -8.93 dBW/kg

Communication System: UID 0, WLAN 802.11 (0); Frequency: 5260 MHz; Duty Cycle: 1:1  
 Medium: 5250/5600/5750 MHz MSL Medium parameters used (interpolated): f = 5260 MHz;  $\sigma = 5.37$  S/m;  $\epsilon_r = 47.342$ ;  $\rho = 1000$  kg/m<sup>3</sup>

Phantom section: Flat Section

DASY4 Configuration:

- Probe: EX3DV4 - SN3994; ConvF(4.38, 4.38, 4.38); Calibrated: 21/03/2016;
- Sensor-Surface: 3mm (Mechanical Surface Detection)
- Electronics: DAE4 Sn1438; Calibrated: 25/04/2016
- Phantom: ELI v5.0 (30deg probe tilt); Type: QDOVA002AA; Serial: 1253
- ; SEMCAD X Version 14.6.10 (7372)

**Configuration/Left 802.11a - Bodyworn - PBx 2/Area Scan (121x121x1):** Interpolated grid: dx=1.000 mm, dy=1.000 mm

Maximum value of SAR (interpolated) = 0.228 W/kg

**Configuration/Left 802.11a - Bodyworn - PBx 2/Zoom Scan (7x7x7) (7x7x12)/Cube 0:** Measurement grid: dx=4mm, dy=4mm, dz=2mm

Reference Value = 2.810 V/m; Power Drift = -0.68 dB

Peak SAR (extrapolated) = 0.830 W/kg

**SAR(1 g) = 0.083 W/kg; SAR(10 g) = 0.030 W/kg.**

Maximum value of SAR (measured) = 0.128 W/kg

SAR/006: Left of EUT Wi-Fi 5.0GHz 802.11a Antenna 0 CH104

Date: 25/05/2016

DUT: Wedge; Type: Antenna 0; Serial: 05

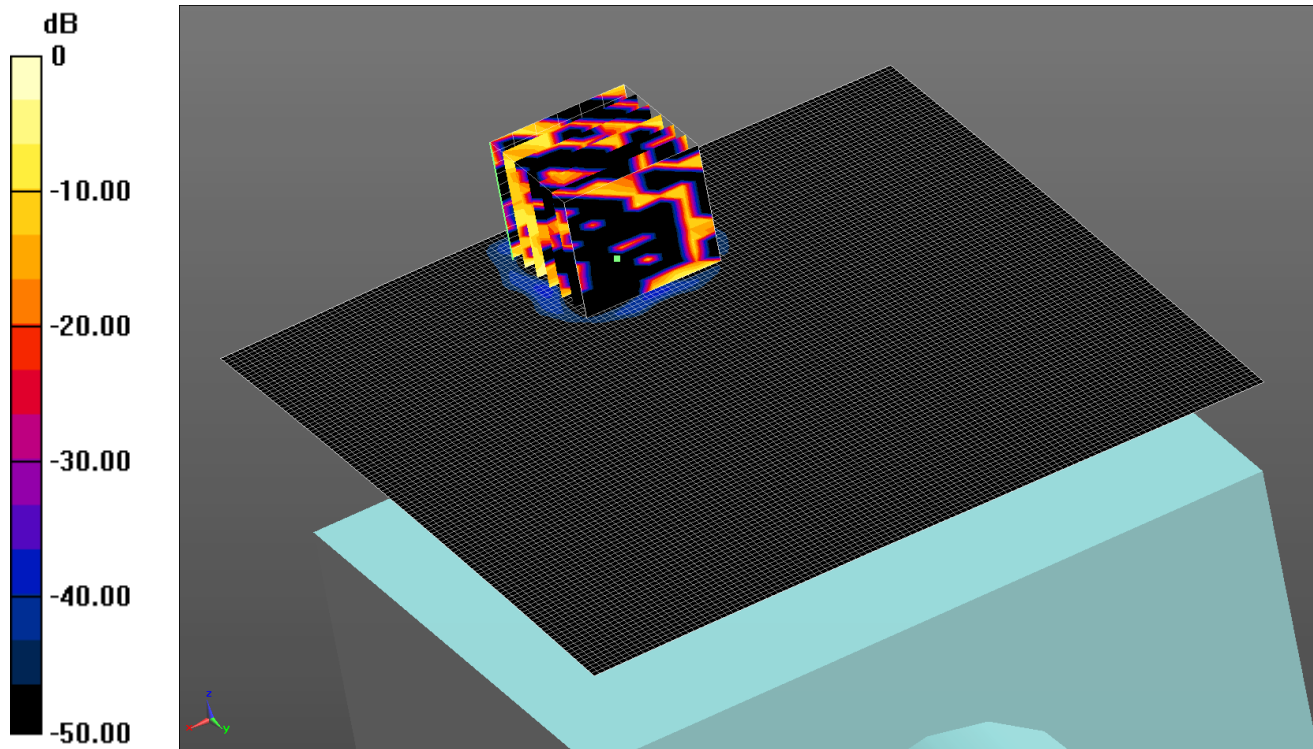

0 dB = 0.0378 W/kg = -14.23 dBW/kg

Communication System: UID 0, WLAN 802.11 (0); Frequency: 5520 MHz; Duty Cycle: 1:1  
 Medium: 5250/5600/5750 MHz MSL Medium parameters used (interpolated):  $f = 5520$  MHz;  $\sigma = 5.76$  S/m;  $\epsilon_r = 46.787$ ;  $\rho = 1000$  kg/m<sup>3</sup>  
 Phantom section: Flat Section  
 DASY4 Configuration:  
 - Probe: EX3DV4 - SN3994; ConvF(3.76, 3.76, 3.76); Calibrated: 21/03/2016;  
 - Sensor-Surface: 3mm (Mechanical Surface Detection)  
 - Electronics: DAE4 Sn1438; Calibrated: 25/04/2016  
 - Phantom: ELI v5.0 (30deg probe tilt); Type: QDOVA002AA; Serial: 1253  
 - ; SEMCAD X Version 14.6.10 (7372)

**Configuration/Left 802.11a - Bodyworn - PBx 2/Area Scan (121x121x1):** Interpolated grid: dx=1.000 mm, dy=1.000 mm

Maximum value of SAR (interpolated) = 0.0311 W/kg

**Configuration/Left 802.11a - Bodyworn - PBx 2/Zoom Scan (7x7x7) (7x7x12)/Cube 0:** Measurement grid: dx=4mm, dy=4mm, dz=2mm

Reference Value = 2.462 V/m; Power Drift = -1.14 dB

Peak SAR (extrapolated) = 0.469 W/kg

**SAR(1 g) = 0.021 W/kg; SAR(10 g) = 0.00221 W/kg**

Maximum value of SAR (measured) = 0.0378 W/kg

SAR/007: Left of EUT Wi-Fi 5.0GHz 802.11a Antenna 0 CH56

Date: 26/05/2016

DUT: Wedge; Type: Antenna 0; Serial: 05

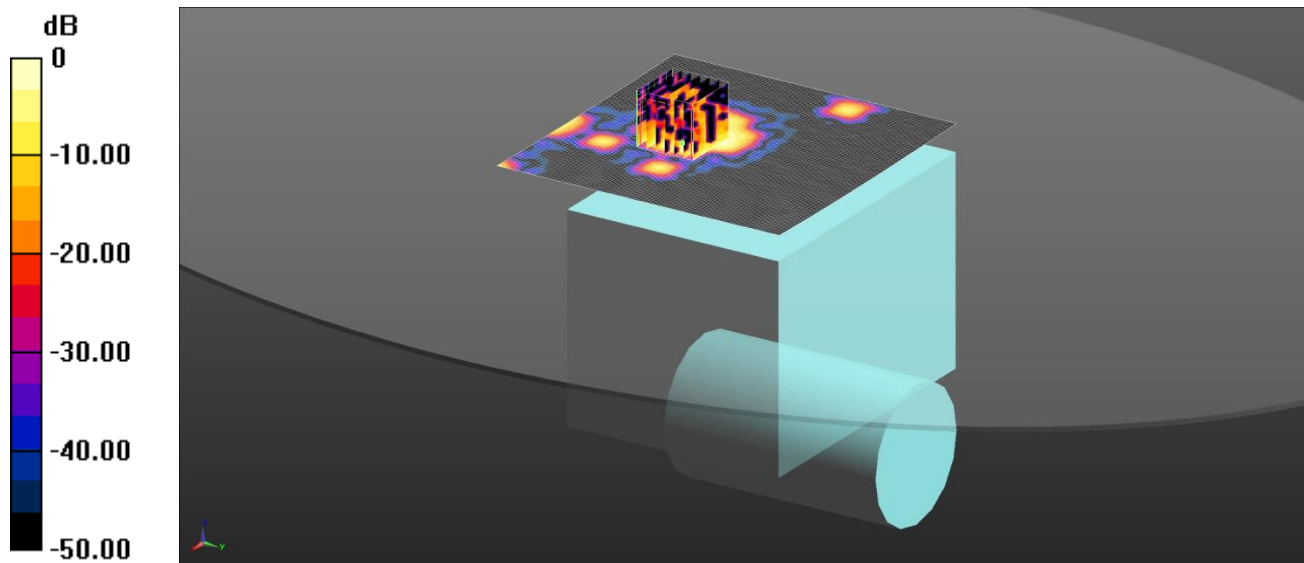

0 dB = 0.120 W/kg = -9.21 dBW/kg

Communication System: UID 0, WLAN 802.11 (0); Frequency: 5280 MHz; Duty Cycle: 1:1  
 Medium: 5250/5600/5750 MHz MSL Medium parameters used (interpolated):  $f = 5280$  MHz;  $\sigma = 5.405$  S/m;  $\epsilon_r = 47.299$ ;  $\rho = 1000$  kg/m<sup>3</sup>  
 Phantom section: Flat Section  
 DASY4 Configuration:  
 - Probe: EX3DV4 - SN3994; ConvF(4.38, 4.38, 4.38); Calibrated: 21/03/2016;  
 - Sensor-Surface: 3mm (Mechanical Surface Detection)  
 - Electronics: DAE4 Sn1438; Calibrated: 25/04/2016  
 - Phantom: ELI v5.0 (30deg probe tilt); Type: QDOVA002AA; Serial: 1253  
 - ; SEMCAD X Version 14.6.10 (7372)

**Configuration/Left 802.11a - Bodyworn - PBx 2/Area Scan (121x121x1):** Interpolated grid:  $dx=1.000$  mm,  $dy=1.000$  mm  
 Maximum value of SAR (interpolated) = 0.251 W/kg

**Configuration/Left 802.11a - Bodyworn - PBx 2/Zoom Scan (7x7x12) (7x7x12)/Cube 0:** Measurement grid:  $dx=4$ mm,  $dy=4$ mm,  $dz=2$ mm

Reference Value = 1.367 V/m; Power Drift = 1.84 dB

Peak SAR (extrapolated) = 0.563 W/kg

**SAR(1 g) = 0.065 W/kg; SAR(10 g) = 0.026 W/kg**

Maximum value of SAR (measured) = 0.120 W/kg

SAR/008: Left of EUT Wi-Fi 5.0GHz 802.11a Antenna 0 CH64

Date: 26/05/2016

DUT: Wedge; Type: Antenna 0; Serial: 05

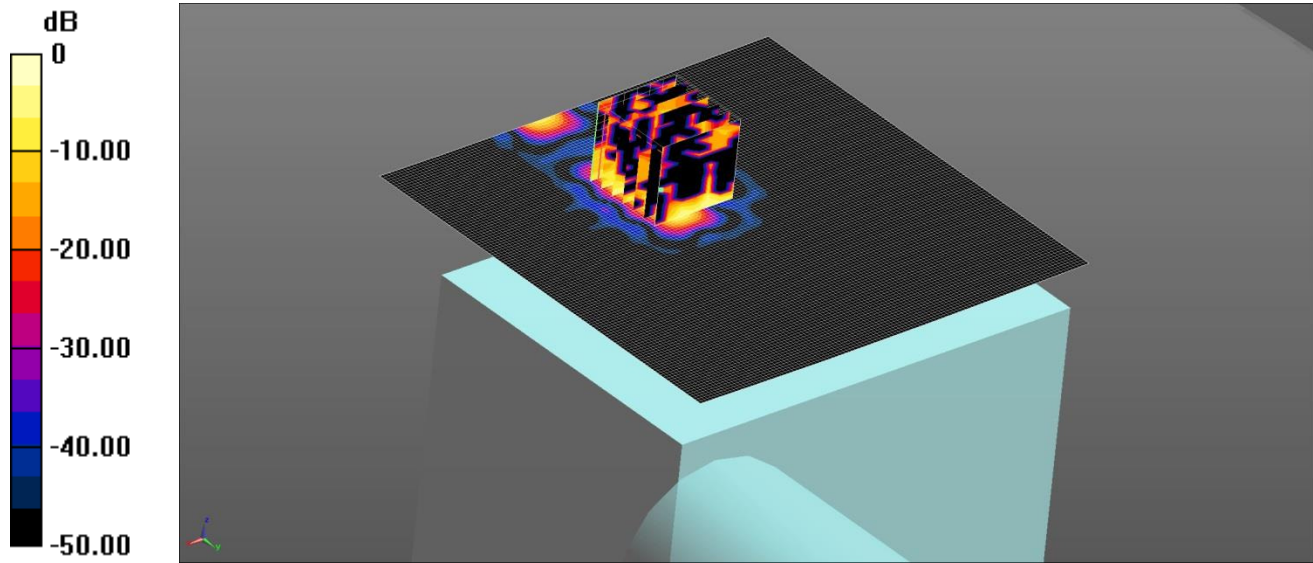

0 dB = 0.0917 W/kg = -10.38 dBW/kg

Communication System: UID 0, WLAN 802.11 (0); Frequency: 5320 MHz; Duty Cycle: 1:1  
 Medium: 5250/5600/5750 MHz MSL Medium parameters used (interpolated):  $f = 5320$  MHz;  $\sigma = 5.485$  S/m;  $\epsilon_r = 47.215$ ;  $\rho = 1000$  kg/m<sup>3</sup>  
 Phantom section: Flat Section  
 DASY4 Configuration:  
 - Probe: EX3DV4 - SN3994; ConvF(4.38, 4.38, 4.38); Calibrated: 21/03/2016;  
 - Sensor-Surface: 3mm (Mechanical Surface Detection)  
 - Electronics: DAE4 Sn1438; Calibrated: 25/04/2016  
 - Phantom: ELI v5.0 (30deg probe tilt); Type: QDOVA002AA; Serial: 1253  
 - ; SEMCAD X Version 14.6.10 (7372)

**Configuration/Left 802.11a - Bodyworn - PBx 2 2/Area Scan (121x121x1):** Interpolated grid: dx=1.000 mm, dy=1.000 mm

Maximum value of SAR (interpolated) = 0.101 W/kg

**Configuration/Left 802.11a - Bodyworn - PBx 2 2/Zoom Scan (7x7x12) (7x7x12)/Cube 0:** Measurement grid: dx=4mm, dy=4mm, dz=2mm

Reference Value = 1.963 V/m; Power Drift = 2.23 dB

Peak SAR (extrapolated) = 0.904 W/kg

**SAR(1 g) = 0.087 W/kg; SAR(10 g) = 0.024 W/kg**

Maximum value of SAR (measured) = 0.0917 W/kg

SAR/009: Top of EUT Wi-Fi 5.0GHz 802.11a Antenna 0 CH36

Date: 25/05/2016

DUT: Wedge; Type: Antenna 0; Serial: 05

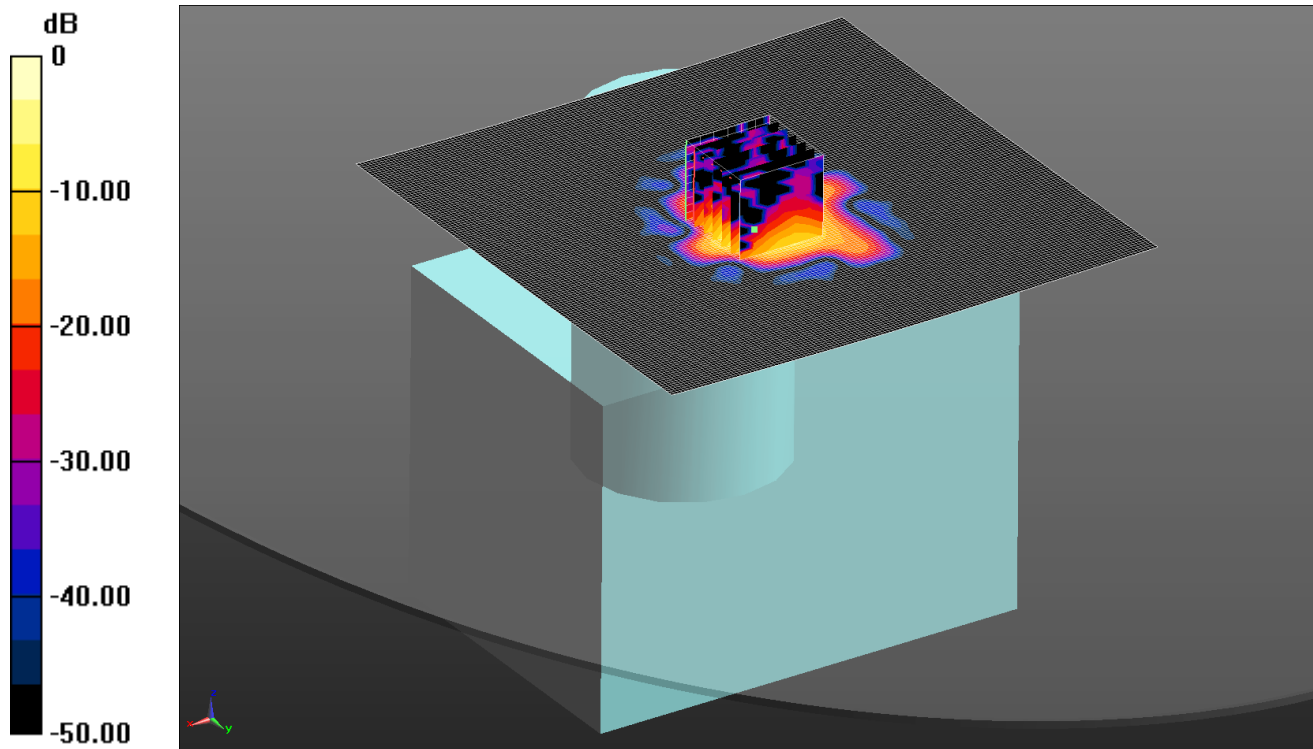

0 dB = 1.78 W/kg = 2.50 dBW/kg

Communication System: UID 0, WLAN 802.11 (0); Frequency: 5180 MHz; Duty Cycle: 1:1

Medium: 5250/5600/5750 MHz MSL Medium parameters used (interpolated):  $f = 5180$  MHz;  $\sigma = 5.244$  S/m;  $\epsilon_r = 47.533$ ;  $\rho = 1000$  kg/m<sup>3</sup>

Phantom section: Flat Section

DASY4 Configuration:

- Probe: EX3DV4 - SN3994; ConvF(4.38, 4.38, 4.38); Calibrated: 21/03/2016;
- Sensor-Surface: 3mm (Mechanical Surface Detection)
- Electronics: DAE4 Sn1438; Calibrated: 25/04/2016
- Phantom: ELI v5.0 (30deg probe tilt); Type: QDOVA002AA; Serial: 1253
- ; SEMCAD X Version 14.6.10 (7372)

**Configuration/Top 802.11a - Bodyworn - PBx 2/Area Scan (141x141x1):** Interpolated grid: dx=1.000 mm, dy=1.000 mm

Maximum value of SAR (interpolated) = 1.79 W/kg

**Configuration/Top 802.11a - Bodyworn - PBx 2/Zoom Scan (7x7x7) (7x7x12)/Cube 0:** Measurement grid: dx=4mm, dy=4mm, dz=2mm

Reference Value = 6.311 V/m; Power Drift = 0.20 dB

Peak SAR (extrapolated) = 4.41 W/kg

**SAR(1 g) = 0.937 W/kg; SAR(10 g) = 0.215 W/kg**

Maximum value of SAR (measured) = 1.78 W/kg

SAR/010: Top of EUT Wi-Fi 5.0GHz 802.11a Antenna 0 CH52

Date: 25/05/2016

DUT: Wedge; Type: Antenna 0; Serial: 05

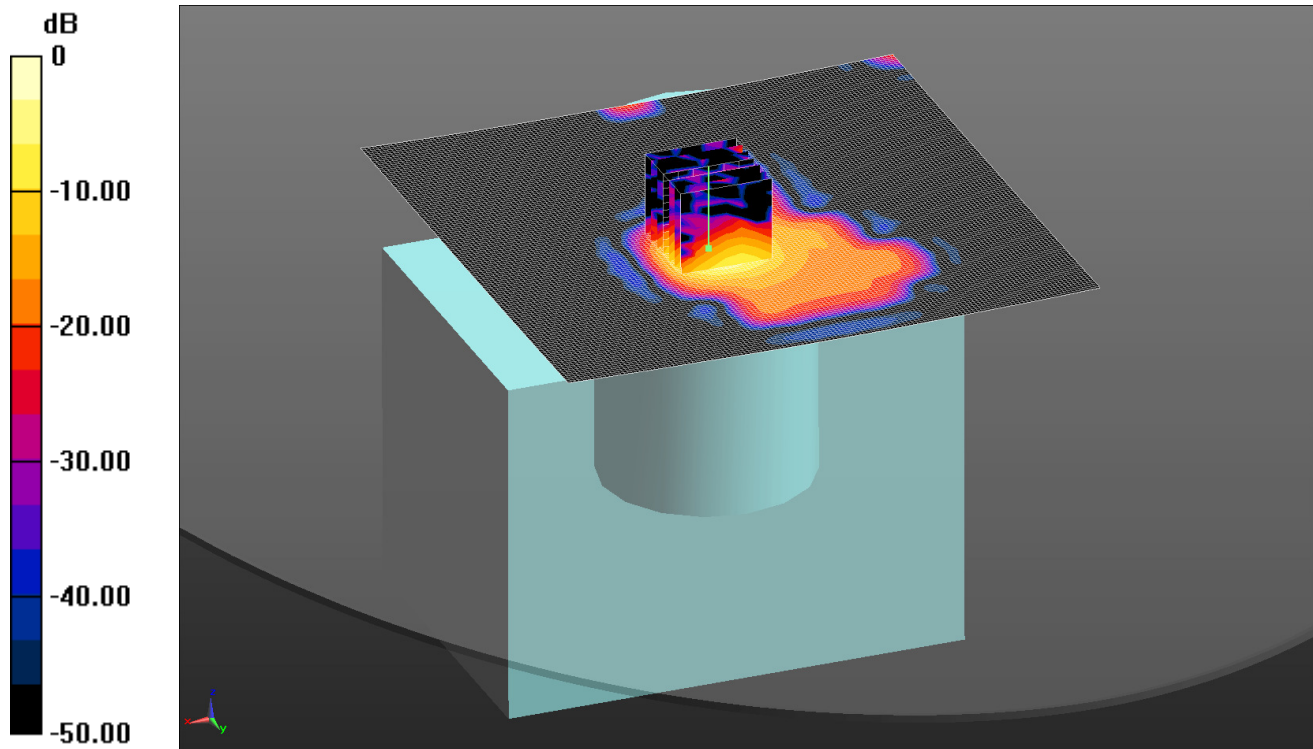

0 dB = 2.36 W/kg = 3.73 dBW/kg

Communication System: UID 0, WLAN 802.11 (0); Frequency: 5260 MHz; Duty Cycle: 1:1  
 Medium: 5250/5600/5750 MHz MSL Medium parameters used (interpolated): f = 5260 MHz;  $\sigma = 5.37$  S/m;  $\epsilon_r = 47.342$ ;  $\rho = 1000$  kg/m<sup>3</sup>

Phantom section: Flat Section

DASY4 Configuration:

- Probe: EX3DV4 - SN3994; ConvF(4.38, 4.38, 4.38); Calibrated: 21/03/2016;
- Sensor-Surface: 3mm (Mechanical Surface Detection)
- Electronics: DAE4 Sn1438; Calibrated: 25/04/2016
- Phantom: ELI v5.0 (30deg probe tilt); Type: QDOVA002AA; Serial: 1253
- ; SEMCAD X Version 14.6.10 (7372)

**Configuration/Top 802.11a - Bodyworn - PBx 2/Area Scan (141x141x1):** Interpolated grid: dx=1.000 mm, dy=1.000 mm

Maximum value of SAR (interpolated) = 2.29 W/kg

**Configuration/Top 802.11a - Bodyworn - PBx 2/Zoom Scan (7x7x7) (7x7x12)/Cube 0:** Measurement grid: dx=4mm, dy=4mm, dz=2mm

Reference Value = 4.532 V/m; Power Drift = 0.18 dB

Peak SAR (extrapolated) = 4.84 W/kg

**SAR(1 g) = 1.16 W/kg; SAR(10 g) = 0.264 W/kg**

Maximum value of SAR (measured) = 2.36 W/kg



SAR/011: Top of EUT Wi-Fi 5.0GHz 802.11a Antenna 0 CH104

Date: 25/05/2016

DUT: Wedge; Type: Antenna 0; Serial: 05

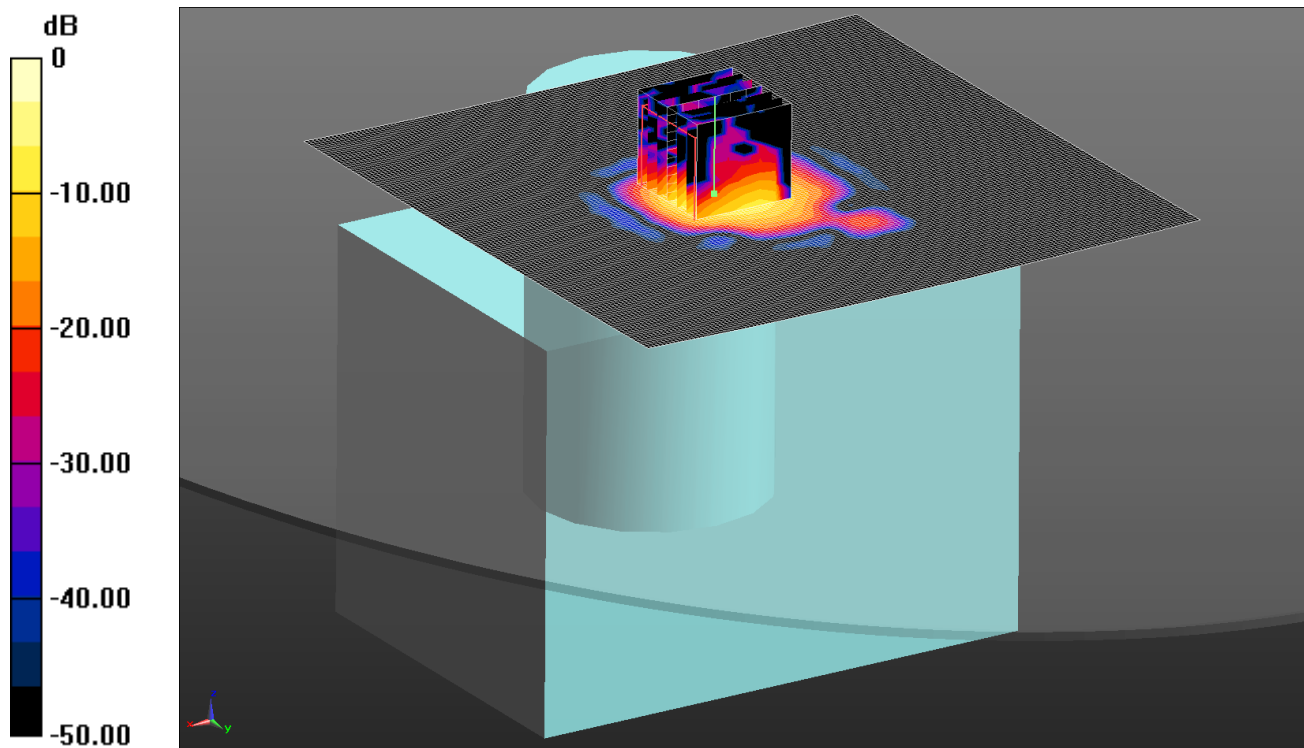

0 dB = 2.38 W/kg = 3.77 dBW/kg

Communication System: UID 0, WLAN 802.11 (0); Frequency: 5520 MHz; Duty Cycle: 1:1  
Medium: 5250/5600/5750 MHz MSL Medium parameters used (interpolated): f = 5520 MHz;  $\sigma = 5.76$  S/m;  $\epsilon_r = 46.787$ ;  $\rho = 1000$  kg/m<sup>3</sup>

Phantom section: Flat Section

DASY4 Configuration:

- Probe: EX3DV4 - SN3994; ConvF(3.76, 3.76, 3.76); Calibrated: 21/03/2016;
- Sensor-Surface: 3mm (Mechanical Surface Detection)
- Electronics: DAE4 Sn1438; Calibrated: 25/04/2016
- Phantom: ELI v5.0 (30deg probe tilt); Type: QDOVA002AA; Serial: 1253
- ; SEMCAD X Version 14.6.10 (7372)

**Configuration/Top 802.11a - Bodyworn - PBx 2/Area Scan (141x141x1):** Interpolated grid: dx=1.000 mm, dy=1.000 mm

Maximum value of SAR (interpolated) = 2.39 W/kg

**Configuration/Top 802.11a - Bodyworn - PBx 2/Zoom Scan (7x7x7) (7x7x12)/Cube 0:** Measurement grid: dx=4mm, dy=4mm, dz=2mm

Reference Value = 4.147 V/m; Power Drift = -0.23 dB

Peak SAR (extrapolated) = 5.44 W/kg

**SAR(1 g) = 1.15 W/kg; SAR(10 g) = 0.236 W/kg**

Maximum value of SAR (measured) = 2.38 W/kg

SAR/012: Top of EUT Wi-Fi 5.0GHz 802.11a Antenna 0 CH149

Date: 25/05/2016

DUT: Wedge; Type: Antenna 0; Serial: 05

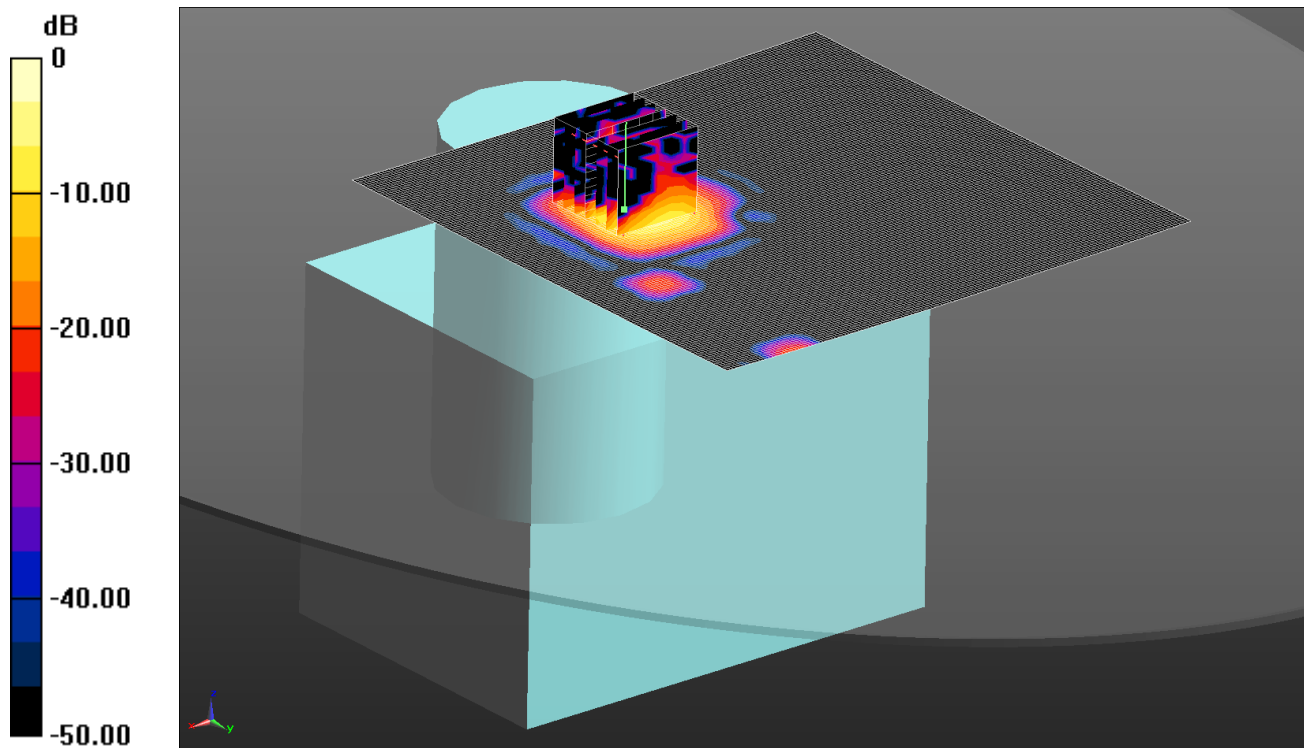

0 dB = 1.27 W/kg = 1.04 dBW/kg

Communication System: UID 0, WLAN 802.11 (0); Frequency: 5745 MHz; Duty Cycle: 1:1  
 Medium: 5250/5600/5750 MHz MSL Medium parameters used (interpolated): f = 5745 MHz;  $\sigma = 6.108$  S/m;  $\epsilon_r = 46.284$ ;  $\rho = 1000$  kg/m<sup>3</sup>

Phantom section: Flat Section

DASY4 Configuration:

- Probe: EX3DV4 - SN3994; ConvF(3.99, 3.99, 3.99); Calibrated: 21/03/2016;
- Sensor-Surface: 3mm (Mechanical Surface Detection)
- Electronics: DAE4 Sn1438; Calibrated: 25/04/2016
- Phantom: ELI v5.0 (30deg probe tilt); Type: QDOVA002AA; Serial: 1253
- ; SEMCAD X Version 14.6.10 (7372)

**Configuration/Top 802.11a - Bodyworn - PBx 2/Area Scan (141x141x1):** Interpolated grid: dx=1.000 mm, dy=1.000 mm  
 Maximum value of SAR (interpolated) = 1.16 W/kg

**Configuration/Top 802.11a - Bodyworn - PBx 2/Zoom Scan (7x7x7) (7x7x12)/Cube 0:** Measurement grid: dx=4mm, dy=4mm, dz=2mm

Reference Value = 0 V/m; Power Drift = 0.00 dB

Peak SAR (extrapolated) = 2.86 W/kg

**SAR(1 g) = 0.617 W/kg; SAR(10 g) = 0.131 W/kg**

Maximum value of SAR (measured) = 1.27 W/kg

SAR/013: Top of EUT Wi-Fi 5.0GHz 802.11a Antenna 1 CH48

Date: 25/05/2016

DUT: Wedge; Type: Antenna 0; Serial: 05

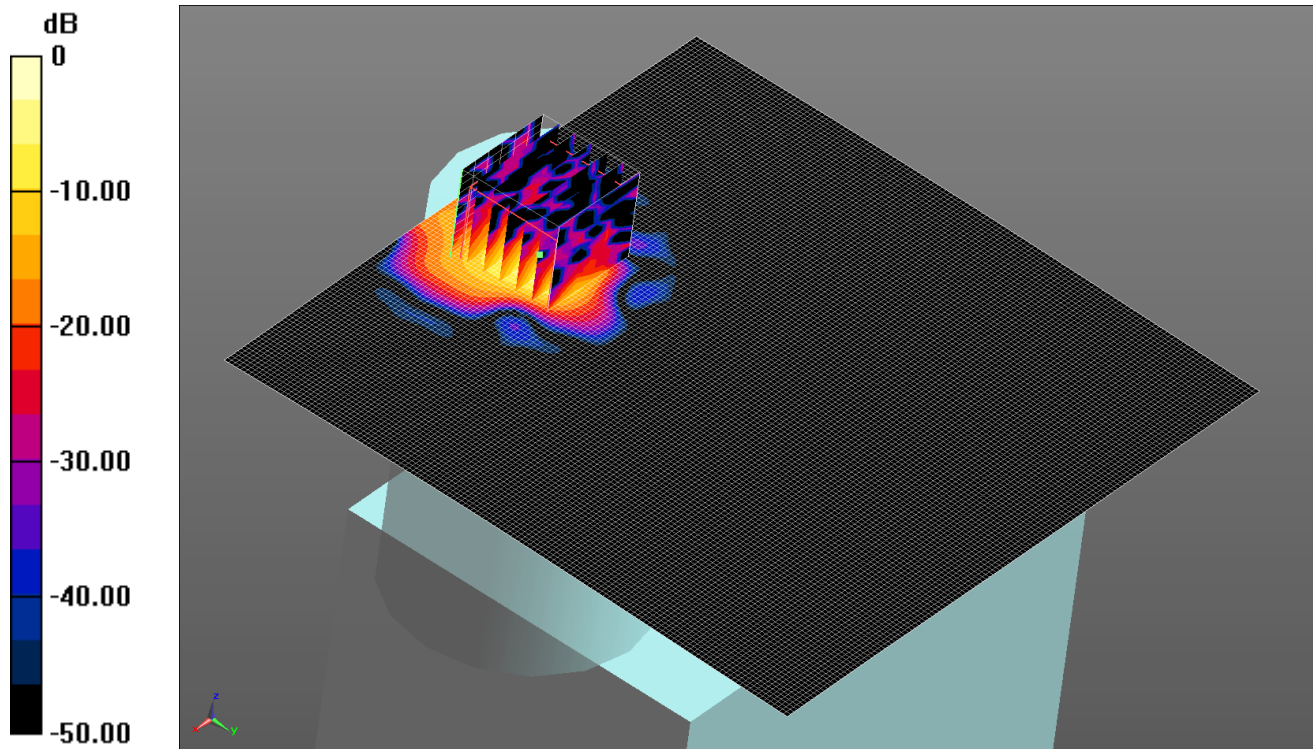

0 dB = 1.71 W/kg = 2.33 dBW/kg

Communication System: UID 0, WLAN 802.11 (0); Frequency: 5240 MHz; Duty Cycle: 1:1  
 Medium: 5250/5600/5750 MHz MSL Medium parameters used (interpolated):  $f = 5240$  MHz;  $\sigma = 5.336$  S/m;  $\epsilon_r = 47.389$ ;  $\rho = 1000$  kg/m<sup>3</sup>  
 Phantom section: Flat Section  
 DASY4 Configuration:  
 - Probe: EX3DV4 - SN3994; ConvF(4.38, 4.38, 4.38); Calibrated: 21/03/2016;  
 - Sensor-Surface: 3mm (Mechanical Surface Detection)  
 - Electronics: DAE4 Sn1438; Calibrated: 25/04/2016  
 - Phantom: ELI v5.0 (30deg probe tilt); Type: QDOVA002AA; Serial: 1253  
 - ; SEMCAD X Version 14.6.10 (7372)

**Configuration/Top 802.11a - Bodyworn - PBx 2/Area Scan (141x141x1):** Interpolated grid: dx=1.000 mm, dy=1.000 mm

Maximum value of SAR (interpolated) = 1.51 W/kg

**Configuration/Top 802.11a - Bodyworn - PBx 2/Zoom Scan (7x7x7) (7x7x12)/Cube 0:** Measurement grid: dx=4mm, dy=4mm, dz=2mm

Reference Value = 0.8920 V/m; Power Drift = -1.38 dB

Peak SAR (extrapolated) = 4.70 W/kg

**SAR(1 g) = 0.893 W/kg; SAR(10 g) = 0.172 W/kg**

Maximum value of SAR (measured) = 1.71 W/kg

SAR/014: Top of EUT Wi-Fi 5.0GHz 802.11a Antenna 1 CH52

Date: 25/05/2016

DUT: Wedge; Type: Antenna 0; Serial: 05

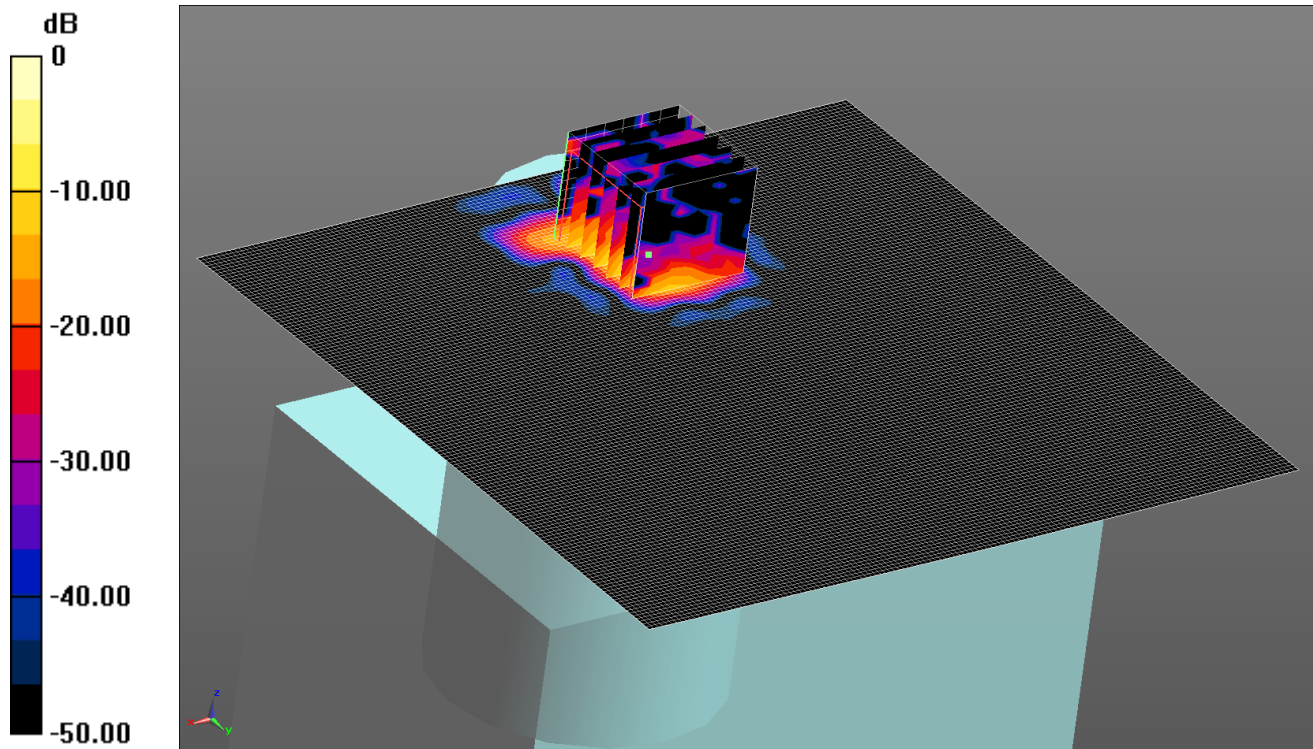

0 dB = 1.55 W/kg = 1.90 dBW/kg

Communication System: UID 0, WLAN 802.11 (0); Frequency: 5260 MHz;Duty Cycle: 1:1  
 Medium: 5250/5600/5750 MHz MSL Medium parameters used (interpolated): f = 5260 MHz;  $\sigma = 5.37$  S/m;  $\epsilon_r = 47.342$ ;  $\rho = 1000$  kg/m<sup>3</sup>  
 Phantom section: Flat Section  
 DASy4 Configuration:  
 - Probe: EX3DV4 - SN3994; ConvF(4.38, 4.38, 4.38); Calibrated: 21/03/2016;  
 - Sensor-Surface: 3mm (Mechanical Surface Detection)  
 - Electronics: DAE4 Sn1438; Calibrated: 25/04/2016  
 - Phantom: ELI v5.0 (30deg probe tilt); Type: QDOVA002AA; Serial: 1253  
 - ; SEMCAD X Version 14.6.10 (7372)

**Configuration/Top 802.11a - Bodyworn - PBx 2/Area Scan (141x141x1):** Interpolated grid: dx=1.000 mm, dy=1.000 mm  
 Maximum value of SAR (interpolated) = 1.44 W/kg

**Configuration/Top 802.11a - Bodyworn - PBx 2/Zoom Scan (7x7x7) (7x7x12)/Cube 0:** Measurement grid: dx=4mm, dy=4mm, dz=2mm  
 Reference Value = 13.64 V/m; Power Drift = -0.23 dB  
 Peak SAR (extrapolated) = 3.42 W/kg  
**SAR(1 g) = 0.775 W/kg; SAR(10 g) = 0.150 W/kg**  
 Maximum value of SAR (measured) = 1.55 W/kg

SAR/015: Top of EUT Wi-Fi 5.0GHz 802.11a Antenna 1 CH108

Date: 25/05/2016

DUT: Wedge; Type: Antenna 0; Serial: 05

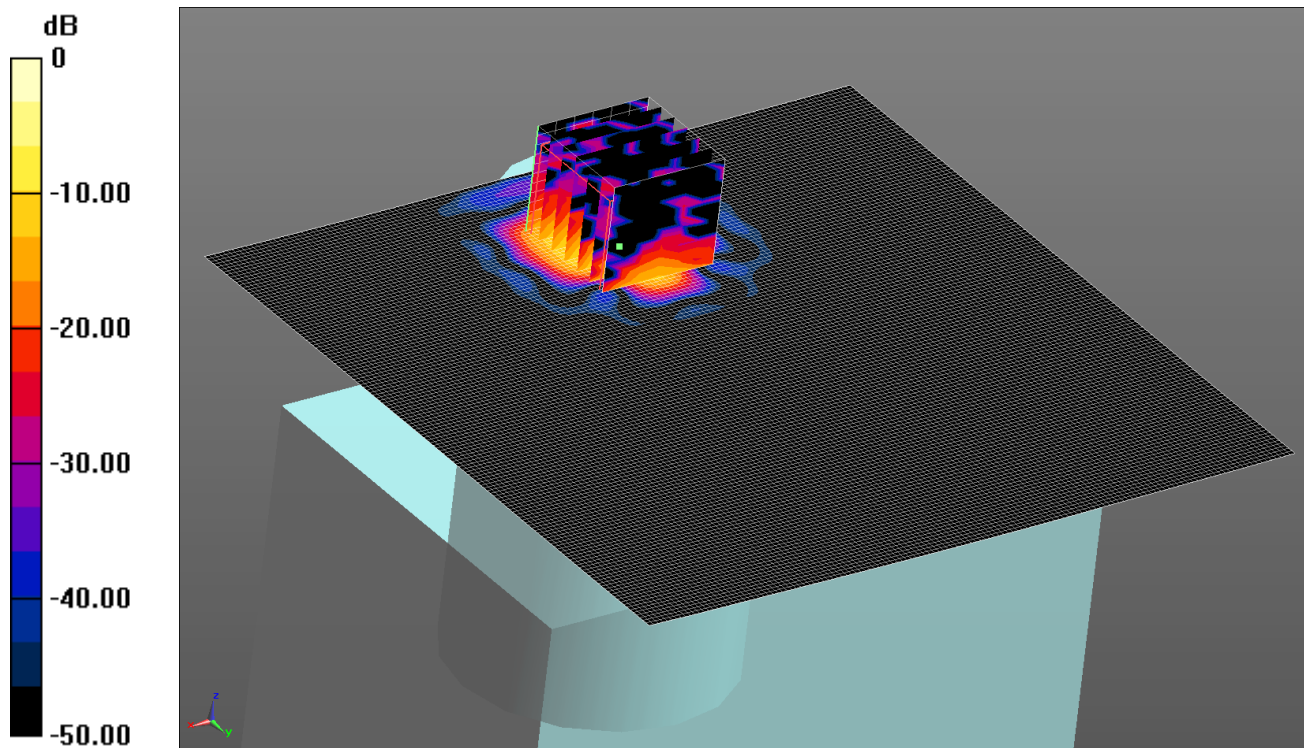

0 dB = 1.54 W/kg = 1.88 dBW/kg

Communication System: UID 0, WLAN 802.11 (0); Frequency: 5540 MHz; Duty Cycle: 1:1  
 Medium: 5250/5600/5750 MHz MSL Medium parameters used (interpolated): f = 5540 MHz;  $\sigma = 5.79$  S/m;  $\epsilon_r = 46.824$ ;  $\rho = 1000$  kg/m<sup>3</sup>  
 Phantom section: Flat Section  
 DASY4 Configuration:  
 - Probe: EX3DV4 - SN3994; ConvF(3.76, 3.76, 3.76); Calibrated: 21/03/2016;  
 - Sensor-Surface: 3mm (Mechanical Surface Detection)  
 - Electronics: DAE4 Sn1438; Calibrated: 25/04/2016  
 - Phantom: ELI v5.0 (30deg probe tilt); Type: QDOVA002AA; Serial: 1253  
 - ; SEMCAD X Version 14.6.10 (7372)

**Configuration/Top 802.11a - Bodyworn - PBx 2/Area Scan (141x141x1):** Interpolated grid: dx=1.000 mm, dy=1.000 mm

Maximum value of SAR (interpolated) = 1.51 W/kg

**Configuration/Top 802.11a - Bodyworn - PBx 2/Zoom Scan (7x7x7) (7x7x12)/Cube 0:** Measurement grid: dx=4mm, dy=4mm, dz=2mm

Reference Value = 1.185 V/m; Power Drift = -0.19 dB

Peak SAR (extrapolated) = 3.37 W/kg

**SAR(1 g) = 0.713 W/kg; SAR(10 g) = 0.141 W/kg**

Maximum value of SAR (measured) = 1.54 W/kg

SAR/016: Top of EUT Wi-Fi 5.0GHz 802.11a Antenna 1 CH165

Date: 25/05/2016

DUT: Wedge; Type: Antenna 0; Serial: 05

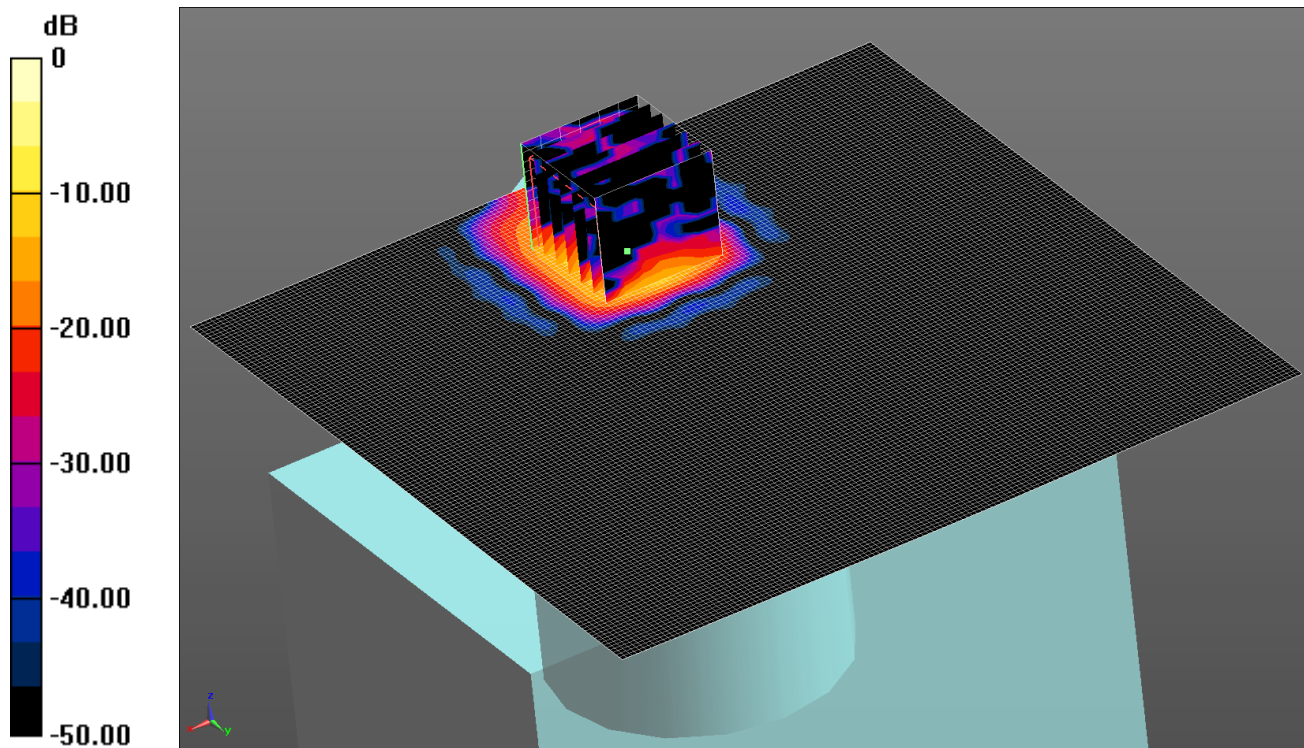

0 dB = 2.64 W/kg = 4.22 dBW/kg

Communication System: UID 0, WLAN 802.11 (0); Frequency: 5825 MHz;Duty Cycle: 1:1  
 Medium: 5250/5600/5750 MHz MSL Medium parameters used (interpolated): f = 5825 MHz;  $\sigma = 6.2$  S/m;  $\epsilon_r = 46.057$ ;  $\rho = 1000$  kg/m<sup>3</sup>  
 Phantom section: Flat Section  
 DASy4 Configuration:  
 - Probe: EX3DV4 - SN3994; ConvF(3.99, 3.99, 3.99); Calibrated: 21/03/2016;  
 - Sensor-Surface: 3mm (Mechanical Surface Detection)  
 - Electronics: DAE4 Sn1438; Calibrated: 25/04/2016  
 - Phantom: ELI v5.0 (30deg probe tilt); Type: QDOVA002AA; Serial: 1253  
 - ; SEMCAD X Version 14.6.10 (7372)

**Configuration/Top 802.11a - Bodyworn - PBx 2/Area Scan (141x141x1):** Interpolated grid: dx=1.000 mm, dy=1.000 mm

Maximum value of SAR (interpolated) = 2.57 W/kg

**Configuration/Top 802.11a - Bodyworn - PBx 2/Zoom Scan (7x7x7) (7x7x12)/Cube 0:** Measurement grid: dx=4mm, dy=4mm, dz=2mm

Reference Value = 3.174 V/m; Power Drift = -0.06 dB

Peak SAR (extrapolated) = 6.00 W/kg

**SAR(1 g) = 1.22 W/kg; SAR(10 g) = 0.238 W/kg**

Maximum value of SAR (measured) = 2.64 W/kg

SAR/017: Top of EUT Wi-Fi 5.0GHz 802.11a Antenna 0 CH56

Date: 26/05/2016

DUT: Wedge; Type: Antenna 0; Serial: 05

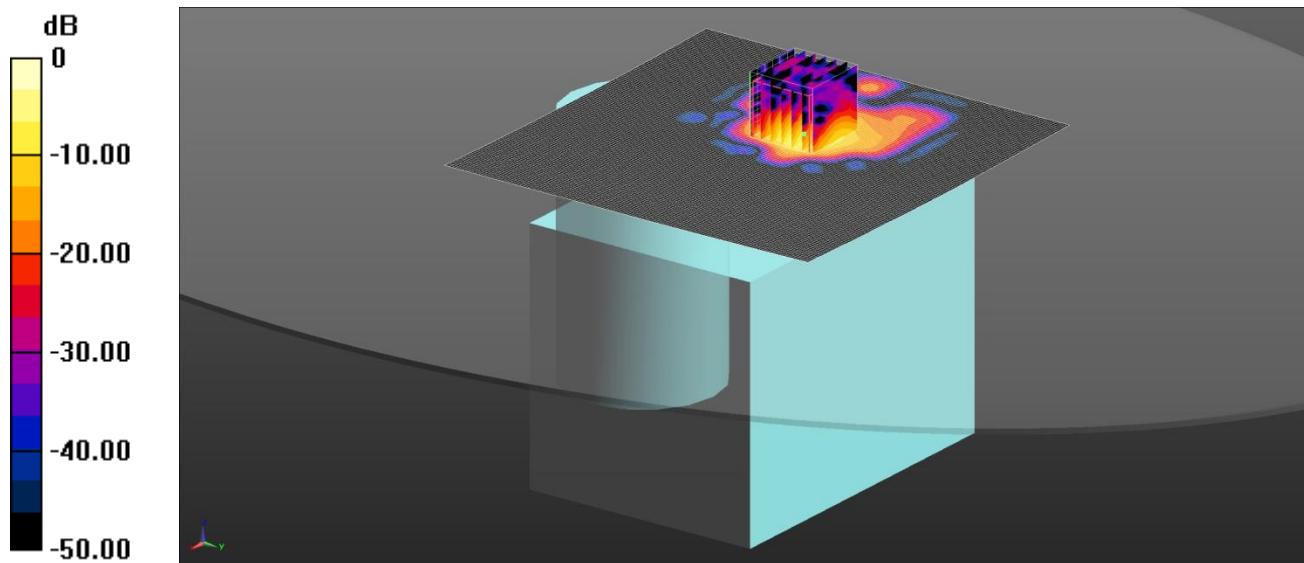

0 dB = 2.60 W/kg = 4.15 dBW/kg

Communication System: UID 0, WLAN 802.11 (0); Frequency: 5280 MHz; Duty Cycle: 1:1  
 Medium: 5250/5600/5750 MHz MSL Medium parameters used (interpolated):  $f = 5280$  MHz;  $\sigma = 5.405$  S/m;  $\epsilon_r = 47.299$ ;  $\rho = 1000$  kg/m<sup>3</sup>  
 Phantom section: Flat Section  
 DASY4 Configuration:  
 - Probe: EX3DV4 - SN3994; ConvF(4.38, 4.38, 4.38); Calibrated: 21/03/2016;  
 - Sensor-Surface: 3mm (Mechanical Surface Detection)  
 - Electronics: DAE4 Sn1438; Calibrated: 25/04/2016  
 - Phantom: ELI v5.0 (30deg probe tilt); Type: QDOVA002AA; Serial: 1253  
 - ; SEMCAD X Version 14.6.10 (7372)

**Configuration/Top 802.11a - Bodyworn - PBx 2/Area Scan 2 (141x141x1):** Interpolated grid: dx=1.000 mm, dy=1.000 mm  
 Maximum value of SAR (interpolated) = 2.30 W/kg  
**Configuration/Top 802.11a - Bodyworn - PBx 2/Zoom Scan (7x7x7) (7x7x12)/Cube 0:** Measurement grid: dx=4mm, dy=4mm, dz=2mm  
 Reference Value = 6.639 V/m; Power Drift = 0.15 dB  
 Peak SAR (extrapolated) = 7.03 W/kg  
**SAR(1 g) = 1.36 W/kg; SAR(10 g) = 0.305 W/kg**  
 Maximum value of SAR (measured) = 2.60 W/kg

SAR/018: Top of EUT Wi-Fi 5.0GHz 802.11a Antenna 0 CH64

Date: 26/05/2016

DUT: Wedge; Type: Antenna 0; Serial: 05

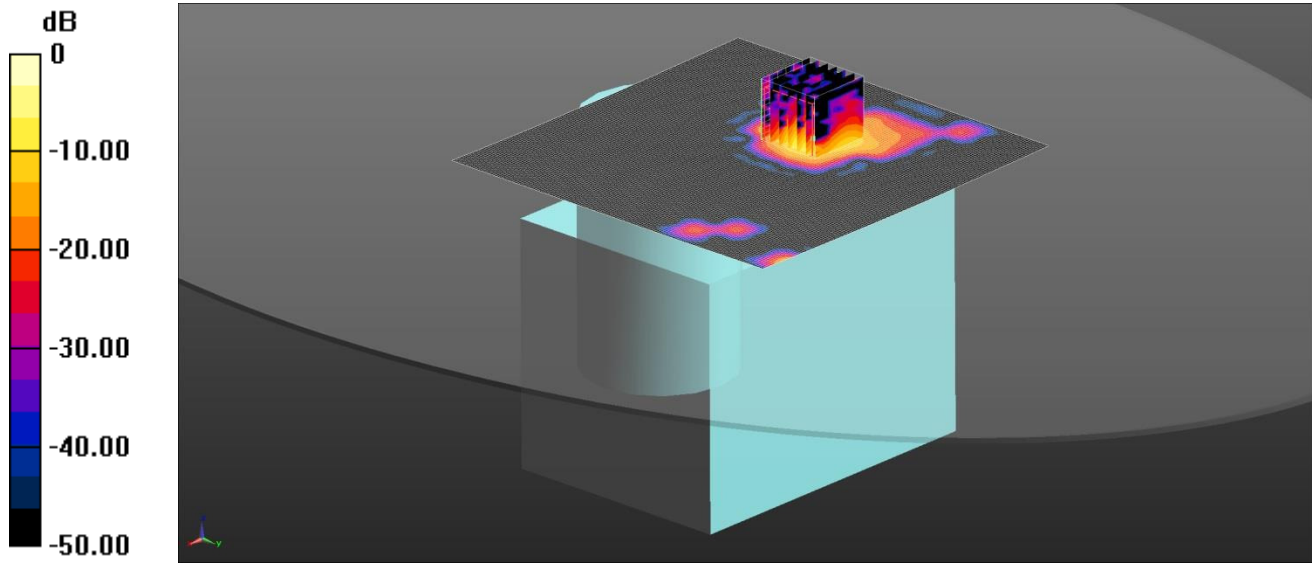

0 dB = 2.78 W/kg = 4.44 dBW/kg

Communication System: UID 0, WLAN 802.11 (0); Frequency: 5320 MHz; Duty Cycle: 1:1  
 Medium: 5250/5600/5750 MHz MSL Medium parameters used (interpolated):  $f = 5320$  MHz;  $\sigma = 5.485$  S/m;  $\epsilon_r = 47.215$ ;  $\rho = 1000$  kg/m<sup>3</sup>  
 Phantom section: Flat Section  
 DASY4 Configuration:  
 - Probe: EX3DV4 - SN3994; ConvF(4.38, 4.38, 4.38); Calibrated: 21/03/2016;  
 - Sensor-Surface: 3mm (Mechanical Surface Detection)  
 - Electronics: DAE4 Sn1438; Calibrated: 25/04/2016  
 - Phantom: ELI v5.0 (30deg probe tilt); Type: QDOVA002AA; Serial: 1253  
 - ; SEMCAD X Version 14.6.10 (7372)

**Configuration/Top 802.11a - Bodyworn - PBx/Area Scan 2 (141x141x1):** Interpolated grid: dx=1.000 mm, dy=1.000 mm

Maximum value of SAR (interpolated) = 1.81 W/kg

**Configuration/Top 802.11a - Bodyworn - PBx/Zoom Scan (7x7x7) (7x7x12)/Cube 0:** Measurement grid: dx=4mm, dy=4mm, dz=2mm

Reference Value = 24.04 V/m; Power Drift = 0.03 dB

Peak SAR (extrapolated) = 5.84 W/kg

**SAR(1 g) = 1.35 W/kg; SAR(10 g) = 0.288 W/kg**

Maximum value of SAR (measured) = 2.78 W/kg



**11.4. Calibration Certificate for E-field probe**

This sub-section contains Cal Certificates for E-field probes, and is not included in the total number of pages for this report.

A2544

Checked  
M. Nave  
19/05/2016

**Calibration Laboratory of  
Schmid & Partner  
Engineering AG**  
Zeughausstrasse 43, 8004 Zurich, Switzerland



**S** Schweizerischer Kalibrierdienst  
**C** Service suisse d'étalonnage  
**S** Servizio svizzero di taratura  
Swiss Calibration Service

Accreditation No.: **SCS 0108**

Accredited by the Swiss Accreditation Service (SAS)  
The Swiss Accreditation Service is one of the signatories to the EA  
Multilateral Agreement for the recognition of calibration certificates

Client **UL RFI UK**

Certificate No: **EX3-3994\_Mar16/2**

**CALIBRATION CERTIFICATE (Replacement of No: EX3-3994\_Mar16)**

Object **EX3DV4 - SN:3994**

Calibration procedure(s) **QA CAL-01.v9, QA CAL-14.v4, QA CAL-23.v5, QA CAL-25.v6  
Calibration procedure for dosimetric E-field probes**

Calibration date: **March 21, 2016**

This calibration certificate documents the traceability to national standards, which realize the physical units of measurements (SI).  
The measurements and the uncertainties with confidence probability are given on the following pages and are part of the certificate.

All calibrations have been conducted in the closed laboratory facility; environment temperature (22 ± 3)°C and humidity < 70%.

Calibration Equipment used (M&TE critical for calibration)

Primary Standards	ID	Cal Date (Certificate No.)	Scheduled Calibration
Power meter E4419B	GB41293874	01-Apr-15 (No. 217-02128)	Mar-16
Power sensor E4412A	MY41498087	01-Apr-15 (No. 217-02128)	Mar-16
Reference 3 dB Attenuator	SN: S5054 (3c)	01-Apr-15 (No. 217-02129)	Mar-16
Reference 20 dB Attenuator	SN: S5277 (20x)	01-Apr-15 (No. 217-02132)	Mar-16
Reference 30 dB Attenuator	SN: S5129 (30b)	01-Apr-15 (No. 217-02133)	Mar-16
Reference Probe ES3DV2	SN: 3013	31-Dec-15 (No. ES3-3013_Dec15)	Dec-16
DAE4	SN: 660	23-Dec-15 (No. DAE4-660_Dec15)	Dec-16
Secondary Standards	ID	Check Date (in house)	Scheduled Check
RF generator HP 8648C	US3642U01700	4-Aug-99 (in house check Apr-13)	In house check: Apr-16
Network Analyzer HP 8753E	US37390585	18-Oct-01 (in house check Oct-15)	In house check: Oct-16

	Name	Function	Signature
Calibrated by:	Leif Klynsner	Laboratory Technician	
Approved by:	Katja Pokovic	Technical Manager	

Issued: May 10, 2016

This calibration certificate shall not be reproduced except in full without written approval of the laboratory.



Accredited by the Swiss Accreditation Service (SAS)

Accreditation No.: **SCS 0108**

The Swiss Accreditation Service is one of the signatories to the EA  
Multilateral Agreement for the recognition of calibration certificates

### Glossary:

TSL	tissue simulating liquid
NORM <sub>x,y,z</sub>	sensitivity in free space
ConvF	sensitivity in TSL / NORM <sub>x,y,z</sub>
DCP	diode compression point
CF	crest factor (1/duty_cycle) of the RF signal
A, B, C, D	modulation dependent linearization parameters
Polarization $\varphi$	$\varphi$ rotation around probe axis
Polarization $\vartheta$	$\vartheta$ rotation around an axis that is in the plane normal to probe axis (at measurement center), i.e., $\vartheta = 0$ is normal to probe axis
Connector Angle	information used in DASY system to align probe sensor X to the robot coordinate system

### Calibration is Performed According to the Following Standards:

- IEEE Std 1528-2013, "IEEE Recommended Practice for Determining the Peak Spatial-Averaged Specific Absorption Rate (SAR) in the Human Head from Wireless Communications Devices: Measurement Techniques", June 2013
- IEC 62209-1, "Procedure to measure the Specific Absorption Rate (SAR) for hand-held devices used in close proximity to the ear (frequency range of 300 MHz to 3 GHz)", February 2005
- IEC 62209-2, "Procedure to determine the Specific Absorption Rate (SAR) for wireless communication devices used in close proximity to the human body (frequency range of 30 MHz to 6 GHz)", March 2010
- KDB 865664, "SAR Measurement Requirements for 100 MHz to 6 GHz"

### Methods Applied and Interpretation of Parameters:

- NORM<sub>x,y,z</sub>**: Assessed for E-field polarization  $\vartheta = 0$  ( $f \leq 900$  MHz in TEM-cell;  $f > 1800$  MHz: R22 waveguide). NORM<sub>x,y,z</sub> are only intermediate values, i.e., the uncertainties of NORM<sub>x,y,z</sub> does not affect the E<sup>2</sup>-field uncertainty inside TSL (see below ConvF).
- NORM(f)<sub>x,y,z</sub> = NORM<sub>x,y,z</sub> \* frequency\_response** (see Frequency Response Chart). This linearization is implemented in DASY4 software versions later than 4.2. The uncertainty of the frequency response is included in the stated uncertainty of ConvF.
- DCP<sub>x,y,z</sub>**: DCP are numerical linearization parameters assessed based on the data of power sweep with CW signal (no uncertainty required). DCP does not depend on frequency nor media.
- PAR**: PAR is the Peak to Average Ratio that is not calibrated but determined based on the signal characteristics
- A<sub>x,y,z</sub>; B<sub>x,y,z</sub>; C<sub>x,y,z</sub>; D<sub>x,y,z</sub>; VR<sub>x,y,z</sub>; A, B, C, D** are numerical linearization parameters assessed based on the data of power sweep for specific modulation signal. The parameters do not depend on frequency nor media. VR is the maximum calibration range expressed in RMS voltage across the diode.
- ConvF and Boundary Effect Parameters**: Assessed in flat phantom using E-field (or Temperature Transfer Standard for  $f \leq 800$  MHz) and inside waveguide using analytical field distributions based on power measurements for  $f > 800$  MHz. The same setups are used for assessment of the parameters applied for boundary compensation (alpha, depth) of which typical uncertainty values are given. These parameters are used in DASY4 software to improve probe accuracy close to the boundary. The sensitivity in TSL corresponds to NORM<sub>x,y,z</sub> \* ConvF whereby the uncertainty corresponds to that given for ConvF. A frequency dependent ConvF is used in DASY version 4.4 and higher which allows extending the validity from  $\pm 50$  MHz to  $\pm 100$  MHz.
- Spherical isotropy (3D deviation from isotropy)**: in a field of low gradients realized using a flat phantom exposed by a patch antenna.
- Sensor Offset**: The sensor offset corresponds to the offset of virtual measurement center from the probe tip (on probe axis). No tolerance required.
- Connector Angle**: The angle is assessed using the information gained by determining the NORM<sub>x</sub> (no uncertainty required).

# Probe EX3DV4

## SN:3994

Manufactured: January 21, 2014  
Calibrated: March 21, 2016

Calibrated for DASY/EASY Systems  
(Note: non-compatible with DASY2 system!)

## DASY/EASY - Parameters of Probe: EX3DV4 - SN:3994

### Basic Calibration Parameters

	Sensor X	Sensor Y	Sensor Z	Unc (k=2)
Norm ( $\mu\text{V}/(\text{V}/\text{m})^2$ ) <sup>A</sup>	0.50	0.50	0.43	$\pm 10.1 \%$
DCP (mV) <sup>B</sup>	101.2	101.2	96.5	

### Modulation Calibration Parameters

UID	Communication System Name		A dB	B dB $\sqrt{\mu\text{V}}$	C	D dB	VR mV	Unc <sup>E</sup> (k=2)
0	CW	X	0.0	0.0	1.0	0.00	195.7	$\pm 3.0 \%$
		Y	0.0	0.0	1.0		183.5	
		Z	0.0	0.0	1.0		177.0	

Note: For details on UID parameters see Appendix.

### Sensor Model Parameters

	C1 fF	C2 fF	$\alpha$ V <sup>-1</sup>	T1 ms.V <sup>-2</sup>	T2 ms.V <sup>-1</sup>	T3 ms	T4 V <sup>-2</sup>	T5 V <sup>-1</sup>	T6
X	64.44	483.3	36.1	24.54	1.628	5.046	0.743	0.447	1.007
Y	53.98	404.3	35.87	21.79	1.722	5.007	0.175	0.525	1.004
Z	58.14	448.8	38	23.28	1.723	5.019	0	0.516	1.005

The reported uncertainty of measurement is stated as the standard uncertainty of measurement multiplied by the coverage factor k=2, which for a normal distribution corresponds to a coverage probability of approximately 95%.

<sup>A</sup> The uncertainties of Norm X,Y,Z do not affect the E<sup>2</sup>-field uncertainty inside TSL (see Pages 5 and 6).

<sup>B</sup> Numerical linearization parameter: uncertainty not required.

<sup>E</sup> Uncertainty is determined using the max. deviation from linear response applying rectangular distribution and is expressed for the square of the field value.

## DASY/EASY - Parameters of Probe: EX3DV4 - SN:3994

### Calibration Parameter Determined in Head Tissue Simulating Media

f (MHz) <sup>C</sup>	Relative Permittivity <sup>F</sup>	Conductivity (S/m) <sup>F</sup>	ConvF X	ConvF Y	ConvF Z	Alpha <sup>G</sup>	Depth <sup>G</sup> (mm)	Unc (k=2)
750	41.9	0.89	10.32	10.32	10.32	0.65	0.80	± 12.0 %
835	41.5	0.90	9.79	9.79	9.79	0.57	0.86	± 12.0 %
900	41.5	0.97	9.42	9.42	9.42	0.47	0.95	± 12.0 %
1450	40.5	1.20	8.72	8.72	8.72	0.43	0.80	± 12.0 %
1750	40.1	1.37	8.42	8.42	8.42	0.34	0.80	± 12.0 %
1900	40.0	1.40	8.14	8.14	8.14	0.31	0.87	± 12.0 %
2100	39.8	1.49	8.26	8.26	8.26	0.36	0.80	± 12.0 %
2300	39.5	1.67	7.71	7.71	7.71	0.29	0.80	± 12.0 %
2450	39.2	1.80	7.36	7.36	7.36	0.32	0.80	± 12.0 %
2600	39.0	1.96	7.07	7.07	7.07	0.37	0.80	± 12.0 %
5250	35.9	4.71	5.20	5.20	5.20	0.35	1.80	± 13.1 %
5600	35.5	5.07	4.50	4.50	4.50	0.50	1.80	± 13.1 %
5750	35.4	5.22	4.51	4.51	4.51	0.50	1.80	± 13.1 %

<sup>C</sup> Frequency validity above 300 MHz of ± 100 MHz only applies for DASY v4.4 and higher (see Page 2), else it is restricted to ± 50 MHz. The uncertainty is the RSS of the ConvF uncertainty at calibration frequency and the uncertainty for the indicated frequency band. Frequency validity below 300 MHz is ± 10, 25, 40, 50 and 70 MHz for ConvF assessments at 30, 64, 128, 150 and 220 MHz respectively. Above 5 GHz frequency validity can be extended to ± 110 MHz.

<sup>F</sup> At frequencies below 3 GHz, the validity of tissue parameters ( $\epsilon$  and  $\sigma$ ) can be relaxed to ± 10% if liquid compensation formula is applied to measured SAR values. At frequencies above 3 GHz, the validity of tissue parameters ( $\epsilon$  and  $\sigma$ ) is restricted to ± 5%. The uncertainty is the RSS of the ConvF uncertainty for indicated target tissue parameters.

<sup>G</sup> Alpha/Depth are determined during calibration. SPEAG warrants that the remaining deviation due to the boundary effect after compensation is always less than ± 1% for frequencies below 3 GHz and below ± 2% for frequencies between 3-6 GHz at any distance larger than half the probe tip diameter from the boundary.

## DASY/EASY - Parameters of Probe: EX3DV4 - SN:3994

### Calibration Parameter Determined in Body Tissue Simulating Media

f (MHz) <sup>C</sup>	Relative Permittivity <sup>F</sup>	Conductivity (S/m) <sup>F</sup>	ConvF X	ConvF Y	ConvF Z	Alpha <sup>G</sup>	Depth <sup>G</sup> (mm)	Unc (k=2)
750	55.5	0.96	9.93	9.93	9.93	0.54	0.80	± 12.0 %
835	55.2	0.97	9.73	9.73	9.73	0.44	0.89	± 12.0 %
900	55.0	1.05	9.74	9.74	9.74	0.41	0.90	± 12.0 %
1450	54.0	1.30	8.47	8.47	8.47	0.32	0.80	± 12.0 %
1750	53.4	1.49	8.12	8.12	8.12	0.46	0.80	± 12.0 %
1900	53.3	1.52	7.81	7.81	7.81	0.37	0.85	± 12.0 %
2100	53.2	1.62	8.10	8.10	8.10	0.28	1.02	± 12.0 %
2300	52.9	1.81	7.45	7.45	7.45	0.32	0.95	± 12.0 %
2450	52.7	1.95	7.28	7.28	7.28	0.36	0.85	± 12.0 %
2600	52.5	2.16	6.99	6.99	6.99	0.29	0.95	± 12.0 %
5250	48.9	5.36	4.38	4.38	4.38	0.55	1.90	± 13.1 %
5600	48.5	5.77	3.76	3.76	3.76	0.60	1.90	± 13.1 %
5750	48.3	5.94	3.99	3.99	3.99	0.60	1.90	± 13.1 %

<sup>C</sup> Frequency validity above 300 MHz of ± 100 MHz only applies for DASY v4.4 and higher (see Page 2), else it is restricted to ± 50 MHz. The uncertainty is the RSS of the ConvF uncertainty at calibration frequency and the uncertainty for the indicated frequency band. Frequency validity below 300 MHz is ± 10, 25, 40, 50 and 70 MHz for ConvF assessments at 30, 64, 128, 150 and 220 MHz respectively. Above 5 GHz frequency validity can be extended to ± 110 MHz.

<sup>F</sup> At frequencies below 3 GHz, the validity of tissue parameters ( $\epsilon$  and  $\sigma$ ) can be relaxed to ± 10% if liquid compensation formula is applied to measured SAR values. At frequencies above 3 GHz, the validity of tissue parameters ( $\epsilon$  and  $\sigma$ ) is restricted to ± 5%. The uncertainty is the RSS of the ConvF uncertainty for indicated target tissue parameters.

<sup>G</sup> Alpha/Depth are determined during calibration. SPEAG warrants that the remaining deviation due to the boundary effect after compensation is always less than ± 1% for frequencies below 3 GHz and below ± 2% for frequencies between 3-6 GHz at any distance larger than half the probe tip diameter from the boundary.

### Frequency Response of E-Field (TEM-Cell:ifi110 EXX, Waveguide: R22)

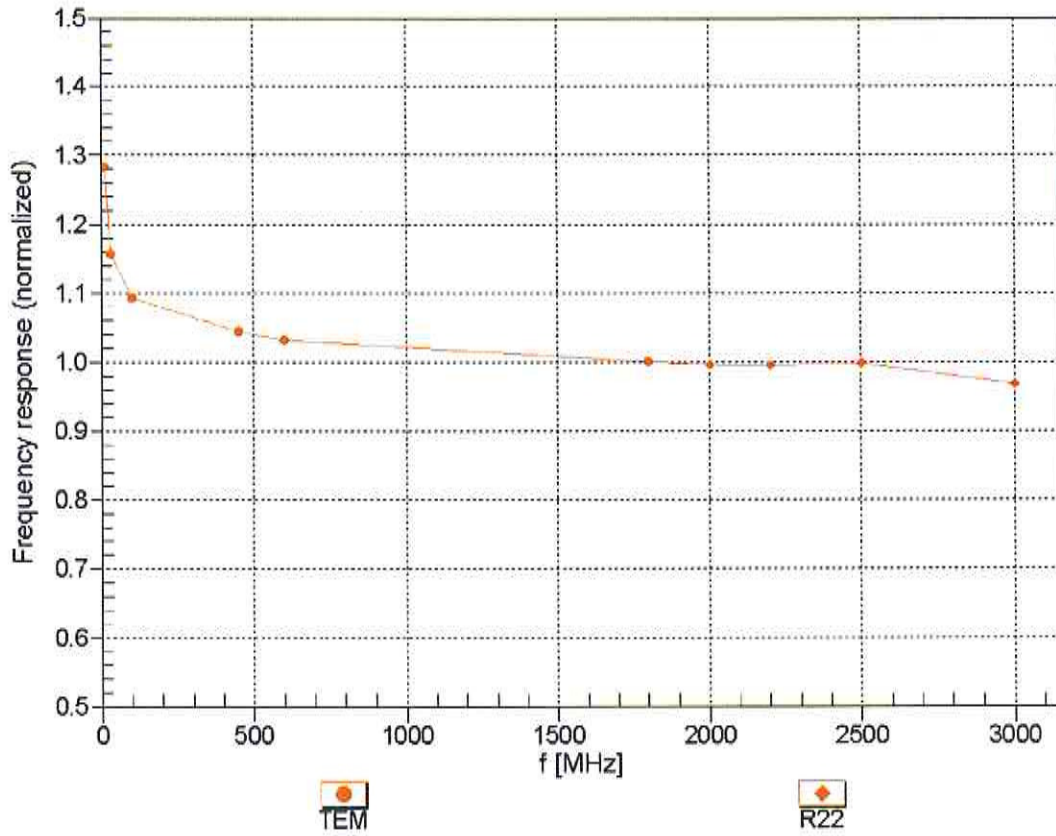

Uncertainty of Frequency Response of E-field:  $\pm 6.3\%$  (k=2)



### Receiving Pattern ( $\phi$ ), $\vartheta = 0^\circ$

f=600 MHz,TEM

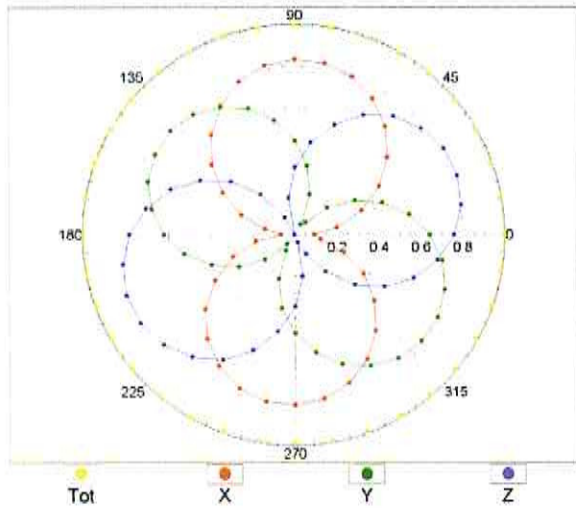

f=1800 MHz,R22

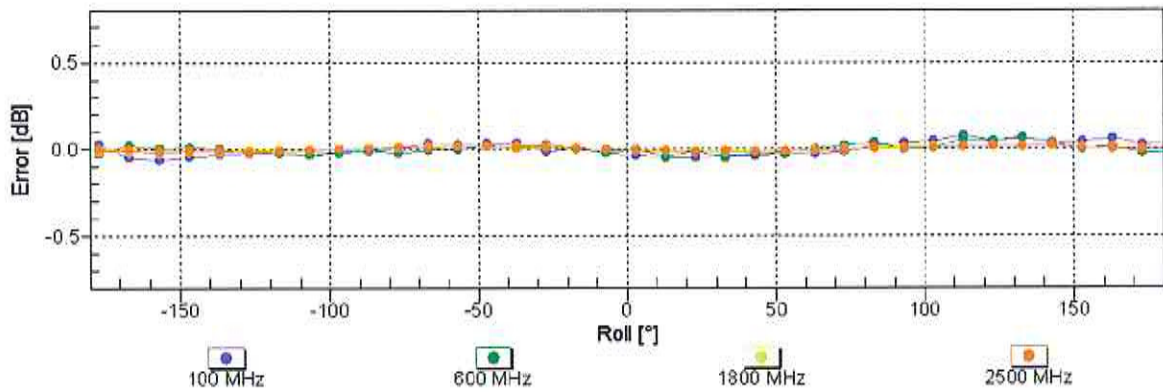
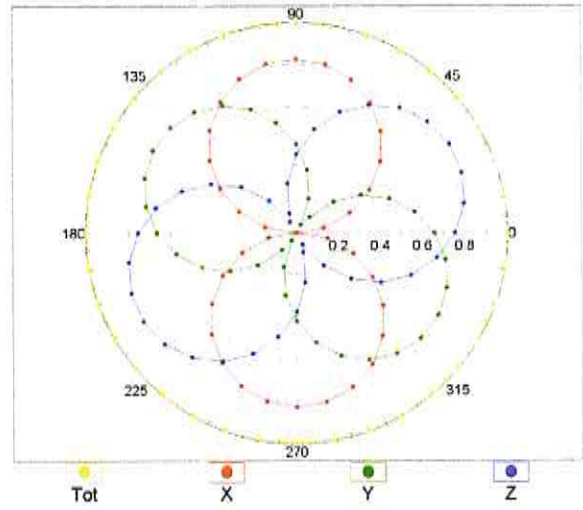

Uncertainty of Axial Isotropy Assessment:  $\pm 0.5\%$  (k=2)

### Dynamic Range $f(SAR_{head})$ (TEM cell , $f_{eval}= 1900$ MHz)

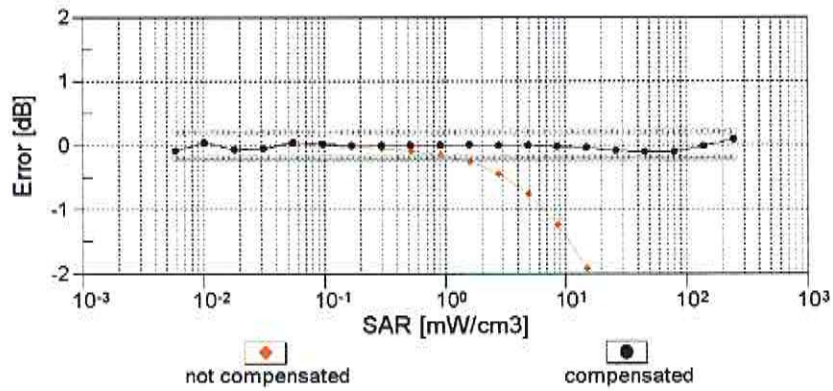
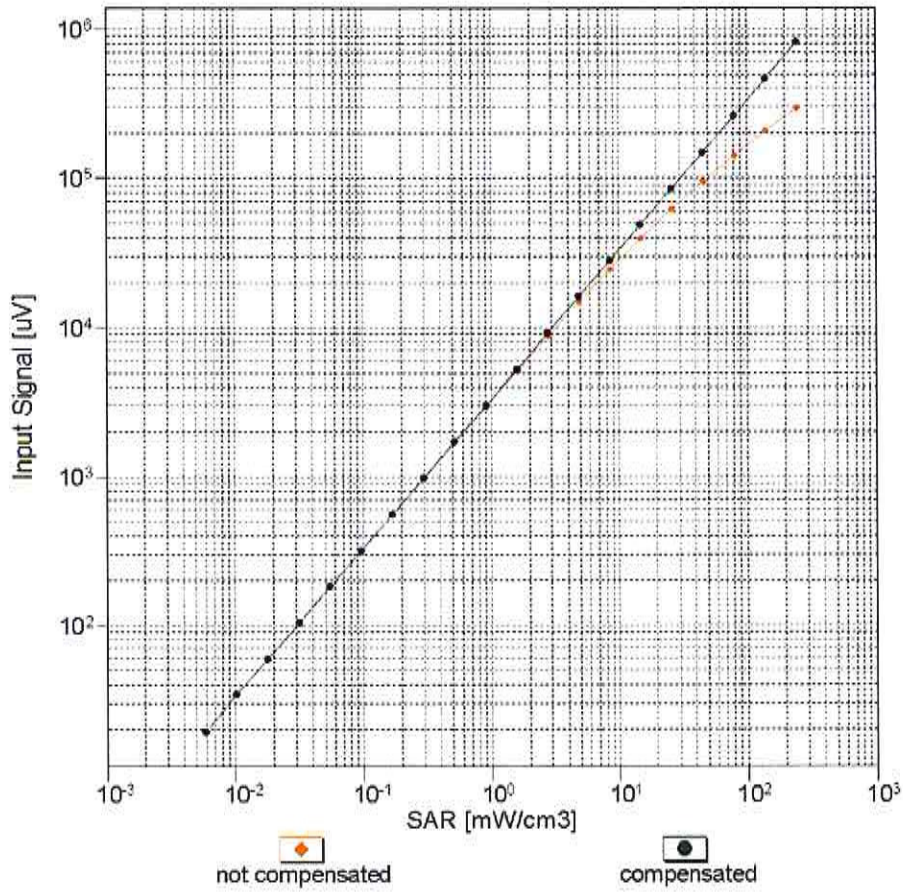

Uncertainty of Linearity Assessment:  $\pm 0.6\%$  (k=2)

# Conversion Factor Assessment

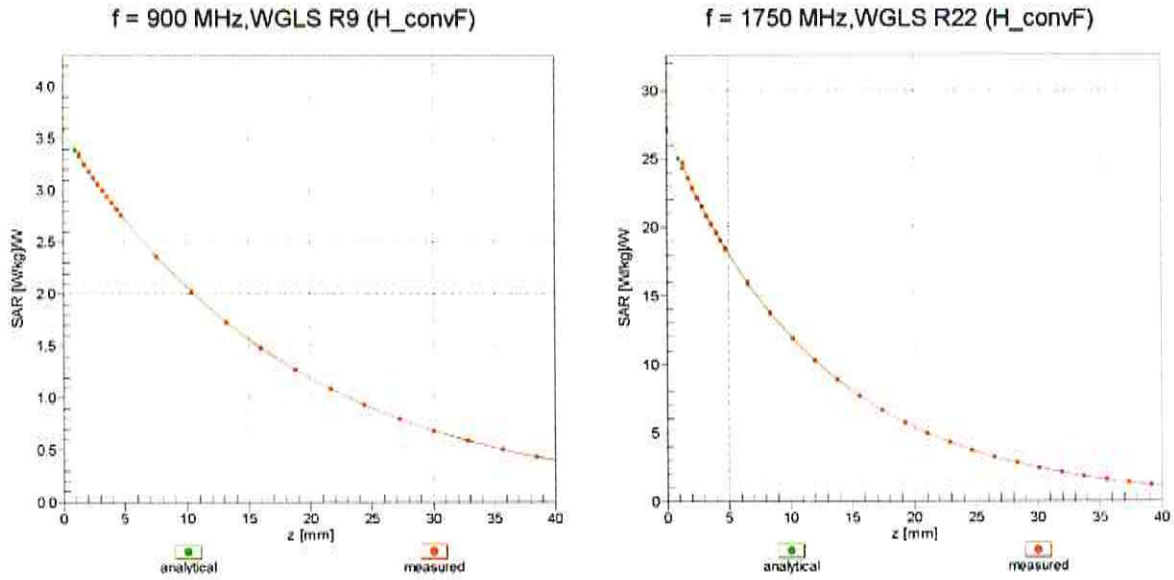

## Deviation from Isotropy in Liquid Error ( $\phi, \vartheta$ ), f = 900 MHz

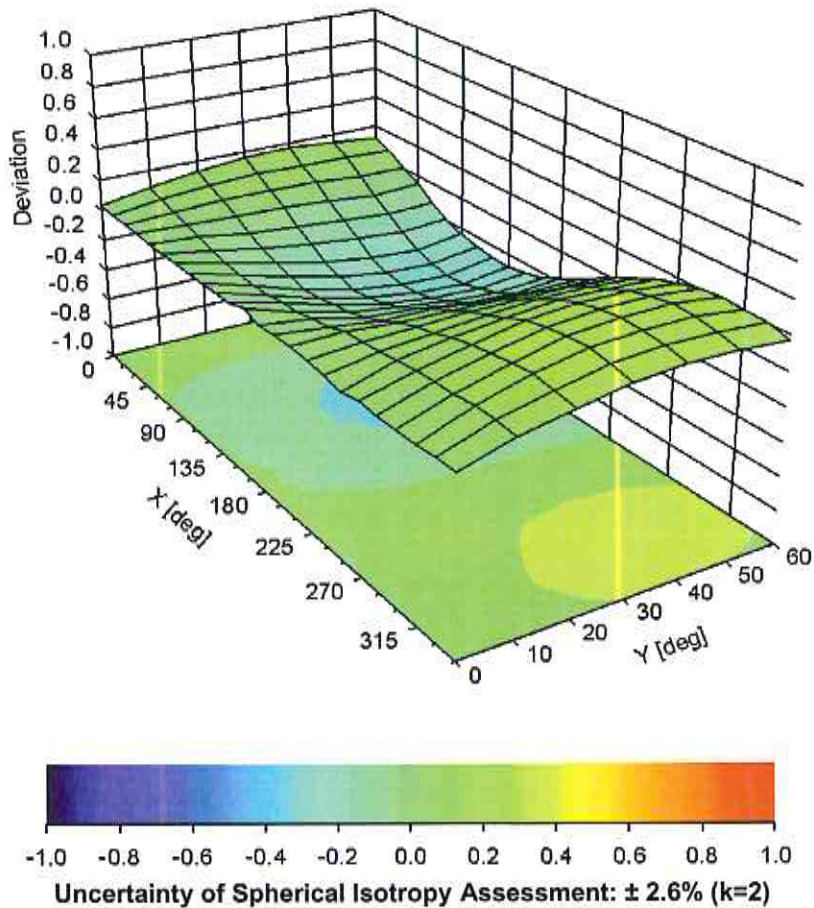

## DASY/EASY - Parameters of Probe: EX3DV4 - SN:3994

### Other Probe Parameters

Sensor Arrangement	Triangular
Connector Angle (°)	-27
Mechanical Surface Detection Mode	enabled
Optical Surface Detection Mode	disabled
Probe Overall Length	337 mm
Probe Body Diameter	10 mm
Tip Length	9 mm
Tip Diameter	2.5 mm
Probe Tip to Sensor X Calibration Point	1 mm
Probe Tip to Sensor Y Calibration Point	1 mm
Probe Tip to Sensor Z Calibration Point	1 mm
Recommended Measurement Distance from Surface	1.4 mm

A2587

Checked  
M. Nasser  
04/09/15

**Calibration Laboratory of  
Schmid & Partner  
Engineering AG**  
Zeughausstrasse 43, 8004 Zurich, Switzerland



**S** Schweizerischer Kalibrierdienst  
**S** Service suisse d'étalonnage  
**S** Servizio svizzero di taratura  
**S** Swiss Calibration Service

Accredited by the Swiss Accreditation Service (SAS)

Accreditation No.: **SCS 0108**

The Swiss Accreditation Service is one of the signatories to the EA  
Multilateral Agreement for the recognition of calibration certificates

Client **UL RFI UK**

Certificate No: **ES3-3341\_Aug15**

## CALIBRATION CERTIFICATE

Object **ES3DV3 - SN:3341**

Calibration procedure(s) **QA CAL-01.v9, QA CAL-12.v9, QA CAL-23.v5, QA CAL-25.v6  
Calibration procedure for dosimetric E-field probes**

Calibration date: **August 25, 2015**

This calibration certificate documents the traceability to national standards, which realize the physical units of measurements (SI).  
The measurements and the uncertainties with confidence probability are given on the following pages and are part of the certificate.

All calibrations have been conducted in the closed laboratory facility: environment temperature ( $22 \pm 3$ )°C and humidity < 70%.

Calibration Equipment used (M&TE critical for calibration)

Primary Standards	ID	Cal Date (Certificate No.)	Scheduled Calibration
Power meter E4419B	GB41293874	01-Apr-15 (No. 217-02128)	Mar-16
Power sensor E4412A	MY41498087	01-Apr-15 (No. 217-02128)	Mar-16
Reference 3 dB Attenuator	SN: S5054 (3c)	01-Apr-15 (No. 217-02129)	Mar-16
Reference 20 dB Attenuator	SN: S5277 (20x)	01-Apr-15 (No. 217-02132)	Mar-16
Reference 30 dB Attenuator	SN: S5129 (30b)	01-Apr-15 (No. 217-02133)	Mar-16
Reference Probe ES3DV2	SN: 3013	30-Dec-14 (No. ES3-3013_Dec14)	Dec-15
DAE4	SN: 660	14-Jan-15 (No. DAE4-660_Jan15)	Jan-16
Secondary Standards	ID	Check Date (in house)	Scheduled Check
RF generator HP 8648C	US3642U01700	4-Aug-99 (in house check Apr-13)	In house check: Apr-16
Network Analyzer HP 8753E	US37390585	18-Oct-01 (in house check Oct-14)	In house check: Oct-15

	Name	Function	Signature
Calibrated by:	Claudio Leubler	Laboratory Technician	
Approved by:	Katja Pokovic	Technical Manager	

Issued: August 25, 2015

This calibration certificate shall not be reproduced except in full without written approval of the laboratory.



Accredited by the Swiss Accreditation Service (SAS)

Accreditation No.: **SCS 0108**

The Swiss Accreditation Service is one of the signatories to the EA  
Multilateral Agreement for the recognition of calibration certificates

### Glossary:

TSL	tissue simulating liquid
NORM <sub>x,y,z</sub>	sensitivity in free space
ConvF	sensitivity in TSL / NORM <sub>x,y,z</sub>
DCP	diode compression point
CF	crest factor (1/duty_cycle) of the RF signal
A, B, C, D	modulation dependent linearization parameters
Polarization $\varphi$	$\varphi$ rotation around probe axis
Polarization $\vartheta$	$\vartheta$ rotation around an axis that is in the plane normal to probe axis (at measurement center), i.e., $\vartheta = 0$ is normal to probe axis
Connector Angle	information used in DASY system to align probe sensor X to the robot coordinate system

### Calibration is Performed According to the Following Standards:

- IEEE Std 1528-2013, "IEEE Recommended Practice for Determining the Peak Spatial-Averaged Specific Absorption Rate (SAR) in the Human Head from Wireless Communications Devices: Measurement Techniques", June 2013
- IEC 62209-1, "Procedure to measure the Specific Absorption Rate (SAR) for hand-held devices used in close proximity to the ear (frequency range of 300 MHz to 3 GHz)", February 2005
- IEC 62209-2, "Procedure to determine the Specific Absorption Rate (SAR) for wireless communication devices used in close proximity to the human body (frequency range of 30 MHz to 6 GHz)", March 2010
- KDB 865664, "SAR Measurement Requirements for 100 MHz to 6 GHz"

### Methods Applied and Interpretation of Parameters:

- NORM<sub>x,y,z</sub>**: Assessed for E-field polarization  $\vartheta = 0$  ( $f \leq 900$  MHz in TEM-cell;  $f > 1800$  MHz: R22 waveguide). NORM<sub>x,y,z</sub> are only intermediate values, i.e., the uncertainties of NORM<sub>x,y,z</sub> does not affect the  $E^2$ -field uncertainty inside TSL (see below *ConvF*).
- NORM(f)<sub>x,y,z</sub>** = NORM<sub>x,y,z</sub> \* *frequency\_response* (see Frequency Response Chart). This linearization is implemented in DASY4 software versions later than 4.2. The uncertainty of the frequency response is included in the stated uncertainty of *ConvF*.
- DCP<sub>x,y,z</sub>**: DCP are numerical linearization parameters assessed based on the data of power sweep with CW signal (no uncertainty required). DCP does not depend on frequency nor media.
- PAR**: PAR is the Peak to Average Ratio that is not calibrated but determined based on the signal characteristics
- A<sub>x,y,z</sub>; B<sub>x,y,z</sub>; C<sub>x,y,z</sub>; D<sub>x,y,z</sub>; VR<sub>x,y,z</sub>**: A, B, C, D are numerical linearization parameters assessed based on the data of power sweep for specific modulation signal. The parameters do not depend on frequency nor media. VR is the maximum calibration range expressed in RMS voltage across the diode.
- ConvF and Boundary Effect Parameters**: Assessed in flat phantom using E-field (or Temperature Transfer Standard for  $f \leq 800$  MHz) and inside waveguide using analytical field distributions based on power measurements for  $f > 800$  MHz. The same setups are used for assessment of the parameters applied for boundary compensation (alpha, depth) of which typical uncertainty values are given. These parameters are used in DASY4 software to improve probe accuracy close to the boundary. The sensitivity in TSL corresponds to NORM<sub>x,y,z</sub> \* *ConvF* whereby the uncertainty corresponds to that given for *ConvF*. A frequency dependent *ConvF* is used in DASY version 4.4 and higher which allows extending the validity from  $\pm 50$  MHz to  $\pm 100$  MHz.
- Spherical isotropy (3D deviation from isotropy)**: in a field of low gradients realized using a flat phantom exposed by a patch antenna.
- Sensor Offset**: The sensor offset corresponds to the offset of virtual measurement center from the probe tip (on probe axis). No tolerance required.
- Connector Angle**: The angle is assessed using the information gained by determining the NORM<sub>x</sub> (no uncertainty required).

# Probe ES3DV3

## SN:3341

Manufactured: March 15, 2012  
Calibrated: August 25, 2015

Calibrated for DASY/EASY Systems  
(Note: non-compatible with DASY2 system!)

## DASY/EASY - Parameters of Probe: ES3DV3 - SN:3341

### Basic Calibration Parameters

	Sensor X	Sensor Y	Sensor Z	Unc (k=2)
Norm ( $\mu\text{V}/(\text{V}/\text{m})^2$ ) <sup>A</sup>	1.04	1.14	1.07	± 10.1 %
DCP (mV) <sup>B</sup>	107.5	104.4	107.1	

### Modulation Calibration Parameters

UID	Communication System Name		A dB	B dB $\sqrt{\mu\text{V}}$	C	D dB	VR mV	Unc <sup>E</sup> (k=2)
0	CW	X	0.0	0.0	1.0	0.00	194.4	±3.3 %
		Y	0.0	0.0	1.0		199.7	
		Z	0.0	0.0	1.0		194.4	

The reported uncertainty of measurement is stated as the standard uncertainty of measurement multiplied by the coverage factor k=2, which for a normal distribution corresponds to a coverage probability of approximately 95%.

<sup>A</sup> The uncertainties of Norm X,Y,Z do not affect the E<sup>2</sup>-field uncertainty inside TSL (see Pages 5 and 6).

<sup>B</sup> Numerical linearization parameter: uncertainty not required.

<sup>E</sup> Uncertainty is determined using the max. deviation from linear response applying rectangular distribution and is expressed for the square of the field value.



## DASY/EASY - Parameters of Probe: ES3DV3 - SN:3341

### Calibration Parameter Determined in Head Tissue Simulating Media

f (MHz) <sup>C</sup>	Relative Permittivity <sup>F</sup>	Conductivity (S/m) <sup>F</sup>	ConvF X	ConvF Y	ConvF Z	Alpha <sup>G</sup>	Depth <sup>G</sup> (mm)	Unc (k=2)
450	43.5	0.87	6.82	6.82	6.82	0.19	1.90	± 13.3 %
750	41.9	0.89	6.53	6.53	6.53	0.22	2.52	± 12.0 %
835	41.5	0.90	6.42	6.42	6.42	0.80	1.15	± 12.0 %
900	41.5	0.97	6.17	6.17	6.17	0.53	1.42	± 12.0 %
1450	40.5	1.20	5.39	5.39	5.39	0.35	1.76	± 12.0 %
1750	40.1	1.37	5.27	5.27	5.27	0.76	1.17	± 12.0 %
1900	40.0	1.40	5.07	5.07	5.07	0.75	1.20	± 12.0 %
2100	39.8	1.49	5.12	5.12	5.12	0.52	1.49	± 12.0 %
2300	39.5	1.67	4.80	4.80	4.80	0.62	1.40	± 12.0 %
2450	39.2	1.80	4.50	4.50	4.50	0.80	1.25	± 12.0 %
2600	39.0	1.96	4.33	4.33	4.33	0.75	1.27	± 12.0 %

<sup>C</sup> Frequency validity above 300 MHz of ± 100 MHz only applies for DASY v4.4 and higher (see Page 2), else it is restricted to ± 50 MHz. The uncertainty is the RSS of the ConvF uncertainty at calibration frequency and the uncertainty for the indicated frequency band. Frequency validity below 300 MHz is ± 10, 25, 40, 50 and 70 MHz for ConvF assessments at 30, 64, 128, 150 and 220 MHz respectively. Above 5 GHz frequency validity can be extended to ± 110 MHz.

<sup>F</sup> At frequencies below 3 GHz, the validity of tissue parameters ( $\epsilon$  and  $\sigma$ ) can be relaxed to ± 10% if liquid compensation formula is applied to measured SAR values. At frequencies above 3 GHz, the validity of tissue parameters ( $\epsilon$  and  $\sigma$ ) is restricted to ± 5%. The uncertainty is the RSS of the ConvF uncertainty for indicated target tissue parameters.

<sup>G</sup> Alpha/Depth are determined during calibration. SPEAG warrants that the remaining deviation due to the boundary effect after compensation is always less than ± 1% for frequencies below 3 GHz and below ± 2% for frequencies between 3-6 GHz at any distance larger than half the probe tip diameter from the boundary.

## DASY/EASY - Parameters of Probe: ES3DV3 - SN:3341

### Calibration Parameter Determined in Body Tissue Simulating Media

f (MHz) <sup>C</sup>	Relative Permittivity <sup>F</sup>	Conductivity (S/m) <sup>F</sup>	ConvF X	ConvF Y	ConvF Z	Alpha <sup>G</sup>	Depth <sup>G</sup> (mm)	Unc (k=2)
450	56.7	0.94	7.33	7.33	7.33	0.15	1.50	± 13.3 %
750	55.5	0.96	6.37	6.37	6.37	0.30	1.93	± 12.0 %
835	55.2	0.97	6.33	6.33	6.33	0.48	1.53	± 12.0 %
900	55.0	1.05	6.14	6.14	6.14	0.36	1.85	± 12.0 %
1450	54.0	1.30	5.16	5.16	5.16	0.34	1.87	± 12.0 %
1750	53.4	1.49	4.93	4.93	4.93	0.72	1.31	± 12.0 %
1900	53.3	1.52	4.78	4.78	4.78	0.68	1.40	± 12.0 %
2100	53.2	1.62	4.88	4.88	4.88	0.80	1.31	± 12.0 %
2300	52.9	1.81	4.54	4.54	4.54	0.80	1.15	± 12.0 %
2450	52.7	1.95	4.31	4.31	4.31	0.80	1.16	± 12.0 %
2600	52.5	2.16	4.10	4.10	4.10	0.80	1.20	± 12.0 %

<sup>C</sup> Frequency validity above 300 MHz of ± 100 MHz only applies for DASY v4.4 and higher (see Page 2), else it is restricted to ± 50 MHz. The uncertainty is the RSS of the ConvF uncertainty at calibration frequency and the uncertainty for the indicated frequency band. Frequency validity below 300 MHz is ± 10, 25, 40, 50 and 70 MHz for ConvF assessments at 30, 64, 128, 150 and 220 MHz respectively. Above 5 GHz frequency validity can be extended to ± 110 MHz.

<sup>F</sup> At frequencies below 3 GHz, the validity of tissue parameters ( $\epsilon$  and  $\sigma$ ) can be relaxed to ± 10% if liquid compensation formula is applied to measured SAR values. At frequencies above 3 GHz, the validity of tissue parameters ( $\epsilon$  and  $\sigma$ ) is restricted to ± 5%. The uncertainty is the RSS of the ConvF uncertainty for indicated target tissue parameters.

<sup>G</sup> Alpha/Depth are determined during calibration. SPEAG warrants that the remaining deviation due to the boundary effect after compensation is always less than ± 1% for frequencies below 3 GHz and below ± 2% for frequencies between 3-6 GHz at any distance larger than half the probe tip diameter from the boundary.

### Frequency Response of E-Field (TEM-Cell:ifi110 EXX, Waveguide: R22)

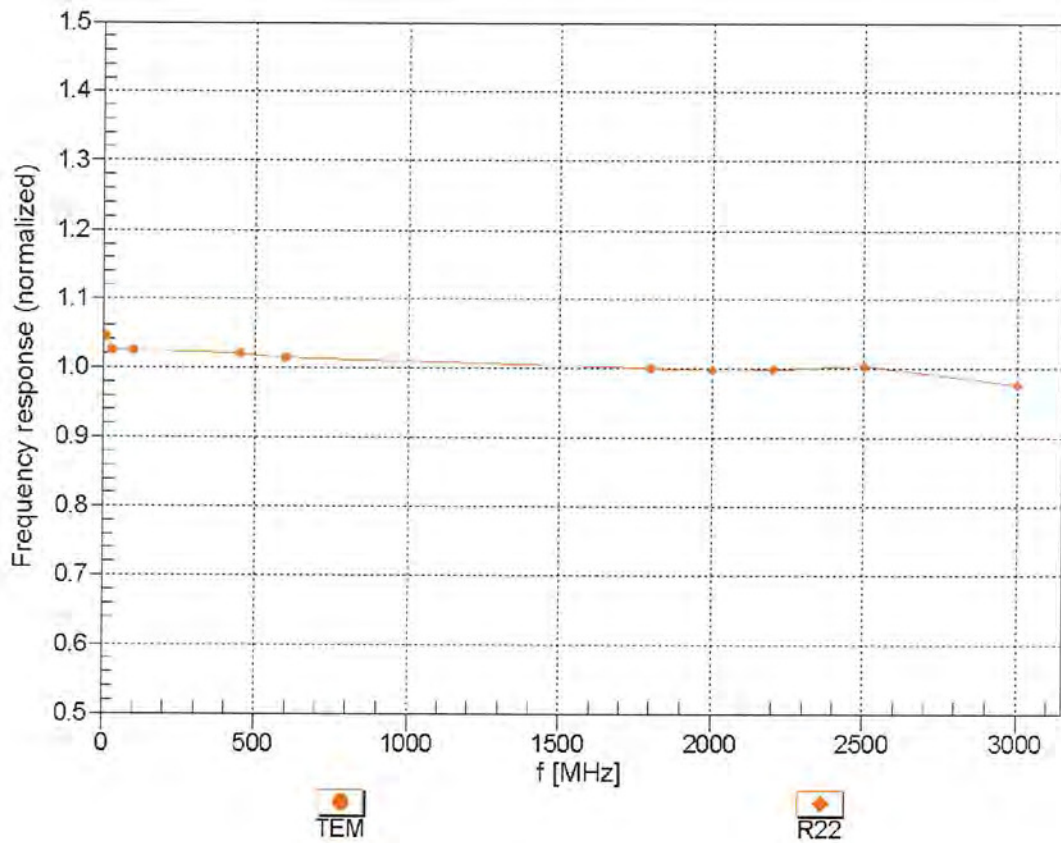

Uncertainty of Frequency Response of E-field:  $\pm 6.3\%$  (k=2)

### Receiving Pattern ( $\phi$ ), $\vartheta = 0^\circ$

f=600 MHz,TEM

f=1800 MHz,R22

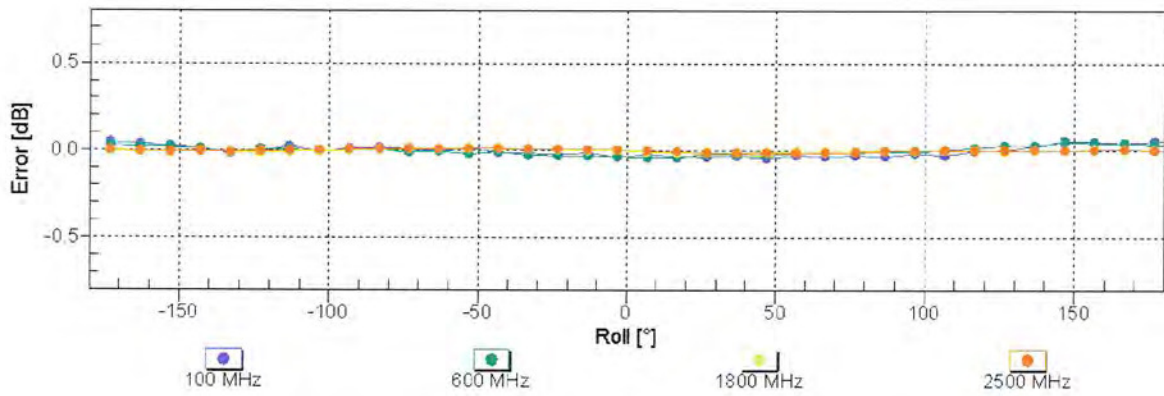
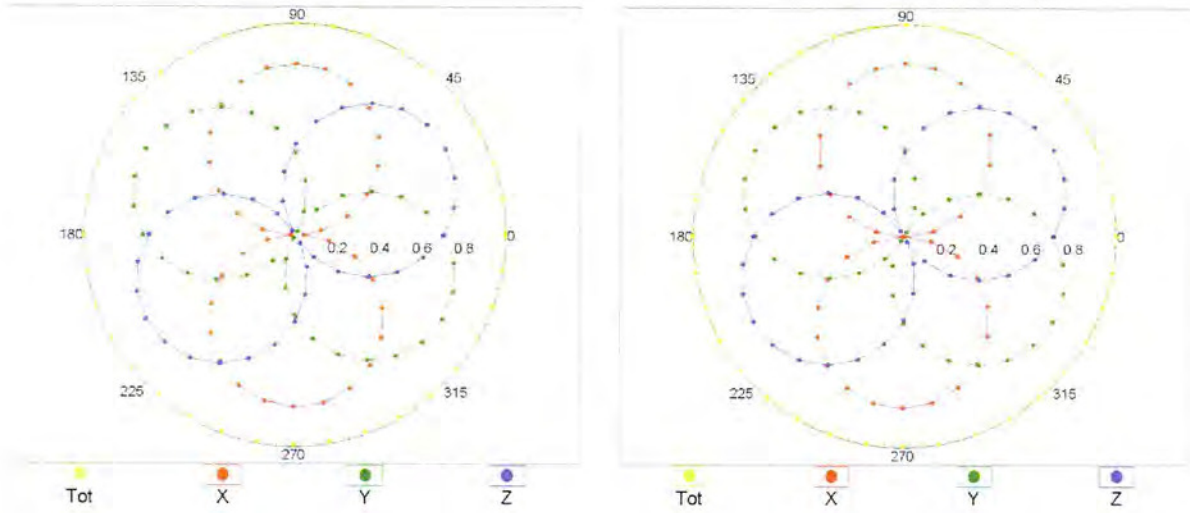

Uncertainty of Axial Isotropy Assessment:  $\pm 0.5\%$  (k=2)

### Dynamic Range f(SAR<sub>head</sub>) (TEM cell , f<sub>eval</sub>= 1900 MHz)

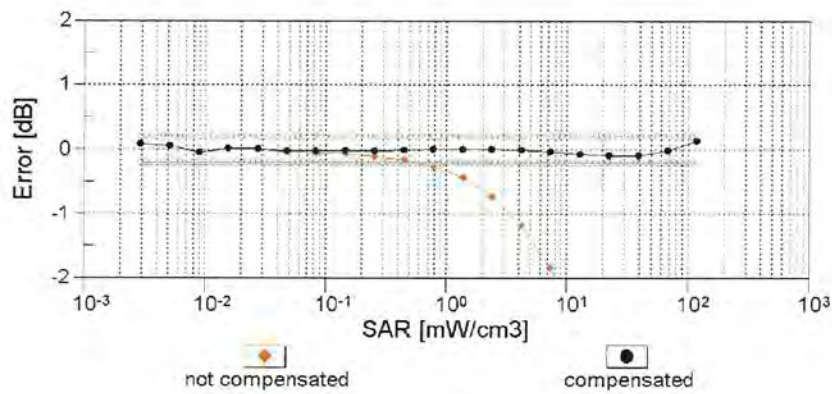
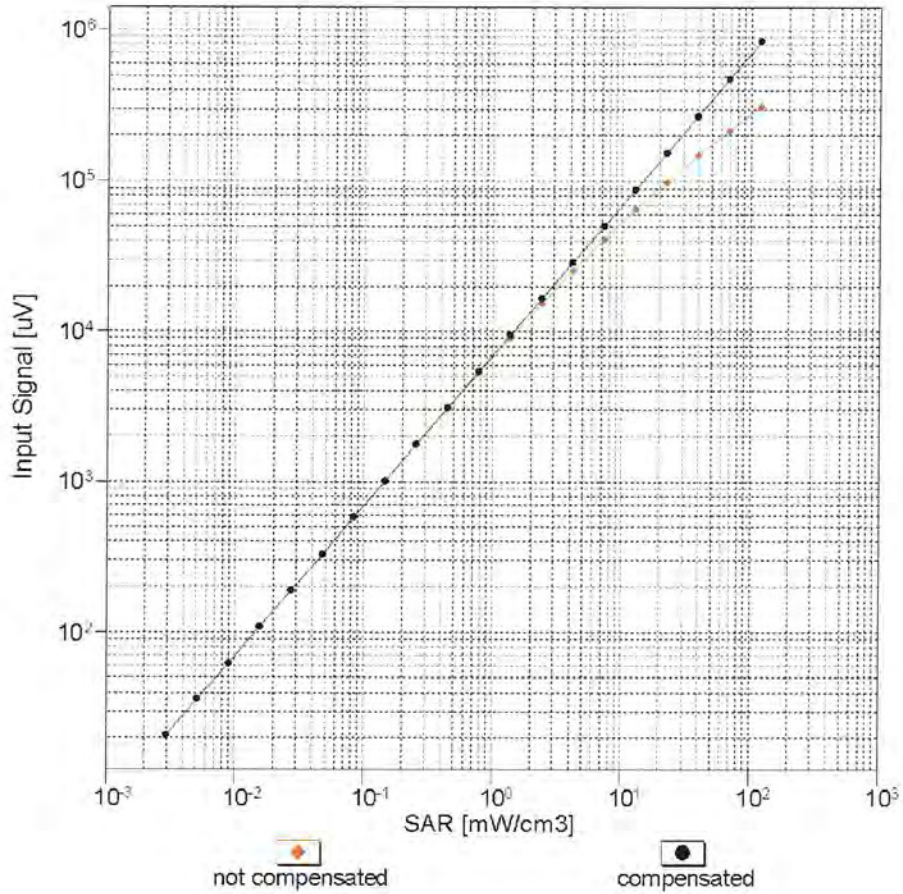

Uncertainty of Linearity Assessment: ± 0.6% (k=2)

# Conversion Factor Assessment

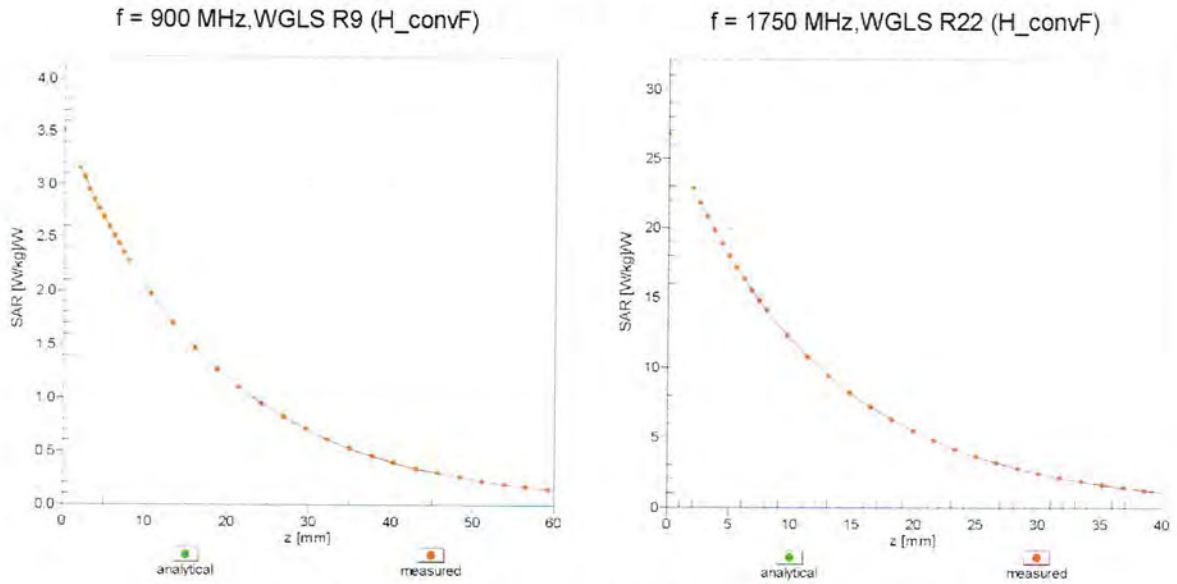

## Deviation from Isotropy in Liquid Error ( $\phi, \vartheta$ ), f = 900 MHz

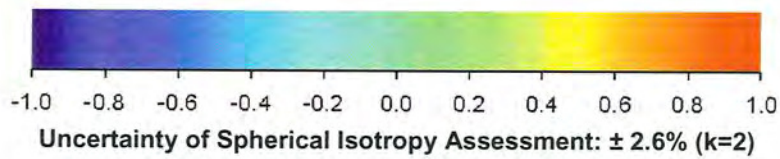
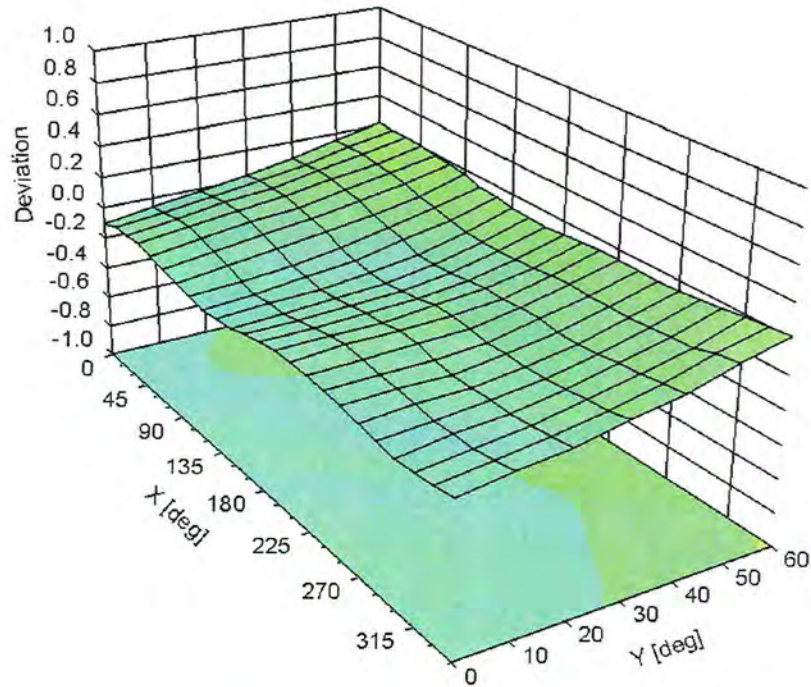

## DASY/EASY - Parameters of Probe: ES3DV3 - SN:3341

### Other Probe Parameters

Sensor Arrangement	Triangular
Connector Angle (°)	106.8
Mechanical Surface Detection Mode	enabled
Optical Surface Detection Mode	disabled
Probe Overall Length	337 mm
Probe Body Diameter	10 mm
Tip Length	10 mm
Tip Diameter	4 mm
Probe Tip to Sensor X Calibration Point	2 mm
Probe Tip to Sensor Y Calibration Point	2 mm
Probe Tip to Sensor Z Calibration Point	2 mm
Recommended Measurement Distance from Surface	3 mm