

SAR TEST REPORT

Reference No. : WTS16S0346199E V1
FCC ID..... : 2AEE8LAVAIRIS758
Applicant : LAVA INTERNATIONAL (H.K) LIMITED
Address : UNIT L 1/F MAU LAM COMM BLDG 16-18 MAU LAM ST, JORDAN KL, HK
Manufacturer : LAVA INTERNATIONAL (H.K) LIMITED
Address : UNIT L 1/F MAU LAM COMM BLDG 16-18 MAU LAM ST, JORDAN KL, HK
Product Name : Mobile Phone
Model No. : iris 758
Brand : LAVA
Standards : FCC 47 CFR Part2(2.1093)
ANSI/IEEE C95.1-2006
IEEE 1528-2013 & Published RF Exposure KDB Procedures
Date of Receipt sample.... : Mar. 29, 2016
Date of Test..... : Mar. 30, 2016 - Apr. 14, 2016
Date of Issue : May. 12, 2016
Test Result : Pass

Remarks:

The results shown in this test report refer only to the sample(s) tested, this test report cannot be reproduced, except in full, without prior written permission of the company. The report would be invalid without specific stamp of test institute and the signatures of compiler and approver.

Prepared By:

Waltek Services (Shenzhen) Co., Ltd.

Address: 1/F., Fukangtai Building, West Baima Road, Songgang Street, Baoan District, Shenzhen, Guangdong, China

Tel :+86-755-83551033

Fax:+86-755-83552400

Compiled by:



Zero Zhou / Test Engineer

Approved by:



Philo Zhong / Manager

1 Laboratory Introduction

Waltek Service Co., Ltd. is a professional third-party testing and certification organization with multi-year product testing and certification experience. Established strictly in accordance with ISO/IEC Guide 65 and ISO/IEC 17025, our company has got recognition from CNAS (China National Accreditation Service for Conformity Assessment) and International Laboratory Accreditation Cooperation (ILAC). At the same time, our company has been approved by some authoritative organizations, such as EMSD of Hongkong, UL, Intertek-ETL SEMKO, CSA, MET, TÜV Rheinland, TÜV SÜD, SGS, Nemko, FCC, IC of Canada, CPSC, TMICO and California Energy Commission (CEC). Since the set-up of our company, we sincerely help our customers to improve their products to achieve relative international standards. We are accepted by various clients in international market and well-known in the same industry.



There are several laboratories in our company which are equipped with advanced equipments for fully testing. It can provide testing and certification services for products exported around the world, also it can ensure that the products reach international standards in aspects of safety, electromagnetic compatibility, virulence, energy efficiency, reliability and so on. To enable our customers can get local services more directly and conveniently, and to realize our promise to provide more high quality services. Our company has set up product testing labs in South China and East China (Shenzhen, Dongguan, Foshan, Suzhou and Ningbo). We can provide our clients with accurate test and technical support services in good faith, and actively follow customer demand. These can fully demonstrate Waltek Services concept -- "One-stop Services".

Our company has many experienced engineers and customer service representatives to meet our customer's demand for a number of tests and provide superb technical guidance and modification service; At the same time we can provide global certification services by our global partners to help our customer's products to successfully extend to the global market.

2 Report Revision History

Report No.	Report Version	Description	Issue Date
WTS16S0346199E	NONE	Original	Apr. 18, 2016
WTS16S0346199E	V1	Version 1	May. 12, 2016

3 Contents

1	LABORATORY INTRODUCTION	2
2	REPORT REVISION HISTORY	3
3	CONTENTS	4
4	GENERAL INFORMATION	5
5	INTRODUCTION	7
6	SAR MEASUREMENT SETUP	8
7	EXPOSURE LIMIT	17
8	SYSTEM AND LIQUID VALIDATION	18
9	TYPE A MEASUREMENT UNCERTAINTY	31
10	TEST INSTRUMENT	34
11	OUTPUT POWER VERIFICATION	35
12	EXPOSURE CONDITIONS CONSIDERATION	57
13	SAR TEST RESULTS	59
14	SAR MEASUREMENT REFERENCES	70
15	CALIBRATION REPORTS-PROBE	90
16	SAR SYSTEM PHOTOS	147
17	SETUP PHOTOS	148
18	EUT PHOTOS	150

4 General Information

4.1 General Description of E.U.T.

Product Name:	Mobile Phone
Model No.:	iris 758
Model Description:	N/A
GSM Band(s):	GSM 850/900/1800/1900MHz
GPRS/EGPRS Class:	12
WCDMA Band(s):	FDD Band II/V
LTE Bnad(s)	LTE Band 2/4/7
Wi-Fi Specification:	802.11b/g/n HT20/n HT40
Bluetooth Version:	Bluetooth v4.0 with BLE
GPS:	Support
NFC:	N/A
Hardware Version	V2.0
Software Version	LAVA_iris 758_MX_S101_20160311

4.2 Details of E.U.T.

Operation Frequency	GSM/GPRS/EDGE 850: 824~849MHz PCS/GPRS/EDGE1900: 1850~1910MHz WCDMA Band II: 1850~1910MHz WCDMA Band V: 824~849MHz LTE Band 2: 1850~1910MHz LTE Band 4: 1710~1755MHz LTE Band 7: 2500-2570MHz WiFi: 802.11b/g/n HT20: 2412~2462MHz 802.11n HT40: 2422~2452MHz Bluetooth: 2402~2480MHz
Max. RF output power	GSM 850: 32.71dBm PCS1900:29.82dBm WCDMA Band II: 22.88dBm WCDMA Band V: 22.55dBm LTE Band 2: 22.78dBm LTE Band 4: 22.75dBm LTE Band 7: 23.63dBm WiFi: 9.51dBm Bluetooth:5.95dBm
Max.SAR:	0.37 W/Kg 1g Head Tissue 0.73 W/Kg 1g Body-worn Tissue 0.90 W/Kg 1g Hotspot Tissue

Max Simultaneous SAR	1.09 W/Kg
Type of Modulation:	GSM,GPRS: GMSK EDGE: GMSK, 8PSK WCDMA: BPSK LTE: QPSK, 16QAM WiFi: CCK, OFDM Bluetooth: GFSK, Pi/4 DQPSK,8DPSK
Antenna installation	GSM/WCDMA/LTE: internal permanent antenna WiFi/Bluetooth: internal permanent antenna
Antenna Gain	GSM 850: 0.6dBi PCS1900: 0.7dBi WCDMA Band II: 0.7dBi WCDMA Band V: 0.6dBi LTE Band 2: 0.7dBi LTE Band 4: 0.7dBi LTE Band 7: 0.6dBi WiFi(2.4G): 1.2dBi Bluetooth: 1.2dBi
Technical Data	Battery DC 3.8V 2000mAh DC 5V, 1A, charging from adapter (Adapter Input: 100-300V~50/60Hz 0.15A)
Adapter	Manufacture: Shenzhen Tianyin Electronics Co.,LTD. Model No.: CLV-14

5 INTRODUCTION

Introduction

This measurement report shows compliance of the EUT with ANSI/IEEE C95.1-2006 and FCC 47 CFR Part2 (2.1093)

The test procedures, as described in IEEE 1528-2013 Standard for IEEE Recommended Practice for Determining the Peak Spatial-Average Specific Absorption Rate (SAR) in the Human Head from Wireless Communications Devices: Measurement Techniques(300MHz~6GHz) and Published RF Exposure KDB Procedures

SAR Definition

- ▶ SAR : Specific Absorption Rate
- ▶ The SAR characterize the absorption of energy by a quantity of tissue
- ▶ This is related to a increase of the temperature of these tissues during a time period.

$$DAS = \frac{d}{dt} \left(\frac{dW}{dm} \right) = \frac{d}{dt} \left(\frac{dW}{\rho dV} \right)$$

$$DAS = \frac{\sigma E^2}{\rho}$$

$$DAS = c_h \left. \frac{dT}{dt} \right|_{t=0}$$

SAR definition

$$SAR = \frac{\sigma E^2}{\rho}$$

- ▶ SAR : Specific Absorption Rate

- σ : Liquid conductivity

- $\epsilon_r = \epsilon' - j\epsilon''$ (complex permittivity of liquid)

- $\sigma = \frac{\epsilon'' \omega}{\epsilon_0}$

- ρ : Liquid density

- $\rho = 1000 \text{ g/L} = 1000 \text{ Kg/m}^3$

where:

σ = conductivity of the tissue (S/m)

ρ = mass density of the tissue (kg/m³)

E = rms electric field strength (V/m)

6 SAR MEASUREMENT SETUP

SAR bench sub-systems

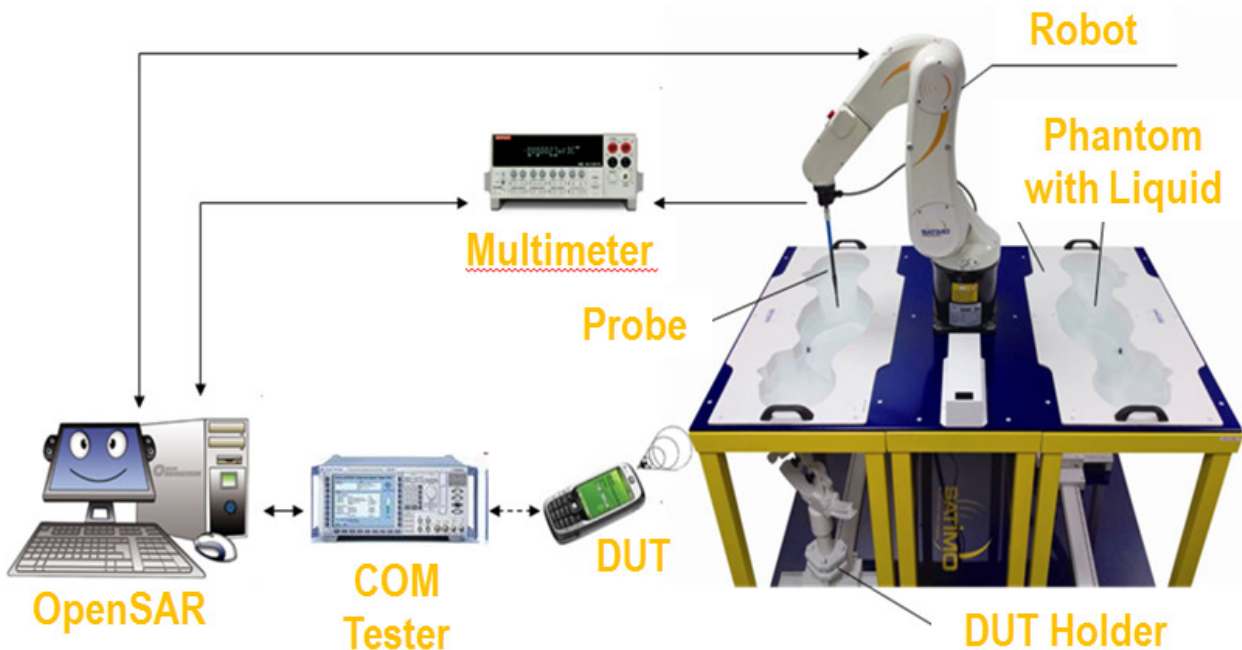

Scanning System (robot)

- ▶ It must be able to scan all the volume of the phantom to evaluate the tridimensional distribution of SAR.
- ▶ Must be able to set the probe orthogonal of the surface of the phantom ($\pm 30^\circ$).
- ▶ Detects stresses on the probe and stop itself if necessary to keep the integrity of the probe.



SAM Phantom (Specific Anthropomorphic Mannequin)

- 2 The probe scanning of the E-Field is done in the 2 half of the normalized head.
- 2 The normalized shape of the phantom corresponds to the dimensions of 90% of an adult head size.
- 2 The materials for the phantom should not affect the radiation of the device under test (DUT)
 - Permittivity < 5
- 2 The head is filled with tissue simulating liquid.
- 2 The hand holding the DUT does not have to be modeled.

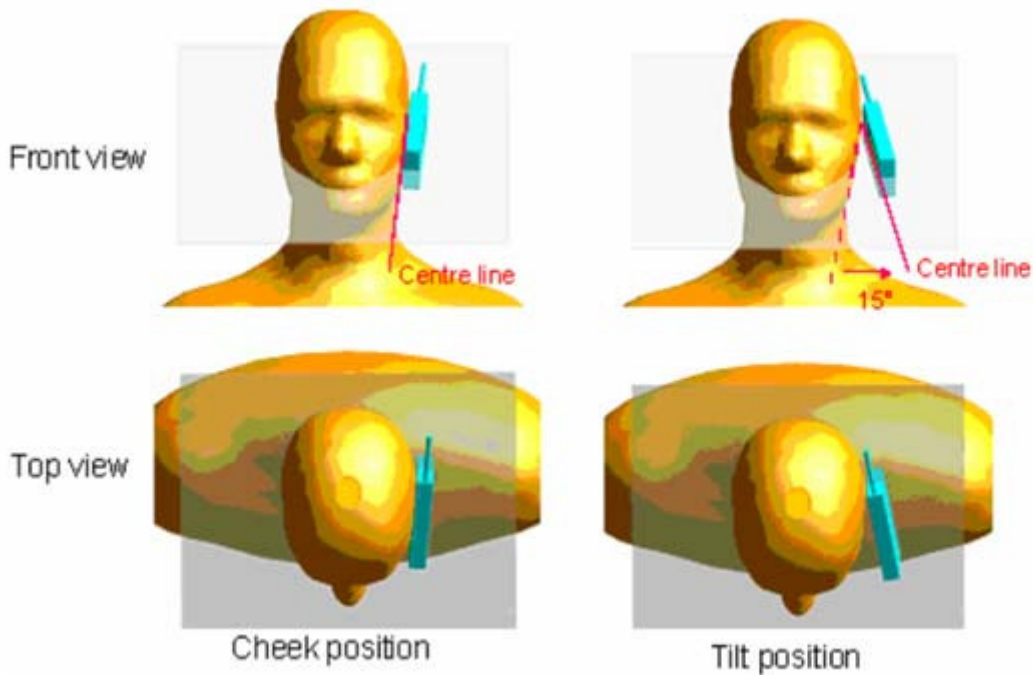
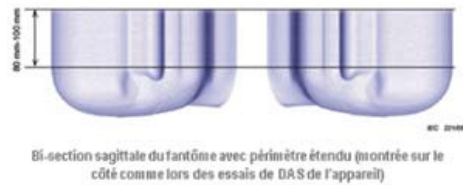
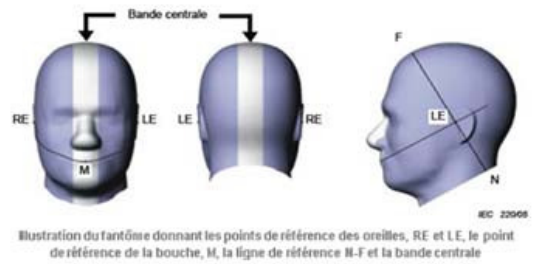

The OPENSAR system for performing compliance tests consist of the following items:

1. A standard high precision 6-axis robot (KUKA) with controller and software.
2. KUKA Control Panel (KCP).
3. A dosimetric probe, i.e., an isotropic E-field probe optimized and calibrated for usage in tissue simulating liquid. The probe is equipped with an optical surface detector system.
4. The functions of the PC plug-in card are to perform the time critical task such as signal filtering, surveillance of the robot operation fast movement interrupts.
5. A computer operating Windows 7.
6. OPENSAR software.
7. Remote control with teaches pendant and additional circuitry for robot safety such as warning lamps, etc.
8. The SAM phantom enabling testing left-hand right-hand and body usage.
9. The Position device for handheld EUT.
10. Tissue simulating liquid mixed according to the given recipes (see Application Note).
11. System validation dipoles to validate the proper functioning of the system.

Data Evaluation

The OPENSAR software automatically executes the following procedure to calculate the field units from the microvolt readings at the probe connector. The parameters used in the valuation are stored in the configuration modules of the software:

Probe Parameters	- Sensitivity	Norm _i
	- Conversion factor	ConvFi
	- Diode compression point Dcpi	
Device Parameter	- Frequency	f
	- Crest factor	cf
Media Parametrs	- Conductivity	σ
	- Density	ρ

These parameters must be set correctly in the software. They can either be found in the component documents or be imported into the software from the configuration files issued for the OPENSAR components.

The first step of the evaluation is a linearization of the filtered input signal to account for the compression characteristics of the detector diode. The compensation depends on the input signal, the diode type and the DC-transmission factor from the diode to the evaluation electronics. If the exciting field is pulsed, the crest factor of the signal must be known to correctly compensate for peak power. The formula for each channel can be given as

$$V_i = U_i + U_i^2 \cdot \frac{cf}{dcp_i}$$

Where V_i = Compensated signal of channel i ($i = x, y, z$)

U_i = Input signal of channel i ($i = x, y, z$)

cf = Crest factor of exciting field (DASY parameter)

dcp_i = Diode compression point (DASY parameter)

From the compensated input signals the primary field data for each channel can be evaluated:

$$\text{E-field probes: } E_i = \sqrt{\frac{V_i}{\text{Norm}_i \cdot \text{ConvF}}}$$

$$\text{H-field probes: } H_i = \sqrt{V_i} \cdot \frac{a_{i0} + a_{i1}f + a_{i2}f^2}{f}$$

Where V_i = Compensated signal of channel i ($i = x, y, z$)

Norm_i = Sensor sensitivity of channel i ($i = x, y, z$)
 $\mu\text{V}/(\text{V/m})^2$ for E0field Probes

ConvF = Sensitivity enhancement in solution

a_{ij} = Sensor sensitivity factors for H-field probes

f = Carrier frequency (GHz)

E_i = Electric field strength of channel i in V/m

H_i = Magnetic field strength of channel i in A/m

The RSS value of the field components gives the total field strength (Hermitian magnitude):

$$E_{\text{tot}} = \sqrt{E_x^2 + E_y^2 + E_z^2}$$

The primary field data are used to calculate the derived field units.

$$\text{SAR} = E_{\text{tot}}^2 \cdot \frac{\sigma}{\rho \cdot 1000}$$

where SAR = local specific absorption rate in mW/g

E_{tot} = total field strength in V/m

σ = conductivity in [mho/m] or [siemens/m]

ρ = equivalent tissue density in g/cm³

Note that the density is normally set to 1 (or 1.06), to account for actual brain density rather than the density of the simulation liquid.

The power flow density is calculated assuming the excitation field as a free space field.

$$P_{\text{pwe}} = \frac{E_{\text{tot}}^2}{3770} \quad \text{or} \quad P_{\text{pwe}} = H_{\text{tot}}^2 \cdot 37.7$$

where P_{pwe} = Equivalent power density of a plane wave in mW/cm²

E_{tot} = total electric field strength in V/m

H_{tot} = total magnetic field strength in A/m

SAR Evaluation – Peak Spatial - Average

The procedure for assessing the peak spatial-average SAR value consists of the following steps

- **Power Reference Measurement**

The reference and drift jobs are useful jobs for monitoring the power drift of the device under test in the batch process. Both jobs measure the field at a specified reference position, at a selectable distance from the phantom surface. The reference position can be either the selected section's grid reference point or a user point in this section. The reference job projects the selected point onto the phantom surface, orients the probe perpendicularly to the surface, and approaches the surface using the selected detection method.

- **Area Scan**

The area scan is used as a fast scan in two dimensions to find the area of high field values, before doing a finer measurement around the hot spot. The sophisticated interpolation routines implemented in OPENSAR software can find the maximum locations even in relatively coarse grids. The scan area is defined by an editable grid. This grid is anchored at the grid reference point of the selected section in the phantom. When the area scan's property sheet is brought-up, grid was at to 15 mm by 15 mm and can be edited by a user.

- **Zoom Scan**

Zoom scans are used to assess the peak spatial SAR values within a cubic averaging volume containing 1 g and 10 g of simulated tissue. The default zoom scan measures 5 x 5 x 7 points within a cube whose base faces are centered around the maximum found in a preceding area scan job within the same procedure. If the preceding Area Scan job indicates more than one maximum, the number of Zoom Scans has to be enlarged accordingly (The default number inserted is 1).

- **Power Drift measurement**

The drift job measures the field at the same location as the most recent reference job within the same procedure, and with the same settings. The drift measurement gives the field difference in dB from the reading conducted within the last reference measurement. Several drift measurements are possible for one reference measurement. This allows a user to monitor the power drift of the device under test within a batch process. In the properties of the Drift job, the user can specify a limit for the drift and have OPENSAR software stop the measurements if this limit is exceeded.

SAR Evaluation – Peak SAR

The procedure for spatial peak SAR evaluation has been implemented according to the IEEE1529 standard. It can be conducted for 1 g and 10 g. The OPENSAR system allows evaluations that combine measured data and robot positions, such as:

- maximum search
- extrapolation
- boundary correction
- peak search for averaged SAR

During a maximum search, global and local maximum searches are automatically performed in 2-D after each Area Scan measurement with at least 6 measurement points. It is based on the evaluation of the local SAR gradient calculated by the Quadratic Shepard's method. The algorithm will find the global maximum and all local maxima within -2 dB of the global maxima for all SAR distributions.

Extrapolation

Extrapolation routines are used to obtain SAR values between the lowest measurement points and the inner phantom surface. The extrapolation distance is determined by the surface detection distance and the probe sensor offset. Several measurements at different distances are necessary for the extrapolation.

They are used in the Cube Scan to obtain SAR values between the lowest measurement points and the inner phantom surface. The routine uses the fourth order least square polynomial method for extrapolation. For a grid using 5x5x7 measurement points with 5mm resolution amounting to 343 measurement points, the uncertainty of the extrapolation routines is less than 1% for 1 g and 10 g cubes.

Definition of Reference Points

Ear Reference Point

Figure 6.2 shows the front, back and side views of the SAM Phantom. The point “M” is the reference point for the center of the mouth, “LE” is the left ear reference point (ERP), and “RE” is the right ERP. The ERPs are 15mm posterior to the entrance to the ear canal (EEC) along the B-M line (Back-Mouth), as shown in Figure 6.1. The plane passing through the two ear canals and M is defined as the Reference Plane. The line N-F (Neck-Front) is perpendicular to the reference plane and passing through the RE (or LE) is called the Reference Pivoting Line (see Figure 6.1). Line B-M is perpendicular to the N-F line. Both N-F and B-M lines are marked on the external phantom shell to facilitate handset positioning [5].

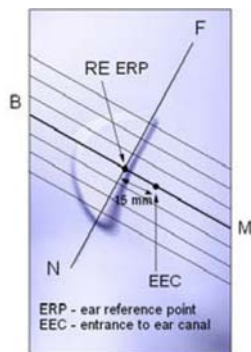

Figure 6.1 Close-up side view of ERP's



Figure 6.2 Front, back and side view of SAM

Device Reference Points

Two imaginary lines on the device need to be established: the vertical centerline and the horizontal line. The test device is placed in a normal operating position with the “test device reference point” located along the “vertical centerline” on the front of the device aligned to the “ear reference point” (See Fig. 6.3). The “test device reference point” is then located at the same level as the center of the ear reference point. The test device is positioned so that the “vertical centerline” is bisecting the front surface of the device at its top and bottom edges, positioning the “ear reference point” on the outer surface of both the left and right head phantoms on the ear reference point [5].

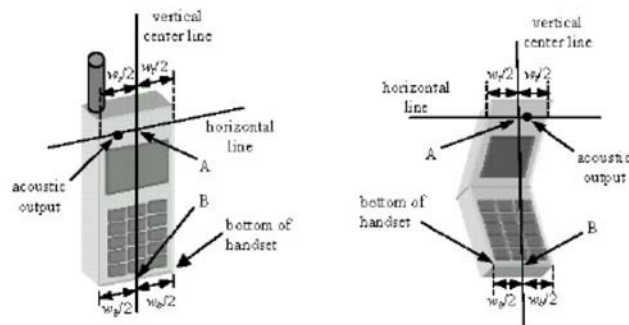

Figure 6.3 Handset Vertical Center & Horizontal Line Reference Points

Test Configuration – Positioning for Cheek / Touch

1. Position the device close to the surface of the phantom such that point A is on the (virtual) extension of the line passing through points RE and LE on the phantom (see Figure below), such that the plane defined by the vertical center line and the horizontal line of the device is approximately parallel to the sagittal plane of the phantom

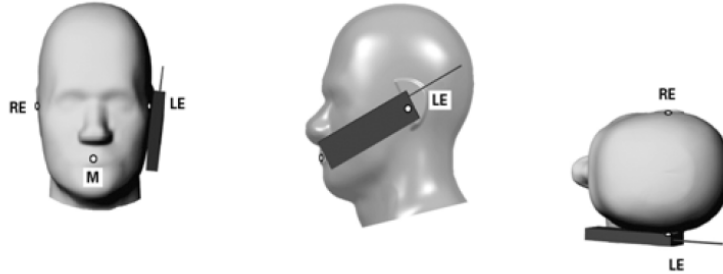

Figure 7.1 Front, Side and Top View of Cheek/Touch Position

2. Translate the device towards the phantom along the line passing through RE and LE until the device touches the ear.
3. While maintaining the device in this plane, rotate it around the LE-RE line until the vertical centerline is in the plane normal to MB-NF including the line MB (called the reference plane).
4. Rotate the device around the vertical centerline until the device (horizontal line) is symmetrical with respect to the line NF.
5. While maintaining the vertical centerline in the reference plane, keeping point A on the line passing through RE and LE and maintaining the device contact with the ear, rotate the device about the line NF until any point on the device is in contact with a phantom point below the ear (cheek). See Figure below.

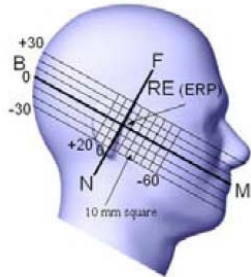

Figure 7.2 Side view w/ relevant markings

Test Configuration – Positioning for Ear / 15° Tilt

With the test device aligned in the Cheek/Touch Position”:

1. While maintaining the orientation of the device, retract the device parallel to the reference plane far enough to enable a rotation of the device by 15 degrees.
2. Rotate the device around the horizontal line by 15 degrees.
3. While maintaining the orientation of the device, move the device parallel to the reference plane until any part of the device touches the head. (In this position, point A is located on the line RE-LE). The tilted position is obtained when the contact is on the pinna. If the contact is at any location other than the pinna, the angle of the device shall be reduced. The tilted position is obtained when any part of the device is in contact with the ear as well as a second part of the device is in contact with the head (see Figure below).

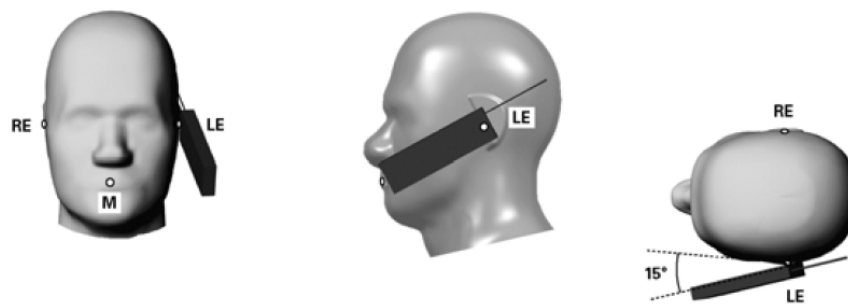
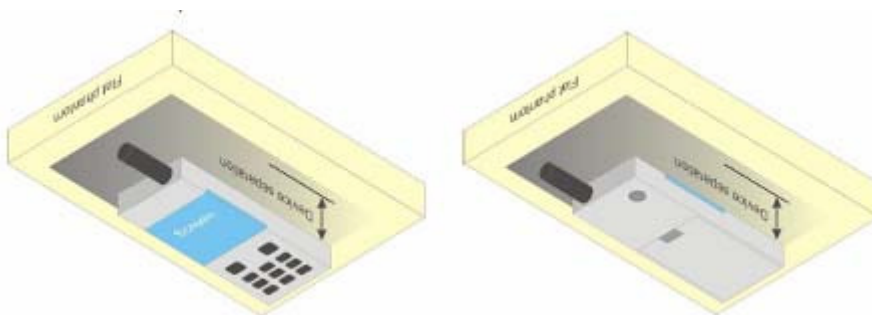

Figure 7.3 Front, Side and Top View of Ear/15° Tilt Position

Test Position – Body Configurations

Body Worn Position

- (a) To position the device parallel to the phantom surface with either keypad up or down.
- (b) To adjust the device parallel to the flat phantom.
- (c) To adjust the distance between the device surface and the flat phantom to 1.5 cm or holster surface and the flat phantom to 0 cm.



7 EXPOSURE LIMIT

In order for users to be aware of the body-worn operating requirements for meeting RF exposure compliance, operating instructions and cautions statements are included in the user's manual.

Uncontrolled Environment

Uncontrolled Environments are defined as locations where there is the exposure of individuals who have no knowledge or control of their exposure. The general population/uncontrolled exposure limits are applicable to situations in which the general public may be exposed or in which persons who are exposed as a consequence of their employment may not be made fully aware of the potential for exposure or cannot exercise control over their exposure. Members of the general public would come under this category when exposure is not employment-related; for example, in the case of a wireless transmitter that exposes persons in its vicinity.

Controlled Environment

Controlled Environments are defined as locations where there is exposure that may be incurred by persons who are aware of the potential for exposure, (i.e. as a result of employment or occupation). In general, occupational/controlled exposure limits are applicable to situations in which persons are exposed as a consequence of their employment, who have been made fully aware of the potential for exposure and can exercise control over their exposure. This exposure category is also applicable when the exposure is of a transient nature due to incidental passage through a location where the exposure levels may be higher than the general population/uncontrolled limits, but the exposed person is fully aware of the potential for exposure and can exercise control over his or her exposure by leaving the area or by some other appropriate means.

Table 8.1 Human Exposure Limits

	UNCONTROLLED ENVIRONMENT General Population (W/kg) or (mW/g)	CONTROLLED ENVIROMENT Professional Population (W/kg) or (mW/g)
SPATIAL PEAK SAR ¹ Brain	1.60	8.00
SPATIAL AVERAGE SAR ² Whole Body	0.08	0.40
SPATIAL PEAK SAR ³ Hands, Feet, Ankles, Wrists	4.00	20.00

¹ The Spatial Peak value of the SAR averaged over any 1 gram of tissue (defined as a tissue volume in the shape of a cube) and over the appropriate averaging time.

² The Spatial Average value of the SAR averaged over the whole body.

³ The Spatial Peak value of the SAR averaged over any 10 grams of tissue (defined as a tissue volume in the shape of a cube) and over the appropriate averaging time.

8 SYSTEM AND LIQUID VALIDATION

System Validation

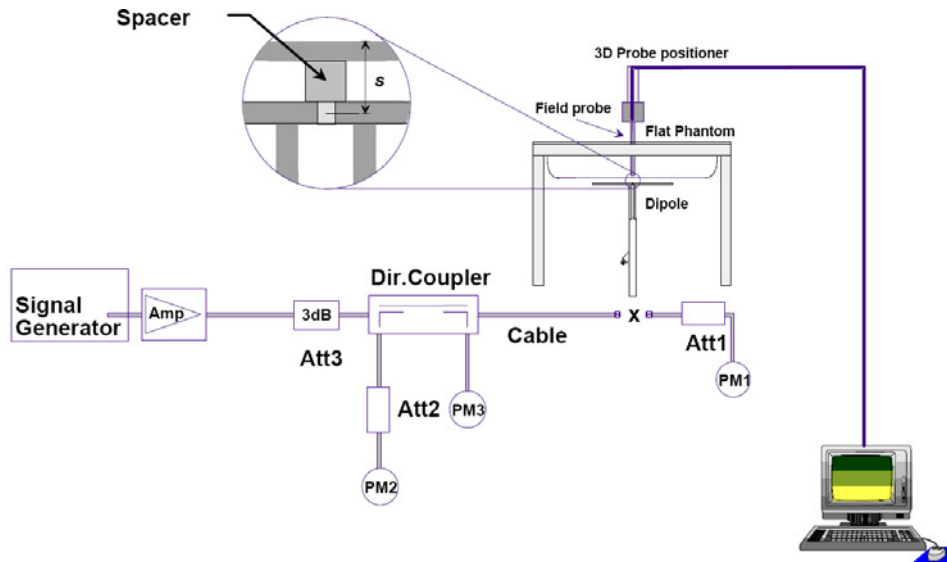

Fig 8.1 System Setup for System Evaluation

The system performance check verifies that the system operates within its specifications. System and operator errors can be detected and corrected. It is recommended that the system performance check be performed prior to any usage of the system in order to guarantee reproducible results. The system performance check uses normal SAR measurements in a simplified setup with a well characterized source. This setup was selected to give a high sensitivity to all parameters that might fail or vary over time. The system check does not intend to replace the calibration of the components, but indicates situations where the system uncertainty is exceeded due to drift or failure.

In the simplified setup for system evaluation, the DUT is replaced by a calibrated dipole and the power source is replaced by a continuous wave that comes from a signal generator. The calibrated dipole must be placed beneath the flat phantom section of the SAM twin phantom with the correct distance holder. The distance holder should touch the phantom surface with a light pressure at the reference marking and be oriented parallel to the long side of the phantom. The equipment setup is shown below:

1. Signal Generator
2. Amplifier
3. Directional Coupler
4. Power Meter
5. Calibrated Dipole

The output power on dipole port must be calibrated to 30 dBm (1000 mW) before dipole is connected.

Numerical reference SAR values (W/kg) for reference dipole and flat phantom

Frequency (MHz)	1 g SAR	10 g SAR	Local SAR at surface (above feed-point)	Local SAR at surface (y = 2 cm offset from feed-point) ^a
300	3.0	2.0	4.4	2.1
450	4.9	3.3	7.2	3.2
835	9.5	6.2	4.1	4.9
900	10.8	6.9	16.4	5.4
1450	29.0	16.0	50.2	6.5
1800	38.1	19.8	69.5	6.8
1900	39.7	20.5	72.1	6.6
2000	41.1	21.1	74.6	6.5
2450	52.4	24.0	104.2	7.7
3000	63.8	25.7	140.2	9.5

Table 1: system validation (1g)

Measurement Date	Frequency (MHz)	Liquid Type (head/body)	Target SAR1g (W/kg)	Measured SAR1g (W/kg)	Normalized SAR1g (W/kg)	Deviation (%)
Mar 30,2016	835	head	9.53	0.0960	9.60	0.7
Mar 30,2016	835	body	9.44	0.0915	9.15	-3.1
Apr 7,2016	1800	head	37.56	0.3743	37.43	-0.3
Apr 7,2016	1800	body	37.91	0.3960	39.60	4.5
Apr 13,2016	1900	head	39.37	0.3895	38.95	-2.2
Apr 13,2016	1900	body	38.58	0.3652	36.52	-5.3
Apr 14,2016	2450	head	53.38	0.5315	53.15	-0.4
Apr 14,2016	2450	body	50.67	0.5153	51.53	1.7

Note: system check input power: 10mW

Liquid Validation

The dielectric parameters were checked prior to assessment using the HP85070C dielectric probe kit. The dielectric parameters measured are reported in each correspondent section.

KDB 865664 recommended Tissue Dielectric Parameters

The head and body tissue parameters given in this below table should be used to measure the SAR of transmitters operating in 100 MHz to 6 GHz frequency range. The tissue dielectric parameters of the tissue medium at the test frequency should be within the tolerance required in this document. The dielectric parameters should be linearly interpolated between the closest pair of target frequencies to determine the applicable dielectric parameters corresponding to the device test frequency.

The head tissue dielectric parameters recommended by IEEE Std 1528-2013 have been incorporated in the following table. These head parameters are derived from planar layer models simulating the highest expected SAR for the dielectric properties and tissue thickness variations in a human head. Other head and body tissue parameters that have not been specified in 1528 are derived from tissue dielectric parameters computed from the 4-Cole-Cole equations described above and extrapolated according to the head parameters specified in 1528.

Target Frequency	Head Tissue		Body Tissue	
	MHz	ϵ_r	σ' (S/m)	ϵ_r
150	52.3	0.76	61.9	0.80
300	45.3	0.87	58.2	0.92
450	43.5	0.87	56.7	0.94
835	41.5	0.90	55.2	0.97
900	41.5	0.97	55.0	1.05
915	41.5	0.98	55.0	1.06
1450	40.5	1.20	54.0	1.30
1610	40.3	1.29	53.8	1.40
1800-2000	40.0	1.40	53.3	1.52
2450	39.2	1.80	52.7	1.95
3000	38.5	2.40	52.0	2.73
5800	35.3	5.27	48.2	6.00

Tissue Dielectric Parameters for Head and Body Phantoms

The head tissue dielectric parameters recommended by the IEEE SCC-34/SC-2 in P1528 have been incorporated in the following table. These head parameters are derived from planar layer models simulating the highest expected SAR for the dielectric properties and tissue thickness Power drifts in a human head. Other head and body tissue parameters that have not been specified in P1528 are derived from the tissue dielectric parameters computed from the 4-Cole-Cole equations described in Reference [12] and extrapolated according to the head parameters specified in P1528.

Table 2: Recommended Dielectric Performance of Tissue
Recommended Dielectric Performance of Tissue

Ingredients (% by weight)	Frequency (MHz)							
	835		1800		1900		2450	
	Head	Body	Head	Body	Head	Body	Head	Body
Water	41.46	52.4	55.2	70.2	54.9	40.4	62.7	73.2
Salt (NaCl)	1.45	1.4	0.3	0.4	0.18	0.5	0.5	0.04
Sugar	56.0	45.0	0.0	0.0	0.0	58.0	0.0	0.0
HEC	1.0	1.0	0.0	0.0	0.0	1.0	0.0	0.0
Bactericide	0.1	0.1	0.0	0.0	0.0	0.1	0.0	0.0
Triton x-100	0.0	0.0	0.0	0.0	0.0	0.0	36.8	0.0
DGBE	0.0	0.0	44.5	29.4	44.92	0.0	0.0	26.4
Dielectric Constant	42.54	56.1	40.0	53.3	39.9	54.0	39.8	52.5
Conductivity (s/m)	0.91	0.95	1.40	1.52	1.42	1.45	1.88	1.78

Table 3: Dielectric Performance of Head Tissue Simulating Liquid

Temperature: 21°C , Relative humidity: 57%				
Frequency(MHz)	Measured Date	Description	Dielectric Parameters	
			ϵ_r	σ (s/m)
835	Mar 30,2016	Target Value $\pm 5\%$ window	41.50 39.43 — 43.58	0.90 0.855 — 0.945
		Measurement Value	41.33	0.91
1700	Apr 7,2016	Target Value $\pm 5\%$ window	40.00 38.00 — 42.00	1.40 1.33 — 1.47
		Measurement Value	40.51	1.39
1800	Apr 7,2016	Target Value $\pm 5\%$ window	40.00 38.00 — 42.00	1.40 1.33 — 1.47
		Measurement Value	40.59	1.39
1900	Apr 13,2016	Target Value $\pm 5\%$ window	40.00 38.00 — 42.00	1.40 1.33 — 1.47
		Measurement Value	41.04	1.41
2450	Apr 14,2016	Target Value $\pm 5\%$ window	39.2 37.24 — 41.16	1.80 1.71 — 1.89
		Measurement Value	39.77	1.79
2500	Apr 14,2016	Target Value $\pm 5\%$ window	39.2 37.24 — 41.16	1.80 1.71 — 1.89
		Measurement Value	39.54	1.79

Table 4: Dielectric Performance of Body Tissue Simulating Liquid

Temperature: 21°C , Relative humidity: 57% , Measured Date: Apr 7,2016				
Frequency(MHz)	Measured Date	Description	Dielectric Parameters	
			ϵ_r	σ (s/m)
835	Mar 30,2016	Target Value $\pm 5\%$ window	55.2 52.25 — 57.75	0.97 0.922 — 1.018
		Measurement Value	55.44	0.98
1700	Apr 7,2016	Target Value $\pm 5\%$ window	53.30 50.64 — 55.97	1.52 1.44 — 1.60
		Measurement Value	53.85	1.50
1800	Apr 7,2016	Target Value $\pm 5\%$ window	53.30 50.64 — 55.97	1.52 1.44 — 1.60
		Measurement Value	53.71	1.50
1900	Apr 13,2016	Target Value $\pm 5\%$ window	53.30 50.64 — 55.97	1.52 1.44 — 1.60
		Measurement Value	53.51	1.50
2450	Apr 14,2016	Target Value $\pm 5\%$ window	52.70 50.07 — 55.34	1.95 1.86 — 2.05
		Measurement Value	52.95	1.94
2500	Apr 14,2016	Target Value $\pm 5\%$ window	52.70 50.07 — 55.34	1.95 1.86 — 2.05
		Measurement Value	52.73	1.94

System Verification Plots

Product Description: Dipole

Model: SID835

Test Date: Mar 30,2016

Medium(liquid type)	HSL_835
Frequency (MHz)	835.000000
Relative permittivity (real part)	41.33
Conductivity (S/m)	0.91
Input power	10mW
E-Field Probe	SN 07/15 EP249
Duty cycle	1:1
Conversion Factor	5.26
Sensor-surface	4mm
Area Scan	dx=8mm dy=8mm
Zoom Scan	5x5x7,dx=8mm dy=8mm dz=5mm
Variation (%)	-0.32
SAR 10g (W/Kg)	0.062053
SAR 1g (W/Kg)	0.096027
SURFACE SAR	VOLUME SAR

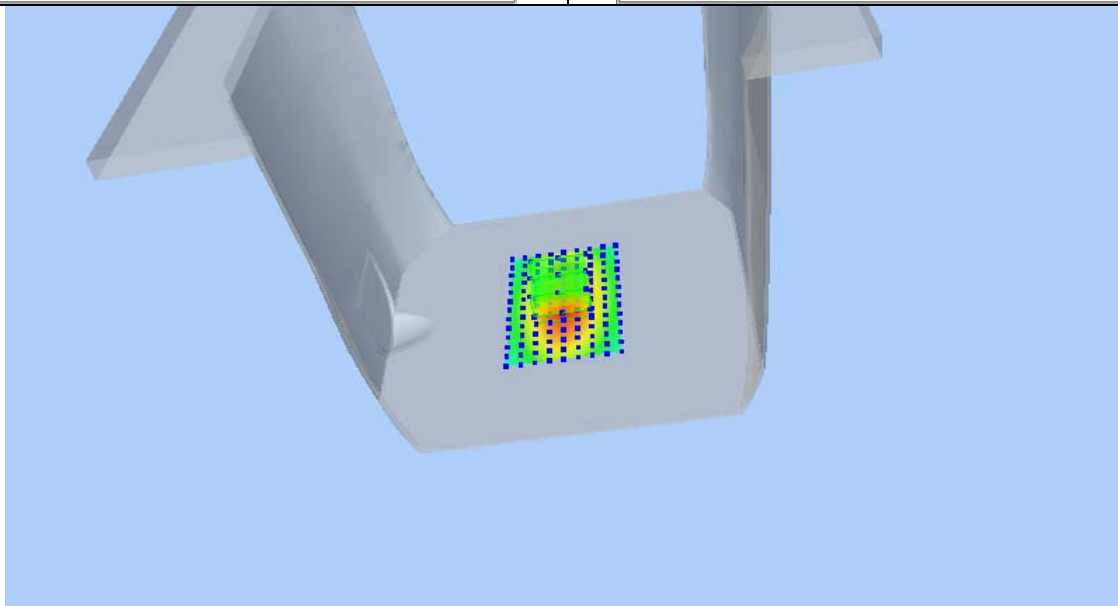
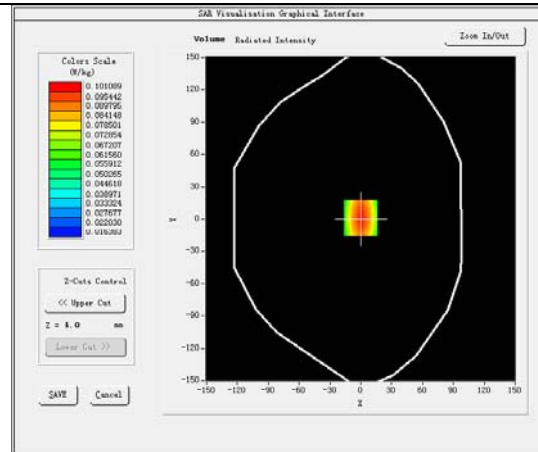
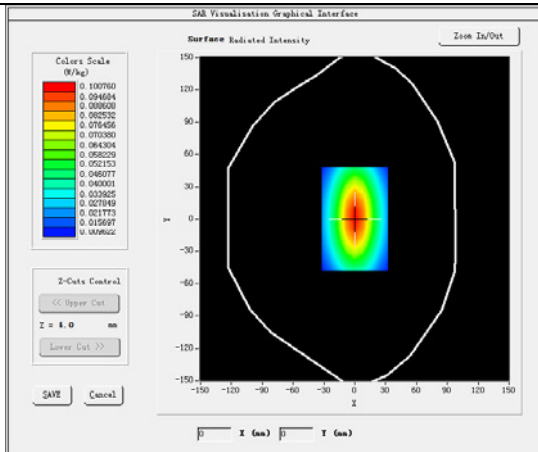

Product Description: Dipole**Model: SID835****Test Date: Mar 30,2016**

Medium(liquid type)	MSL_835
Frequency (MHz)	835.000000
Relative permittivity (real part)	55.44
Conductivity (S/m)	0.98
Input power	10mW
E-Field Probe	SN 07/15 EP249
Duty cycle	1:1
Conversion Factor	5.46
Sensor-surface	4mm
Area Scan	dx=8mm dy=8mm
Zoom Scan	5x5x7,dx=8mm dy=8mm dz=5mm
Variation (%)	-0.48
SAR 10g (W/Kg)	0.059353
SAR 1g (W/Kg)	0.091587
SURFACE SAR	VOLUME SAR

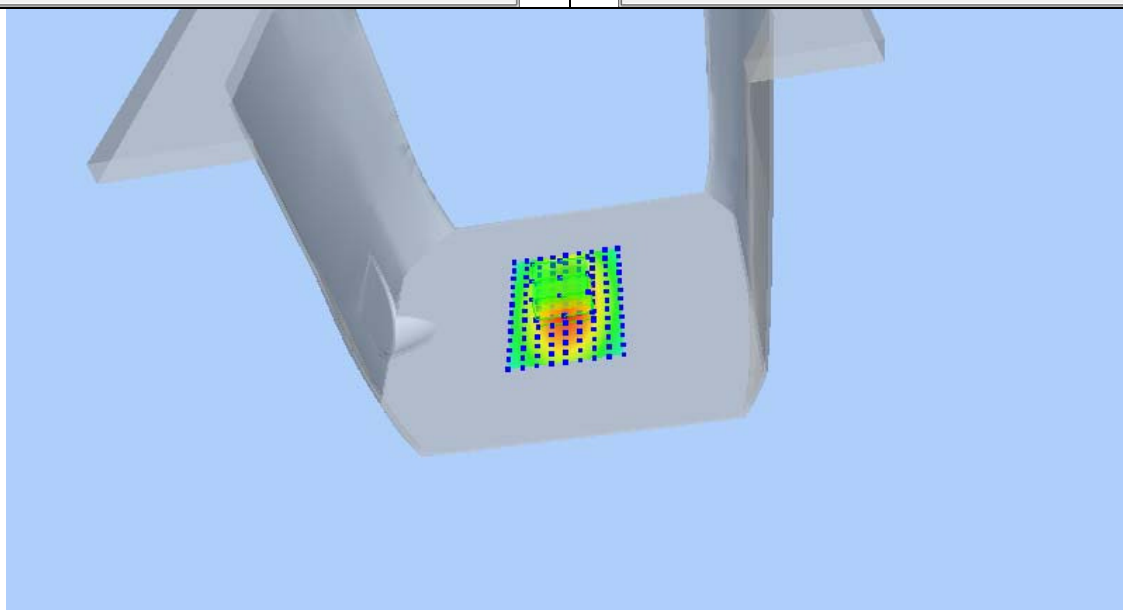
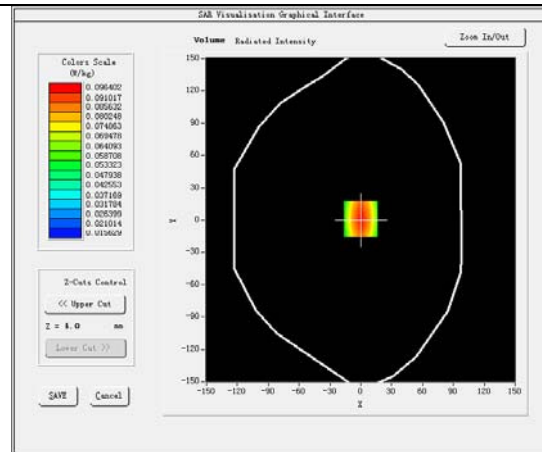
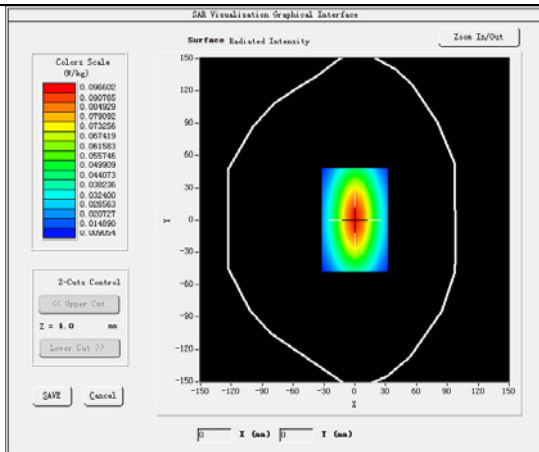

Product Description: Dipole**Model: SID1800****Test Date: Apr 7,2016**

Medium(liquid type)	HSL_1800
Frequency (MHz)	1800.000
Relative permittivity (real part)	40.59
Conductivity (S/m)	1.39
Input power	10mW
E-Field Probe	SN 07/15 EP249
Duty cycle	1:1
Conversion Factor	4.23
Sensor-Surface	4mm
Area Scan	dx=8mm dy=8mm
Zoom Scan	5x5x7,dx=8mm dy=8mm dz=5mm
Variation (%)	-0.60
SAR 10g (W/Kg)	0.198695
SAR 1g (W/Kg)	0.374253
SURFACE SAR	VOLUME SAR

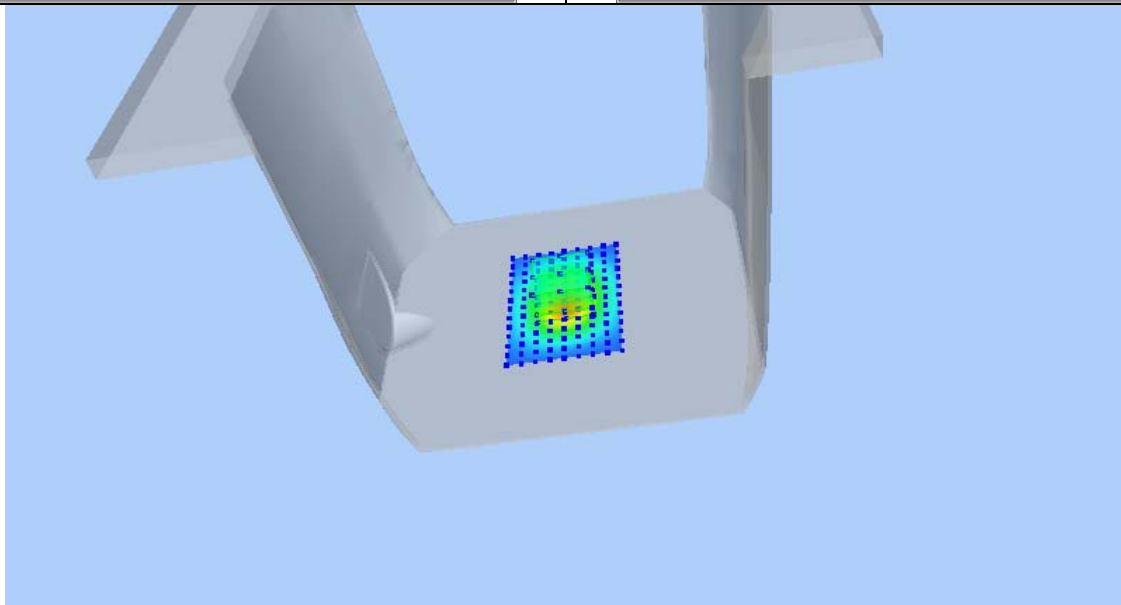
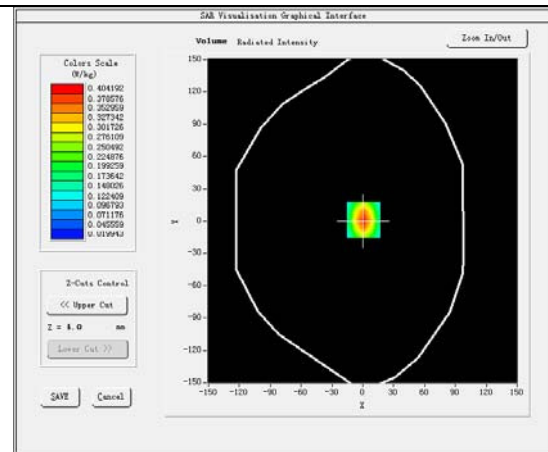
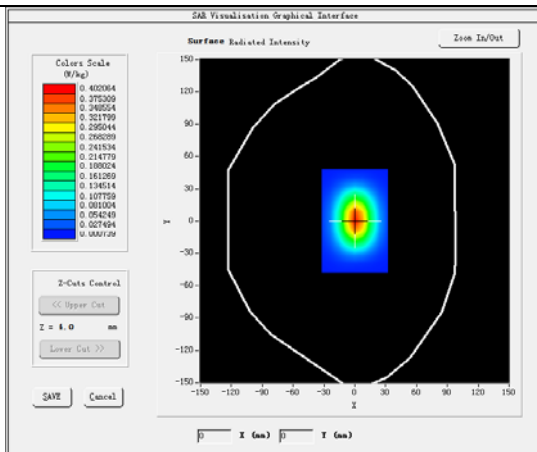

Product Description: Dipole**Model: SID1800****Test Date: Apr 7,2016**

Medium(liquid type)	MSL_1800
Frequency (MHz)	1800.000
Relative permittivity (real part)	53.71
Conductivity (S/m)	1.50
Input power	10mW
E-Field Probe	SN 07/15 EP249
Duty cycle	1:1
Conversion Factor	4.37
Sensor-Surface	4mm
Area Scan	dx=8mm dy=8mm
Zoom Scan	5x5x7,dx=8mm dy=8mm dz=5mm
Variation (%)	0.18
SAR 10g (W/Kg)	0.209895
SAR 1g (W/Kg)	0.396029

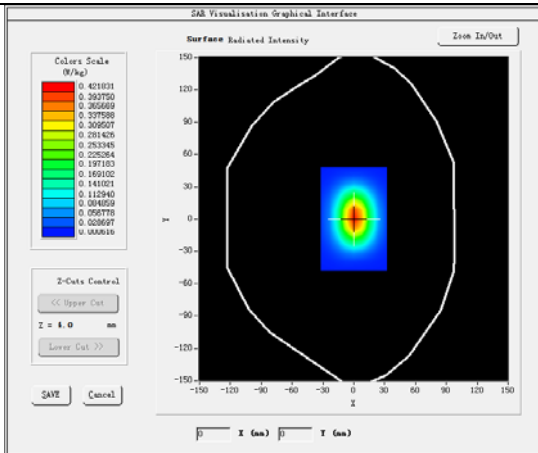
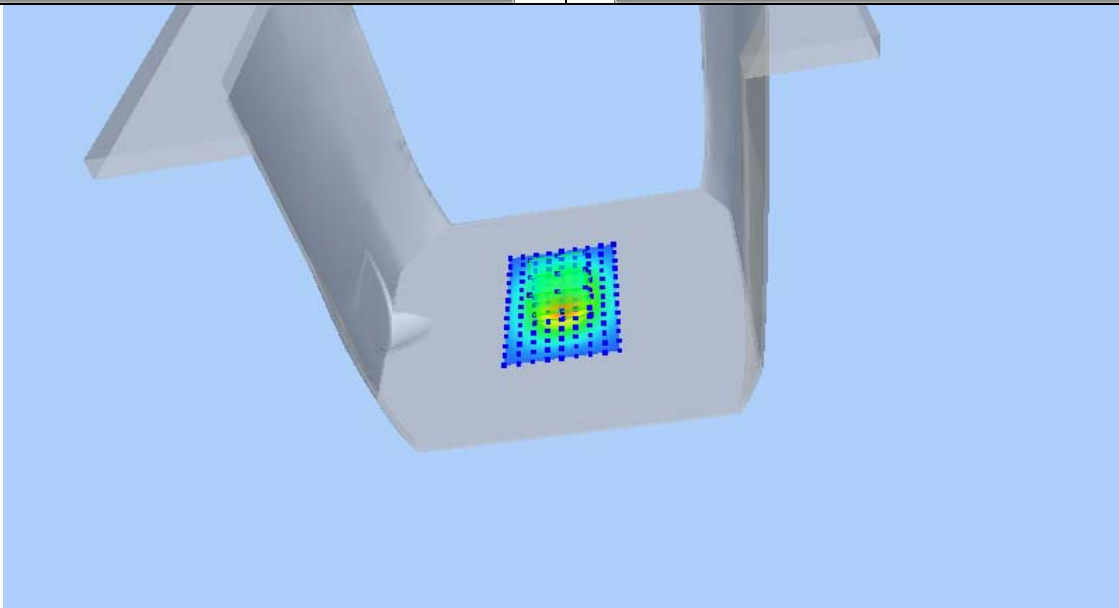
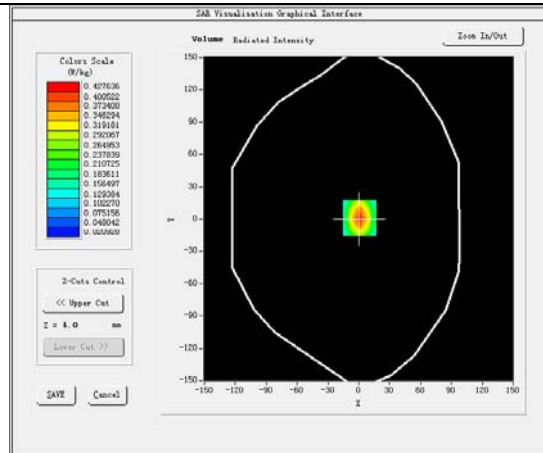
SURFACE SAR**VOLUME SAR**

Product Description: Dipole**Model: SID1900****Test Date: Apr 13,2016**

Medium(liquid type)	HSL_1900
Frequency (MHz)	1900.000
Relative permittivity (real part)	41.04
Conductivity (S/m)	1.41
Input power	10mW
E-Field Probe	SN 07/15 EP249
Duty cycle	1:1
Conversion Factor	4.95
Sensor-Surface	4mm
Area Scan	dx=8mm dy=8mm
Zoom Scan	5x5x7,dx=8mm dy=8mm dz=5mm
Variation (%)	-0.14
SAR 10g (W/Kg)	0.202880
SAR 1g (W/Kg)	0.389457
SURFACE SAR	VOLUME SAR

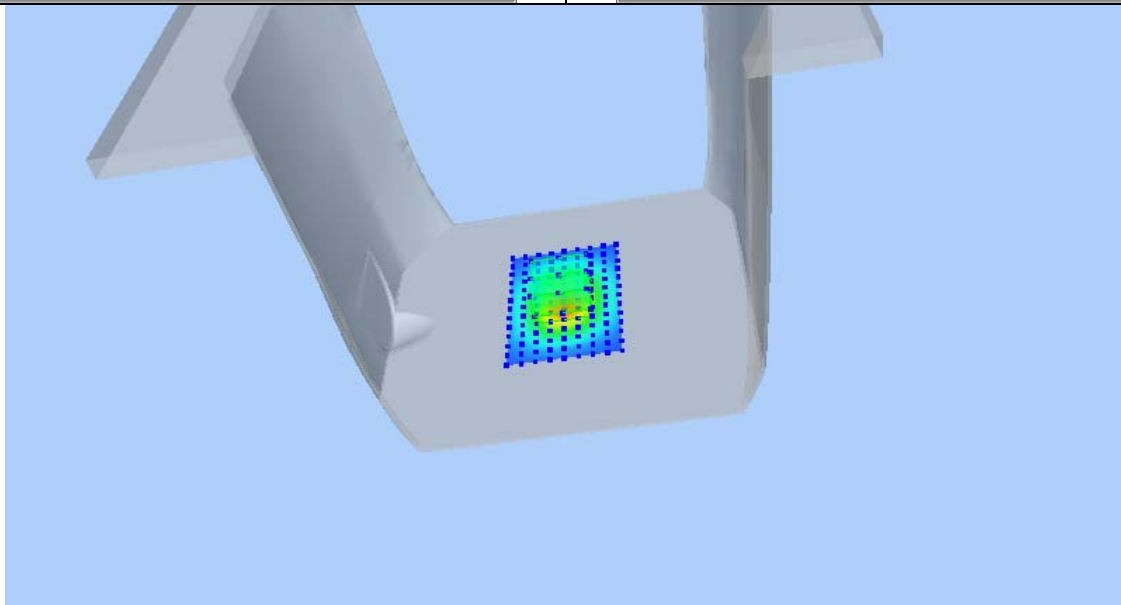
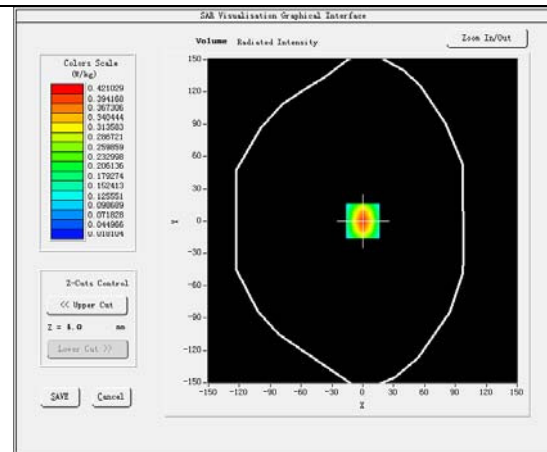
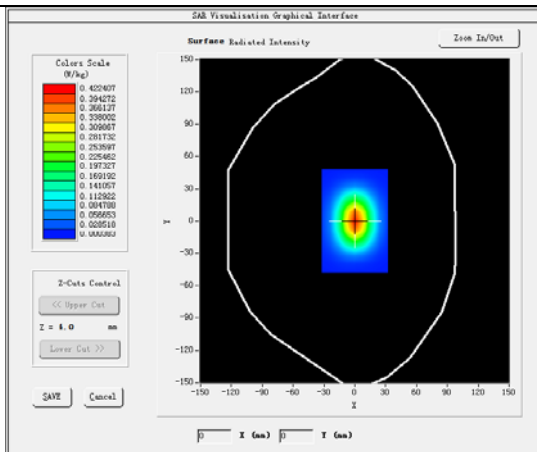

Product Description: Dipole**Model: SID1900****Test Date: Apr 13,2016**

Medium(liquid type)	MSL_1900
Frequency (MHz)	1900.000
Relative permittivity (real part)	53.51
Conductivity (S/m)	1.50
Input power	10mW
E-Field Probe	SN 07/15 EP249
Duty cycle	1:1
Conversion Factor	5.05
Sensor-Surface	4mm
Area Scan	dx=8mm dy=8mm
Zoom Scan	5x5x7,dx=8mm dy=8mm dz=5mm
Variation (%)	-0.49
SAR 10g (W/Kg)	0.190576
SAR 1g (W/Kg)	0.365181
SURFACE SAR	VOLUME SAR

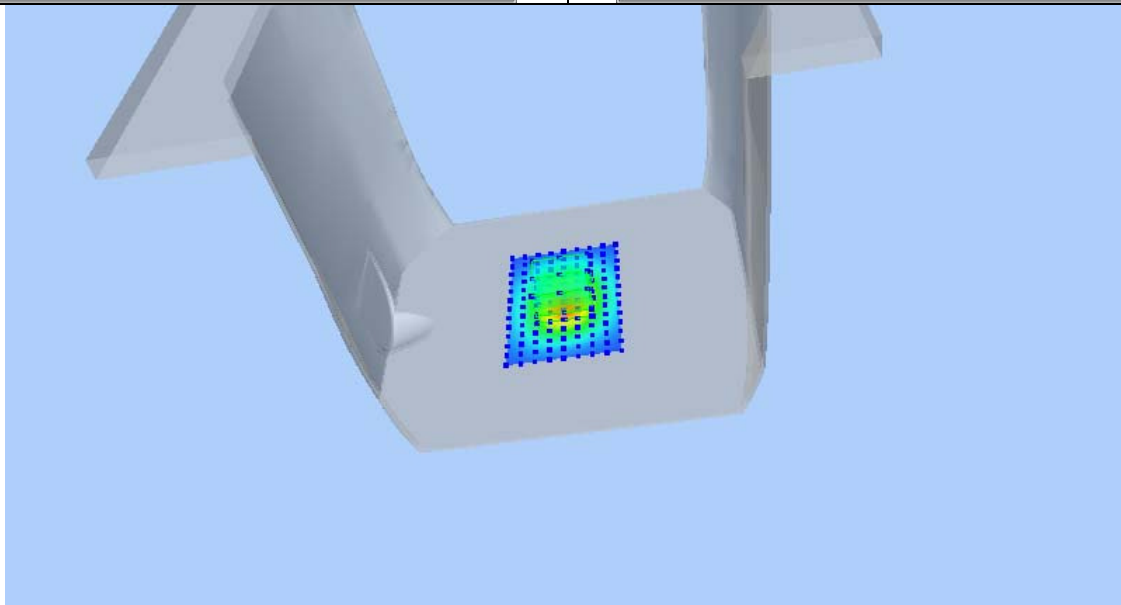
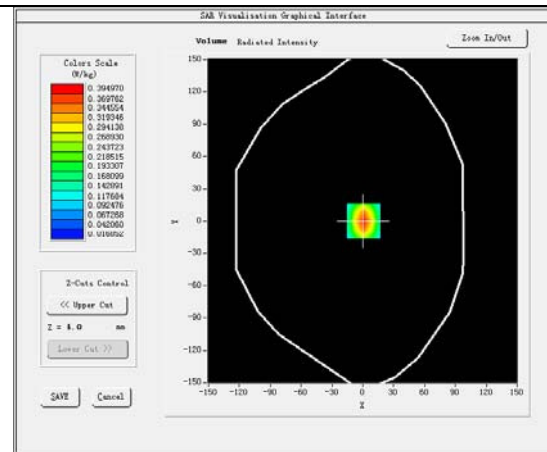
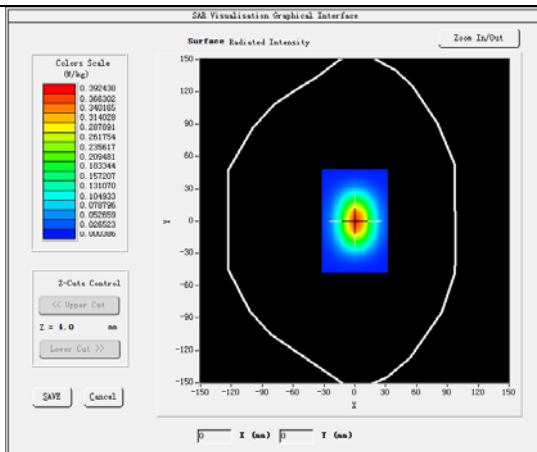

Product Description: Dipole**Model: SID2450****Test Date: Apr 14,2016**

Medium(liquid type)	HSL_2450
Frequency (MHz)	2450.000
Relative permittivity (real part)	39.77
Conductivity (S/m)	1.79
Input power	10mW
E-Field Probe	SN 07/15 EP249
Duty cycle	1:1
Conversion Factor	4.32
Sensor-Surface	4mm
Area Scan	dx=8mm dy=8mm
Zoom Scan	5x5x7,dx=8mm dy=8mm dz=5mm
Variation (%)	0.23
SAR 10g (W/Kg)	0.240540
SAR 1g (W/Kg)	0.531501
SURFACE SAR	VOLUME SAR

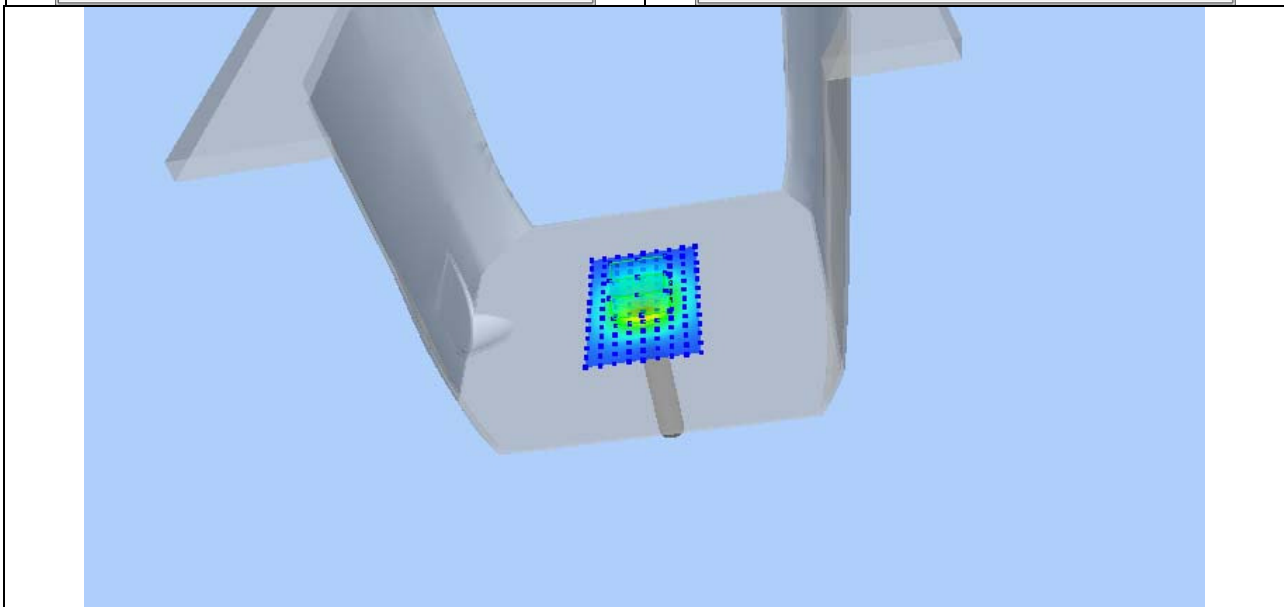
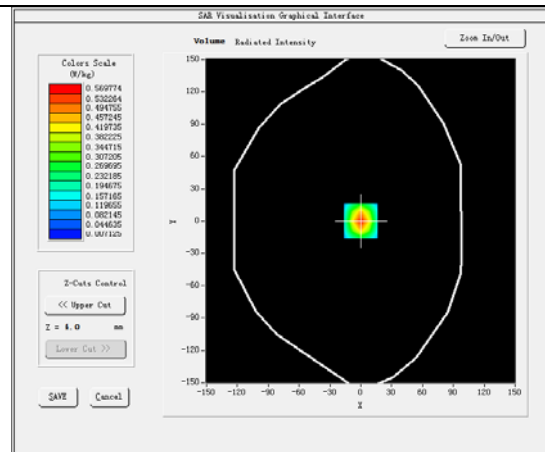
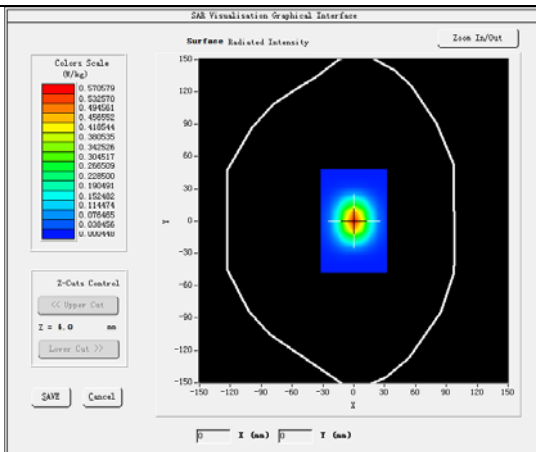

Product Description: Dipole**Model: SID2450****Test Date: Apr 14,2016**

Medium(liquid type)	MSL_2450
Frequency (MHz)	2450.000
Relative permittivity (real part)	52.95
Conductivity (S/m)	1.94
Input power	10mW
E-Field Probe	SN 07/15 EP249
Duty cycle	1:1
Conversion Factor	4.49
Sensor-Surface	4mm
Area Scan	dx=8mm dy=8mm
Zoom Scan	5x5x7,dx=8mm dy=8mm dz=5mm
Variation (%)	0.25
SAR 10g (W/Kg)	0.233289
SAR 1g (W/Kg)	0.515317
SURFACE SAR	VOLUME SAR

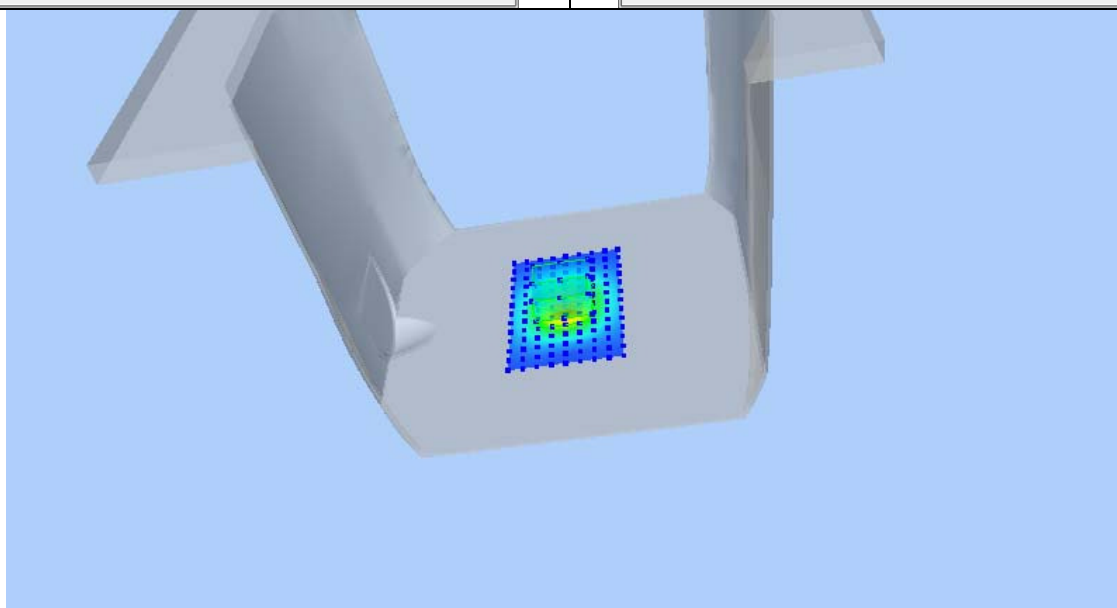
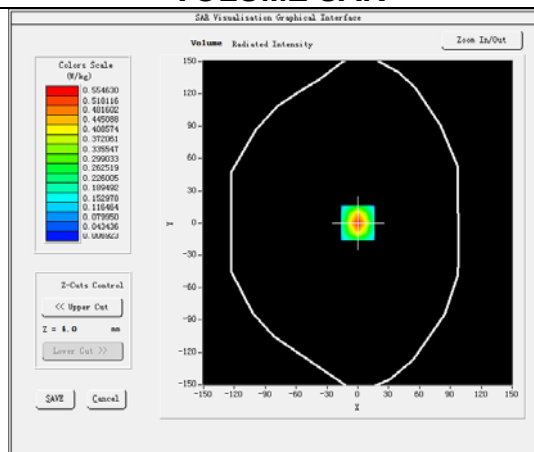
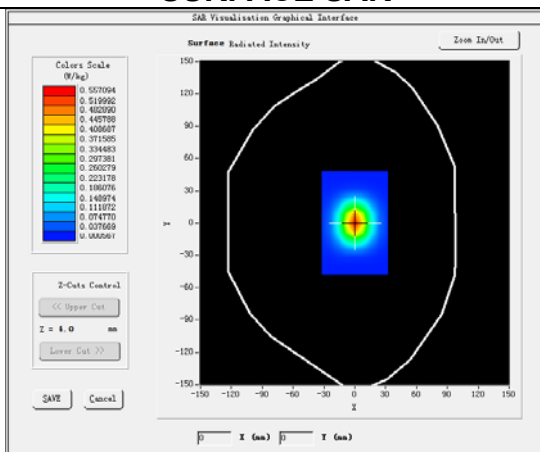

9 TYPE A MEASUREMENT UNCERTAINTY

The component of uncertainty may generally be categorized according to the methods used to evaluate them. The evaluation of uncertainty by the statistical analysis of a series of observations is termed a Type A evaluation of uncertainty. The evaluation of uncertainty by means other than the statistical analysis of a series of observation is termed a Type B evaluation of uncertainty. Each component of uncertainty, however evaluated, is represented by an estimated standard deviation, termed standard uncertainty, which is determined by the positive square root of the estimated variance

A Type A evaluation of standard uncertainty may be based on any valid statistical method for treating data. This includes calculating the standard deviation of the mean of a series of independent observations; using the method of least squares to fit a curve to the data in order to estimate the parameter of the curve and their standard deviations; or carrying out an analysis of variance in order to identify and quantify random effects in certain kinds of measurement.

A type B evaluation of standard uncertainty is typically based on scientific judgment using all of the relevant information available. These may include previous measurement data, experience and specification, data provided in calibration reports and uncertainties assigned to reference data taken from handbooks. Broadly speaking, the uncertainty is either obtained from an outdoor source or obtained from an assumed distribution, such as the normal distribution, rectangular or triangular distributions indicated in Table below :

Uncertainty Distribution	Normal	Rectangle	Triangular	U Shape
Multi-plying Factor ^(a)	$1/k^{(b)}$	$1/\sqrt{3}$	$1/\sqrt{6}$	$1/\sqrt{2}$

(a) standard uncertainty is determined as the product of the multiplying factor and the estimated range of variations in the measured quantity

(b) k is the coverage factor

Standard Uncertainty for Assumed Distribution

The combined standard uncertainty of the measurement result represents the estimated standard deviation of the result. It is obtained by combining the individual standard uncertainties of both Type A and Type -sum- by taking the positive square root of the estimated variances.

Expanded uncertainty is a measure of uncertainty that defines an interval about the measurement result within which the measured value is confidently believed to lie. It is obtained by multiplying the combined standard uncertainty by a coverage factor. Typically, the coverage factor ranges from 2 to 3. Using a coverage factor allows the true value of a measured quantity to be specified with a defined probability within the specified uncertainty range. For purpose of this document, a coverage factor two is used, which corresponds to confidence interval of about 95 %.

The COMOSAR Uncertainty Budget is show in below table:

UNCERTAINTY FOR SYSTEM PERFORMANCE CHECK

Uncertainty Component	Tol. (± %)	Prob. Dist.	Div.	ci (1 g)	ci (10 g)	1 g ui (± %)	10 g ui (± %)	vi
Measurement System								
Probe Calibration	5,8	N	1	1	1	5,8	5,8	∞
Axial Isotropy	3,5	R	$\sqrt{3}$	$(1-cp)1/2$	$(1-cp)1/2$	1,42887	1,42887	∞
Hemispherical Isotropy	5,9	R	$\sqrt{3}$	\sqrt{Cp}	\sqrt{Cp}	2,40866	2,40866	∞
Boundary Effect	1	R	$\sqrt{3}$	1	1	0,57735	0,57735	∞
Linearity	4,7	R	$\sqrt{3}$	1	1	2,71355	2,71355	∞
System Detection Limits	1	R	$\sqrt{3}$	1	1	0,57735	0,57735	∞
Readout Electronics	0,5	N	1	1	1	0,5	0,5	∞
Response Time	0	R	$\sqrt{3}$	1	1	0	0	∞
Integration Time	1,4	R	$\sqrt{3}$	1	1	0,80829	0,80829	∞
RF Ambient Conditions	3	R	$\sqrt{3}$	1	1	1,73205	1,73205	∞
Probe Positioner Mechanical Tolerance	1,4	R	$\sqrt{3}$	1	1	0,80829	0,80829	∞
Probe Positioning with respect to Phantom Shell	1,4	R	$\sqrt{3}$	1	1	0,80829	0,80829	∞
Extrapolation, interpolation and Integration Algorithms for Max. SAR Evaluation	2,3	R	$\sqrt{3}$	1	1	1,32791	1,32791	∞
Dipole								
Dipole Axis to Liquid Distance	2	N	$\sqrt{3}$	1	1	1,1547	1,1547	N-1
Input Power and SAR drift measurement	5	R	$\sqrt{3}$	1	1	2,88675	2,88675	∞
Phantom and Tissue Parameters								
Phantom Uncertainty (shape and thickness tolerances)	4	R	$\sqrt{3}$	1	1	2,3094	2,3094	∞
Liquid Conductivity - deviation from target values	5	R	$\sqrt{3}$	0,64	0,43	1,84752	1,2413	∞
Liquid Conductivity - measurement uncertainty	4	N	1	0,64	0,43	2,56	1,72	M
Liquid Permittivity - deviation from target values	5	R	$\sqrt{3}$	0,6	0,49	1,73205	1,41451	∞
Liquid Permittivity - measurement uncertainty	5	N	1	0,6	0,49	3	2,45	M
Combined Standard Uncertainty		RSS				9.6671	9.1646	
Expanded Uncertainty (95% CONFIDENCE INTERVAL)		k				19.3342	18.3292	

UNCERTAINTY EVALUATION FOR HANDSET SAR TEST

Uncertainty Component	Tol. (± %)	Prob. Dist.	Div.	c_i (1 g)	c_i (10 g)	1 g u_i (± %)	10 g u_i (± %)	v_i
Measurement System								
Probe Calibration	5,8	N	1	1	1	5,8	5,8	∞
Axial Isotropy	3,5	R	$\sqrt{3}$	$(1-c_p)^{1/2}$	$(1-c_p)^{1/2}$	1,43	1,43	∞
Hemispherical Isotropy	5,9	R	$\sqrt{3}$	$\sqrt{C_p}$	$\sqrt{C_p}$	2,41	2,41	∞
Boundary Effect	1	R	$\sqrt{3}$	1	1	0,58	0,58	∞
Linearity	4,7	R	$\sqrt{3}$	1	1	2,71	2,71	∞
System Detection Limits	1	R	$\sqrt{3}$	1	1	0,58	0,58	∞
Readout Electronics	0,5	N	1	1	1	0,50	0,50	∞
Response Time	0	R	$\sqrt{3}$	1	1	0,00	0,00	∞
Integration Time	1,4	R	$\sqrt{3}$	1	1	0,81	0,81	∞
RF Ambient Conditions	3	R	$\sqrt{3}$	1	1	1,73	1,73	∞
Probe Positioner Mechanical Tolerance	1,4	R	$\sqrt{3}$	1	1	0,81	0,81	∞
Probe Positioning with respect to Phantom Shell	1,4	R	$\sqrt{3}$	1	1	0,81	0,81	∞
Extrapolation, interpolation and Integration Algorithms for Max. SAR Evaluation	2,3	R	$\sqrt{3}$	1	1	1,33	1,33	∞
Test sample Related								
Test Sample Positioning	2,6	N	1	1	1	2,60	2,60	N-1
Device Holder Uncertainty	3	N	1	1	1	3,00	3,00	N-1
Output Power Variation - SAR drift measurement	5	R	$\sqrt{3}$	1	1	2,89	2,89	∞
Phantom and Tissue Parameters								
Phantom Uncertainty (shape and thickness tolerances)	4	R	$\sqrt{3}$	1	1	2,31	2,31	∞
Liquid Conductivity - deviation from target values	5	R	$\sqrt{3}$	0,64	0,43	1,85	1,24	∞
Liquid Conductivity - measurement uncertainty	4	N	1	0,64	0,43	2,56	1,72	M
Liquid Permittivity - deviation from target values	5	R	$\sqrt{3}$	0,6	0,49	1,73	1,41	∞
Liquid Permittivity - measurement uncertainty	5	N	1	0,6	0,49	3,00	2,45	M
Combined Standard Uncertainty		RSS				10.39	9.92	
Expanded Uncertainty (95% CONFIDENCE INTERVAL)		k				20.78	19.84	

10 TEST INSTRUMENT

Name of Equipment	Manufacturer	Type/Model	Serial Number	Calibration Date	Calibration Due
6 AXIS ROBOT	KUKA	KR6 R900 SIXX	502635	N/A	N/A
SATIMO Test Software	MVG	OPENSAR	OPENSAR V_4_02_27	N/A	N/A
PHANTOM TABLE	MVG	N/A	SAR_1215_01	N/A	N/A
SAM PHANTOM	MVG	SAM118	SN 11/15 SAM118	N/A	N/A
MultiMeter	Keithley	MiltiMeter 2000	4073942	2016-03-16	2017-03-15
Data Acquisition Electronics	MVG	DAE4	915	2016-03-16	2017-03-15
S-Parameter Network Analyzer	Agilent	8753E	JP38160684	2016-04-02	2017-04-01
Universal Radio Communication Tester	ROHDE&SCHWARZ	CMU200	112461	2016-03-23	2017-03-22
E-Field Probe	MVG	SSE5	SN 07/15 EP249	2015-10-19	2016-10-18
DIPOLE 835	MVG	SID835	SN 09/15 DIP 0G835-358	2015-03-16	2017-03-15
DIPOLE 1800	MVG	SID1800	SN 09/15 DIP 1G800-360	2015-03-16	2017-03-15
DIPOLE 1900	MVG	SID1900	SN 09/15 DIP 1G900-361	2015-03-16	2017-03-15
Limesar Dielectric Probe	MVG	SCLMP	SN 11/15 OCPG 69	2016-03-16	2017-03-15
Power Amplifier	BONN	BLWA 0830 -160/100/40D	128740	2015-09-14	2016-09-14
Signal Generator	R&S	SMB100A	105942	2015-09-14	2016-09-14
Power Meter	R&S	NRP2	102031	2015-09-14	2016-09-14

11 OUTPUT POWER VERIFICATION

Test Condition:

1. Conducted Measurement
EUT was set for low, mid, high channel with modulated mode and highest RF output power.
The base station simulator was connected to the antenna terminal.
2. Conducted Emissions Measurement Uncertainty
All test measurements carried out are traceable to national standards. The uncertainty of the measurement at a confidence level of approximately 95% (in the case where distributions are normal), with a coverage factor of 2, in the range 30MHz – 40GHz is ± 1.5 dB.
3. Environmental Conditions

Temperature	23°C
Relative Humidity	53%
Atmospheric Pressure	1019mbar
4. Test Date : Mar 30,2016
Tested By : Damon Wang

Test Procedures:

Mobile Phone radio output power measurement

1. The transmitter output port was connected to base station emulator.
2. Establish communication link between emulator and EUT and set EUT to operate at maximum output power all the time.
3. Select lowest, middle, and highest channels for each band and different possible test mode.
4. Measure the conducted peak burst power and conducted average burst power from EUT antenna port.

Other radio output power measurement

The output power was measured using power meter at low, mid, and hi channels.

Source-based Time Averaged Burst Power Calculation:

For TDMA, the following duty cycle factor was used to calculate the source-based time average power

Number of Time slot	1	2	3	4
Duty Cycle	1:8	1:4	1:2.66	1:2
Duty cycle factor	-9.03 dB	-6.02 dB	-4.26 dB	-3.01 dB
Crest Factor	8	4	2.66	2

Remark: *Time slot duty cycle factor = $10 * \log (1 / \text{Time Slot Duty Cycle})$*

Source based time averaged power = Maximum burst averaged power (1 Uplink) – 9.03 dB

Source based time averaged power = Maximum burst averaged power (2 Uplink) – 6.02 dB

Source based time averaged power = Maximum burst averaged power (3 Uplink) – 4.26 dB

Source based time averaged power = Maximum burst averaged power (4 Uplink) – 3.01 dB

Test Result:

Burst Average Power (dBm);								
Band	GSM850				PCS1900			
Channel	128	190	251	Tune up Power tolerant	512	661	810	Tune up Power tolerant
Frequency (MHz)	824.2	836.6	848.8	/	1850.2	1880	1909.8	/
GSM Voice	32.69	32.55	32.43	32±1	29.81	29.79	29.43	29±1
GPRS 1 slots	32.71	32.58	32.48	32±1	29.82	29.80	29.43	29±1
GPRS 2 slots	32.45	32.34	32.23	32±1	28.99	28.96	28.63	28±1
GPRS 3 slots	31.37	31.22	31.12	30.5±1	27.10	27.04	26.79	27±1
GPRS 4 slots	28.43	28.29	28.20	28±1	25.98	25.88	25.64	25±1
EGPRS 1 slots	26.80	26.89	26.83	26±1	25.44	25.03	24.96	25±1
EGPRS 2 slots	25.69	25.80	25.68	25±1	24.15	23.70	22.93	24±1
EGPRS 3 slots	25.54	25.66	25.44	25±1	22.89	22.78	22.56	22±1
EGPRS 4 slots	25.41	25.46	25.32	25±1	22.36	22.34	22.12	22±1
Remark : GPRS, CS1 coding scheme. EGPRS, MCS5 coding scheme. Multi 1 Slot , Support Max 4 downlink, 1 uplink , 5 working link Multi 2 Slots , Support Max 4 downlink, 2 uplink , 5 working link Multi 3 Slots , Support Max 4 downlink, 3 uplink , 5 working link Multi 4 Slots , Support Max 4 downlink, 4 uplink , 5 working link								

Source Based time Average Power (dBm)								
Band	GSM850				PCS1900			
Channel	128	190	251	Time Average factor	512	661	810	Time Average factor
Frequency (MHz)	824.2	836.6	848.8	/	1850.2	1880	1909.8	/
GSM Voice	23.66	23.52	23.40	-9.03	20.78	20.76	20.40	-9.03
GPRS 1 slots	23.68	23.55	23.45	-9.03	20.79	20.77	20.40	-9.03
GPRS 2 slots	26.43	26.32	26.21	-6.02	22.97	22.94	22.61	-6.02
GPRS 3 slots	27.11	26.96	26.86	-4.26	22.84	22.78	22.53	-4.26
GPRS 4 slots	25.42	25.28	25.19	-3.01	22.97	22.87	22.63	-3.01
EGPRS 1 slots	17.77	17.86	17.80	-9.03	16.21	16.00	15.93	-9.03
EGPRS 2 slots	19.67	19.78	19.66	-6.02	18.13	17.68	16.91	-6.02
EGPRS 3 slots	21.28	21.40	21.18	-4.26	18.63	18.52	18.30	-4.26
EGPRS 4 slots	22.40	22.45	22.31	-3.01	19.35	19.33	19.11	-3.01

Remark :

Time average factor = 1 uplink , $10 \cdot \log(1/8) = -9.03\text{dB}$, 2 uplink , $10 \cdot \log(2/8) = -6.02\text{dB}$, 3 uplink , $10 \cdot \log(3/8) = -4.26\text{dB}$, 4 uplink , $10 \cdot \log(4/8) = -3.01\text{dB}$

Source based time average power = Burst Average power + Time Average factor

Note: 1. For GSM850, DUT was set in GPRS(3Tx slots) due to the Maximum source-base time average output power for body SAR.

1. For PCS1900, DUT was set in GPRS(4Tx slots) due to the Maximum source-base time average output power for body SAR.

WCDMA - Average Power (dBm)										
Band	WCDMA Band II					WCDMA Band V				
Channel	9262	9400	9538	Tune up Power tolerant	MPR (dB)	4132	4183	4233	Tune up Power tolerant	MPR (dB)
Frequency (MHz)	1852.4	1880	1907.6	/	/	826.4	836.6	846.6	/	/
RMC 12.2k	22.88	22.72	22.68	22±1	0	22.54	22.37	22.55	22±1	0
HSDPA Subtest-1	21.53	21.66	21.60	21±1	1	21.42	21.20	21.57	21±1	1
HSDPA Subtest-2	21.42	21.55	21.58	21±1	1	21.36	21.17	21.47	21±1	1
HSDPA Subtest-3	21.40	21.47	21.57	21±1	1	21.32	21.16	21.45	21±1	1
HSDPA Subtest-4	21.39	21.36	21.52	21±1	1	21.28	21.22	21.43	21±1	1
HSUPA Subtest-1	21.56	21.68	21.60	21±1	1	21.39	21.21	21.57	21±1	1
HSUPA Subtest-2	21.45	21.62	21.55	21±1	1	21.40	21.23	21.47	21±1	1
HSUPA Subtest-3	21.42	21.58	21.49	21±1	1	21.36	21.20	21.45	21±1	1
HSUPA Subtest-4	21.38	21.42	21.46	21±1	1	21.33	21.19	21.36	21±1	1
HSUPA Subtest-5	21.39	21.44	21.47	21±1	1	21.27	21.17	21.32	21±1	1

LTE Power Reduction

The following tests were conducted according to the test requirements outlined in section 6.2 of the 3GPP TS36.101 specification.

The allowed Maximum Power Reduction (MPR) for the maximum output power due to higher order modulation and transmit bandwidth configuration (resource blocks) is specified in Table 6.2.3-1 of the 3GPP TS36.101.

Table 6.2.3-1: Maximum Power Reduction (MPR) for Power Class 3

Modulation	Channel bandwidth / Transmission bandwidth (RB)						MPR (dB)
	1.4 MHz	3.0 MHz	5 MHz	10 MHz	15 MHz	20 MHz	
QPSK	> 5	> 4	> 8	> 12	> 16	> 18	≤ 1
16 QAM	≤ 5	≤ 4	≤ 8	≤ 12	≤ 16	≤ 18	≤ 1
16 QAM	> 5	> 4	> 8	> 12	> 16	> 18	≤ 2

The allowed A-MPR values specified below in Table 6.2.4-1 of 3GPP TS36.101 are in addition to the allowed MPR requirements. All the measurements below were performed with A-MPR disabled, by using Network Signalling Value of "NS_01".

Table 6.2.4-1: Additional Maximum Power Reduction (A-MPR)

Network Signalling value	Requirements (sub-clause)	E-UTRA Band	Channel bandwidth (MHz)	Resources Blocks (N_{RB})	A-MPR (dB)
NS_01	6.6.2.1.1	Table 5.5-1	1.4, 3, 5, 10, 15, 20	Table 5.6-1	NA
NS_03	6.6.2.2.1	2, 4, 10, 23, 25, 35, 36	3	>5	≤ 1
			5	>6	≤ 1
			10	>6	≤ 1
			15	>8	≤ 1
			20	>10	≤ 1
NS_04	6.6.2.2.2	41	5	>6	≤ 1
			10, 15, 20	See Table 6.2.4-4	
NS_05	6.6.3.3.1	1	10, 15, 20	≥ 50	≤ 1
NS_06	6.6.2.2.3	12, 13, 14, 17	1.4, 3, 5, 10	Table 5.6-1	n/a
NS_07	6.6.2.2.3	13	10	Table 6.2.4-2	Table 6.2.4-2
	6.6.3.3.2				
NS_08	6.6.3.3.3	19	10, 15	> 44	≤ 3
NS_09	6.6.3.3.4	21	10, 15	> 40	≤ 1
				> 55	≤ 2
NS_10		20	15, 20	Table 6.2.4-3	Table 6.2.4-3
NS_11	6.6.2.2.1	23 ¹	1.4, 3, 5, 10	Table 6.2.4-5	Table 6.2.4-5
..					
NS_32	-	-	-	-	-

Note 1: Applies to the lower block of Band 23, i.e. a carrier placed in the 2000-2010 MHz region.

LTE Band 2:

BW(MHz)	Ch	Freq(MHz)	Mode	UL RB Allocation	UL RB Offset	Average Power (dbm)	Tune up limited(dBm)	MPR (dB)
1.4MHz	18607	1850.7	QPSK	1	0	21.89	22.0±1	0
				1	2	21.88	22.0±1	0
				1	5	21.92	22.0±1	0
				3	0	21.27	21.0±1	1
				3	1	21.49	21.0±1	1
				3	2	21.18	21.0±1	1
			16QAM	6	0	21.17	21.0±1	1
				1	0	21.86	21.0±1	1
				1	2	21.89	21.0±1	1
				1	5	21.79	21.0±1	1
				3	0	21.94	21.0±1	1
				3	1	21.93	21.0±1	1
	18900	1880	QPSK	3	2	21.89	21.0±1	1
				6	0	21.89	21.0±1	1
				1	0	22.32	22.0±1	0
				1	2	22.32	22.0±1	0
				1	5	22.31	22.0±1	0
				3	0	21.39	21.0±1	1
			16QAM	3	1	21.4	21.0±1	1
				3	2	21.38	21.0±1	1
				6	0	21.29	21.0±1	1
				1	0	21.68	21.0±1	1
				1	2	21.67	21.0±1	1
				1	5	21.65	21.0±1	1
	19193	1909.3	QPSK	3	0	21.59	21.0±1	1
				3	1	21.53	21.0±1	1
				3	2	21.54	21.0±1	1
				6	0	20.23	21.0±1	1
				1	0	22.47	22.0±1	0
				1	2	22.56	22.0±1	0
16QAM			1	5	22.51	22.0±1	0	
			3	0	21.47	21.0±1	1	
			3	1	21.51	21.0±1	1	
			3	2	21.48	21.0±1	1	
			6	0	21.56	21.0±1	1	
			1	0	21.38	21.0±1	1	
16QAM	1	2	21.4	21.0±1	1			
	1	5	21.39	21.0±1	1			
	3	0	21.59	21.0±1	1			
	3	1	21.57	21.0±1	1			
	3	2	21.56	21.0±1	1			
	6	0	20.62	21.0±1	1			

BW(MHz)	Ch	Freq(MHz)	Mode	UL RB Allocation	UL RB Offset	Average Power (dbm)	Tune up limited(dBm)	MPR (dB)
3MHz	18615	1851.5	QPSK	1	0	21.9	22.0±1	0
				1	8	21.82	22.0±1	0
				1	14	21.9	22.0±1	0
				6	0	21.14	21.0±1	1
				6	4	21.33	21.0±1	1
				6	9	21.25	21.0±1	1
			16QAM	15	0	21.08	21.0±1	1
				1	0	21.87	22.0±1	0
				1	8	21.87	22.0±1	0
				1	14	21.91	22.0±1	0
				6	0	21.92	21.0±1	1
				6	4	21.91	21.0±1	1
				6	9	21.96	21.0±1	1
				15	0	22.02	21.0±1	1
				18900	1880	QPSK	1	0
	1	8	22.37				22.0±1	0
	1	14	22.31				22.0±1	0
	6	0	21.4				21.0±1	1
	6	4	21.42				21.0±1	1
	6	9	21.43				21.0±1	1
	16QAM	15	0			21.36	21.0±1	1
		1	0			21.65	22.0±1	0
		1	8			21.69	22.0±1	0
		1	14			21.66	22.0±1	0
		6	0			20.48	21.0±1	1
		6	4			20.5	21.0±1	1
		6	9			20.51	21.0±1	1
		15	0			20.43	21.0±1	1
		19185	1908.5			QPSK	1	0
	1			8	22.52		22.0±1	0
1	14			22.47	22.0±1		0	
6	0			21.59	21.0±1		1	
6	4			21.6	21.0±1		1	
6	9			21.59	21.0±1		1	
16QAM	15			0	21.54	21.0±1	1	
	1			0	21.42	22.0±1	0	
	1			8	21.4	22.0±1	0	
	1			14	21.34	22.0±1	0	
	6			0	20.59	21.0±1	1	
	6			4	20.59	21.0±1	1	
	6			9	20.56	21.0±1	1	
	15			0	20.49	21.0±1	1	

BW(MHz)	Ch	Freq(MHz)	Mode	UL RB Allocation	UL RB Offset	Average Power (dbm)	Tune up limited(dBm)	MPR (dB)
5MHz	18625	1852.5	QPSK	1	0	21.92	22.0±1	0
				1	12	21.93	22.0±1	0
				1	24	21.89	22.0±1	0
				12	0	20.99	21.0±1	1
				12	6	20.96	21.0±1	1
				12	11	20.95	21.0±1	1
				25	0	20.93	21.0±1	1
			16QAM	1	0	21.08	21.0±1	1
				1	12	21.07	21.0±1	1
				1	24	21.02	21.0±1	1
				12	0	20.08	21.0±1	1
				12	6	20.05	21.0±1	1
				12	11	20.08	21.0±1	1
				25	0	19.98	21.0±1	1
	18900	1880	QPSK	1	0	22.36	22.0±1	0
				1	12	22.38	22.0±1	0
				1	24	22.35	22.0±1	0
				12	0	21.44	21.0±1	1
				12	6	21.43	21.0±1	1
				12	11	21.43	21.0±1	1
				25	0	21.38	21.0±1	1
			16QAM	1	0	21.87	21.0±1	1
				1	12	21.87	21.0±1	1
				1	24	21.83	21.0±1	1
				12	0	20.61	21.0±1	1
				12	6	20.6	21.0±1	1
				12	11	20.58	21.0±1	1
				25	0	20.48	21.0±1	1
	19175	1907.5	QPSK	1	0	22.61	22.0±1	0
				1	12	22.64	22.0±1	0
1				24	22.62	22.0±1	0	
12				0	21.65	21.0±1	1	
12				6	21.62	21.0±1	1	
12				11	21.62	21.0±1	1	
25				0	21.58	21.0±1	1	
16QAM			1	0	21.64	21.0±1	1	
			1	12	21.61	21.0±1	1	
			1	24	21.54	21.0±1	1	
			12	0	20.7	21.0±1	1	
			12	6	20.67	21.0±1	1	
			12	11	20.66	21.0±1	1	
			25	0	20.54	21.0±1	1	

BW(MHz)	Ch	Freq(MHz)	Mode	UL RB Allocation	UL RB Offset	Average Power (dbm)	Tune up limited(dBm)	MPR (dB)
10MHz	18650	1855	QPSK	1	0	22.06	22.0±1	0
				1	24	21.61	22.0±1	0
				1	49	21.54	22.0±1	0
				25	0	20.7	21.0±1	1
				25	12	20.67	21.0±1	1
				25	24	20.66	21.0±1	1
				50	0	20.54	21.0±1	1
			16QAM	1	0	21.4	21.0±1	1
				1	24	21.41	21.0±1	1
				1	49	21.66	21.0±1	1
				25	0	21.74	21.0±1	1
				25	12	21.45	21.0±1	1
				25	24	21.61	21.0±1	1
				50	0	21.54	21.0±1	1
	18900	1880	QPSK	1	0	22.36	22.0±1	0
				1	24	22.41	22.0±1	0
				1	49	22.45	22.0±1	0
				25	0	21.38	21.0±1	1
				25	12	21.38	21.0±1	1
				25	24	21.4	21.0±1	1
				50	0	21.41	21.0±1	1
			16QAM	1	0	21.66	21.0±1	1
				1	24	21.74	21.0±1	1
				1	49	21.74	21.0±1	1
				25	0	20.43	21.0±1	1
				25	12	20.45	21.0±1	1
				25	24	20.46	21.0±1	1
				50	0	20.47	21.0±1	1
	19150	1905	QPSK	1	0	22.44	22.0±1	0
				1	24	22.55	22.0±1	0
1				49	22.6	22.0±1	0	
25				0	21.53	21.0±1	1	
25				12	21.53	21.0±1	1	
25				24	21.56	21.0±1	1	
50				0	21.54	21.0±1	1	
16QAM			1	0	21.35	21.0±1	1	
			1	24	21.53	21.0±1	1	
			1	49	21.43	21.0±1	1	
			25	0	20.65	21.0±1	1	
			25	12	20.66	21.0±1	1	
			25	24	20.65	21.0±1	1	
			50	0	20.59	21.0±1	1	

BW(MHz)	Ch	Freq(MHz)	Mode	UL RB Allocation	UL RB Offset	Average Power (dbm)	Tune up limited(dBm)	MPR (dB)
15MHz	18675	1857.5	QPSK	1	0	22.04	22.0±1	0
				1	37	22.09	22.0±1	0
				1	74	22.18	22.0±1	0
				36	0	21.14	21.0±1	1
				36	16	21.17	21.0±1	1
				36	35	21.22	21.0±1	1
				75	0	21.18	21.0±1	1
			16QAM	1	0	20.9	21.0±1	1
				1	37	20.89	21.0±1	1
				1	74	20.98	21.0±1	1
				36	0	20.08	21.0±1	1
				36	16	20.11	21.0±1	1
				36	35	20.15	21.0±1	1
				75	0	20.13	21.0±1	1
	18900	1880	QPSK	1	0	22.4	22.0±1	0
				1	37	22.44	22.0±1	0
				1	74	22.46	22.0±1	0
				36	0	21.48	21.0±1	1
				36	16	21.47	21.0±1	1
				36	35	21.52	21.0±1	1
				75	0	21.51	21.0±1	1
			16QAM	1	0	21.68	21.0±1	1
				1	37	21.75	21.0±1	1
				1	74	21.76	21.0±1	1
				36	0	20.53	21.0±1	1
				36	16	20.53	21.0±1	1
				36	35	20.56	21.0±1	1
				75	0	20.52	21.0±1	1
	19125	1902.5	QPSK	1	0	22.45	22.0±1	0
				1	37	22.62	22.0±1	0
1				74	22.53	22.0±1	0	
36				0	21.36	21.0±1	1	
36				16	21.43	21.0±1	1	
36				35	21.22	21.0±1	1	
75				0	21.68	21.0±1	1	
16QAM			1	0	21.61	21.0±1	1	
			1	37	21.9	21.0±1	1	
			1	74	21.76	21.0±1	1	
			36	0	20.29	21.0±1	1	
			36	16	20.6	21.0±1	1	
			36	35	20.64	21.0±1	1	
			75	0	20.65	21.0±1	1	

BW(MHz)	Ch	Freq(MHz)	Mode	UL RB Allocation	UL RB Offset	Average Power (dbm)	Tune up limited(dBm)	MPR (dB)
20MHz	18700	1860	QPSK	1	0	22.01	22.0±1	0
				1	49	22.06	22.0±1	0
				1	99	22.24	22.0±1	0
				50	0	21.02	21.0±1	1
				50	24	21.05	21.0±1	1
				50	49	21.14	21.0±1	1
				100	0	21.06	21.0±1	1
			16QAM	1	0	21.5	21.0±1	1
				1	49	21.49	21.0±1	1
				1	99	21.68	21.0±1	1
				50	0	20.05	21.0±1	1
				50	24	20.07	21.0±1	1
				50	49	20.17	21.0±1	1
				100	0	20.11	21.0±1	1
	18900	1880	QPSK	1	0	22.35	22.0±1	0
				1	49	22.44	22.0±1	0
				1	99	22.52	22.0±1	0
				50	0	21.43	21.0±1	1
				50	24	21.44	21.0±1	1
				50	49	21.5	21.0±1	1
				100	0	21.45	21.0±1	1
			16QAM	1	0	21.7	21.0±1	1
				1	49	21.85	21.0±1	1
				1	99	21.87	21.0±1	1
				50	0	20.47	21.0±1	1
				50	24	20.51	21.0±1	1
				50	49	20.54	21.0±1	1
				100	0	20.47	21.0±1	1
	19100	1900	QPSK	1	0	22.53	22.0±1	0
				1	49	22.19	22.0±1	0
1				99	22.78	22.0±1	0	
50				0	21.33	21.0±1	1	
50				24	21.36	21.0±1	1	
50				49	21.58	21.0±1	1	
100				0	21.54	21.0±1	1	
16QAM			1	0	21.8	21.0±1	1	
			1	49	21.48	21.0±1	1	
			1	99	21.84	21.0±1	1	
			50	0	20.3	21.0±1	1	
			50	24	20.31	21.0±1	1	
			50	49	20.59	21.0±1	1	
			100	0	20.58	21.0±1	1	

LTE Band 4:

BW(MHz)	Ch	Freq(MHz)	Mode	UL RB Allocation	UL RB Offset	Average Power (dbm)	Tune up limited(dBm)	MPR (dB)			
1.4MHz	19957	1710.7	QPSK	1	0	21.73	22.0±1	0			
				1	2	21.82	22.0±1	0			
				1	5	21.82	22.0±1	0			
				3	0	21.84	22.0±1	0			
				3	1	22.33	22.0±1	0			
				3	2	22.27	22.0±1	0			
			6	0	22.28	22.0±1	0				
			16QAM	1	0	22.45	22.0±1	0			
				1	2	22.38	22.0±1	0			
				1	5	22.4	22.0±1	0			
				3	0	22.33	22.0±1	0			
				3	1	22.27	22.0±1	0			
				3	2	22.28	22.0±1	0			
				6	0	22.17	22.0±1	0			
	1	0		22.24	22.0±1	0					
	20175	1732.5	QPSK	1	2	22.21	22.0±1	0			
				1	5	22.22	22.0±1	0			
				3	0	22.33	22.0±1	0			
				3	1	22.27	22.0±1	0			
				3	2	22.28	22.0±1	0			
				6	0	22.17	22.0±1	0			
			16QAM	1	0	22.57	22.0±1	0			
				1	2	22.52	22.0±1	0			
				1	5	22.54	22.0±1	0			
				3	0	22.45	22.0±1	0			
				3	1	22.38	22.0±1	0			
				3	2	22.4	22.0±1	0			
				6	0	22.09	22.0±1	0			
				20393	1754.3	QPSK	1	0	21.82	22.0±1	0
							1	2	21.82	22.0±1	0
1							5	21.84	22.0±1	0	
3	0	21.96	22.0±1				0				
3	1	21.93	22.0±1				0				
3	2	21.94	22.0±1				0				
6	0	21.84	22.0±1			0					
16QAM	1	0	21.85			22.0±1	0				
	1	2	21.82			22.0±1	0				
	1	5	21.86			22.0±1	0				
	3	0	22.09			22.0±1	0				
	3	1	22.05			22.0±1	0				
	3	2	22.06			22.0±1	0				
	6	0	21.95			22.0±1	0				

BW(MHz)	Ch	Freq(MHz)	Mode	UL RB Allocation	UL RB Offset	Average Power (dbm)	Tune up limited(dBm)	MPR (dB)
3MHz	19965	1711.5	QPSK	1	0	21.65	22.0±1	0
				1	8	22.09	22.0±1	0
				1	14	21.82	22.0±1	0
				6	0	21.82	22.0±1	0
				6	4	21.84	22.0±1	0
				6	9	21.96	22.0±1	0
				15	0	22.26	22.0±1	0
			16QAM	1	0	22.22	22.0±1	0
				1	8	22.57	22.0±1	0
				1	14	22.58	22.0±1	0
				8	0	21.83	22.0±1	0
				8	4	21.79	22.0±1	0
				8	9	21.94	22.0±1	0
				15	0	21.93	22.0±1	0
	20175	1732.5	QPSK	1	0	22.26	22.0±1	0
				1	8	22.27	22.0±1	0
				1	14	22.21	22.0±1	0
				6	0	22.27	22.0±1	0
				6	4	22.26	22.0±1	0
				6	9	22.26	22.0±1	0
				15	0	22.22	22.0±1	0
			16QAM	1	0	22.57	22.0±1	0
				1	8	22.58	22.0±1	0
				1	14	22.53	22.0±1	0
				6	0	22.31	22.0±1	0
				6	4	22.32	22.0±1	0
				6	9	22.3	22.0±1	0
				15	0	22.25	22.0±1	0
	20385	1753.5	QPSK	1	0	21.83	22.0±1	0
				1	8	21.83	22.0±1	0
1				14	21.79	22.0±1	0	
6				0	21.94	22.0±1	0	
6				4	21.93	22.0±1	0	
6				9	21.93	22.0±1	0	
15				0	21.9	22.0±1	0	
16QAM			1	0	21.85	22.0±1	0	
			1	8	21.82	22.0±1	0	
			1	14	21.77	22.0±1	0	
			8	0	21.92	22.0±1	0	
			8	4	21.93	22.0±1	0	
			8	9	21.9	22.0±1	0	
			15	0	21.83	22.0±1	0	

BW(MHz)	Ch	Freq(MHz)	Mode	UL RB Allocation	UL RB Offset	Average Power (dbm)	Tune up limited(dBm)	MPR (dB)
5MHz	19975	1712.5	QPSK	1	0	21.72	22.0±1	0
				1	49	21.83	22.0±1	0
				1	99	21.86	22.0±1	0
				12	0	21.79	22.0±1	0
				12	24	21.85	22.0±1	0
				12	49	21.88	22.0±1	0
				25	0	21.78	22.0±1	0
			16QAM	1	0	21.84	22.0±1	0
				1	49	21.95	22.0±1	0
				1	99	22.01	22.0±1	0
				12	0	21.83	22.0±1	0
				12	24	21.88	22.0±1	0
				12	49	21.94	22.0±1	0
				25	0	21.78	22.0±1	0
	20175	1732.5	QPSK	1	0	22.33	22.0±1	0
				1	49	22.29	22.0±1	0
				1	99	22.22	22.0±1	0
				12	0	22.32	22.0±1	0
				12	24	22.29	22.0±1	0
				12	49	22.3	22.0±1	0
				25	0	22.28	22.0±1	0
			16QAM	1	0	22.8	22.0±1	0
				1	49	22.75	22.0±1	0
				1	99	22.68	22.0±1	0
				12	0	22.43	22.0±1	0
				12	24	22.4	22.0±1	0
				12	49	22.39	22.0±1	0
				25	0	22.3	22.0±1	0
	20375	1752.5	QPSK	1	0	22.02	22.0±1	0
				1	49	21.97	22.0±1	0
1				99	21.93	22.0±1	0	
12				0	21.97	22.0±1	0	
12				24	21.93	22.0±1	0	
12				49	21.95	22.0±1	0	
25				0	21.91	22.0±1	0	
16QAM			1	0	22.02	22.0±1	0	
			1	49	21.97	22.0±1	0	
			1	99	21.95	22.0±1	0	
			12	0	21.98	22.0±1	0	
			12	24	21.97	22.0±1	0	
			12	49	21.94	22.0±1	0	
			25	0	21.81	22.0±1	0	

BW(MHz)	Ch	Freq(MHz)	Mode	UL RB Allocation	UL RB Offset	Average Power (dbm)	Tune up limited(dBm)	MPR (dB)
10MHz	20000	1715	QPSK	1	0	21.82	22.0±1	0
				1	49	22.4	22.0±1	0
				1	99	22.39	22.0±1	0
				25	0	22.3	22.0±1	0
				25	24	22.02	22.0±1	0
				25	49	21.93	22.0±1	0
				50	0	21.97	22.0±1	0
			16QAM	1	0	21.93	22.0±1	0
				1	49	21.95	22.0±1	0
				1	99	22.31	22.0±1	0
				25	0	22.27	22.0±1	0
				25	24	22.25	22.0±1	0
				25	49	22.3	22.0±1	0
				50	0	22.02	22.0±1	0
	20175	1732.5	QPSK	1	0	22.39	22.0±1	0
				1	49	22.27	22.0±1	0
				1	99	22.25	22.0±1	0
				25	0	22.29	22.0±1	0
				25	24	22.27	22.0±1	0
				25	49	22.24	22.0±1	0
				50	0	22.28	22.0±1	0
			16QAM	1	0	22.68	22.0±1	0
				1	49	22.53	22.0±1	0
				1	99	22.52	22.0±1	0
				25	0	22.31	22.0±1	0
				25	24	22.27	22.0±1	0
				25	49	22.25	22.0±1	0
				50	0	22.29	22.0±1	0
	20350	1750	QPSK	1	0	21.95	22.0±1	0
				1	49	21.81	22.0±1	0
1				99	21.82	22.0±1	0	
25				0	21.9	22.0±1	0	
25				24	21.87	22.0±1	0	
25				49	21.82	22.0±1	0	
50				0	21.89	22.0±1	0	
16QAM			1	0	21.97	22.0±1	0	
			1	49	21.82	22.0±1	0	
			1	99	21.81	22.0±1	0	
			25	0	21.97	22.0±1	0	
			25	24	21.92	22.0±1	0	
			25	49	21.89	22.0±1	0	
			50	0	21.9	22.0±1	0	

BW(MHz)	Ch	Freq(MHz)	Mode	UL RB Allocation	UL RB Offset	Average Power (dbm)	Tune up limited(dBm)	MPR (dB)
15MHz	20025	1717.5	QPSK	1	0	21.83	22.0±1	0
				1	49	22.1	22.0±1	0
				1	99	22.28	22.0±1	0
				36	0	22.03	22.0±1	0
				36	24	22.17	22.0±1	0
				36	49	22.29	22.0±1	0
				75	0	22.19	22.0±1	0
			16QAM	1	0	21.69	22.0±1	0
				1	49	21.99	22.0±1	0
				1	99	22.18	22.0±1	0
				36	0	22	22.0±1	0
				36	24	22.14	22.0±1	0
				36	49	22.26	22.0±1	0
				75	0	22.16	22.0±1	0
	20175	1732.5	QPSK	1	0	22.4	22.0±1	0
				1	49	22.33	22.0±1	0
				1	99	22.26	22.0±1	0
				36	0	22.41	22.0±1	0
				36	24	22.36	22.0±1	0
				36	49	22.3	22.0±1	0
				75	0	22.39	22.0±1	0
			16QAM	1	0	22.7	22.0±1	0
				1	49	22.62	22.0±1	0
				1	99	22.54	22.0±1	0
				36	0	22.42	22.0±1	0
				36	24	22.36	22.0±1	0
				36	49	22.32	22.0±1	0
				75	0	22.37	22.0±1	0
	20325	1747.5	QPSK	1	0	22.13	22.0±1	0
				1	49	21.98	22.0±1	0
1				99	21.92	22.0±1	0	
36				0	22.06	22.0±1	0	
36				24	22	22.0±1	0	
36				49	21.99	22.0±1	0	
75				0	22.05	22.0±1	0	
16QAM			1	0	22.47	22.0±1	0	
			1	49	22.27	22.0±1	0	
			1	99	22.19	22.0±1	0	
			36	0	22.01	22.0±1	0	
			36	24	21.93	22.0±1	0	
			36	49	21.91	22.0±1	0	
			75	0	22	22.0±1	0	

BW(MHz)	Ch	Freq(MHz)	Mode	UL RB Allocation	UL RB Offset	Average Power (dbm)	Tune up limited(dBm)	MPR (dB)
20MHz	20050	1720	QPSK	1	0	21.86	22.0±1	0
				1	49	22.11	22.0±1	0
				1	99	22.42	22.0±1	0
				50	0	22.05	22.0±1	0
				50	24	22.21	22.0±1	0
				50	49	22.35	22.0±1	0
				100	0	22.2	22.0±1	0
			16QAM	1	0	22.37	22.0±1	0
				1	49	22.62	22.0±1	0
				1	99	22.64	22.0±1	0
				50	0	22.41	22.0±1	0
				50	24	22.01	22.0±1	0
				50	49	21.99	22.0±1	0
				100	0	21.51	22.0±1	0
	20175	1732.5	QPSK	1	0	22.3	22.0±1	0
				1	49	22.53	22.0±1	0
				1	99	22.29	22.0±1	0
				50	0	22.37	22.0±1	0
				50	24	22.58	22.0±1	0
				50	49	22.1	22.0±1	0
				100	0	22.28	22.0±1	0
			16QAM	1	0	21.93	22.0±1	0
				1	49	22.06	22.0±1	0
				1	99	21.97	22.0±1	0
				50	0	22.03	22.0±1	0
				50	24	22.24	22.0±1	0
				50	49	21.63	22.0±1	0
				100	0	21.76	22.0±1	0
	20300	1745	QPSK	1	0	22.26	22.0±1	0
				1	49	21.99	22.0±1	0
1				99	21.93	22.0±1	0	
50				0	22.21	22.0±1	0	
50				24	22.69	22.0±1	0	
50				49	21.45	22.0±1	0	
100				0	21.33	22.0±1	0	
16QAM			1	0	21.89	22.0±1	0	
			1	49	21.83	22.0±1	0	
			1	99	21.44	22.0±1	0	
			50	0	21.55	22.0±1	0	
			50	24	21.36	22.0±1	0	
			50	49	21.54	22.0±1	0	
			100	0	22.34	22.0±1	0	

LTE Band 7:

BW(MHz)	Ch	Freq(MHz)	Mode	UL RB Allocation	UL RB Offset	Average Power (dbm)	Tune up limited(dBm)	MPR (dB)
5MHz	20775	2502.5	QPSK	1	0	23.24	23.0±1	0
				1	49	23.27	23.0±1	0
				1	99	23.29	23.0±1	0
				12	0	22.33	22.0±1	1
				12	24	22.34	22.0±1	1
				12	49	22.36	22.0±1	1
				25	0	22.29	22.0±1	1
			16QAM	1	0	22.78	22.0±1	1
				1	49	22.79	22.0±1	1
				1	99	22.77	22.0±1	1
				12	0	21.56	22.0±1	1
				12	24	21.56	22.0±1	1
				12	49	21.55	22.0±1	1
				25	0	21.43	22.0±1	1
	21100	2535	QPSK	1	0	23.5	23.0±1	0
				1	49	23.47	23.0±1	0
				1	99	23.39	23.0±1	0
				12	0	22.55	22.0±1	1
				12	24	22.5	22.0±1	1
				12	49	22.52	22.0±1	1
				25	0	22.47	22.0±1	1
			16QAM	1	0	22.57	22.0±1	1
				1	49	22.53	22.0±1	1
				1	99	22.49	22.0±1	1
				12	0	21.6	22.0±1	1
				12	24	21.57	22.0±1	1
				12	49	21.56	22.0±1	1
				25	0	21.44	22.0±1	1
	21425	2567.5	QPSK	1	0	22.98	23.0±1	0
				1	49	22.97	23.0±1	0
1				99	22.93	23.0±1	0	
12				0	21.96	22.0±1	1	
12				24	21.94	22.0±1	1	
12				49	21.94	22.0±1	1	
25				0	21.92	22.0±1	1	
16QAM			1	0	22.07	22.0±1	1	
			1	49	22.06	22.0±1	1	
			1	99	21.99	22.0±1	1	
			12	0	21.05	22.0±1	1	
			12	24	21.03	22.0±1	1	
			12	49	21.03	22.0±1	1	
			25	0	21.15	22.0±1	1	

BW(MHz)	Ch	Freq(MHz)	Mode	UL RB Allocation	UL RB Offset	Average Power (dbm)	Tune up limited(dBm)	MPR (dB)
10MHz	20800	2505	QPSK	1	0	22.31	23.0±1	0
				1	49	22.49	23.0±1	0
				1	99	22.6	23.0±1	0
				25	0	21.57	22.0±1	1
				25	24	21.56	22.0±1	1
				25	49	21.44	22.0±1	1
				50	0	22.98	22.0±1	1
			16QAM	1	0	21.69	22.0±1	1
				1	49	21.87	22.0±1	1
				1	99	21.37	22.0±1	1
				25	0	21.58	21.0±1	2
				25	24	21.55	21.0±1	2
				25	49	21.5	21.0±1	2
				50	0	21.57	21.0±1	2
	21100	2535	QPSK	1	0	23.55	23.0±1	0
				1	49	23.47	23.0±1	0
				1	99	23.4	23.0±1	0
				25	0	22.54	22.0±1	1
				25	24	22.49	22.0±1	1
				25	49	22.47	22.0±1	1
				50	0	22.55	22.0±1	1
			16QAM	1	0	22.87	22.0±1	1
				1	49	22.85	22.0±1	1
				1	99	22.78	22.0±1	1
				25	0	21.58	21.0±1	2
				25	24	21.55	21.0±1	2
				25	49	21.5	21.0±1	2
				50	0	21.57	21.0±1	2
	21400	2565	QPSK	1	0	22	23.0±1	0
				1	49	22.67	23.0±1	0
1				99	22.85	23.0±1	0	
25				0	21.32	22.0±1	1	
25				24	21.72	22.0±1	1	
25				49	21.96	22.0±1	1	
50				0	21.81	22.0±1	1	
16QAM			1	0	21.93	22.0±1	1	
			1	49	21.69	22.0±1	1	
			1	99	21.87	22.0±1	1	
			25	0	20.37	21.0±1	2	
			25	24	20.77	21.0±1	2	
			25	49	21.05	21.0±1	2	
			50	0	20.8	21.0±1	2	

BW(MHz)	Ch	Freq(MHz)	Mode	UL RB Allocation	UL RB Offset	Average Power (dbm)	Tune up limited(dBm)	MPR (dB)
15MHz	20825	2507.5	QPSK	1	0	23.34	23.0±1	0
				1	49	23.47	23.0±1	0
				1	99	23.56	23.0±1	0
				36	0	22.52	22.0±1	1
				36	24	22.61	22.0±1	1
				36	49	22.63	22.0±1	1
				75	0	22.6	22.0±1	1
			16QAM	1	0	22.2	22.0±1	1
				1	49	22.23	22.0±1	1
				1	99	22.33	22.0±1	1
				36	0	21.47	21.0±1	2
				36	24	21.52	21.0±1	2
				36	49	21.55	21.0±1	2
				75	0	21.55	21.0±1	2
	21100	2535	QPSK	1	0	23.63	23.0±1	0
				1	49	23.4	23.0±1	0
				1	99	23.45	23.0±1	0
				36	0	22.49	22.0±1	1
				36	24	22.51	22.0±1	1
				36	49	22.54	22.0±1	1
				75	0	22.59	22.0±1	1
			16QAM	1	0	22.89	22.0±1	1
				1	49	22.79	22.0±1	1
				1	99	22.81	22.0±1	1
				36	0	21.49	21.0±1	2
				36	24	21.52	21.0±1	2
				36	49	21.56	21.0±1	2
				75	0	21.61	21.0±1	2
	21375	2562.5	QPSK	1	0	22.3	23.0±1	0
				1	49	22.16	23.0±1	0
1				99	22.99	23.0±1	0	
36				0	21.05	22.0±1	1	
36				24	21.21	22.0±1	1	
36				49	21.96	22.0±1	1	
75				0	21.36	22.0±1	1	
16QAM			1	0	21.7	22.0±1	1	
			1	49	21.97	22.0±1	1	
			1	99	22.11	22.0±1	1	
			36	0	20.32	21.0±1	2	
			36	24	20.44	21.0±1	2	
			36	49	20.78	21.0±1	2	
			75	0	20.71	21.0±1	2	

BW(MHz)	Ch	Freq(MHz)	Mode	UL RB Allocation	UL RB Offset	Average Power (dbm)	Tune up limited(dBm)	MPR (dB)
20MHz	20850	2510	QPSK	1	0	23.31	23.0±1	0
				1	49	23.46	23.0±1	0
				1	99	23.27	23.0±1	0
				50	0	22.41	22.0±1	1
				50	24	22.47	22.0±1	1
				50	49	22.64	22.0±1	1
				100	0	22.57	22.0±1	1
			16QAM	1	0	22.87	22.0±1	1
				1	49	22.94	22.0±1	1
				1	99	22.82	22.0±1	1
				50	0	21.25	21.0±1	2
				50	24	21.9	21.0±1	2
				50	49	21.62	21.0±1	2
				100	0	21.86	21.0±1	2
	21100	2535	QPSK	1	0	23.46	23.0±1	0
				1	49	23.42	23.0±1	0
				1	99	23.5	23.0±1	0
				50	0	22.56	22.0±1	1
				50	24	22.54	22.0±1	1
				50	49	22.49	22.0±1	1
				100	0	22.53	22.0±1	1
			16QAM	1	0	22.99	22.0±1	1
				1	49	22.88	22.0±1	1
				1	99	22.72	22.0±1	1
				50	0	21.66	21.0±1	2
				50	24	21.58	21.0±1	2
				50	49	21.49	21.0±1	2
				100	0	21.53	21.0±1	2
	21350	2560	QPSK	1	0	22.85	23.0±1	0
				1	49	22.09	23.0±1	0
1				99	22.89	23.0±1	0	
50				0	22	22.0±1	1	
50				24	21.73	22.0±1	1	
50				49	21.96	22.0±1	1	
100				0	22.03	22.0±1	1	
16QAM			1	0	22.35	22.0±1	1	
			1	49	21.84	22.0±1	1	
			1	99	22.18	22.0±1	1	
			50	0	20.97	21.0±1	2	
			50	24	20.72	21.0±1	2	
			50	49	20.94	21.0±1	2	
			100	0	21	21.0±1	2	

WIFI Mode (2.4G)

Mode	Channel number	Frequency (MHz)	Data rate(Mbps)	Average Output Power(dBm)	Average Tune up limited(dBm)
802.11b	1	2412	1	9.43	8.6±1
	6	2437	1	9.16	8.6±1
	11	2462	1	9.24	8.6±1
802.11g	1	2412	6	9.41	8.6±1
	6	2437	6	9.46	8.6±1
	11	2462	6	9.34	8.6±1
802.11n(HT20)	1	2412	MCS0	9.25	8.6±1
	6	2437	MCS0	9.49	8.6±1
	11	2462	MCS0	9.51	8.6±1
802.11n(HT40)	3	2422	MCS0	9.45	8.6±1
	6	2437	MCS0	9.41	8.6±1
	9	2452	MCS0	9.43	8.6±1

Bluetooth Measurement Result

Mode	Frequency (MHz)	Output Power(dBm)	Tune up limited(dBm)
GFSK	2402	4.46	4.0±1
	2441	5.95	5.0±1
	2480	4.55	4.0±1
π/4DQPSK	2402	3.62	4.0±1
	2441	5.20	5.0±1
	2480	3.72	4.0±1
8DPSK	2402	3.89	4.0±1
	2441	5.41	5.0±1
	2480	3.81	4.0±1

BLE Measurement Result

Channel number	Frequency (MHz)	Output Power(dBm)	Tune up limited(dBm)
0	2402	-2.82	-2.5±1
19	2440	-1.85	-2.5±1
39	2480	-3.44	-2.5±1

12 EXPOSURE CONDITIONS CONSIDERATION

EUT antenna location:

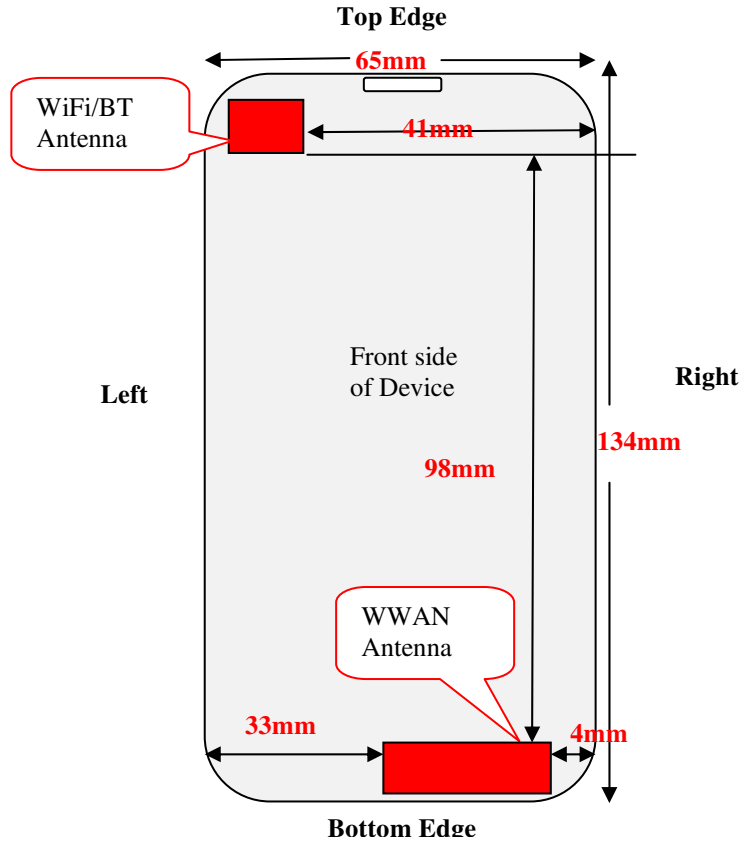

Test position consideration:

Distance of EUT antenna-to-edge/surface(mm), Test distance:10mm						
Antennas	Back side	Front side	Left Edge	Right Edge	Top Edge	Bottom Edge
WWAN	2	7	33	4	118	2
WLAN	2	7	2	41	3	116
Bluetooth	2	7	2	41	3	116

Test distance:10mm						
Antennas	Back side	Front side	Left Edge	Right Edge	Top Edge	Bottom Edge
WWAN	YES	YES	NO	YES	NO	YES
WLAN	NO	NO	NO	NO	NO	NO
Bluetooth	NO	NO	NO	NO	NO	NO

Note:

- Head/Body-worn/Hotspot mode SAR assessments are required.
- Referring to KDB 941225 D06v02r01, when the overall device length and width are $\geq 9\text{cm} * 5\text{cm}$, the test distance is 10mm. SAR must be measured for all sides and surfaces with a transmitting antenna located within 25mm from that surface or edge.
- Per KDB 447498 D01v06, for handsets the test separation distance is determined by the smallest distance between the outer surface of the device and the user, which is 0 mm for head SAR, 10 mm for hotspot SAR, and 10 mm for body-worn SAR.

RF Exposure

Standard Requirement:

According to §15.247 (i) and §1.1307(b)(1), systems operating under the provisions of this section shall be operated in a manner that ensures that the public is not exposed to radio frequency energy level in excess of the Commission's guidelines.

The 1-g and 10-g SAR test exclusion thresholds for 100 MHz to 6 GHz at *test separation distances* ≤ 50 mm are determined by:

$[(\text{max. power of channel, including tune-up tolerance, mW}) / (\text{min. test separation distance, mm})] \cdot [\sqrt{f_{\text{GHz}}}] \leq 3.0$ for 1-g SAR and ≤ 7.5 for 10-g extremity SAR,¹⁶ where

- f_{GHz} is the RF channel transmit frequency in GHz
- Power and distance are rounded to the nearest mW and mm before calculation¹⁷
- The result is rounded to one decimal place for comparison

The test exclusions are applicable only when the minimum *test separation distance* is ≤ 50 mm and for transmission frequencies between 100 MHz and 6 GHz. When the minimum *test separation distance* is < 5 mm, a distance of 5 mm is applied to determine SAR test exclusion.

Routine SAR evaluation refers to that specifically required by § 2.1093, using measurements or computer simulation. When routine SAR evaluation is not required, portable transmitters with output power greater than the applicable low threshold require SAR evaluation to qualify for TCB approval.

Exclusion Thresholds = $P\sqrt{F} / D$

P= Maximum turn-up power in mW

F= Channel frequency in GHz

D= Minimum test separation distance in mm

Test Distance (5mm)

Mode	MAX Power (dBm)	Tune Up Power (dBm)	Max Tune Up Power (dBm)	Max Tune Up Power (mW)	Exclusion Thresholds	Limit
WIF	9.51	8.6±1	9.6	9.12	2.862	3
Bluetooth	5.95	5.0±1	6.0	3.98	1.244	3
BLE	-1.85	-2.5±1	-1.5	0.71	0.222	3

Test Distance (10mm)

Mode	MAX Power (dBm)	Tune Up Power (dBm)	Max Tune Up Power (dBm)	Max Tune Up Power (mW)	Exclusion Thresholds	Limit
WIF	9.51	8.6±1	9.6	9.12	1.431	3
Bluetooth	5.95	5.0±1	6.0	3.98	0.622	3
BLE	-1.85	-2.5±1	-1.5	0.71	0.111	3

Result: Compliance

No SAR measurement is required.

13 SAR TEST RESULTS

Test Condition:

1. SAR Measurement
The distance between the EUT and the antenna of the emulator is more than 50 cm and the output power radiated from the emulator antenna is at least 30 dB less than the output power of EUT.
2. Environmental Conditions

Temperature	23°C
Relative Humidity	57%
Atmospheric Pressure	1019mbar
3. Test Date : Mar 30,2016-Apr 13,2016
Tested By : Damon Wang

Generally Test Procedures:

1. Establish communication link between EUT and base station emulation by air link.
2. Place the EUT in the selected test position. (Cheek, tilt or flat)
3. Perform SAR testing at middle or highest output power channel under the selected test mode. If the measured 1-g SAR is ≤ 0.8 W/kg, then testing for the other channel will not be performed.
4. When SAR is < 0.8 W/kg, no repeated SAR measurement is required

For WCDMA test:

1. KDB941225 D01-Body SAR is not required for HSDPA when the average output of each RF channel with HSDPA active is less than 0.25dB higher than measured without HSDPA using 12.2kbps RMC or the maximum SAR for 12.2kbps RMC $< 75\%$ of the SAR limit.
2. KDB941225 D01-Body SAR is not required for handset with HSPA capabilities when the maximum average output of each RF channel with HSUPA/HSDPA active is less than 0.25dB higher than that measure without HSUPA/HSDPA using 12.2kbps RMC AND THE maximum SAR for 12.2kbps RMC is $< 75\%$ of the SAR limit

For LTE test:

1. According to FCC KDB 941225 D05v02r05:
 - a. Per Section 5.2.1, SAR is required for QPSK 1 RB Allocation for the largest bandwidth
 - i. The required channel and offset combination with the highest maximum output power is required for SAR.
 - ii. When the reported SAR is ≤ 0.8 W/kg, testing of the remaining RB offset configurations and required test channels is not required. Otherwise, SAR is required for the remaining required test channels using the RB offset configuration with highest output power for that channel.
 - iii. When the reported SAR for a required test channel is > 1.45 W/kg, SAR is required for all RB offset configurations for that channel.
 - b. Per Section 5.2.2, SAR is required for 50% RB allocation using the largest bandwidth following the same procedures outlined in Section 5.2.1.
 - c. Per Section 5.2.3, QPSK SAR is not required for the 100% allocation when the highest maximum output power for the 100% allocation is less than the highest maximum output power of the 1 RB and 50% RB allocations and the reported SAR for the 1 RB and 50% RB allocations is < 0.8 W/kg.
 - d. Per Section 5.2.4 and 5.3, SAR tests for higher order modulations and lower bandwidths configurations are not required when the conducted power of the required test configurations determined by Sections 5.2.1 through 5.2.3 is less than or equal to $\frac{1}{2}$ dB higher than the equivalent configuration using QPSK modulation and when the QPSK SAR for those configurations is < 1.45 W/kg.
 - e. A-MPR was disabled for all SAR tests by setting NS=01 on the base station simulator. SAR tests were performed with the same number of RB and RB offsets transmitting on all TTI frames (maximum TTI).

SAR Summary Test Result:**Table 5: SAR Values of GSM 850MHz Band**

Test Positions		Channel		Test Mode	Power(dBm)		SAR 1g(W/Kg), Limit(1.6W/kg)		Plot No.
		CH.	MHz		Maximum Turn-up Power(dBm)	Measured output power(dBm)	Measured SAR 1g(W/kg)	Scaled SAR 1g(W/kg)	
Right Head	Cheek	190	836.6	Voice call	33	32.55	0.203	0.23	--
	Tilt	190	836.6	Voice call	33	32.55	0.125	0.14	--
Left Head	Cheek	190	836.6	Voice call	33	32.55	0.212	0.24	1
	Tilt	190	836.6	Voice call	33	32.55	0.147	0.16	--
Body-worn (10mm Separation)	Front side	190	836.6	Voice call	33	32.55	0.277	0.31	--
	Back side	190	836.6	Voice call	33	32.55	0.453	0.50	2
Hotspot (10mm Separation)	Front side	190	836.6	GPRS 3 slots	31.5	31.22	0.452	0.48	--
	Back side	190	836.6	GPRS 3 slots	31.5	31.22	0.673	0.72	3
	Right EDGE	190	836.6	GPRS 3 slots	31.5	31.22	0.315	0.34	--
	Bottom EDGE	190	836.6	GPRS 3 slots	31.5	31.22	0.079	0.08	--

Table 6: SAR Values of WCDMA BAND V

Test Positions		Channel		Test Mode	Power(dBm)		SAR 1g(W/Kg), Limit(1.6W/kg)		Plot No.
		CH.	MHz		Maximum Turn-up Power(dBm)	Measured output power(dBm)	Measured SAR 1g(W/kg)	Scaled SAR 1g(W/kg)	
Right Head	Cheek	4183	836.6	RMC 12.2kbps	23	22.37	0.133	0.15	--
	Tilt	4183	836.6	RMC 12.2kbps	23	22.37	0.069	0.08	--
Left Head	Cheek	4183	836.6	RMC 12.2kbps	23	22.37	0.155	0.18	4
	Tilt	4183	836.6	RMC 12.2kbps	23	22.37	0.085	0.10	--
Body-worn (10mm Separation)	Front side	4183	836.6	RMC 12.2kbps	23	22.37	0.190	0.22	--
	Back side	4183	836.6	RMC 12.2kbps	23	22.37	0.330	0.38	5
Hotspot (10mm Separation)	Front side	4183	836.6	RMC 12.2kbps	23	22.37	0.190	0.22	--
	Back side	4183	836.6	RMC 12.2kbps	23	22.37	0.330	0.38	5
	Right EDGE	4183	836.6	RMC 12.2kbps	23	22.37	0.134	0.15	--
	Bottom EDGE	4183	836.6	RMC 12.2kbps	23	22.37	0.035	0.04	--

Table 7: SAR Values of GSM 1900MHz Band

Test Positions		Channel		Test Mode	Power(dBm)		SAR 1g(W/Kg), Limit(1.6W/kg)		Plot No.
		CH.	MHz		Maximum Turn-up Power(dBm)	Measured output power(dBm)	Measured SAR 1g(W/kg)	Scaled SAR 1g(W/kg)	
Right Head	Cheek	661	1880	Voice call	30	29.79	0.126	0.13	--
	Tilt	661	1880	Voice call	30	29.79	0.019	0.02	--
Left Head	Cheek	661	1880	Voice call	30	29.79	0.143	0.15	6
	Tilt	661	1880	Voice call	30	29.79	0.021	0.02	--
Body-worn (10mm Separation)	Front side	661	1880	Voice call	30	29.79	0.237	0.25	--
	Back side	661	1880	Voice call	30	29.79	0.315	0.33	7
Hotspot (10mm Separation)	Front side	661	1880	GPRS 4 slots	26	25.88	0.329	0.34	--
	Back side	661	1880	GPRS 4 slots	26	25.88	0.392	0.40	--
	Right EDGE	661	1880	GPRS 4 slots	26	25.88	0.109	0.11	--
	Bottom EDGE	661	1880	GPRS 4 slots	26	25.88	0.474	0.49	8

Table 8: SAR Values of WCDMA BAND II

Test Positions		Channel		Test Mode	Power(dBm)		SAR 1g(W/Kg), Limit(1.6W/kg)		Plot No.
		CH.	MHz		Maximum Turn-up Power(dBm)	Measured output power(dBm)	Measured SAR 1g(W/kg)	Scaled SAR 1g(W/kg)	
Right Head	Cheek	9400	1880	RMC 12.2kbps	23	22.72	0.298	0.32	9
	Tilt	9400	1880	RMC 12.2kbps	23	22.72	0.041	0.04	--
Left Head	Cheek	9400	1880	RMC 12.2kbps	23	22.72	0.248	0.26	--
	Tilt	9400	1880	RMC 12.2kbps	23	22.72	0.046	0.05	--
Body-worn (10mm Separation)	Front side	9400	1880	RMC 12.2kbps	23	22.72	0.402	0.43	--
	Back side	9400	1880	RMC 12.2kbps	23	22.72	0.593	0.63	10
Hotspot (10mm Separation)	Front side	9400	1880	RMC 12.2kbps	23	22.72	0.402	0.43	--
	Back side	9400	1880	RMC 12.2kbps	23	22.72	0.593	0.63	--
	Right EDGE	9400	1880	RMC 12.2kbps	23	22.72	0.153	0.16	--
	Bottom EDGE	9400	1880	RMC 12.2kbps	23	22.72	0.660	0.70	11

Table 9: SAR Values of LTE BAND 2 , 20MHz ,QPSK

Test Mode	Test Positions		Channel		Power(dBm)		MPR (dB)	SAR 1g(W/Kg), Limit(1.6W/kg)		Plot No.	
			CH.	MHz	Maximum Turn-up Power(dBm)	Measured output power(dBm)		Measured SAR 1g(W/kg)	Scaled SAR 1g(W/kg)		
1RB #49	Right Head	Cheek	18900	1880	23	22.44	0	0.293	0.33	--	
		Tilt	18900	1880	23	22.44	0	0.069	0.08	--	
	Left Head	Cheek	18900	1880	23	22.44	0	0.327	0.37	12	
		Tilt	18900	1880	23	22.44	0	0.061	0.07	--	
	Body-worn (10mm Separation)	Front side	18900	1880	23	22.44	0	0.512	0.58	--	
		Back side	18900	1880	23	22.44	0	0.645	0.73	13	
	Hotspot (10mm Separation)	Front side	18900	1880	23	22.44	0	0.512	0.58	--	
		Back side	18900	1880	23	22.44	0	0.645	0.73	--	
		Right EDGE	18900	1880	23	22.44	0	0.196	0.22	--	
		Bottom EDGE	18900	1880	23	22.44	0	0.788	0.90	14	
	50%RB #0	Right Head	Cheek	18900	1880	22	21.44	1	0.267	0.30	--
			Tilt	18900	1880	22	21.44	1	0.050	0.06	--
Left Head		Cheek	18900	1880	22	21.44	1	0.302	0.34	--	
		Tilt	18900	1880	22	21.44	1	0.050	0.06	--	
Body-worn (10mm Separation)		Front side	18900	1880	22	21.44	1	0.461	0.52	--	
		Back side	18900	1880	22	21.44	1	0.597	0.68	--	
Hotspot (10mm Separation)		Front side	18900	1880	22	21.44	1	0.461	0.52	--	
		Back side	18900	1880	22	21.44	1	0.597	0.68	--	
		Right EDGE	18900	1880	22	21.44	1	0.190	0.22	--	
		Bottom EDGE	18900	1880	22	21.44	1	0.722	0.82	--	

Table 10: SAR Values of LTE BAND 4 , 20MHz ,QPSK

Test Mode	Test Positions		Channel		Power(dBm)		MPR (dB)	SAR 1g(W/Kg), Limit(1.6W/kg)		Plot No.	
			CH.	MHz	Maximum Turn-up Power(dBm)	Measured output power(dBm)		Measured SAR 1g(W/kg)	Scaled SAR 1g(W/kg)		
1RB #49	Right Head	Cheek	20175	1732.5	23	22.53	0	0.243	0.27	15	
		Tilt	20175	1732.5	23	22.53	0	0.029	0.03	--	
	Left Head	Cheek	20175	1732.5	23	22.53	0	0.194	0.22	--	
		Tilt	20175	1732.5	23	22.53	0	0.039	0.04	--	
	Body-worn (10mm Separation)	Front side	20175	1732.5	23	22.53	0	0.278	0.31	--	
		Back side	20175	1732.5	23	22.53	0	0.559	0.62	16	
	Hotspot (10mm Separation)	Front side	20175	1732.5	23	22.53	0	0.278	0.31	--	
		Back side	20175	1732.5	23	22.53	0	0.559	0.62	16	
		Right EDGE	20175	1732.5	23	22.53	0	0.139	0.15	--	
		Bottom EDGE	20175	1732.5	23	22.53	0	0.450	0.50	--	
	50%RB #0	Right Head	Cheek	20175	1732.5	23	22.58	0	0.225	0.25	--
			Tilt	20175	1732.5	23	22.58	0	0.030	0.03	--
Left Head		Cheek	20175	1732.5	23	22.58	0	0.166	0.18	--	
		Tilt	20175	1732.5	23	22.58	0	0.033	0.04	--	
Body-worn (10mm Separation)		Front side	20175	1732.5	23	22.58	0	0.289	0.32	--	
		Back side	20175	1732.5	23	22.58	0	0.540	0.59	--	
Hotspot (10mm Separation)		Front side	20175	1732.5	23	22.58	0	0.289	0.32	--	
		Back side	20175	1732.5	23	22.58	0	0.540	0.59	--	
		Right EDGE	20175	1732.5	23	22.58	0	0.145	0.16	--	
		Bottom EDGE	20175	1732.5	23	22.58	0	0.458	0.50	--	

Table 11: SAR Values of LTE BAND 7 , 20MHz ,QPSK

Test Mode	Test Positions		Channel		Power(dBm)		MPR (dB)	SAR 1g(W/Kg), Limit(1.6W/kg)		Plot No.	
			CH.	MHz	Maximum Turn-up Power(dBm)	Measured output power(dBm)		Measured SAR 1g(W/kg)	Scaled SAR 1g(W/kg)		
1RB #49	Right Head	Cheek	21100	2535	24	23.42	0	0.037	0.04	17	
		Tilt	21100	2535	24	23.42	0	0.011	0.01	--	
	Left Head	Cheek	21100	2535	24	23.42	0	0.023	0.03	--	
		Tilt	21100	2535	24	23.42	0	0.016	0.02	--	
	Body-worn (10mm Separation)	Front side	21100	2535	24	23.42	0	0.113	0.13	--	
		Back side	21100	2535	24	23.42	0	0.310	0.35	18	
	Hotspot (10mm Separation)	Front side	21100	2535	24	23.42	0	0.113	0.13	--	
		Back side	21100	2535	24	23.42	0	0.310	0.35	--	
		Right EDGE	21100	2535	24	23.42	0	0.055	0.06	--	
		Bottom EDGE	21100	2535	24	23.42	0	0.461	0.53	19	
	50%RB #0	Right Head	Cheek	21100	2535	23	22.54	1	0.035	0.04	--
			Tilt	21100	2535	23	22.54	1	0.009	0.01	--
Left Head		Cheek	21100	2535	23	22.54	1	0.019	0.02	--	
		Tilt	21100	2535	23	22.54	1	0.015	0.02	--	
Body-worn (10mm Separation)		Front side	21100	2535	23	22.54	1	0.102	0.11	--	
		Back side	21100	2535	23	22.54	1	0.287	0.32	--	
Hotspot (10mm Separation)		Front side	21100	2535	23	22.54	1	0.102	0.11	--	
		Back side	21100	2535	23	22.54	1	0.287	0.32	--	
		Right EDGE	21100	2535	23	22.54	1	0.053	0.06	--	
		Bottom EDGE	21100	2535	23	22.54	1	0.289	0.32	--	

- Note:**1. KDB941225 D01-Body SAR is not required for HSDPA when the average output of each RF channel with HSDPA active is less than 0.25dB higher than measured without HSDPA using 12.2kbps RMC or the maximum SAR for 12.2kbps RMC<75% of the SAR limit.
2. KDB941225 D01-Body SAR is not required for handset with HSPA capabilities when the maximum average output of each RF channel with HSUPA/HSDPA active is less than 0.25dB higher than that measure without HSUPA/HSDPA using 12.2kbps RMC AND THE maximum SAR for 12.2kbps RMC is<75% of the SAR limit

Measurement variability consideration

According to KDB 865664 D01v01r04 section 2.8.1, repeated measurements are required following the procedures as below:

1. Repeated measurement is not required when the original highest measured SAR is < 0.80W/kg; steps 2) through 4) do not apply.
2. When the original highest measured SAR is ≥ 0.80 W/kg, repeat that measurement once.
3. Perform a second repeated measurement only if the ratio of largest to smallest SAR for the original and first repeated measurements is > 1.20 or when the original or repeated measurement is ≥ 1.45 W/kg (~ 10% from the 1-g SAR limit).
4. Perform a third repeated measurement only if the original, first or second repeated measurement is ≥ 1.5 W/kg and the ratio of largest to smallest SAR for the original, first and second repeated measurements is > 1.20 .

No Repeated SAR

Simultaneous Transmission SAR Analysis.

List of Mode for Simultaneous Multi-band Transmission:

No.	Configurations	Head SAR	Body-worn SAR	Hotspot SAR
1	GSM(Voice) + WLAN 2.4GHz(Data)	Yes	Yes	-
2	GPRS (Data) + WLAN 2.4GHz(Data)	-	-	Yes
3	GSM(Voice) + Bluetooth(Data)	Yes	Yes	-
4	GPRS (Data) + Bluetooth(Data)	-	-	Yes
5	WCDMA (Voice) + WLAN 2.4GHz(Data)	Yes	Yes	-
6	WCDMA (Data) + WLAN 2.4GHz(Data)	-	-	Yes
7	WCDMA (Voice) + Bluetooth(Data)	Yes	Yes	-
8	WCDMA (Data) + Bluetooth(Data)	-	-	Yes
9	LTE (Data) + Bluetooth(Data)	Yes	Yes	Yes

Remark:

1. GSM and WCDMA share the same antenna, and cannot transmit simultaneously.
2. WLAN and Bluetooth share the same antenna, and cannot transmit simultaneously.
3. According to the KDB 447498 D01 v06, when standalone SAR test exclusion applies to an antenna that transmits simultaneously with other antennas, the standalone SAR must be estimated according to following to determine simultaneous transmission SAR test exclusion:

(max. power of channel, including tune-up tolerance, mW)/(min. test separation distance, mm) • [√ f(GHz)/x] W/kg for test separation distances ≤ 50 mm;

where x = 7.5 for 1-g SAR, and x = 18.75 for 10-g SAR.

For simultaneous transmission analysis, Bluetooth SAR is estimated per KDB 447498 D01 v06 as below:

WIFI:

Tune-Up Power (dBm)	Max. Power (mW)	Distance (mm)	Frequency (GHz)	X	SAR(1g) 5mm	SAR(1g) 10mm
9.6	9.12	5/10	2.462	7.5	0.38	0.19

Bluetooth:

Tune-Up Power (dBm)	Max. Power (mW)	Distance (mm)	Frequency (GHz)	X	SAR(1g) 5mm	SAR(1g) 10mm
6.0	3.98	5/10	2.441	7.5	0.17	0.08

4. The maximum SAR summation is calculated based on the same configuration and test position

Head SAR**WWAN and WLAN (2.4GHz)**

Position	WWAN (maximum)		WLAN(5mm)	Summed SAR (W/kg)
	Band	Scaled SAR (W/kg)	Scaled SAR (W/kg)	
Left Cheek	GSM850	0.24	0.38	0.62
Left Cheek	GSM1900	0.15	0.38	0.53
Left Cheek	WCDMA Band V	0.18	0.38	0.56
Right Cheek	WCDMA Band II	0.32	0.38	0.70
Left Cheek	LTE BAND 2(1RB)	0.37	0.38	0.75
Right Cheek	LTE BAND 4(1RB)	0.27	0.38	0.65
Right Cheek	LTE BAND 7(1RB)	0.04	0.38	0.42

WWAN and BT

Position	WWAN (maximum)		WLAN(5mm)	Summed SAR (W/kg)
	Band	Scaled SAR (W/kg)	Scaled SAR (W/kg)	
Left Cheek	GSM850	0.24	0.17	0.41
Left Cheek	GSM1900	0.15	0.17	0.32
Left Cheek	WCDMA Band V	0.18	0.17	0.35
Right Cheek	WCDMA Band II	0.32	0.17	0.49
Left Cheek	LTE BAND 2(1RB)	0.37	0.17	0.54
Right Cheek	LTE BAND 4(1RB)	0.27	0.17	0.44
Right Cheek	LTE BAND 7(1RB)	0.04	0.17	0.21

Remark: WIFI/BT the 1g SAR value is not being captured by the measurement system, the 1g-SAR value is conservatively used for simultaneous transmission analysis.

Body-worn SAR**WWAN and WLAN (2.4GHz)**

Position	WWAN (maximum)		WLAN(10mm)	Summed SAR (W/kg)
	Band	Scaled SAR (W/kg)	Scaled SAR (W/kg)	
Back	GSM850	0.50	0.19	0.69
Back	GSM1900	0.33	0.19	0.52
Back	WCDMA Band V	0.38	0.19	0.57
Back	WCDMA Band II	0.63	0.19	0.82
Back	LTE BAND 2(1RB)	0.73	0.19	0.92
Back	LTE BAND 4(1RB)	0.62	0.19	0.81
Back	LTE BAND 7(1RB)	0.35	0.19	0.54

WWAN and BT

Position	WWAN (maximum)		WLAN(10mm)	Summed SAR (W/kg)
	Band	Scaled SAR (W/kg)	Scaled SAR (W/kg)	
Back	GSM850	0.50	0.08	0.58
Back	GSM1900	0.33	0.08	0.41
Back	WCDMA Band V	0.38	0.08	0.46
Back	WCDMA Band II	0.63	0.08	0.71
Back	LTE BAND 2(1RB)	0.73	0.08	0.81
Back	LTE BAND 4(1RB)	0.62	0.08	0.70
Back	LTE BAND 7(1RB)	0.35	0.08	0.43

Remark: WIFI/BT the 1g SAR value is not being captured by the measurement system, the 1g-SAR value is conservatively used for simultaneous transmission analysis.

Hotspot SAR**WWAN and WLAN (2.4GHz)**

Position	WWAN (maximum)		WLAN(10mm)	Summed SAR (W/kg)
	Band	Scaled SAR (W/kg)	Scaled SAR (W/kg)	
Back	GSM850	0.72	0.19	0.91
Bottom side	GSM1900	0.49	0.19	0.68
Back	WCDMA Band V	0.38	0.19	0.57
Bottom side	WCDMA Band II	0.70	0.19	0.89
Bottom side	LTE BAND 2(1RB)	0.90	0.19	1.09
Back	LTE BAND 4(1RB)	0.62	0.19	0.81
Bottom side	LTE BAND 7(1RB)	0.53	0.19	0.72

WWAN and BT

Position	WWAN (maximum)		WLAN(10mm)	Summed SAR (W/kg)
	Band	Scaled SAR (W/kg)	Scaled SAR (W/kg)	
Back	GSM850	0.72	0.08	0.80
Bottom side	GSM1900	0.49	0.08	0.57
Back	WCDMA Band V	0.38	0.08	0.46
Bottom side	WCDMA Band II	0.70	0.08	0.78
Bottom side	LTE BAND 2(1RB)	0.90	0.08	0.98
Back	LTE BAND 4(1RB)	0.62	0.08	0.70
Bottom side	LTE BAND 7(1RB)	0.53	0.08	0.61

Remark: WIFI/BT the 1g SAR value is not being captured by the measurement system, the 1g-SAR value is conservatively used for simultaneous transmission analysis.

14 SAR MEASUREMENT REFERENCES

References

- 1. FCC 47 CFR Part 2 “Frequency Allocations and Radio Treaty Matters; General Rules and Regulations”**
- 2. IEEE Std. C95.1-2005, “IEEE Standard for Safety Levels with Respect to Human Exposure to Radio Frequency Electromagnetic Fields, 3kHz to 300GHz”, 2005**
- 3. IEEE Std. 1528-2013, “IEEE Recommended Practice for Determining the Peak Spatial-Average Specific Absorption Rate (SAR) in the Human Head from Wireless Communications Devices: Measurement Techniques”, June 2013**
- 4. IEC 62209-2, “Human exposure to radio frequency fields from hand-held and body-mounted wireless communication devices—Human models, instrumentation, and procedures – Part 2: Procedure to determine the specific absorption rate(SAR) for wireless communication devices used in close proximity to the human body(frequency range of 30MHz to 6GHz)”, April 2010**
- 5. FCC KDB 447498 D01 v06, “Mobile and Portable Device RF Exposure Procedures and Equipment Authorization Policies”, Oct 23th, 2015**
- 6. FCC KDB 941225 D01 v03r01, “3G SAR Measurement Procedures”, Oct 23th, 2015**
- 7. FCC KDB 941225 D05 v02r05, “SAR Evaluation Considerations for LTE Devices”, Dec 16th, 2015**
- 8. FCC KDB 941225 D06 v02r01, “SAR Evaluation Procedures for Portable Devices with Wireless Router Capabilities”, Oct 23th, 2015**
- 9. FCC KDB865664 D01 v01r04, “SAR Measurement Requirements 100MHz to 6GHz”, Aug 7th, 2015**
- 10. FCC KDB865664 D02 v01r02, “RF Exposure Compliance Reporting and Documentation Considerations ”, Oct 23th, 2015**
- 11. FCC KDB648474 D04 v01r03, “SAR Evaluation Considerations for Wireless Handsets”, Oct 23th, 2015**
- 12. FCC KDB 248227 D01 v01r02, SAR Guidance for IEEE 802.11 (Wi-Fi) Transmitters, Oct 23th, 2015.**

Maximum SAR measurement Plots

Plot 1: GSM850MHz, Middle channel (Left Head , Cheek)

Product Description: Mobile Phone

Model: iris 758

Test Date: Mar 30, 2016

Medium (liquid type)	HSL_850
Frequency (MHz)	836.60000
Relative permittivity (real part)	41.33
Conductivity (S/m)	0.91
Signal	GSM (Duty cycle: 1:8)
E-Field Probe	SN 07/15 EP249
Conversion Factor	5.26
Area Scan	dx=8mm dy=8mm
Zoom Scan	5x5x7, dx=8mm dy=8mm dz=5mm
Variation (%)	0.99
SAR 10g (W/Kg)	0.158380
SAR 1g (W/Kg)	0.212295
SURFACE SAR	VOLUME SAR

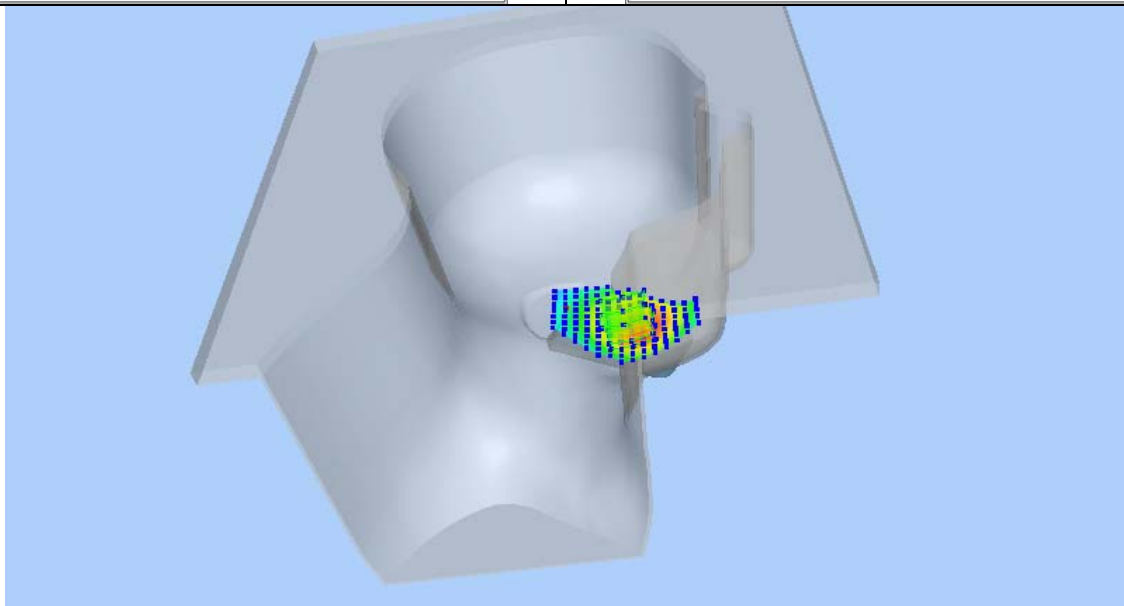
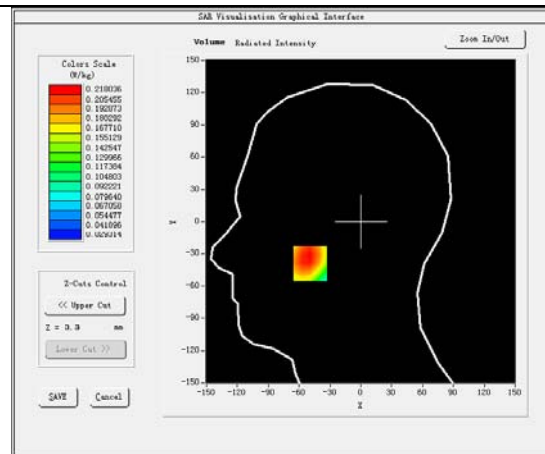
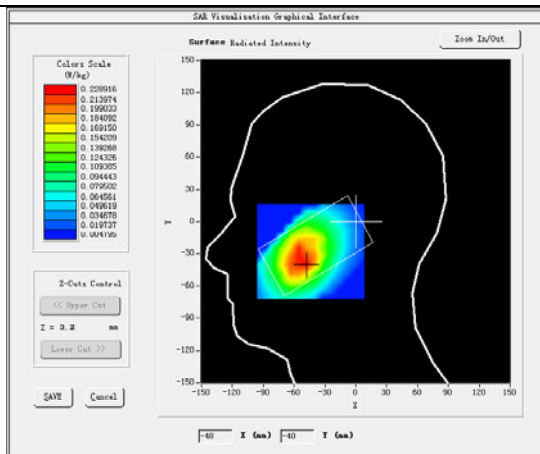

Plot 2: GSM850MHz, Middle channel (Body-worn, Back Surface)**Product Description:Mobile Phone****Model:iris 758****Test Date: Mar 30,2016**

Medium(liquid type)	MSL_850
Frequency (MHz)	836.60000
Relative permittivity (real part)	55.44
Conductivity (S/m)	0.98
Signal	GSM (Duty cycle: 1:8)
E-Field Probe	SN 07/15 EP249
Conversion Factor	5.46
Area Scan	dx=8mm dy=8mm
Zoom Scan	5x5x7,dx=8mm dy=8mm dz=5mm
Variation (%)	-1.69
SAR 10g (W/Kg)	0.329309
SAR 1g (W/Kg)	0.453312

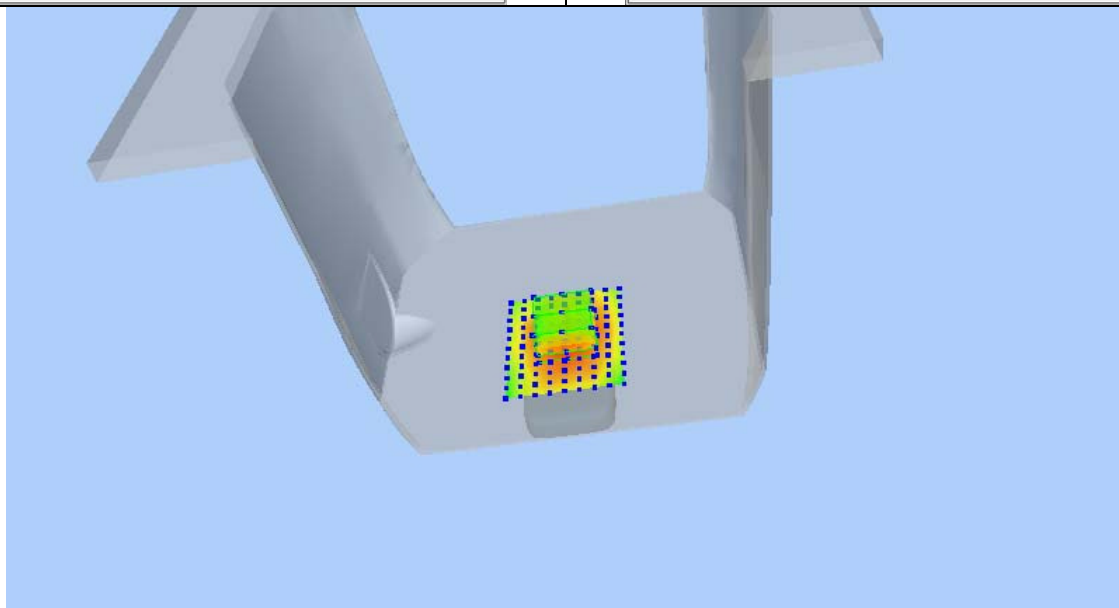
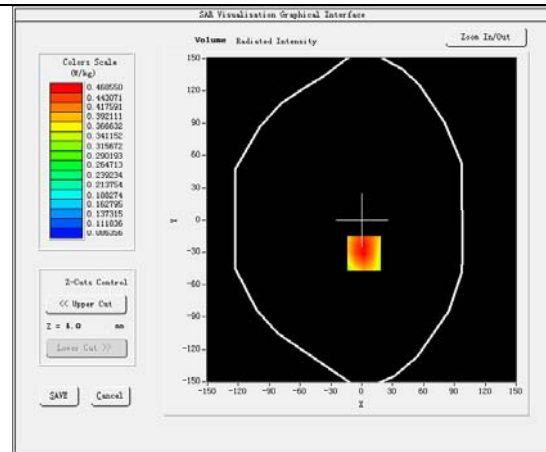
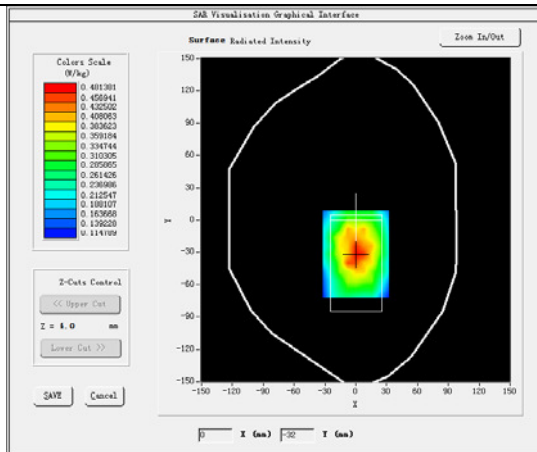
SURFACE SAR**VOLUME SAR**

Plot 3: GPRS850MHz, Middle channel (Hotspot, Back Surface)**Product Description: Mobile Phone****Model: iris 758****Test Date: Mar 30,2016**

Medium(liquid type)	MSL_850
Frequency (MHz)	836.60000
Relative permittivity (real part)	55.44
Conductivity (S/m)	0.98
Signal	GPRS (Duty cycle: 1:2.66)
E-Field Probe	SN 07/15 EP249
Conversion Factor	5.46
Area Scan	dx=8mm dy=8mm
Zoom Scan	5x5x7,dx=8mm dy=8mm dz=5mm
Variation (%)	3.91
SAR 10g (W/Kg)	0.516419
SAR 1g (W/Kg)	0.672809

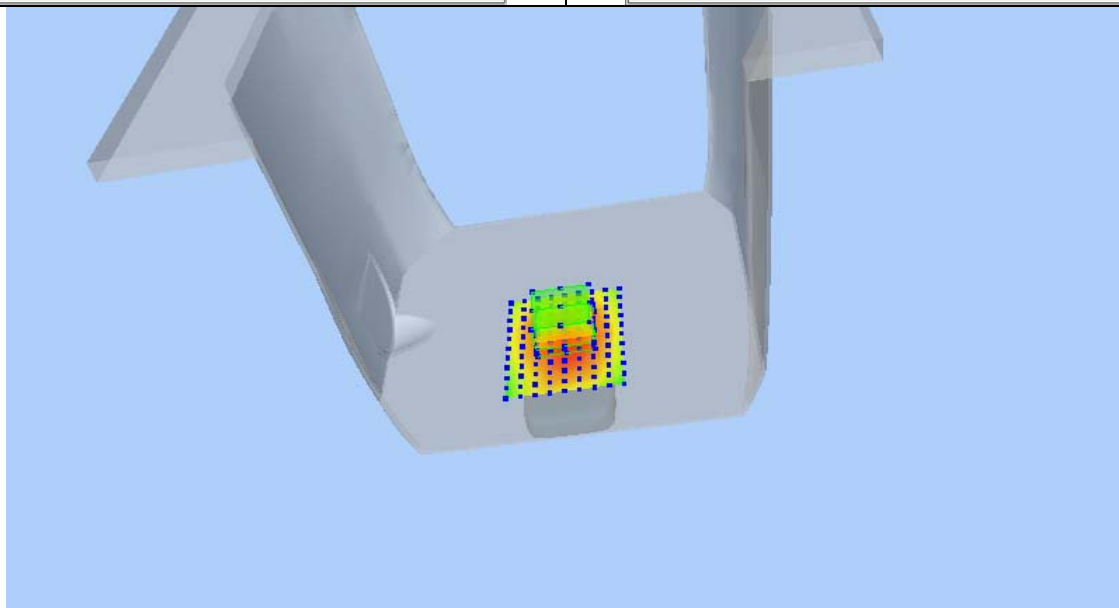
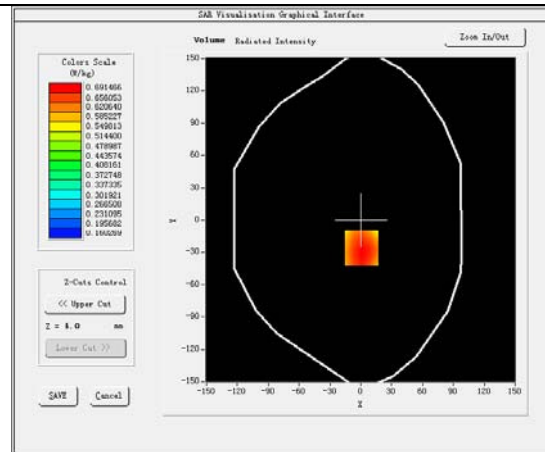
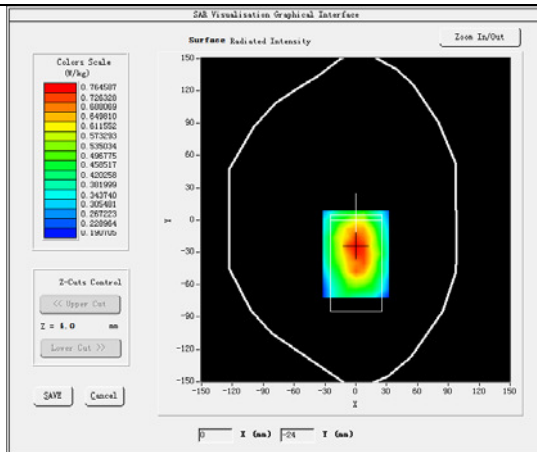
SURFACE SAR**VOLUME SAR**

Plot 4: WCDMA BAND V , Middle channel (Left Head Cheek)

Product Description: Mobile Phone

Model: iris 758

Test Date: Mar 30,2016

Medium(liquid type)	HSL_850
Frequency (MHz)	836.6000
Relative permittivity (real part)	41.33
Conductivity (S/m)	0.91
Signal	WCDMA (Duty cycle: 1:1)
E-Field Probe	SN 07/15 EP249
Conversion Factor	5.26
Sensor-Surface	4mm
Area Scan	dx=8mm dy=8mm
Zoom Scan	5x5x7,dx=8mm dy=8mm dz=5mm
Variation (%)	1.18
SAR 10g (W/Kg)	0.112606
SAR 1g (W/Kg)	0.154958

SURFACE SAR

VOLUME SAR

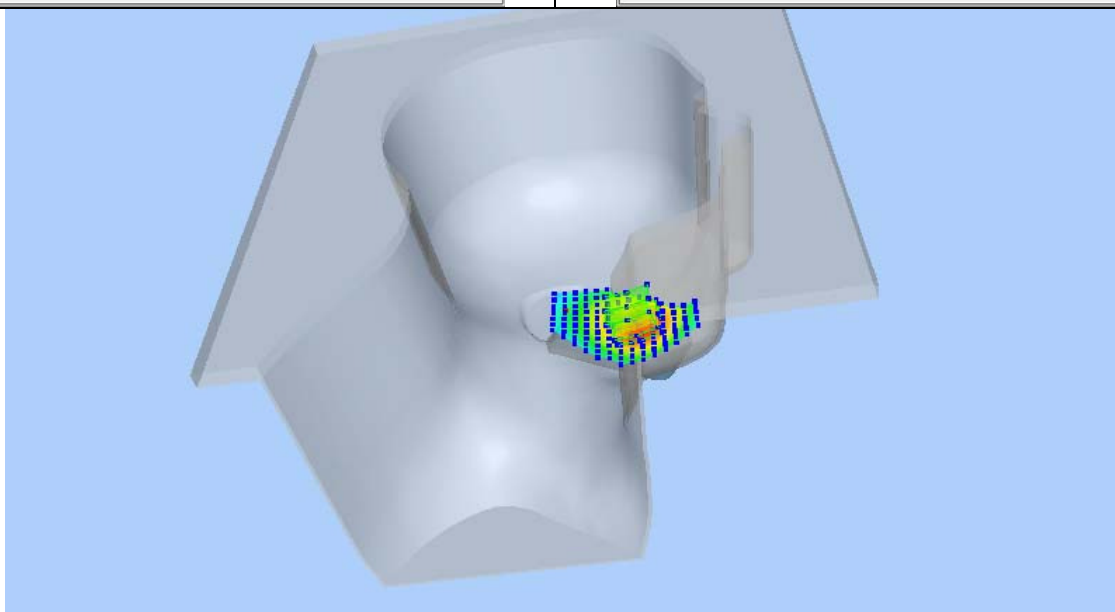
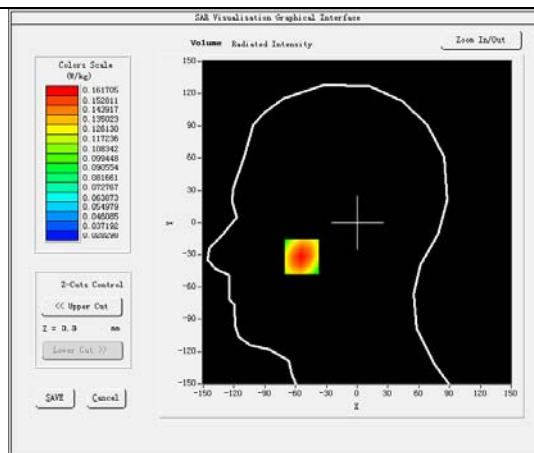
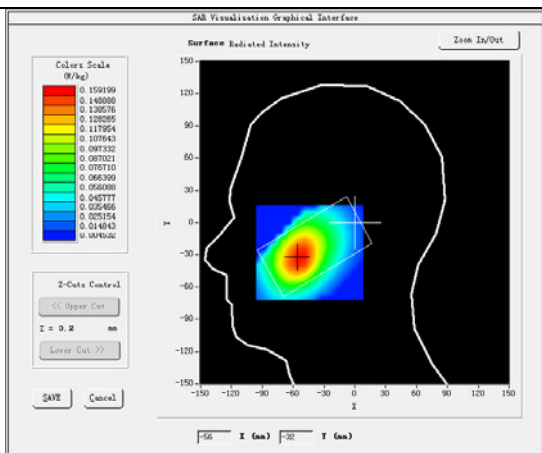

Plot 5: WCDMA BAND V , Middle channel (Body-worn/Hotspot, Back Surface)**Product Description: Mobile Phone****Model: iris 758****Test Date: Mar 30,2016**

Medium(liquid type)	MSL_850
Frequency (MHz)	836.6000
Relative permittivity (real part)	55.44
Conductivity (S/m)	0.98
Signal	WCDMA (Duty cycle: 1:1)
E-Field Probe	SN 07/15 EP249
Conversion Factor	5.46
Sensor-Surface	4mm
Area Scan	dx=8mm dy=8mm
Zoom Scan	5x5x7,dx=8mm dy=8mm dz=5mm
Variation (%)	0.17
SAR 10g (W/Kg)	0.239881
SAR 1g (W/Kg)	0.329970

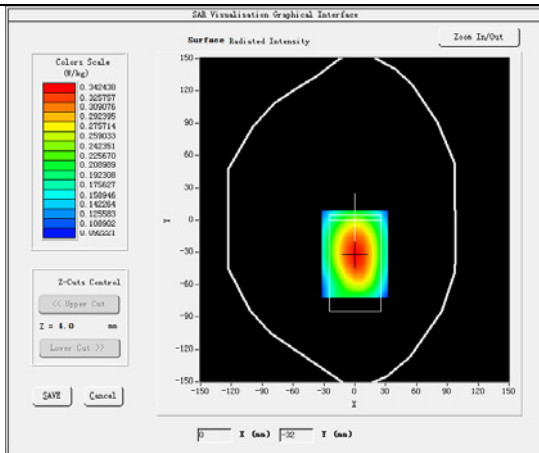
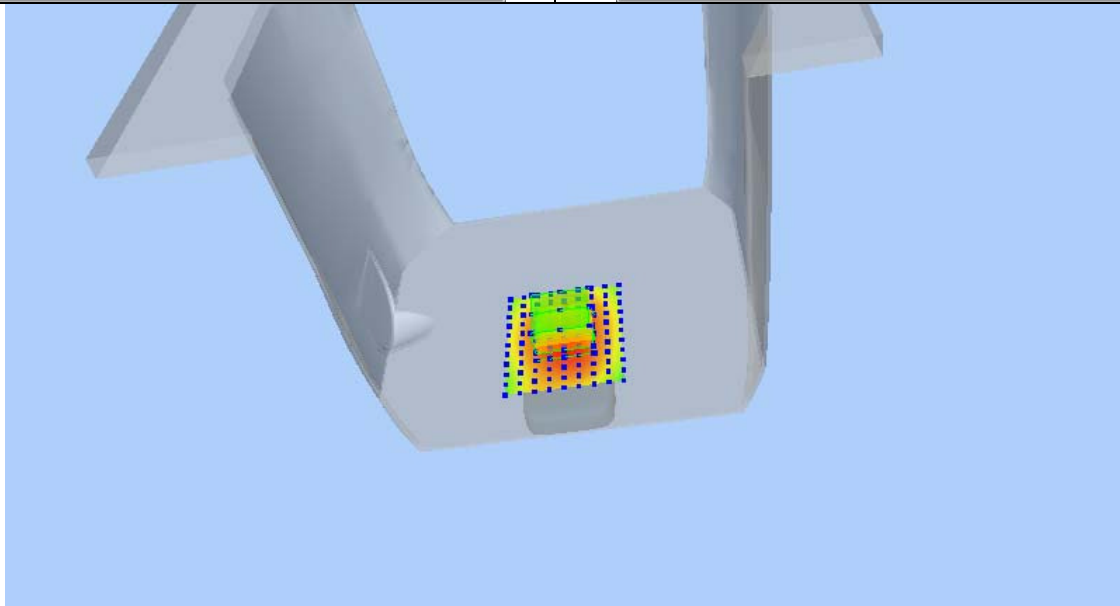
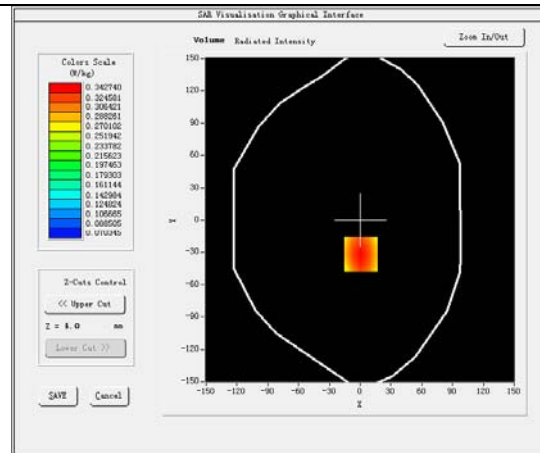
SURFACE SAR**VOLUME SAR**

Plot 6: GSM1900, Middle channel (Left Head Cheek)**Product Description: Mobile Phone****Model: iris 758****Test Date: Apr 13,2016**

Medium(liquid type)	HSL_1900
Frequency (MHz)	1880.0000
Relative permittivity (real part)	41.04
Conductivity (S/m)	1.41
Signal	GSM (Duty cycle: 1:8)
E-Field Probe	SN 07/15 EP249
Conversion Factor	4.95
Sensor-Surface	4mm
Area Scan	dx=8mm dy=8mm
Zoom Scan	5x5x7,dx=8mm dy=8mm dz=5mm
Variation (%)	0.12
SAR 10g (W/Kg)	0.081979
SAR 1g (W/Kg)	0.142872

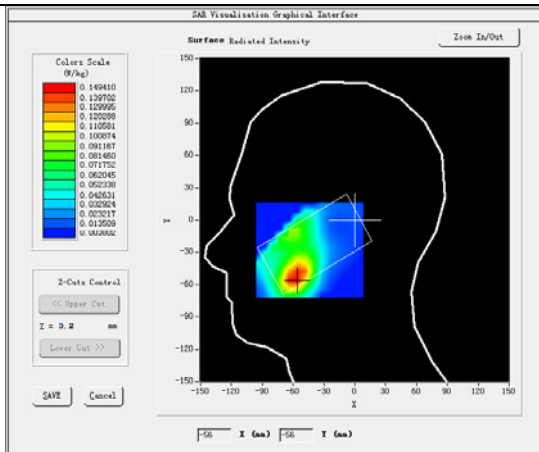
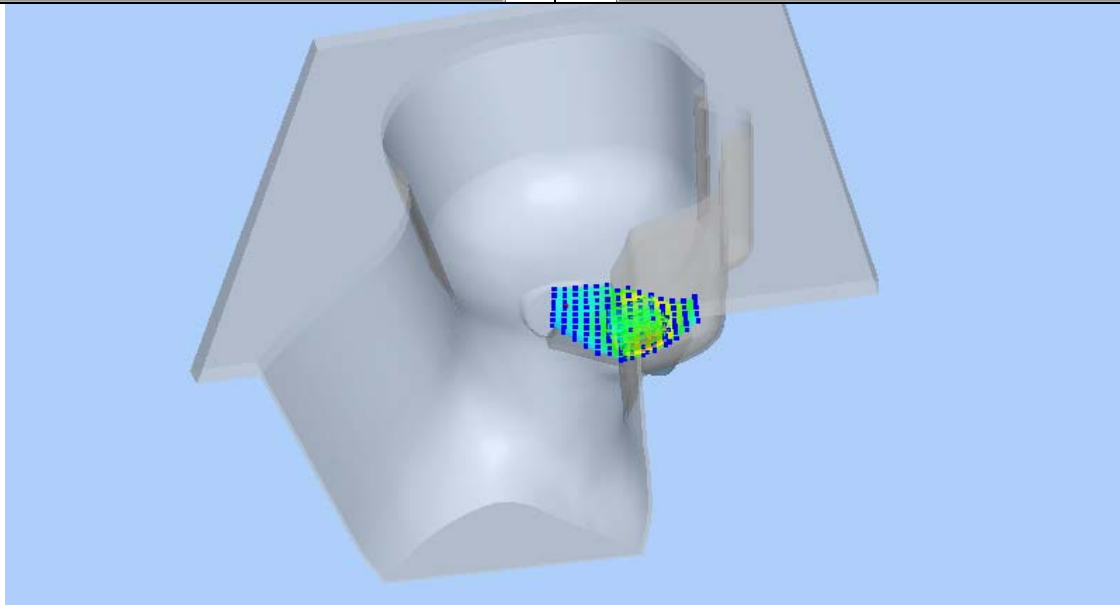
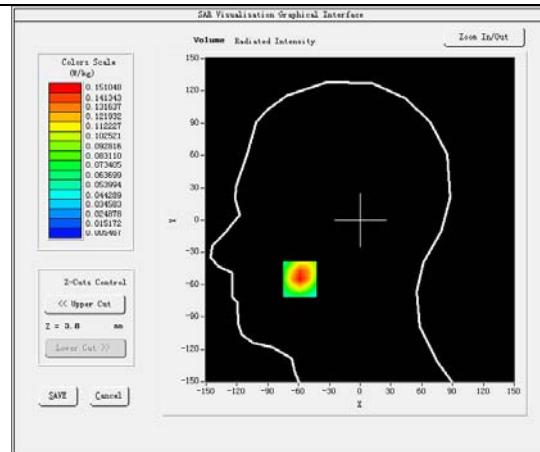
SURFACE SAR**VOLUME SAR**

Plot 7: GSM1900, Middle channel (Body-worn, Back Surface)**Product Description: Mobile Phone****Model: iris 758****Test Date: Apr 13,2016**

Medium(liquid type)	MSL_1900
Frequency (MHz)	1880.0000
Relative permittivity (real part)	53.51
Conductivity (S/m)	1.50
Signal	GSM (Duty cycle: 1:8)
E-Field Probe	SN 07/15 EP249
Conversion Factor	5.05
Sensor-Surface	4mm
Area Scan	dx=8mm dy=8mm
Zoom Scan	5x5x7,dx=8mm dy=8mm dz=5mm
Variation (%)	-2.41
SAR 10g (W/Kg)	0.192276
SAR 1g (W/Kg)	0.314725

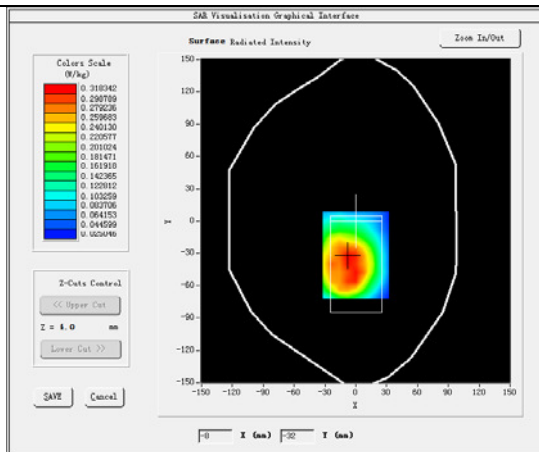
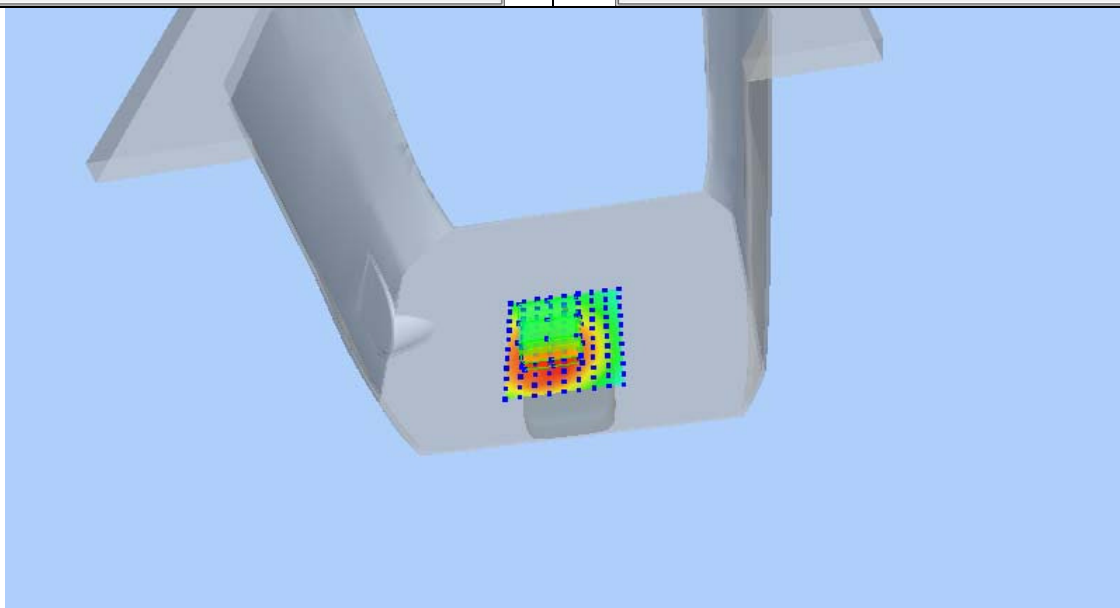
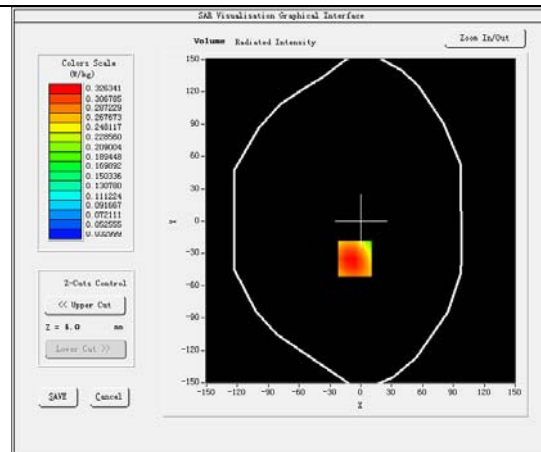
SURFACE SAR**VOLUME SAR**

Plot 8: GPRS1900, Middle channel (Hotspot, Bottom Edge)**Product Description: Mobile Phone****Model: iris 758****Test Date: Apr 13,2016**

Medium(liquid type)	MSL_1900
Frequency (MHz)	1880.0000
Relative permittivity (real part)	53.51
Conductivity (S/m)	1.50
Signal	GPRS (Duty cycle: 1:2)
E-Field Probe	SN 07/15 EP249
Conversion Factor	5.05
Sensor-Surface	4mm
Area Scan	dx=8mm dy=8mm
Zoom Scan	5x5x7,dx=8mm dy=8mm dz=5mm
Variation (%)	-0.96
SAR 10g (W/Kg)	0.253798
SAR 1g (W/Kg)	0.473936

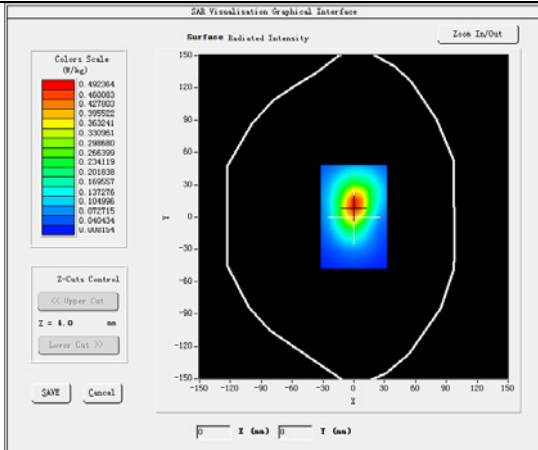
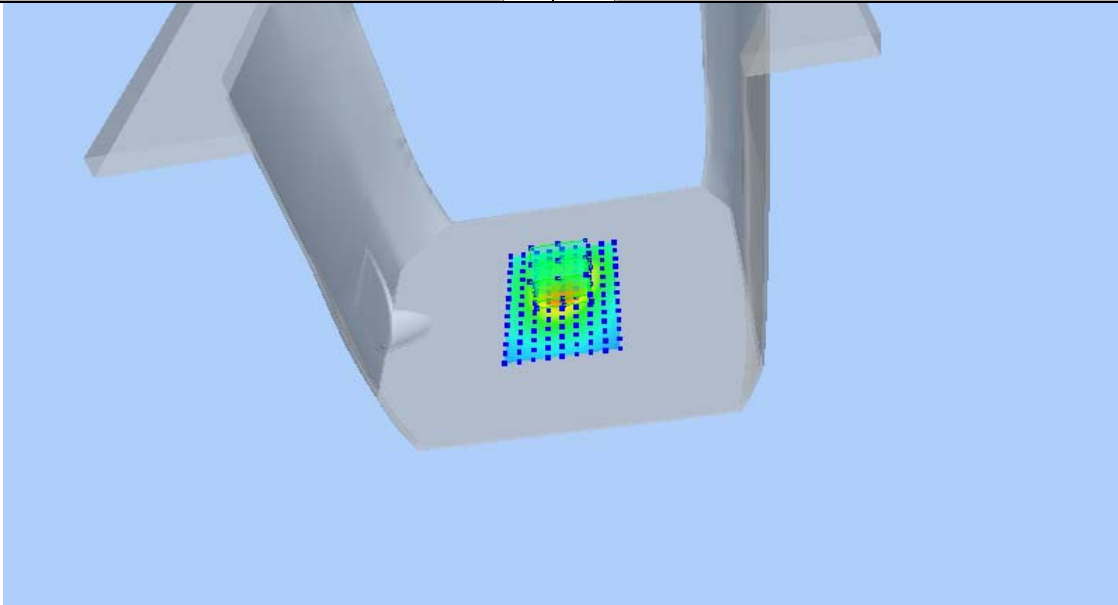
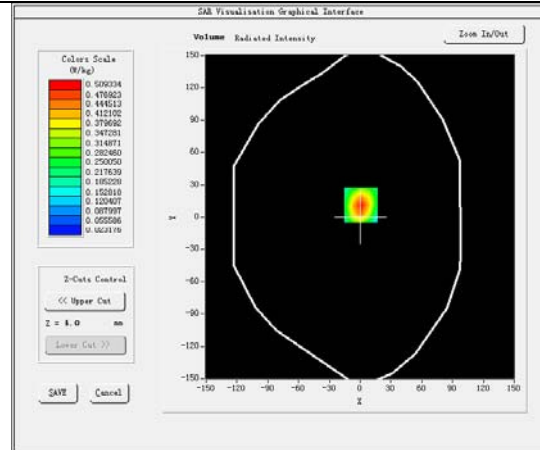
SURFACE SAR**VOLUME SAR**

Plot 9: WCDMA BAND II , Middle channel (Right Head Cheek)**Product Description: Mobile Phone****Model: iris 758****Test Date: Apr 13,2016**

Medium(liquid type)	HSL_1900
Frequency (MHz)	1880.0000
Relative permittivity (real part)	41.04
Conductivity (S/m)	1.41
Signal	WCDMA(Duty cycle: 1:1)
E-Field Probe	SN 07/15 EP249
Conversion Factor	4.95
Sensor-Surface	4mm
Area Scan	dx=8mm dy=8mm
Zoom Scan	5x5x7,dx=8mm dy=8mm dz=5mm
Variation (%)	-0.10
SAR 10g (W/Kg)	0.168773
SAR 1g (W/Kg)	0.298188

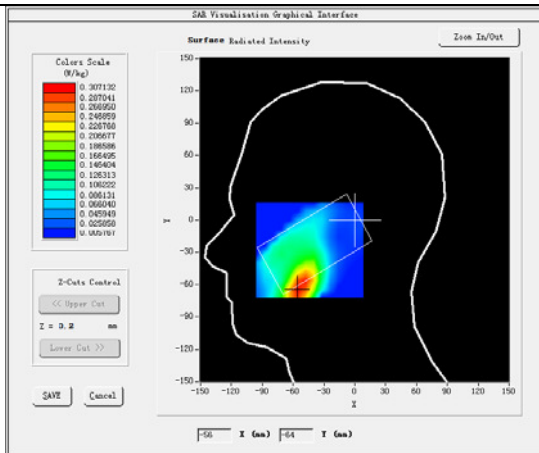
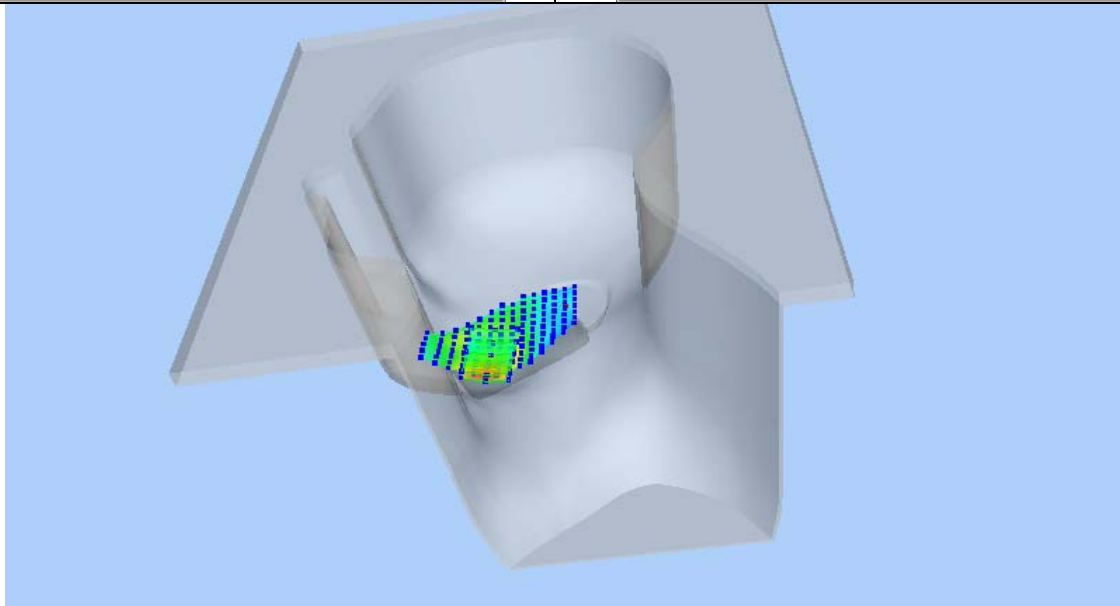
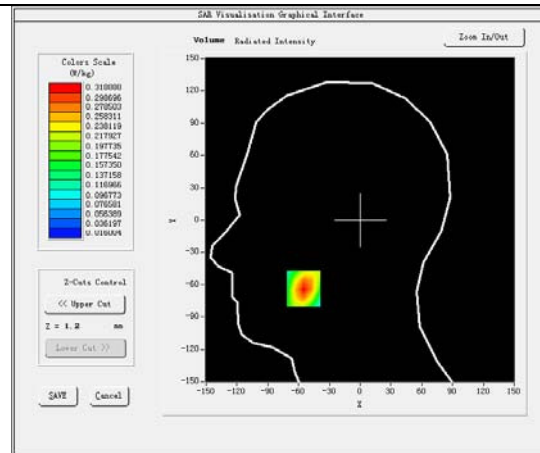
SURFACE SAR**VOLUME SAR**

Plot 10: WCDMA BAND II , Middle channel (Body-worn, Back Surface)**Product Description: Mobile Phone****Model: iris 758****Test Date: Apr 13,2016**

Medium(liquid type)	MSL_1900
Frequency (MHz)	1880.0000
Relative permittivity (real part)	53.51
Conductivity (S/m)	1.50
Signal	WCDMA(Duty cycle: 1:1)
E-Field Probe	SN 07/15 EP249
Conversion Factor	5.05
Sensor-Surface	4mm
Area Scan	dx=8mm dy=8mm
Zoom Scan	5x5x7,dx=8mm dy=8mm dz=5mm
Variation (%)	-0.84
SAR 10g (W/Kg)	0.361216
SAR 1g (W/Kg)	0.592930

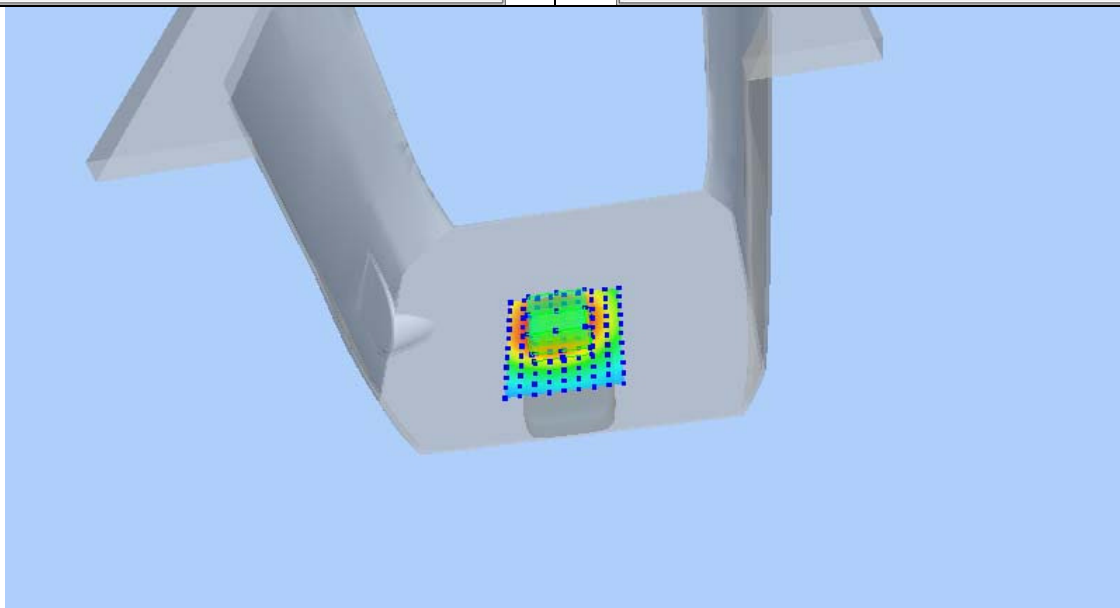
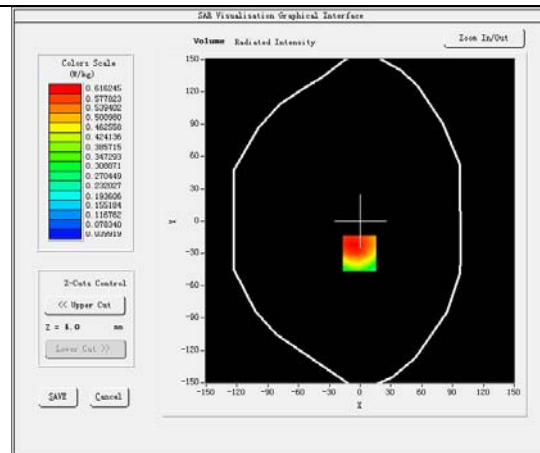
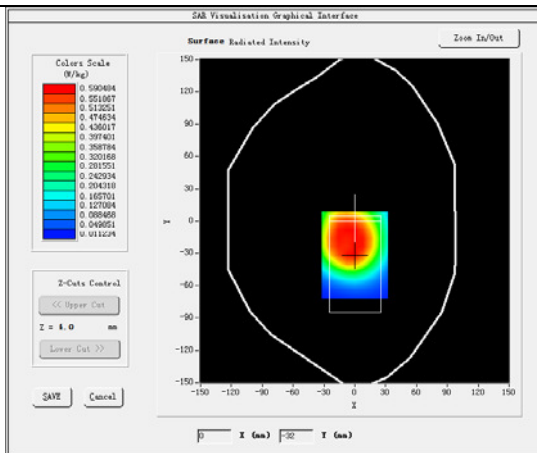
SURFACE SAR**VOLUME SAR**

Plot 11: WCDMA BAND II , Middle channel (Hotspot, Bottom Edge)**Product Description: Mobile Phone****Model: iris 758****Test Date: Apr 13,2016**

Medium(liquid type)	MSL_1900
Frequency (MHz)	1880.0000
Relative permittivity (real part)	53.51
Conductivity (S/m)	1.50
Signal	WCDMA(Duty cycle: 1:1)
E-Field Probe	SN 07/15 EP249
Conversion Factor	5.05
Sensor-Surface	4mm
Area Scan	dx=8mm dy=8mm
Zoom Scan	5x5x7,dx=8mm dy=8mm dz=5mm
Variation (%)	0.06
SAR 10g (W/Kg)	0.359605
SAR 1g (W/Kg)	0.660158

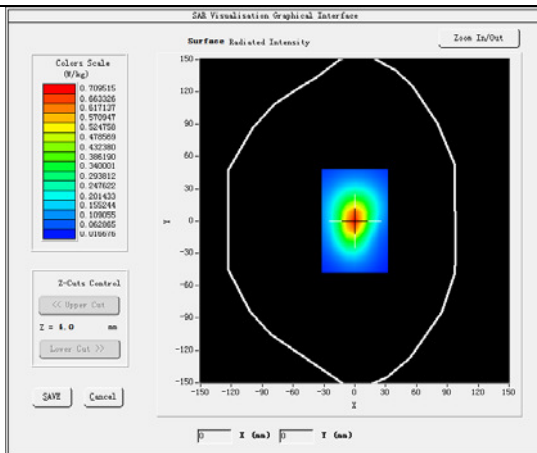
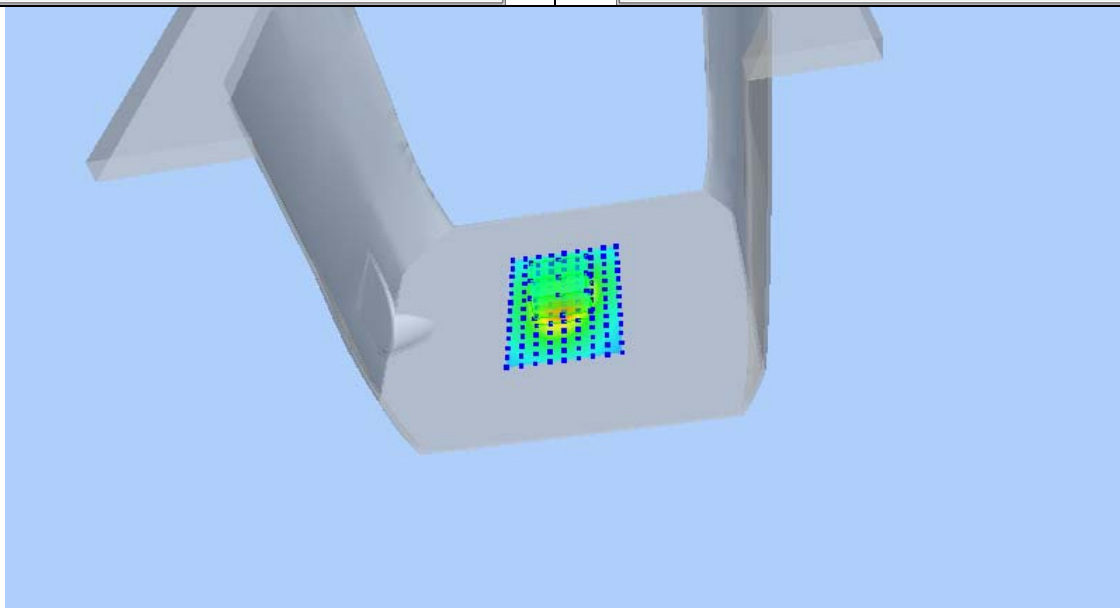
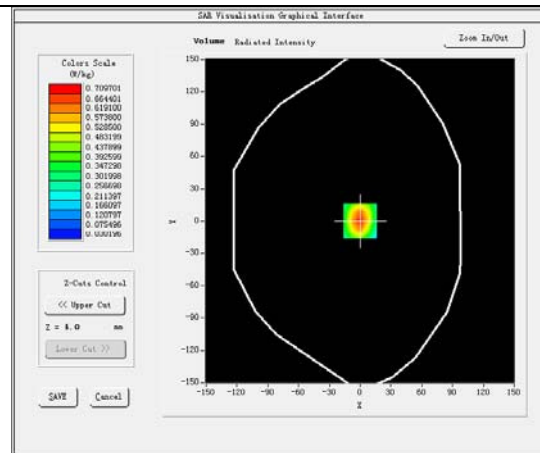
SURFACE SAR**VOLUME SAR**

Plot 12:LTE BAND2, Middle channel (Left Head Cheek)**Product Description:Mobile Phone****Model: iris 758****Test Date: Apr 7,2016**

Medium(liquid type)	HSL_1900
Frequency (MHz)	1880.0000
Relative permittivity (real part)	41.04
Conductivity (S/m)	1.41
Signal	Duty cycle: 1:1
E-Field Probe	SN 07/15 EP249
Conversion Factor	4.95
Bandwidth(MHz)	20
RB Allocation	1
RB Offset	49
Area Scan	dx=8mm dy=8mm
Zoom Scan	5x5x7,dx=8mm dy=8mm dz=5mm
Variation (%)	-2.26
SAR 10g (W/Kg)	0.194353
SAR 1g (W/Kg)	0.327126

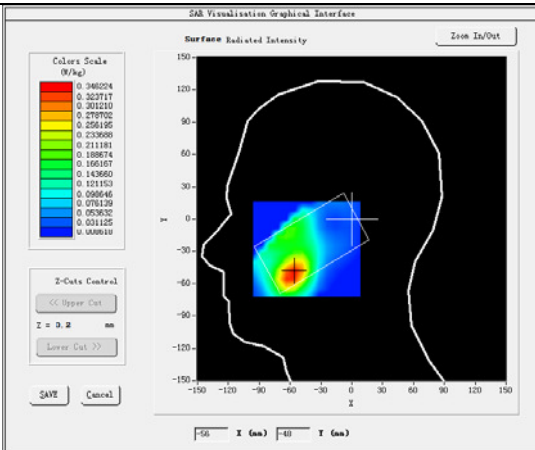
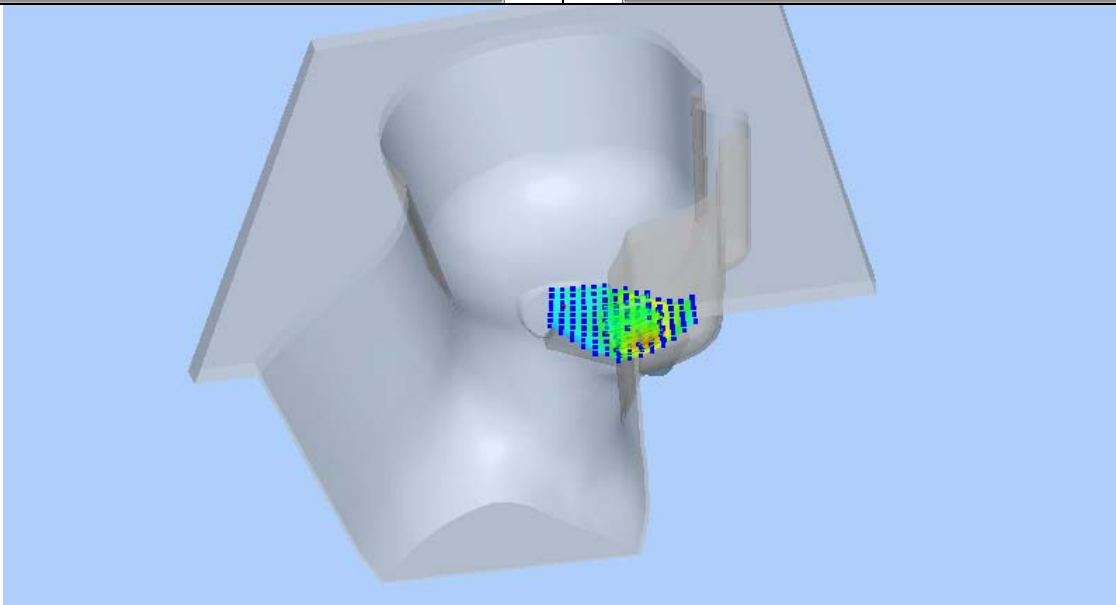
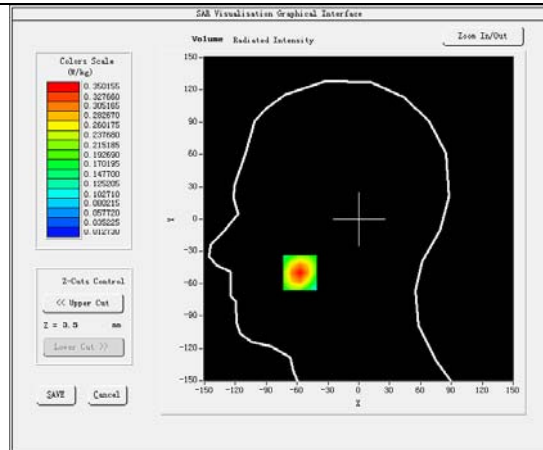
SURFACE SAR**VOLUME SAR**

Plot 13:LTE BAND2, Middle channel (Body-worn, Back Surface)**Product Description:Mobile Phone****Model: iris 758****Test Date: Apr 7,2016**

Medium(liquid type)	MSL_1900
Frequency (MHz)	1880.0000
Relative permittivity (real part)	53.51
Conductivity (S/m)	1.50
Signal	Duty cycle: 1:1
E-Field Probe	SN 07/15 EP249
Conversion Factor	5.05
Bandwidth(MHz)	20
RB Allocation	1
RB Offset	49
Area Scan	dx=8mm dy=8mm
Zoom Scan	5x5x7,dx=8mm dy=8mm dz=5mm
Variation (%)	-1.02
SAR 10g (W/Kg)	0.394754
SAR 1g (W/Kg)	0.645182

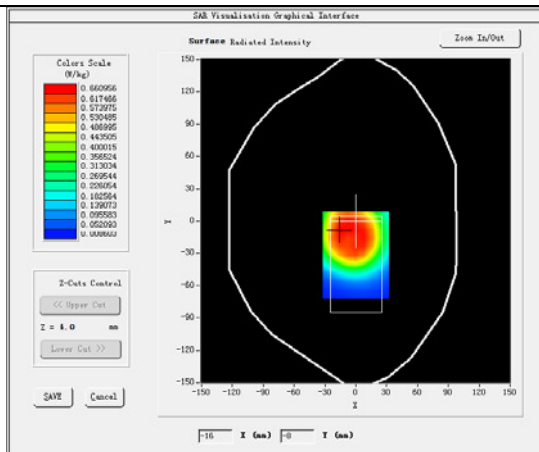
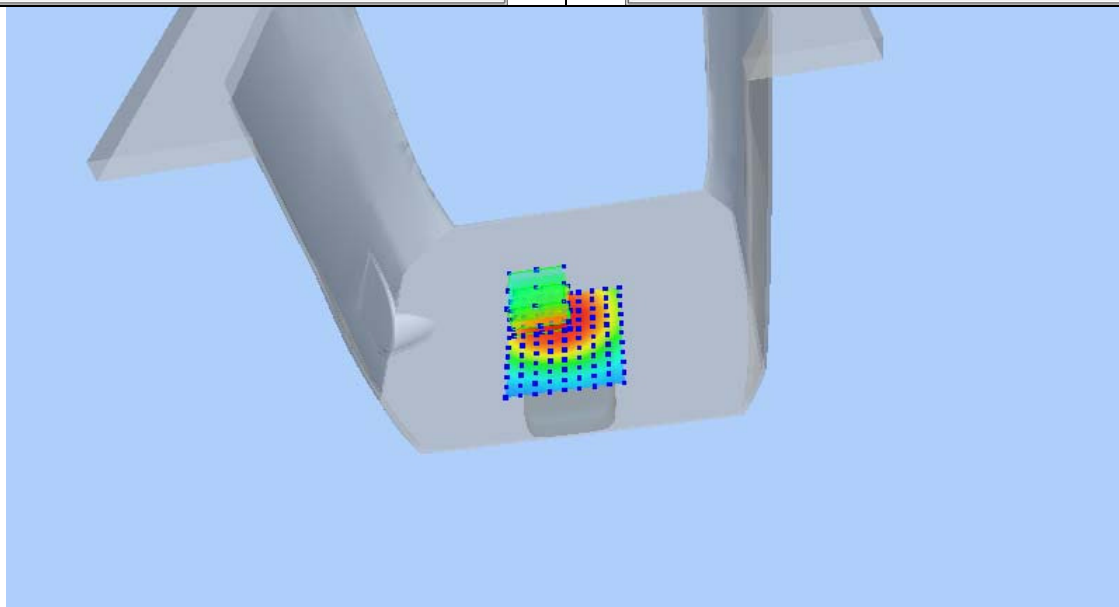
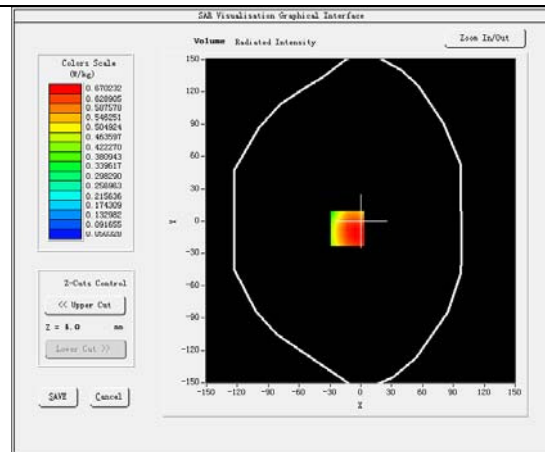
SURFACE SAR**VOLUME SAR**

Plot 14:LTE BAND2, Middle channel (Hotspot, Bottom Edge)**Product Description:Mobile Phone****Model: iris 758****Test Date: Apr 7,2016**

Medium(liquid type)	MSL_1900
Frequency (MHz)	1880.0000
Relative permittivity (real part)	53.51
Conductivity (S/m)	1.50
Signal	Duty cycle: 1:1
E-Field Probe	SN 07/15 EP249
Conversion Factor	5.05
Bandwidth(MHz)	20
RB Allocation	1
RB Offset	49
Area Scan	dx=8mm dy=8mm
Zoom Scan	5x5x7,dx=8mm dy=8mm dz=5mm
Variation (%)	-1.00
SAR 10g (W/Kg)	0.432438
SAR 1g (W/Kg)	0.787986

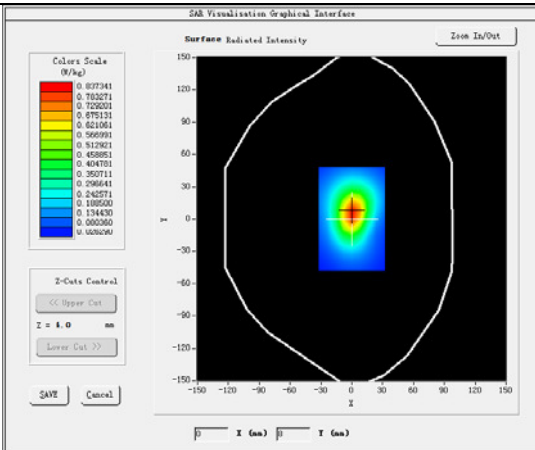
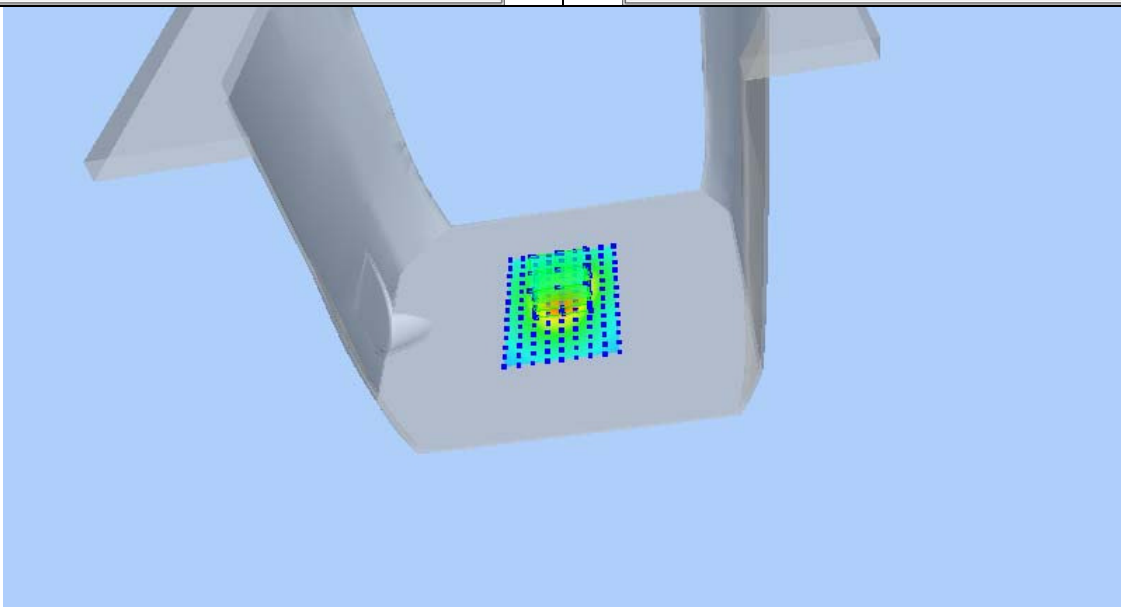
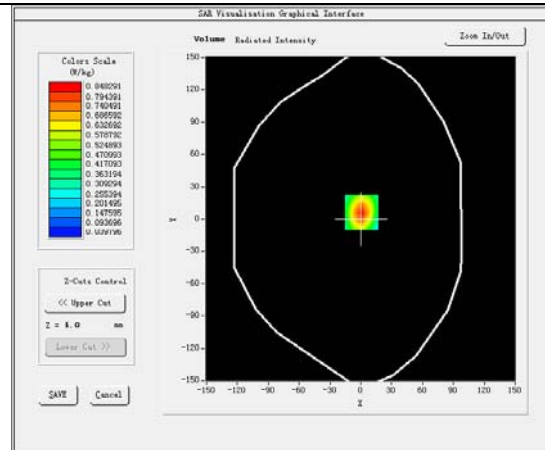
SURFACE SAR**VOLUME SAR**

Plot 15:LTE BAND4, Middle channel (Right Head Cheek)**Product Description:Mobile Phone****Model: iris 758****Test Date: Apr 7,2016**

Medium(liquid type)	HSL_1800
Frequency (MHz)	1732.5000
Relative permittivity (real part)	40.51
Conductivity (S/m)	1.39
Signal	Duty cycle: 1:1
E-Field Probe	SN 07/15 EP249
Conversion Factor	4.23
Bandwidth(MHz)	20
RB Allocation	1
RB Offset	49
Area Scan	dx=8mm dy=8mm
Zoom Scan	5x5x7,dx=8mm dy=8mm dz=5mm
Variation (%)	3.29
SAR 10g (W/Kg)	0.140328
SAR 1g (W/Kg)	0.242876

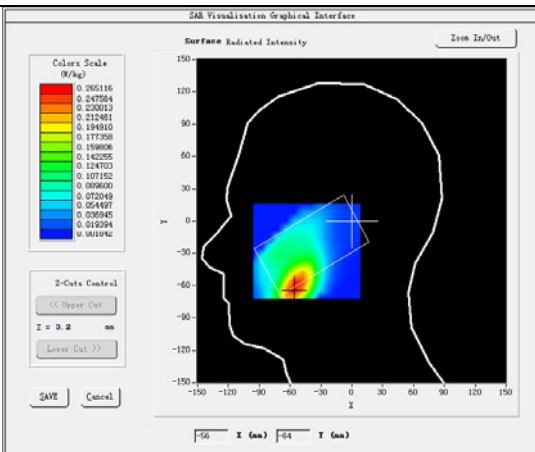
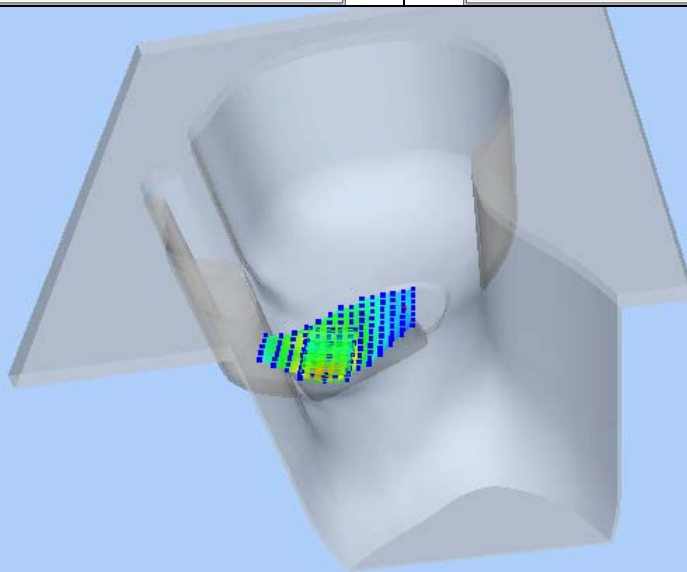
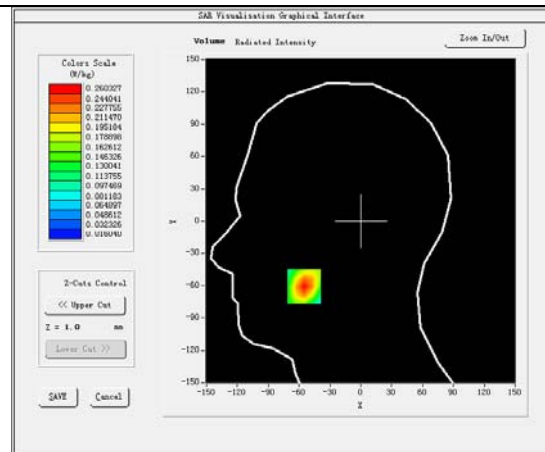
SURFACE SAR**VOLUME SAR**

Plot 16:LTE BAND4, Middle channel (Body-worn/Hotspot, Back Surface)**Product Description:Mobile Phone****Model: iris 758****Test Date: Apr 7,2016**

Medium(liquid type)	MSL_1800
Frequency (MHz)	1732.5000
Relative permittivity (real part)	53.85
Conductivity (S/m)	1.50
Signal	Duty cycle: 1:1
E-Field Probe	SN 07/15 EP249
Conversion Factor	4.37
Bandwidth(MHz)	20
RB Allocation	1
RB Offset	49
Area Scan	dx=8mm dy=8mm
Zoom Scan	5x5x7,dx=8mm dy=8mm dz=5mm
Variation (%)	3.82
SAR 10g (W/Kg)	0.337775
SAR 1g (W/Kg)	0.558923

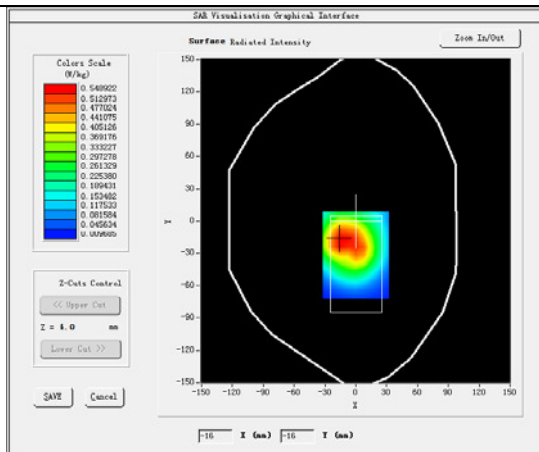
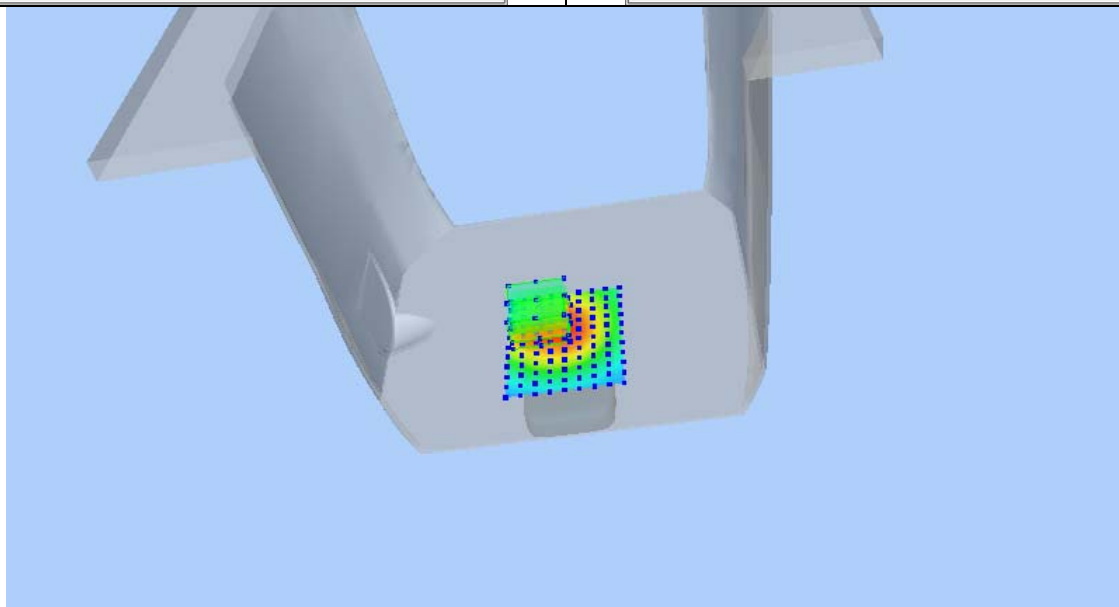
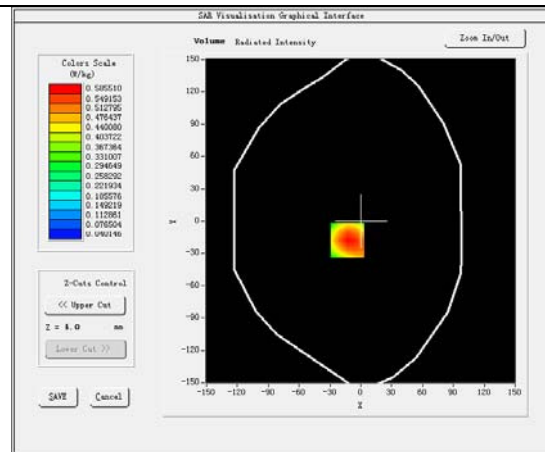
SURFACE SAR**VOLUME SAR**

Plot 17:LTE BAND7, Middle channel (Right Head Cheek)**Product Description:Mobile Phone****Model: iris 758****Test Date: Apr 7,2016**

Medium(liquid type)	HSL_2450
Frequency (MHz)	2535.0000
Relative permittivity (real part)	39.54
Conductivity (S/m)	1.79
Signal	Duty cycle: 1:1
E-Field Probe	SN 07/15 EP249
Conversion Factor	4.32
Bandwidth(MHz)	20
RB Allocation	1
RB Offset	49
Area Scan	dx=8mm dy=8mm
Zoom Scan	5x5x7,dx=8mm dy=8mm dz=5mm
Variation (%)	4.50
SAR 10g (W/Kg)	0.019010
SAR 1g (W/Kg)	0.037042

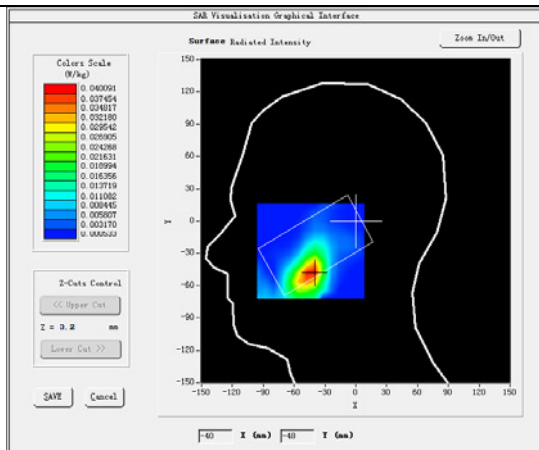
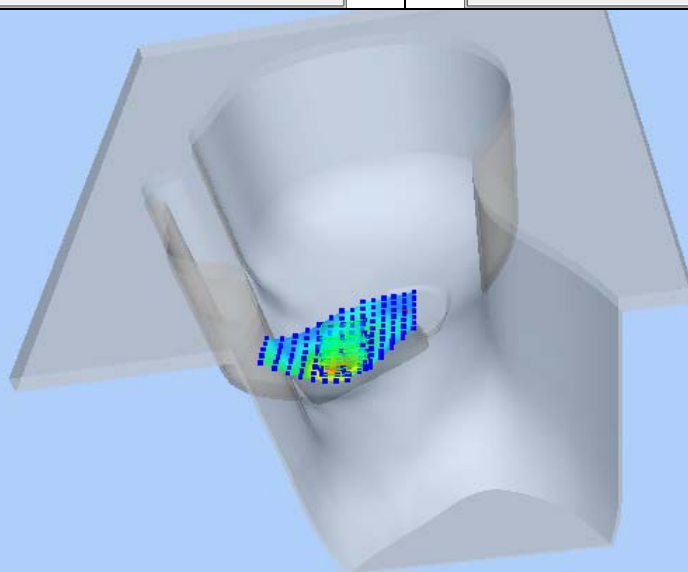
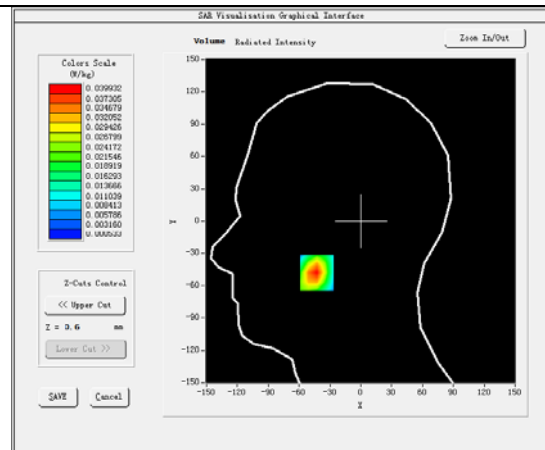
SURFACE SAR**VOLUME SAR**

Plot 18:LTE BAND7, Middle channel (Body-worn, Back Surface)**Product Description:Mobile Phone****Model: iris 758****Test Date: Apr 7,2016**

Medium(liquid type)	MSL_2450
Frequency (MHz)	2535.0000
Relative permittivity (real part)	52.73
Conductivity (S/m)	1.94
Signal	Duty cycle: 1:1
E-Field Probe	SN 07/15 EP249
Conversion Factor	4.49
Bandwidth(MHz)	20
RB Allocation	1
RB Offset	49
Area Scan	dx=8mm dy=8mm
Zoom Scan	5x5x7,dx=8mm dy=8mm dz=5mm
Variation (%)	-2.90
SAR 10g (W/Kg)	0.150878
SAR 1g (W/Kg)	0.310359

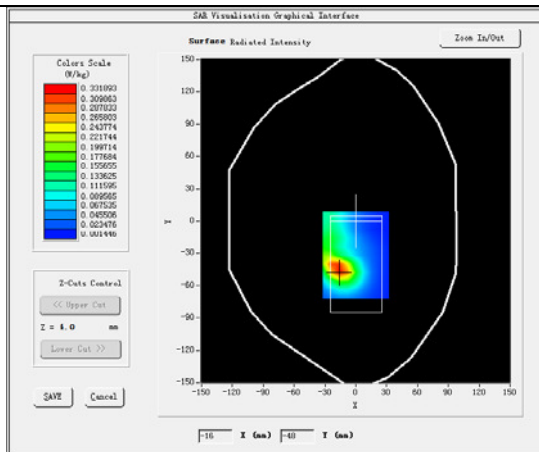
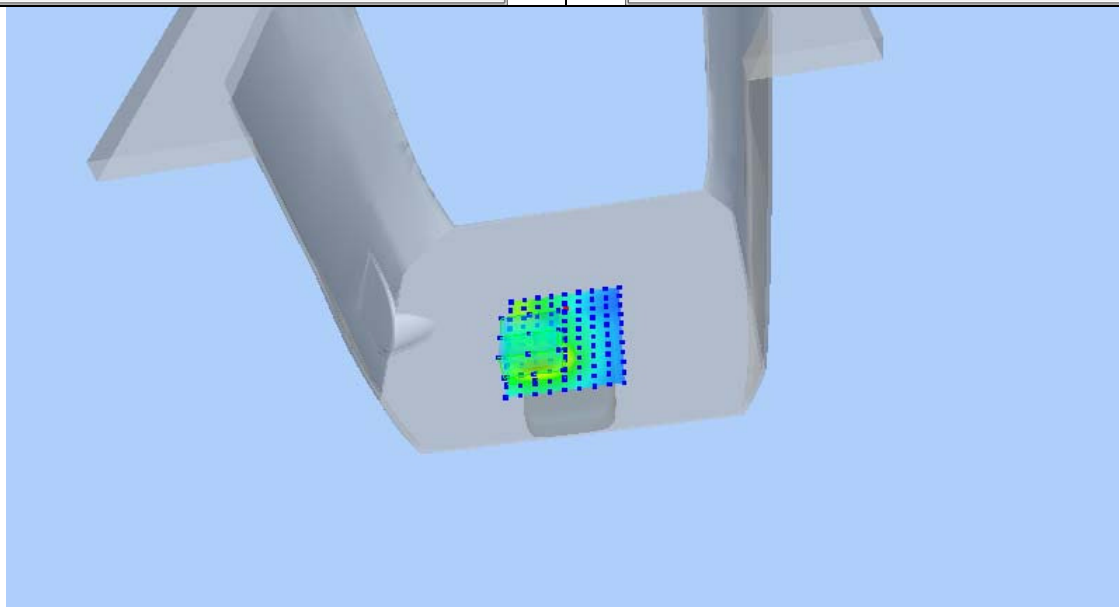
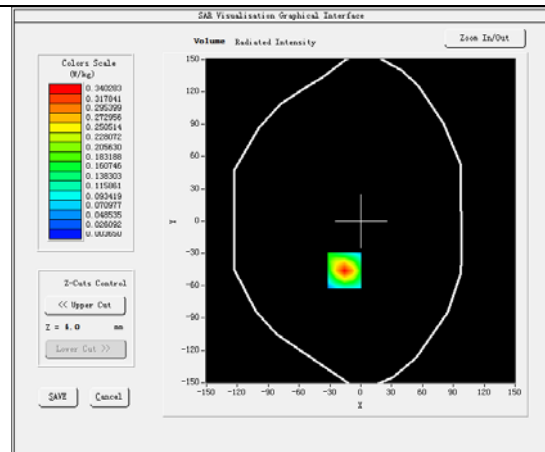
SURFACE SAR**VOLUME SAR**

Plot 19:LTE BAND7, Middle channel (Hotspot, Bottom Edge)

Product Description:Mobile Phone

Model: iris 758

Test Date: Apr 7,2016

Medium(liquid type)	MSL_2450
Frequency (MHz)	2535.0000
Relative permittivity (real part)	52.73
Conductivity (S/m)	1.94
Signal	Duty cycle: 1:1
E-Field Probe	SN 07/15 EP249
Conversion Factor	4.49
Bandwidth(MHz)	20
RB Allocation	1
RB Offset	49
Area Scan	dx=8mm dy=8mm
Zoom Scan	5x5x7,dx=8mm dy=8mm dz=5mm
Variation (%)	1.10
SAR 10g (W/Kg)	0.213985
SAR 1g (W/Kg)	0.461404

SURFACE SAR

VOLUME SAR

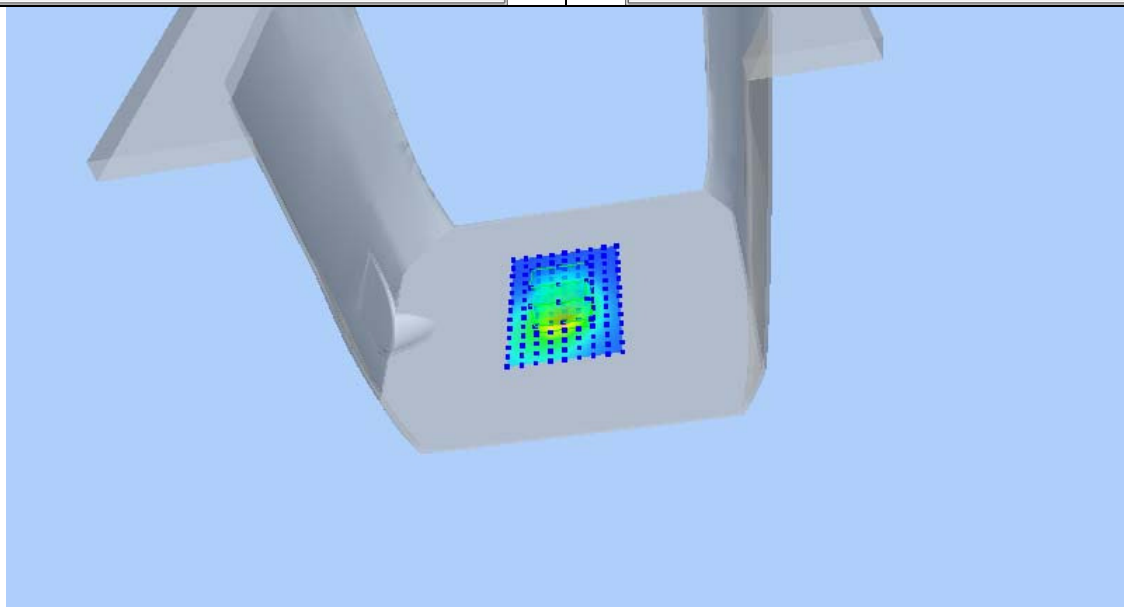
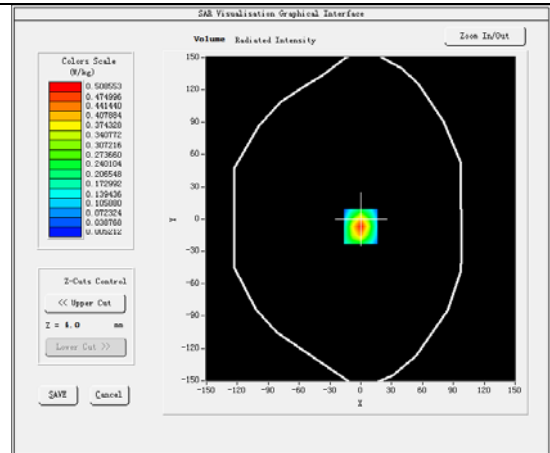
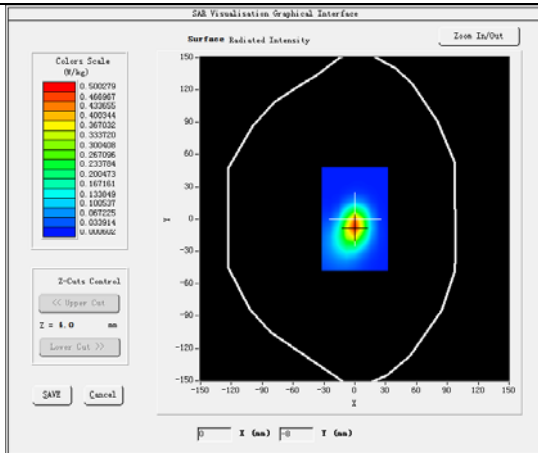

15 Calibration reports-Probe



COMOSAR E-Field Probe Calibration Report

Ref : ACR.307.1.15.SATU.A

WALTEK SERVICES (SHENZHEN) CO., LTD
1/F., FUKANGTAI BUILDING, WEST BAIMA ROAD,
SONGGANG STREET
BAOAN DISTRICT, SHENZHEN GUANGDONG 518105,
CHINA
MVG COMOSAR DOSIMETRIC E-FIELD PROBE
SERIAL NO.: SN 07/15 EP249

Calibrated at MVG US
2105 Barrett Park Dr. - Kennesaw, GA 30144



Calibration Date: 10/19/2015

Summary:

This document presents the method and results from an accredited COMOSAR Dosimetric E-Field Probe calibration performed in MVG USA using the CALISAR / CALIBAIR test bench, for use with a COMOSAR system only. All calibration results are traceable to national metrology institutions.



COMOSAR E-FIELD PROBE CALIBRATION REPORT

Ref: ACR.307.1.15.SATU.A

	<i>Name</i>	<i>Function</i>	<i>Date</i>	<i>Signature</i>
<i>Prepared by :</i>	Jérôme LUC	Product Manager	11/3/2015	<i>JS</i>
<i>Checked by :</i>	Jérôme LUC	Product Manager	11/3/2015	<i>JS</i>
<i>Approved by :</i>	Kim RUTKOWSKI	Quality Manager	11/3/2015	<i>Kim Rutkowski</i>

	<i>Customer Name</i>
<i>Distribution :</i>	Waltek Services (Shenzhen) Co., Ltd

<i>Issue</i>	<i>Date</i>	<i>Modifications</i>
A	11/3/2015	Initial release

Page: 2/9

*This document shall not be reproduced, except in full or in part, without the written approval of MVG.
The information contained herein is to be used only for the purpose for which it is submitted and is not to be released in whole or part without written approval of MVG.*



COMOSAR E-FIELD PROBE CALIBRATION REPORT

Ref: ACR.307.1.15.SATU.A

TABLE OF CONTENTS

1	Device Under Test	4
2	Product Description	4
2.1	General Information	4
3	Measurement Method	4
3.1	Linearity	4
3.2	Sensitivity	5
3.3	Lower Detection Limit	5
3.4	Isotropy	5
3.5	Boundary Effect	5
4	Measurement Uncertainty	5
5	Calibration Measurement Results	6
5.1	Sensitivity in air	6
5.2	Linearity	7
5.3	Sensitivity in liquid	7
5.4	Isotropy	8
6	List of Equipment	9

Page: 3/9

*This document shall not be reproduced, except in full or in part, without the written approval of MVG.
The information contained herein is to be used only for the purpose for which it is submitted and is not to
be released in whole or part without written approval of MVG.*



COMOSAR E-FIELD PROBE CALIBRATION REPORT

Ref: ACR.307.1.15.SATU.A

1 DEVICE UNDER TEST

Device Under Test	
Device Type	COMOSAR DOSIMETRIC E FIELD PROBE
Manufacturer	MVG
Model	SSE5
Serial Number	SN 07/15 EP249
Product Condition (new / used)	New
Frequency Range of Probe	0.7 GHz-3GHz
Resistance of Three Dipoles at Connector	Dipole 1: R1=0.178 MΩ Dipole 2: R2=0.179 MΩ Dipole 3: R3=0.167 MΩ

A yearly calibration interval is recommended.

2 PRODUCT DESCRIPTION**2.1 GENERAL INFORMATION**

MVG's COMOSAR E field Probes are built in accordance to the IEEE 1528, OET 65 Bulletin C and CEI/IEC 62209 standards.



Figure 1 – MVG COMOSAR Dosimetric E field Dipole

Probe Length	330 mm
Length of Individual Dipoles	4.5 mm
Maximum external diameter	8 mm
Probe Tip External Diameter	5 mm
Distance between dipoles / probe extremity	2.7 mm

3 MEASUREMENT METHOD

The IEEE 1528, OET 65 Bulletin C, CENELEC EN50361 and CEI/IEC 62209 standards provide recommended practices for the probe calibrations, including the performance characteristics of interest and methods by which to assess their affect. All calibrations / measurements performed meet the fore mentioned standards.

3.1 LINEARITY

The evaluation of the linearity was done in free space using the waveguide, performing a power sweep to cover the SAR range 0.01W/kg to 100W/kg.

Page: 4/9

*This document shall not be reproduced, except in full or in part, without the written approval of MVG.
The information contained herein is to be used only for the purpose for which it is submitted and is not to be released in whole or part without written approval of MVG.*



COMOSAR E-FIELD PROBE CALIBRATION REPORT

Ref: ACR.307.1.15.SATU.A

3.2 SENSITIVITY

The sensitivity factors of the three dipoles were determined using a two step calibration method (air and tissue simulating liquid) using waveguides as outlined in the standards.

3.3 LOWER DETECTION LIMIT

The lower detection limit was assessed using the same measurement set up as used for the linearity measurement. The required lower detection limit is 10 mW/kg.

3.4 ISOTROPY

The axial isotropy was evaluated by exposing the probe to a reference wave from a standard dipole with the dipole mounted under the flat phantom in the test configuration suggested for system validations and checks. The probe was rotated along its main axis from 0 - 360 degrees in 15 degree steps. The hemispherical isotropy is determined by inserting the probe in a thin plastic box filled with tissue-equivalent liquid, with the plastic box illuminated with the fields from a half wave dipole. The dipole is rotated about its axis (0°–180°) in 15° increments. At each step the probe is rotated about its axis (0°–360°).

3.5 BOUNDARY EFFECT

The boundary effect is defined as the deviation between the SAR measured data and the expected exponential decay in the liquid when the probe is oriented normal to the interface. To evaluate this effect, the liquid filled flat phantom is exposed to fields from either a reference dipole or waveguide. With the probe normal to the phantom surface, the peak spatial average SAR is measured and compared to the analytical value at the surface.

4 MEASUREMENT UNCERTAINTY

The guidelines outlined in the IEEE 1528, OET 65 Bulletin C, CENELEC EN50361 and CEI/IEC 62209 standards were followed to generate the measurement uncertainty associated with an E-field probe calibration using the waveguide technique. All uncertainties listed below represent an expanded uncertainty expressed at approximately the 95% confidence level using a coverage factor of k=2, traceable to the Internationally Accepted Guides to Measurement Uncertainty.

Uncertainty analysis of the probe calibration in waveguide					
ERROR SOURCES	Uncertainty value (%)	Probability Distribution	Divisor	ci	Standard Uncertainty (%)
Incident or forward power	3.00%	Rectangular	$\sqrt{3}$	1	1.732%
Reflected power	3.00%	Rectangular	$\sqrt{3}$	1	1.732%
Liquid conductivity	5.00%	Rectangular	$\sqrt{3}$	1	2.887%
Liquid permittivity	4.00%	Rectangular	$\sqrt{3}$	1	2.309%
Field homogeneity	3.00%	Rectangular	$\sqrt{3}$	1	1.732%
Field probe positioning	5.00%	Rectangular	$\sqrt{3}$	1	2.887%

Page: 5/9

*This document shall not be reproduced, except in full or in part, without the written approval of MVG.
The information contained herein is to be used only for the purpose for which it is submitted and is not to be released in whole or part without written approval of MVG.*



COMOSAR E-FIELD PROBE CALIBRATION REPORT

Ref: ACR.307.1.15.SATU.A

Field probe linearity	3.00%	Rectangular	$\sqrt{3}$	1	1.732%
Combined standard uncertainty					5.831%
Expanded uncertainty 95 % confidence level k = 2					12.0%

5 CALIBRATION MEASUREMENT RESULTS

Calibration Parameters	
Liquid Temperature	21 °C
Lab Temperature	21 °C
Lab Humidity	45 %

5.1 SENSITIVITY IN AIR

Normx dipole 1 ($\mu\text{V}/(\text{V}/\text{m})^2$)	Normy dipole 2 ($\mu\text{V}/(\text{V}/\text{m})^2$)	Normz dipole 3 ($\mu\text{V}/(\text{V}/\text{m})^2$)
6.81	6.65	6.62

DCP dipole 1 (mV)	DCP dipole 2 (mV)	DCP dipole 3 (mV)
95	91	91

Calibration curves $e_i=f(V)$ ($i=1,2,3$) allow to obtain H-field value using the formula:

$$E = \sqrt{E_1^2 + E_2^2 + E_3^2}$$

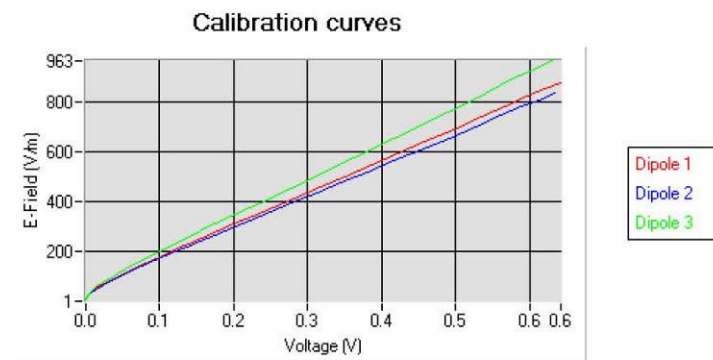

Page: 6/9

*This document shall not be reproduced, except in full or in part, without the written approval of MVG.
The information contained herein is to be used only for the purpose for which it is submitted and is not to be released in whole or part without written approval of MVG.*



COMOSAR E-FIELD PROBE CALIBRATION REPORT

Ref: ACR.307.1.15.SATU.A

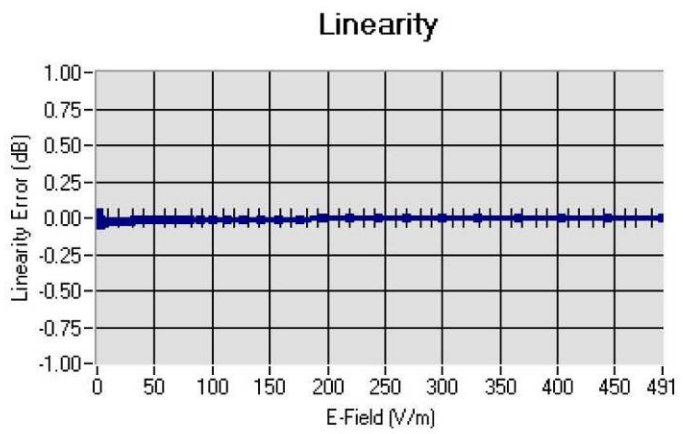
5.2 LINEARITYLinearity: $\pm 1.21\%$ ($\pm 0.05\text{dB}$)5.3 SENSITIVITY IN LIQUID

<u>Liquid</u>	<u>Frequency</u> (MHz +/- 100MHz)	<u>Permittivity</u>	<u>Epsilon (S/m)</u>	<u>ConvF</u>
HL750	750	42.24	0.90	4.97
BL750	750	56.85	0.99	5.11
HL850	835	43.02	0.90	5.26
BL850	835	53.72	0.98	5.46
HL900	900	42.47	0.99	5.03
BL900	900	56.97	1.09	5.22
HL1800	1800	42.24	1.40	4.23
BL1800	1800	53.53	1.53	4.37
HL1900	1900	40.79	1.42	4.95
BL1900	1900	54.47	1.57	5.05
HL2000	2000	40.52	1.44	4.44
BL2000	2000	54.18	1.56	4.57
HL2450	2450	38.73	1.81	4.32
BL2450	2450	53.23	1.96	4.49
HL2600	2600	38.54	1.95	4.26
BL2600	2600	52.07	2.23	4.40

LOWER DETECTION LIMIT: 8mW/kg

Page: 7/9

*This document shall not be reproduced, except in full or in part, without the written approval of MVG.
The information contained herein is to be used only for the purpose for which it is submitted and is not to be released in whole or part without written approval of MVG.*



COMOSAR E-FIELD PROBE CALIBRATION REPORT

Ref: ACR.307.1.15.SATU.A

5.4 ISOTROPY

HL900 MHz

- Axial isotropy: 0.04 dB
- Hemispherical isotropy: 0.05 dB

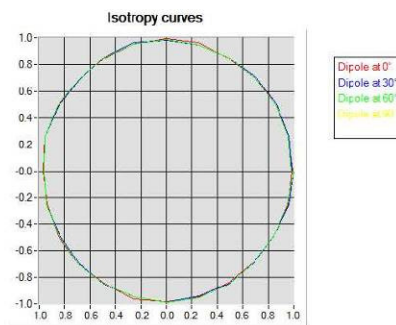

HL1800 MHz

- Axial isotropy: 0.04 dB
- Hemispherical isotropy: 0.06 dB

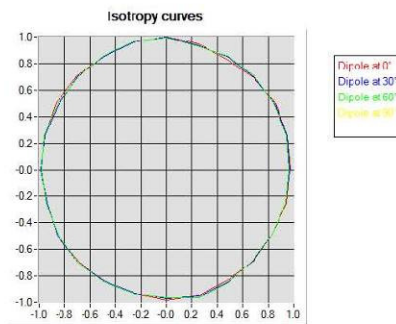

Page: 8/9

*This document shall not be reproduced, except in full or in part, without the written approval of MVG.
The information contained herein is to be used only for the purpose for which it is submitted and is not to be released in whole or part without written approval of MVG.*



COMOSAR E-FIELD PROBE CALIBRATION REPORT

Ref: ACR.307.1.15.SATU.A

6 LIST OF EQUIPMENT

Equipment Summary Sheet				
Equipment Description	Manufacturer / Model	Identification No.	Current Calibration Date	Next Calibration Date
Flat Phantom	MVG	SN-20/09-SAM71	Validated. No cal required.	Validated. No cal required.
COMOSAR Test Bench	Version 3	NA	Validated. No cal required.	Validated. No cal required.
Network Analyzer	Rhode & Schwarz ZVA	SN100132	02/2013	02/2016
Reference Probe	MVG	EP 94 SN 37/08	10/2015	10/2016
Multimeter	Keithley 2000	1188656	12/2013	12/2016
Signal Generator	Agilent E4438C	MY49070581	12/2013	12/2016
Amplifier	Aethercomm	SN 046	Characterized prior to test. No cal required.	Characterized prior to test. No cal required.
Power Meter	HP E4418A	US38261498	12/2013	12/2016
Power Sensor	HP ECP-E26A	US37181460	12/2013	12/2016
Directional Coupler	Narda 4216-20	01386	Characterized prior to test. No cal required.	Characterized prior to test. No cal required.
Waveguide	Mega Industries	069Y7-158-13-712	Validated. No cal required.	Validated. No cal required.
Waveguide Transition	Mega Industries	069Y7-158-13-701	Validated. No cal required.	Validated. No cal required.
Waveguide Termination	Mega Industries	069Y7-158-13-701	Validated. No cal required.	Validated. No cal required.

Page: 9/9

*This document shall not be reproduced, except in full or in part, without the written approval of MVG.
The information contained herein is to be used only for the purpose for which it is submitted and is not to be released in whole or part without written approval of MVG.*



SAR Reference Dipole Calibration Report

Ref : ACR.92.3.15.SATU.A

WALTEK SERVICES (SHENZHEN) CO., LTD
1/F., FUKANGTAI BUILDING, WEST BAIMA ROAD,
SONGGANG STREET
BAOAN DISTRICT, SHENZHEN GUANGDONG 518105,
CHINA
MVG COMOSAR REFERENCE DIPOLE
FREQUENCY: 835 MHZ
SERIAL NO.: SN 09/15 DIP 0G835-358

Calibrated at MVG US
2105 Barrett Park Dr. - Kennesaw, GA 30144



03/16/2015

Summary:

This document presents the method and results from an accredited SAR reference dipole calibration performed in MVG USA using the COMOSAR test bench. All calibration results are traceable to national metrology institutions.