



FCC Part 15C Test Report

FCC ID: 2AEDNA43

Product Name:	Wireless Mouse
Trademark:	
Model Name :	SL-630014
Serial Model:	SL-630014-BKBE, SL-630014-BKGY, SL-630014-BKRD
Prepared For :	Winspeed Co., Ltd
Address :	14 F-1, No.2, Jian-Ba Rd., Chung-Ho District, New Taipei, Taiwan
Prepared By :	Shenzhen BCTC Testing Co., Ltd.
Address :	BCTC Building & 1-2F, East of B Building, Pengzhou Industrial, Fuyuan 1st Road, Qiaotou Community, Fuyong Street, Bao'an District, Shenzhen, China
Test Date:	Mar. 20 - Mar. 27, 2018
Date of Report :	Mar. 27, 2018
Report No.:	BCTC-LH180300439E



VERIFICATION OF COMPLIANCE

Applicant's name..... : **Winspeed Co., Ltd**
 Address : 14 F-1, No.2, Jian-Ba Rd., Chung-Ho District, New Taipei, Taiwan
Manufacture's Name..... : **Winspeed Co., Ltd**
 Address : 14 F-1, No.2, Jian-Ba Rd., Chung-Ho District, New Taipei, Taiwan

Product description

Product name : Wireless Mouse

Trademark: 

Model Name: SL-630014

Standards: FCC Part15.249
 ANSI C63.10-2013

This device described above has been tested by BCTC, and the test results show that the equipment under test (EUT) is in compliance with the FCC requirements. And it is applicable only to the tested sample identified in the report.

This report shall not be reproduced except in full, without the written approval of BCTC, this document may be altered or revised by BCTC, personal only, and shall be noted in the revision of the document.

Test Result..... : **Pass**

Prepared by(Engineer): Eric Yang
 Reviewer(Supervisor): Jade Yang
 Approved(Manager): Carson Zhang



**Table of Contents**

	Page
1 . SUMMARY OF TEST RESULTS	5
1.1 TEST FACILITY	5
1.2 MEASUREMENT UNCERTAINTY	5
2 . GENERAL INFORMATION	6
2.1 GENERAL DESCRIPTION OF EUT	6
2.2 DESCRIPTION OF TEST MODES	7
2.3 TABLE OF PARAMETERS OF TEXT SOFTWARE SETTING	7
2.4 BLOCK DIGRAM SHOWING THE CONFIGURATION OF SYSTEM TESTED	8
2.5 DESCRIPTION OF SUPPORT UNITS(CONDUCTED MODE)	8
2.6 EQUIPMENTS LIST FOR ALL TEST ITEMS	9
3 . EMC EMISSION TEST	10
3.1 RADIATED EMISSION MEASUREMENT	10
3.1.1 RADIATED EMISSION LIMITS	10
3.1.2 TEST PROCEDURE	11
3.1.3 DEVIATION FROM TEST STANDARD	11
3.1.4 TEST SETUP	12
3.1.5 EUT OPERATING CONDITIONS	13
3.1.6 TEST RESULTS	14
4 . BANDWIDTH TEST	19
4.1 APPLIED PROCEDURES / LIMIT	19
4.1.1 TEST PROCEDURE	19
4.1.2 DEVIATION FROM STANDARD	19
4.1.3 TEST SETUP	19
4.1.4 EUT OPERATION CONDITIONS	19
4.1.5 TEST RESULTS	20
5 . 100 KHZ BANDWIDTH OF FREQUENCY BAND EDGE	22
5.1 DEVIATION FROM STANDARD	22
5.2 TEST SETUP	22
5.3 EUT OPERATION CONDITIONS	22
5.4 TEST RESULTS	23
6 . ANTENNA REQUIREMENT	26
6.1 STANDARD REQUIREMENT	26
6.2 EUT ANTENNA	26



Table of Contents

	Page
7 . EUT TEST PHOTOS	27
8 . PHOTOS OF THE EUT	28



1. SUMMARY OF TEST RESULTS

Test procedures according to the technical standards:

FCC Part15 (15.249) , Subpart C			
Standard Section	Test Item	Judgment	Remark
15.207	Conducted Emission	N/A	
15.249	Fundamental & Radiated Spurious Emission Measurement	PASS	
15.249	Bandwidth	PASS	
15.205	Band Edge Emission	PASS	
15.203	Antenna Requirement	PASS	

NOTE:

(1) "N/A" denotes test is not applicable in this Test Report

1.1 TEST FACILITY

Shenzhen BCTC Testing Co., Ltd.

Add.: BCTC Building & 1-2F, East of B Building, Pengzhou Industrial, Fuyuan 1st Road, Qiaotou Community, Fuyong Street, Bao'an District, Shenzhen, China

FCC Test Firm Registration Number: 712850

IC Registered No.: 23583

1.2 MEASUREMENT UNCERTAINTY

The reported uncertainty of measurement $y \pm U$, where expanded uncertainty U is based on a standard uncertainty multiplied by a coverage factor of $k=2$, providing a level of confidence of approximately **95 %**.

No.	Item	Uncertainty
1	Conducted Emission Test	$\pm 1.38\text{dB}$
2	RF power, conducted	$\pm 0.16\text{dB}$
3	Spurious emissions, conducted	$\pm 0.21\text{dB}$
4	All emissions, radiated (<1G)	$\pm 4.68\text{dB}$
5	All emissions, radiated (>1G)	$\pm 4.89\text{dB}$
6	Temperature	$\pm 0.5^\circ\text{C}$
7	Humidity	$\pm 2\%$



2. GENERAL INFORMATION

2.1 GENERAL DESCRIPTION OF EUT

Equipment	Wireless Mouse	
Trade Name		
Model Name	SL-630014	
Serial Model	SL-630014-BKBE, SL-630014-BKGY, SL-630014-BKRD	
Model Difference	All models are the same circuit and rf module, except for the model name and color.	
Product Description	Operation Frequency:	2405~2470MHz
	Modulation Type:	GFSK
	Number Of Channel	8CH
	Antenna Designation:	Please see Note 3.
	Based on the application, features, or specification exhibited in User's Manual, the EUT is considered as an ITE/Computing Device. More details of EUT technical specification, please refer to the User's Manual.	
Channel List	Please refer to the Note 2.	
Power Source	DC 1.5V(from battery)	
Connecting I/O Port(s)	Please refer to the User's Manual	
hardware version	--	
Software version	--	
Serial number	--	



Note:

1. For a more detailed features description, please refer to the manufacturer's specifications or the User's Manual.

2

Channel List					
Channel	Frequency (MHz)	Channel	Frequency (MHz)	Channel	Frequency (MHz)
00	2405	03	2430	06	2460
01	2413	04	2440	07	2470
02	2422	05	2450		

3. Table for Filed Antenna

Ant.	Brand	Model Name	Antenna Type	Gain (dBi)	NOTE
1	N/A	N/A	PCB Antenna	0	N/A

2.2 DESCRIPTION OF TEST MODES

To investigate the maximum EMI emission characteristics generates from EUT, the test system was pre-scanning tested base on the consideration of following EUT operation mode or test configuration mode which possible have effect on EMI emission level. Each of these EUT operation mode(s) or test configuration mode(s) mentioned above was evaluated respectively.

For Conducted & Radiated Emission	
Final Test Mode	Description
Mode 1	CH00
Mode 2	CH03
Mode 3	CH07
Mode 4	working Mode

Note:

- (1) The measurements are performed at the highest, middle, lowest available channels.
- (2) Fully-charged battery is used during the test

2.3 TABLE OF PARAMETERS OF TEXT SOFTWARE SETTING

During testing channel & power controlling software provided by the customer was used to control the operating channel as well as the output power level. The RF output power selection is for the setting of RF output power expected by the customer and is going to be fixed on the firmware of the final end product power parameters.

Frequency	2405 MHz	2430 MHz	2470 MHz
Channel	Low	Middle	High



2.4 BLOCK DIGRAM SHOWING THE CONFIGURATION OF SYSTEM TESTED

Radiated Spurious Emission Test

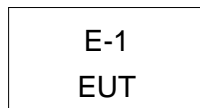

2.5 DESCRIPTION OF SUPPORT UNITS(CONDUCTED MODE)

The EUT has been tested as an independent unit together with other necessary accessories or support units. The following support units or accessories were used to form a representative test configuration during the tests.

Item	Equipment	Mfr/Brand	Model/Type No.	Series No.	Note
E-1	Wireless Mouse		SL-630014	N/A	EUT

Item	Shielded Type	Ferrite Core	Length	Note

Note:

- (1) The support equipment was authorized by Declaration of Confirmation.
- (2) For detachable type I/O cable should be specified the length in cm in 『Length』 column.
- (3) “YES” is means “shielded” “with core”; “NO” is means “unshielded” “without core”.



2.6 EQUIPMENTS LIST FOR ALL TEST ITEMS

Radiation Test equipment

Item	Equipment	Manufacturer	Type No.	Serial No.	Last calibration	Calibrated until
1	Spectrum Analyzer (9kHz-26.5GHz)	Agilent	E4407B	MY45108040	2017.08.27	2018.08.26
2	Test Receiver (9kHz-7GHz)	R&S	ESPI	101318	2017.08.27	2018.08.26
3	Bilog Antenna (30MHz-1GHz)	R&S	VULB 9168	VULB91 68-438	2017.08.27	2018.08.26
4	Horn Antenna (1GHz-18GHz)	SCHWARZBECK	BBHA9120D	1201	2017.09.03	2018.09.02
5	Horn Antenna (14GHz-40GHz)	SCHWARZBECK	BBHA 9170	9170-181	2017.09.03	2018.09.02
6	Amplifier (9KHz-6GHz)	SCHWARZBECK	BBV9744	9744-0037	2017.08.27	2018.08.26
7	Amplifier (1GHz-18GHz)	SCHWARZBECK	BBV9718	9718-309	2017.08.27	2018.08.26
8	Amplifier (18GHz-40GHz)	SCHWARZBECK	BBV 9721	9721-205	2017.08.27	2018.08.26
9	Loop Antenna (9KHz-30MHz)	SCHWARZBECK	FMZB1519B	00014	2017.09.03	2018.09.02
10	RF cables1 (9kHz-1GHz)	R&S	R203	R20X	2017.08.27	2018.08.26
11	RF cables2 (1GHz-40GHz)	R&S	R204	R21X	2017.08.27	2018.08.26
12	Antenna connector	Florida RF Labs	N/A	RF 01#	2017.08.27	2018.08.26
13	Power Metter	ANRITSU	ML2487A	6K00001568	2017.08.27	2018.08.26
14	Power Sensor (AV)	ANRITSU	ML2491A	030989	2017.08.27	2018.08.26
15	Signal Analyzer 9kHz-26.5GHz	Agilent	N9010A	MY48030494	2017.08.27	2018.08.26
16	Test Receiver 20kHz-40GHz	R&S	ESU 40	100376	2017.08.27	2018.08.26
17	D.C. Power Supply	LongWei	PS-305D	010964729	2017.08.27	2018.08.26

Conduction Test equipment

Item	Equipment	Manufacturer	Type No.	Serial No.	Last calibration	Calibrated until
1	Test Receiver	R&S	ESCI	1166.5950K03-1011 65-ha	2017.08.27	2018.08.26
2	LISN	SCHWARZBECK	NSLK8127	8127739	2017.08.27	2018.08.26
3	LISN	R&S	NSLK8126	8126487	2017.08.27	2018.08.26
4	RF cables	R&S	R204	R20X	2017.08.27	2018.08.26
5	Attenuator	R&S	ESH3-Z2	143206	2017.08.27	2018.08.26



3. EMC EMISSION TEST

3.1 RADIATED EMISSION MEASUREMENT

3.1.1 RADIATED EMISSION LIMITS (Frequency Range 9kHz-1000MHz)

20dBc in any 100 kHz bandwidth outside the operating frequency band. In case the emission fall within the restricted band specified on 15.205(a), then the 15.209(a) limit in the table below has to be followed.

Frequencies (MHz)	Field Strength (micorvolts/meter)	Measurement Distance (meters)
0.009~0.490	2400/F(KHz)	300
0.490~1.705	24000/F(KHz)	30
1.705~30.0	30	30
30~88	100	3
88~216	150	3
216~960	200	3
Above 960	500	3

LIMITS OF RADIATED EMISSION MEASUREMENT (Above 1000MHz)

FREQUENCY (MHz)	Limit (dBuV/m) (at 3M)	
	PEAK	AVERAGE
Above 1000	74	54

Notes:

- (1) The limit for radiated test was performed according to FCC PART 15C.
- (2) The tighter limit applies at the band edges.
- (3) Emission level (dBuV/m)=20log Emission level (uV/m).

FREQUENCY RANGE OF RADIATED MEASUREMENT (For unintentional radiators)

Highest frequency generated or Upper frequency of measurement used in the device or on which the device operates or tunes (MHz)	Range (MHz)
Below 1.705	30
1.705 – 108	1000
108 – 500	2000
500 – 1000	5000
Above 1000	5 th harmonic of the highest frequency or 40 GHz, whichever is lower



Spectrum Parameter	Setting
Attenuation	Auto
Start Frequency	1000 MHz
Stop Frequency	10th carrier harmonic
RB / VB (emission in restricted band)	1 MHz / 1 MHz for Peak, 1 MHz / 10Hz for Average

Receiver Parameter	Setting
Attenuation	Auto
Start ~ Stop Frequency	9kHz~150kHz / RB 200Hz for QP
Start ~ Stop Frequency	150kHz~30MHz / RB 9kHz for QP
Start ~ Stop Frequency	30MHz~1000MHz / RB 120kHz for QP

3.1.2 TEST PROCEDURE

- a. The measuring distance of at 3 m shall be used for measurements at frequency up to 25GHz. For frequencies above 1GHz, any suitable measuring distance may be used.
- b. The EUT was placed on the top of a rotating table 0.8 and 1.5 meters above the ground at a 3 meter semi-chamber test. The table was rotated 360 degrees to determine the position of the highest radiation.
- c. The height of the equipment or of the substitution antenna shall be 0.8 m; above 1GHz, the height was 1.5m, the height of the test antenna shall vary between 1 m to 4 m. Both horizontal and vertical polarizations of the antenna are set to make the measurement.
- d. The initial step in collecting conducted emission data is a spectrum analyzer peak detector mode pre-scanning the measurement frequency range. Significant peaks are then marked and then Quasi Peak detector mode re-measured.
- e. If the Peak Mode measured value compliance with and lower than Quasi Peak Mode Limit, the EUT shall be deemed to meet QP Limits and then no additional QP Mode measurement performed.
- f. For the actual test configuration, please refer to the related Item –EUT Test Photos.
- g. For the radiated emission test above 1GHz:
Place the measurement antenna away from each area of the EUT determined to be a source of emissions at the specified measurement distance, while keeping the measurement antenna aimed at the source of emissions at each frequency of significant emissions, with polarization oriented for maximum response.
The measurement antenna may have to be higher or lower than the EUT, depending on the radiation pattern of the emission and staying aimed at the emission source for receiving the maximum signal. The final measurement antenna elevation shall be that which maximizes the emissions. The measurement antenna elevation for maximum emissions shall be restricted to a range of heights of from 1 m to 4 m above the ground or reference ground plane.

Note:

Both horizontal and vertical antenna polarities were tested and performed pretest to three orthogonal axis. The worst case emissions were reported

3.1.3 DEVIATION FROM TEST STANDARD

No deviation

3.1.4 TEST SETUP

(A) Radiated Emission Test-Up Frequency Below 30MHz

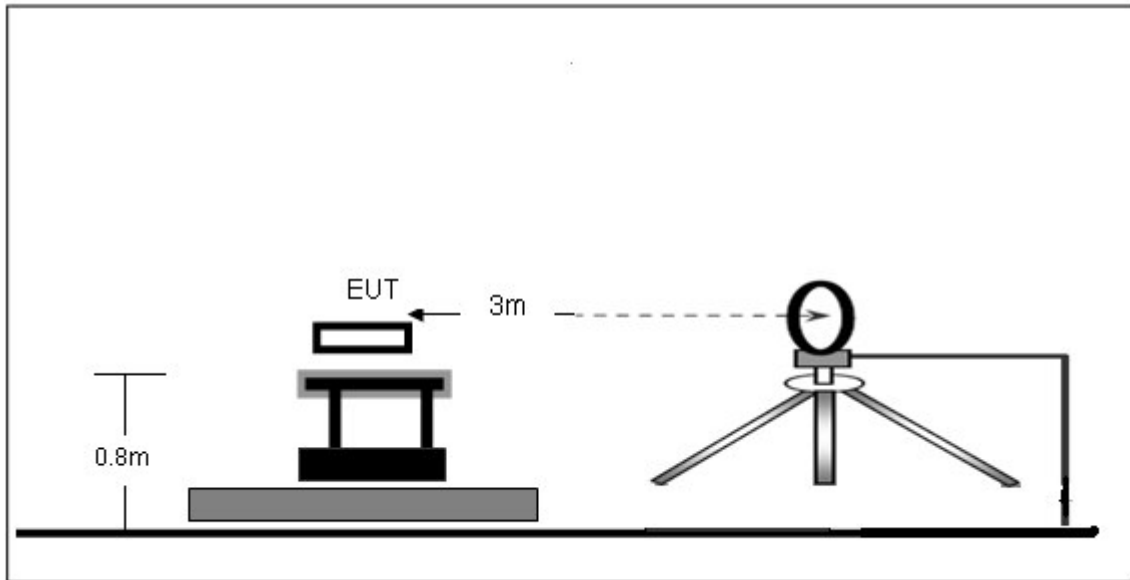

(B) Radiated Emission Test-Up Frequency 30MHz~1GHz

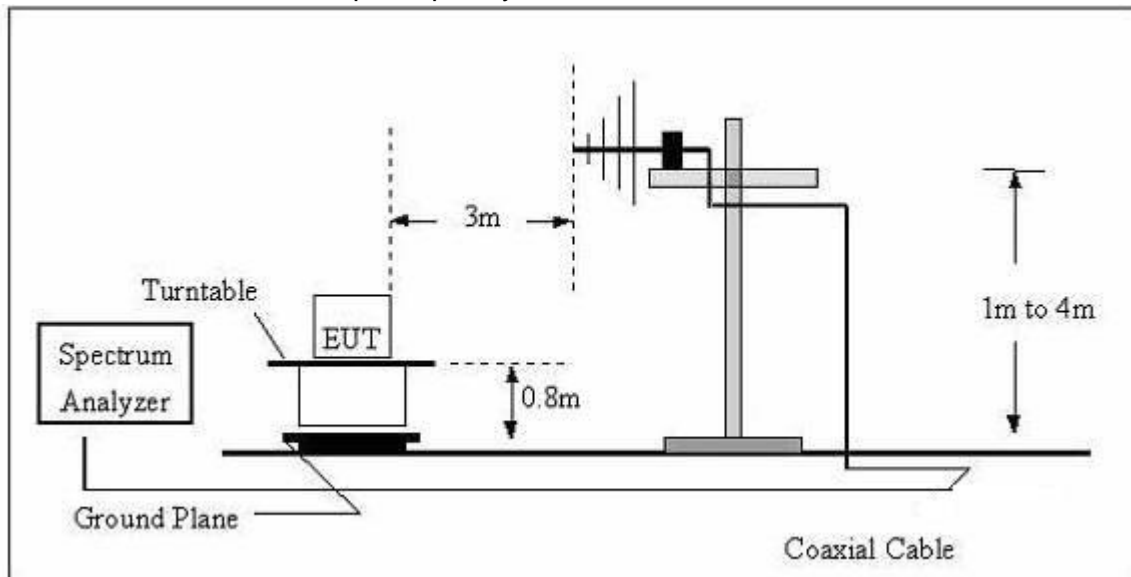

(C) Radiated Emission Test-Up Frequency Above 1GHz

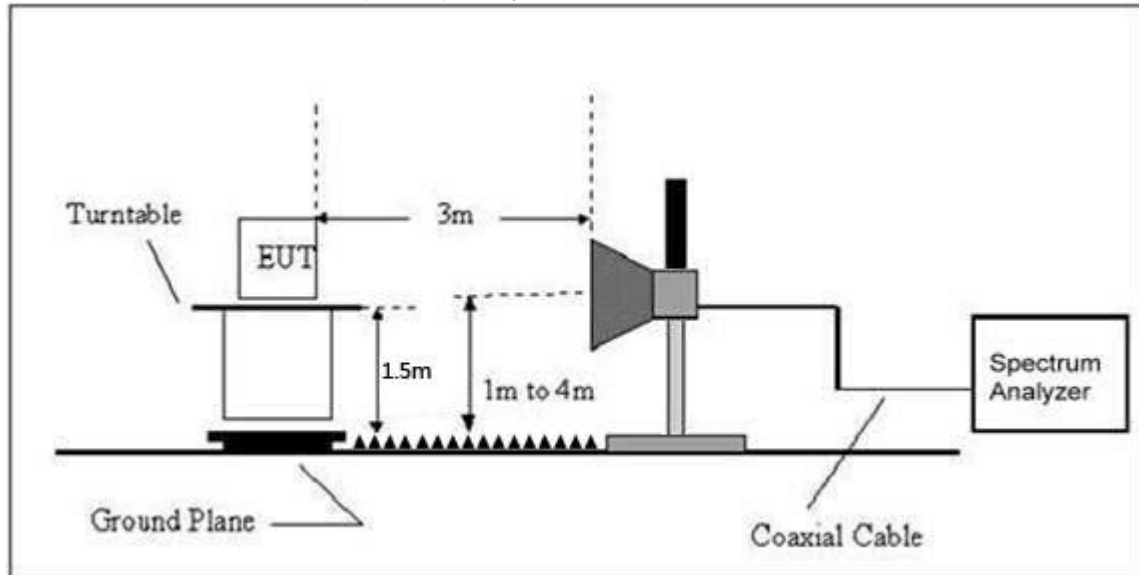

3.1.5 EUT OPERATING CONDITIONS

The EUT tested system was configured as the statements of 2.4 Unless otherwise a special operating condition is specified in the follows during the testing.



3.1.6 TEST RESULTS

Radiated Spurious Emission (Below 30MHz)

Temperature :	20 °C	Relative Humidity :	48%
Pressure :	1010 hPa	Polarization :	---
Test Voltage :	DC 1.5V		
Test Mode :	Link Mode		

Freq. (MHz)	Reading (dBuV/m)	Limit (dBuV/m)	Margin (dB)	State P/F
--	--	--	--	PASS
--	--	--	--	PASS

NOTE:

The amplitude of spurious emissions which are attenuated by more than 20dB below the permissible value has no need to be reported.

Distance extrapolation factor = $40 \log (\text{specific distance}/\text{test distance})$ (dB);

Limit line = specific limits(dBuv) + distance extrapolation factor.



Radiated Spurious Emission (Between 30MHz – 1GHz)

Temperature :	26 °C	Relative Humidity :	54%
Pressure :	1010 hPa	Polarization :	Horizontal
Test Voltage :	DC 1.5V		
Test Mode : (Worst)	Mode 4		

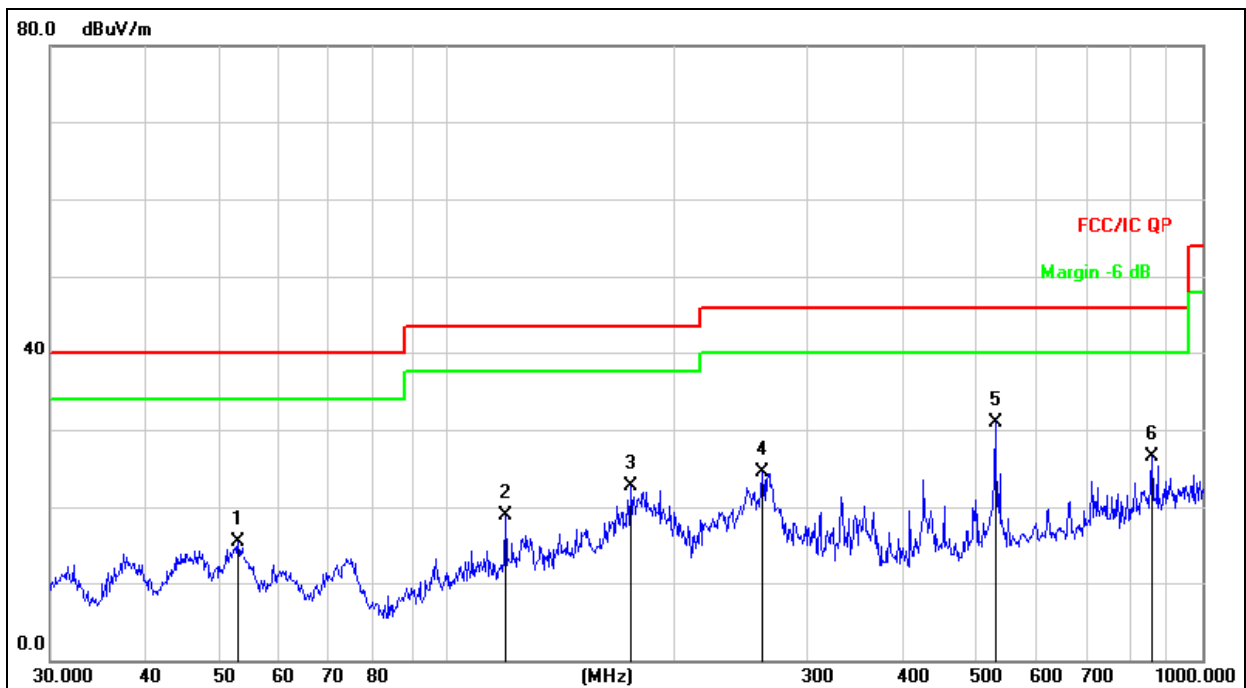

Remark:
Factor = Antenna Factor + Cable Loss – Pre-amplifier.

No.	Mk.	Freq. MHz	Reading Level dBuV	Correct Factor dB	Measure- ment dBuV/m	Limit dB/m	Over dB	Detector
1		52.9453	29.91	-14.43	15.48	40.00	-24.52	QP
2		119.8556	36.39	-17.43	18.96	43.50	-24.54	QP
3		175.0368	40.98	-18.32	22.66	43.50	-20.84	QP
4		261.9753	39.57	-14.99	24.58	46.00	-21.42	QP
5	*	531.9635	39.66	-8.81	30.85	46.00	-15.15	QP
6		854.0247	30.04	-3.49	26.55	46.00	-19.45	QP



Temperature :	26 °C	Relative Humidity :	54%
Pressure :	1010 hPa	Polarization :	Vertical
Test Voltage :	DC 1.5V		
Test Mode : (Worst)	Mode 4		

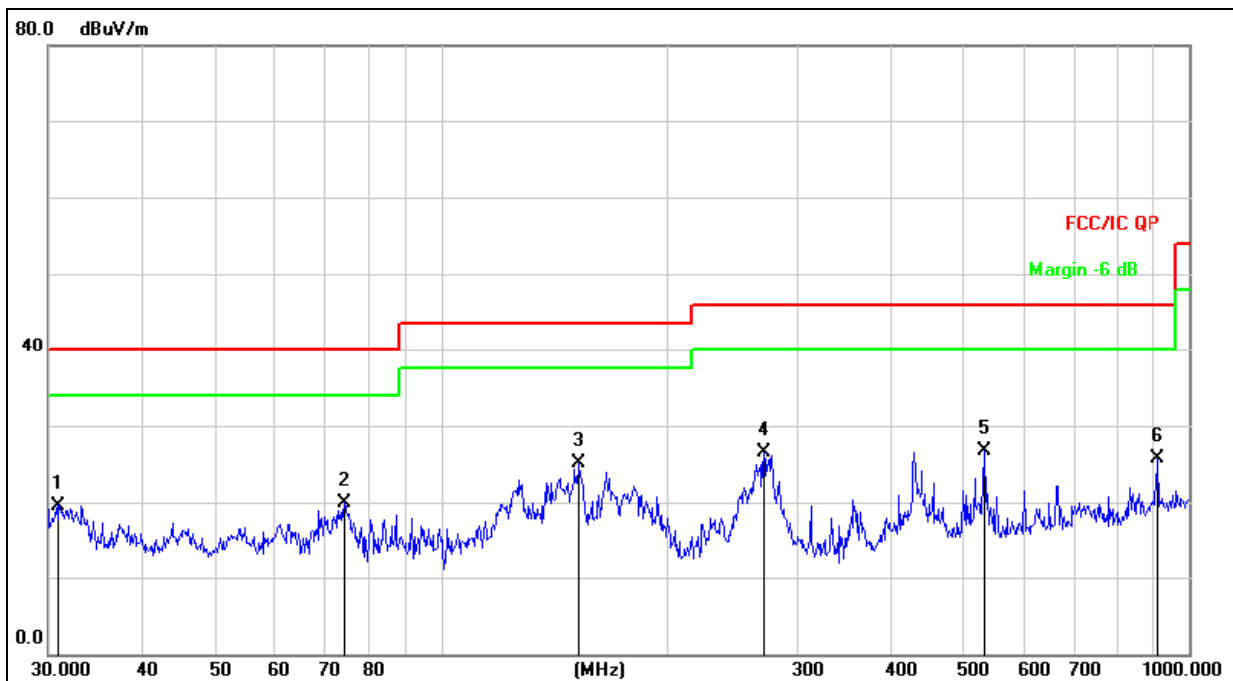

Remark:
Factor = Antenna Factor + Cable Loss – Pre-amplifier.

No.	Mk.	Freq. MHz	Reading Level dBuV	Correct Factor dB	Measure- ment dBuV/m	Limit dB/m	Over dB	Detector
1		30.9619	36.37	-16.77	19.60	40.00	-20.40	QP
2		74.3955	38.41	-18.48	19.93	40.00	-20.07	QP
3	*	153.2004	44.12	-19.00	25.12	43.50	-18.38	QP
4		270.3748	41.47	-14.93	26.54	46.00	-19.46	QP
5		533.8321	35.56	-8.77	26.79	46.00	-19.21	QP
6		909.6667	27.91	-2.29	25.62	46.00	-20.38	QP



Radiated Spurious Emission (1GHz to 10th harmonics)

Polar (H/V)	Frequency	Meter Reading	Pre-amplifier	Cable Loss	Antenna Factor	Emission Level	Limits	Margin	Detector Type
	(MHz)	(dBuV)	(dB)	(dB)	(dB/m)	(dBuV/m)	(dBuV/m)	(dB)	
Low Channel 2405MHz									
V	2405.00	105.00	38.06	7.42	20.15	94.51	114.00	-19.49	PK
V	2405.00	91.38	38.06	7.42	20.15	80.89	94.00	-13.11	AV
V	4810.00	54.12	38.53	7.78	23.25	46.62	74.00	-27.38	PK
V	4810.00	43.12	38.53	7.78	23.25	35.62	54.00	-18.38	AV
V	16132.00	43.77	38.75	10.36	26.57	41.95	74.00	-32.05	PK
H	2405.00	106.95	38.06	7.42	20.15	96.46	114.00	-17.54	PK
H	2405.00	92.48	38.06	7.42	20.15	81.99	94.00	-12.01	AV
H	4810.00	56.24	38.53	7.78	23.25	48.74	74.00	-25.26	PK
H	4810.00	42.86	38.53	7.78	23.25	35.36	54.00	-18.64	AV
H	16132.00	44.15	38.75	10.36	26.57	42.33	74.00	-31.67	PK
Middle Channel 2430MHz									
V	2430.00	104.08	38.11	7.44	20.36	93.77	114.00	-20.23	PK
V	2430.00	87.18	38.11	7.44	20.36	76.87	94.00	-17.13	AV
V	4860.00	53.40	38.65	7.80	23.61	46.16	74.00	-27.84	PK
V	4860.00	44.93	38.65	7.80	23.61	37.69	54.00	-16.31	AV
V	16132.00	42.68	38.75	10.36	26.57	40.86	74.00	-33.14	PK
H	2430.00	104.79	38.11	7.44	20.36	94.48	114.00	-19.52	PK
H	2430.00	85.80	38.11	7.44	20.36	75.49	94.00	-18.51	AV
H	4860.00	53.03	38.65	7.80	23.61	45.79	74.00	-28.21	PK
H	4860.00	43.51	38.65	7.80	23.61	36.27	54.00	-17.73	AV
H	16132.00	42.73	38.75	10.36	26.57	40.91	74.00	-33.09	PK
High Channel 2470MHz									
V	2470.00	105.11	38.17	7.47	20.51	94.92	114.00	-19.08	PK
V	2470.00	92.55	38.17	7.47	20.51	82.36	94.00	-11.64	AV
V	4940.00	52.55	38.69	7.83	23.83	45.52	74.00	-28.48	PK
V	4940.00	44.62	38.69	7.83	23.83	37.59	54.00	-16.41	AV
V	16132.00	44.54	38.75	10.36	26.57	42.72	74.00	-31.28	PK
H	2470.00	101.13	38.17	7.47	20.51	90.94	114.00	-23.06	PK
H	2470.00	89.98	38.17	7.47	20.51	79.79	94.00	-14.21	AV
H	4940.00	56.32	38.69	7.83	23.83	49.29	74.00	-24.71	PK
H	4940.00	44.40	38.69	7.83	23.83	37.37	54.00	-16.63	AV
H	16132.00	44.67	38.75	10.36	26.57	42.85	74.00	-31.15	PK

Remark:

1. Emission Level = Meter Reading + Antenna Factor + Cable Loss – Pre-amplifier, Margin= Emission Level - Limit
2. If peak below the average limit, the average emission was no test.
3. The amplitude of spurious emissions which are attenuated by more than 20dB below the permissible value has no need to be reported.



CONDUCTED EMISSION MEASUREMENT

GFSK

Low Channel 2405MHz

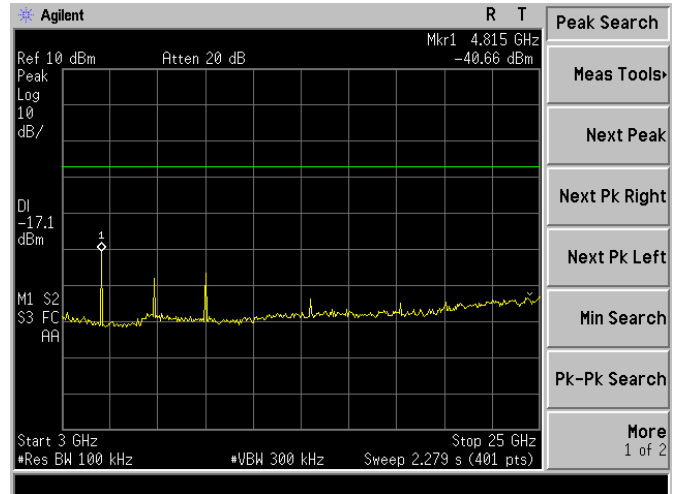
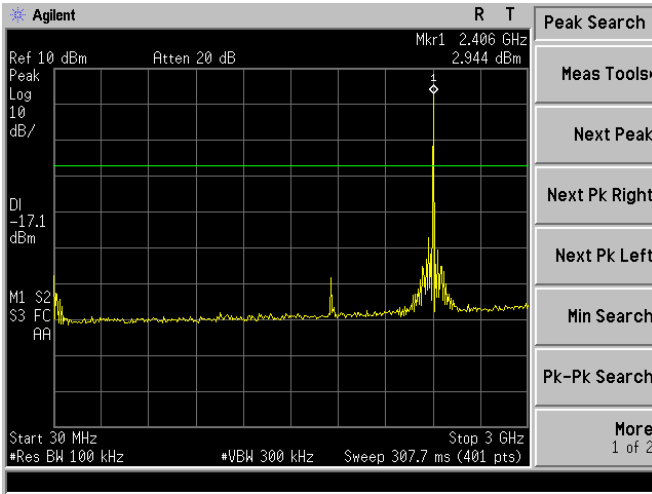

Middle Channel 2430MHz

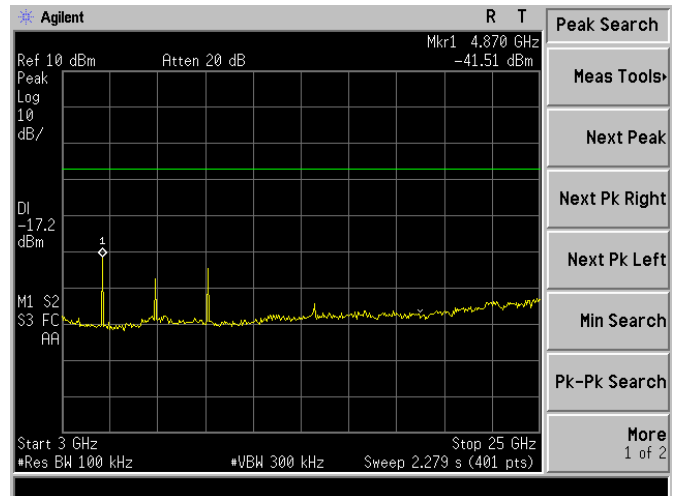
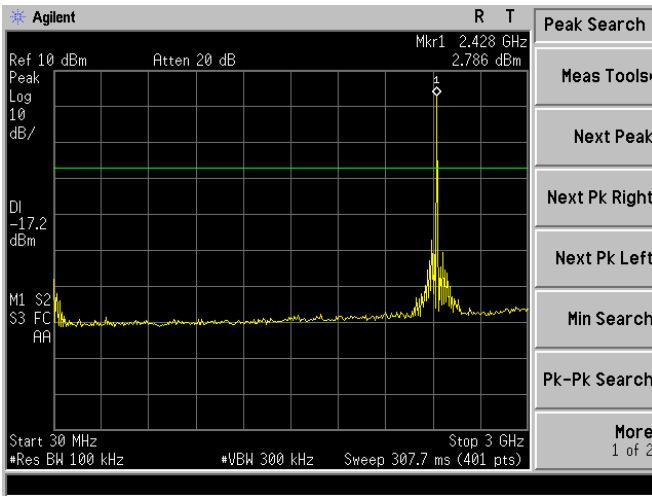

High Channel 2470MHz

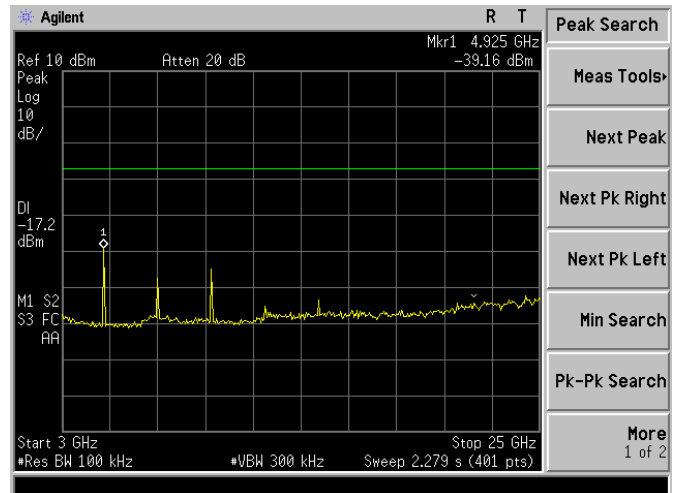
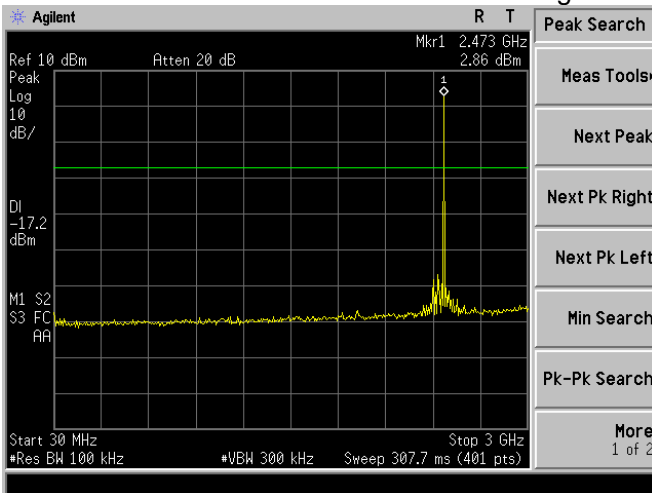



4. BANDWIDTH TEST

4.1 APPLIED PROCEDURES / LIMIT

FCC Part15 (15.249) , Subpart C				
Section	Test Item	Limit	Frequency Range (MHz)	Result
15.249	Bandwidth	(20dB bandwidth)	2400-2483.5	PASS

Spectrum Parameter	Setting
Attenuation	Auto
Span Frequency	> Measurement Bandwidth or Channel Separation
RB	100KHz
VB	≥RBW
Detector	Peak
Trace	Max Hold
Sweep Time	Auto

4.1.1 TEST PROCEDURE

- a. The EUT was directly connected to the spectrum analyzer and antenna output port as show in the block diagram below,
- b. Spectrum Setting : RBW= 100KHz, VBW≥ RBW, Sweep time = Auto.

4.1.2 DEVIATION FROM STANDARD

No deviation.

4.1.3 TEST SETUP

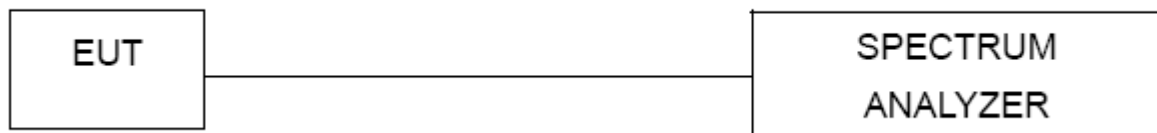

4.1.4 EUT OPERATION CONDITIONS

The EUT tested system was configured as the statements of 2.4 Unless otherwise a special operating condition is specified in the follows during the testing.



4.1.5 TEST RESULTS

Temperature :	25 °C	Relative Humidity :	54%
Pressure :	1012 hPa	Test Voltage :	DC 1.5V
Test Mode :	CH00/CH03 /CH07		

Frequency	20dB Bandwidth (MHz)	Result
2405 MHz	2.613	PASS
2430 MHz	2.592	PASS
2470 MHz	2.641	PASS

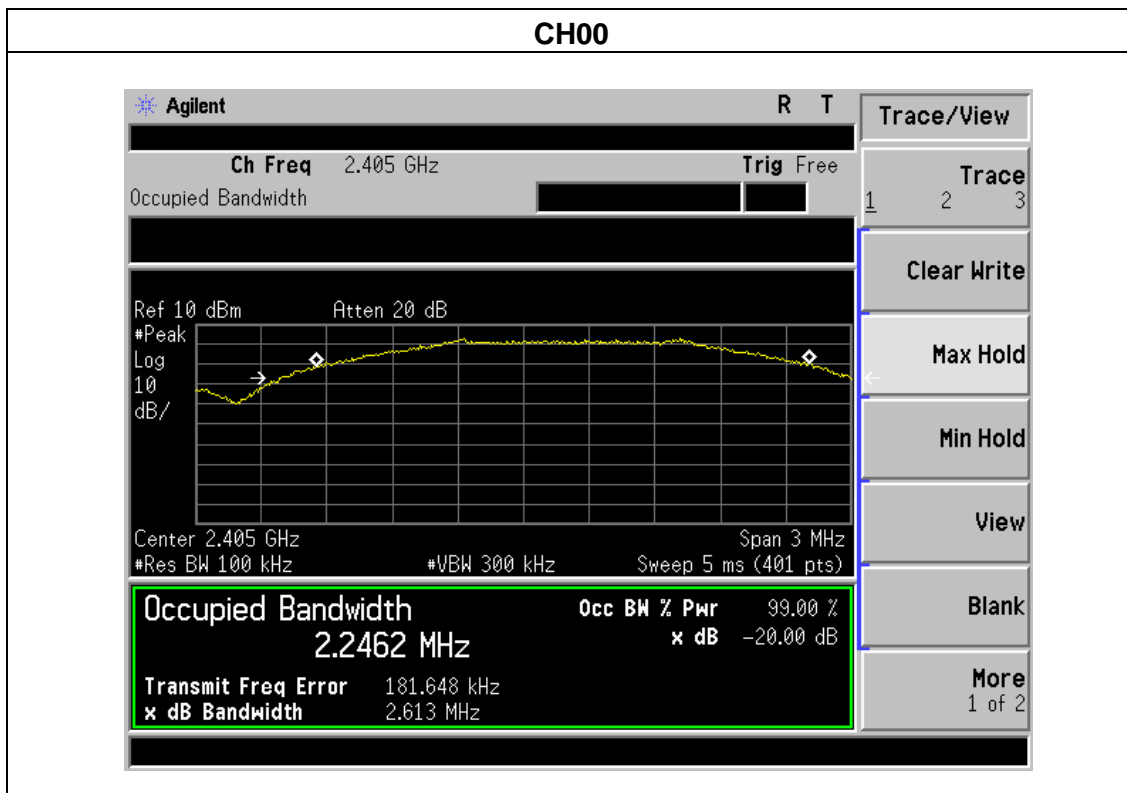

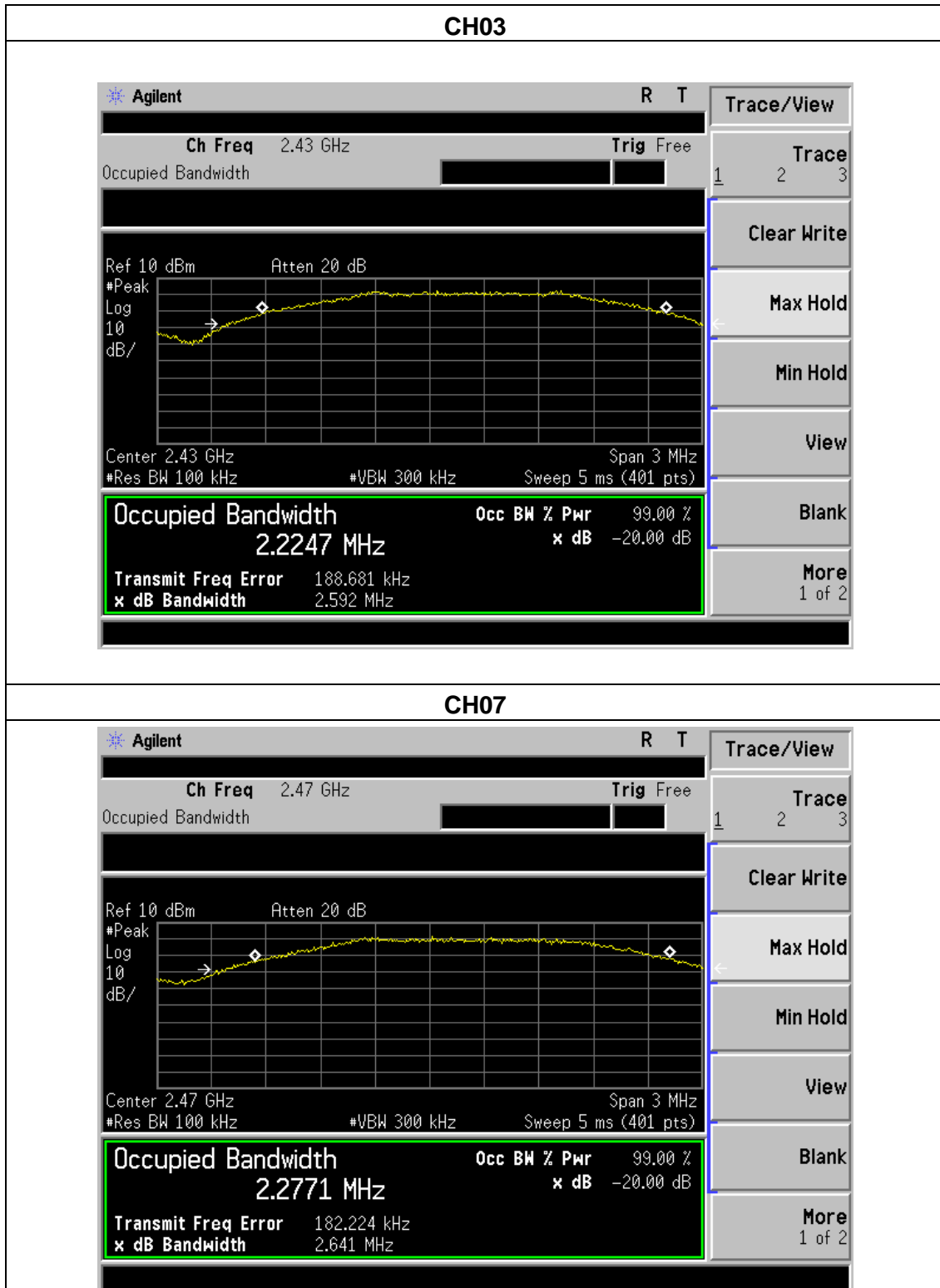



5. 100 KHZ BANDWIDTH OF FREQUENCY BAND EDGE APPLICABLE STANDARD

Emissions radiated outside of the specified frequency bands, except for harmonics, shall be attenuated by at least 50 dB below the level of the fundamental or to the general radiated emission limits in § 15.209, whichever is the lesser attenuation

TEST PROCEDURE

- a) Check the calibration of the measuring instrument using either an internal calibrator or a known signal from an external generator.
- b) Position the EUT without connection to measurement instrument. Turn on the EUT and connect its antenna terminal to measurement instrument via a low loss cable. Then set it to any one measured frequency within its operating range, and make sure the instrument is operated in its linear range.
- c) i) VBW for Peak, Quasi-peak, or Average Detector Function: $3 \times \text{RBW}$
- d) Repeat above procedures until all measured frequencies were complete.

Note:

Both horizontal and vertical antenna polarities were tested and performed pretest to three orthogonal axis. The worst case emissions were reported

5.1 DEVIATION FROM STANDARD

No deviation.

5.2 TEST SETUP

5.3 EUT OPERATION CONDITIONS

The EUT tested system was configured as the statements of 2.4 Unless otherwise a special operating condition is specified in the follows during the testing.



5.4 TEST RESULTS

Temperature :	25 °C	Relative Humidity :	54%
Pressure :	1012 hPa	Test Voltage :	DC 1.5V
Test Mode :	CH00/CH07		

Polar (H/V)	Frequency (MHz)	Meter Reading (dBuV)	Pre-amplifier (dB)	Cable Loss (dB)	Antenna Factor (dB/m)	Emission level (dBuV/m)	Limits (dBuV/m)		Result
						PK	PK	AV	
Low Channel 2405MHz									
H	2390.00	49.04	38.06	7.42	20.15	38.55	74.00	54.00	PASS
H	2400.00	47.96	38.06	7.42	20.15	37.47	74.00	54.00	PASS
V	2390.00	48.81	38.06	7.42	20.15	38.32	74.00	54.00	PASS
V	2400.00	48.70	38.06	7.42	20.15	38.21	74.00	54.00	PASS
High Channel 2470MHz									
H	2483.50	44.74	38.17	7.45	20.54	34.53	74.00	54.00	PASS
H	2485.00	43.73	38.17	7.45	20.54	33.52	74.00	54.00	PASS
V	2483.50	43.45	38.20	7.45	20.54	33.24	74.00	54.00	PASS
V	2485.00	43.35	38.20	7.45	20.54	33.14	74.00	54.00	PASS
Remark:									
1. Emission Level = Meter Reading + Antenna Factor + Cable Loss – Pre-amplifier, Margin= Emission Level - Limit									
2. If the PK measured levels comply with average limit, then the average level were deemed to comply with average limit.									



2405MHz Horizontal

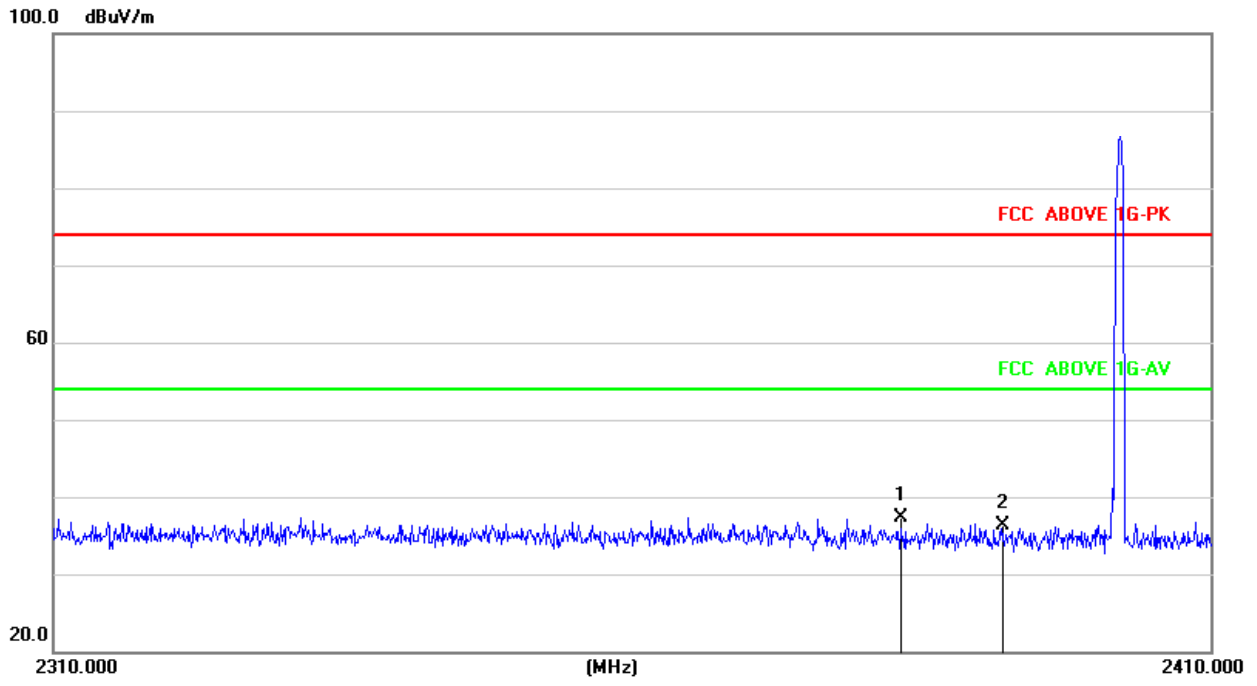

2405MHz Vertical

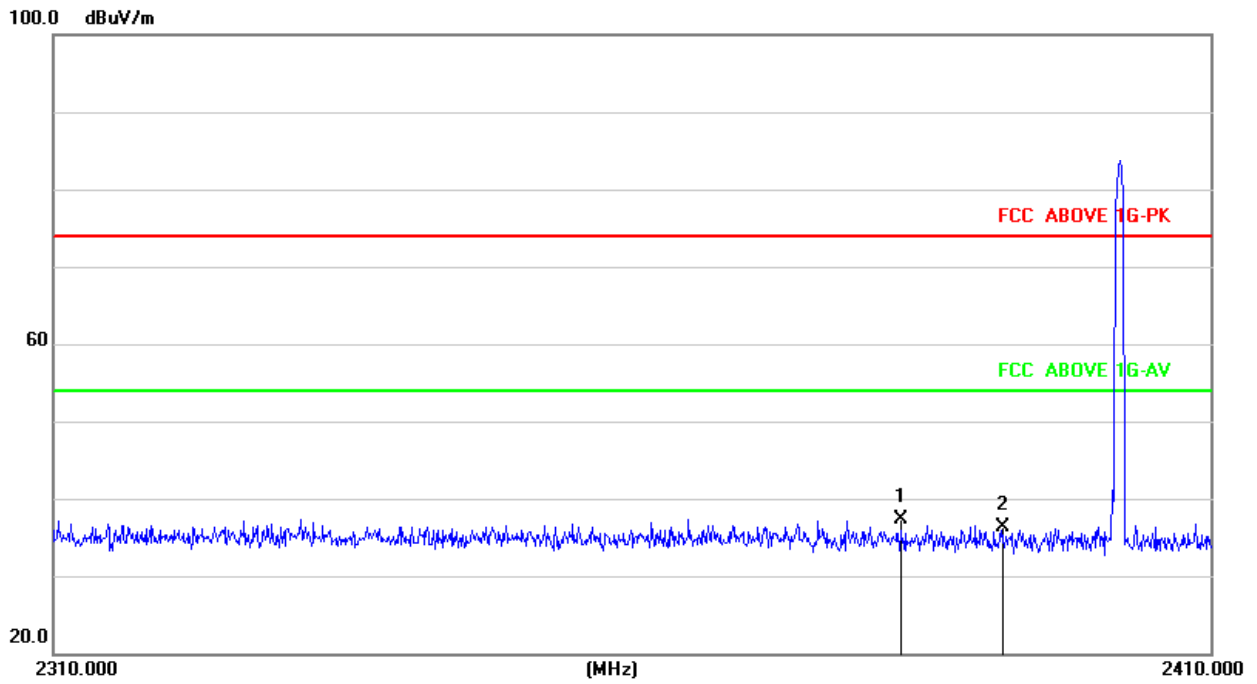



2470MHz Horizontal

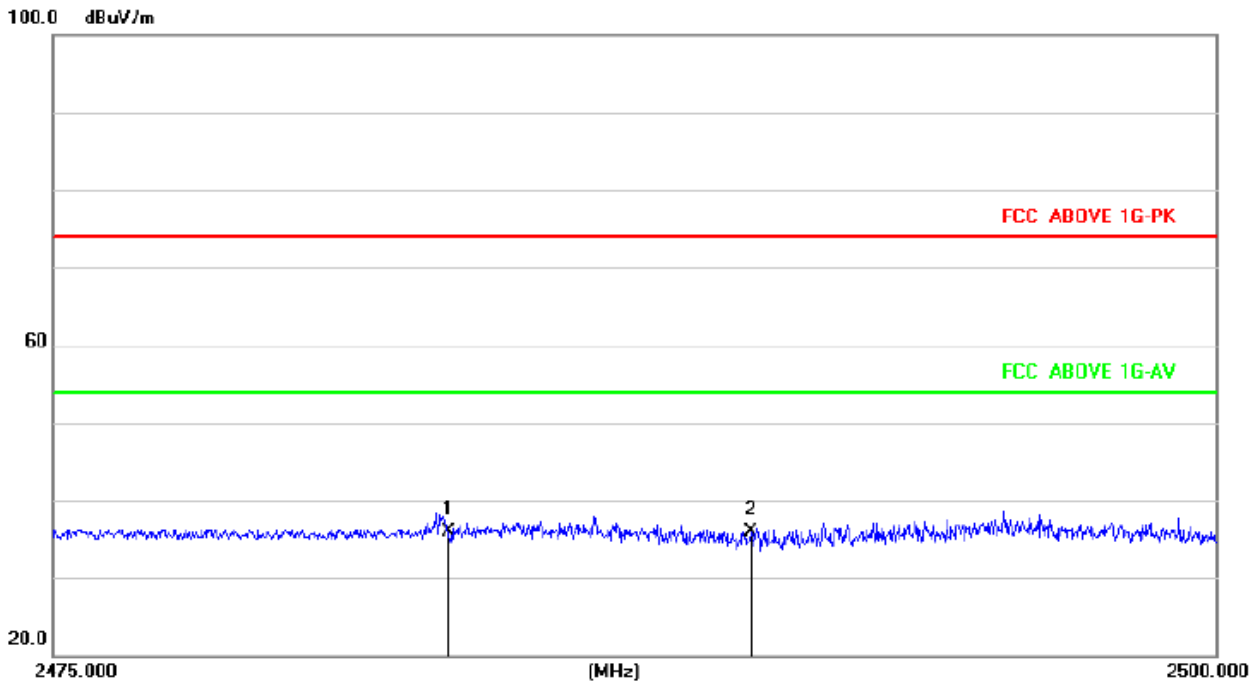

2470MHz Vertical

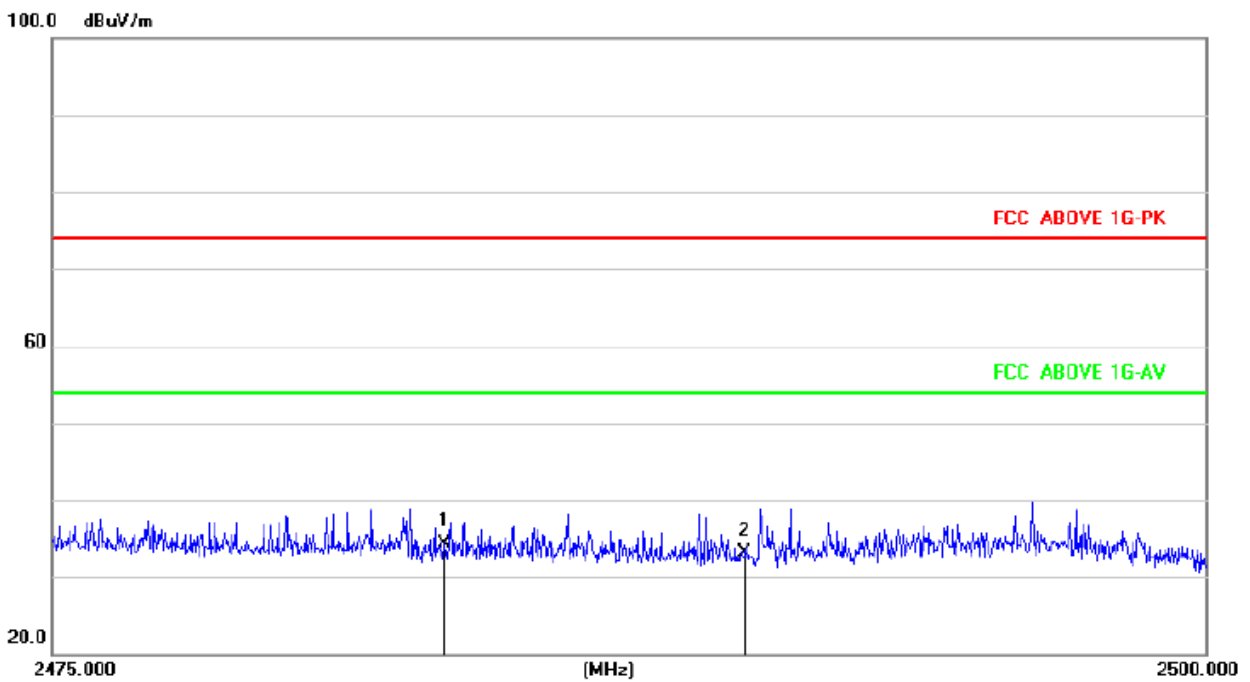



6. ANTENNA REQUIREMENT

6.1 STANDARD REQUIREMENT

15.203 requirement: For intentional device, according to 15.203: an intentional radiator shall be designed to ensure that no antenna other than that furnished by the responsible party shall be used with the device.

6.2 EUT ANTENNA

The EUT antenna is PCB antenna. It complies with the standard requirement.

7. EUT TEST PHOTOS

Radiated Measurement Photos

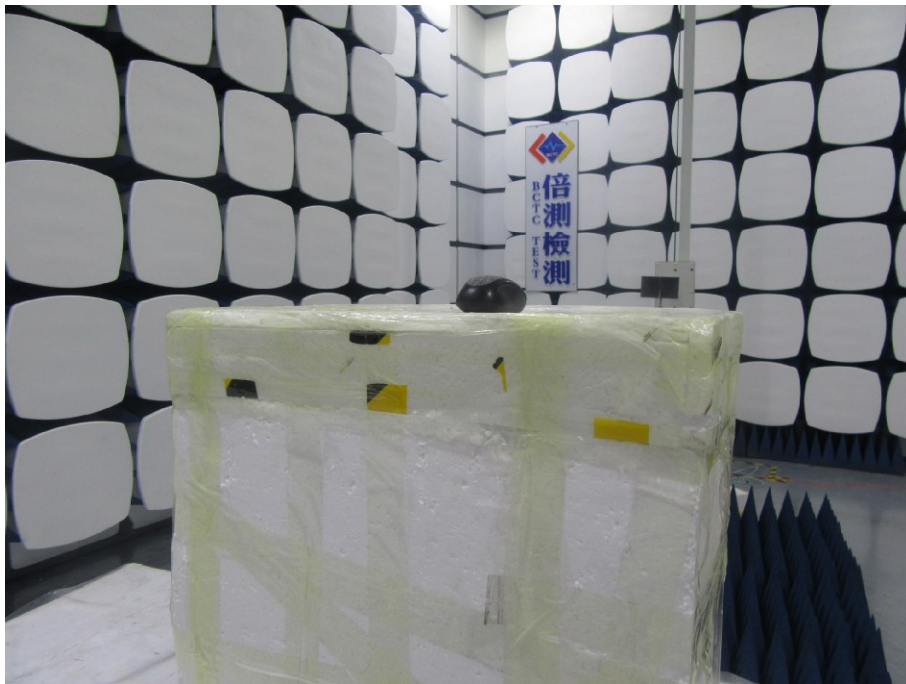
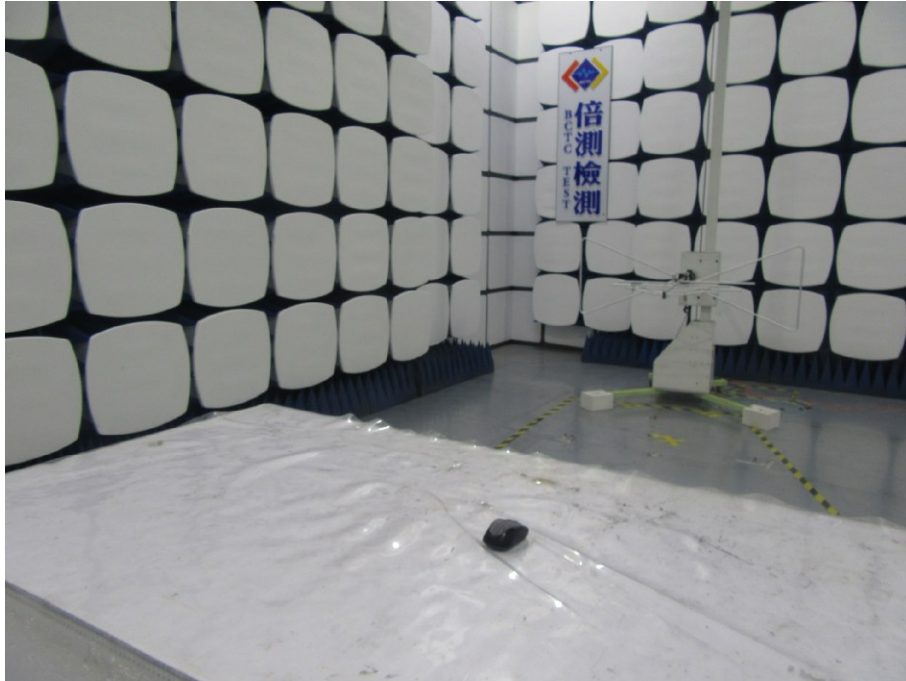

8. PHOTOS OF THE EUT



***** END OF REPORT *****