

# FCC Part 15C Test Report

## FCC ID:2AEBY-DG078

<b>Product Name:</b>	Wireless Controller for Switch
<b>Trademark:</b>	N/A
<b>Model Name :</b>	DG078 3002701, 5148201, 3002601, 5148001
<b>Prepared For :</b>	ShenZhen Targetever Technology Co., Ltd.
<b>Address :</b>	Floor 11-12, Building 8, LianHua Industrial Park, LongYuan Road, LongHua New District, ShenZhen, China
<b>Prepared By :</b>	Shenzhen BCTC Testing Co., Ltd.
<b>Address :</b>	BCTC Building & 1-2F, East of B Building, Pengzhou Industrial, Fuyuan 1st Road, Qiaotou Community, Fuyong Street, Bao'an District, Shenzhen, China
<b>Test Date:</b>	Aug. 06, 2020 to Aug. 19, 2020
<b>Date of Report :</b>	Aug. 19, 2020
<b>Report No.:</b>	BCTC2008000353E

### TEST RESULT CERTIFICATION

**Applicant's name**.....: ShenZhen Targetever Technology Co., Ltd.  
**Address**.....: Floor 11-12, Building 8, LianHua Industrial Park, LongYuan Road, LongHua New District, ShenZhen, China  
**Manufacture's Name**.....: ShenZhen Targetever Technology Co., Ltd.  
**Address**.....: Floor 11-12, Building 8, LianHua Industrial Park, LongYuan Road, LongHua New District, ShenZhen, China

#### Product description

**Product name**.....: Wireless Controller for Switch  
**Trademark**.....: N/A  
**Model and/or type reference**.....: DG078  
3002701, 5148201, 3002601, 5148001  
**Standards**.....: FCC Part15.247  
ANSI C63.10:2013  
558074 D01 15.247 Meas Guidance v05r02

This device described above has been tested by BCTC, and the test results show that the equipment under test (EUT) is in compliance with the FCC requirements. And it is applicable only to the tested sample identified in the report.

This report shall not be reproduced except in full, without the written approval of BCTC, this document may be altered or revised by BCTC, personal only, and shall be noted in the revision of the document.

Prepared by(Engineer): Kelsey Tan

*Kelsey Tan*

Approved(Manager): Zero Zhou



**Table of Contents**

Test Report Declaration	Page
<b>1. TEST SUMMARY.....</b>	<b>5</b>
<b>2. TEST FACILITY.....</b>	<b>6</b>
<b>3. MEASUREMENT UNCERTAINTY.....</b>	<b>6</b>
<b>4. GENERAL INFORMATION.....</b>	<b>7</b>
4.1 GENERAL DESCRIPTION OF EUT.....	7
4.2 Test Setup Configuration.....	8
4.3 Support Equipment.....	8
4.4 Channel List.....	9
4.5 Test Mode.....	10
<b>5. TEST FACILITY AND TEST INSTRUMENT USED.....</b>	<b>11</b>
5.1 Test Facility.....	11
5.2 Test Instrument Used.....	11
<b>6. CONDUCTED EMISSIONS.....</b>	<b>13</b>
6.1 Block Diagram Of Test Setup.....	13
6.2 Limit.....	13
6.3 Test procedure.....	13
6.4 Test Result.....	15
<b>7. RADIATED EMISSIONS.....</b>	<b>17</b>
7.1 Block Diagram Of Test Setup.....	17
7.2 Limit.....	18
7.3 Test procedure.....	18
7.4 Test Result.....	20
7.5 RADIATED BAND EMISSION MEASUREMENT AND RESTRICTED BANDS OF OPERATION.....	24
<b>8. CONDUCTED EMISSION.....</b>	<b>27</b>
8.1 Block Diagram Of Test Setup.....	27
8.2 Limit.....	27
8.3 Test procedure.....	27
8.4 Test Result.....	28
<b>9. 20 DB BANDWIDTH.....</b>	<b>34</b>
9.1 Block Diagram Of Test Setup.....	34
9.2 Limit.....	34
9.3 Test procedure.....	34
9.4 Test Result.....	35
<b>10. MAXIMUM PEAK OUTPUT POWER.....</b>	<b>39</b>
10.1 Block Diagram Of Test Setup.....	39
10.2 Limit.....	39
10.3 Test procedure.....	39
10.4 Test Result.....	40
<b>11. HOPPING CHANNEL SEPARATION.....</b>	<b>44</b>
11.1 Block Diagram Of Test Setup.....	44

11.2	Limit.....	44
11.3	Test procedure.....	44
11.4	Test Result.....	45
<b>12.</b>	<b>NUMBER OF HOPPING FREQUENCY.....</b>	<b>49</b>
12.1	Block Diagram Of Test Setup.....	49
12.2	Limit.....	49
12.3	Test procedure.....	49
12.4	Test Result.....	50
<b>13.</b>	<b>DWELL TIME.....</b>	<b>51</b>
13.1	Block Diagram Of Test Setup.....	51
13.2	Limit.....	51
13.3	Test procedure.....	51
13.4	Test Result.....	52
<b>14.</b>	<b>ANTENNA REQUIREMENT.....</b>	<b>56</b>
<b>15.</b>	<b>EUT PHOTOGRAPHS.....</b>	<b>57</b>
<b>16.</b>	<b>EUT TEST SETUP PHOTOGRAPHS.....</b>	<b>58</b>

*(Note: N/A means not applicable)*

## 1. TEST SUMMARY

Test procedures according to the technical standards:

<b>FCC Part15 (15.247) , Subpart C</b>			
Standard Section	Test Item	Judgment	Remark
15.205(a) 15.209 15.247(d)	Radiated Spurious Emissions	PASS	
15.247(d)	Conducted Spurious emissions	PASS	
15.247(d) 15.205(a)	Band edge	PASS	
15.207	Conducted Emission	PASS	
15.247(a)	20dB Bandwidth	PASS	
15.247(b)	Maximum Peak Output Power	PASS	
15.247(a)	Frequency Separation	PASS	
15.247(a)	Number of Hopping Frequency	PASS	
15.247(a)	Dwell time	PASS	
15.203	Antenna Requirement	PASS	
Note: (1) "N/A" denotes test is not applicable in this Test Report			

## 2. TEST FACILITY

Shenzhen BCTC Testing Co., Ltd.

Add. : BCTC Building & 1-2F, East of B Building, Pengzhou Industrial, Fuyuan 1st Road, Qiaotou Community, Fuyong Street, Bao'an District, Shenzhen, China

Test Firm Registration Number: 712850

IC Registered No.: 23583

## 3. MEASUREMENT UNCERTAINTY

The reported uncertainty of measurement  $y \pm U$ , where expanded uncertainty  $U$  is based on a standard uncertainty multiplied by a coverage factor of  $k=2$ , providing a level of confidence of approximately 95 %.

No.	Item	Uncertainty
1	3m chamber Radiated spurious emission(30MHz-1GHz)	U=4.3dB
2	3m chamber Radiated spurious emission(1GHz-18GHz)	U=4.5dB
3	3m chamber Radiated spurious emission(18GHz-40GHz)	U=3.34dB
4	Conducted Adjacent channel power	U=1.38dB
5	Conducted output power uncertainty Above 1G	U=1.576dB
6	Conducted output power uncertainty below 1G	U=1.28dB
7	humidity uncertainty	U=5.3%
8	Temperature uncertainty	U=0.59°C

## 4. GENERAL INFORMATION

### 4.1 GENERAL DESCRIPTION OF EUT

Equipment	Wireless Controller for Switch	
Trade Name	N/A	
Model Name	DG078 3002701, 5148201, 3002601, 5148001	
Model Difference	All models are identical except for the appearance color, the test model is DG078 and the test results are applicable to other tests.	
Product Description	The EUT is a Wireless Controller for Switch	
	Operation Frequency:	2402-2480 MHz
	Modulation Type:	GFSK, Pi/4DQPSK
	Number Of Channel	79CH
	Antenna Designation:	PCB antenna
	Antenna Gain	0dBi
Channel List	Please refer to the section 4.4.	
Ratings	USB:DC 5V Battery:DC 3.7V	
Connecting I/O Port(s)	Please refer to the User's Manual	

## 4.2 Test Setup Configuration

See test photographs attached in EUT TEST SETUP Photographs for the actual Conducted Emission Test

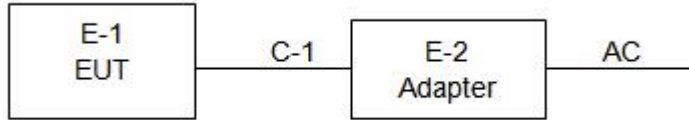

### Radiated Spurious Emission

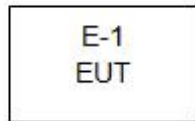

## 4.3 Support Equipment

No.	Device Type	Brand	Model	Series No.	Data Cable
E-1	Wireless Controller for Switch	N/A	DG078	N/A	EUT
E-2	Adapter	N/A	BCTC001	N/A	Auxiliary

Item	Shielded Type	Ferrite Core	Length	Note
C-1	NO	NO	0.5M	DC cable unshielded

### Notes:

1. All the equipment/cables were placed in the worst-case configuration to maximize the emission during the test.
2. Grounding was established in accordance with the manufacturer's requirements and conditions for the intended use.



#### 4.4 Channel List

CH	Frequency (MHz)	CH	Frequency (MHz)	CH	Frequency (MHz)	CH	Frequency (MHz)
0	2402	1	2403	2	2404	3	2405
4	2406	5	2407	6	2408	7	2409
8	2410	9	2411	10	2412	11	2413
12	2414	13	2415	14	2416	15	2417
16	2418	17	2419	18	2420	19	2421
20	2422	21	2423	22	2424	23	2425
24	2426	25	2427	26	2428	27	2429
28	2430	29	2431	30	2432	31	2433
32	2434	33	2435	34	2436	35	2437
36	2438	37	2439	38	2440	39	2441
40	2442	41	2443	42	2444	43	2445
44	2446	45	2447	46	2448	47	2449
48	2450	49	2451	50	2452	51	2453
52	2454	53	2455	54	2456	55	2457
56	2458	57	2459	58	2460	59	2461
60	2462	61	2463	62	2464	63	2465
64	2466	65	2467	66	2468	67	2469
68	2470	69	2471	70	2472	71	2473
72	2474	73	2475	74	2476	75	2477
76	2478	77	2479	78	2480	79	/

#### 4.5 Test Mode

All test mode(s) and condition(s) mentioned were considered and evaluated respectively by performing full tests, the worst data were recorded and reported.

During testing, Channel and Power Controlling Software provided by the customer was used to control the operating channel as well as the output power level. The RF output power selection is for the setting of RF output power expected by the customer and is going to be fixed on the firmware of the final end product.

The EUT is Continue Transmitting.

The software is installed in operation system, named "SecureCRT" ,Version 1.0.

Test Mode	Test mode	Low channel	Middle channel	High channel
1	Transmitting(GFSK)	2402MHz	2441MHz	2480MHz
2	Transmitting(Pi/4DQPSK)	2402MHz	2441MHz	2480MHz
3	Charging(Conducted Emission)			
4.	Transmitting (Radiated emission)			

## 5. TEST FACILITY AND TEST INSTRUMENT USED

### 5.1 Test Facility

All measurement facilities used to collect the measurement data are located at BCTC Building & 1-2F, East of B Building, Pengzhou Industrial, Fuyuan 1st Road, Qiaotou Community, Fuyong Street, Bao'an District, Shenzhen, China. The site and apparatus are constructed in conformance with the requirements of ANSI C63.4 and CISPR 16-1-1 other equivalent standards.

### 5.2 Test Instrument Used

RF conduction and Radiation Test equipment

Item	Equipment	Manufacturer	Type No.	Serial No.	Last calibration	Calibrated until
1	Spectrum Analyzer (9kHz-26.5GHz)	Agilent	E4407B	MY45109572	Jun. 08, 2020	Jun. 07, 2021
2	Test Receiver (9kHz-7GHz)	R&S	ESR7	101154	Jun. 08, 2020	Jun. 07, 2021
3	Bilog Antenna (30MHz-3GHz)	SCHWARZB ECK	VULB9163	VULB9163-942	Jun. 08, 2020	Jun. 07, 2021
4	Horn Antenna (1GHz-18GHz)	SCHWARZB ECK	BBHA9120D	1541	Jun. 10, 2020	Jun. 09, 2021
5	Horn Antenna (18GHz-40GHz)	SCHWARZB ECK	BBHA9170	00822	Jun. 10, 2020	Jun. 09, 2021
6	Amplifier (9KHz-6GHz)	SCHWARZB ECK	BBV9744	9744-0037	Jun. 04, 2020	Jun. 03, 2021
7	Amplifier (0.5GHz-18GHz)	SCHWARZB ECK	BBV9718	9718-309	Jun. 04, 2020	Jun. 03, 2021
8	Amplifier (18GHz-40GHz)	MITEQ	TTA1840-35-HG	2034381	Jun. 08, 2020	Jun. 07, 2021
9	Loop Antenna (9KHz-30MHz)	SCHWARZB ECK	FMZB1519B	00014	Jun. 08, 2020	Jun. 07, 2021
10	RF cables1 (9kHz-30MHz)	Huber+Suhner	9kHz-30MHz	B1702988-0008	Jun. 08, 2020	Jun. 07, 2021
11	RF cables2 (30MHz-1GHz)	Huber+Suhner	30MHz-1GHz	1486150	Jun. 08, 2020	Jun. 07, 2021
12	RF cables3 (1GHz-40GHz)	Huber+Suhner	1GHz-40GHz	1607106	Jun. 08, 2020	Jun. 07, 2021
13	Power Metter	Keysight	E4419B	\	Jun. 08, 2020	Jun. 07, 2021
14	Power Sensor (AV)	Keysight	E9 300A	\	Jun. 08, 2020	Jun. 07, 2021
15	Signal Analyzer 20kHz-26.5GHz	KEYSIGHT	N9020A	MY49100060	Jun. 04, 2020	Jun. 03, 2021
16	Spectrum Analyzer 9kHz-40GHz	Agilent	FSP40	100363	Jun. 13, 2020	Jun. 12, 2021
17	D.C. Power Supply	LongWei	TPR-6405D	\	\	\
18	Software	Frad	EZ-EMC	FA-03A2 RE	\	\

## Conduction Test equipment

Item	Equipment	Manufacturer	Type No.	Serial No.	Last calibration	Calibrated until
1	Test Receiver	R&S	ESR3	102075	Jun. 08, 2020	Jun. 07, 2021
2	LISN	SCHWARZBECK	NSLK8127	8127739	Jun. 13, 2020	Jun. 12, 2021
3	LISN	R&S	ENV216	101375	Jun. 04, 2020	Jun. 03, 2021
4	RF cables	Huber+Suhnar	9kHz-30MHz	B1702988-0008	Jun. 08, 2020	Jun. 07, 2021
5	Software	Frad	EZ-EMC	EMC-CON 3A1	\	\

## 6. CONDUCTED EMISSIONS

### 6.1 Block Diagram Of Test Setup

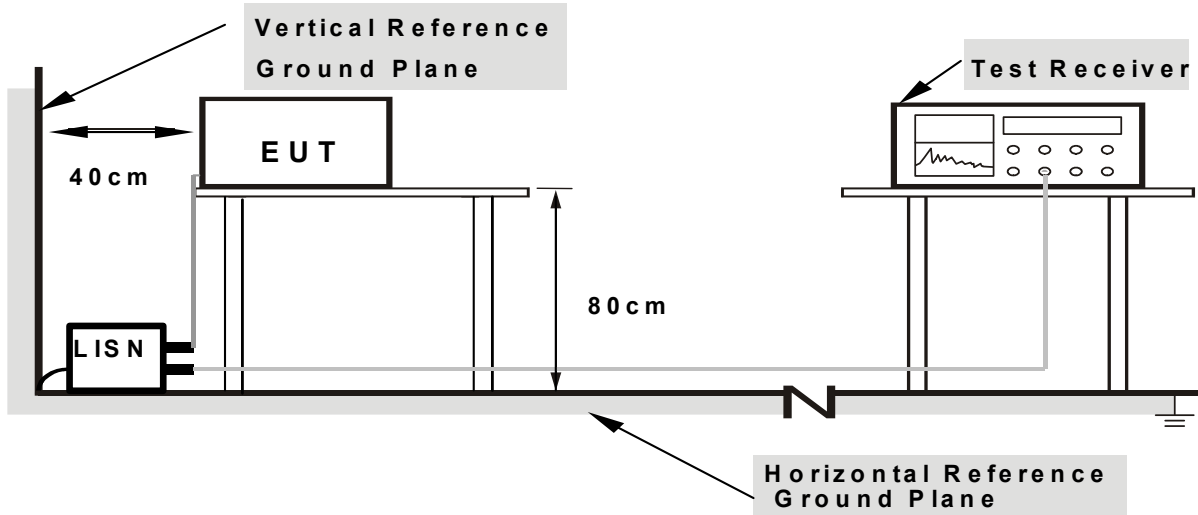

Note: 1.Support units were connected to second LISN.

2.Both of LISNs (AMN) are 80 cm from EUT and at least 80 cm from other units and other metal planes

### 6.2 Limit

FREQUENCY (MHz)	Limit (dBUV)		Standard
	Quasi-peak	Average	
0.15 -0.5	66 - 56 *	56 - 46 *	FCC
0.50 -5.0	56.00	46.00	FCC
5.0 -30.0	60.00	50.00	FCC

### 6.3 Test procedure

Receiver Parameters	Setting
Attenuation	10 dB
Start Frequency	0.15 MHz
Stop Frequency	30 MHz
IF Bandwidth	9 kHz

a. The EUT was placed 0.8 meters from the horizontal ground plane with EUT being connected to the power mains through a line impedance stabilization network (LISN). All other support equipments powered from additional LISN(s). The LISN provide 50 Ohm/ 50uH of coupling impedance for the measuring instrument.

- b. Interconnecting cables that hang closer than 40 cm to the ground plane shall be folded back and forth in the center forming a bundle 30 to 40 cm long.
- c. I/O cables that are not connected to a peripheral shall be bundled in the center. The end of the cable may be terminated, if required, using the correct terminating impedance. The overall length shall not exceed 1 m.
- d. LISN at least 80 cm from nearest part of EUT chassis.
- e. For the actual test configuration, please refer to the related Item –EUT Test Photos.

## 6.4 Test Result

Temperature :	26 °C	Relative Humidity :	54%
Pressure :	101kPa	Phase :	L
Test Voltage :	AC120V/60Hz	Test Mode :	Mode 3

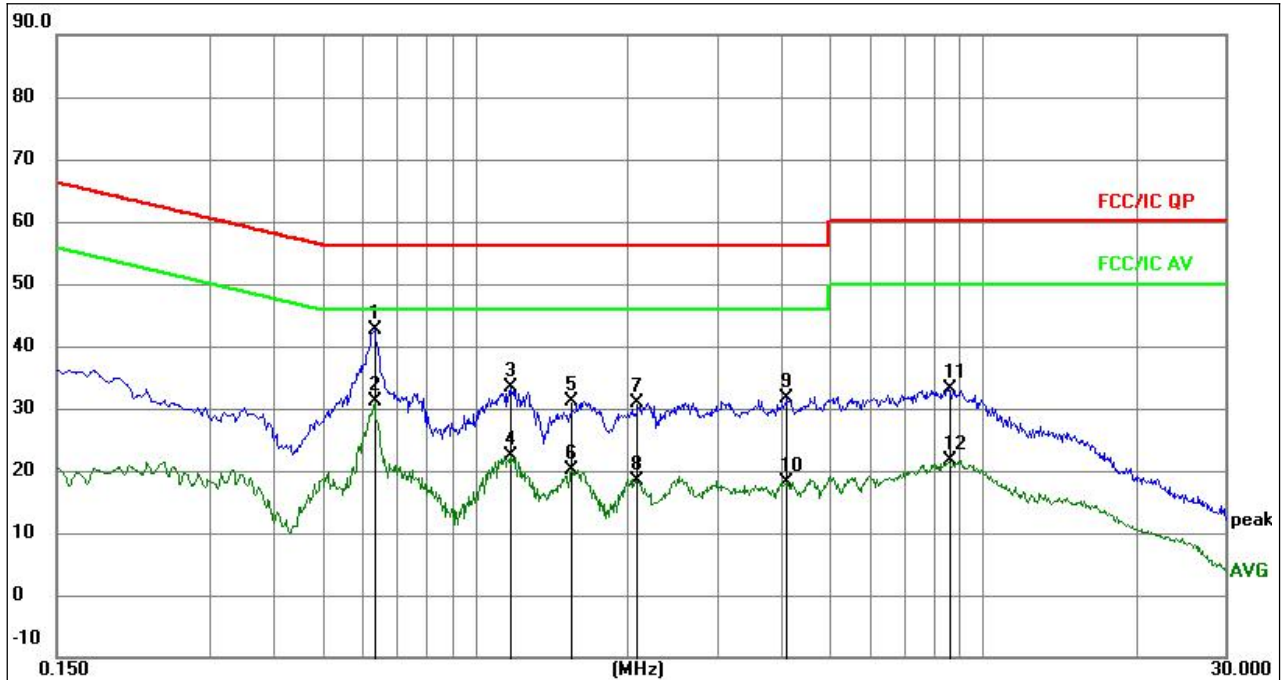

Remark:

1. All readings are Quasi-Peak and Average values.
2. Factor = Insertion Loss + Cable Loss.

No.	Mk.	Freq. MHz	Reading Level	Correct Factor dB	Measure- ment dBuV	Limit dBuV	Over dB	Detector
1	*	0.6359	32.66	9.87	42.53	56.00	-13.47	QP
2		0.6359	21.34	9.87	31.21	46.00	-14.79	AVG
3		1.1759	23.80	9.57	33.37	56.00	-22.63	QP
4		1.1759	12.84	9.57	22.41	46.00	-23.59	AVG
5		1.5494	21.47	9.58	31.05	56.00	-24.95	QP
6		1.5494	10.55	9.58	20.13	46.00	-25.87	AVG
7		2.0803	21.29	9.60	30.89	56.00	-25.11	QP
8		2.0803	8.88	9.60	18.48	46.00	-27.52	AVG
9		4.1055	21.81	9.74	31.55	56.00	-24.45	QP
10		4.1055	8.45	9.74	18.19	46.00	-27.81	AVG
11		8.5875	23.54	9.70	33.24	60.00	-26.76	QP
12		8.5875	11.95	9.70	21.65	50.00	-28.35	AVG



Temperature :	26 °C	Relative Humidity :	54%
Pressure :	101kPa	Phase :	N
Test Voltage :	AC120V/60Hz	Test Mode :	Mode 3

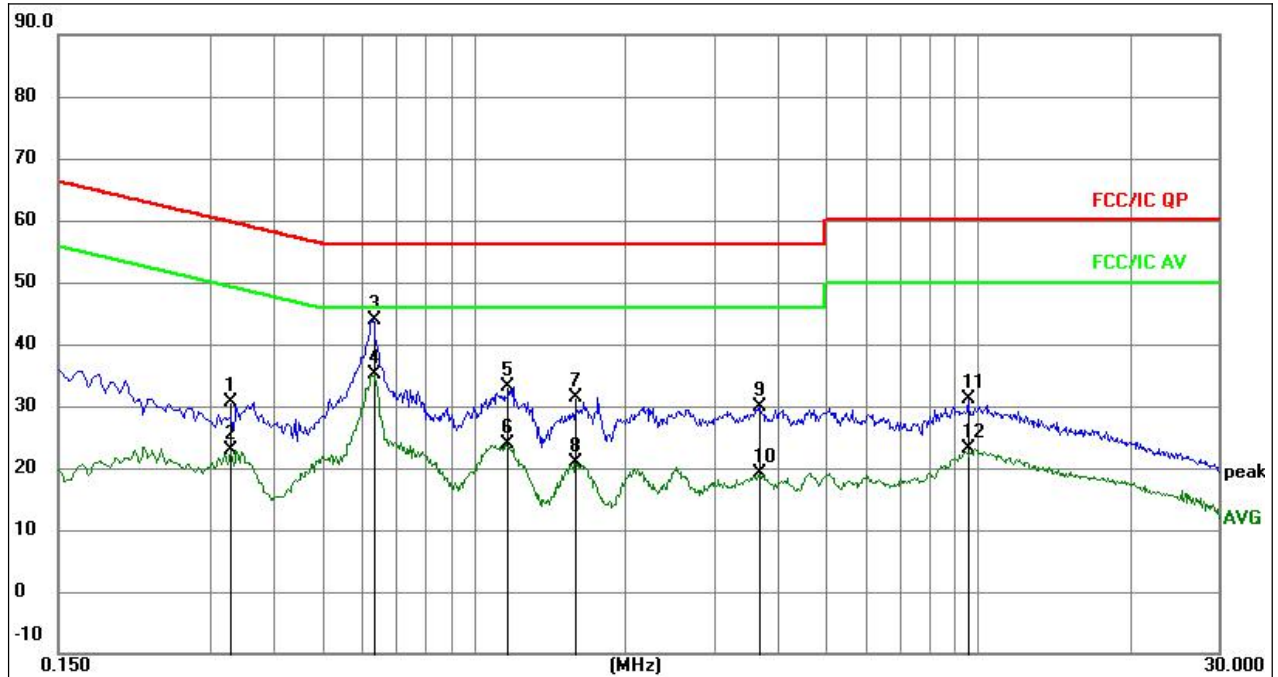

Remark:

1. All readings are Quasi-Peak and Average values.
2. Factor = Insertion Loss + Cable Loss.

No.	Mk.	Freq. MHz	Reading Level	Correct Factor dB	Measure- ment dBuV	Limit dBuV	Over dB	Detector
1		0.3300	20.99	9.56	30.55	59.45	-28.90	QP
2		0.3300	13.35	9.56	22.91	49.45	-26.54	AVG
3		0.6314	33.90	9.89	43.79	56.00	-12.21	QP
4	*	0.6314	25.20	9.89	35.09	46.00	-10.91	AVG
5		1.1624	23.60	9.57	33.17	56.00	-22.83	QP
6		1.1624	14.34	9.57	23.91	46.00	-22.09	AVG
7		1.5900	21.89	9.58	31.47	56.00	-24.53	QP
8		1.5900	11.35	9.58	20.93	46.00	-25.07	AVG
9		3.6960	20.11	9.71	29.82	56.00	-26.18	QP
10		3.6960	9.40	9.71	19.11	46.00	-26.89	AVG
11		9.5550	21.44	9.69	31.13	60.00	-28.87	QP
12		9.5550	13.49	9.69	23.18	50.00	-26.82	AVG



## 7. RADIATED EMISSIONS

### 7.1 Block Diagram Of Test Setup

(A) Radiated Emission Test-Up Frequency Below 30MHz

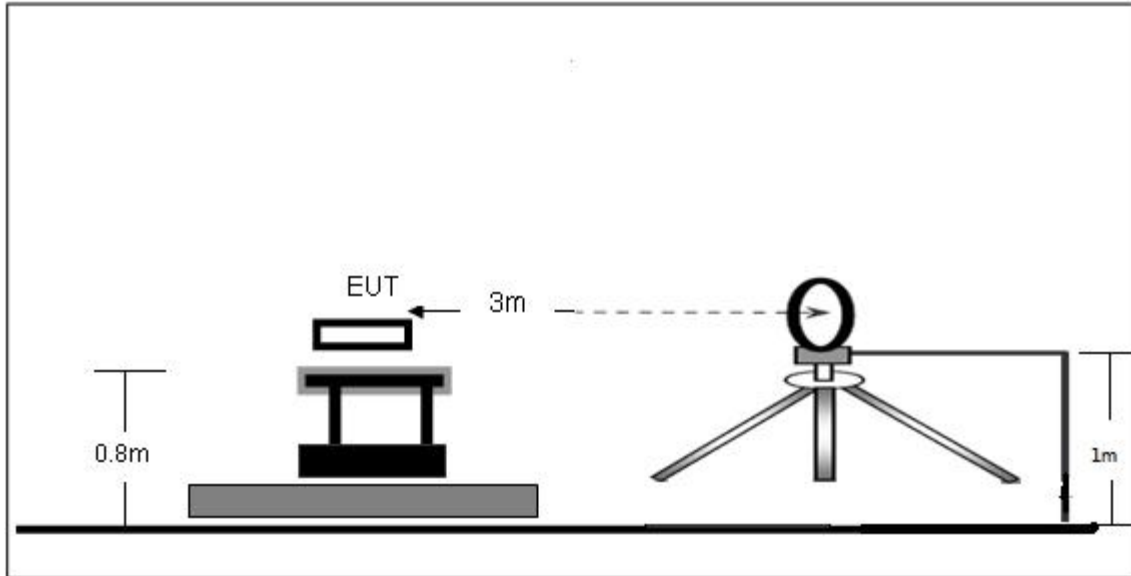

(B) Radiated Emission Test-Up Frequency 30MHz~1GHz

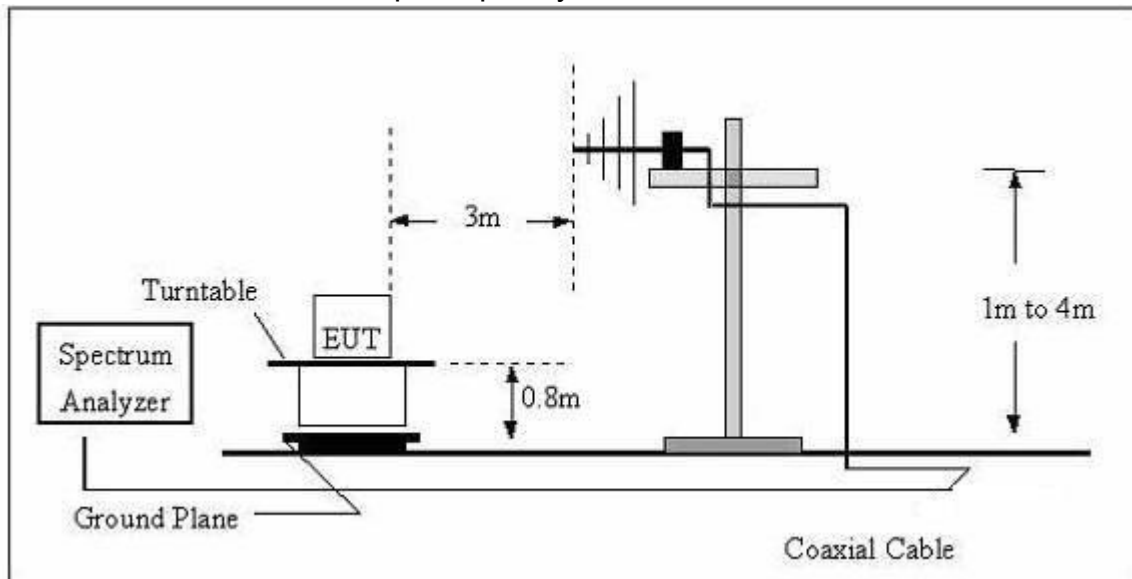

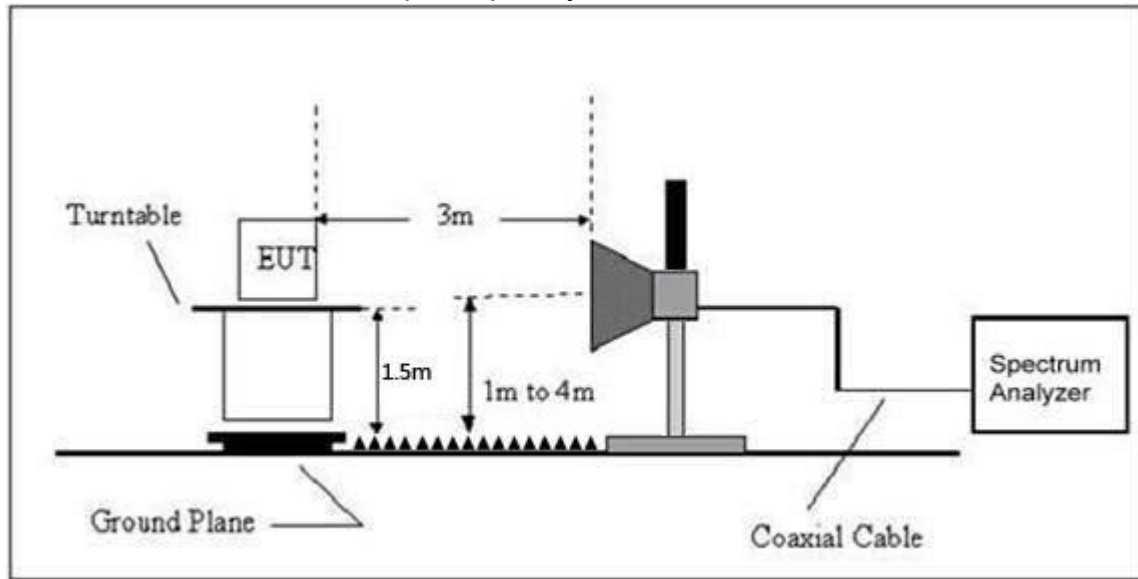
**(C) Radiated Emission Test-Up Frequency Above 1GHz**

**7.2 Limit**

20dBc in any 100 kHz bandwidth outside the operating frequency band. In case the emission fall within the restricted band specified on 15.205(a), then the 15.209(a) limit in the table below has to be followed.

Frequency (MHz)	Field Strength uV/m	Distance (m)	Field Strength Limit at 3m Distance	
			uV/m	dBuV/m
0.009 ~ 0.490	2400/F(kHz)	300	10000 * 2400/F(kHz)	20log <sup>(2400/F(kHz))</sup> + 80
0.490 ~ 1.705	24000/F(kHz)	30	100 * 24000/F(kHz)	20log <sup>(24000/F(kHz))</sup> + 40
1.705 ~ 30	30	30	100 * 30	20log <sup>(30)</sup> + 40
30 ~ 88	100	3	100	20log <sup>(100)</sup>
88 ~ 216	150	3	150	20log <sup>(150)</sup>
216 ~ 960	200	3	200	20log <sup>(200)</sup>
Above 960	500	3	500	20log <sup>(500)</sup>

**7.3 Test procedure**

Receiver Parameter	Setting
Attenuation	Auto
9kHz~150kHz	RBW 200Hz for QP
150kHz~30MHz	RBW 9kHz for QP
30MHz~1000MHz	RBW 120kHz for QP

Spectrum Parameter	Setting
1-25GHz	RBW 1 MHz /VBW 1 MHz for Peak, RBW 1 MHz / VBW 10Hz for Average

Below 1GHz test procedure as below:

- a. The EUT was placed on the top of a rotating table 0.8 meters above the ground at a 3 meter semi-anechoic chamber. The table was rotated 360 degrees to determine the position of the highest radiation.
- b. The EUT was set 3 meters away from the interference-receiving antenna, which was mounted on the top of a variable-height antenna tower.
- c. The antenna height is varied from one meter to four meters above the ground to determine the maximum value of the field strength. Both horizontal and vertical polarizations of the antenna are set to make the measurement.
- d. For each suspected emission, the EUT was arranged to its worst case and then the antenna was tuned to heights from 1 meter to 4 meters (for the test frequency of below 30MHz, the antenna was tuned to heights 1 meter) and the rotatable table was turned from 0 degrees to 360 degrees to find the maximum reading.
- e. The test-receiver system was set to Peak Detect Function and Specified Bandwidth with Maximum Hold Mode.
- f. If the emission level of the EUT in peak mode was 10dB lower than the limit specified, then testing could be stopped and the peak values of the EUT would be reported. Otherwise the emissions that did not have 10dB margin would be re-tested one by one using peak, quasi-peak or average method as specified and then reported in a data sheet.

Above 1GHz test procedure as below:

- g. Different between above is the test site, change from Semi- Anechoic Chamber to fully Anechoic Chamber and change form table 0.8 metre to 1.5 metre( Above 18GHz the distance is 1 meter and table is 1.5 metre).
- h. Test the EUT in the lowest channel ,the middle channel ,the Highest channel.

Note:

Both horizontal and vertical antenna polarities were tested and performed pretest to three orthogonal axis. The worst case emissions were reported.

## 7.4 Test Result

Between 9KHz – 30MHz

Temperature:	26°C	Relative Humidity:	54%
Pressure:	101 kPa	Test Voltage :	DC 3.7V
Test Mode :	Mode 4	Polarization :	--

Freq. (MHz)	Reading (dBuV/m)	Limit (dBuV/m)	Margin (dB)	State P/F
--	--	--	--	PASS
--	--	--	--	PASS

**Note:**

The amplitude of spurious emissions which are attenuated by more than 20dB below the permissible value has no need to be reported.

Distance extrapolation factor =  $40 \log(\text{specific distance}/\text{test distance})$ (dB);

Limit line = specific limits(dBuv) + distance extrapolation factor.

Test all the modes and only worst case was reported.

## Between 30MHz – 1GHz

Temperature:	26°C	Relative Humidity:	54%
Pressure:	101kPa	Test Voltage :	DC 3.7V
Test Mode :	Mode 4	Polarization :	Horizontal

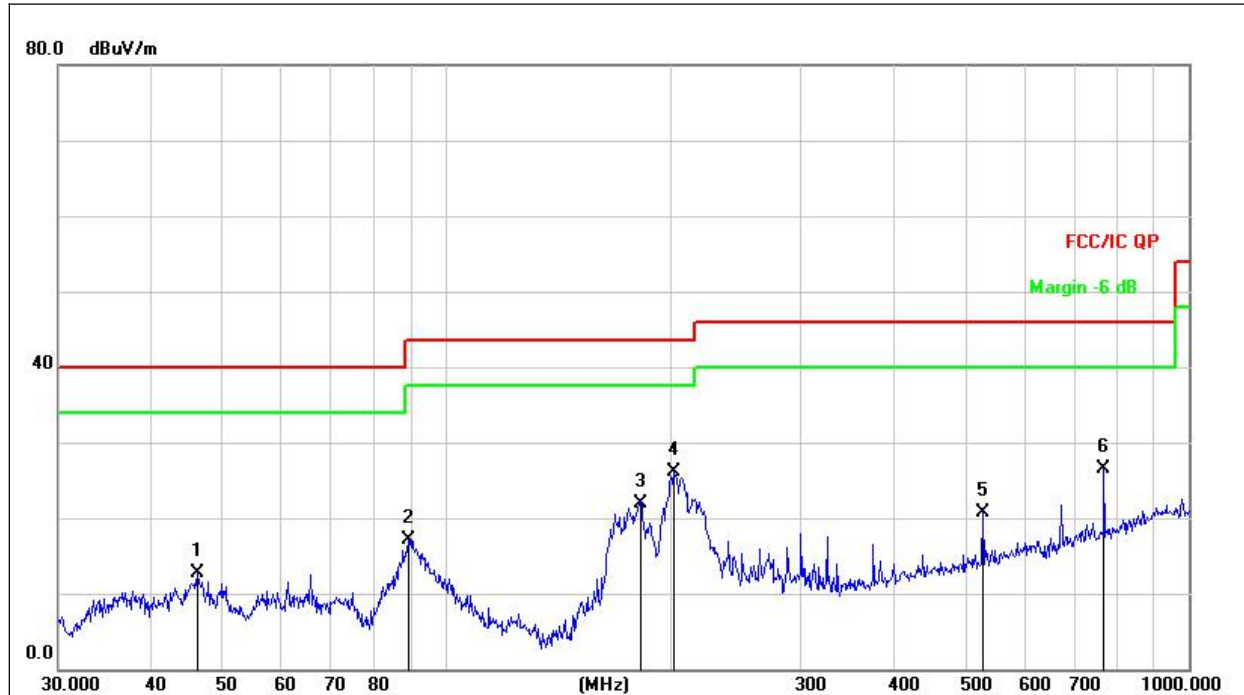

Remark:

Factor = Antenna Factor + Cable Loss – Pre-amplifier.

No.	Mk.	Freq. MHz	Reading Level dBuV	Correct Factor dB	Measure- ment dBuV/m	Limit dB/m	Over dB	Detector
1		46.1779	27.72	-15.06	12.66	40.00	-27.34	QP
2		88.9639	35.54	-18.34	17.20	43.50	-26.30	QP
3		181.9202	39.34	-17.46	21.88	43.50	-21.62	QP
4	*	202.1005	42.45	-16.25	26.20	43.50	-17.30	QP
5		528.2458	28.84	-8.23	20.61	46.00	-25.39	QP
6		768.7481	30.62	-4.08	26.54	46.00	-19.46	QP

Temperature:	26°C	Relative Humidity:	54%
Pressure:	101kPa	Test Voltage :	DC 3.7V
Test Mode :	Mode 4	Polarization :	Vertical

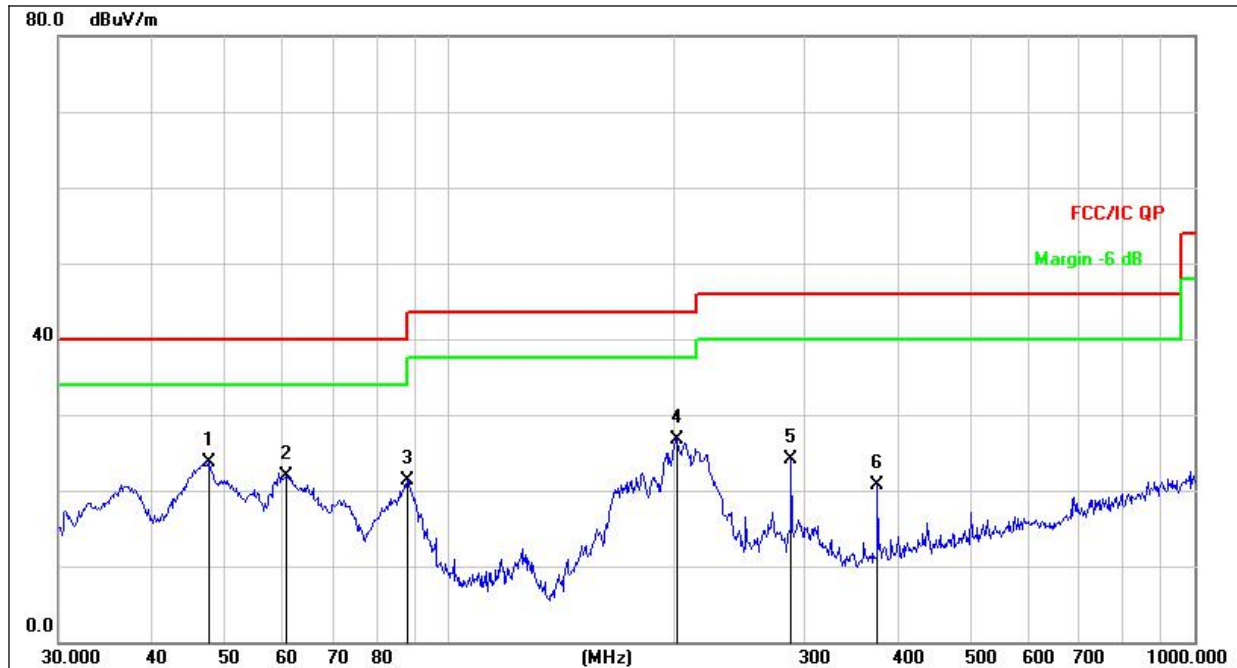

Remark:

Factor = Antenna Factor + Cable Loss – Pre-amplifier.

No.	Mk.	Freq. MHz	Reading Level dBuV	Correct Factor dB	Measure- ment dBuV/m	Limit dB/m	Over dB	Detector
1	*	47.6586	38.68	-14.98	23.70	40.00	-16.30	QP
2		60.7044	38.06	-16.07	21.99	40.00	-18.01	QP
3		88.0329	39.89	-18.55	21.34	43.50	-22.16	QP
4		202.8104	42.97	-16.24	26.73	43.50	-16.77	QP
5		287.9904	38.13	-13.97	24.16	46.00	-21.84	QP
6		375.9385	32.27	-11.64	20.63	46.00	-25.37	QP

Remark:

Test all the modes and only worst case was reported. The worst mode is GFSK, Low Channel.

**Between 1-25GHz**

Polar (H/V)	Frequency	Meter Reading	Pre-amplifier	Cable Loss	Antenna Factor	Emission Level	Limits	Margin	Detector Type
	(MHz)	(dBuV)	(dB)	(dB)	(dB)	(dBuV/m)	(dBuV/m)	(dB)	
GFSK Low Channel:2402MHz									
V	4804.00	53.12	35.91	8.11	29.36	54.68	74.00	-19.32	Pk
V	4804.00	43.45	35.91	8.11	29.36	45.01	54.00	-8.99	AV
V	7206.00	52.41	35.66	9.63	34.21	60.59	74.00	-13.41	Pk
V	7206.00	40.50	35.66	9.63	34.21	48.68	54.00	-5.32	AV
H	4804.00	50.39	35.91	8.11	29.36	51.95	74.00	-22.05	Pk
H	4804.00	43.81	35.91	8.11	29.36	45.37	54.00	-8.63	AV
H	7206.00	50.02	35.66	9.63	34.21	58.20	74.00	-15.80	Pk
H	7206.00	40.71	35.66	9.63	34.21	48.89	54.00	-5.11	AV

Polar (H/V)	Frequency	Meter Reading	Pre-amplifier	Cable Loss	Antenna Factor	Emission Level	Limits	Margin	Detector Type
	(MHz)	(dBuV)	(dB)	(dB)	(dB)	(dBuV/m)	(dBuV/m)	(dB)	
GFSK Middle Channel:2441MHz									
V	4882.00	51.05	35.89	8.23	29.47	52.86	74.00	-21.14	Pk
V	4882.00	43.77	35.89	8.23	29.47	45.58	54.00	-8.42	AV
V	7323.00	52.74	35.65	9.66	34.33	61.08	74.00	-12.92	Pk
V	7323.00	40.30	35.65	9.66	34.33	48.64	54.00	-5.36	AV
H	4882.00	53.73	35.89	8.23	29.47	55.54	74.00	-18.46	Pk
H	4882.00	43.41	35.89	8.23	29.47	45.22	54.00	-8.78	AV
H	7323.00	48.97	35.65	9.66	34.33	57.31	74.00	-16.69	Pk
H	7323.00	40.14	35.65	9.66	34.33	48.48	54.00	-5.52	AV

Polar (H/V)	Frequency	Meter Reading	Pre-amplifier	Cable Loss	Antenna Factor	Emission Level	Limits	Margin	Detector Type
	(MHz)	(dBuV)	(dB)	(dB)	(dB)	(dBuV/m)	(dBuV/m)	(dB)	
GFSK High Channel:2480MHz									
V	4960.00	54.96	35.83	8.32	29.51	56.96	74.00	-17.04	Pk
V	4960.00	43.60	35.83	8.32	29.51	45.60	54.00	-8.40	AV
V	7440.00	50.49	35.72	9.71	34.62	59.10	74.00	-14.90	Pk
V	7440.00	40.93	35.72	9.71	34.62	49.54	54.00	-4.46	AV
H	4960.00	53.78	35.83	8.32	29.51	55.78	74.00	-18.22	Pk
H	4960.00	43.61	35.83	8.32	29.51	45.61	54.00	-8.39	AV
H	7440.00	50.47	35.72	9.71	34.62	59.08	74.00	-14.92	Pk
H	7440.00	40.87	35.72	9.71	34.62	49.48	54.00	-4.52	AV

**Remark:**

- Emission Level = Meter Reading + Antenna Factor + Cable Loss – Pre-amplifier, Margin= Emission Level - Limit
- If peak below the average limit, the average emission was no test.
- The amplitude of spurious emissions which are attenuated by more than 20dB below the permissible value has no need to be reported.
- All the Modulation are test, the worst mode is GFSK, the data recording in the report.



## 7.5 RADIATED BAND EMISSION MEASUREMENT AND RESTRICTED BANDS OF OPERATION

Test Requirement:

FCC Part15 C Section 15.209 and 15.205

(a) Except as shown in paragraph (d) of this section, only spurious emissions are permitted in any of the frequency bands listed below:

MHz	MHz	MHz	GHz
0.090-0.110	16.42-16.423	399.9-410	4.5-5.15
0.495-0.505	16.69475-16.69525	608-614	5.35-5.46
2.1735-2.1905	16.80425-16.80475	960-1240	7.25-7.75
4.125-4.128	25.5-25.67	1300-1427	8.025-8.5
4.17725-4.17775	37.5-38.25	1435-1626.5	9.0-9.2
4.20725-4.20775	73-74.6	1645.5-1646.5	9.3-9.5
6.215-6.218	74.8-75.2	1660-1710	10.6-12.7
6.26775-6.26825	108-121.94	1718.8-1722.2	13.25-13.4
6.31175-6.31225	123-138	2200-2300	14.47-14.5
8.291-8.294	149.9-150.05	2310-2390	15.35-16.2
8.362-8.366	156.52475-156.52525	2483.5-2500	17.7-21.4
8.37625-8.38675	156.7-156.9	2690-2900	22.01-23.12
8.41425-8.41475	162.0125-167.17	3260-3267	23.6-24.0
12.29-12.293	167.72-173.2	3332-3339	31.2-31.8
12.51975-12.52025	240-285	3345.8-3358	36.43-36.5
12.57675-12.57725	322-335.4	3600-4400	(2)
13.36-13.41			

### LIMITS OF RADIATED EMISSION MEASUREMENT (Above 1000MHz)

FREQUENCY (MHz)	Limit (dBuV/m) (at 3M)	
	PEAK	AVERAGE
Above 1000	74	54

Notes:

- (1) The limit for radiated test was performed according to FCC PART 15C.
- (2) The tighter limit applies at the band edges.
- (3) Emission level (dBuV/m)=20log Emission level (uV/m).

Spectrum Parameter	Setting
Attenuation	Auto
Start Frequency	2300MHz
Stop Frequency	2520
RB / VB (emission in restricted band)	1 MHz / 1 MHz for Peak, 1 MHz / 10Hz for Average

### TEST PROCEDURE

Above 1GHz test procedure as below:

- a. 1. The EUT was placed on the top of a rotating table 1.5 meters above the ground at a 3 meter camber. The table was rotated 360 degrees to determine the position of the highest radiation.
- b. The EUT was set 3 meters away from the interference-receiving antenna, which was mounted on the top of a variable-height antenna tower.
- c. The antenna height is varied from one meter to four meters above the ground to determine the maximum value of the field strength. Both horizontal and vertical polarizations of the antenna are set to make the measurement.



- d. For each suspected emission, the EUT was arranged to its worst case and then the antenna was tuned to heights from 1 meter to 4 meters and the rota table was turned from 0 degrees to 360 degrees to find the maximum reading.
- e. The test-receiver system was set to Peak Detect Function and Specified Bandwidth with Maximum Hold Mode.
- f. If the emission level of the EUT in peak mode was 10dB lower than the limit specified, then testing could be stopped and the peak values of the EUT would be reported. Otherwise the emissions that did not have 10dB margin would be re-tested one by one using peak, quasi-peak or average method as specified and then reported in a data sheet.
- g. Test the EUT in the lowest channel,the Highest channel

Note:

Both horizontal and vertical antenna polarities were tested and performed pretest to three orthogonal axis. The worst case emissions were reported

**TEST RESULT**

	Polar (H/V)	Frequency (MHz)	Meter Reading (dBuV)	Pre-amplifier (dB)	Cable Loss (dB)	Antenna Factor (dB/m)	Emission level (dBuV/m)	Limits (dBuV/m)		Result	
							PK	PK	AV		
GFSK	<b>Low Channel 2402MHz</b>										
	H	2390.00	61.56	38.06	7.42	20.15	51.07	74.00	54.00	PASS	
	H	2400.00	57.31	38.06	7.42	20.15	46.82	74.00	54.00	PASS	
	V	2390.00	60.55	38.06	7.42	20.15	50.06	74.00	54.00	PASS	
	V	2400.00	59.43	38.06	7.42	20.15	48.94	74.00	54.00	PASS	
	<b>High Channel 2480MHz</b>										
	H	2483.50	61.83	38.17	7.45	20.54	51.65	74.00	54.00	PASS	
	H	2485.50	58.60	38.17	7.45	20.54	48.42	74.00	54.00	PASS	
	V	2483.50	59.04	38.20	7.45	20.54	48.83	74.00	54.00	PASS	
	V	2485.50	60.50	38.20	7.45	20.54	50.29	74.00	54.00	PASS	
	Pi/4DQPSK	<b>Low Channel 2402MHz</b>									
		H	2390.00	61.27	38.06	7.42	20.15	50.78	74.00	54.00	PASS
H		2400.00	56.93	38.06	7.42	20.15	46.44	74.00	54.00	PASS	
V		2390.00	60.71	38.06	7.42	20.15	50.22	74.00	54.00	PASS	
V		2400.00	59.79	38.06	7.42	20.15	49.30	74.00	54.00	PASS	
<b>High Channel 2480MHz</b>											
H		2483.50	61.66	38.06	7.42	20.15	51.17	74.00	54.00	PASS	
H		2485.50	58.71	38.06	7.42	20.15	48.22	74.00	54.00	PASS	
V		2483.50	60.18	38.06	7.42	20.15	49.69	74.00	54.00	PASS	
V		2485.50	60.73	38.06	7.42	20.15	50.24	74.00	54.00	PASS	
<b>Remark:</b>											
1. Emission Level = Meter Reading + Antenna Factor + Cable Loss – Pre-amplifier, Margin= Emission Level - Limit											
2. If the PK measured levels comply with average limit, then the average level were deemed to comply with average limit.											
3 In restricted bands of operation, The spurious emissions below the permissible value more than 20dB											
4. The amplitude of spurious emissions which are attenuated by more than 20dB below the permissible value has no need to be reported.											

## 8. CONDUCTED EMISSION

### 8.1 Block Diagram Of Test Setup

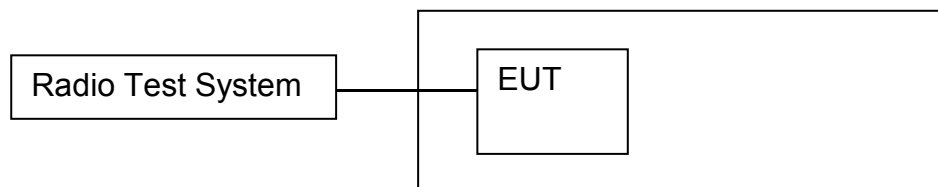

### 8.2 Limit

Regulation 15.247 (d), In any 100 kHz bandwidth outside the frequency band in which the spread spectrum or digitally modulated intentional radiator is operating, the radio frequency power that is produced by the intentional radiator shall be at least 20 dB below that in the 100 kHz bandwidth within the band that contains the highest level of the desired power, based on either an RF conducted or a radiated measurement, provided the transmitter demonstrates compliance with the peak conducted power limits. If the transmitter complies with the conducted power limits based on the use of RMS averaging over a time interval, as permitted under paragraph (b)(3) of this section, the attenuation required under this paragraph shall be 30 dB instead of 20 dB. Attenuation below the general limits specified in §15.209(a) is not required. In addition, radiated emissions which fall in the restricted bands, as defined in §15.205(a), must also comply with the radiated emission limits specified in §15.209(a) (see §15.205(c)).

### 8.3 Test procedure

1. Remove the antenna from the EUT and then connect a low RF cable from the antenna port to the spectrum;

2. Set the spectrum analyzer:

Below 30MHz:

RBW = 100kHz, VBW = 300kHz, Sweep = auto

Detector function = peak, Trace = max hold

Above 30MHz:

RBW = 100KHz, VBW = 300KHz, Sweep = auto

Detector function = peak, Trace = max hold

## 8.4 Test Result

### 30MHz – 25GHz

#### GFSK Low Channel

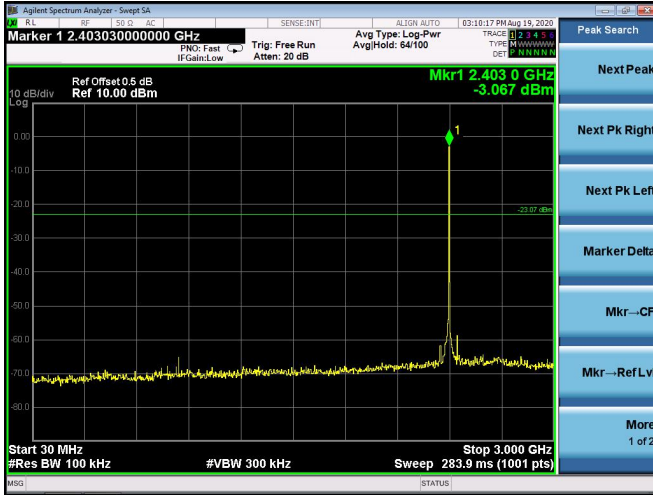

#### GFSK Middle Channel

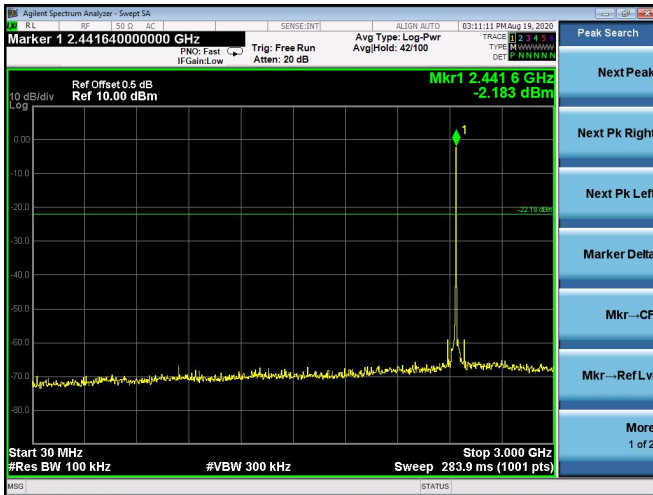

#### GFSK High Channel

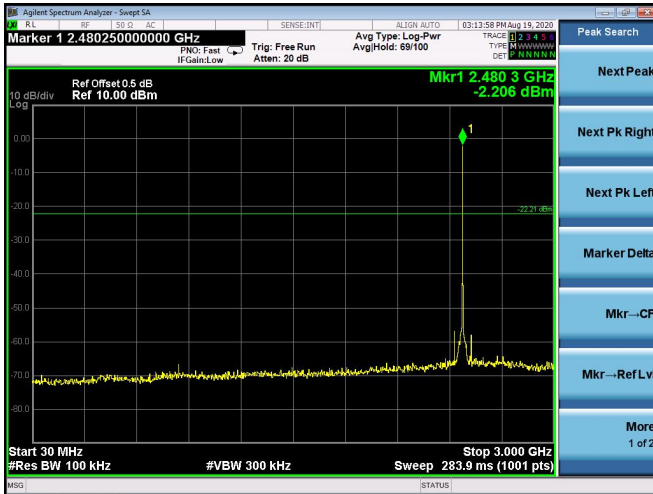

Pi/4 DQPSK Low Channel

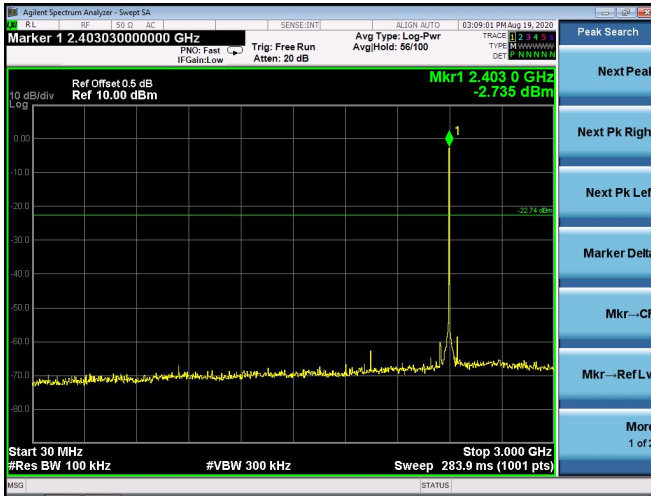

Pi/4 DQPSK Middle Channel

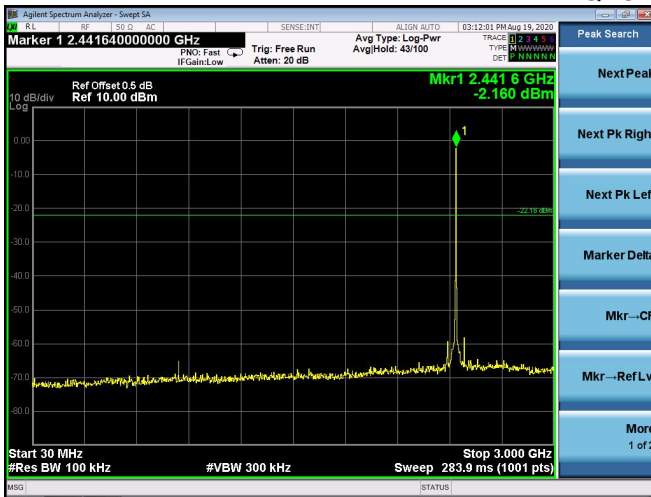

Pi/4 DQPSK High Channel

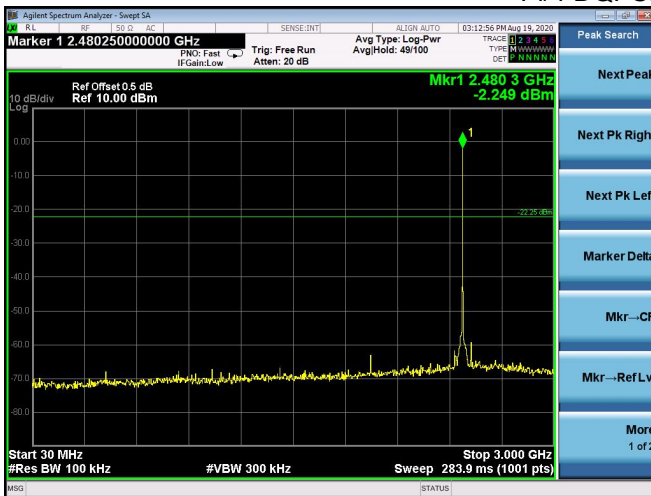

### GFSK Transmitting Band edge-left side

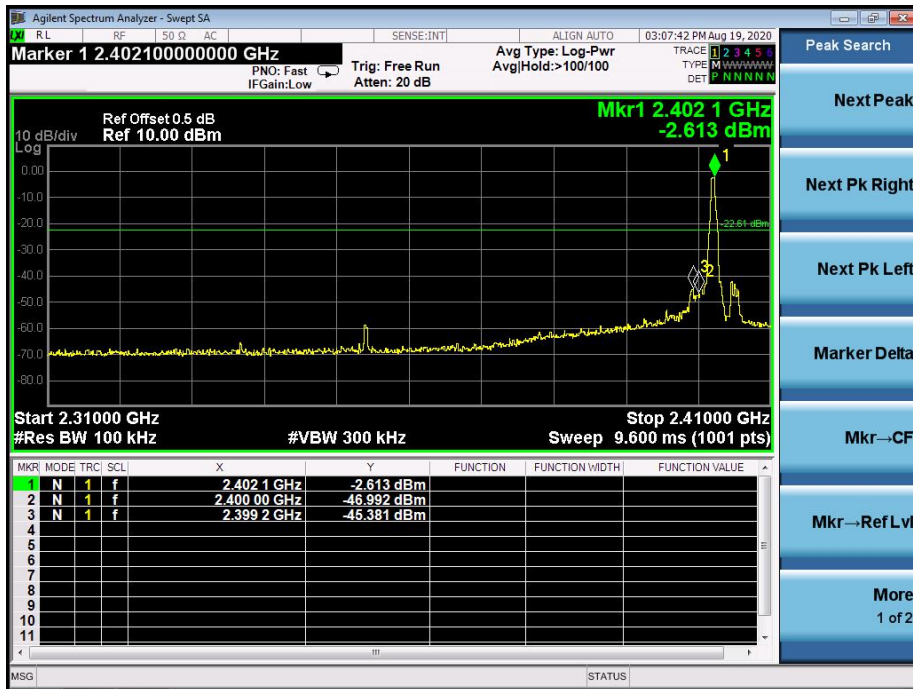

### GFSK Hopping Band edge-left side

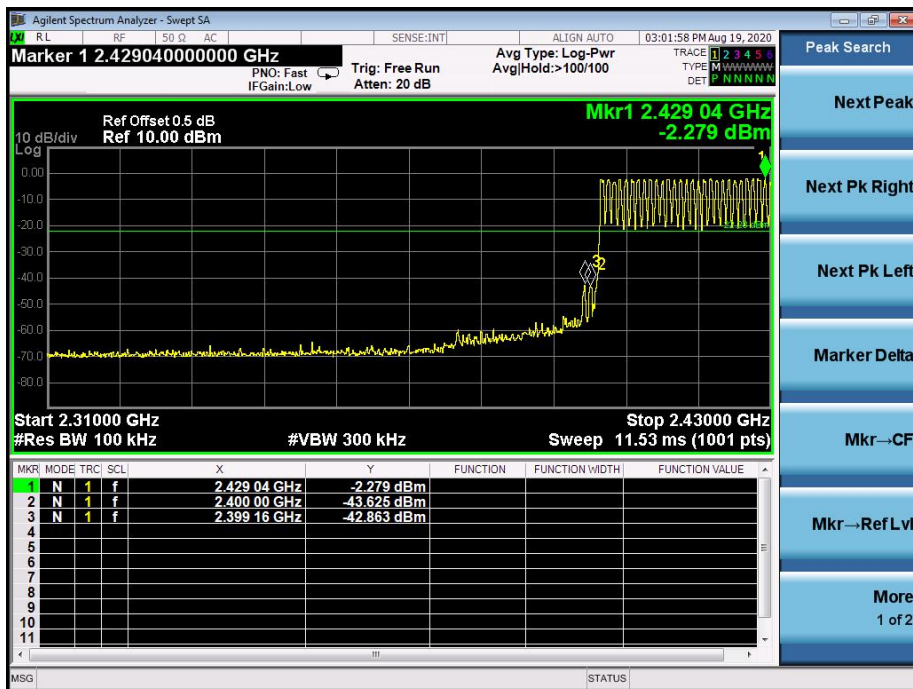



GFSK Transmitting Band edge-right side

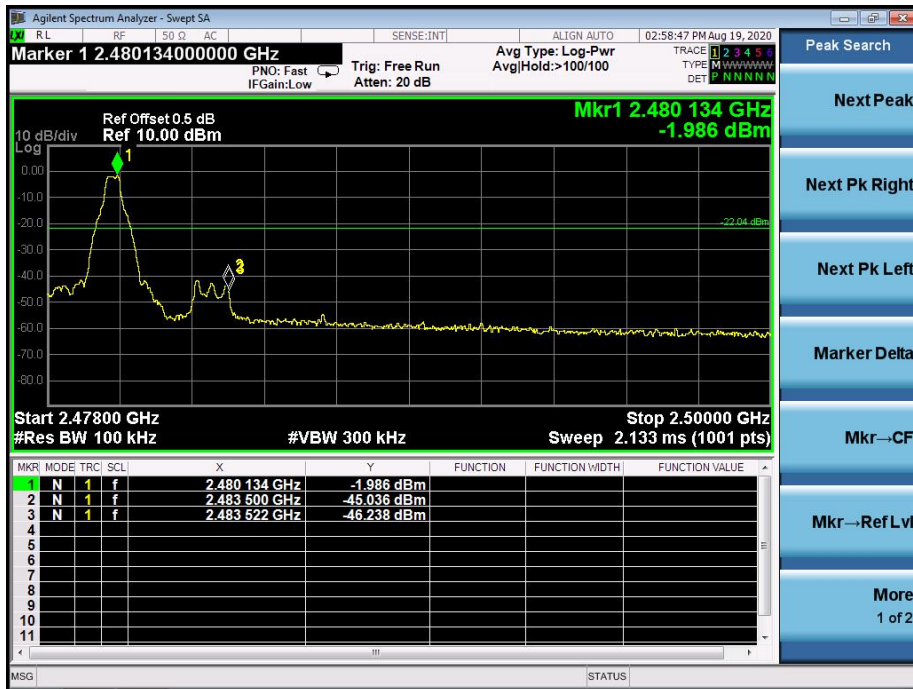

GFSK Hopping Band edge-right side

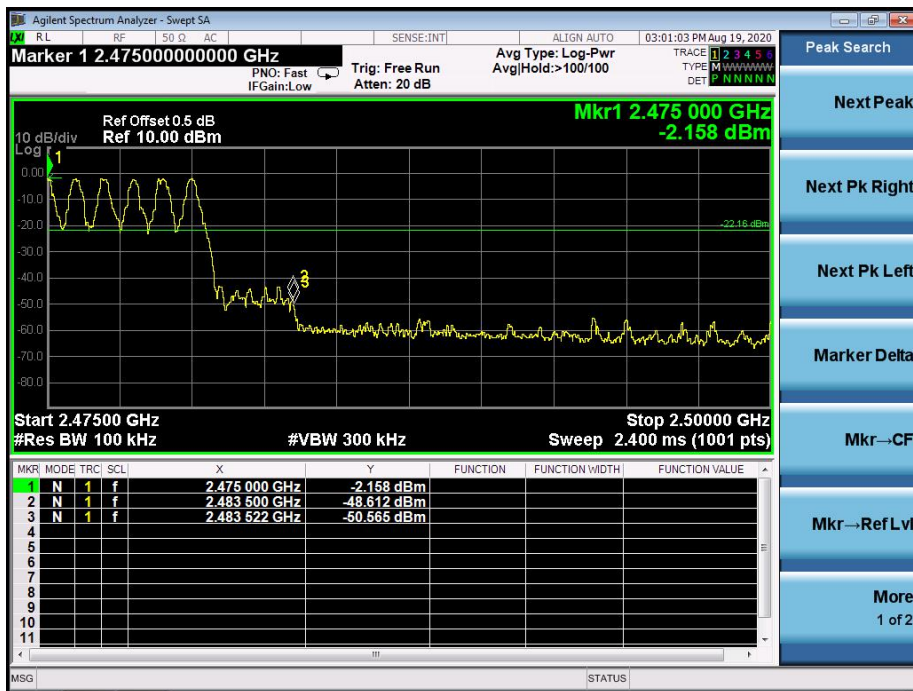

Pi/4 DQPSK Transmitting Band edge-left side

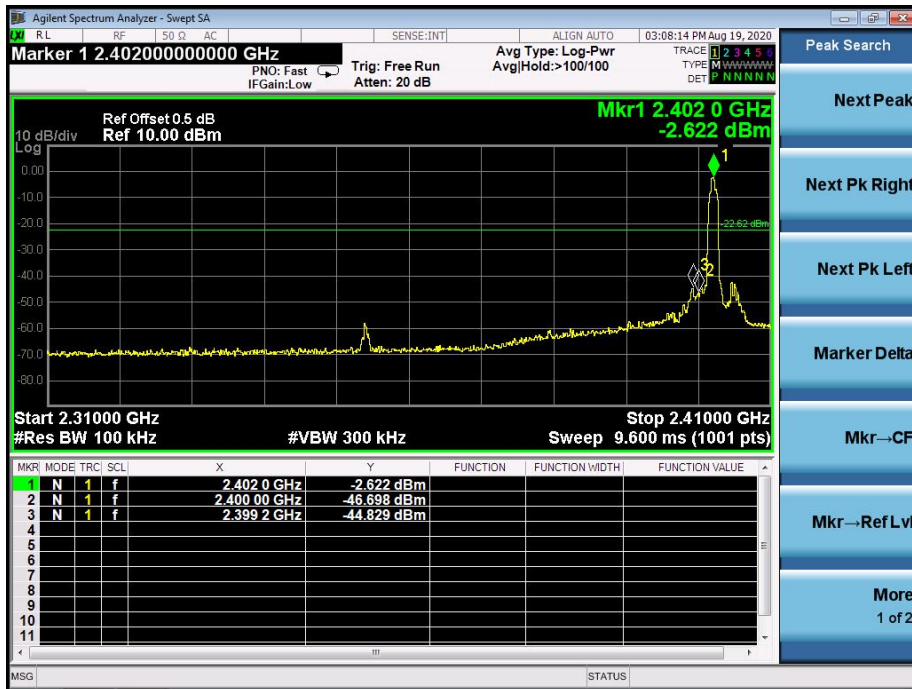

Pi/4 DQPSK Hopping Band edge-left side





Pi/4 DQPSK Transmitting Band edge-right side

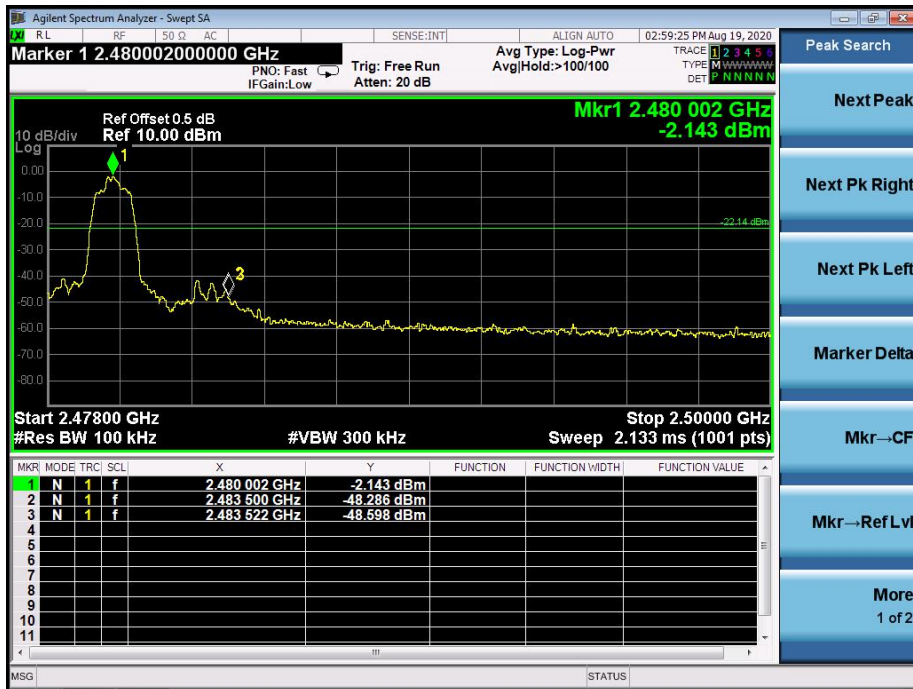

Pi/4 DQPSK Hopping Band edge-right side

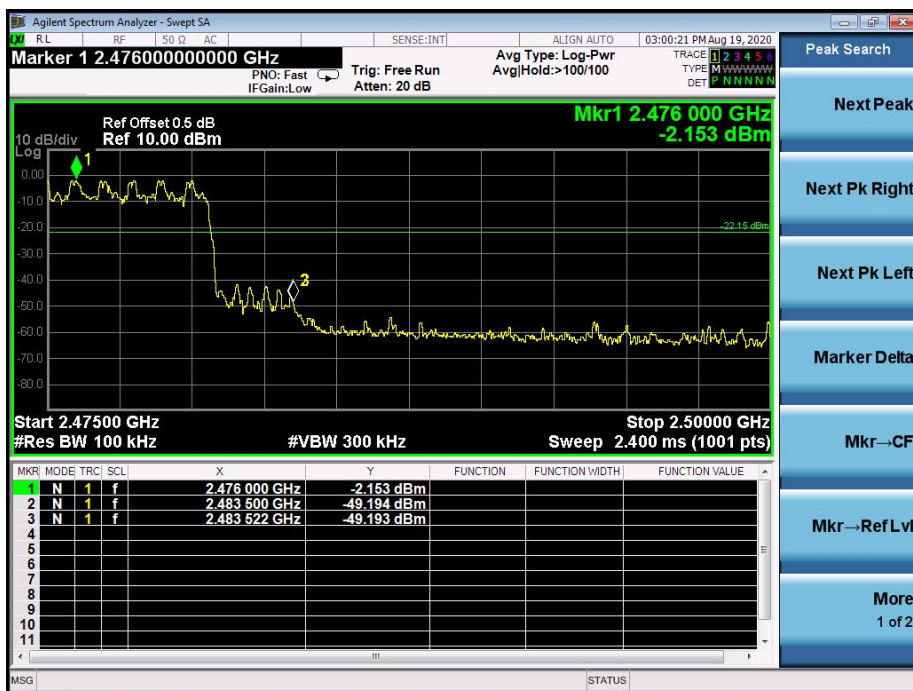

## 9. 20 DB BANDWIDTH

### 9.1 Block Diagram Of Test Setup

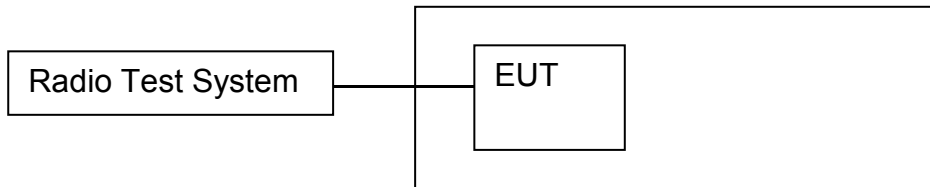

### 9.2 Limit

N/A

### 9.3 Test procedure

1. Set RBW = 30 kHz.
2. Set the video bandwidth (VBW)  $\geq 3 \times$  RBW.
3. Detector = Peak.
4. Trace mode = max hold.
5. Sweep = auto couple.
6. Allow the trace to stabilize.
7. Measure the maximum width of the emission that is constrained by the frequencies associated with the two outermost amplitude points (upper and lower frequencies) that are attenuated by 20 dB relative to the maximum level measured in the fundamental emission.

## 9.4 Test Result

Modulation	Test Channel	Bandwidth(MHz)
GFSK	Low	0.781
GFSK	Middle	0.782
GFSK	High	0.797
Pi/4 DQPSK	Low	1.231
Pi/4 DQPSK	Middle	1.211
Pi/4 DQPSK	High	1.230

**Test plots**  
GFSK Low Channel

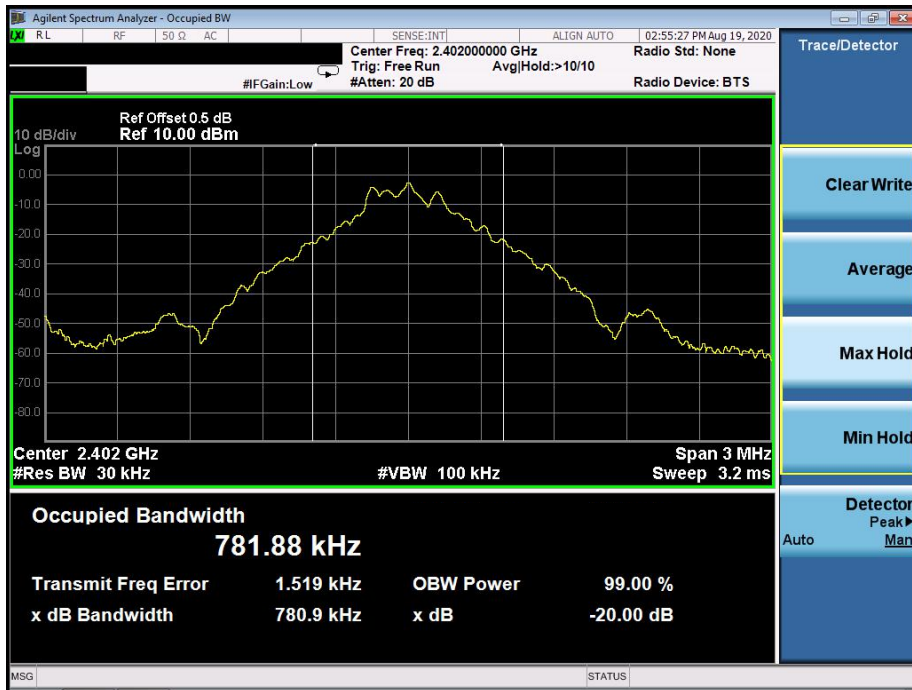

GFSK Middle Channel

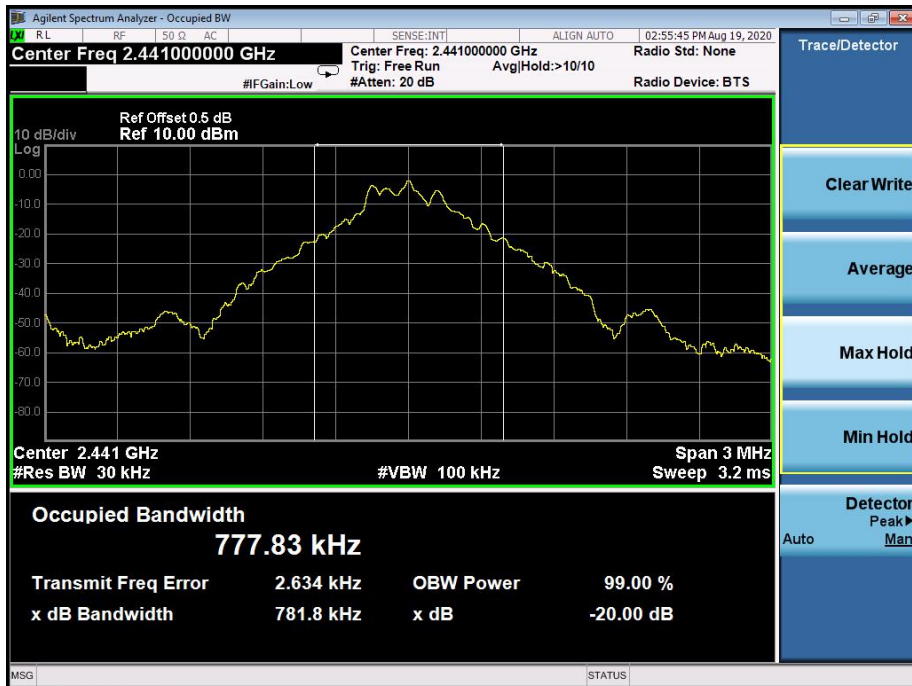

GFSK High Channel

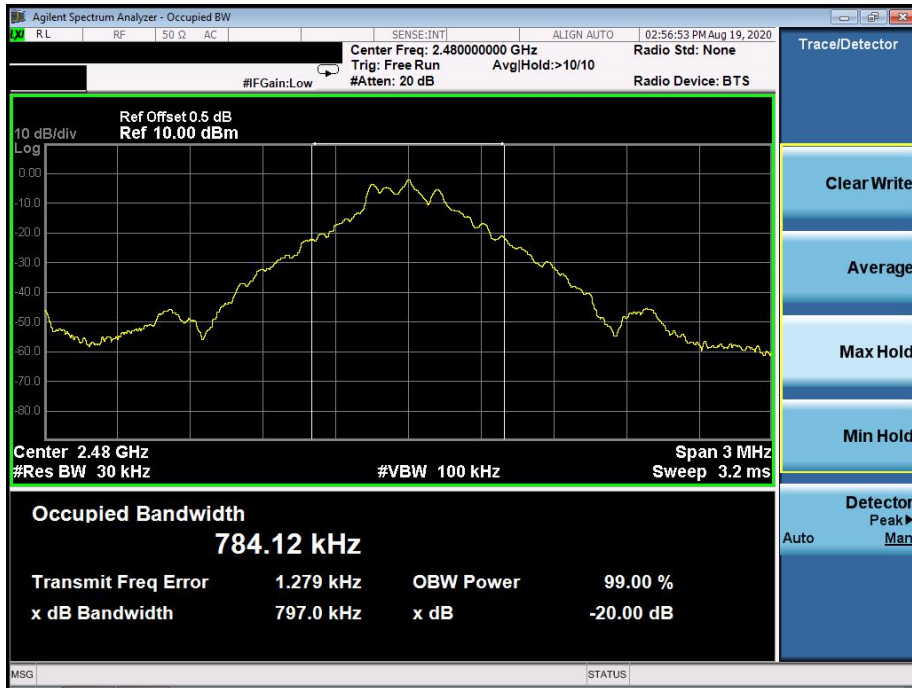

Pi/4 DQPSK Low Channel

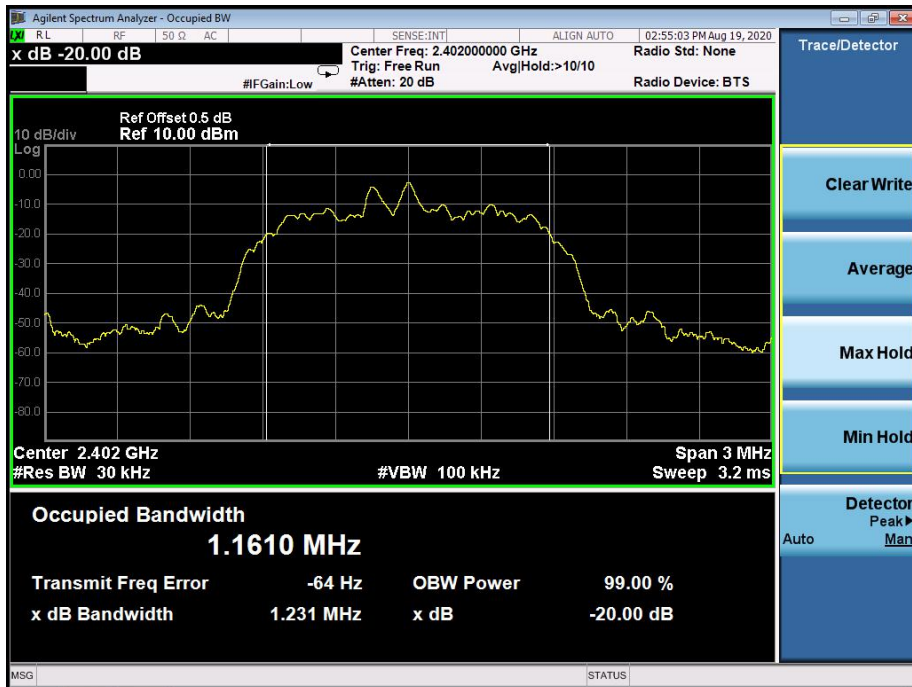

Pi/4 DQPSK Middle Channel

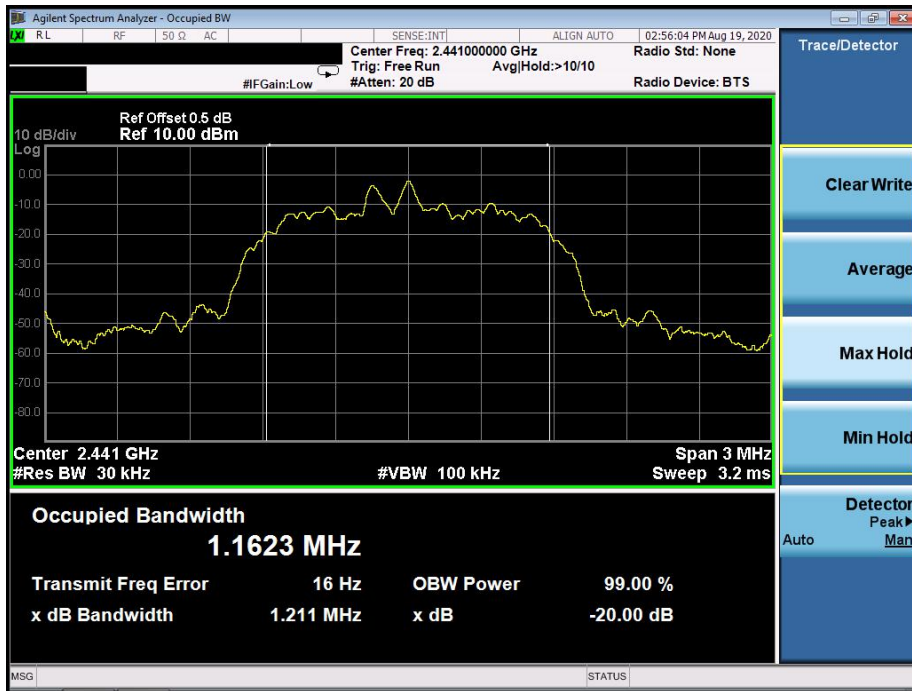

Pi/4 DQPSK High Channel

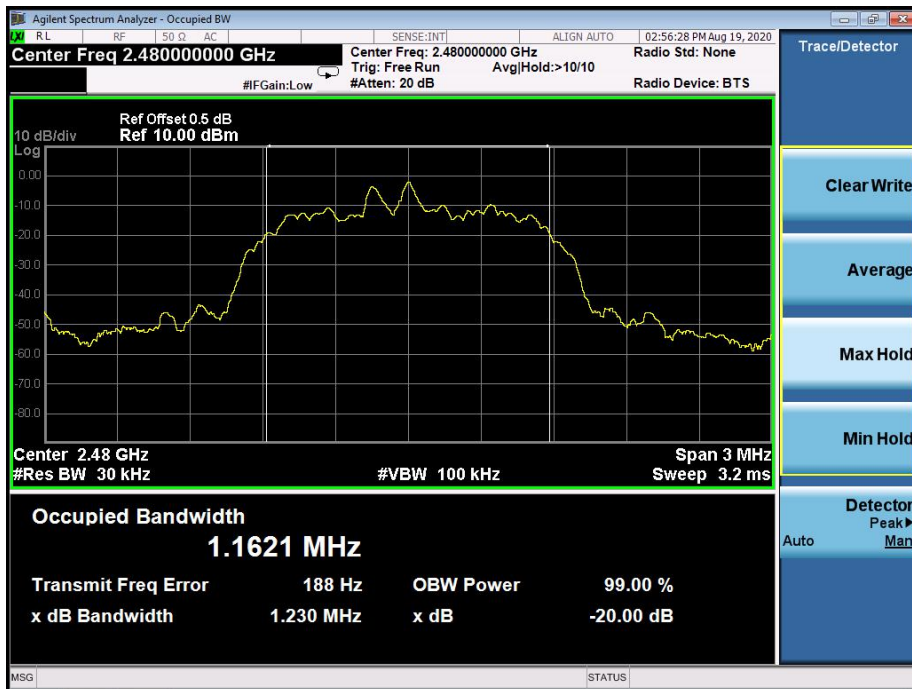

## 10. MAXIMUM PEAK OUTPUT POWER

### 10.1 Block Diagram Of Test Setup

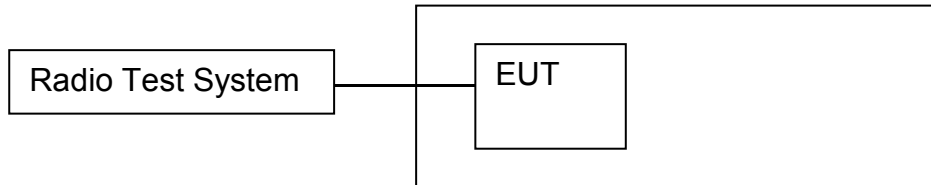

### 10.2 Limit

For frequency hopping systems operating in the 2400-2483.5 MHz band employing at least 75 non-overlapping hopping channels, and all frequency hopping systems in the 5725-5850 MHz band: 1 watt. For all other frequency hopping systems in the 2400-2483.5 MHz band: 0.125 watts.

### 10.3 Test procedure

1. Remove the antenna from the EUT and then connect a low RF cable from the antenna port to the spectrum.
2. Set the spectrum analyzer: RBW = 3MHz. VBW = 3MHz. Sweep = auto; Detector Function = Peak.
3. Keep the EUT in transmitting at lowest, medium and highest channel individually. Record the max value.

## 10.4 Test Result

Modulation	Test Channel	Output Power (dBm)	Limit (dBm)
GFSK	Low	-2.49	21
GFSK	Middle	-1.97	21
GFSK	High	-2.05	21
Pi/4 DQPSK	Low	-1.58	21
Pi/4 DQPSK	Middle	-1.09	21
Pi/4 DQPSK	High	-1.12	21



**Test plots**  
GFSK Low Channel

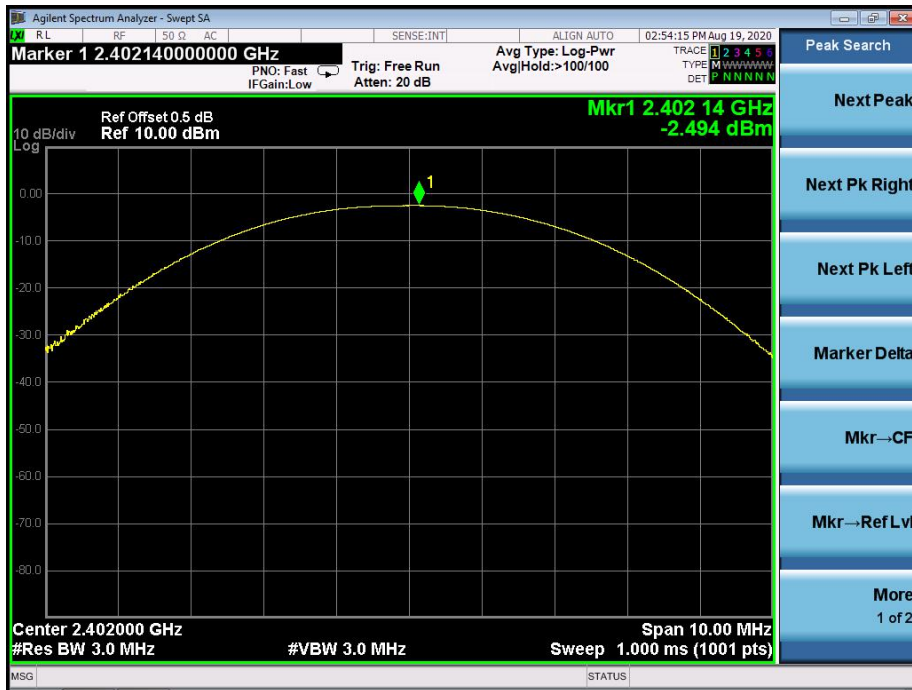

GFSK Middle Channel

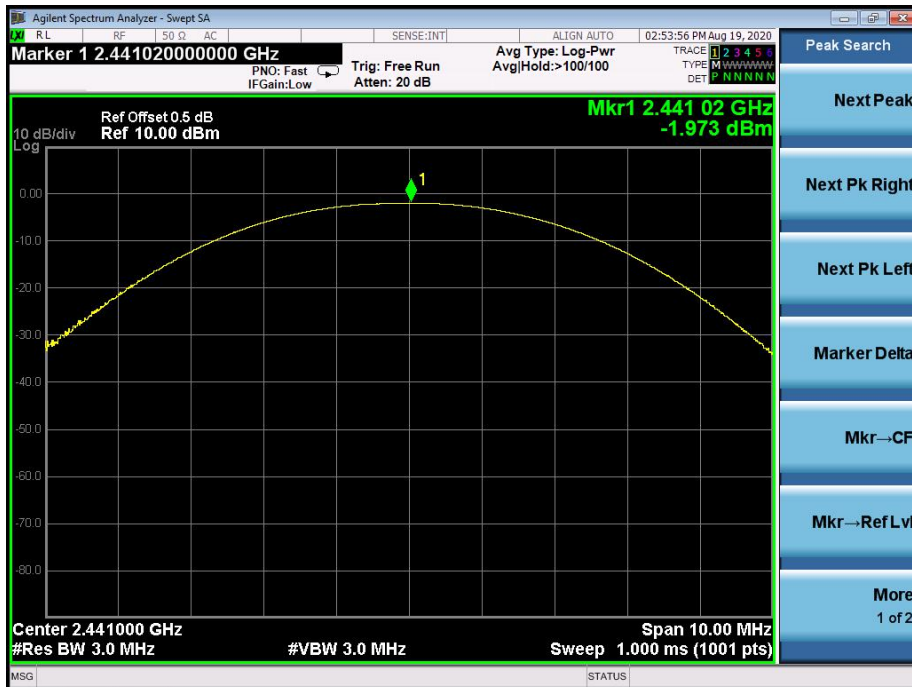

GFSK High Channel



Pi/4 DQPSK Low Channel



Pi/4 DQPSK Middle Channel

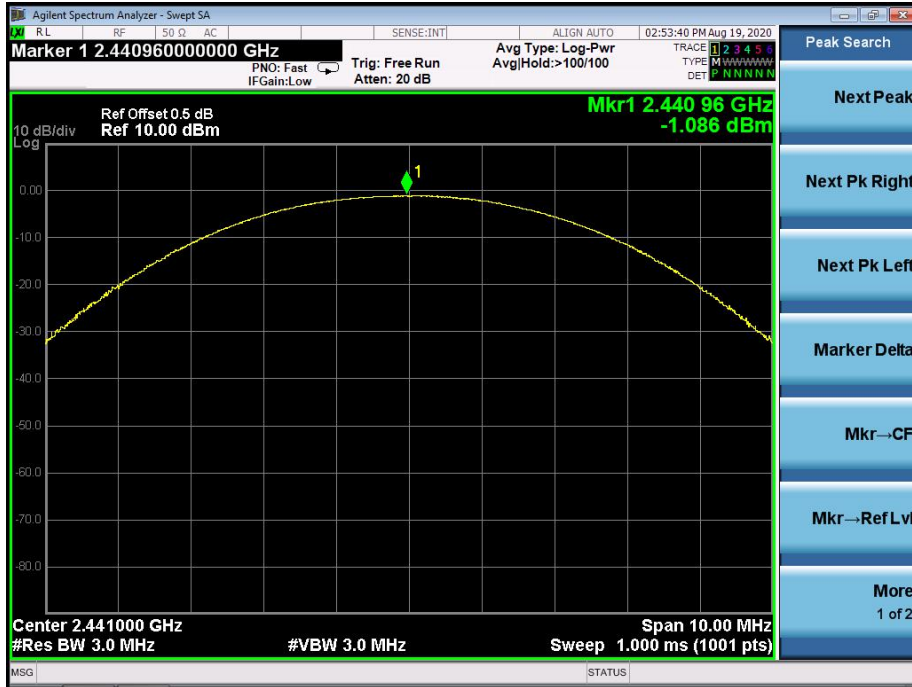

Pi/4 DQPSK High Channel



## 11. HOPPING CHANNEL SEPARATION

### 11.1 Block Diagram Of Test Setup

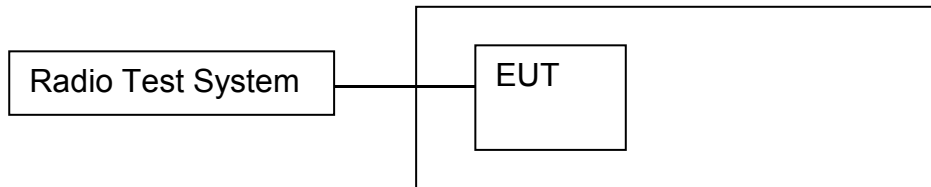

### 11.2 Limit

Frequency hopping systems shall have hopping channel carrier frequencies separated by a minimum of 25 kHz or the 20 dB bandwidth of the hopping channel, whichever is greater. Alternatively, frequency hopping systems operating in the 2400-2483.5 MHz band may have hopping channel carrier frequencies that are separated by 25 kHz or two-thirds of the 20 dB bandwidth of the hopping channel, whichever is greater, provided the systems operate with an output power no greater than 0.125W.

### 11.3 Test procedure

1. Remove the antenna from the EUT and then connect a low RF cable from the antenna port to the spectrum.
2. Set the spectrum analyzer: RBW = 30kHz. VBW = 100kHz , Span = 2.0MHz. Sweep = auto; Detector Function = Peak. Trace = Max hold.
3. Allow the trace to stabilize. Use the marker-delta function to determine the separation between the peaks of the adjacent channels. The limit is specified in one of the subparagraphs of this Section Submit this plot.

## 11.4 Test Result

Modulation	Test Channel	Separation (MHz)	Limit(MHz)	Result
GFSK	Low	1.000	0.521	PASS
GFSK	Middle	1.000	0.521	PASS
GFSK	High	1.002	0.531	PASS
Pi/4 DQPSK	Low	1.002	0.821	PASS
Pi/4 DQPSK	Middle	1.000	0.807	PASS
Pi/4 DQPSK	High	1.000	0.820	PASS

**Test plots**  
GFSK Low Channel



GFSK Middle Channel



GFSK High Channel



Pi/4 DQPSK Low Channel

