

## FCC - TEST REPORT

Report Number : **68.760.23.0754.01-R1** Date of Issue: 2023-10-23

Model : **H8249-1.**

Product Type : IP Touch Lite 7

Applicant : ABB Xiamen Smart Technology Co., Ltd.

Address : 4th Floor, No. 881, FangShanXiEr Road, Xiang'An Industrial Area,  
Torch Hi-Tech Industrial Development Zone, 361000 Xiamen S.E.Z,  
Fujian Province, PEOPLE'S REPUBLIC OF CHINA

Manufacturer : ABB Xiamen Smart Technology Co., Ltd.

Address : 4th Floor, No. 881, FangShanXiEr Road, Xiang'An Industrial Area,  
Torch Hi-Tech Industrial Development Zone, 361000 Xiamen S.E.Z,  
Fujian Province, PEOPLE'S REPUBLIC OF CHINA

Test Result :  **Positive**       **Negative**

Total pages including Appendices : **271**

*Any use for advertising purposes must be granted in writing. This technical report may only be quoted in full. This report is the result of a single examination of the object in question and is not generally applicable evaluation of the quality of other products in regular production. For further details, please see testing and certification regulation chapter A-3.4.*



## 1 Table of Contents

1 Table of Contents .....	2
2 Details about the Test Laboratory .....	3
3 Description of the Equipment Under Test .....	4
4 Summary of Test Standards .....	5
5 Summary of Test Results.....	6
6 General Remarks.....	7
7 Test setups .....	8
7.1 Radiated test setups.....	8
7.2 Conducted RF test setups .....	9
7.3 AC Power Line Conducted Emission test setups .....	9
8. Systems test configuration.....	10
9 Technical Requirement.....	12
9.1 Conducted Emission .....	12
9.2 Emission bandwidth .....	15
9.3 Maximum conducted output power.....	16
9.4 Maximum power spectral density .....	17
9.5 Unwanted emissions .....	18
9.6 Frequencies Stability .....	24
9.7 Dynamic Frequency Selection (DFS) .....	25
10 Test Equipment List .....	35
11 System Measurement Uncertainly .....	36



## 2 Details about the Test Laboratory

### Details about the Test Laboratory

#### Test Site 1

Company name: TÜV SÜD Certification and Testing (China) Co., Ltd. Shenzhen Branch  
Building 12 & 13, Zhiheng Wisdomland Business Park, Guankou Erlu, Nantou, Nanshan District, Shenzhen, Guangdong, China

Telephone: 86 755 8828 6998

Fax: 86 755 8828 5299

FCC Registration No.: 514049

FCC Designation Number: CN5009

### 3 Description of the Equipment Under Test

Product:	IP Touch Lite 7
Model no.:	H8249-1.
FCC ID:	2AEBL-H8249
Options and accessories:	NIL
Ratings:	20-27VDC, 9W
RF Transmission Frequency:	2412MHz - 2462MHz for 2.4GHz Wi-Fi; 5180MHz – 5320MHz, 5500MHz – 5700MHz, 5745MHz – 5825MHz for 5GHz Wi-Fi (This device shall not be capable of transmitting in the band 5600-5650 MHz. This restriction is for the protection of Terminal Doppler Weather Radar (TDWR) operating in this band.)
No. of Operated Channel:	11 for 2.4GHz Wi-Fi; 43 for 5GHz Wi-Fi
Modulation:	802.11b: BPSK, QPSK, CCK, 802.11g: BPSK, QPSK, 16-QAM, 64-QAM 802.11a: BPSK, QPSK, 16-QAM, 64-QAM 802.11n: BPSK, QPSK, 16-QAM, 64-QAM 802.11ac: BPSK, QPSK, 16-QAM, 64-QAM, 256-QAM
Antenna Type:	Integrated FPC antenna
Antenna Gain:	4.5 dBi for 2.4GHz Wi-Fi 5.3 dBi for 5GHz Wi-Fi
Description of the EUT:	The EUT is an IP Touch Lite 7 supports Wi-Fi functions, 2412MHz - 2462MHz for 2.4GHz Wi-Fi, 5180MHz – 5320MHz, 5500MHz – 5700MHz, 5745MHz – 5825MHz for 5GHz Wi-Fi.

NOTE 1: The above EUT's information is declared by manufacturer. Please refer to the specifications or user's manual for more detailed description.



## 4 Summary of Test Standards

<b>Test Standards</b>	
FCC Part 15 Subpart E, October 1, 2021 Edition	PART 15 - RADIO FREQUENCY DEVICES Subpart E - Unlicensed National Information Infrastructure Devices

**Test Method:**

- KDB 789033 D02 General UNII Test Procedures New Rules v02r01
- KDB 905462 D02 UNII DFS Compliance Procedures New Rules v02
- KDB 905462 D03 Client Without DFS New Rules v01r02
- ANSI C63.10-2020, American National Standard of Procedures for Compliance Testing of Unlicensed Wireless Devices

## 5 Summary of Test Results

Technical Requirements			
FCC Part 15 Subpart E, October 1, 2021 Edition			
Test Condition	Test Result		
	Pass	Fail	N/A
15.207 Conducted Emission AC Power Port	<input checked="" type="checkbox"/>	<input type="checkbox"/>	<input type="checkbox"/>
15.407(e) Emission bandwidth	<input checked="" type="checkbox"/>	<input type="checkbox"/>	<input type="checkbox"/>
15.407(a) Maximum Conducted Output Power	<input checked="" type="checkbox"/>	<input type="checkbox"/>	<input type="checkbox"/>
15.407(a) Maximum Power Spectral Density	<input checked="" type="checkbox"/>	<input type="checkbox"/>	<input type="checkbox"/>
15.407(b)(1), 15.407(b)(2), 15.407(b)(3), 15.407(b)(4), 15.407(b)(8), 15.407(b)(9), 15.209 Unwanted Emissions	<input checked="" type="checkbox"/>	<input type="checkbox"/>	<input type="checkbox"/>
15.407(g) Frequencies Stability	<input checked="" type="checkbox"/>	<input type="checkbox"/>	<input type="checkbox"/>
15.407(h) Dynamic Frequency Selection (DFS) <sup>a</sup>	<input checked="" type="checkbox"/>	<input type="checkbox"/>	<input type="checkbox"/>
15.203 Antenna Requirement <sup>b</sup>	<input checked="" type="checkbox"/>	<input type="checkbox"/>	<input type="checkbox"/>

Remark: <sup>a</sup> The EUT is Clients Device without Radar Detection.

Remark: <sup>b</sup> The EUT uses an Integrated FPC antenna, which gains are 4.5 dBi for 2.4GHz WIFI and 5.3dBi for 5GHz WIFI. In accordance to §15.203 and RSS-Gen 6.8, it is considered sufficiently to comply with the provisions of this section.

## 6 General Remarks

### Remarks

EUT supports Wi-Fi functions: 2412MHz - 2462MHz for 2.4GHz Wi-Fi; 5180 - 5320 MHz, 5500 - 5700 MHz and 5745-5825 MHz for 5GHz Wi-Fi.

This submittal(s) (test report) is intended for FCC ID: 2AEBL-H8249, complies with Section 15.203, 15.205, 15.207, 15.209, 15.407 of the FCC Part 15, Subpart E.

This report is only for the 5GHz Wi-Fi band.

### SUMMARY:

All tests according to the regulations cited on page 6 were

- Performed

- **Not** Performed

The Equipment Under Test

- **Fulfills** the general approval requirements.

- **Does not** fulfill the general approval requirements.

Sample Received Date: 2023-08-11

Testing Start Date: 2023-08-14

Testing End Date: 2023-10-17

- TÜV SÜD Certification and Testing (China) Co., Ltd. Shenzhen Branch

Reviewed by:

Prepared by:

Tested by:

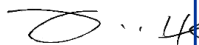

Jessie He  
Project Manager

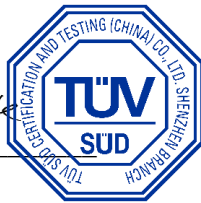

Myron Yu  
Project Engineer

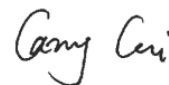

Carry Cai  
Test Engineer

## 7 Test setups

### 7.1 Radiated test setups

9kHz - 30MHz

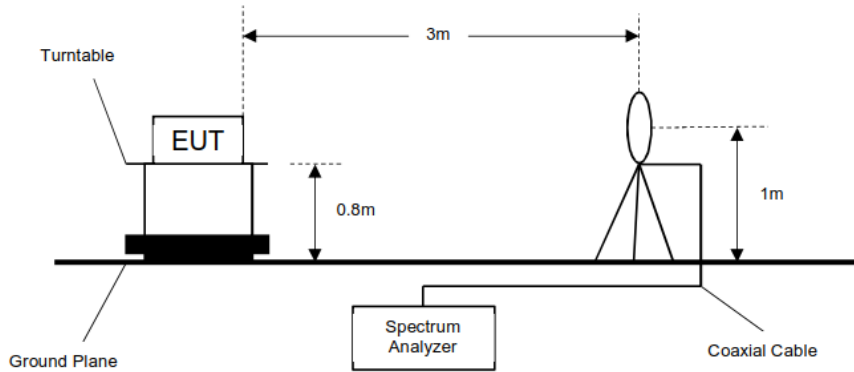

Below 1GHz

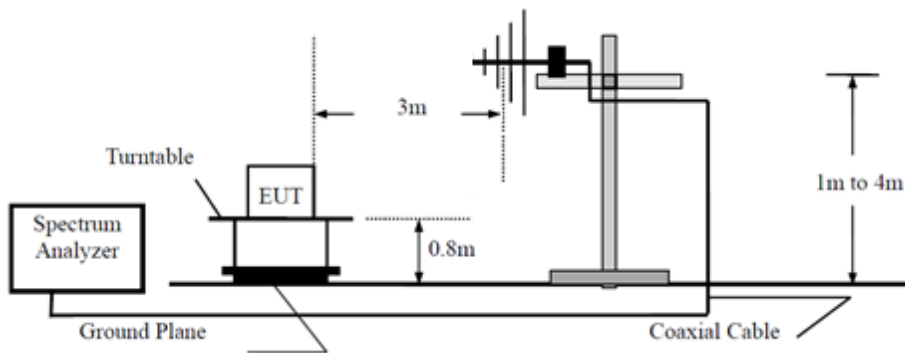

Above 1GHz

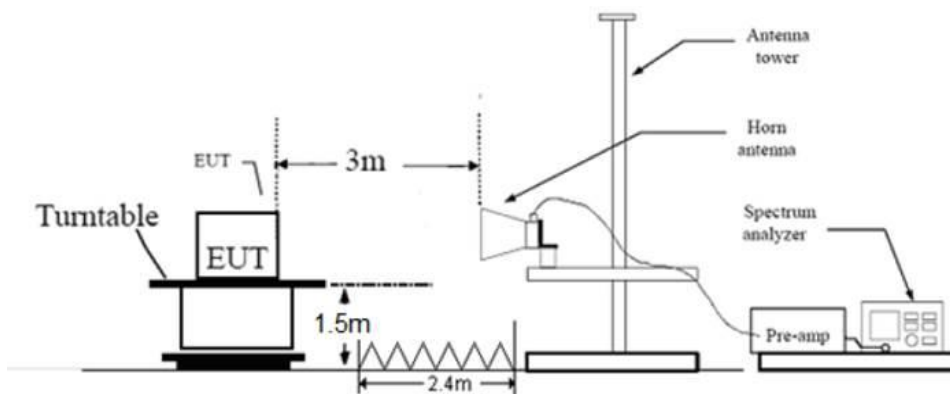



## 7.2 Conducted RF test setups

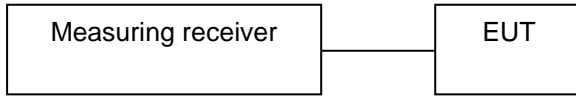

## 7.3 AC Power Line Conducted Emission test setups

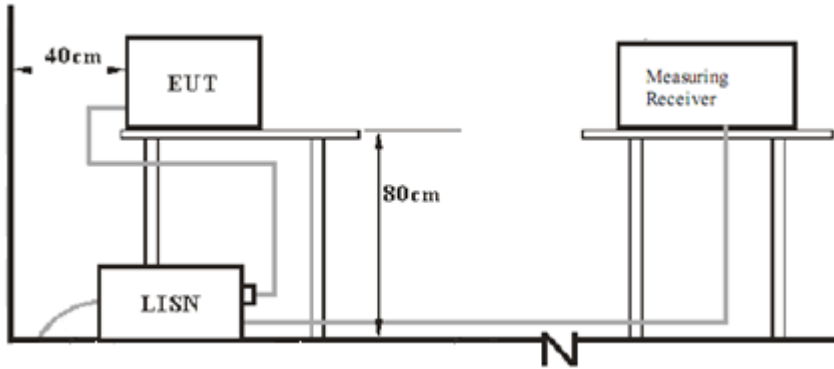

## 8. Systems test configuration

Auxiliary Equipment Used during Test:

DESCRIPTION	MODEL NO.(SHIELD)	MANUFACTURER	
Auxiliary Power supply	YSM01	ABB	---
ABB Welcome IP (Outdoor unit)	H81381T-S	ABB	---
PoE switch	TL-SG1210DP	TP-LINK	1225175003885

Test software information:

Test Software Version	PuTTY release 0.78	
Mode	Setting TX Power	Data Rate
802.11a	15	11g 6 Mbps
802.11n HT20	15	MCS0 6.5 Mbps
802.11n HT40	13	MCS0 13.5 Mbps(40MHz)
802.11ac VHT20	14	11ac MCS0 NGI 6.5 Mbps(20MHz),
802.11ac VHT40	13	11ac MCS0 NGI 13.5 Mbps(40MHz)
802.11ac VHT80	11	11ac MCS0 NGI 29.3 Mbps(80MHz)

The system was configured to channel:

Test Mode	Channel (MHz)		
802.11a, 802.11n HT20 802.11ac VHT20	5G WIFI-Band 1		
	CH36 (5180MHz)	CH40 (5200MHz)	CH48 (5240MHz)
	5G WIFI-Band 2		
	CH52 (5260MHz)	CH56 (5280MHz)	CH64 (5320MHz)
	5G WIFI-Band 3		
	CH100 (5500MHz)	CH116 (5580MHz)	CH140 (5700MHz)
	CH144 (5720MHz)		
	5G WIFI-Band 4		
	CH149 (5745MHz)	CH157(5785MHz)	CH165 (5825MHz)

Test Mode	Channel (MHz)		
802.11n HT40 802.11ac VHT40	5G WIFI-Band 1		
	CH38(5190MHz)	CH46 (5230MHz)	
	5G WIFI-Band 2		
	CH54(5270MHz)	CH62(5310MHz)	
	5G WIFI-Band 3		
	CH102(5510MHz)	CH110(5550MHz)	CH134(5670MHz)
	CH 142 (5710MHz)		
	5G WIFI-Band 4		
CH151(5755MHz)	CH159(5795MHz)		



Test Mode	Channel (MHz)		
802.11ac VHT80	5G WIFI-Band 1		
	CH42(5210MHz)		
	5G WIFI-Band 2		
	CH58(5290MHz)		
	5G WIFI-Band 3		
	CH106(5530MHz)	CH122(5610MHz)	CH138(5690MHz)
	5G WIFI-Band 4		
	CH155(5775MHz)		

## 9 Technical Requirement

### 9.1 Conducted Emission

#### Test Method

1. The EUT was placed 0.4 meter from the conducting wall of the shielding room was kept at least 80 centimeters from any other grounded conducting surface.
2. Connect EUT to the power mains through a line impedance stabilization network (LISN).
3. All the support units are connecting to the other LISN.
4. The LISN provides 50 ohm coupling impedance for the measuring instrument.
5. Both sides of AC line were checked for maximum conducted interference.
6. The frequency range from 150 kHz to 30 MHz was searched.
7. Set the test-receiver system to Peak Detect Function and specified bandwidth (IF Bandwidth = 9kHz) with Maximum Hold Mode. Then measurement is also conducted by Average Detector and Quasi-Peak Detector Function respectively

#### Limit

According to §15.207, conducted emissions limit as below:

Frequency MHz	QP Limit dB $\mu$ V	AV Limit dB $\mu$ V
0.150-0.500	66-56*	56-46*
0.500-5	56	46
5-30	60	50

Remark: "\*" Decreasing linearly with logarithm of the frequency

## Conducted Emission

Product Type : IP Touch Lite 7  
 M/N : H8249-1W  
 Operating Condition : Wi-Fi function on.  
 Test Specification : Power Line, Live  
 Comment : AC 120V/60Hz

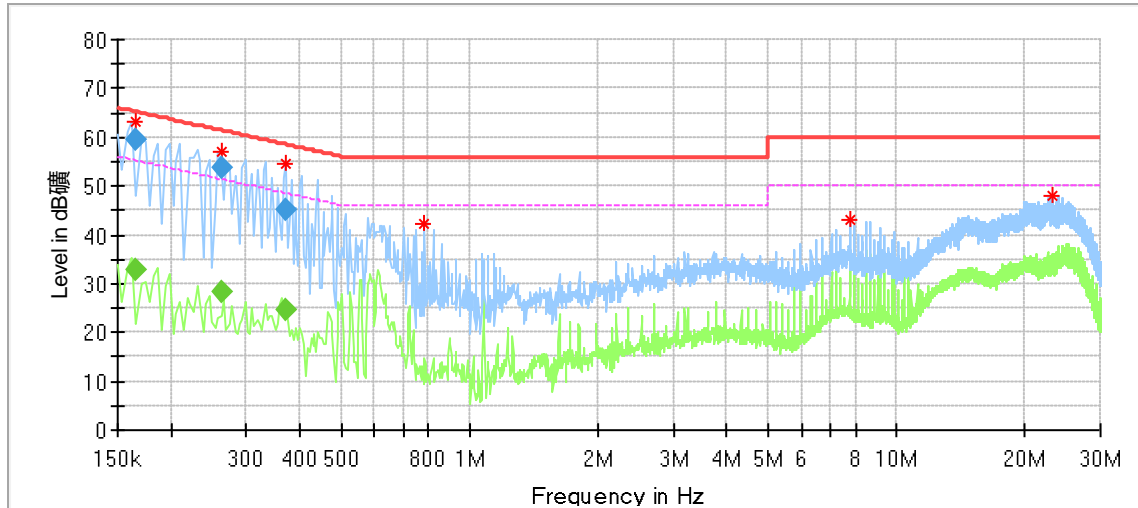

### Critical Freqs

Frequency (MHz)	MaxPeak (dBμV)	Average (dBμV)	Limit (dBμV)	Margin (dB)	Line	Corr. (dB)
0.165500	63.32	---	65.36	2.04	L1	9.54
0.261500	57.13	---	61.50	4.36	L1	9.56
0.369500	54.50	---	58.50	4.00	L1	9.57
0.786000	42.25	---	56.00	13.75	L1	9.60
7.750000	42.93	---	60.00	17.07	L1	9.87
23.082000	48.04	---	60.00	11.96	L1	10.05

### Final Result

Frequency (MHz)	QuasiPeak (dBμV)	Average (dBμV)	Limit (dBμV)	Margin (dB)	Line	Corr. (dB)
0.165500	---	32.72	55.18	22.46	L1	9.54
0.165500	59.53	---	65.18	5.65	L1	9.54
0.261500	---	28.47	51.38	22.91	L1	9.56
0.261500	53.60	---	61.38	7.79	L1	9.56
0.369500	---	24.62	48.51	23.90	L1	9.57
0.369500	45.07	---	58.51	13.44	L1	9.57

Remark:

Level=Reading Level + Correction Factor

Correction Factor=Cable Loss + LISN Factor

(The Reading Level is recorded by software which is not shown in the sheet)

## Conducted Emission

Product Type : IP Touch Lite 7  
 M/N : H8249-1W  
 Operating Condition : Wi-Fi function on.  
 Test Specification : Power Line, Neutral  
 Comment : AC 120V/60Hz

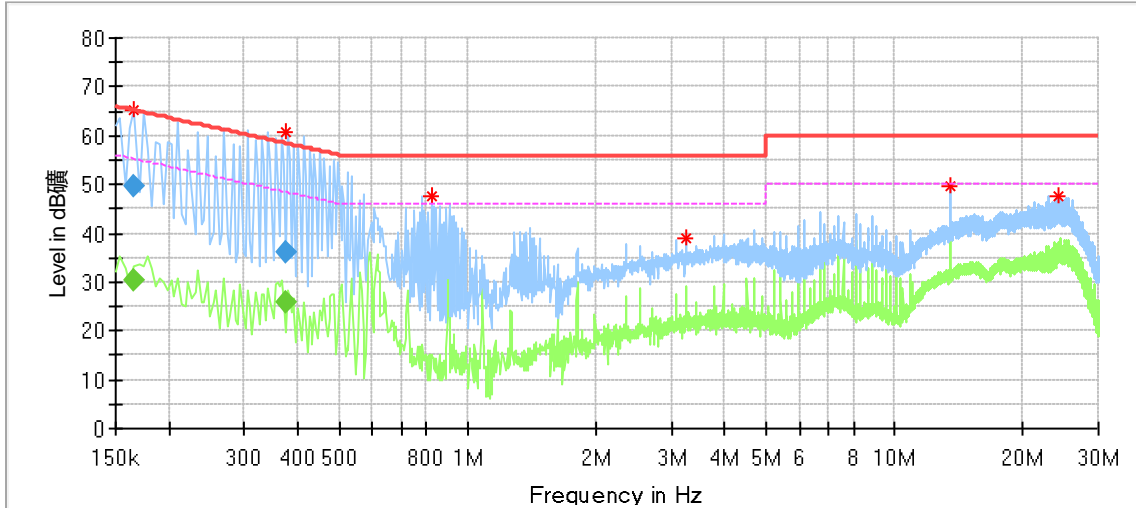

### Critical Freqs

Frequency (MHz)	MaxPeak (dBμV)	Average (dBμV)	Limit (dBμV)	Margin (dB)	Line	Corr. (dB)
0.165500	65.07	---	65.16	0.09	N	9.57
0.373500	60.92	---	58.32	-2.60	N	9.61
0.822000	47.55	---	56.00	8.45	N	9.63
3.250000	38.85	---	56.00	17.15	N	9.69
13.558000	49.80	---	60.00	10.20	N	9.99
24.202000	47.64	---	60.00	12.36	N	9.94

### Final Result

Frequency (MHz)	QuasiPeak (dBμV)	Average (dBμV)	Limit (dBμV)	Margin (dB)	Line	Corr. (dB)
0.165500	---	30.51	55.18	24.67	N	9.57
0.165500	49.75	---	65.18	15.43	N	9.57
0.373500	---	25.90	48.42	22.52	N	9.61
0.373500	36.18	---	58.42	22.24	N	9.61

Remark:

Level=Reading Level + Correction Factor

Correction Factor=Cable Loss + LISN Factor

(The Reading Level is recorded by software which is not shown in the sheet)

## 9.2 Emission bandwidth

The EUT was placed on 0.8m height table, the RF output of EUT was connected to the test receiver by RF cable. The path loss was compensated to the results for each measurement.

### 1. Test Method of 26dB Bandwidth

1. Set RBW = approximately 1% of the emission bandwidth.
2. Set the VBW > RBW.
3. Detector = Peak.
4. Trace mode = max hold.
5. Measure the maximum width of the emission that is 26 dB down from the maximum of the emission. Compare this with the RBW setting of the analyzer. Readjust RBW and repeat measurement as needed until the RBW/EBW ratio is approximately 1%.

**Limit:** No limit

### 2. Test Method of 6dB Bandwidth

1. Set center frequency to the nominal EUT channel center frequency
2. Set RBW = 100KHz
3. Set the video bandwidth (VBW)  $\geq 3 \times$  RBW
4. Detector = Peak.
5. Trace mode = max hold.
6. Sweep = Sweep = No faster than coupled (auto) time.
7. Allow the trace to stabilize.
8. Measure the maximum width of the emission that is constrained by the frequencies associated with the two outermost amplitude points (upper and lower frequencies) that are attenuated by 6 dB relative to the maximum level measured in the fundamental emission.
9. Record the results in the test report.

**Limit:**  $\geq 500$ KHz

### 3. Test Method of 99% Bandwidth

1. Set center frequency to the nominal EUT channel center frequency
2. Set span = 1.5 times to 5.0 times the OBW.
3. Set RBW = 1 % to 5 % of the OBW
4. Set VBW  $\geq 3$  RBW
5. Trace mode = max hold.
6. Sweep = auto couple.
7. Allow the trace to stabilize.
8. Use the 99 % power bandwidth function of the instrument.
9. Record the results in the test report.

**Limit:** No limit

**Test Result: Pass**

**See Appendix A1&A2&A3 for test data.**

## 9.3 Maximum conducted output power

### Test Method

According to C63.10, the EUT was placed on 0.8m height table, the RF output of EUT was connected to the test power meter by RF cable. The path loss was compensated to the results for each measurement.

(1) Measurements may be performed using a wideband RF power meter with a thermocouple detector or equivalent if all of the following conditions are satisfied:

The EUT is configured to transmit continuously or to transmit with a consistent duty cycle. At all times when the EUT is transmitting, it must be transmitting at its maximum power control level.

The integration period of the power meter exceeds the repetition period of the transmitted signal by at least a factor of five.

(2) If the transmitter does not transmit continuously, measure the duty cycle,  $x$ , of the transmitter output signal as described in 12.2 in C63.10-2020.

(3) Measure the average power of the transmitter. This measurement is an average over both the on and off periods of the transmitter.

(4) Adjust the measurement in dBm by adding  $10 \log (1/x)$  where  $x$  is the duty cycle (e.g.,  $10 \log (1/0.25)$  if the duty cycle is 25%).

### Limits:

For client devices in the 5.15-5.25 GHz band, the maximum conducted output power over the frequency band of operation shall not exceed 250 mW provided the maximum antenna gain does not exceed 6 dBi.

For the 5.25-5.35 GHz and 5.47-5.725 GHz bands, the maximum conducted output power over the frequency bands of operation shall not exceed the lesser of 250 mW or  $11 \text{ dBm} + 10 \log B$ , where  $B$  is the 26dB emission bandwidth in megahertz.

For the band 5.725-5.85 GHz, the maximum conducted output power over the frequency band of operation shall not exceed 1 W.

### Note:

1. Maximum Conducted Output Power=Conducted Output Power + Correction Factor

### Test Result: Pass

See Appendix B for test data.



## 9.4 Maximum power spectral density

### Test Method (Method SA-2 in C63.10-2020)

The EUT was placed on 0.8m height table, the RF output of EUT was connected to the test receiver by RF cable. The path loss was compensated to the results for each measurement. (trace averaging across on and off times of the EUT transmissions, followed by duty cycle correction).

1. Measure the duty cycle.
2. Set span to encompass the entire emission bandwidth (EBW) of the signal.
3. Set RBW = 1 MHz.
4. Set VBW  $\geq$  3 MHz.
5. Number of points in sweep  $\geq$  2 Span / RBW.
6. Sweep time = auto.
7. Detector = RMS
8. Trace average at least 100 traces in power averaging mode.
9. Add  $10 \log(1/x)$ , where x is the duty cycle, to the measured power in order to compute the average power during the actual transmission times. For example, add  $10 \log(1/0.25) = 6$  dB if the duty cycle is 25 percent.

### Limit:

The maximum power spectral density shall not exceed 11dBm for the 5.15-5.25GHz, 5.25-5.35GHz, 5.47-5.725 GHz Band in any 1 megahertz band.

For the band 5.725-5.85 GHz, the maximum power spectral density shall not exceed 30 dBm in any 500kHz band.

### Test Result: Pass

See Appendix C for test data.

## 9.5 Unwanted emissions

Transmitting spurious emission test result as below:

### Radiated Spurious Emission Test Method:

1. The EUT was placed on a turn table which is 1.5m above ground plane for above 1GHz and 0.8m above ground for below 1GHz at 3meter chamber room for test. The table was rotated 360 degrees to determine the position of the highest radiation.
2. The EUT was set 3 meters away from the interference – receiving antenna, which was mounted on the top of a variable – height antenna tower.
3. The height of antenna is varied from one meter to four meters above the ground to determine the maximum value of the field strength. Both horizontal and vertical polarizations of the antenna are set to make the measurement.
4. For each suspected emission, the EUT was arranged to its worst case and then the antenna was tuned to heights from 1 meter to 4 meters and the rotatable table was turned.
5. Use the following spectrum analyzer settings According to C63.10:
  - 1) Procedure for Unwanted Emissions Measurements Below 1000 MHz
    - RBW = 120 kHz
    - VBW = 300 kHz
    - Detector = Peak
    - Trace mode = max hold
  - 2) For Above 1GHz:  
Procedure for Peak Unwanted Emissions Measurements Above 1000 MHz
    - RBW = 1 MHz
    - VBW  $\geq$  3 MHz
    - Detector = Peak
    - Sweep time = auto
    - Trace mode = max hold
  - 3) Procedures for Average Unwanted Emissions Measurements above 1000 MHz
    - a) RBW = 1 MHz.
    - b) VBW  $\geq$  [3  $\times$  RBW].
    - c) Detector = Power averaging (rms), if [span / (# of points in sweep)]  $\leq$  RBW / 2.  
Satisfying this condition can require increasing the number of points in the sweep or reducing the span. If the condition is not satisfied, then the detector mode shall be set to peak.
    - d) Averaging type = power (i.e., rms) (As an alternative, the detector and averaging type may be set for linear voltage averaging. Some instruments require linear display mode to use linear voltage averaging. Log or dB averaging shall not be used.)
    - e) Sweep time = auto.
    - f) Perform a trace average of at least 100 traces if the transmission is continuous. If the transmission is not continuous, then the number of traces shall be increased by a factor of 1 / D, where D is the duty cycle. For example, with 50% duty cycle, at least 200 traces shall be averaged. (If a specific emission is demonstrated to be continuous—i.e., 100% duty cycle—then rather than turning ON and OFF with the transmit cycle, at least 100 traces shall be averaged.)
    - g) If tests are performed with the EUT transmitting at a duty cycle less than 98%, then a correction factor shall be added to the measurement results prior to comparing with the

emission limit, to compute the emission level that would have been measured had the test been performed at 100% duty cycle. The correction factor is computed as follows:

(1) If power averaging (rms) mode was used in the preceding step e), then the correction factor is  $[10 \log (1 / D)]$ , where D is the duty cycle. For example, if the transmit duty cycle was 50%, then 3 dB shall be added to the measured emission levels.

(2) If linear voltage averaging mode was used in the preceding step e), then the correction factor is  $[20 \log (1 / D)]$ , where D is the duty cycle. For example, if the transmit duty cycle was 50%, then 6 dB shall be added to the measured emission levels. If a specific emission is demonstrated to be continuous (100% duty cycle) rather than turning ON and OFF with the transmit cycle, then no duty cycle correction is required for that emission.

## Limit

The radio emission outside the operating frequency band shall be at least 20 dB below that in the 100 kHz bandwidth within the band that contains the highest level of the desired power. Radiated emissions which fall in the restricted bands, as defined in section 15.205, must comply with the radiated emission limits specified in section 15.209.

Frequency MHz	Field Strength uV/m	Field Strength dB $\mu$ V/m	Detector
30-88	100	40	QP
88-216	150	43.5	QP
216-960	200	46	QP
960-1000	500	54	QP
Above 1000	500	54	AV
Above 1000	5000	74	PK

According to part 15.407b (1) (2) (3) (4)

For transmitters operating in the 5.15-5.25 GHz band: All emissions outside of the 5.15-5.35 GHz band shall not exceed an e.i.r.p. of  $-27$  dBm/MHz.

For transmitters operating in the 5.25-5.35 GHz band: All emissions outside of the 5.15-5.35 GHz band shall not exceed an e.i.r.p. of  $-27$  dBm/MHz.

For transmitters operating in the 5.47-5.725 GHz band: All emissions outside of the 5.47-5.725 GHz band shall not exceed an e.i.r.p. of  $-27$  dBm/MHz.

For transmitters operating in the 5.725-5.85 GHz band: All emissions shall be limited to a level of  $-27$  dBm/MHz at 75 MHz or more above or below the band edge increasing linearly to 10 dBm/MHz at 25 MHz above or below the band edge, and from 25 MHz above or below the band edge increasing linearly to a level of 15.6 dBm/MHz at 5 MHz above or below the band edge, and from 5 MHz above or below the band edge increasing linearly to a level of 27 dBm/MHz at the band edge.

According to part 15.407b (9), Unwanted emissions below 1 GHz must comply with the general field strength limits set forth in §15.209.

According to part 15.407b (10), The provisions of §15.205 apply to intentional radiators operating under this section.

Note: According to C63.10, the Conversion Factors between E[dB $\mu$ V/m] and EIRP[dBm] as below:

$E[\text{dB}\mu\text{V/m}] = \text{EIRP}[\text{dBm}] + 95.2$ , for  $d = 3$  meters.

## Spurious radiated emissions for transmitter

According to C63.10, if the peak (or quasi-peak) measured value complies with the average limit, it is unnecessary to perform an average measurement, so AV emission value did not show in below table if the peak value complies with average limit.

Only the worst case (802.11ac40 modulation) test result is listed in the report.

Radiated Mode:

Transmitting spurious emission test result as below:

Below 1GHz

Frequency (MHz)	MaxPeak (dB $\mu$ V/m)	Limit (dB $\mu$ V/m)	Margin (dB)	Height (cm)	Pol	Azimuth (deg)	Corr. (dB/m)
44.711667	24.11	40.00	15.89	100.0	H	303.0	18.07
102.211111	22.72	43.50	20.78	100.0	H	26.0	16.08
281.230000*	31.86	46.00	14.14	100.0	H	0.0	18.09
349.992222	32.06	46.00	13.94	100.0	H	152.0	20.25
468.763333	39.30	46.00	6.70	200.0	H	2.0	22.39
656.242778	39.36	46.00	6.64	100.0	H	329.0	25.64
719.980000	41.73	46.00	4.27	100.0	H	305.0	26.77
47.783333	35.56	40.00	4.44	100.0	V	231.0	18.27
64.785333	36.23	40.00	3.77	100.0	V	48.0	15.45
95.690556	29.52	43.50	13.98	100.0	V	97.0	15.48
219.042222	29.79	46.00	16.21	100.0	V	200.0	16.20
468.763333	37.66	46.00	8.34	100.0	V	184.0	22.39
574.978333	37.86	46.00	8.14	100.0	V	160.0	24.32

Frequency (MHz)	QuasiPeak (dB $\mu$ V/m)	Limit (dB $\mu$ V/m)	Margin (dB)	Height (cm)	Pol	Azimuth (deg)	Corr. (dB/m)
719.980000	37.73	46.00	8.27	100.0	H	305.0	26.77
64.785333	31.07	40.00	8.93	100.0	V	48.0	15.44

Above 1GHz

802.11ac40 Modulation 5190MHz Test Result

Frequency (MHz)	MaxPeak (dB $\mu$ V/m)	Limit (dB $\mu$ V/m)	Margin (dB)	Height (cm)	Pol	Azimuth (deg)	Corr. (dB/m)
3063.000000	43.23	68.20	24.97	150.0	H	0.0	-0.73
6441.000000	52.97	68.20	15.23	150.0	H	193.0	9.52
10315.000000	42.31	68.20	25.89	150.0	H	219.0	11.43
2042.000000	38.07	68.20	30.13	150.0	V	0.0	-5.73
4045.000000*	45.14	74.00	28.86	150.0	V	320.0	2.93
9806.500000	39.16	68.20	29.04	150.0	V	149.0	11.35

## 802.11ac40 Modulation 5230MHz Test Result

Frequency (MHz)	MaxPeak (dB $\mu$ V/m)	Limit (dB $\mu$ V/m)	Margin (dB)	Height (cm)	Pol	Azimuth (deg)	Corr. (dB/m)
2136.000000	39.07	68.20	29.13	150.0	H	93.0	-5.49
4178.000000*	46.20	74.00	27.80	150.0	H	203.0	3.64
9937.500000	41.44	68.20	26.76	150.0	H	30.0	11.27
3080.000000	43.11	68.20	25.09	150.0	V	78.0	-0.86
6804.000000	52.88	68.20	15.32	150.0	V	102.0	10.10
10264.000000	41.51	68.20	26.69	150.0	V	262.0	11.44

## 802.11ac40 Modulation 5270MHz Test Result

Frequency (MHz)	MaxPeak (dB $\mu$ V/m)	Limit (dB $\mu$ V/m)	Margin (dB)	Height (cm)	Pol	Azimuth (deg)	Corr. (dB/m)
1968.000000	38.16	68.20	30.04	150.0	H	100.0	-6.39
3060.000000	45.19	68.20	23.01	150.0	H	291.0	-0.70
11153.000000*	42.73	74.00	31.27	150.0	H	168.0	12.30
1632.500000	34.70	68.20	33.50	150.0	V	227.0	-8.82
3814.500000*	47.76	74.00	26.24	150.0	V	60.0	2.65
9087.000000*	39.84	74.00	34.16	150.0	V	78.0	10.22

## 802.11ac40 Modulation 5310MHz Test Result

Frequency (MHz)	MaxPeak (dB $\mu$ V/m)	Limit (dB $\mu$ V/m)	Margin (dB)	Height (cm)	Pol	Azimuth (deg)	Corr. (dB/m)
3969.500000*	46.71	74.00	27.29	150.0	H	96.0	2.81
8344.000000*	39.66	74.00	34.34	150.0	H	57.0	9.55
13004.000000	42.13	68.20	26.07	150.0	H	243.0	14.01
3080.500000	44.54	68.20	23.66	150.0	V	284.0	-0.85
6850.000000	54.31	68.20	13.89	150.0	V	292.0	10.28
8905.500000	41.32	68.20	26.88	150.0	V	114.0	10.33

## 802.11ac40 Modulation 5590MHz Test Result

Frequency (MHz)	MaxPeak (dB $\mu$ V/m)	Limit (dB $\mu$ V/m)	Margin (dB)	Height (cm)	Pol	Azimuth (deg)	Corr. (dB/m)
3727.000000	49.79	74.00	24.21	150.0	H	351.0	2.06
5581.000000	58.95	---	---	150.0	H	314.0	7.30
6999.000000	55.15	68.20	13.05	150.0	H	356.0	10.50
3152.000000	46.24	68.20	21.96	150.0	V	186.0	-0.18
4826.000000	50.46	74.00	23.54	150.0	V	257.0	5.26
6961.000000	54.67	68.20	13.53	150.0	V	163.0	10.37

## 802.11ac40 Modulation 5670MHz Test Result

Frequency (MHz)	MaxPeak (dB $\mu$ V/m)	Limit (dB $\mu$ V/m)	Margin (dB)	Height (cm)	Pol	Azimuth (deg)	Corr. (dB/m)
4670.000000	49.65	74.00	24.35	150.0	H	25.0	4.33
5679.000000	58.69	---	---	150.0	H	322.0	7.15
6919.500000	54.63	68.20	13.57	150.0	H	88.0	10.32
2069.500000	41.22	68.20	26.98	150.0	V	258.0	-5.71
4345.000000*	50.27	74.00	23.73	150.0	V	356.0	4.17
6833.000000	55.73	68.20	12.47	150.0	V	305.0	10.24

## 802.11ac40 Modulation 5755MHz Test Result

Frequency (MHz)	MaxPeak (dB $\mu$ V/m)	Limit (dB $\mu$ V/m)	Margin (dB)	Height (cm)	Pol	Azimuth (deg)	Corr. (dB/m)
1464.000000*	40.89	74.00	33.11	150.0	H	0.0	-9.82
5705.000000	56.43	68.20	11.77	150.0	H	320.0	7.21
9908.000000	41.73	68.20	26.47	150.0	H	127.0	11.32
3095.000000	44.48	68.20	23.72	150.0	V	0.0	-0.64
4620.500000*	49.69	74.00	24.31	150.0	V	8.0	4.25
10028.500000	41.39	68.20	26.81	150.0	V	337.0	11.39

Frequency (MHz)	Average (dB $\mu$ V/m)	Limit (dB $\mu$ V/m)	Margin (dB)	Height (cm)	Pol	Azimuth (deg)	Corr. (dB/m)
5705.000000	52.10	54.00	1.90	150.0	H	320.0	7.21

## 802.11ac40 Modulation 5795MHz Test Result

Frequency (MHz)	MaxPeak (dB $\mu$ V/m)	Limit (dB $\mu$ V/m)	Margin (dB)	Height (cm)	Pol	Azimuth (deg)	Corr. (dB/m)
1464.000000*	39.90	74.00	34.10	150.0	H	12.0	-9.82
3864.000000*	49.45	74.00	24.55	150.0	H	356.0	2.85
9473.500000*	41.97	74.00	32.03	150.0	H	242.0	11.07
3810.500000*	46.75	74.00	27.25	150.0	V	161.0	2.64
5033.500000*	51.17	74.00	22.83	150.0	V	138.0	5.91
9174.000000*	42.32	74.00	31.68	150.0	V	219.0	10.41

## Remark:

- (1) "\*" means the emission(s) appear within the restrict bands shall follow the requirement of § 15.205 and RSS-Gen section 8.10.
  - (2) Data of measurement within frequency ranges 9kHz-30MHz and 18-40GHz are the noise floor or attenuated more than 20dB below the permissible limits or the field strength is too small to be measured, so test data does not present in this report,
  - (3) Level= Reading Level + Correction Factor
  - (4) Above 1GHz: Corrector factor = Antenna Factor + Cable Loss- Amplifier Gain  
Below 1GHz: Corrector factor = Antenna Factor + Cable Loss
- (The Reading Level is recorded by software which is not shown in the sheet)

## Conducted Spurious Emission Test Method:

According to KBD789033 D02

1. The EUT was placed on 0.8m height table, the RF output of EUT was connected to the test receiver by RF cable. The path loss was compensated to the results for each measurement.

2. For transmitters with operating frequencies in the band 5150-5250 MHz, all emissions outside the band 5150-5350 MHz shall not exceed -27 dBm/MHz e.i.r.p. Any unwanted emissions that fall into the band 5250-5350 MHz shall be attenuated below the channel power by at least 26 dB, when measured using a resolution bandwidth between 1 and 5% of the occupied bandwidth (i.e. 99% bandwidth), above 5250 MHz. The 26 dB bandwidth may fall into the 5250-5350 MHz band; however, if the occupied bandwidth also falls within the 5250-5350 MHz band, the transmission is considered as intentional and the devices shall comply with all requirements in the band 5250-5350 MHz including implementing dynamic frequency selection (DFS) and TPC, on the portion of the emission that resides in the 5250-5350 MHz band.

- a) Set RBW  $\geq$  between 1 and 5% of the occupied bandwidth (i.e. 99% bandwidth)
- b) Set VBW  $\geq$  3 RBW.

### Limits:

For transmitters with operating frequencies in the band 5150-5250 MHz, all emissions outside the band 5150-5350 MHz shall not exceed -27 dBm/MHz e.i.r.p. Any unwanted emissions that fall into the band 5250-5350 MHz shall be attenuated below the channel power by at least 26 dB, when measured using a resolution bandwidth between 1 and 5% of the occupied bandwidth (i.e. 99% bandwidth), above 5250 MHz. The 26 dB bandwidth may fall into the 5250-5350 MHz band; however, if the occupied bandwidth also falls within the 5250-5350 MHz band, the transmission is considered as intentional and the devices shall comply with all requirements in the band 5250-5350 MHz including implementing dynamic frequency selection (DFS) and TPC, on the portion of the emission that resides in the 5250-5350 MHz band.

For transmitters operating in the 5.25-5.35 GHz band: All emissions outside the band 5250-5350 MHz shall not exceed -27 dBm/MHz e.i.r.p.

For transmitters operating in the 5.47-5.725 GHz band: All emissions outside of the 5.47-5.725 GHz band shall not exceed -27 dBm/MHz e.i.r.p.

For transmitters operating in the 5.725-5.85 GHz band: shall have e.i.r.p. of unwanted emissions comply with the following:

- a) 27 dBm/MHz at frequencies from the band edges decreasing linearly to 15.6 dBm/MHz at 5 MHz above or below the band edges;
- b) 15.6 dBm/MHz at 5 MHz above or below the band edges decreasing linearly to 10 dBm/MHz at 25 MHz above or below the band edges;
- c) 10 dBm/MHz at 25 MHz above or below the band edges decreasing linearly to -27 dBm/MHz at 75 MHz above or below the band edges; and
- d) -27 dBm/MHz at frequencies more than 75 MHz above or below the band edges.

**Test Result: Pass**

**See Appendix D1&D2 for test data.**



## 9.6 Frequencies Stability

### Test Method

1. The EUT was placed on 0.8m height table, the RF output of EUT was connected to the test receiver by RF cable. The path loss was compensated to the results for each measurement.
2. Set Centre Frequency of the channel under test.
3. Set Detector PEAK
4. Set RBW: 10KHz, VBW: 3RBW
5. Set Span: Encompass the entire emissions bandwidth (EBW) of the signal.
6. Allow the trace to stabilize, find the peak value of the power envelope and record the frequency, then calculated the frequency drift.

The test extreme voltage is to change the primary supply voltage from 85 to 115 percent of the nominal value.

User manual temperature is 0°C to +45°C, normal Temperature is +25°C.

Manufacturers of U-NII devices are responsible for ensuring frequency stability such that an emission is maintained within the band of operation under all conditions of normal operation as specified in the users manual.

Test Results (All conditions and all modes were performed, only list Worst-Case in the report)

Remark: NV is normal Voltage: 24Vdc, HV is High Voltage: 27.6Vdc, LV is Low Voltage: 20.4Vdc, NT is normal Temperature: +25°C.

### Test Result: Pass

See Appendix E for test data.



## 9.7 Dynamic Frequency Selection (DFS)

### Mode of Operation:

Parameters of EUT	
Frequency	5250-5350MHz 5470-5600MHz 5650-5725MHz
Operational Mode	<input type="checkbox"/> Master <input checked="" type="checkbox"/> Client without Radar Detection <input type="checkbox"/> Client with Radar Detection
Modulation	OFDM
Channel Bandwidth	20MHz, 40MHz, 80MHz

### Working Modes and required Test Items

The manufacturer shall whether the EUT is capable of operating as a master and a client. If the EUT is capable of operating in more than one operating mode then each operating mode shall be tested separately.

**Table 1: Applicability of DFS Requirements Prior to Use of a Channel**

Requirement	Operational Mode		
	Master	Client Without Radar Detection	Client With Radar Detection
<i>Non-Occupancy Period</i>	Yes	Not required	Yes
<i>DFS Detection Threshold</i>	Yes	Not required	Yes
<i>Channel Availability Check Time</i>	Yes	Not required	Not required
<i>U-NII Detection Bandwidth</i>	Yes	Not required	Yes

**Table 2: Applicability of DFS requirements during normal operation**

Requirement	Operational Mode	
	Master Device or Client with Radar Detection	Client Without Radar Detection
<i>DFS Detection Threshold</i>	Yes	Not required
<i>Channel Closing Transmission Time</i>	Yes	Yes
<i>Channel Move Time</i>	Yes	Yes
<i>U-NII Detection Bandwidth</i>	Yes	Not required

Additional requirements for devices with multiple bandwidth modes	Master Device or Client with Radar Detection	Client Without Radar Detection
<i>U-NII Detection Bandwidth and Statistical Performance Check</i>	All BW modes must be tested	Not required
<i>Channel Move Time and Channel Closing Transmission Time</i>	Test using widest BW mode available	Test using the widest BW mode available for the link
<i>All other tests</i>	Any single BW mode	Not required
<b>Note:</b> Frequencies selected for statistical performance check (Section 7.8.4) should include several frequencies within the radar detection bandwidth and frequencies near the edge of the radar detection bandwidth. For 802.11 devices it is suggested to select frequencies in each of the bonded 20 MHz channels and the channel center frequency.		

**Requirement:**

Per KDB 905462 D02 v02 the following are the requirements for client Devices:

- a) A Client Device will not transmit before having received appropriate control signals from a Master Device.
- b) A Client Device will stop all its transmissions whenever instructed by a Master Device to which it is associated and will meet the Channel Move Time and Channel Closing Transmission Time requirements. The Client Device will not resume any transmissions until it has again received control signals from a Master Device.
- c) If a Client Device is performing In-Service Monitoring and detects a Radar Waveform above the DFS Detection Threshold, it will inform the Master Device. This is equivalent to the Master Device detecting the Radar Waveform and d) through f) of section 5.1.1 apply.
- d) Irrespective of Client Device or Master Device detection the Channel Move Time and Channel Closing Transmission Time requirements remain the same.
- e) The client test frequency must be monitored to ensure no transmission of any type has occurred for 30 minutes. Note: If the client moves with the master, the device is considered compliant if nothing appears in the client non-occupancy period test. For devices that shut down (rather than moving channels), no beacons should appear.

**Table 3: DFS Response Requirement Values**

<b>Parameter</b>	<b>Value</b>
<i>Non-occupancy period</i>	Minimum 30 minutes
<i>Channel Availability Check Time</i>	60 seconds
<i>Channel Move Time</i>	10 seconds See Note 1.
<i>Channel Closing Transmission Time</i>	200 milliseconds + an aggregate of 60 milliseconds over remaining 10 second period. See Notes 1 and 2.
<i>U-NII Detection Bandwidth</i>	Minimum 100% of the U-NII 99% transmission power bandwidth. See Note 3.

**Note 1:** *Channel Move Time* and the *Channel Closing Transmission Time* should be performed with Radar Type 0. The measurement timing begins at the end of the Radar Type 0 burst.

**Note 2:** The *Channel Closing Transmission Time* is comprised of 200 milliseconds starting at the beginning of the *Channel Move Time* plus any additional intermittent control signals required to facilitate a *Channel* move (an aggregate of 60 milliseconds) during the remainder of the 10 second period. The aggregate duration of control signals will not count quiet periods in between transmissions.

**Note 3:** During the *U-NII Detection Bandwidth* detection test, radar type 0 should be used. For each frequency step the minimum percentage of detection is 90 percent. Measurements are performed with no data traffic.

### DFS Detection Thresholds Values

Table 4 below provides the DFS Detection Thresholds for Master Devices as well as Client Devices incorporating In-Service Monitoring.

**Table 4: DFS Detection Thresholds for Master Devices and Client Devices with Radar Detection**

<b>Maximum Transmit Power</b>	<b>Value (See Notes 1, 2, and 3)</b>
EIRP $\geq$ 200 milliwatt	-64 dBm
EIRP < 200 milliwatt and power spectral density < 10 dBm/MHz	-62 dBm
EIRP < 200 milliwatt that do not meet the power spectral density requirement	-64 dBm

**Note 1:** This is the level at the input of the receiver assuming a 0 dBi receive antenna.

**Note 2:** Throughout these test procedures an additional 1 dB has been added to the amplitude of the test transmission waveforms to account for variations in measurement equipment. This will ensure that the test signal is at or above the detection threshold level to trigger a DFS response.

**Note 3:** EIRP is based on the highest antenna gain. For MIMO devices refer to KDB Publication 662911 D01.

### Test Procedure

The FCC KDB 905462 D02 v02 describes a radiated test setup and a conducted test setup. A conducted test setup was used for this testing. Figure 1 shows the typical test setup. One channel selected between 5260 and 5350 MHz is chosen for the testing.

**Figure 1. Test Setup for DFS**

Setup for client with injection at the master.

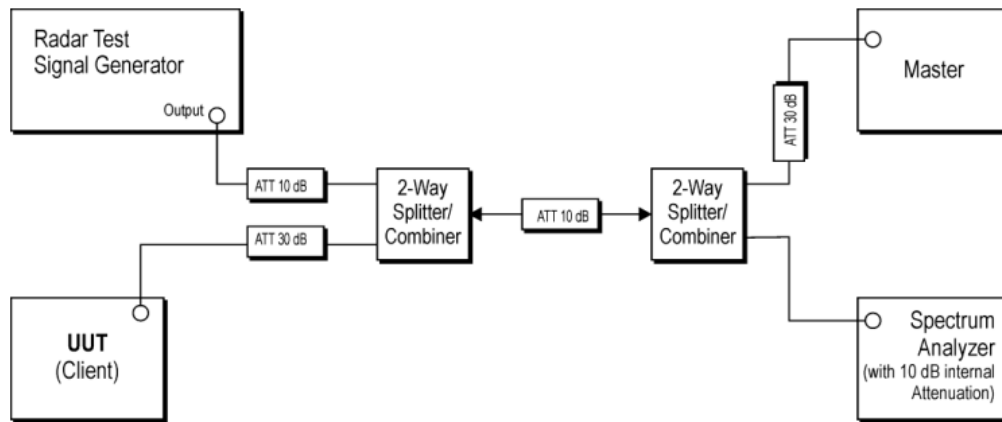

**Channel Closing Transmission Time, Channel Move Time and Non-Occupancy Period.**

Block Diagram of test setup test procedure.

- (1) The Radar Pulse generator is setup to provide a pulse at frequency that the master and client are operating, A type 0 radar pulse is used for the testing.
- (2) The vector signal generator is adjusted to provide the radar burst (18 pulses) at the level of approximately -62dBm at the antenna of the master device.
- (3) A trigger is provided from the pulse generator to the DFS monitoring system in order to capture the traffic and the occurrence of the radar pulse.
- (4) The Client Device (EUT) is set up per the diagram in Figure 1 and communications between the Master device and the Client is established.
- (5) Iperf software is used to properly load the test channel.
- (6) The real ime spectrum analyzer is set to record a 16sec window to any transmissions occurring up to and after 10sec.
- (7) The system is again setup and the monitoring time is shortened in order to capture the Channel Closing Transmission Time. This time is measured to ensure that the Client ceases transmission within 200ms and the aggregate of emissions occurring after 200ms up to 10 sec do not exceed 60ms.  
(Note: the channel may be different since the Master and Client have changed channels due to the detection of e initial radar pulse.)
- (8) After the initial radar burst the channel is monitored for 30 minutes to ensure no transmissions or beacons occur. A second monitoring setup is used to verify that the Master and Client have both moved to different channels.

**Test Result**

Clause	Test Parameter	Remarks	Pass/Fail
15.407	DFS Detection Threshold	Not Applicable	N/A
15.407	Channel Availability Check time	Not Applicable	N/A
15.407	Channel Move time	Applicable	Pass
15.407	Channel Closing Transmission time	Applicable	Pass
15.407	Non-occupancy Period	Not Applicable	N/A
15.407	Uniform Spreading	Not Applicable	N/A
15.407	U-NII Detection Bandwidth	Not Applicable	N/A

**DFS Detection Thresholds:**

Test Mode	Channel [MHz]	Radar Type	Result [dbm]	Limit [dbm]	Verdict
11AC20SISO	5260	Type0	-62.75	-61.00	PASS
	5500	Type0	-62.94	-61.00	PASS
11AC40SISO	5270	Type0	-62.07	-61.00	PASS
	5510	Type0	-62.80	-61.00	PASS
11AC80SISO	5290	Type0	-62.53	-61.00	PASS
	5530	Type0	-62.77	-61.00	PASS

**Channel Move Time and Channel Closing Transmission Time:**

Test Mode	Channel [MHz]	CCT [s]	Limit [s]	CMT [ms]	Limit [ms]	Verdict
11AC20SISO	5260	16.9	60	9326.2	10000	PASS
	5500	13	60	451.1	10000	PASS
11AC40SISO	5270	13	60	492.7	10000	PASS
	5510	15.6	60	503.1	10000	PASS
11AC80SISO	5290	33.8	60	2590.9	10000	PASS
	5530	0	60	0	10000	PASS

### Test Graphs - DFS Detection Thresholds

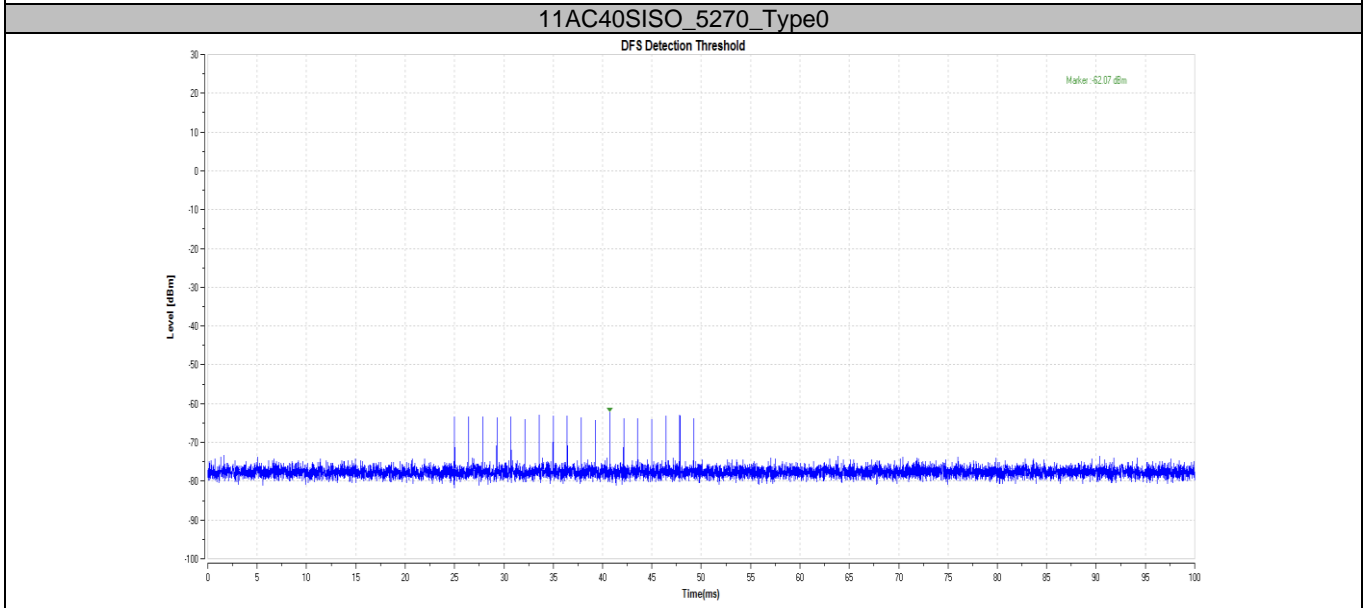
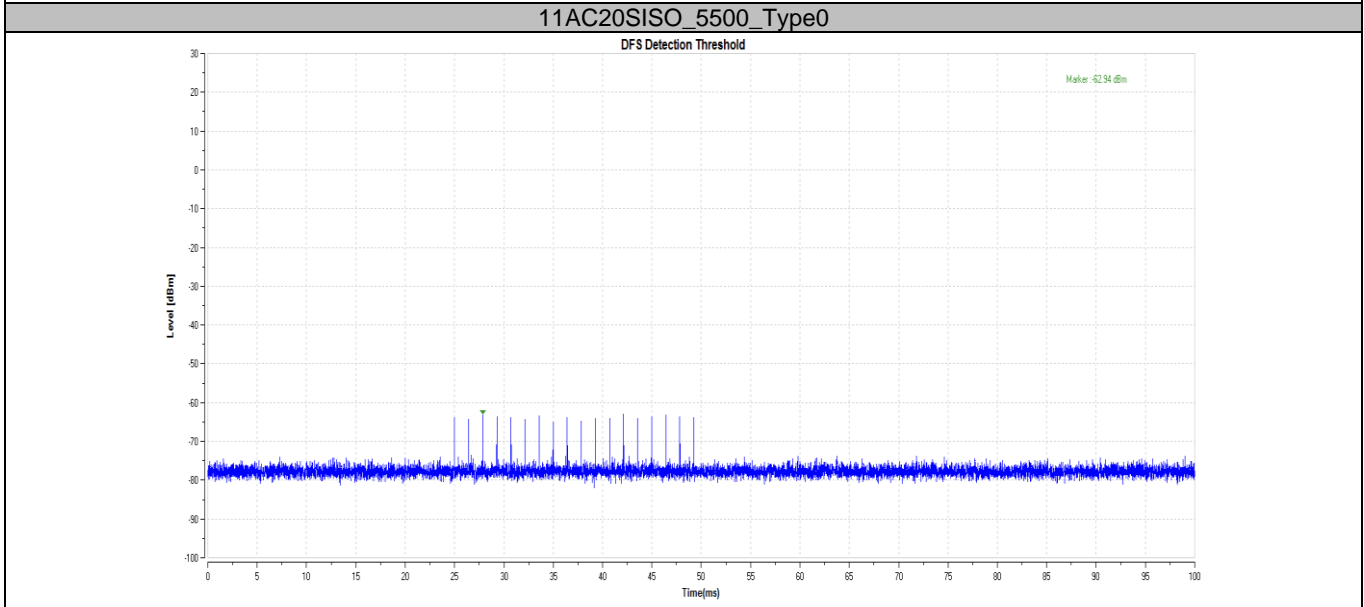
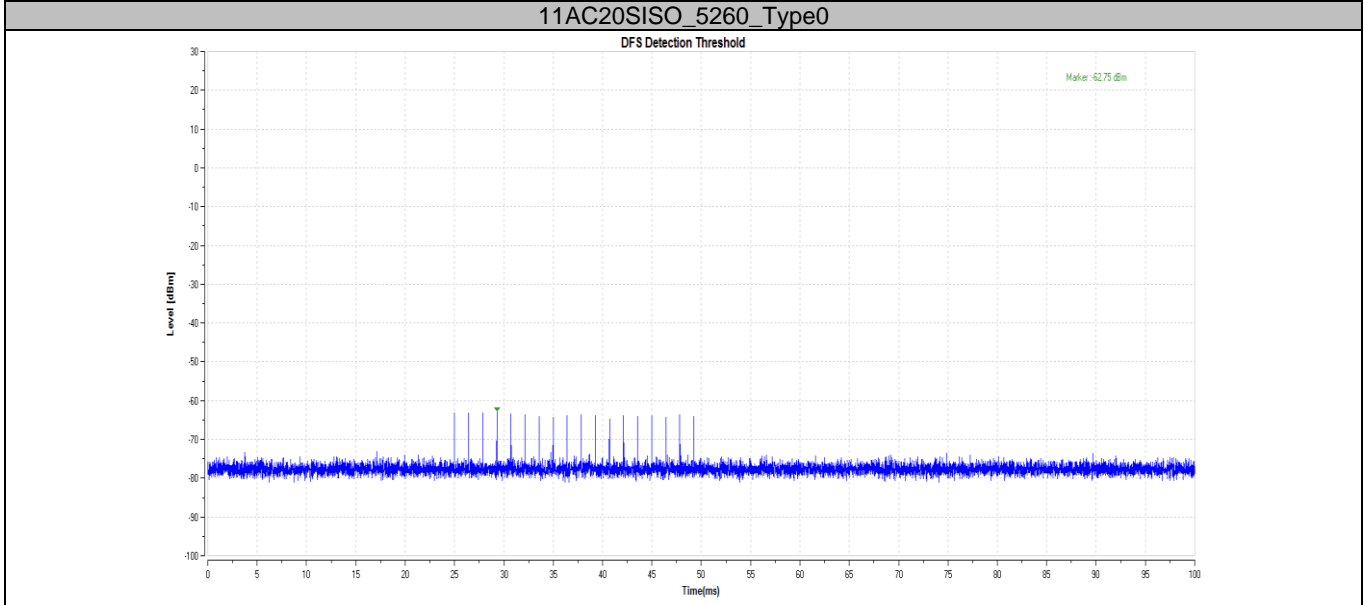

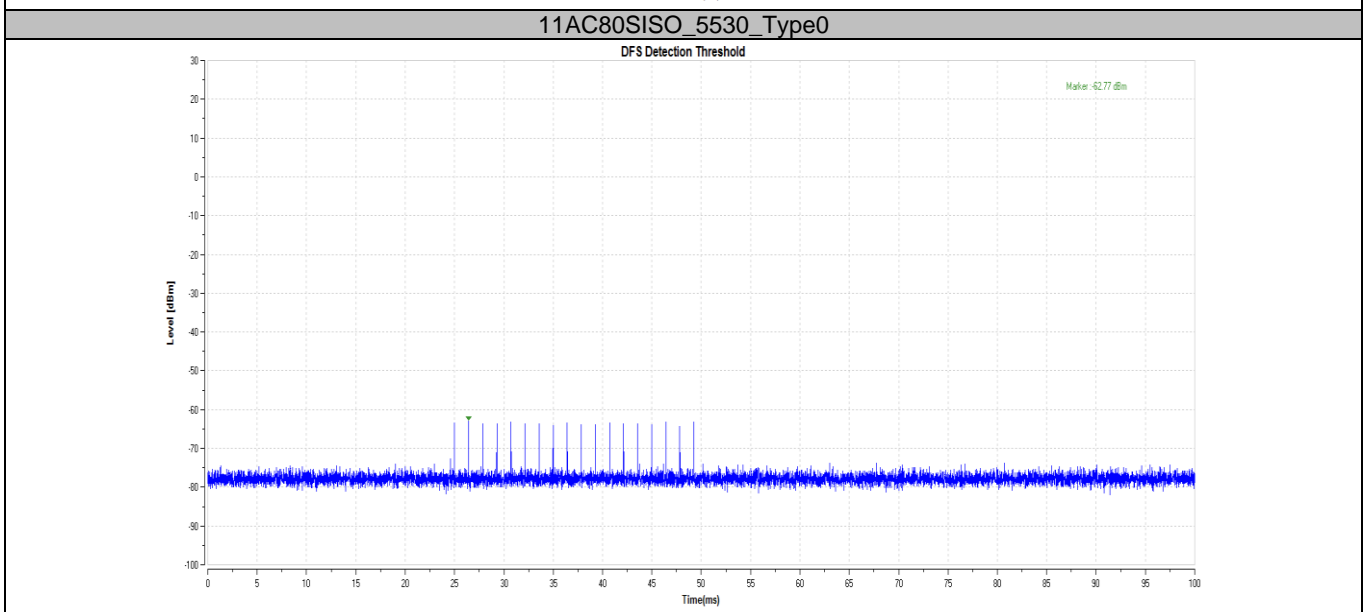
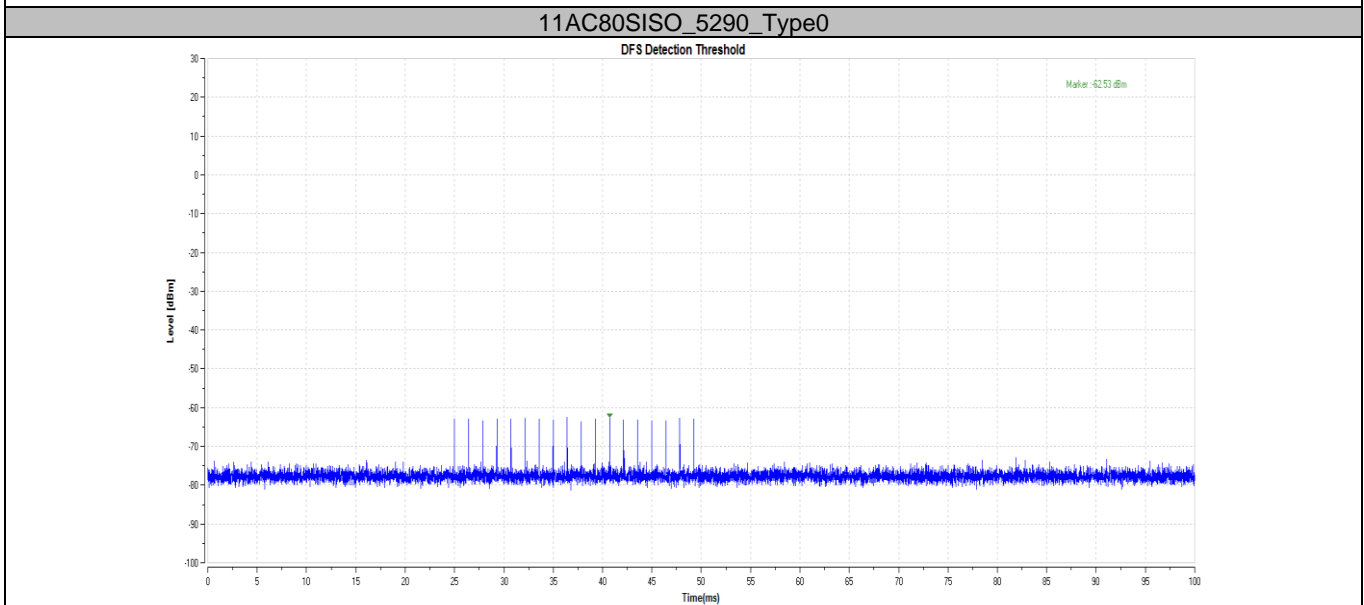
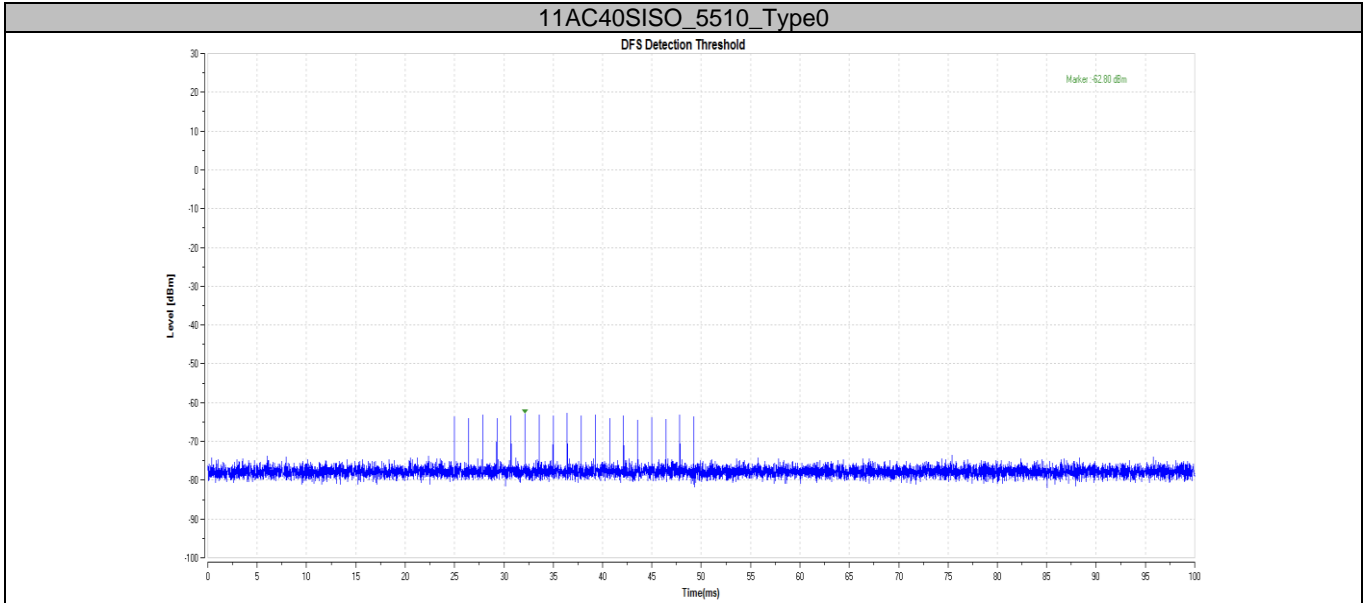



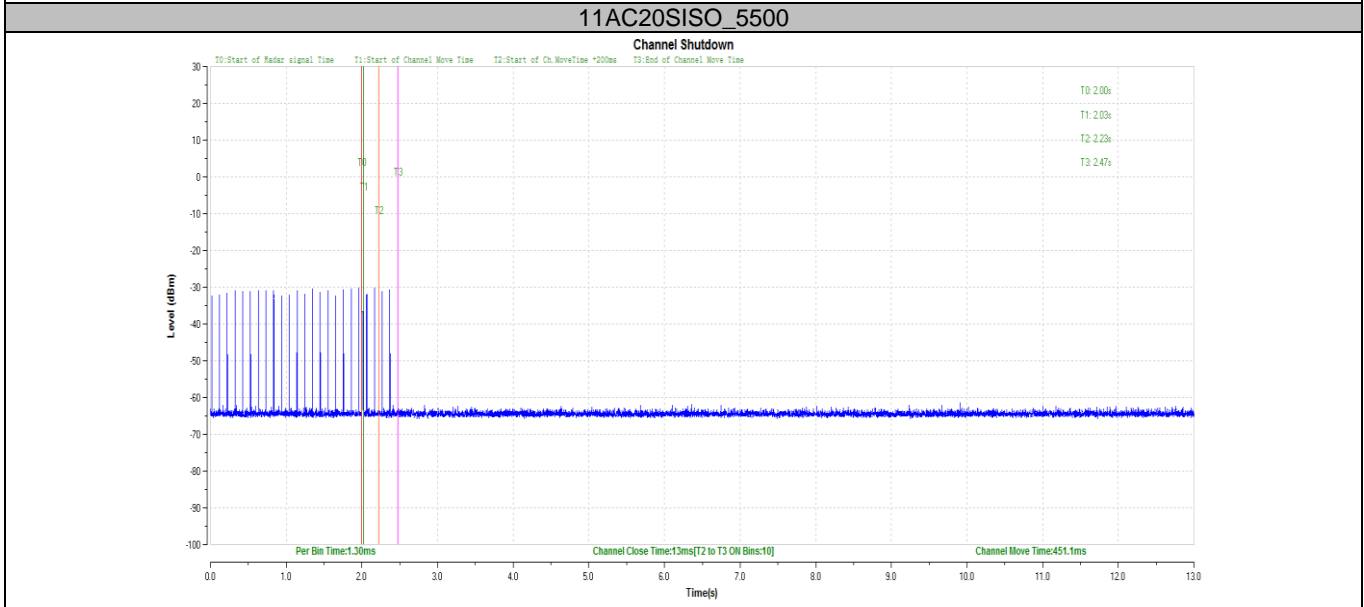
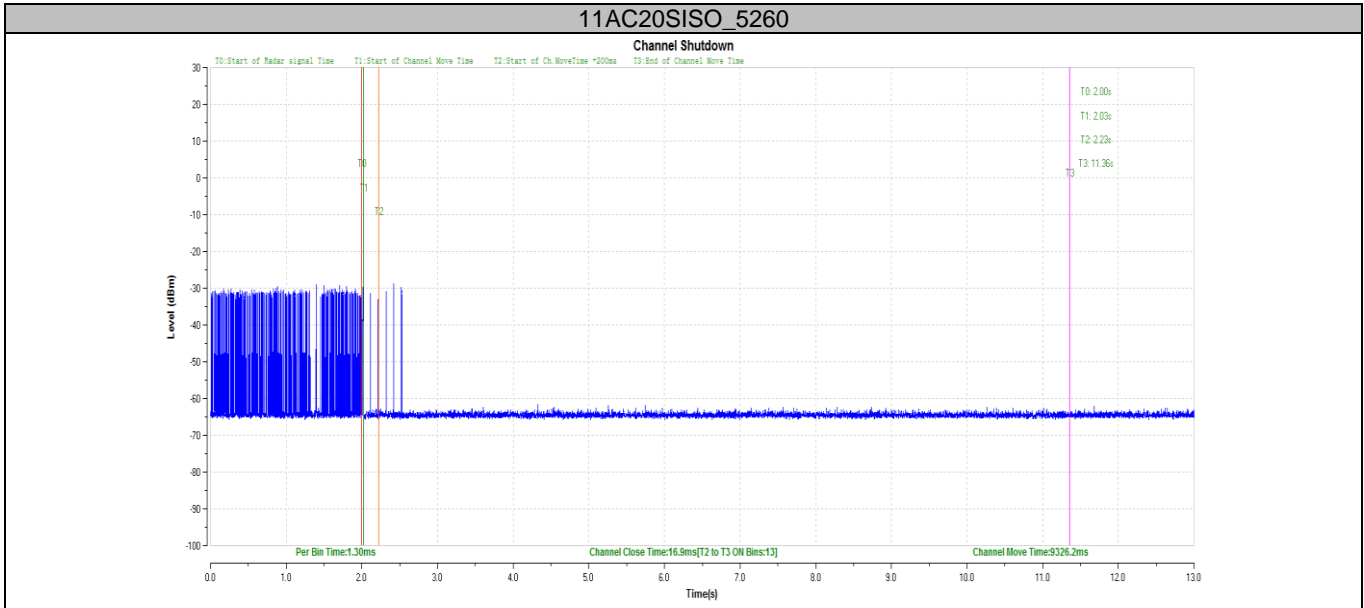



Test Graphs - Channel Move Time and Channel Closing Transmission Time

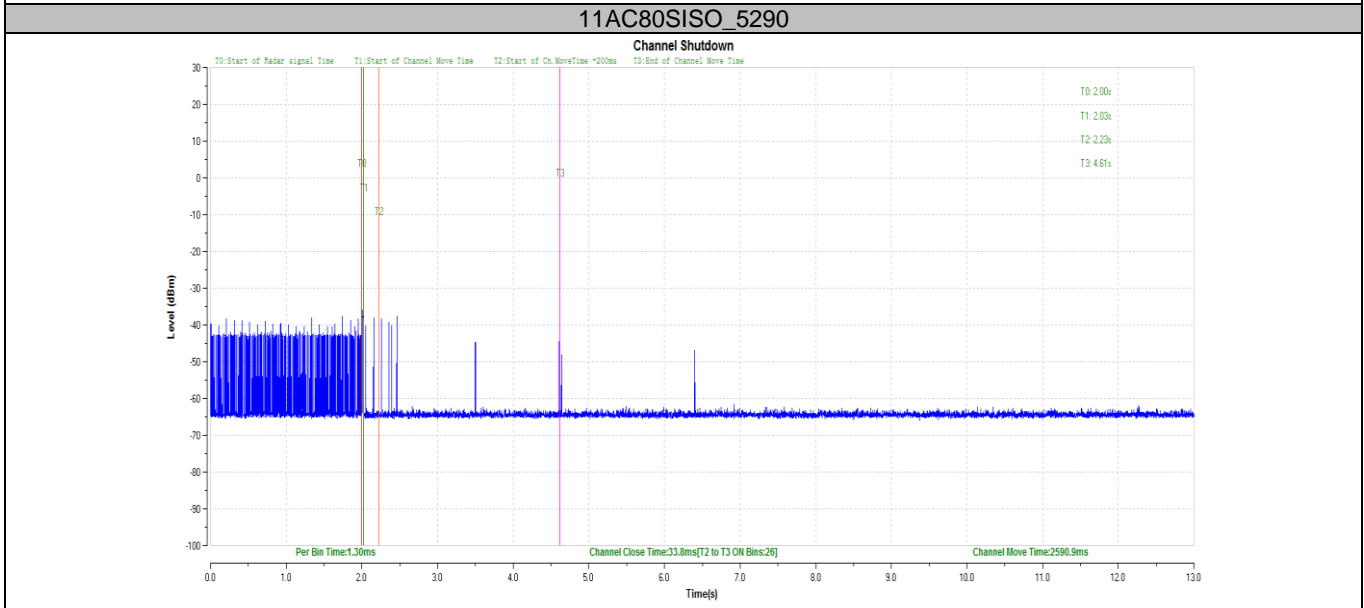
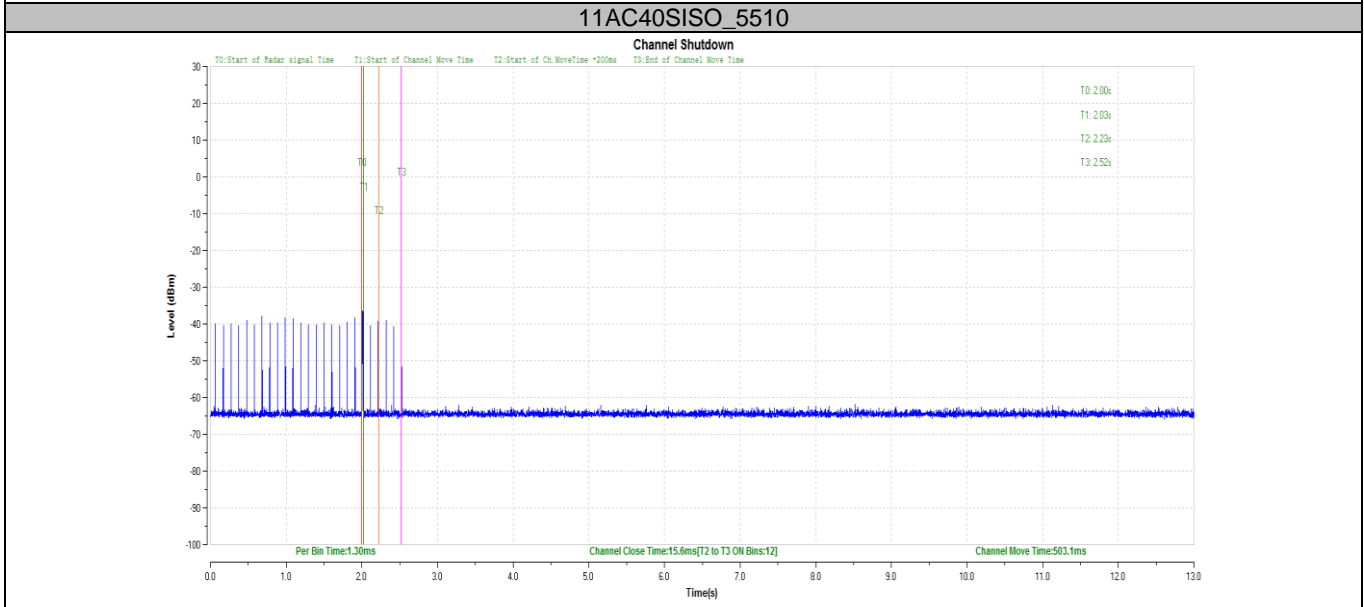
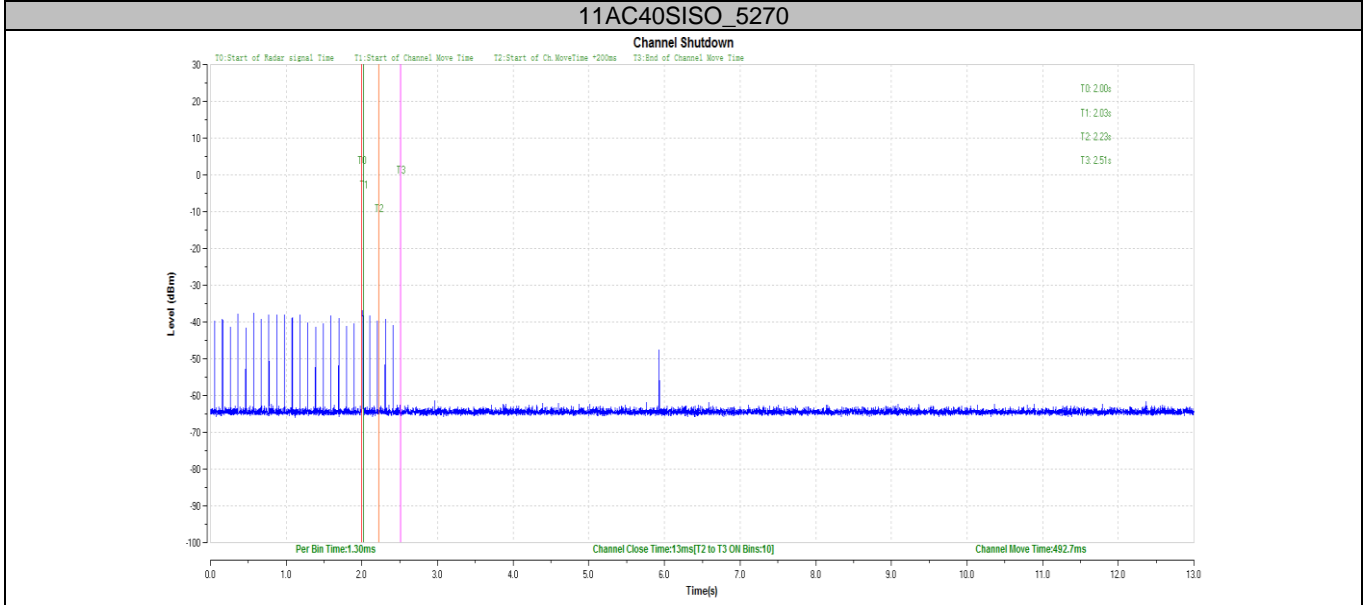

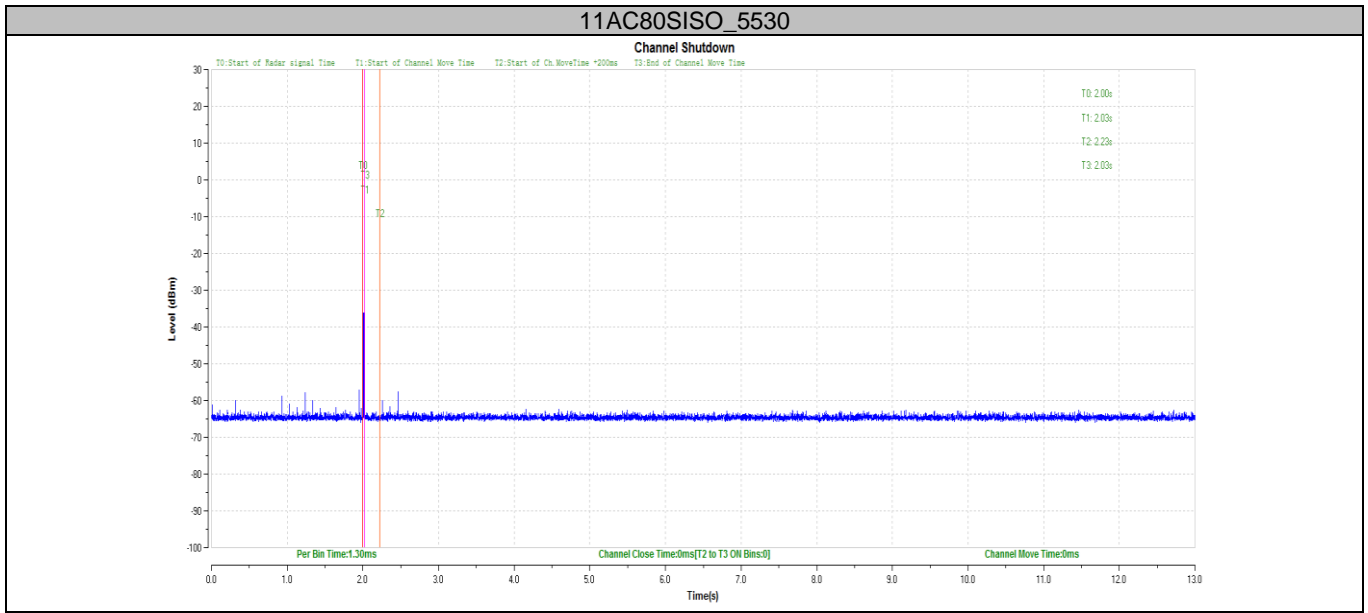

**Test Result: Pass**

## 10 Test Equipment List

### Conducted Emission Test

Description	Manufacturer	Model no.	Equipment ID	Serial no.	Cal interval (year)	Cal. due date
EMI Test Receiver	Rohde & Schwarz	ESR 3	68-4-74-19-002	102590	1	2024-5-19
LISN	Rohde & Schwarz	ENV216	68-4-87-19-001	102472	1	2024-5-20
Attenuator	Shanghai Huaxiang	TS2-26-3	68-4-81-16-003	080928189	1	2024-5-19
Test software	Rohde & Schwarz	EMC32	68-4-90-19-005-A01	Version 10.35.02	N/A	N/A
Shielding Room	TDK	CSR #2	68-4-90-19-005	----	3	2025-10-15

### Radiated Emission Test, SAC-3 #1

Description	Manufacturer	Model no.	Equipment ID	Serial no.	Cal interval (year)	Cal. due date
EMI Test Receiver	Rohde & Schwarz	ESR 7	68-4-74-19-001	102176	1	2024-5-20
Loop Antenna	Rohde & Schwarz	HFH2-Z2	68-4-80-14-006	100398	1	2024-8-7
Attenuator	Mini-circuits	UNAT-6+	68-4-81-21-001	15542	1	2024-5-19
3m Semi-anechoic chamber	TDK	SAC-3 #1	68-4-90-14-001	----	3	2024-5-28
Test software	Rohde & Schwarz	EMC32	68-4-90-14-001-A10	Version10.35.02	N/A	N/A

### Radiated Emission Test, SAC-3 #2

Description	Manufacturer	Model no.	Equipment ID	Serial no.	Cal interval (year)	Cal. due date
EMI Test Receiver	Rohde & Schwarz	ESR 26	68-4-74-14-002	101269	1	2024-5-20
Trilog Super Broadband Test Antenna	Schwarzbeck	VULB 9162	68-4-80-19-003	284	1	2024-3-5
Wave Guide Antenna	ETS	3117	68-4-80-19-001	00218954	1	2024-4-26
Pre-amplifier	Rohde & Schwarz	SCU 18F	68-4-29-19-001	100745	1	2024-5-19
Pre-amplifier	Rohde & Schwarz	SCU 18F	68-4-29-19-002	100746	1	2024-5-19
Sideband Horn Antenna	Q-PAR	QWH-SL-18-40-K-SG	68-4-80-14-008	12827	1	2024-7-11
Pre-amplifier	Rohde & Schwarz	SCU 40A	68-4-29-14-002	100432	1	2024-8-1
Attenuator	Mini-circuits	UNAT-6+	68-4-81-21-002	15542	1	2024-5-19
3m Semi-anechoic chamber	TDK	SAC-3 #2	68-4-90-19-006	----	2	2024-5-28
Test software	Rohde & Schwarz	EMC32	68-4-90-19-006-A01	Version10.35.02	N/A	N/A

### RF Conducted Test

Description	Manufacturer	Model no.	Equipment ID	Serial no.	Cal interval (year)	Cal. due date
Signal Analyzer	Rohde & Schwarz	FSV40	68-4-74-14-004	101030	1	2024-5-19
Signal Generator	Rohde & Schwarz	SMB100A	68-4-48-14-001	108272	1	2024-5-19
Vector Signal Generator	Rohde & Schwarz	SMBV100A	68-4-48-18-001	262825	1	2024-5-19
Test software	Tonscend	System for BT/WIFI	68-4-74-14-006-A13	Version 2.6.77.0518	N/A	N/A

## 11 System Measurement Uncertainty

For a 95% confidence level, the measurement expanded uncertainties for defined systems, in accordance with the recommendations of ISO 17025 were:

System Measurement Uncertainty	
Test Items	Extended Uncertainty
Uncertainty for Conducted Emission in new shielding room (68-4-90-19-005) 150kHz-30MHz (for test using AMN ENV216)	3.33dB
Uncertainty for Radiated Emission in 3m chamber (68-4-90-14-001) 9kHz-30MHz	4.70dB
Uncertainty for Radiated Emission in new 3m chamber (68-4-90-19-006) 30MHz-1000MHz	Horizontal: 4.59dB; Vertical: 4.75dB
Uncertainty for Radiated Emission in new 3m chamber (68-4-90-19-006) 1000MHz-18000MHz	Horizontal: 5.08dB; Vertical: 5.09dB
Uncertainty for Radiated Emission in new 3m chamber (68-4-90-19-006) above 18000MHz	Horizontal: 3.14dB; Vertical: 3.12dB
Uncertainty for Conducted RF test with TS 8997	RF Power Conducted: 1.31dB Frequency test involved: 0.6×10 <sup>-8</sup> or 1%

Measurement Uncertainty Decision Rule:

Determination of conformity with the specification limits is based on the decision rule according to IEC Guide 115:2021, clause 4.4.3 and 4.5.1.