

FCC - TEST REPORT

Report Number : **64.790.19.00122.02-2** Date of Issue: 2020-07-06

Model : **D04011**

Product Type : Smart Access Point Pro

Applicant : ABB Xiamen Smart Technology Co., Ltd.

Manufacturer : ABB Xiamen Smart Technology Co., Ltd.

Address : No.7 Fangshan South Road, Torch High Technology, Development Zone (Xiang An), Industrial Zone, 361000 Xiamen S.E.Z, Fujian Province, PEOPLE'S REPUBLIC OF CHINA

Test Result : **Positive** **Negative**



Total pages including Appendices : **50**

TÜV SÜD Certification and Testing (China) Co., Ltd. Guangzhou Branch is a subcontractor to TÜV SÜD Product Service GmbH according to the principles outlined in ISO 17025.

TÜV SÜD Certification and Testing (China) Co., Ltd. Guangzhou Branch reports apply only to the specific samples tested under stated test conditions. Construction of the actual test samples has been documented. It is the manufacturer's responsibility to assure that additional production units of this model are manufactured with identical electrical and mechanical components. The manufacturer/importer is responsible to the Competent Authorities in Europe for any modifications made to the production units which result in non-compliance to the relevant regulations. TÜV SÜD Certification and Testing (China) Co., Ltd. Guangzhou Branch shall have no liability for any deductions, inferences or generalizations drawn by the client or others from TÜV SÜD Certification and Testing (China) Co., Ltd. Guangzhou Branch issued reports.

This report is the confidential property of the client. As a mutual protection to our clients, the public and ourselves, extracts from the test report shall not be reproduced except in full without our written approval

1. Table of Contents

1.	TABLE OF CONTENTS.....	2
2.	DETAILS ABOUT THE TEST LABORATORY.....	3
3.	SUMMARY OF TEST STANDARDS	6
4.	SUMMARY OF TEST RESULTS.....	7
5.	GENERAL REMARKS.....	8
6.	TECHNICAL REQUIREMENT	9
8.1.	Conducted Emission	9
8.2.	Emission bandwidth	12
8.3.	Maximum conducted output power	13
8.4.	Maximum power spectral density.....	14
8.5.	Unwanted emissions	15
8.6.	Band Edge	43
8.7.	Frequencies Stability.....	44
8.8.	Dynamic Frequency Selection (DFS)	45
7.	TEST EQUIPMENT LIST	49
8.	SYSTEM MEASUREMENT UNCERTAINTY	50

2. Details about the Test Laboratory

Details about the Test Laboratory

Test Site 1

Company name: TÜV SÜD Certification and Testing (China) Co., Ltd. Shenzhen Branch
Building 12&13, Zhiheng Wisdomland Business Park,
Nantou Checkpoint Road 2, Nanshan District,
Shenzhen City, 518052,
P. R. China

FCC Registration Number: 514049

IC Registration No: 10320A

Telephone: 86 755 8828 6998
Fax: 86 755 8828 5299

DESCRIPTION	MODEL NO.(SHIELD)	MANUFACTURER
IP touch 7, LAN+WiFi, T-loop	H8236-	ABB
IP touch 10, LAN / WLAN	H8237-	ABB
IP touch 7, LAN+LAN, T-loop	H8236-*	ABB
IP touch 10, LAN / LAN	H8237-*	ABB
Outdoor station Bar pushbutton module	5138.SP.	ABB
Outdoor station Round pushbutton module	5138.RP.	ABB
Outdoor station keypad module	5138.K-	ABB
System controller	YSM01	ABB
POE Switch	TL-SL1218P	TP-LINK

Test software information:

Test Software Version	TI_Wireless_Tools_3.0.2.1		
Modulation	Setting TX Power	Mode	Packet Type
802.11a	17	Continuous	6 Mbps
802.11n HT20	17	Continuous	MCS0 Mbps
802.11n HT40	17	Continuous	MCS0 Mbps

Test channel:

Test Mode	Channel (MHz)		
802.11a, 802.11n HT20	5G WIFI-Band 1		
	CH36 (5180MHz)	CH40 (5200MHz)	CH46 (5240MHz)
	5G WIFI-Band 2		
	CH52 (5260MHz)	CH56 (5280MHz)	CH64 (5320MHz)
	5G WIFI-Band 3		
	CH100 (5500MHz)	CH116 (5580MHz)	CH140 (5700MHz)
	CH 142 (5710MHz)		
	5G WIFI-Band 4		
	CH149 (5745MHz),	CH157(5785MHz)	CH165 (5825MHz)

Test Mode	Channel (MHz)		
802.11n HT40	5G WIFI-Band 1		
	CH38(5190MHz)	CH46 (5230MHz)	
	5G WIFI-Band 2		
	CH54(5270MHz)	CH62(5310MHz)	
	5G WIFI-Band 3		
	CH102(5510MHz)	CH110(5550MHz)	CH134(5670MHz)
	CH 144 (5720MHz)		
	5G WIFI-Band 4		
	CH151(5755MHz)	CH159(5795MHz)	

RF Transmission Frequency: 5.180GHz~5.240GHz;
5.260GHz~5.320GHz;
5.500GHz~5.700GHz;
5.745GHz~5.825GHz

Modulation: 802.11a: BPSK, QPSK, 16QAM, 64QAM
802.11n: BPSK, QPSK, 16QAM, 64QAM

Antenna Type: Integral Antenna

Antenna Gain: 3dBi for 5GHz

Description of the EUT: The Equipment Under Test (EUT) is a Smart Access Point Pro supports 2.4GHz Bluetooth/Wi-Fi, 5GHz Wi-Fi functions.

3. Summary of Test Standards

Test Standards	
FCC Part 15 Subpart E, 10-1-2019 Edition	PART 15 - RADIO FREQUENCY DEVICES Subpart E - Unlicensed National Information Infrastructure Devices

Test Method:

KDB 789033 D02 General UNII Test Procedures New Rules v02r01

KDB 905462 D02 UNII DFS Compliance Procedures New Rules v02

ANSI C63.10-2013, American National Standard for Testing Unlicensed Wireless Devices

4. Summary of Test Results

Technical Requirements			
FCC Part 15 Subpart E,			
Test Condition	Test Result	Verdict	Test Site
15.207 Conducted Emission AC Power Port	See Page 9-13	Pass	Site 1
15.407(e) Emission bandwidth	Appendix A1-A3	Pass	Site 1
15.407(a)(i) Maximum Conducted Output Power	Appendix B	Pass	Site 1
15.407(a)(i) Maximum Power Spectral Density	Appendix C	Pass	Site 1
15.407(b)(1), 15.407(b)(2), 15.407(b)(3), 15.407(b)(4), 15.407(b)(6) 15.407(b)(7) 15.209 Unwanted Emissions (Conducted)	Appendix E	Pass	Site 1
15.407(b)(1), 15.407(b)(2), 15.407(b)(3), 15.407(b)(4), 15.407(b)(6) 15.407(b)(7) 15.209 Unwanted Emissions (Radiated)	See Page 17-26	Pass	Site 1
15.407(b)(i), 15.407(b)(5), 15.407(b)(7), 15.209 Band edge compliance	Appendix D	Pass	Site 1
15.407(g) Frequencies Stability	Appendix F	Pass	Site 1
15.407(h) Dynamic Frequency Selection (DFS). ^a	Appendix G	Pass	Site 1
15.203 Antenna Requirement ^b	See note ^b	Pass	Site 1

Remark: ^a The EUT is Clients Device without Radar Detection.

Remark: ^b The EUT uses an Integrated Antenna, the antenna gain: 4.2dBi, in accordance to 15.203, it is considered sufficiently to comply with the provisions of this section. According to §15.203, it is considered sufficiently to comply with the provisions of this section.

5. General Remarks

This submittal(s) (test report) is intended for FCC ID:2AEBL-D04011, complies with Section 15.207, 15.209, 15.205 of the FCC Part 15, Subpart C, Subpart E rules.

EUT supports Bluetooth function (BLE only): 2402-2480MHz; Wi-Fi functions, 2412MHz - 2462MHz for 2.4GHz Wi-Fi, 5180MHz – 5320MHz, 5500MHz – 5700MHz, 5745MHz – 5825MHz for 5GHz Wi-Fi.

This report is for the 5GHz Wi-Fi band 1/2/3/4.

SUMMARY:

All tests according to the regulations cited on page 5 were

■ - Performed

□ - **Not** Performed

The Equipment Under Test

■ - **Fulfills** the general approval requirements.

□ - **Does not** fulfill the general approval requirements.

Sample Received Date: 2018-07-10; 2020-01-09

Testing Date: 2018-07-13~2018-07-17; 2020-01-10~2020-03-13

TÜV SÜD Certification and Testing (China) Co., Ltd. Guangzhou Branch

Reviewed by:

Prepared by:

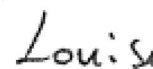

Tony Liu

Kevin Ouyang

Louise Liu

6. Technical Requirement

8.1. Conducted Emission

Test Method:

1. The EUT was placed on a table, which is 0.8m above ground plane.
2. The power line of the EUT is connected to the AC mains through an Artificial Mains Network (A.M.N.).
3. Maximum procedure was performed to ensure EUT compliance.
4. A EMI test receiver is used to test the emissions from both sides of AC line.

Test Setup:

The mains cable of the EUT (per AC/DC Adapter) must be connected to LISN. The LISN shall be placed 0.8 m from the boundary of EUT and bonded to a ground reference plane for LISN mounted on top of the ground reference plane. This distance is between the closest points of the LISN and the EUT. All other units of the EUT and associated equipment shall be at least 0.8m from the LISN.

Ground connections, where required for safety purposes, shall be connected to the reference ground point of the LISN and, where not otherwise provided or specified by the manufacturer, shall be of same length as the mains cable and run parallel to the mains connection at a separation distance of not more than 0.1 m.

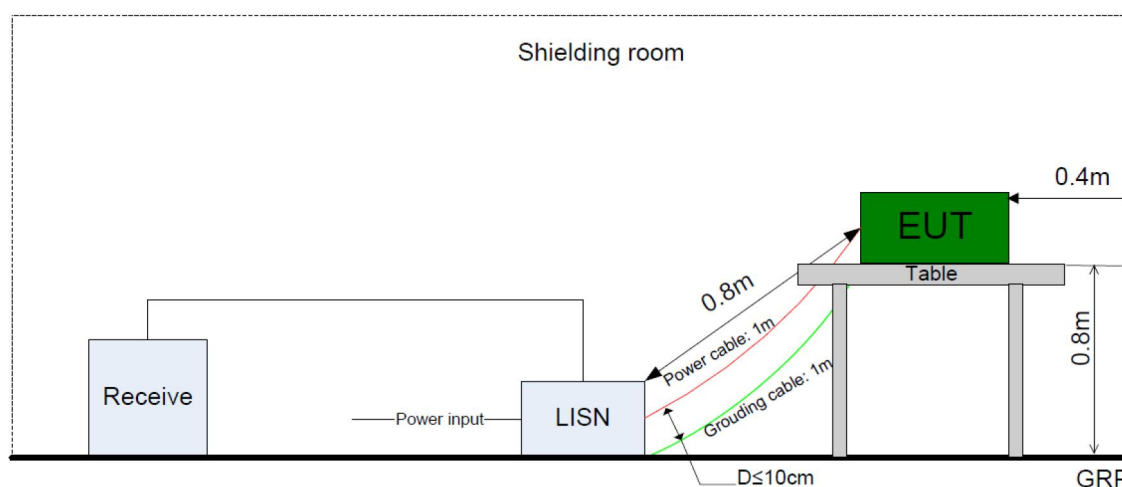

Limit:

Frequency MHz	QP Limit dB μ V	AV Limit dB μ V
0.150-0.500	66-56*	56-46*
0.500-5	56	46
5-30	60	50

Decreasing linear

Test Result: Pass

Test data:

Conducted Emission

Product Type : Smart Access Point Pro
 M/N : D04011
 Operating Condition : WiFi function on.
 Test Specification : L
 Comment : AC 120V/60Hz
 Test date : 2020-01-10

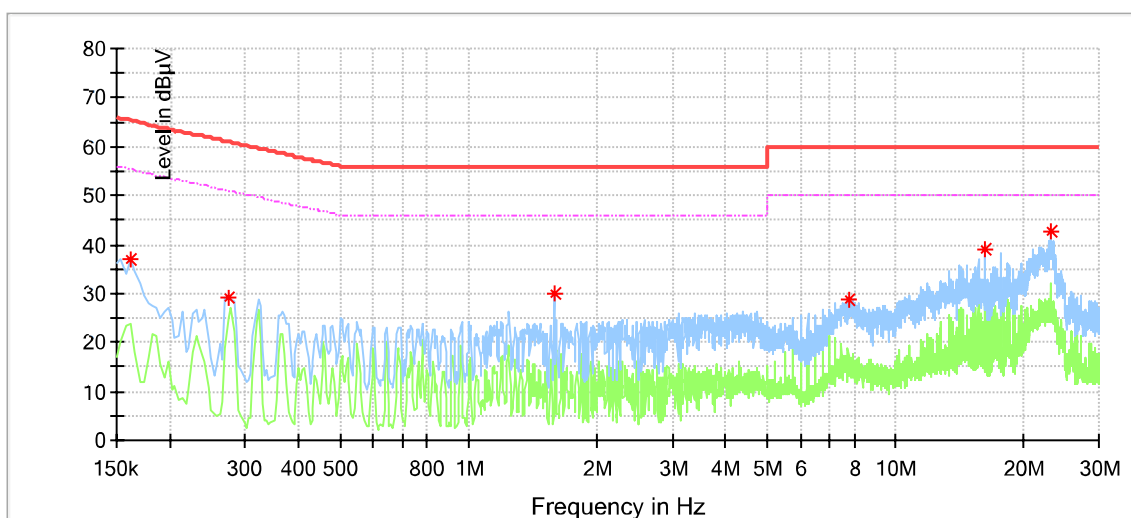

Frequency (MHz)	MaxPeak (dBµV)	Average (dBµV)	Limit (dBµV)	Margin (dB)	Line	Corr. (dB)
0.162000	36.78	---	65.36	28.58	L1	9.5
0.274000	29.06	---	61.00	31.93	L1	9.5
1.586000	29.97	---	56.00	26.03	L1	9.6
7.790000	28.82	---	60.00	31.18	L1	9.7
16.230000	39.16	---	60.00	20.84	L1	9.7
23.130000	42.73	---	60.00	17.27	L1	9.8

Conducted Emission

Product Type : Smart Access Point Pro
 M/N : D04011
 Operating Condition : WiFi function on.
 Test Specification : N
 Comment : AC 120V/60Hz
 Test date : 2020-01-10

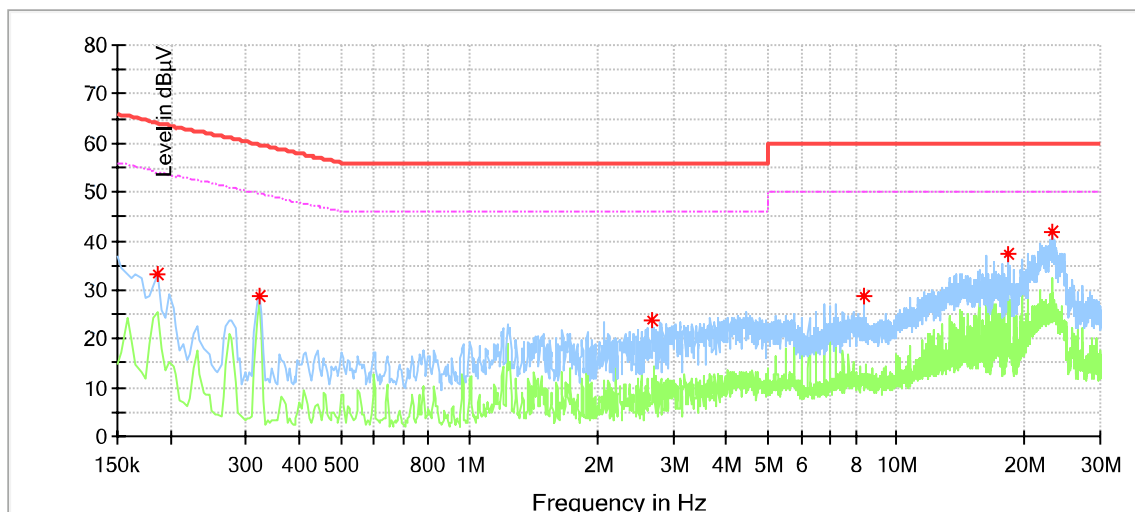

Frequency (MHz)	MaxPeak (dBµV)	Average (dBµV)	Limit (dBµV)	Margin (dB)	Line	Corr. (dB)
0.186000	33.22	---	64.21	31.00	N	9.5
0.322000	28.61	---	59.66	31.04	N	9.6
2.682000	23.66	---	56.00	32.34	N	9.6
8.370000	28.65	---	60.00	31.35	N	9.7
18.246000	37.29	---	60.00	22.71	N	9.8
23.070000	41.78	---	60.00	18.22	N	9.9

8.2. Emission bandwidth

The EUT was placed on 0.8m height table, the RF output of EUT was connected to the test receiver by RF cable. The path loss was compensated to the results for each measurement.

A. Test Method of 26dB Bandwidth

According to KDB789033 D02

- a) Set RBW = approximately 1% of the emission bandwidth.
- b) Set the VBW > RBW.
- c) Detector = Peak.
- d) Trace mode = max hold.
- e) Measure the maximum width of the emission that is 26 dB down from the maximum of the emission. Compare this with the RBW setting of the analyzer. Readjust RBW and repeat measurement as needed until the RBW/EBW ratio is approximately 1%.

Limit: No limit

B. Test Method of 6dB Bandwidth

According to KDB789033 D02

- a) Set RBW = 100KHz
- b) Set the video bandwidth (VBW) $\geq 3 \times$ RBW
- c) Detector = Peak.
- d) Trace mode = max hold.
- e) Sweep = auto couple.
- f) Allow the trace to stabilize.
- g) Measure the maximum width of the emission that is constrained by the frequencies associated with the two outermost amplitude points (upper and lower frequencies) that are attenuated by 6 dB relative to the maximum level measured in the fundamental emission.

Limit: ≥ 500 KHz

C. Test Method of 99% Bandwidth

According to KDB789033 D02

- a) Set center frequency to the nominal EUT channel center frequency
- b) Set span = 1.5 times to 5.0 times the OBW.
- c) Set RBW = 1 % to 5 % of the OBW
- d) Set VBW $\geq 3 \cdot$ RBW
- e) Video averaging is not permitted. Where practical, a sample detection and single sweep mode shall be used. Otherwise, peak detection and max hold mode (until the trace stabilizes) shall be used.
- f) Use the 99 % power bandwidth function of the instrument (if available).
- g) If the instrument does not have a 99 % power bandwidth function, the trace data points are recovered and directly summed in power units. The recovered amplitude data points, beginning at the lowest frequency, are placed in a running sum until 0.5 % of the total is reached; that frequency is recorded as the lower frequency. The process is repeated until 99.5 % of the total is reached; that frequency is recorded as the upper frequency. The 99% occupied bandwidth is the difference between these two frequencies.

Limit: No limit

Test Result: Pass

Test data see annex.

8.3. Maximum conducted output power

Test Method

According to KDB789033 D02(E) Method 3, the EUT was placed on 0.8m height table, the RF output of EUT was connected to the test receiver by RF cable. The path loss was compensated to the results for each measurement.

Limits:

For client devices in the 5.15-5.25 GHz band, the maximum conducted output power over the frequency band of operation shall not exceed 250 mW provided the maximum antenna gain does not exceed 6 dBi.

For the 5.25-5.35 GHz and 5.47-5.725 GHz bands, the maximum conducted output power over the frequency bands of operation shall not exceed the lesser of 250 mW or $11 \text{ dBm} + 10 \log B$, where B is the 26dB emission bandwidth in megahertz.

For the band 5.725-5.85 GHz, the maximum conducted output power over the frequency band of operation shall not exceed 1 W.

Note:

Maximum Conducted Output Power=Conducted Output Power + Correction Factor

Test Result: Pass

Test data see annex.

8.4. Maximum power spectral density

Test Method

According to KDB789033 D02

The EUT was placed on 0.8m height table, the RF output of EUT was connected to the test receiver by RF cable. The path loss was compensated to the results for each measurement.

For devices operating in the bands 5.15-5.25 GHz, 5.25-5.35 GHz, and 5.47-5.725 GHz, the above procedures make use of 1 MHz RBW to satisfy directly the 1 MHz reference bandwidth specified in § 15.407(a)(5). For devices operating in the band 5.725-5.85 GHz, the rules specify a measurement bandwidth of 500 kHz. Many spectrum analyzers do not have 500 kHz RBW, thus a narrower RBW may need to be used. The rules permit the use of a RBWs less than 1 MHz, or bandwidth” to show the total power over the specified measurement bandwidth (i.e., 1 MHz, or 500 kHz). If measurements are performed using a reduced resolution bandwidth (< 1 MHz, or < 500 kHz) and integrated over 1 MHz, or 500 KHz bandwidth, the following adjustments to the procedures apply:

- a) Set $RBW \geq 1/T$, where T is defined in section II.B.I.a).
- b) Set $VBW \geq 3 RBW$.
- c) If measurement bandwidth of Maximum PSD is specified in 500 kHz, add $10\log(500\text{kHz}/RBW)$ to the measured result, whereas RBW (< 500 KHz) is the reduced resolution bandwidth of the spectrum analyzer set during measurement.
- d) If measurement bandwidth of Maximum PSD is specified in 1 MHz, add $10\log(1\text{MHz}/RBW)$ to the measured result, whereas RBW (< 1 MHz) is the reduced resolution bandwidth of spectrum analyzer set during measurement.
- e) Care must be taken to ensure that the measurements are performed during a period of continuous transmission or are corrected upward for duty cycle.

Note: As a practical matter, it is recommended to use reduced RBW of 100 KHz for the sections 5.c) and 5.d) above, since RBW=100 KHz is available on nearly all spectrum analyzers.

Limit:

The maximum power spectral density shall not exceed 11dBm for the 5.15-5.25GHz, 5.25-5.35GHz, 5.47-5.725 GHz Band and 30dBm for the 5.8GHz Band in any 1 megahertz band.

Test Result: Pass

Test data see annex.

8.5. Unwanted emissions

Transmitting spurious emission test result as below (Radiated Mode):

Test Method

1. The EUT was placed on a turn table which is 1.5m above ground plane for above 1GHz and 0.8m above ground for below 1GHz at 3meter chamber room for test. The table was rotated 360 degrees to determine the position of the highest radiation.
2. The EUT was set 3 meters away from the interference – receiving antenna, which was mounted on the top of a variable – height antenna tower.
3. The height of antenna is varied from one meter to four meters above the ground to determine the maximum value of the field strength. Both horizontal and vertical polarizations of the antenna are set to make the measurement.
4. For each suspected emission, the EUT was arranged to its worst case and then the antenna was tuned to heights from 1 meter to 4 meters and the rotatable table was turned
5. Use the following spectrum analyzer settings According to C63.10:

For Above 1GHz

Span = wide enough to capture the peak level of the in-band emission and all spurious
RBW = 1MHz, VBW \geq RBW for peak measurement and VBW = 10Hz for average measurement, Sweep = auto, Detector function = peak, Trace = max hold.

For Below 1GHz

Use the following spectrum analyzer settings:

Span = wide enough to capture the peak level of the in-band emission and all spurious
RBW = 100 KHz, VBW \geq RBW for peak measurement, Sweep = auto, Detector function = peak, Trace = max hold.

Note:

1. The resolution bandwidth and video bandwidth of test receiver/spectrum analyzer is 120 KHz for Quasi-peak detection (QP) at frequency below 1GHz.
2. The resolution bandwidth of test receiver/spectrum analyzer is 1MHz and the video bandwidth is 3MHz for peak detection (PK) at frequency above 1GHz.
3. The resolution bandwidth of test receiver/spectrum analyzer is 1MHz and the video bandwidth is 3MHz for RMS Average ((duty cycle < 98%) for Average detection (AV) at frequency above 1GHz, then the measurement results was added to a correction factor (20log(1/duty cycle)).
4. The resolution bandwidth of test receiver/spectrum analyzer is 1MHz and the video bandwidth is 10Hz (duty cycle > 98%) for Average detection (AV) at frequency above 1GHz.

Limit:

According to part 15.407(b), Unwanted emissions below 1 GHz must comply with the general field strength limits set forth in §15.209. The provisions of §15.205 apply to intentional radiators operating under this section.

§ 15.209

Frequency MHz	Field Strength uV/m	Field Strength dBµV/m	Detector
30-88	100	40	QP
88-216	150	43.5	QP
216-960	200	46	QP
960-1000	500	54	QP
Above 1000	500	54	AV
Above 1000	5000	74	PK

According to part 15.407b (1) (2) (3) (4)

For transmitters operating in the 5.15-5.25 GHz band: All emissions outside of the 5.15-5.35 GHz band shall not exceed an e.i.r.p. of -27 dBm/MHz.

For transmitters operating in the 5.25-5.35 GHz band: All emissions outside of the 5.15-5.35 GHz band shall not exceed an e.i.r.p. of -27 dBm/MHz.

For transmitters operating in the 5.47-5.725 GHz band: All emissions outside of the 5.47-5.725 GHz band shall not exceed an e.i.r.p. of -27 dBm/MHz.

For transmitters operating in the 5.725-5.85 GHz band: All emissions within the frequency range from the band edge to 10 MHz above or below the band edge shall not exceed an e.i.r.p. of -17 dBm/MHz; for frequencies 10 MHz or greater above or below the band edge, emissions shall not exceed an e.i.r.p. of -27 dBm/MHz.

Note: According to KDB 789033 D02 (G): $E[\text{dB}\mu\text{V}/\text{m}] = \text{EIRP}[\text{dBm}] + 95.2$, for $d = 3$ meters.

According to C63.10, if the peak (or quasi-peak) measured value complies with the average limit, it is unnecessary to perform an average measurement, so AV emission value did not show in below table if the peak value complies with average limit. The only worse case test result is listed in the report.

For model D04011:
Below 1GHz

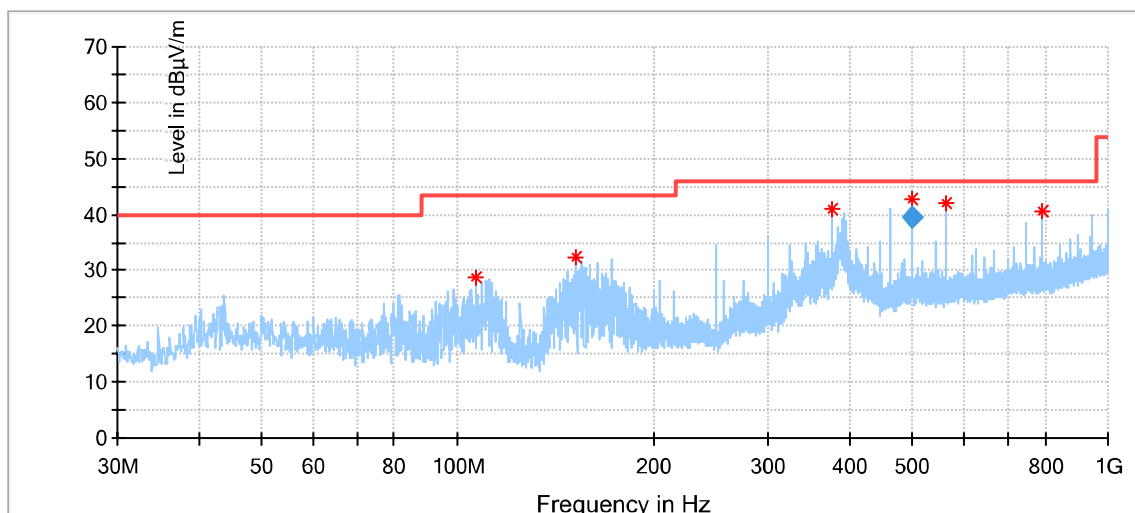

Frequency (MHz)	QuasiPeak (dBµV/m)	Limit (dBµV/m)	Margin (dB)	Height (cm)	Pol	Azimuth (deg)	Corr. (dB/m)
106.683889	28.62	43.50	14.88	200.0	H	234.0	12.0
151.519444	32.20	43.50	11.30	200.0	H	251.0	8.4
374.996667	41.10	46.00	4.90	100.0	H	259.0	16.2
499.999422	42.57	46.00	3.43	167.0	H	6.0	18.8
563.176667	41.95	46.00	4.05	200.0	H	260.0	20.1
791.988889	40.64	46.00	5.36	100.0	H	6.0	23.7

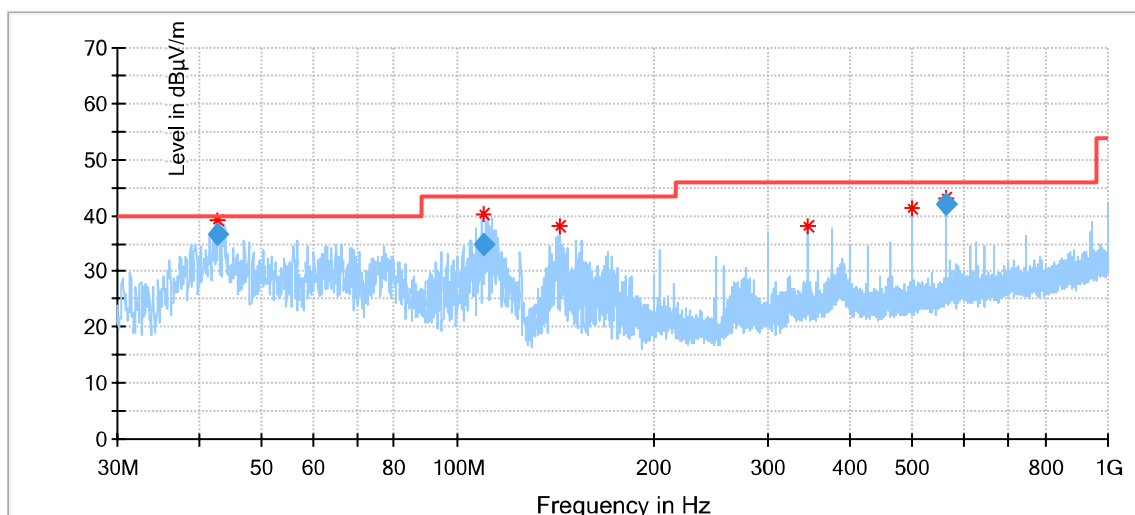

Frequency (MHz)	QuasiPeak (dBµV/m)	Limit (dBµV/m)	Margin (dB)	Height (cm)	Pol	Azimuth (deg)	Corr. (dB/m)
42.780733	36.56	40.00	3.44	104.0	V	2.0	13.7
109.385556	34.93	43.50	8.57	100.0	V	65.0	11.9
563.169867	42.06	46.00	3.94	105.0	V	203.0	20.1

Above 1GHz

Remark: All emissions above the limit are fundamental frequencies.

802.11a Modulation 5180MHz Test Result

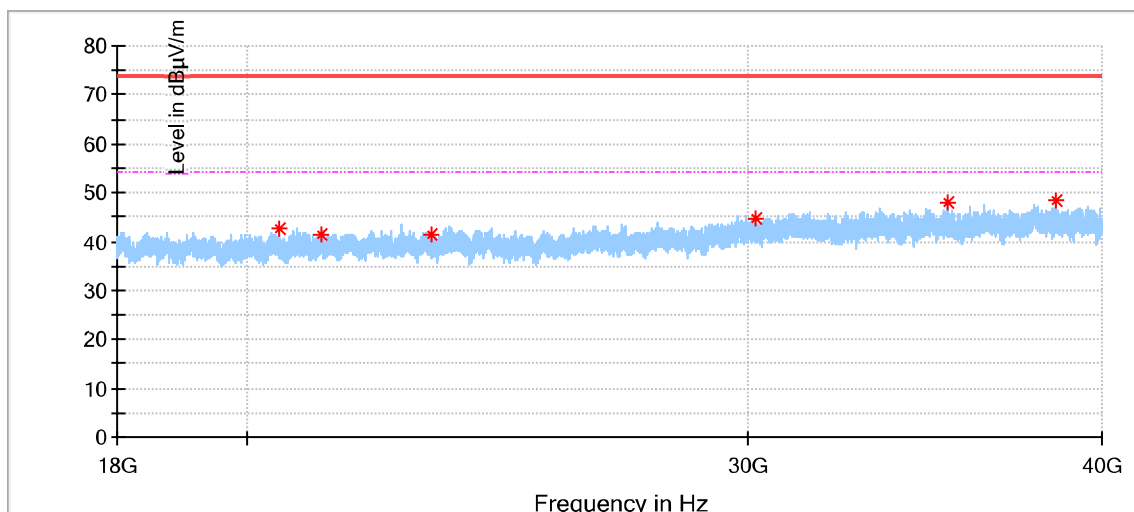
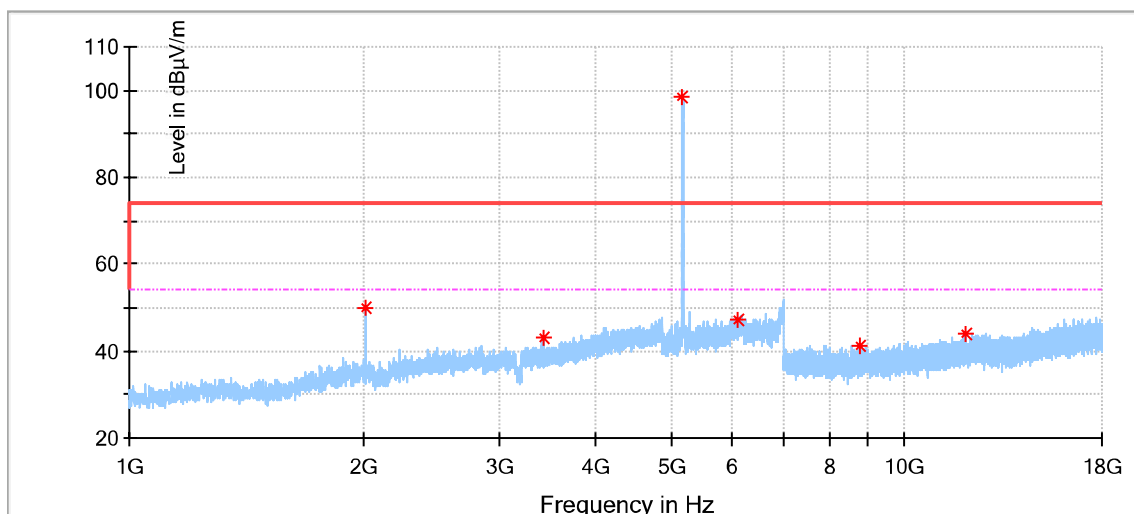

Frequency (MHz)	MaxPeak (dBµV/m)	Limit (dBµV/m)	Margin (dB)	Height (cm)	Pol	Azimuth (deg)	Corr. (dB/m)
2017.000000	49.93	74	24.07	150	H	53.0	-5.8
3429.000000	42.98	74	31.02	150	H	160.0	-2.2
6092.000000	47.00	74	27.00	150	H	196.0	4.4
8760.000000	41.13	74	32.87	150	H	11.0	6.7
12011.500000	44.21	74	29.79	150	H	172.0	9.8
20523.812500	42.47	74	31.53	100	H	283.0	-0.8
21230.562500	41.39	74	32.61	100	H	21.0	-0.3
23212.625000	41.30	74	32.70	100	H	81.0	0.6
30217.562500	44.90	74	29.10	100	H	66.0	2.5
35301.625000	47.97	74	26.03	100	H	240.0	4.4
38517.750000	48.60	74	25.40	100	H	0.0	5.9

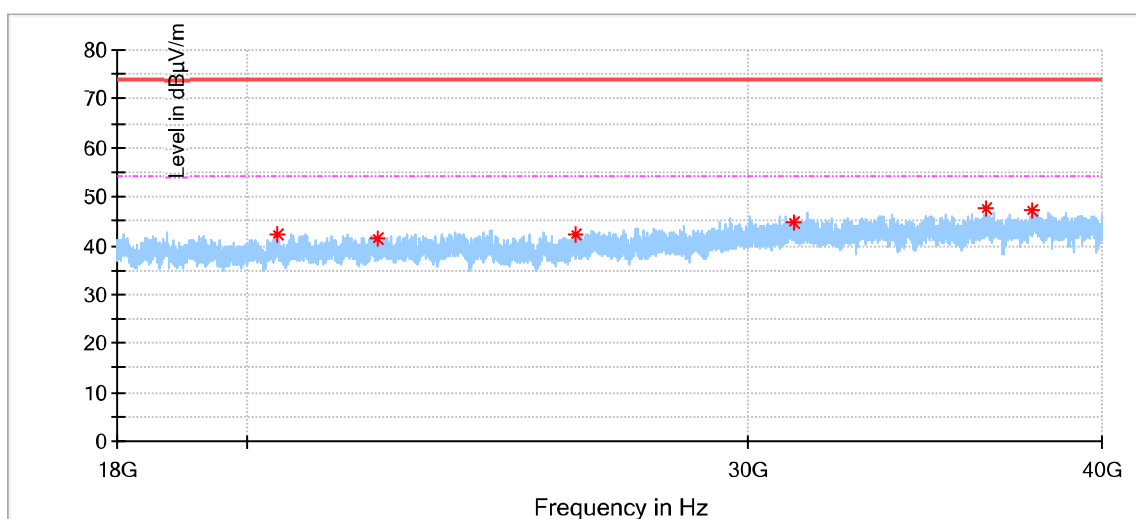
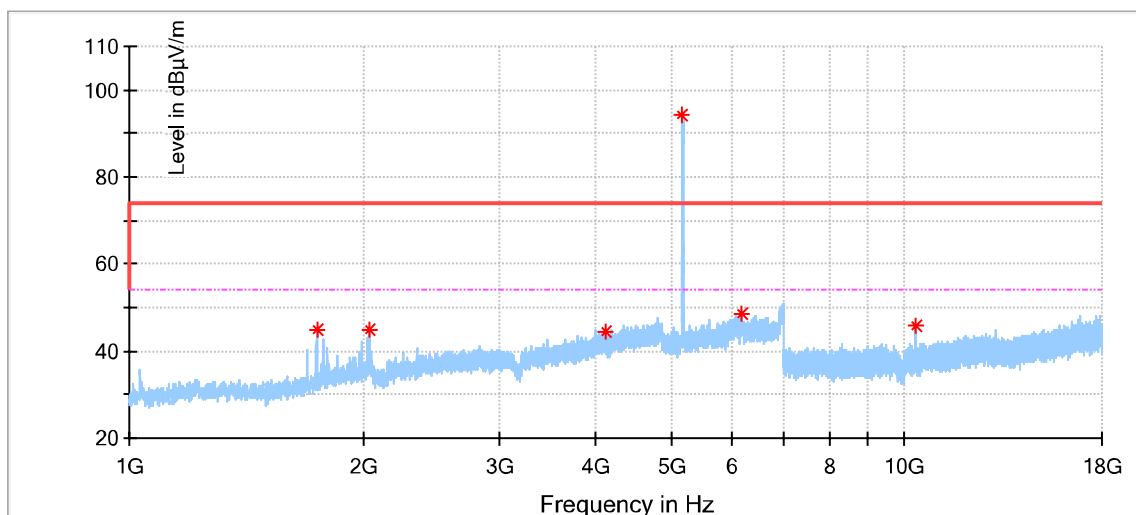

Frequency (MHz)	MaxPeak (dBµV/m)	Limit (dBµV/m)	Margin (dB)	Height (cm)	Pol	Azimuth (deg)	Corr. (dB/m)
1744.500000	45.13	74	28.87	150	V	187.0	-7.7
2039.500000	44.70	74	29.30	150	V	204.0	-5.7
4109.000000	44.64	74	29.36	150	V	196.0	0.8
6165.500000	48.60	74	25.40	150	V	298.0	4.7
10363.500000	45.88	74	28.12	150	V	89.0	8.2
20490.125000	42.07	74	31.93	100	V	155.0	-0.8
22227.437500	41.49	74	32.51	100	V	43.0	0.4
26082.937500	42.33	74	31.67	100	V	295.0	1.4
31129.875000	44.85	74	29.15	100	V	279.0	2.5
36417.437500	47.72	74	26.28	100	V	28.0	5.1
37777.312500	47.04	74	26.96	100	V	295.0	5.8

802.11a Modulation 5200MHz Test Result

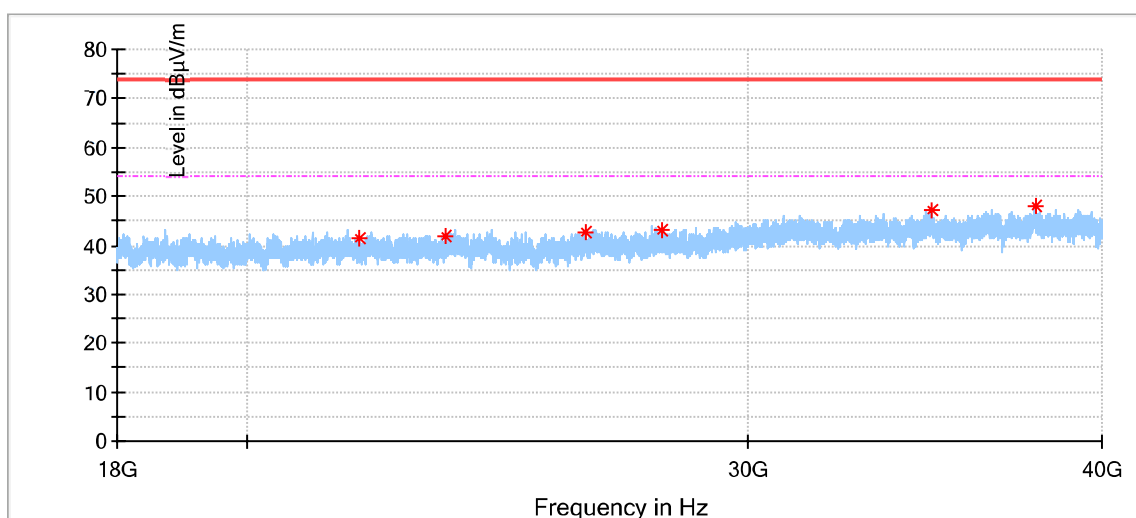
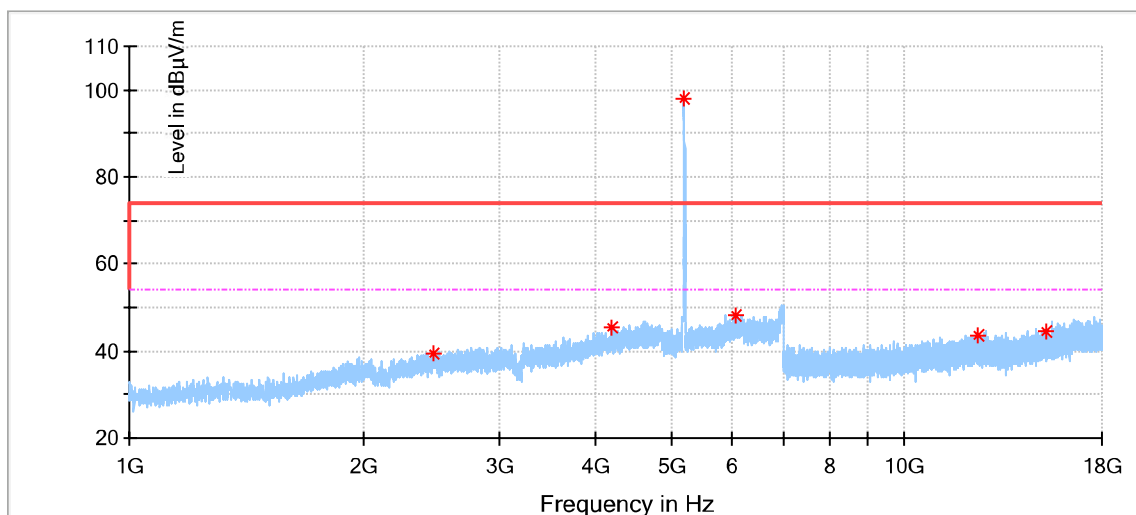

Frequency (MHz)	MaxPeak (dBµV/m)	Limit (dBµV/m)	Margin (dB)	Height (cm)	Pol	Azimuth (deg)	Corr. (dB/m)
2467.000000	39.57	74	34.43	150	H	319.0	-4.3
4201.000000	45.16	74	28.84	150	H	351.0	1.2
6078.000000	48.19	74	25.81	150	H	221.0	4.5
12434.000000	43.39	74	30.61	150	H	247.0	10.1
15258.500000	44.63	74	29.37	150	H	356.0	12.8
21909.812500	41.57	74	32.43	100	H	73.0	0.0
23480.062500	41.89	74	32.11	100	H	354.0	0.8
26294.687500	42.73	74	31.27	100	H	1.0	1.9
27968.062500	43.24	74	30.76	100	H	230.0	2.0
34819.687500	47.23	74	26.77	100	H	158.0	4.1
37918.937500	48.00	74	26.00	100	H	292.0	6.0

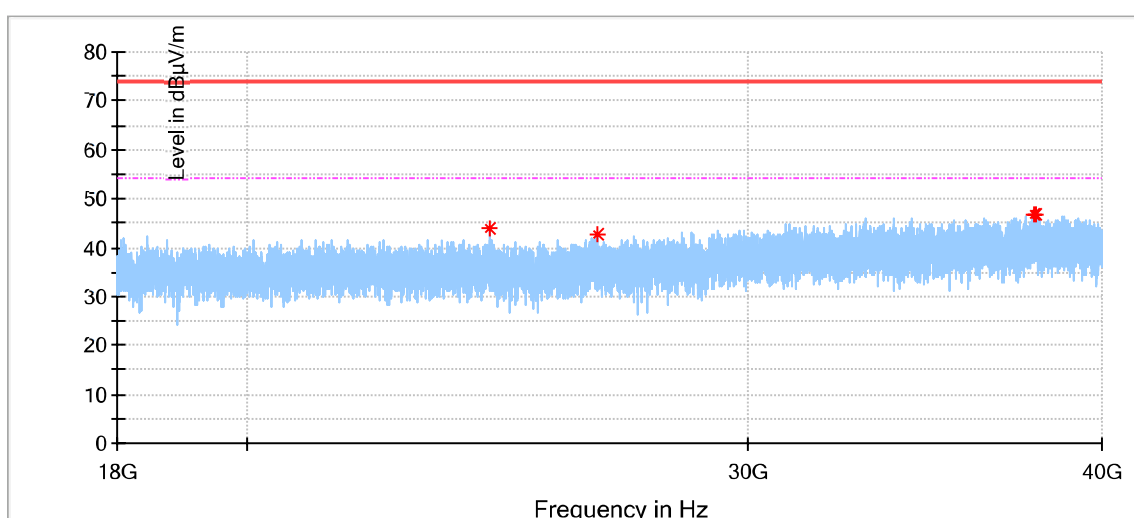
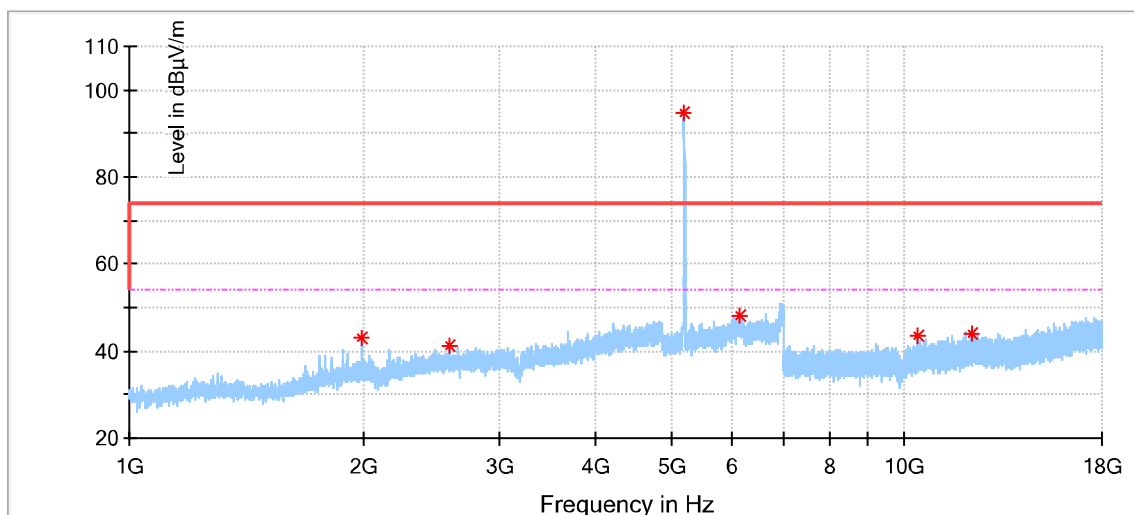

Frequency (MHz)	MaxPeak (dBµV/m)	Limit (dBµV/m)	Margin (dB)	Height (cm)	Pol	Azimuth (deg)	Corr. (dB/m)
1993.500000	43.17	74	30.83	150	V	192.0	-6.0
2594.500000	41.33	74	32.67	150	V	356.0	-4.2
6146.000000	48.34	74	25.66	150	V	0.0	4.4
10400.500000	43.50	74	30.50	150	V	93.0	8.2
12217.500000	43.95	74	30.05	150	V	251.0	9.6
24344.250000	43.88	74	30.12	100	V	0.0	1.1
26590.312500	42.86	74	31.14	100	V	0.0	2.5
37877.000000	46.95	74	27.05	100	V	0.0	5.9
37940.937500	46.88	74	27.12	100	V	0.0	6.0

802.11a Modulation 5240MHz Test Result

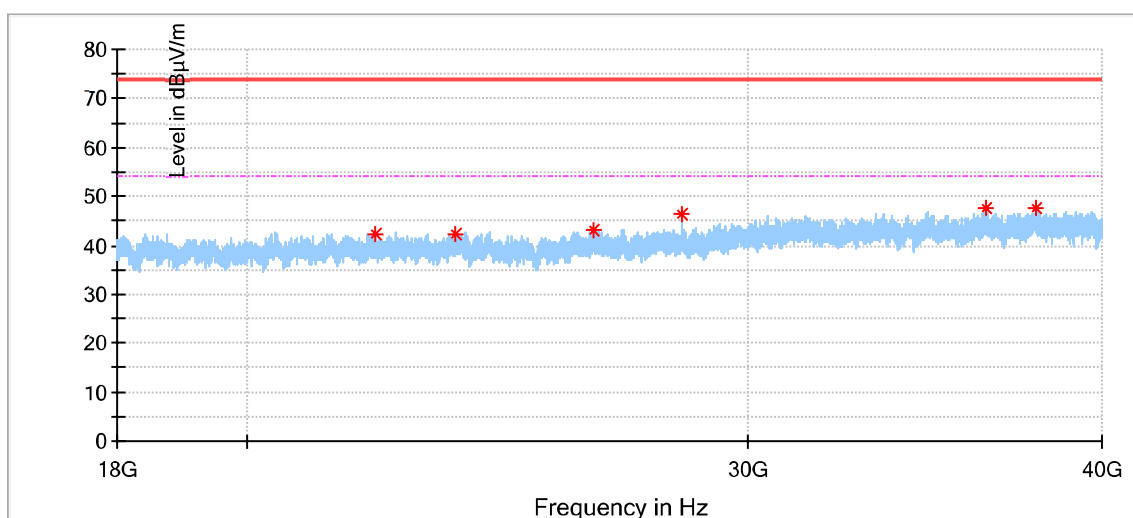
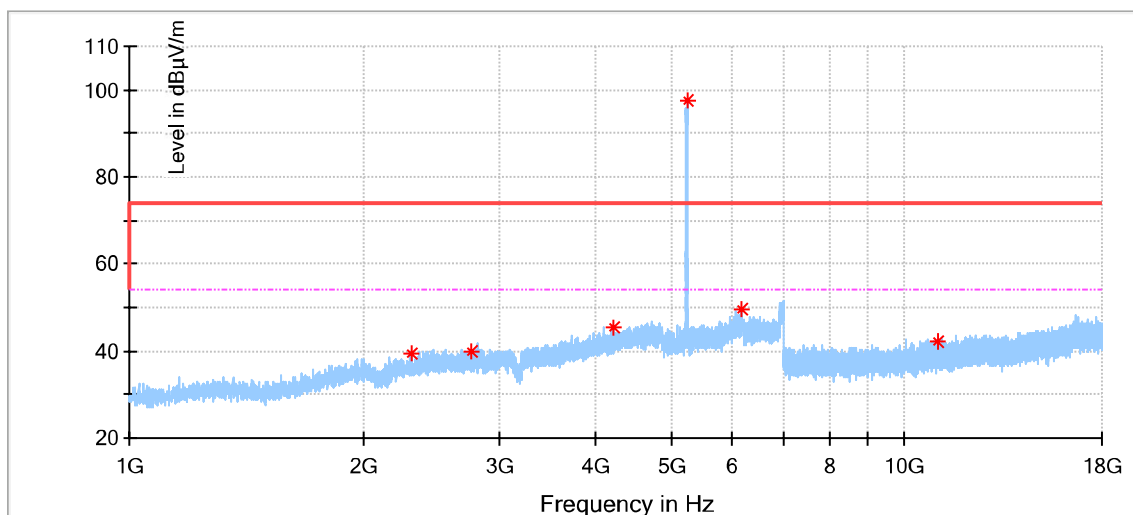

Frequency (MHz)	MaxPeak (dBµV/m)	Limit (dBµV/m)	Margin (dB)	Height (cm)	Pol	Azimuth (deg)	Corr. (dB/m)
2306.500000	39.56	74	34.44	150	H	258.0	-5.1
2757.500000	40.06	74	33.94	150	H	341.0	-4.0
4219.000000	45.35	74	28.65	150	H	196.0	1.1
6187.000000	49.45	74	24.55	150	H	33.0	5.2
11055.000000	42.27	74	31.73	150	H	15.0	8.2
22181.375000	42.43	74	31.57	100	H	6.0	0.4
23674.625000	42.26	74	31.74	100	H	190.0	1.0
26497.500000	43.06	74	30.94	100	H	6.0	2.6
28467.875000	46.20	74	27.80	100	H	235.0	2.1
36398.875000	47.66	74	26.34	100	H	38.0	5.1
37921.687500	47.66	74	26.34	100	H	327.0	6.0

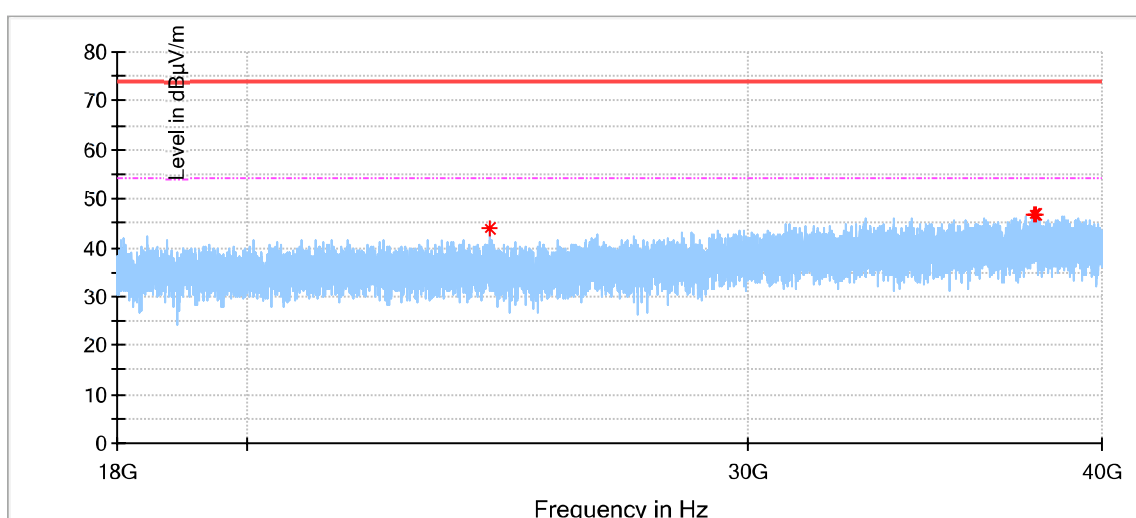
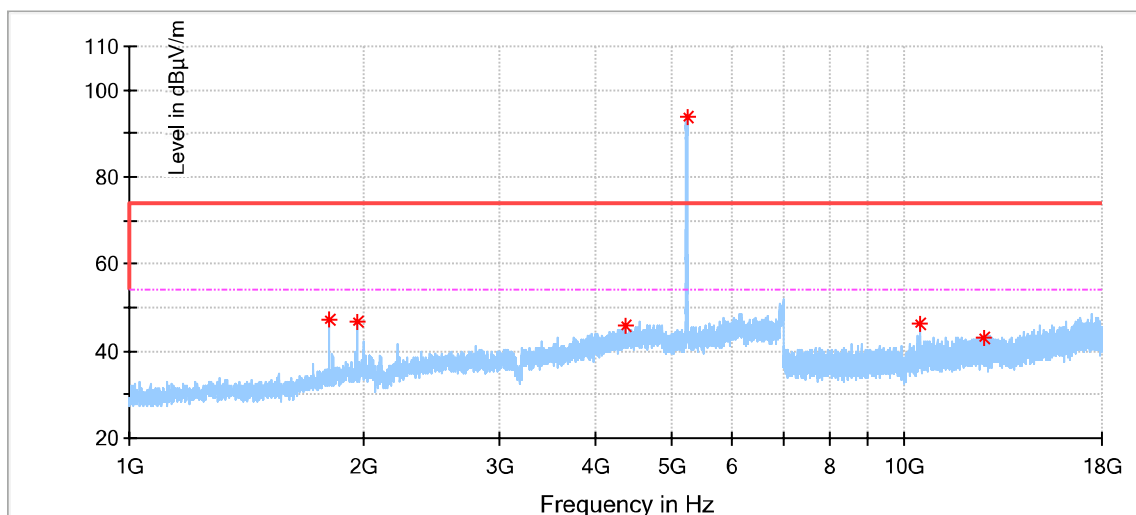

Frequency (MHz)	MaxPeak (dBµV/m)	Limit (dBµV/m)	Margin (dB)	Height (cm)	Pol	Azimuth (deg)	Corr. (dB/m)
1811.000000	47.25	74	26.75	150	V	194.0	-7.0
1970.500000	46.96	74	27.04	150	V	212.0	-6.1
4378.000000	46.06	74	27.94	150	V	51.0	1.8
10480.000000	46.34	74	27.66	150	V	93.0	8.1
12692.000000	43.00	74	31.00	150	V	66.0	10.0
24344.250000	43.88	74	30.12	100	V	0.0	1.1
37877.000000	46.95	74	27.05	100	V	0.0	5.9
37940.937500	46.88	74	27.12	100	V	0.0	6.0

802.11a Modulation 5260MHz Test Result

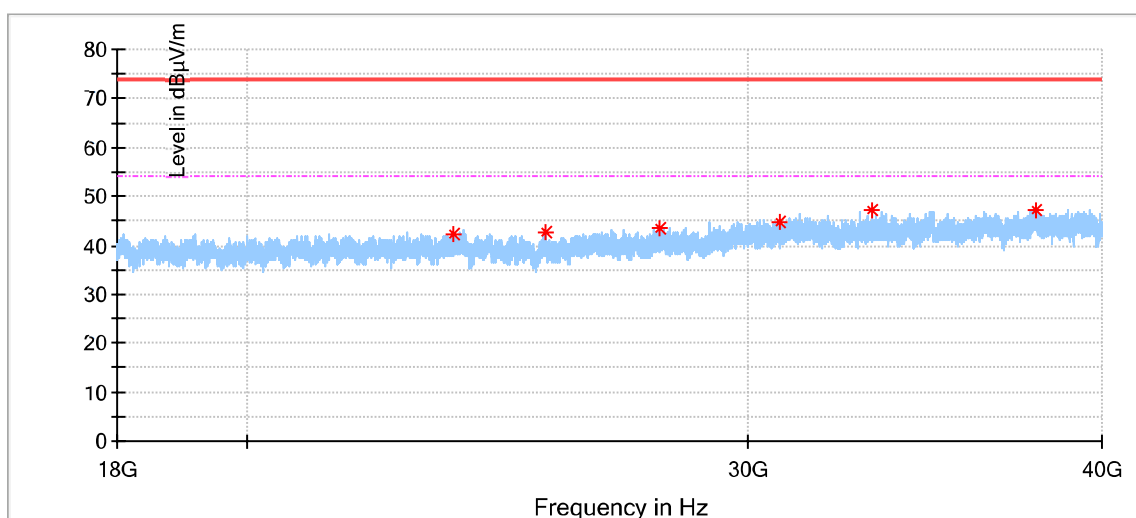
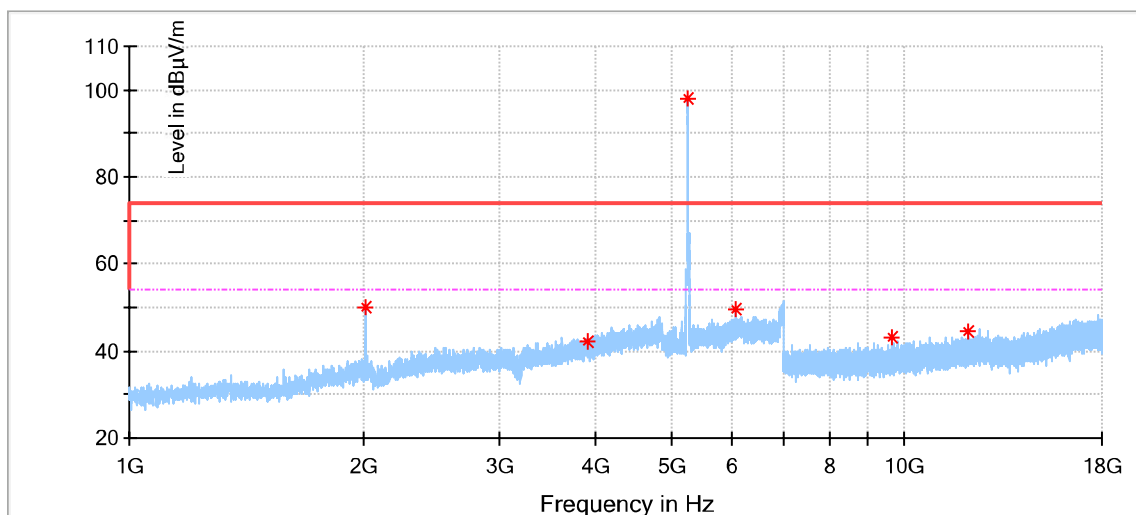

Frequency (MHz)	MaxPeak (dBµV/m)	Limit (dBµV/m)	Margin (dB)	Height (cm)	Pol	Azimuth (deg)	Corr. (dB/m)
2014.500000	49.87	74	24.13	150	H	123.0	-5.9
3910.000000	42.05	74	31.95	150	H	123.0	0.1
6071.500000	49.45	74	24.55	150	H	158.0	4.6
9653.500000	43.17	74	30.83	150	H	331.0	7.6
12088.500000	44.50	74	29.50	150	H	331.0	10.0
23628.562500	42.12	74	31.88	100	H	87.0	1.0
25467.625000	42.68	74	31.32	100	H	5.0	1.1
27956.375000	43.52	74	30.48	100	H	74.0	2.0
30788.875000	44.72	74	29.28	100	H	0.0	2.4
33173.812500	47.19	74	26.81	100	H	308.0	3.3
37927.187500	47.23	74	26.77	100	H	0.0	6.0

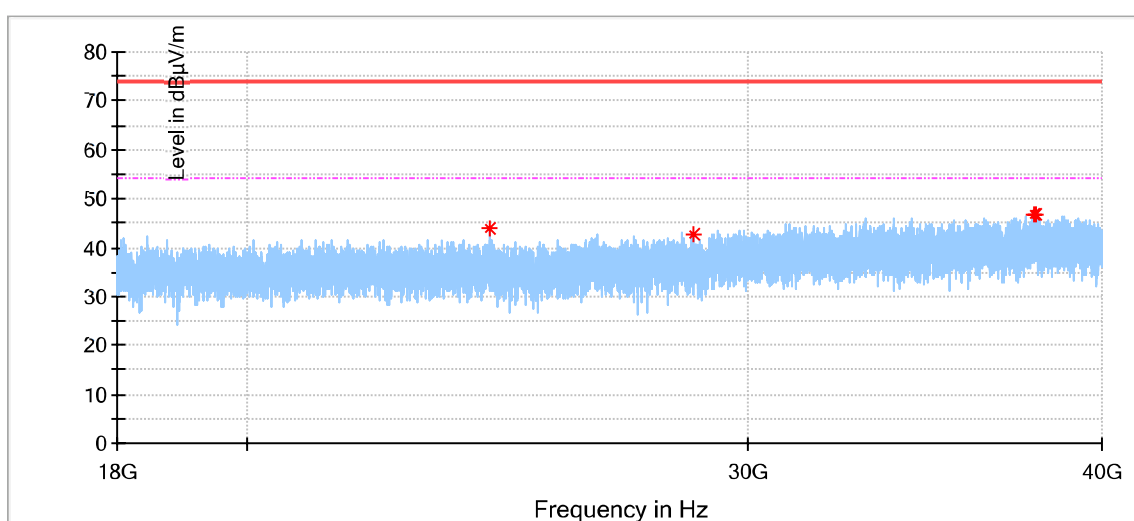
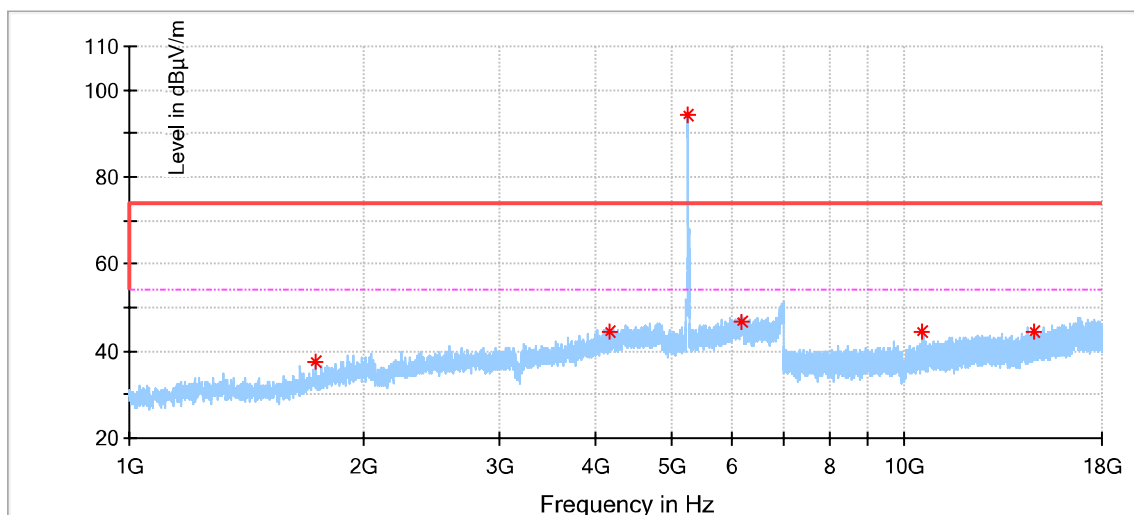

Frequency (MHz)	MaxPeak (dBµV/m)	Limit (dBµV/m)	Margin (dB)	Height (cm)	Pol	Azimuth (deg)	Corr. (dB/m)
1742.500000	37.60	74	36.40	150	V	194.0	-7.6
4176.000000	44.52	74	29.48	150	V	158.0	1.0
6154.000000	46.95	74	27.05	150	V	42.0	4.5
10520.000000	44.36	74	29.64	150	V	89.0	8.1
14668.000000	44.45	74	29.55	150	V	142.0	11.4
24344.250000	43.88	74	30.12	100	V	0.0	1.1
28747.000000	42.68	74	31.32	100	V	0.0	2.2
37877.000000	46.95	74	27.05	100	V	0.0	5.9
37940.937500	46.88	74	27.12	100	V	0.0	6.0

802.11a Modulation 5280MHz Test Result

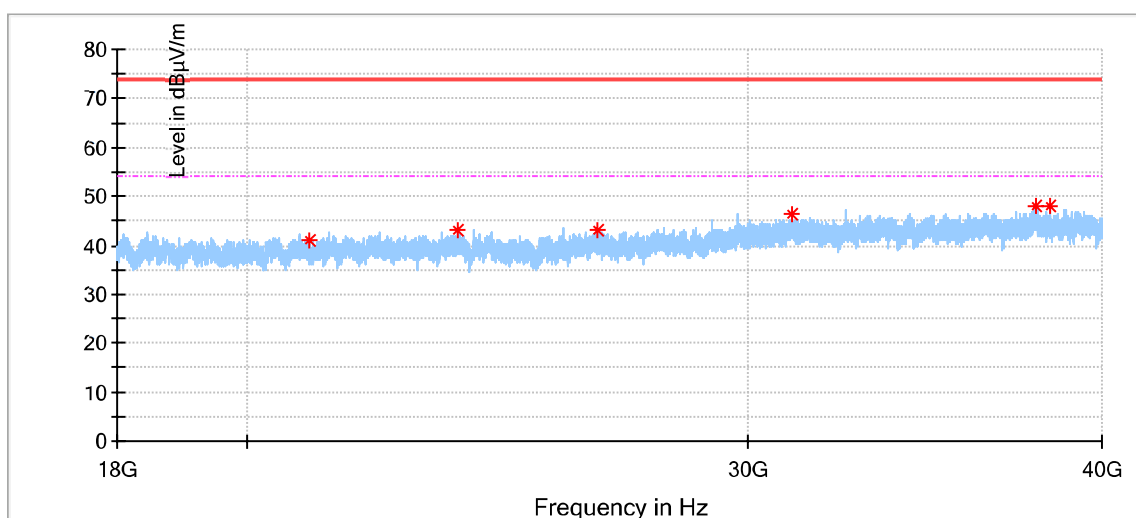
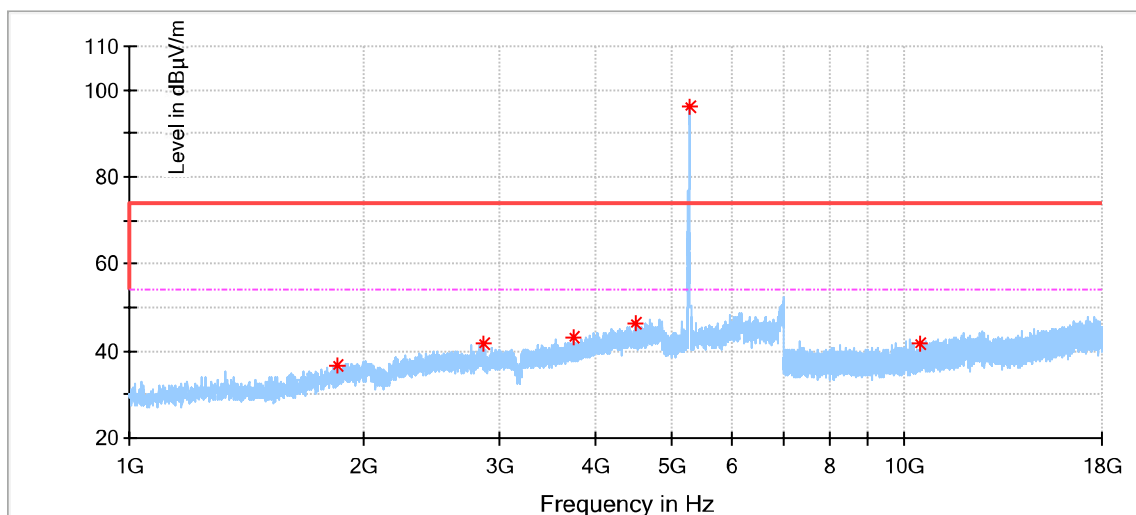

Frequency (MHz)	MaxPeak (dBµV/m)	Limit (dBµV/m)	Margin (dB)	Height (cm)	Pol	Azimuth (deg)	Corr. (dB/m)
1857.000000	36.84	74	37.16	150	H	114.0	-6.9
2859.500000	41.53	74	32.47	150	H	221.0	-3.8
3734.000000	43.31	74	30.69	150	H	10.0	-0.9
4493.000000	46.29	74	27.71	150	H	69.0	2.2
10483.000000	41.77	74	32.23	150	H	40.0	8.1
21027.062500	41.00	74	33.00	100	H	6.0	-0.2
23731.000000	42.99	74	31.01	100	H	357.0	1.1
26558.000000	43.20	74	30.80	100	H	277.0	2.6
31090.687500	46.54	74	27.46	100	H	0.0	2.5
37892.812500	48.20	74	25.80	100	H	6.0	5.9
38366.500000	47.84	74	26.16	100	H	357.0	5.8

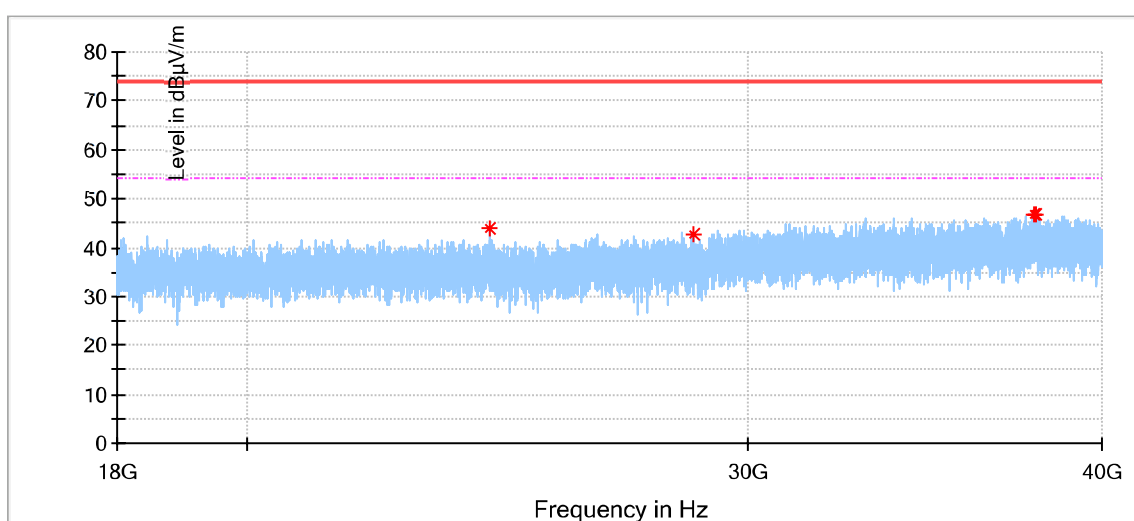
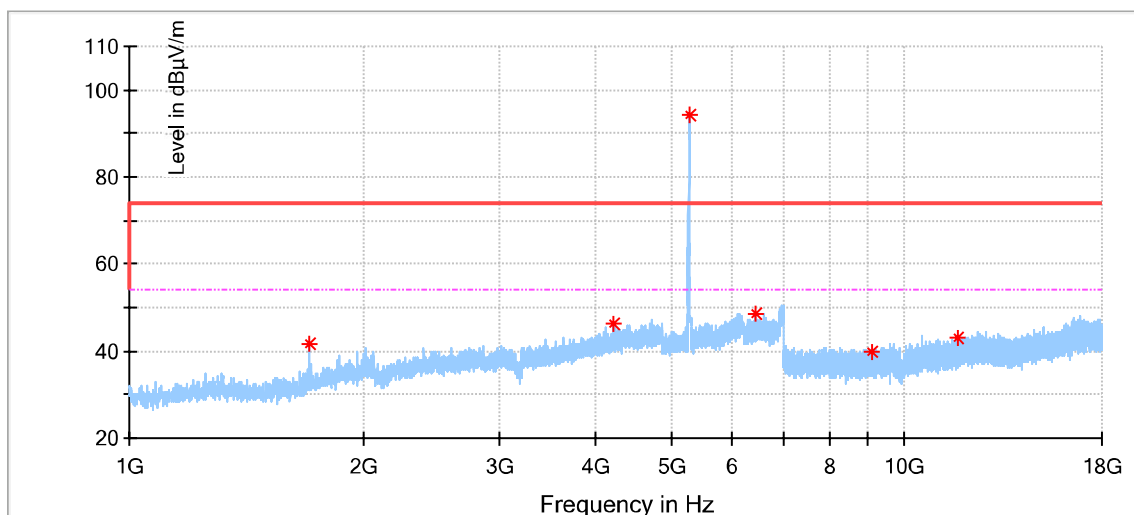

Frequency (MHz)	MaxPeak (dBµV/m)	Limit (dBµV/m)	Margin (dB)	Height (cm)	Pol	Azimuth (deg)	Corr. (dB/m)
1704.000000	41.52	74	32.48	150	V	176.0	-8.0
4208.500000	46.39	74	27.61	150	V	140.0	1.2
6414.500000	48.73	74	25.27	150	V	351.0	5.9
9062.500000	40.07	74	33.93	150	V	195.0	7.0
11765.000000	43.26	74	30.74	150	V	303.0	9.0
24344.250000	43.88	74	30.12	100	V	0.0	1.1
28747.000000	42.68	74	31.32	100	V	0.0	2.2
37877.000000	46.95	74	27.05	100	V	0.0	5.9
37940.937500	46.88	74	27.12	100	V	0.0	6.0

802.11a Modulation 5320MHz Test Result

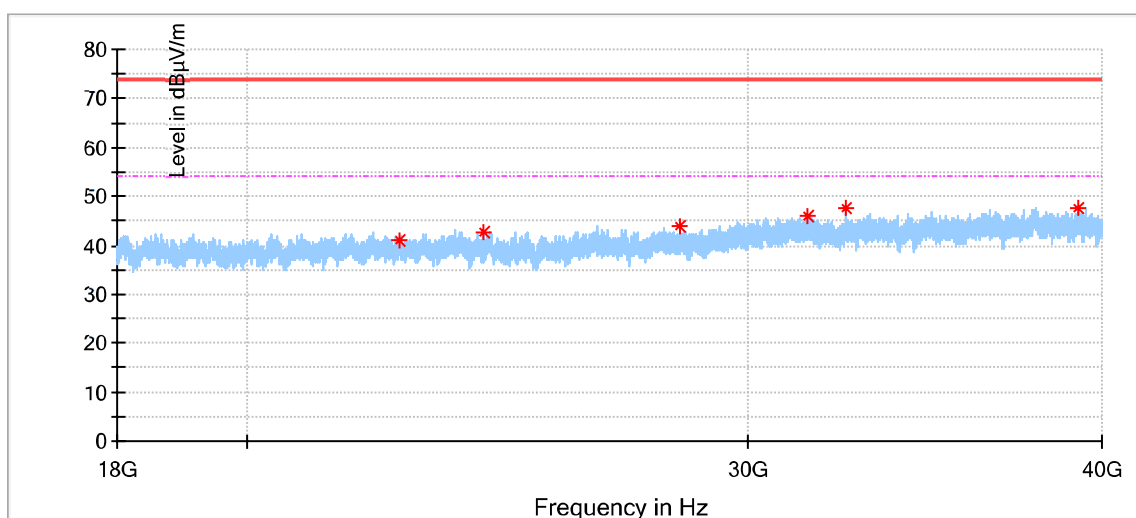
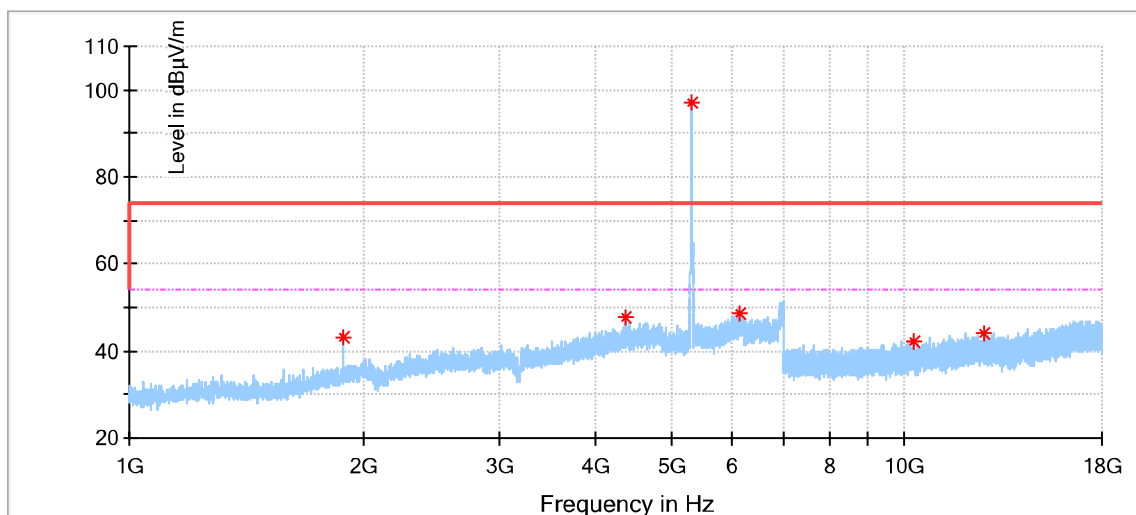

Frequency (MHz)	MaxPeak (dBµV/m)	Limit (dBµV/m)	Margin (dB)	Height (cm)	Pol	Azimuth (deg)	Corr. (dB/m)
1886.000000	42.91	74	31.09	150	H	96.0	-6.3
4370.500000	47.49	74	26.51	150	H	10.0	1.9
6141.500000	48.50	74	25.50	150	H	337.0	4.4
10291.500000	42.08	74	31.92	150	H	37.0	7.9
12642.000000	44.10	74	29.90	150	H	116.0	10.1
22635.812500	41.11	74	32.89	100	H	94.0	0.2
24243.187500	42.67	74	31.33	100	H	121.0	1.0
28421.812500	43.84	74	30.16	100	H	79.0	2.1
31517.625000	45.90	74	28.10	100	H	79.0	2.7
32503.500000	47.56	74	26.44	100	H	3.0	3.0
39236.875000	47.53	74	26.47	100	H	251.0	6.7

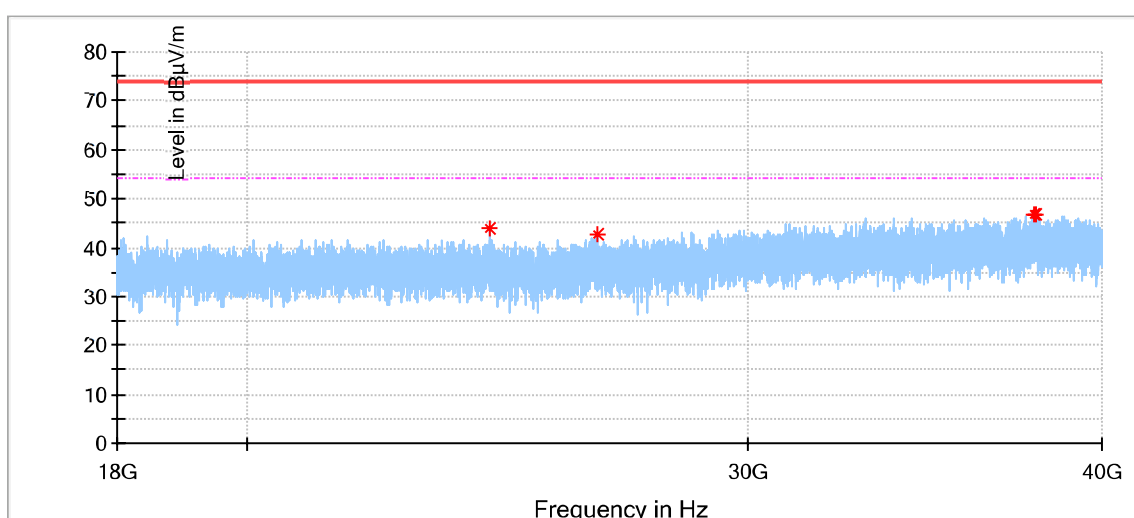
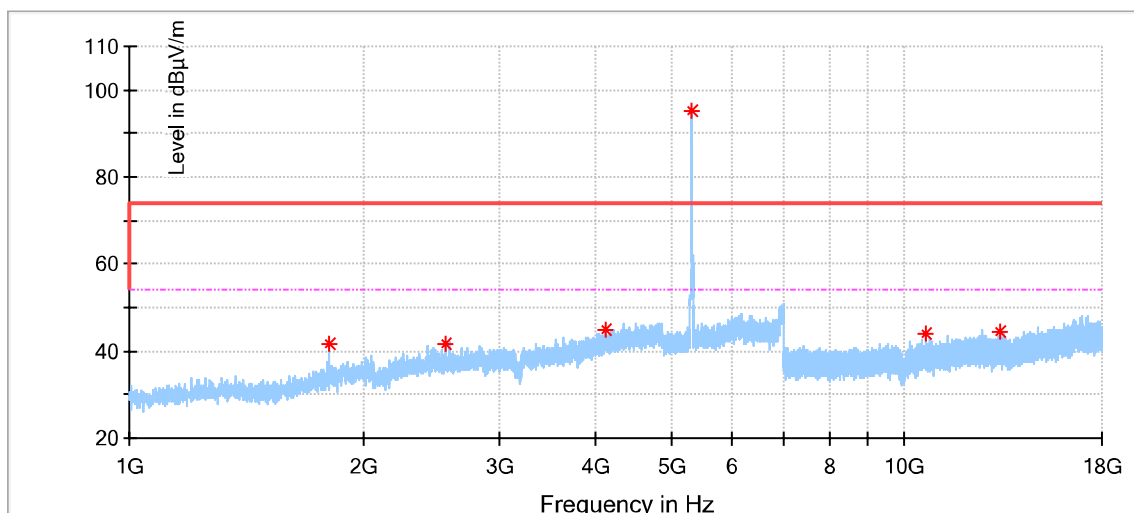

Frequency (MHz)	MaxPeak (dBµV/m)	Limit (dBµV/m)	Margin (dB)	Height (cm)	Pol	Azimuth (deg)	Corr. (dB/m)
1816.000000	41.55	74	32.45	150	V	185.0	-7.0
2552.500000	41.79	74	32.21	150	V	359.0	-4.1
4123.500000	44.84	74	29.16	150	V	24.0	0.8
10640.000000	44.09	74	29.91	150	V	111.0	8.3
13257.500000	44.26	74	29.74	150	V	137.0	9.9
24344.250000	43.88	74	30.12	100	V	0.0	1.1
26590.312500	42.86	74	31.14	100	V	0.0	2.5
37877.000000	46.95	74	27.05	100	V	0.0	5.9
37940.937500	46.88	74	27.12	100	V	0.0	6.0

802.11a Modulation 5500MHz Test Result

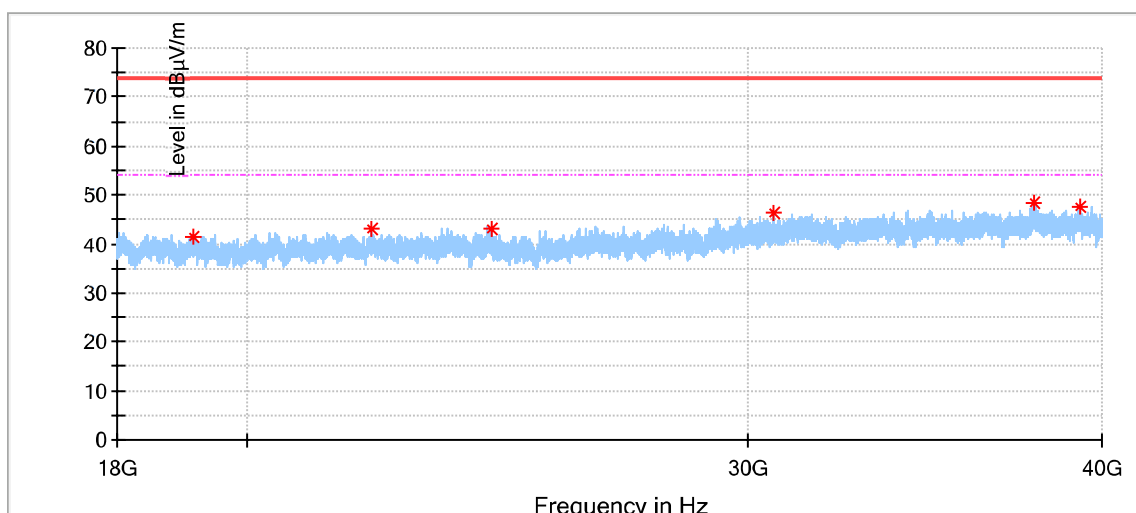
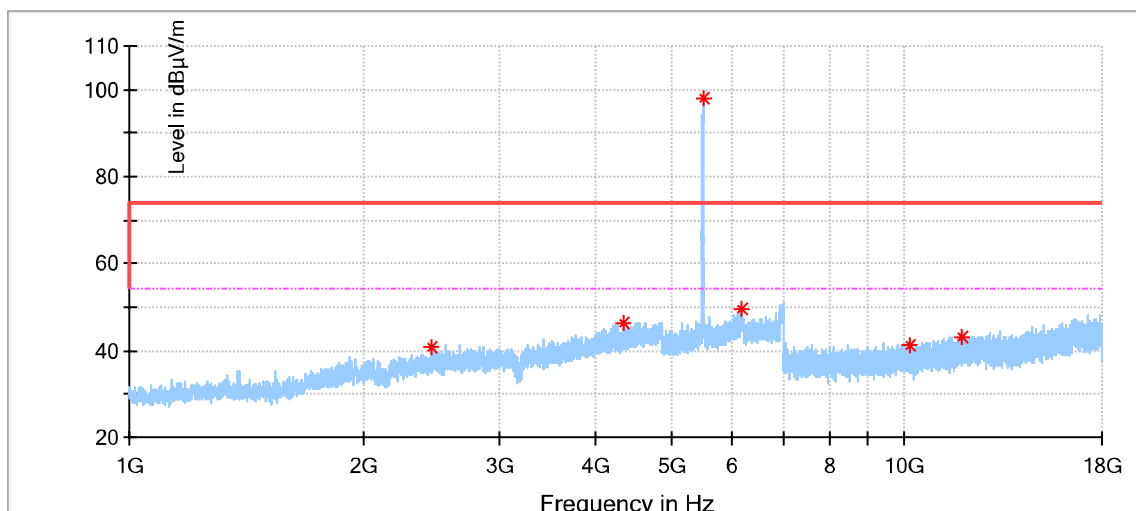

Frequency (MHz)	MaxPeak (dBµV/m)	Limit (dBµV/m)	Margin (dB)	Height (cm)	Pol	Azimuth (deg)	Corr. (dB/m)
2456.000000	40.59	74	33.41	150	H	283.0	-4.3
4338.000000	46.41	74	27.59	150	H	4.0	1.4
6161.500000	49.32	74	24.68	150	H	356.0	4.6
10147.000000	41.13	74	32.87	150	H	66.0	8.2
11873.500000	43.28	74	30.72	150	H	93.0	9.5
19136.437500	41.47	74	32.53	100	H	21.0	-1.9
22113.312500	43.19	74	30.81	100	H	273.0	0.3
24365.562500	43.06	74	30.94	100	H	84.0	1.1
30664.437500	46.21	74	27.79	100	H	127.0	2.4
37875.625000	48.34	74	25.66	100	H	113.0	5.9
39293.937500	47.40	74	26.60	100	H	230.0	6.8

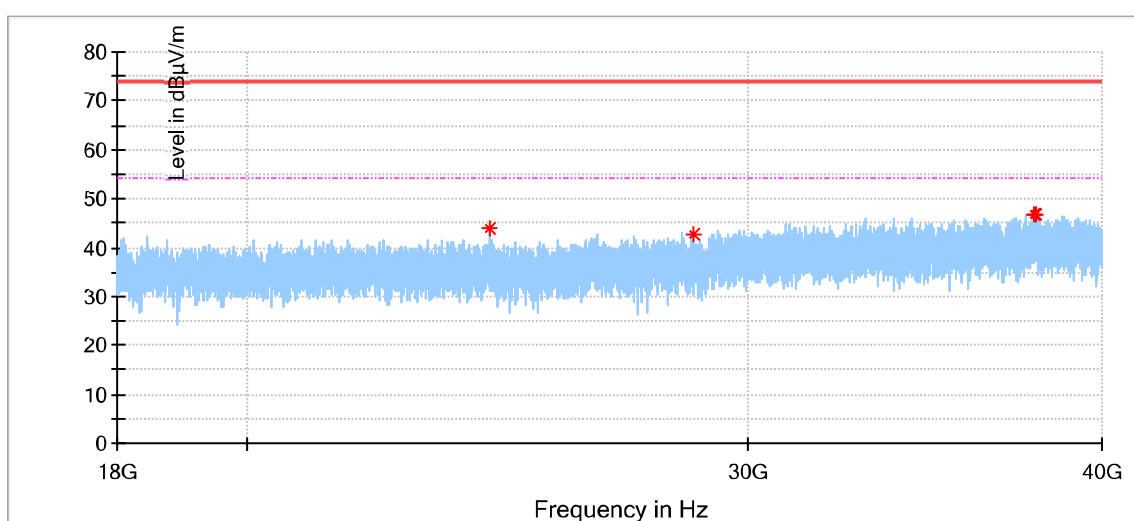
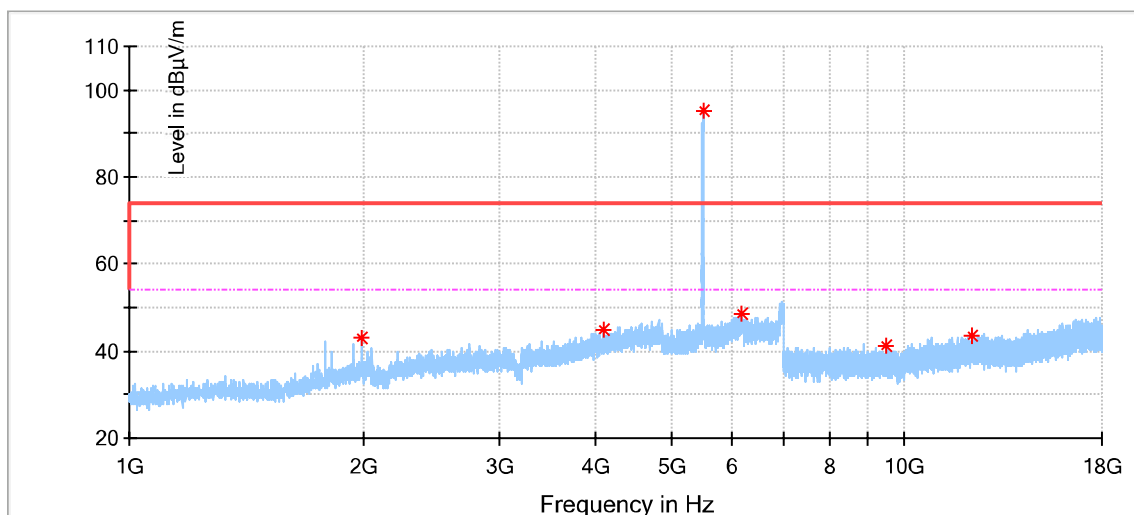

Frequency (MHz)	MaxPeak (dBµV/m)	Limit (dBµV/m)	Margin (dB)	Height (cm)	Pol	Azimuth (deg)	Corr. (dB/m)
1992.500000	43.03	74	30.97	150	V	203.0	-6.0
4105.000000	45.11	74	28.89	150	V	221.0	0.9
6187.000000	48.78	74	25.22	150	V	24.0	5.2
9443.000000	41.28	74	32.72	150	V	35.0	7.3
12249.500000	43.66	74	30.34	150	V	88.0	9.6
24344.250000	43.88	74	30.12	100	V	0.0	1.1
28747.000000	42.68	74	31.32	100	V	0.0	2.2
37877.000000	46.95	74	27.05	100	V	0.0	5.9
37940.937500	46.88	74	27.12	100	V	0.0	6.0

802.11a Modulation 5580MHz Test Result

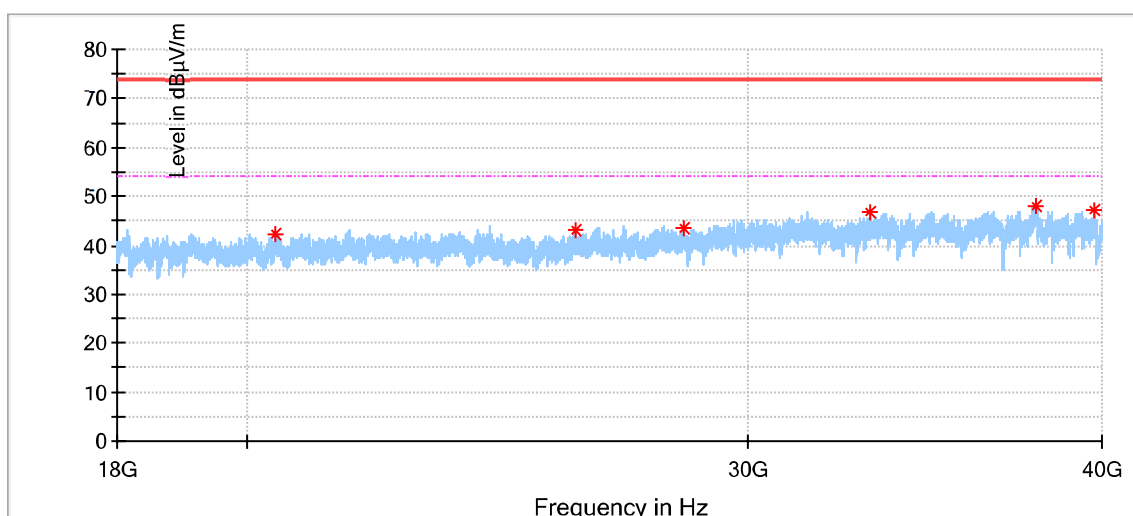
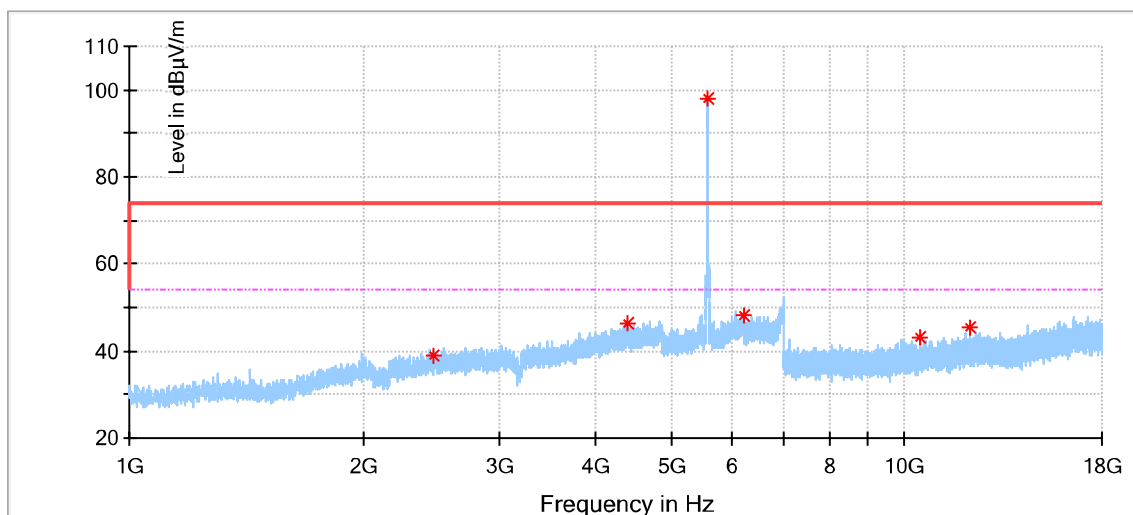

Frequency (MHz)	MaxPeak (dBµV/m)	Limit (dBµV/m)	Margin (dB)	Height (cm)	Pol	Azimuth (deg)	Corr. (dB/m)
2467.500000	38.84	74	35.16	150	H	10.0	-4.3
4400.500000	46.14	74	27.86	150	H	340.0	2.1
6190.000000	48.08	74	25.92	150	H	114.0	5.3
10475.500000	43.15	74	30.85	150	H	224.0	8.1
12141.500000	45.36	74	28.64	150	H	1.0	9.7
20475.000000	42.17	74	31.83	100	H	119.0	-0.9
26105.625000	43.11	74	30.89	100	H	35.0	1.4
28476.125000	43.32	74	30.68	100	H	0.0	2.1
33111.250000	46.76	74	27.24	100	H	353.0	3.3
37883.875000	47.95	74	26.05	100	H	292.0	5.9
39712.625000	47.18	74	26.82	100	H	292.0	7.5

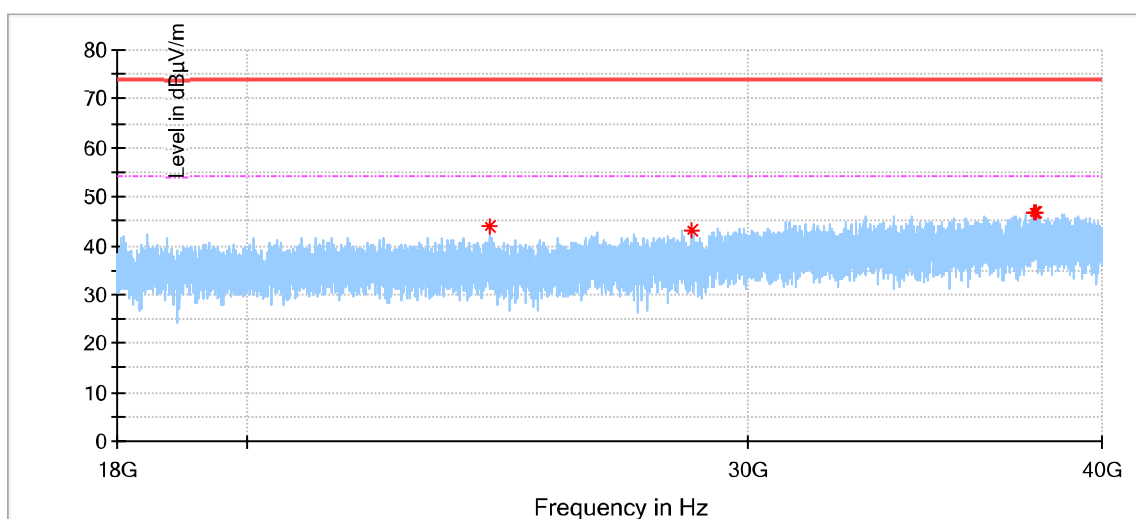
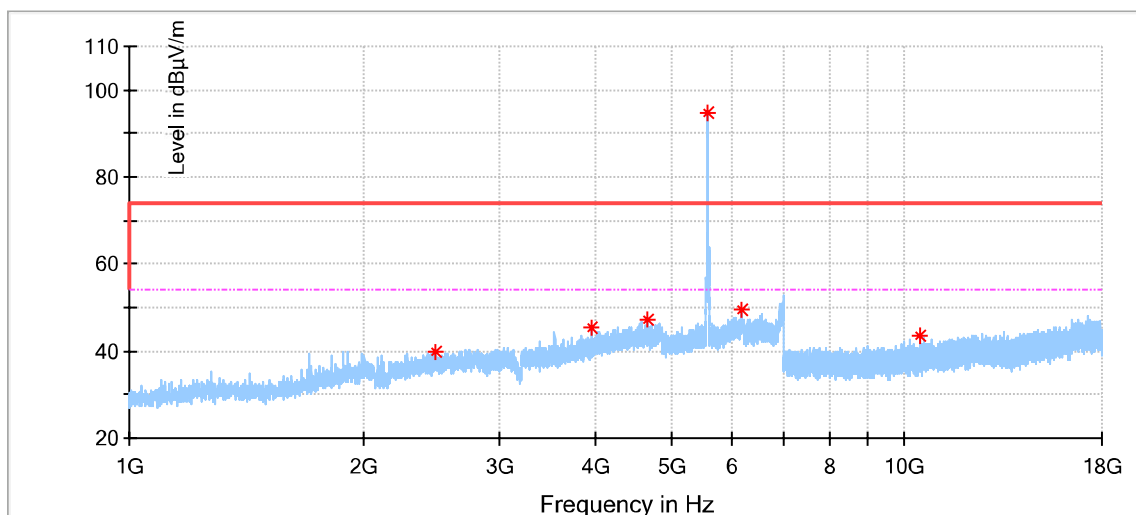

Frequency (MHz)	MaxPeak (dBµV/m)	Limit (dBµV/m)	Margin (dB)	Height (cm)	Pol	Azimuth (deg)	Corr. (dB/m)
2491.000000	39.76	74	34.24	150	V	319.0	-4.1
3945.500000	45.20	74	28.80	150	V	4.0	0.4
4672.500000	47.29	74	26.71	150	V	114.0	2.1
6175.500000	49.58	74	24.42	150	V	4.0	5.0
10449.000000	43.55	74	30.45	150	V	116.0	8.0
24344.250000	43.88	74	30.12	100	V	0.0	1.1
28687.875000	43.13	74	30.87	100	V	0.0	2.2
37877.000000	46.95	74	27.05	100	V	0.0	5.9
37940.937500	46.88	74	27.12	100	V	0.0	6.0

802.11a Modulation 5700MHz Test Result

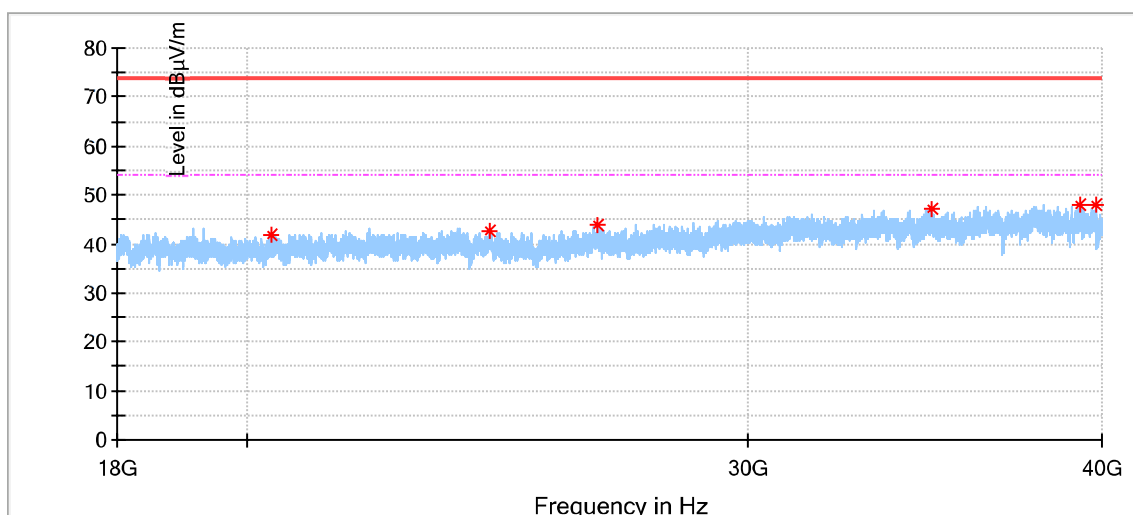
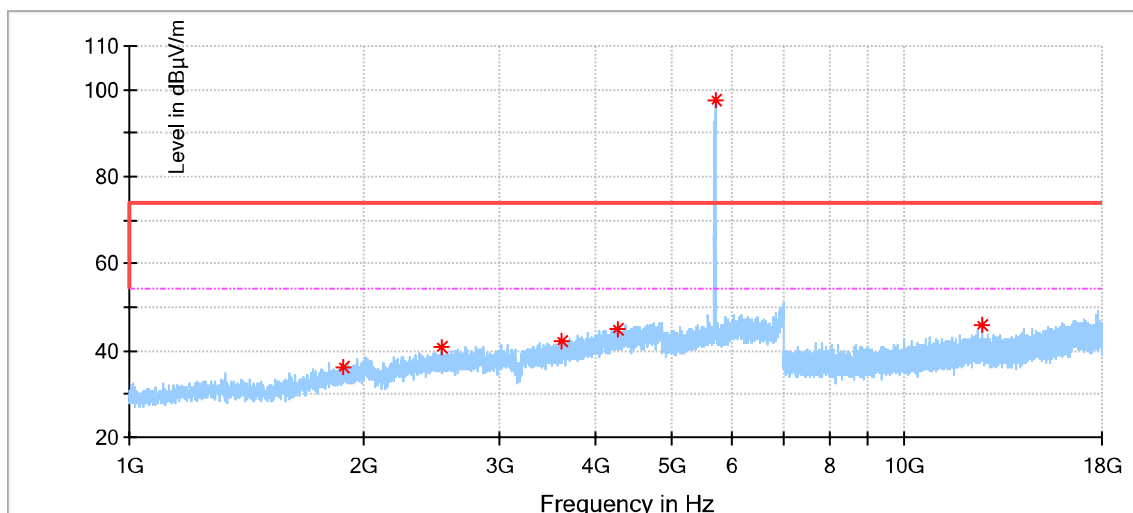

Frequency (MHz)	MaxPeak (dBµV/m)	Limit (dBµV/m)	Margin (dB)	Height (cm)	Pol	Azimuth (deg)	Corr. (dB/m)
1891.000000	36.37	74	37.63	150	H	24.0	-6.3
2532.000000	40.55	74	33.45	150	H	222.0	-4.1
3614.000000	42.10	74	31.90	150	H	24.0	-1.6
4275.500000	44.71	74	29.29	150	H	16.0	1.2
12601.000000	45.82	74	28.18	150	H	356.0	9.7
20386.312500	41.83	74	32.17	100	H	165.0	-1.3
24328.437500	42.77	74	31.23	100	H	236.0	1.1
26566.937500	43.85	74	30.15	100	H	338.0	2.6
34872.625000	47.29	74	26.71	100	H	294.0	4.2
39275.375000	48.18	74	25.82	100	H	66.0	6.7
39780.000000	48.02	74	25.98	100	H	124.0	7.6

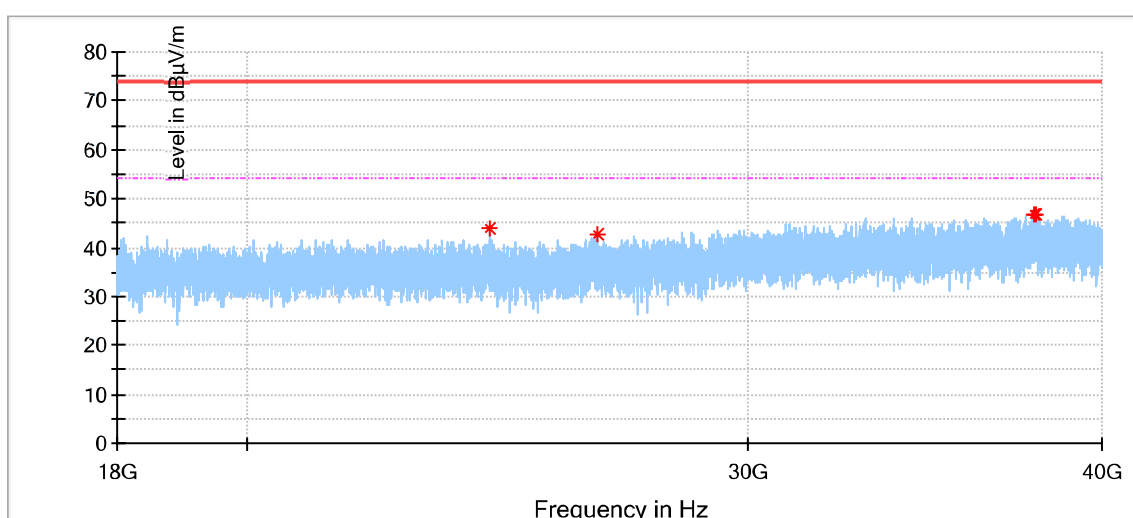
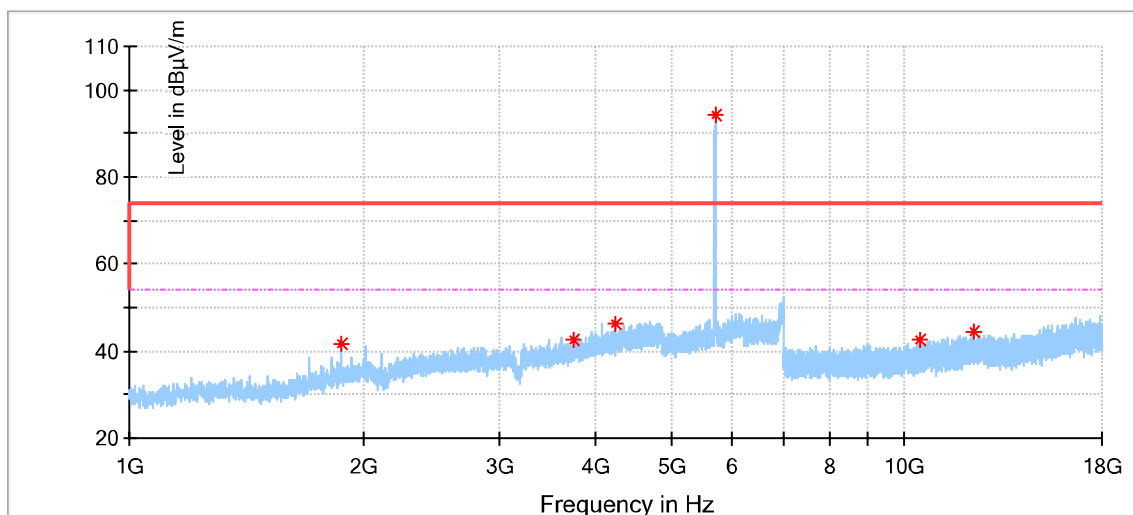

Frequency (MHz)	MaxPeak (dBµV/m)	Limit (dBµV/m)	Margin (dB)	Height (cm)	Pol	Azimuth (deg)	Corr. (dB/m)
1875.000000	41.62	74	32.38	150	V	170.0	-6.6
3736.500000	42.63	74	31.37	150	V	179.0	-0.8
4245.500000	46.39	74	27.61	150	V	90.0	1.2
10475.500000	42.45	74	31.55	150	V	277.0	8.1
12302.500000	44.61	74	29.39	150	V	224.0	10.0
24344.250000	43.88	74	30.12	100	V	0.0	1.1
26590.312500	42.86	74	31.14	100	V	0.0	2.5
37877.000000	46.95	74	27.05	100	V	0.0	5.9
37940.937500	46.88	74	27.12	100	V	0.0	6.0

802.11a Modulation 5745MHz Test Result

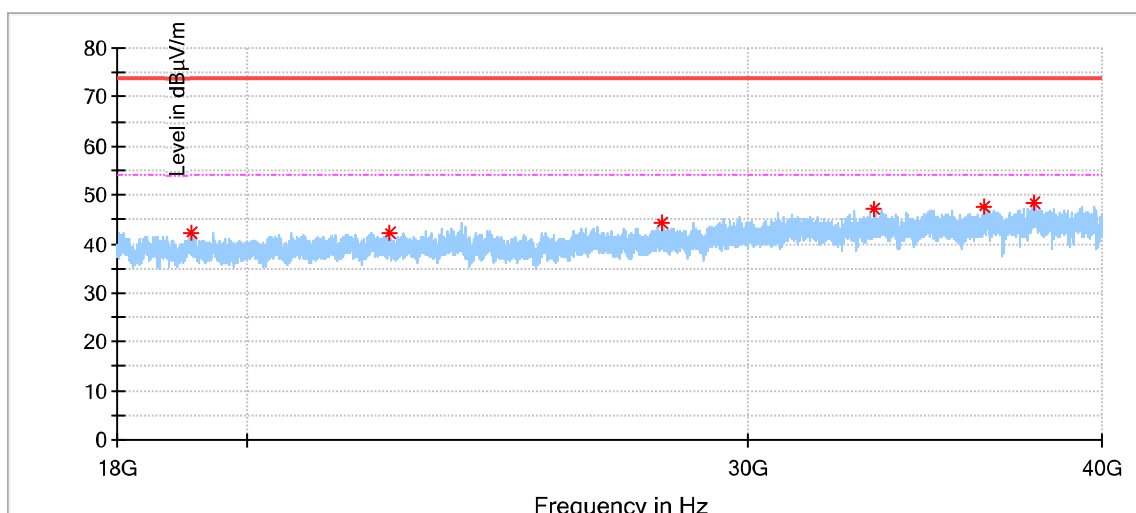
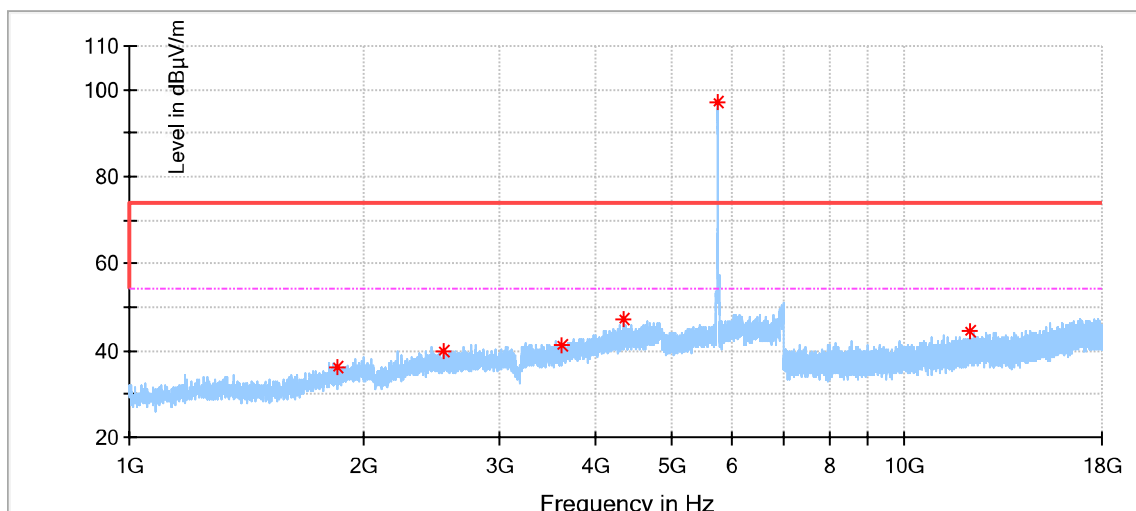

Frequency (MHz)	MaxPeak (dBµV/m)	Limit (dBµV/m)	Margin (dB)	Height (cm)	Pol	Azimuth (deg)	Corr. (dB/m)
1851.000000	35.99	74	38.01	150	H	319.0	-6.9
2545.500000	39.77	74	34.23	150	H	319.0	-4.1
3604.500000	41.41	74	32.59	150	H	158.0	-1.7
4334.000000	47.02	74	26.98	150	H	42.0	1.3
12190.500000	44.63	74	29.37	150	H	142.0	9.5
19099.312500	42.14	74	31.86	100	H	70.0	-1.9
22448.125000	42.40	74	31.60	100	H	140.0	0.3
27996.937500	44.41	74	29.59	100	H	354.0	2.0
33235.000000	47.05	74	26.95	100	H	342.0	3.3
36363.812500	47.77	74	26.23	100	H	168.0	5.0
37825.437500	48.45	74	25.55	100	H	84.0	5.9

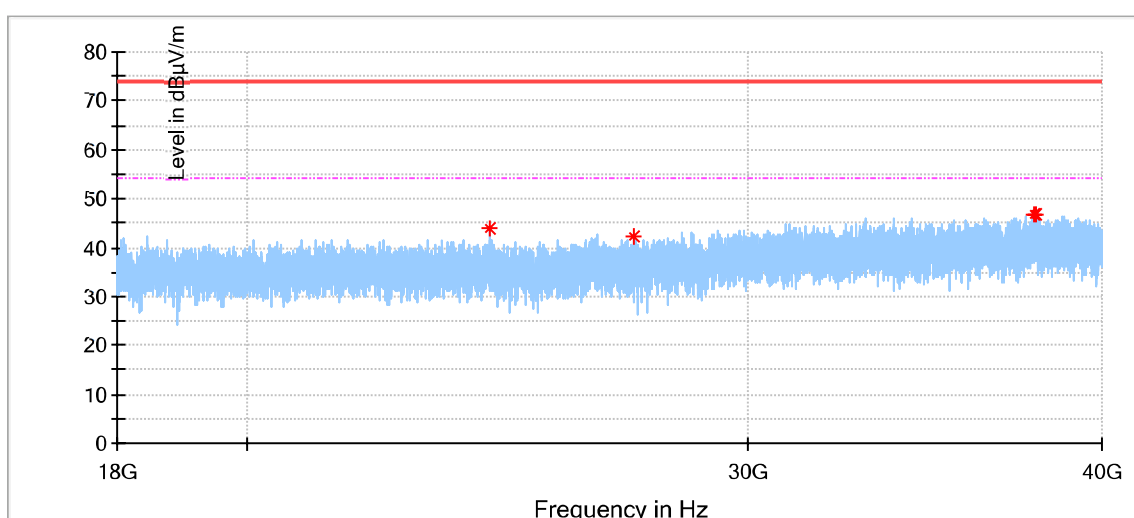
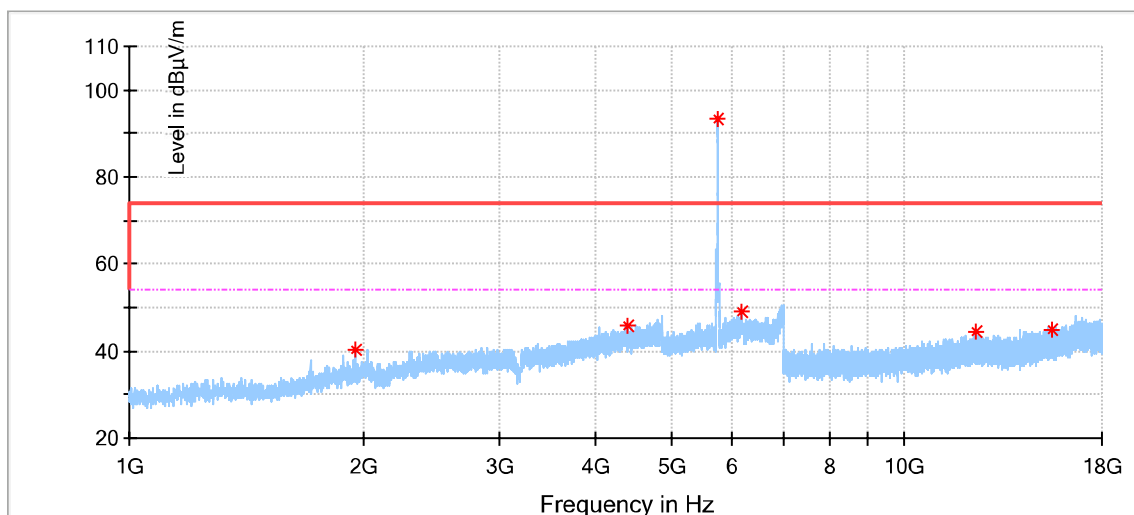

Frequency (MHz)	MaxPeak (dBµV/m)	Limit (dBµV/m)	Margin (dB)	Height (cm)	Pol	Azimuth (deg)	Corr. (dB/m)
1956.000000	40.52	74	33.48	150	V	359.0	-6.2
4390.000000	45.95	74	28.05	150	V	33.0	1.8
6186.500000	48.89	74	25.11	150	V	123.0	5.2
12398.000000	44.45	74	29.55	150	V	40.0	10.2
15510.000000	45.04	74	28.96	150	V	303.0	12.8
24344.250000	43.88	74	30.12	100	V	0.0	1.1
27379.562500	42.46	74	31.54	100	V	0.0	1.8
37877.000000	46.95	74	27.05	100	V	0.0	5.9
37940.937500	46.88	74	27.12	100	V	0.0	6.0

802.11a Modulation 5785MHz Test Result

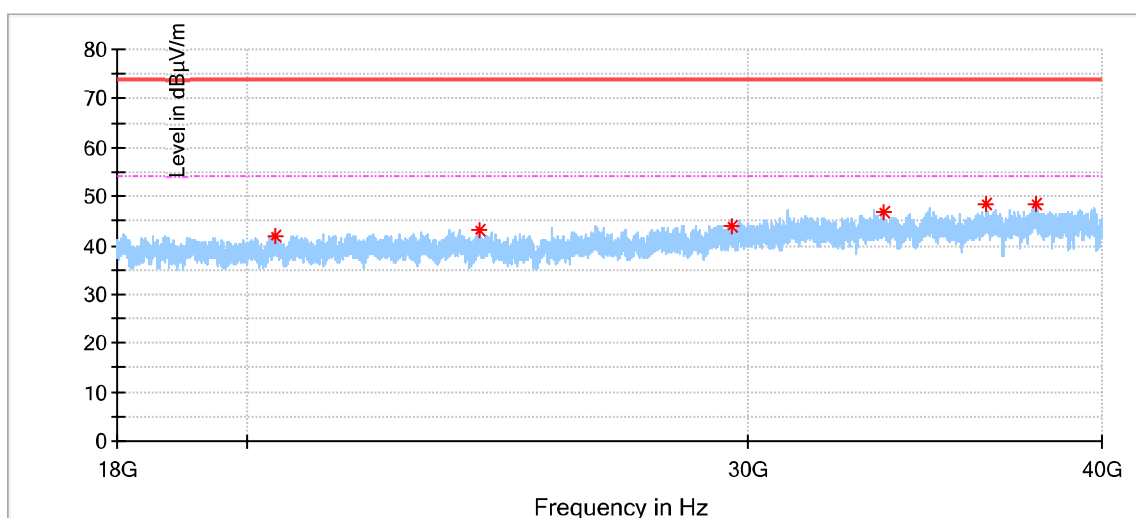
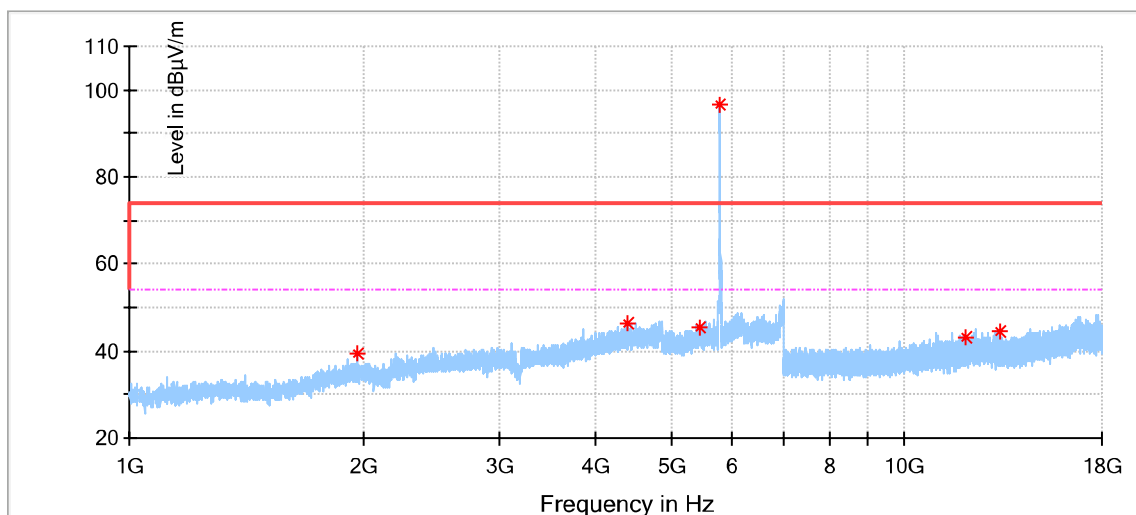

Frequency (MHz)	MaxPeak (dBµV/m)	Limit (dBµV/m)	Margin (dB)	Height (cm)	Pol	Azimuth (deg)	Corr. (dB/m)
1966.500000	39.40	74	34.60	150	H	37.0	-6.2
4398.500000	46.11	74	27.89	150	H	90.0	2.1
5436.000000	45.43	74	28.57	150	H	117.0	2.9
12022.000000	43.19	74	30.81	150	H	11.0	9.8
13328.500000	44.67	74	29.33	150	H	303.0	10.0
20470.187500	41.84	74	32.16	100	H	125.0	-0.9
24155.187500	43.21	74	30.79	100	H	199.0	0.8
29622.875000	43.99	74	30.01	100	H	4.0	2.4
33508.625000	46.88	74	27.12	100	H	0.0	3.3
36434.625000	48.35	74	25.65	100	H	125.0	5.1
37899.000000	48.47	74	25.53	100	H	52.0	5.9

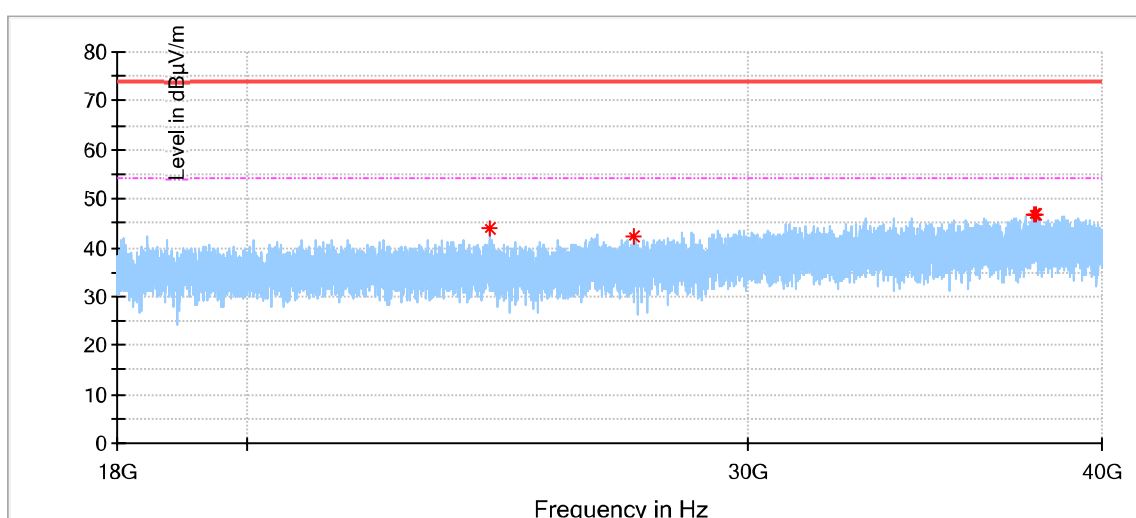
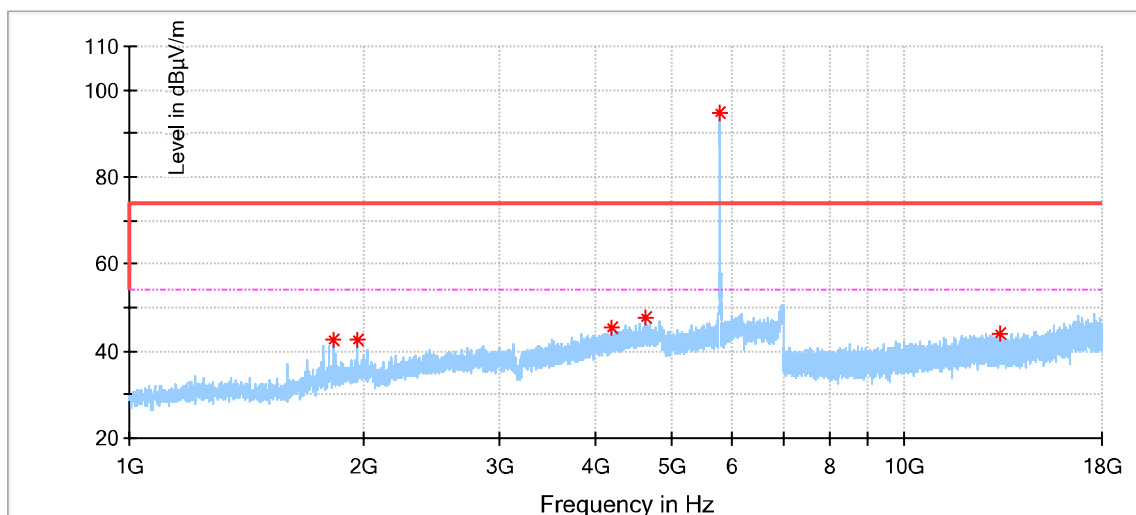

Frequency (MHz)	MaxPeak (dBµV/m)	Limit (dBµV/m)	Margin (dB)	Height (cm)	Pol	Azimuth (deg)	Corr. (dB/m)
1830.500000	42.51	74	31.49	150	V	192.0	-7.0
1967.000000	42.43	74	31.57	150	V	192.0	-6.2
4185.500000	45.35	74	28.65	150	V	308.0	1.1
4627.000000	47.62	74	26.38	150	V	9.0	2.2
13257.000000	44.09	74	29.91	150	V	224.0	9.9
24344.250000	43.88	74	30.12	100	V	0.0	1.1
27379.562500	42.46	74	31.54	100	V	0.0	1.8
37877.000000	46.95	74	27.05	100	V	0.0	5.9
37940.937500	46.88	74	27.12	100	V	0.0	6.0

802.11a Modulation 5825MHz Test Result

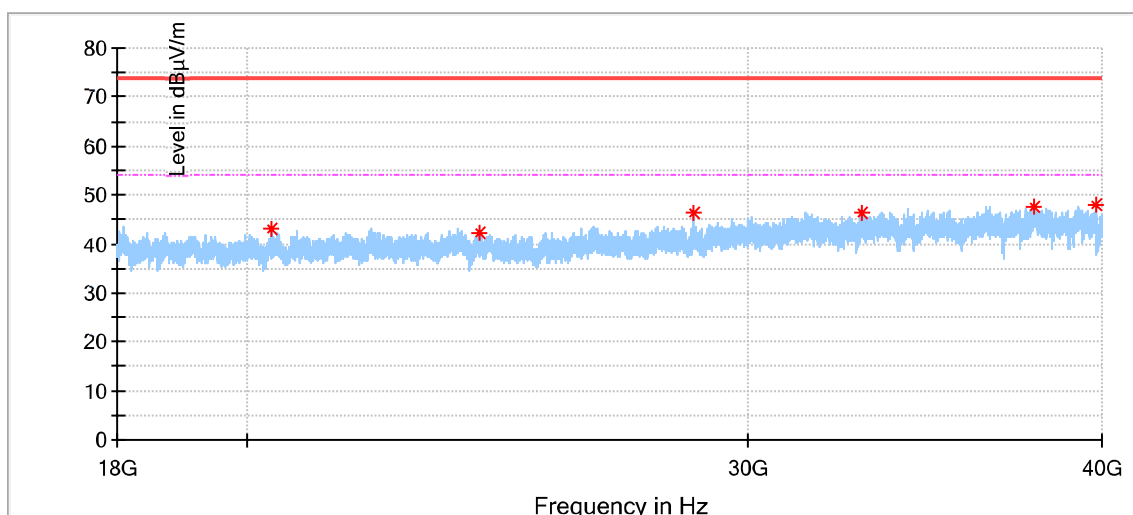
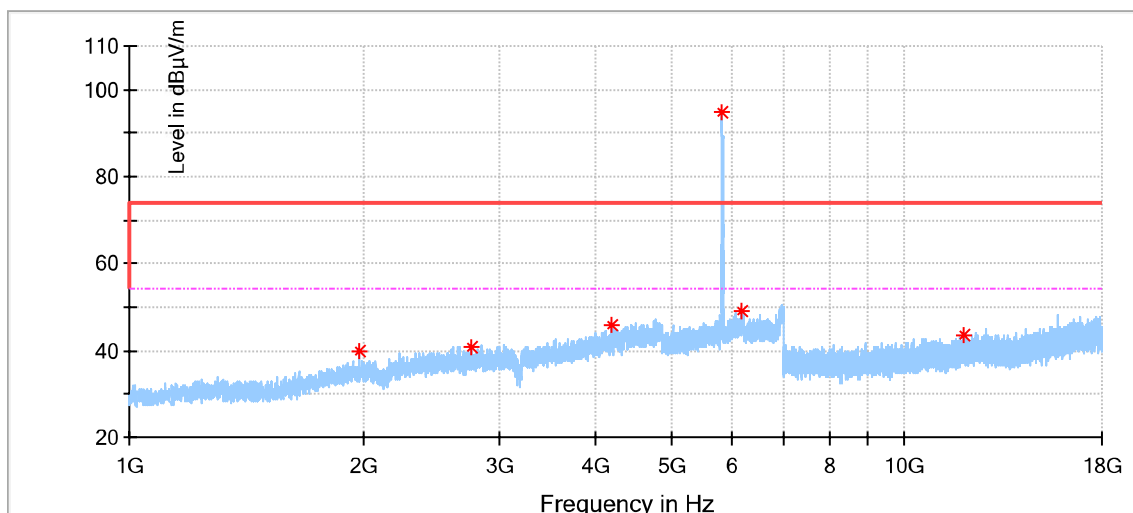

Frequency (MHz)	MaxPeak (dBµV/m)	Limit (dBµV/m)	Margin (dB)	Height (cm)	Pol	Azimuth (deg)	Corr. (dB/m)
1980.000000	39.91	74	34.09	150	H	87.0	-6.0
2761.500000	40.55	74	33.45	150	H	78.0	-4.0
4196.500000	45.71	74	28.29	150	H	242.0	1.2
6186.500000	49.02	74	24.98	150	H	224.0	5.2
11946.000000	43.48	74	30.52	150	H	331.0	9.8
20388.375000	43.02	74	30.98	100	H	215.0	-1.2
24142.125000	42.40	74	31.60	100	H	354.0	0.8
28709.187500	46.15	74	27.85	100	H	50.0	2.2
32914.625000	46.44	74	27.56	100	H	116.0	3.2
37848.125000	47.67	74	26.33	100	H	339.0	5.9
39793.062500	47.88	74	26.12	100	H	181.0	7.6

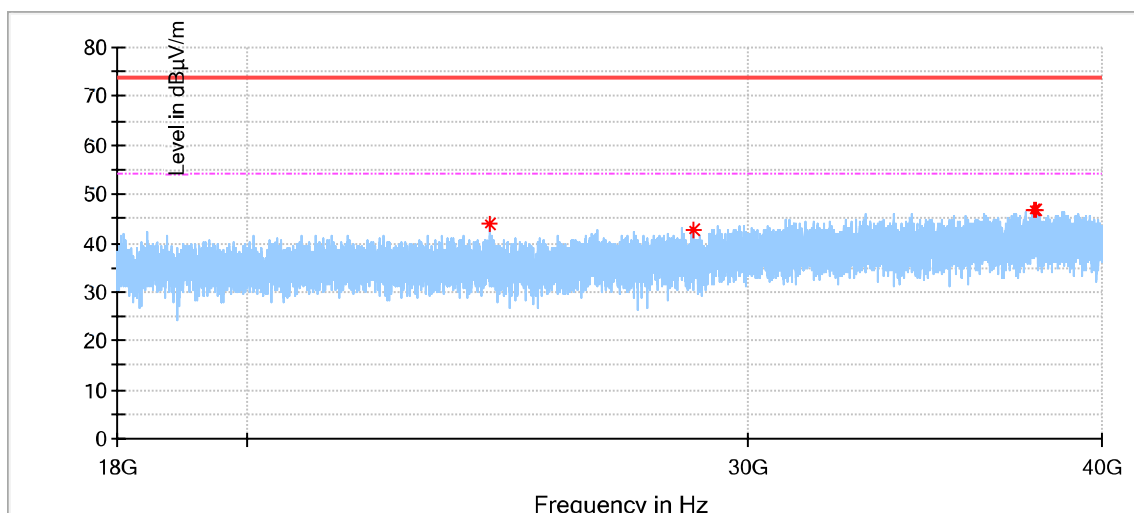
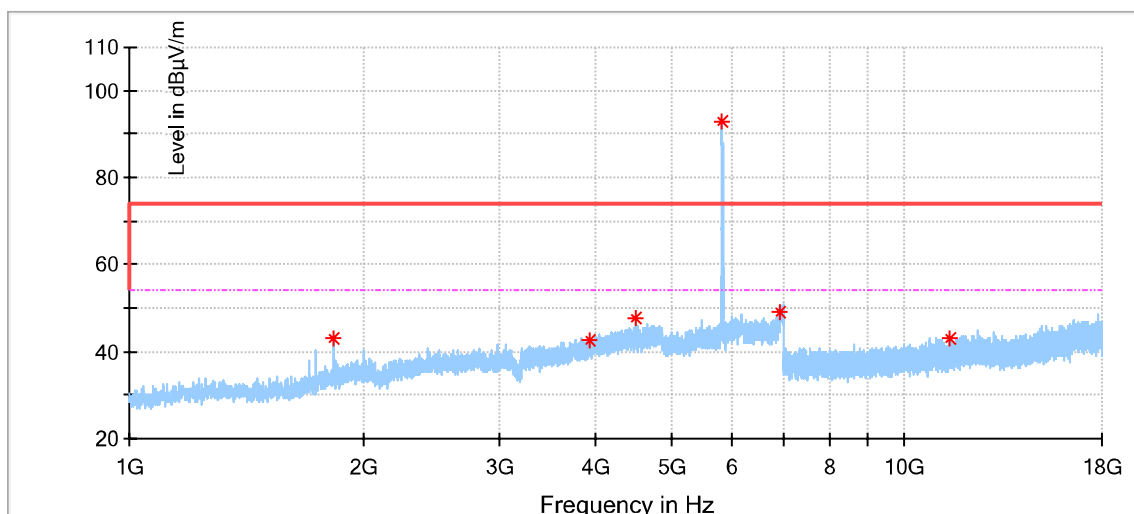

Frequency (MHz)	MaxPeak (dBµV/m)	Limit (dBµV/m)	Margin (dB)	Height (cm)	Pol	Azimuth (deg)	Corr. (dB/m)
1835.000000	43.02	74	30.98	150	V	194.0	-7.0
3918.500000	42.75	74	31.25	150	V	10.0	0.0
4503.500000	47.68	74	26.32	150	V	51.0	2.2
6891.500000	49.01	74	24.99	150	V	140.0	6.3
11433.000000	43.26	74	30.74	150	V	172.0	8.7
24344.250000	43.88	74	30.12	100	V	0.0	1.1
28747.000000	42.68	74	31.32	100	V	0.0	2.2
37877.000000	46.95	74	27.05	100	V	0.0	5.9
37940.937500	46.88	74	27.12	100	V	0.0	6.0

Remark:

- (1) Corrected Amplitude = Read level + Corrector factor
Above 1GHz: Corrector factor = Antenna Factor + Cable Loss- Amplifier Gain.
Below 1GHz: Corrector factor = Antenna Factor + Cable Loss.
(The Reading Level is recorded by software which is not shown in the sheet)
- (2) We test all modes and only the worst case recorded in the report.
- (3) Data of measurement within this frequency range shown "--" in the table above means the reading of emissions are the noise floor or attenuated more than 10dB below the permissible limits or the field strength is too small to be measured.

8.6. Band Edge

Test Method

According to KBD789033 D02 (Integration Method)

- a) Set RBW = 100 kHz
- b) Set VBW $\geq 3 \times$ RBW
- c) Perform a band-power integration across the 1 MHz bandwidth in which the band-edge emission level is to be measured.

Limits:

For transmitters operating in the 5.15-5.25 GHz band: All emissions outside of the 5.15-5.35 GHz band shall not exceed an e.i.r.p. of -27 dBm/MHz.

For transmitters operating in the 5.25-5.35 GHz band: All emissions outside of the 5.15-5.35 GHz band shall not exceed an e.i.r.p. of -27 dBm/MHz.

For transmitters operating in the 5.47-5.725 GHz band: All emissions outside of the 5.47-5.725 GHz band shall not exceed an e.i.r.p. of -27 dBm/MHz.

For transmitters operating in the 5.725-5.85 GHz band: All emissions within the frequency range from the band edge to 10 MHz above or below the band edge shall not exceed an e.i.r.p. of -17 dBm/MHz; for frequencies 10 MHz or greater above or below the band edge, emissions shall not exceed an e.i.r.p. of -27 dBm/MHz.

Test Setup:

The Wi-Fi component's antenna ports(s) of the EUT are connected to the measurement instrument per an appropriate attenuator. The EUT is controlled by PC/software to emit the specified signals for the purpose of measurements.

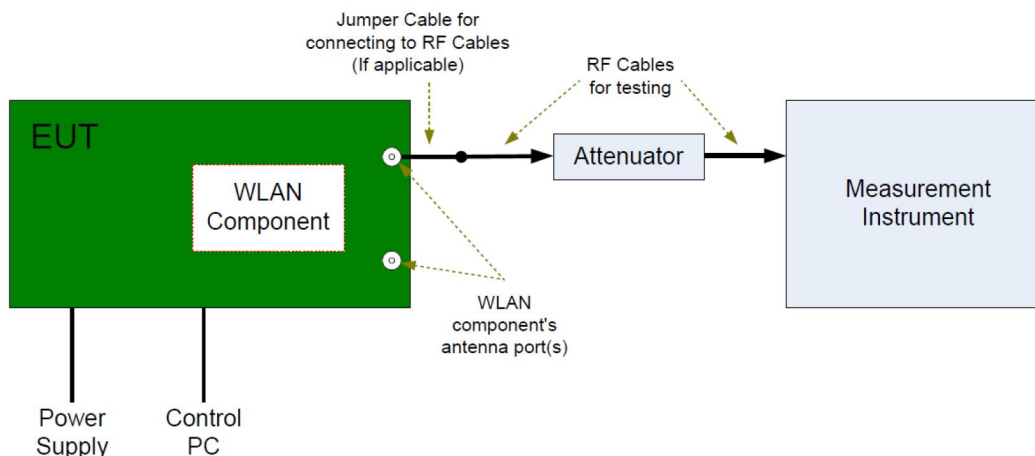

Test Result: Pass

8.7. Frequencies Stability

Test Method

1. The EUT was placed on 0.8m height table, the RF output of EUT was connected to the test receiver by RF cable. The path loss was compensated to the results for each measurement.
2. Set Centre Frequency of the channel under test.
3. Set Detector PEAK
4. Set RBW: 10KHz, VBW: 3RBW
5. Set Span: Encompass the entire emissions bandwidth (EBW) of the signal.
6. Allow the trace to stabilize, find the peak value of the power envelope and record the frequency, then calculated the frequency drift.

The test extreme voltage is to change the primary supply voltage from 85 to 115 percent of the nominal value.

User manual temperature is -10°C to 45°C, normal Temperature is +20°C.

Limit: 20ppm

Test Results (All conditions and all modes were performed, only list Worst-Case in the report)

Test Result: Pass

Test data refer to annex.

8.8. Dynamic Frequency Selection (DFS)

1. General Test Condition

Parameters of EUT	
Frequency	5250 – 5350 MHz & 5470 – 5725 MHz
Operational Mode	Slave
Modulation:	OFDM
Channel Bandwidth:	20 MHz , 40 MHz. 80 MHz

Note: This device was functioned as a Slave device during the DFS

2. Test requirement

The manufacturer shall whether the EUT is capable of operating as a master and a client. If the EUT is capable of operating in more than one operating mode then each operating mode shall be tested separately.

DFS Applicability

Requirement	Operational Mode		
	Master	Client Without Radar Detection	Client With Radar Detection
Non-Occupancy Period	Yes	Not required	Yes
DFS Detection Threshold	Yes	Not required	Yes
Channel Availability Check Time	Yes	Not required	Not required
Uniform Spreading	Yes	Not required	Not required
U-NII Detection Bandwidth	Yes	Not required	Yes

DFS Applicability During Normal Operation

Requirement	Operational Mode		
	Master	Client Without Radar Detection	Radar Detection
Non-Occupancy Period	Yes	Not required	Yes
DFS Detection Threshold	Yes	Not required	Yes
Channel Availability Check Time	Yes	Yes	Not required
Uniform Spreading	Yes	Yes	Not required
U-NII Detection Bandwidth	Yes	Not required	Yes

3、 Test Limited

According to KDB 905462 D02 Table 4 DFS Response Requirement Values

Parameter	Value
<i>Non-occupancy period</i>	Minimum 30 minutes
<i>Channel Availability Check Time</i>	60 seconds
<i>Channel Move Time</i>	10 seconds See Note 1.
<i>Channel Closing Transmission Time</i>	200 milliseconds + an aggregate of 60 milliseconds over remaining 10 second period. See Notes 1 and 2.
<i>U-NII Detection Bandwidth</i>	Minimum 100% of the U-NII 99% transmission power bandwidth. See Note 3.

Note 1: *Channel Move Time* and the *Channel Closing Transmission Time* should be performed with Radar Type 0. The measurement timing begins at the end of the Radar Type 0 burst.

Note 2: The *Channel Closing Transmission Time* is comprised of 200 milliseconds starting at the beginning of the *Channel Move Time* plus any additional intermittent control signals required to facilitate a *Channel* move (an aggregate of 60 milliseconds) during the remainder of the 10 second period. The aggregate duration of control signals will not count quiet periods in between transmissions.

Note 3: During the *U-NII Detection Bandwidth* detection test, radar type 0 should be used. For each frequency step the minimum percentage of detection is 90 percent. Measurements are performed with no data traffic.

4、 Calibration of Radar Waveform

- (1) A 50ohm load is connected in place of the spectrum analyzer, and the spectrum analyzer is connected to place of the master.
- (2) The interference Radar Detection Threshold Level is $-62\text{dBm}+3.7\text{dB}+1.5\text{dB}=-55.8\text{dBm}$ that had been taken into account the output power range and antenna gain.
- (3) The following equipment setup was used to calibrate the conducted radar waveform. A vector signal generator was utilized to establish the test signal level for radar type 0. During this process there were no transmissions by either the master or client device. The spectrum analyzer was switched to the zero spans (time domain) at the frequency of the radar waveform generator. Peak detection was used. The spectrum analyzer resolution bandwidth (RBW) and video bandwidth (VBW) were set to 3MHz. The spectrum analyzer had offset -1.5dB to compensate RF cable loss 1.5dB.
- (4) The vector signal generator amplitude was set so that the power level measured at the spectrum analyzer was $-62\text{dBm}+3.7\text{dB}+1.5\text{dB}=-55.8\text{dBm}$. Capture the spectrum analyzer plots on short pulse radar waveform.

Conducted Calibration Setup:

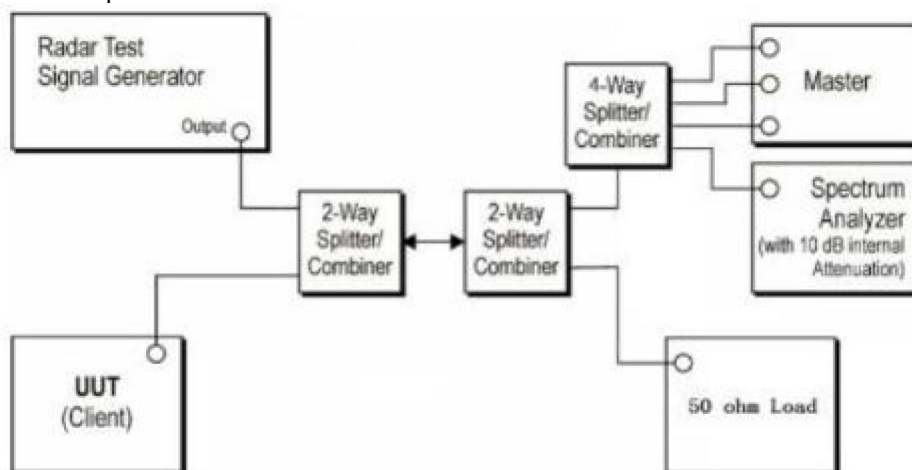

Radar Waveform Calibration result:

5、 Channel Closing Transmission Time, Channel Move Time and Non-Occupancy Period.

Block Diagram of test setup test procedure.

- (1) The Radar Pulse generator is setup to provide a pulse at frequency that the master and client are operating, A type 0 radar pulse with a 1us pulse width and a 1428us PRI is used for the testing.
- (2) The vector signal generator is adjusted to provide the radar burst (18 pulses) at the level of approximately - 55.8dBm at the antenna of the master device.
- (3) A trigger is provided from the pulse generator to the DFS monitoring system in order to capture the traffic and the occurrence of the radar pulse.
- (4) EUT will associate with the master at channel. The file "iperf.exe" specified by the FCC is streamed from the PC 2 through the master and the client device to the PC 1 and played in full motion video using test software in order to properly load the network for the entire period of the test.
- (5) When radar burst with a Level equal to the DFS Detection Threshold +1dB is generated on the operating channel of the U-NII device. At time T0 the radar waveform generator sends a burst of pulse of the radar waveform at Detection threshold +1dB.
- (6) Observe the transmissions of the EUT at the end of the radar Burst on the Operating channel. Measure and record the transmissions from the UUT during The observation time (channel move time). One 15 seconds plot is reported for the short pulse radar type 0. The plot for the short pulse radar burst. The channel move time will be calculated based on the zoom in 600ms plot of the short pulse radar type.
- (7) Measurement of the aggregate duration of the channel closed transmission time method. With the spectrum analyzer set to zero span tuned to the center frequency of the EUT operating channel at the radar simulated frequency, peak detection, and max hold, the dwell time per bin is given by: $Dwell(3.0) = S(12000ms) / B(4000)$; where dwell time per spectrum analyzer sampling bin, S is sweep time and B is the number of spectrum analyzer sampling bins. An upper bound of the aggregate duration of the intermittent control signals of channel closing transmission time is calculated by: $C(ms) = N \times Dwell(0.3ms)$; where C is the closing time, N is the number of spectrum analyzer sampling bins (intermittent control signals) showing a U-NII transmission and dwell is the dwell time per bin.
- (8) Measurement the EUT for more than 30 minutes following the channel move time to verify that no transmission or beacons occur on this channel.

Test Setup:
Setup for client with injection at the master.

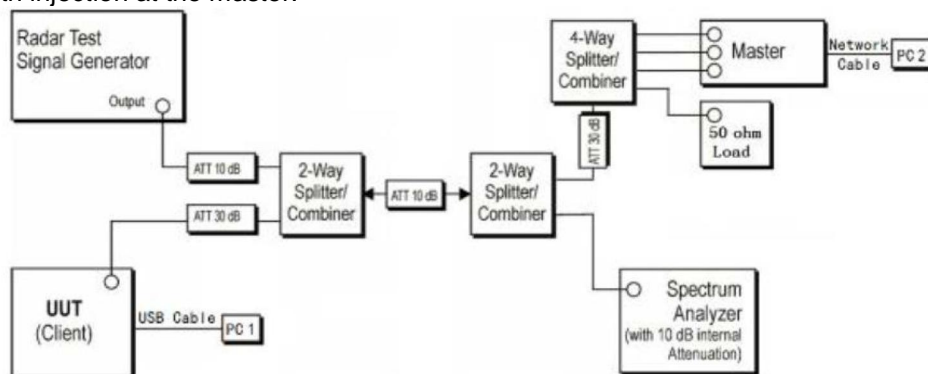

6、 Test Result

Clause	Test Parameter	Remarks	Pass/Fail
15.407	DFS Detection Threshold	No Applicable	N/A
15.407	Channel Availability Check time	No Applicable	N/A
15.407	Channel Move time	Applicable	Pass
15.407	Channel Closing Transmission Time	Applicable	Pass
15.407	Non-Occupancy Period	Applicable	Pass
15.407	Uniform Spreading	No Applicable	N/A
15.407	U-NII Detection Bandwidth	No Applicable	N/A

DFS Detection Threshold Test result:

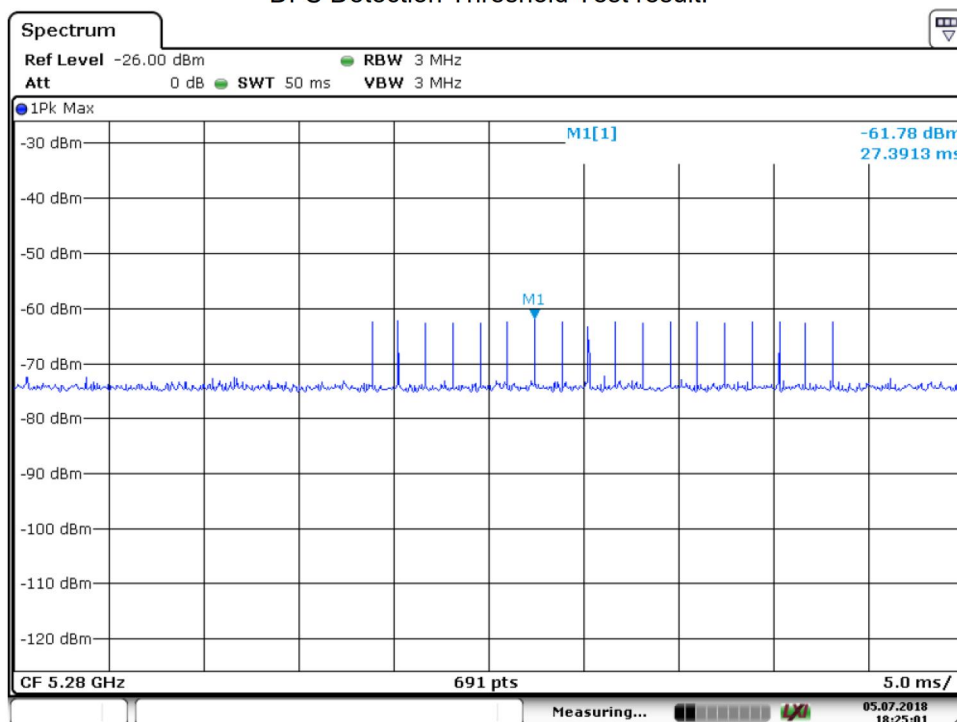

Test Result: Pass

7. Test Equipment List

Conducted Emission Test

Description	Manufacturer	Model no.	Serial no.	cal. due date
EMI Test Receiver	Rohde & Schwarz	ESR 3	101782	2020-6-28
LISN	Rohde & Schwarz	ENV4200	100249	2020-6-28
Attenuator	Shanghai Huaxiang	TS2-26-3	080928189	2020-6-28
Test software	Rohde & Schwarz	EMC32	Version9.15.00	N/A

Radiated Emission Test

DESCRIPTION	MANUFACTURER	MODEL NO.	SERIAL NO.	CAL. DUE DATE
Signal Analyzer	Rohde & Schwarz	FSV40	101031	2020-6-28
High Pass Filter (HPF)	UCL	UCL-BPF1-7G	1504005103	2020-6-28
Trilog Super Broadband Test Antenna	Schwarzbeck	VULB 9163	707	2020-6-29
Horn Antenna	Rohde & Schwarz	HF907	102295	2020-6-22
Wideband Horn Antenna	Q-PAR	QWH-SL-18-40-K-SG	12827	2020-7-12
Pre-amplifier	Rohde & Schwarz	SCU 18	102230	2020-6-28
Pre-amplifier	Rohde & Schwarz	SCU 40A	100432	2020-7-16
Attenuator	Agilent	8491A	MY39264334	2020-6-28
3m Semi-anechoic chamber	TDK	9X6X6	----	2020-7-7
Test software	Rohde & Schwarz	EMC32	Version 9.15.00	N/A

RF conducted test

DESCRIPTION	MANUFACTURER	MODEL NO.	SERIAL NO.	CAL. DUE DATE
Signal Analyzer	Rohde & Schwarz	FSV40	101030	2020-6-28
RF Switch Module	Rohde & Schwarz	OSP120/OSP-B157	101226/100851	2020-6-28
Power Splitter	Weinschel	1580	SC319	2020-7-7
Vector Signal Generator	Rohde & Schwarz	SMBV100A	262825	2020-6-28
RF Switch Module	Rohde & Schwarz	OSP120/OSP-B157	101226/100851	2020-7-6
Test software	Tonscend	System for BT/WIFI	Version 2.6	N/A

8. System Measurement Uncertainty

For a 95% confidence level, the measurement expanded uncertainties for defined systems, in accordance with the recommendations of ISO 17025 were:

System Measurement Uncertainty	
Test Items	Extended Uncertainty
Uncertainty for Conducted Emission 150kHz-30MHz (for test using AMN ENV432 or ENV4200)	3.62dB
Uncertainty for Radiated Spurious Emission 25MHz-3000MHz	Horizontal: 4.81dB; Vertical: 4.89dB;
Uncertainty for Radiated Spurious Emission 3000MHz-18000MHz	Horizontal: 4.69dB; Vertical: 4.68dB;
Uncertainty for Radiated Spurious Emission 18000MHz-40000MHz	Horizontal: 4.89dB; Vertical: 4.87dB;
Uncertainty for Conducted RF test with TS 8997	RF Power Conducted: 1.16dB Frequency test involved: 0.6×10^{-7} or 1%