

TEST REPORT

Applicant:	Guangde Ledup Enterprise, Inc.
Address of Applicant:	Jingtang Road, Guangde Economic Development Zone, Guangde, Anhui, China
Manufacturer:	Guangde Ledup Enterprise, Inc.
Address of Manufacturer:	Jingtang Road, Guangde Economic Development Zone, Guangde, Anhui, China
Product name:	Remote
Model:	10AR-2010B1, 10NAR-2010B1
Rating(s):	DC 3V battery
Trademark:	LEDUP
Standards:	47 CFR PART 15 Subpart C: section 15.249
FCC ID:	2AEBHAR2101B1
Data of Receipt:	2021-02-24
Date of Test:	2021-02-24~2021-03-03
Date of Issue:	2021-03-04
Test Result	Pass*

* In the configuration tested, the test item complied with the standards specified above.

Authorized for issue by:**Test by:**

Mar.04, 2021 Eleven Liang
Project Engineer



Date Name/Position Signature

Reviewed by:

Mar.04, 2021 Pauler Li
Project Engineer



Date Name/Position Signature

Possible test case verdicts:

test case does not apply to the test object ...: N/A
test object does meet the requirement: P (Pass)
test object does not meet the requirement ..: F (Fail)

Testing Laboratory information:

Testing Laboratory Name: ITL Co., LTD
Address.....: No.8, Jinqianling Street 5, Huangjiang, Dongguan,
Guangdong, China.
Testing location : Same as above
Tel : 0086-769-39001678
Fax : 0086-20-62824387
E-mail : itl@i-testlab.com

General remarks:

The test results presented in this report relate only to the object tested.

The results contained in this report reflect the results for this particular model and serial number. It is the responsibility of the manufacturer to ensure that all production models meet the intent of the requirements detailed within this report.

This report would be invalid test report without all the signatures of testing technician and approver.

This report shall not be reproduced, except in full, without the written approval of the Issuing testing laboratory.

Note:

The models 10AR-2010B1 and 10NAR-2010B1 are identical to each other except for the model name and function position of the keys.

All tests were performed on the model 10NAR-2010B1 as representative

1 Test Summary

Test	Test Requirement	Test method	Result
Antenna Requirement	FCC PART 15 C Section 15.203	FCC PART 15 C Section 15.203	PASS
Occupied Bandwidth	FCC PART 15 C section 15.215 (c)	ANSI C63.10:2013	PASS
Radiated Emission	FCC PART 15 C section 15.249 (a), (d)	ANSI C63.10:2013	PASS
Band Edges Measurement	FCC PART 15 C section 15.249 (d)	ANSI C63.10:2013	PASS
Conducted Emissions at Mains Terminals	FCC PART 15 C section 15.207	ANSI C63.10:2013	N/A

Note: The remote is powered by 3V batteries, the Conducted Emissions at Mains Terminals for 15.207 does not require testing.

2 Contents

	Page
TEST REPORT	1
1 TEST SUMMARY	3
2 CONTENTS	4
3 GENERAL INFORMATION	5
3.1 CLIENT INFORMATION	5
3.2 GENERAL DESCRIPTION OF E.U.T.	5
3.3 DETAILS OF E.U.T.	5
3.4 DESCRIPTION OF SUPPORT UNITS	5
3.5 TEST LOCATION	5
3.6 DEVIATION FROM STANDARDS	5
3.7 ABNORMALITIES FROM STANDARD CONDITIONS	5
3.8 OTHER INFORMATION REQUESTED BY THE CUSTOMER	5
3.9 TEST FACILITY	6
3.10 MEASUREMENT UNCERTAINTY	6
4 INSTRUMENTS USED DURING TEST	7
5 TEST RESULTS	8
5.1 E.U.T. TEST CONDITIONS	8
5.2 ANTENNA REQUIREMENT	10
5.3 OCCUPIED BANDWIDTH	11
5.4 RADIATED SPURIOUS EMISSIONS	14
5.4.1 Harmonic and other spurious emissions	19
5.5 BAND EDGES REQUIREMENT	23
5.6 CONDUCTED EMISSIONS AT MAINS TERMINALS 150 KHZ TO 30MHZ (N/A)	26

3 General Information

3.1 Client Information

Applicant: Guangde Ledup Enterprise, Inc.
Address of Applicant: Jingtang Road, Guangde Economic Development Zone, Guangde, Anhui, China

3.2 General Description of E.U.T.

Name: Remote
Model No.: 10NAR-2010B1
Trade Mark: LEDUP
Operating Frequency: 2402 MHz
Channel Separation: /
Type of Modulation: GFSK
Antenna Type: PIFA antenna
Antenna gain: 1 dBi

3.3 Details of E.U.T.

EUT Power Supply: DC 3V battery
Test mode: The program used to control the EUT for staying in continuous transmitting and receiving mode is programmed.
Power cord: /

3.4 Description of Support Units

The EUT has been tested as an independent unit for fixed frequency by testing lab.

3.5 Test Location

All tests were performed at:
ITL Co., Ltd.
No.8, JinQianLing street 5, DongHuan Road, Huangjiang Town, Dongguan, China.
0086-769-39001678
itl@i-testlab.com
No tests were sub-contracted.

3.6 Deviation from Standards

Biconical and log periodic antennas were used instead of dipole antennas.

3.7 Abnormalities from Standard Conditions

None.

3.8 Other Information Requested by the Customer

None.

3.9 Test Facility

The test facility is recognized, certified, or accredited by the following organizations:

- CNAS(Lab code:L9342)
- FCC (Resignation No.:CN5035)
- IC (Registration NO.:12593A)

3.10 Measurement Uncertainty

The below measurement uncertainties given below are based on a 95% confidence level (base on a coverage factor (k=2).)

Parameter	Uncertainty
Radio frequency	$\pm 1.06 \times 10^{-7}$
total RF power, conducted	1.37 dB
RF power density , conducted	2.89 dB
All emissions, radiated	± 3.35 dB
Temperature	± 0.23 °C
Humidity	± 0.3 %
DC and low frequency voltages	± 0.3 %

4 Instruments Used during Test

No.	Test Equipment	Manufacturer	Model	Serial No.	Last Cal.	Cal. Due
DGITL- 301	Semi-Anechoic chamber	ETS•Lindgren	9*6*6	CT000874-1181	2020.08.03	2022.08.03
DGITL- 307	EMI test receiver	R&S	ESVS10	833616 /003	2020.05.22	2021.05.22
DGITL- 306	Spectrum Analyzer	Agilent Technologies	N9010A	MY54200334	2020.05.22	2021.05.22
DGITL- 352	Pre Amplifier	MInI-CIrcuits	ZFC-1000HX	SN292801110	2020.05.22	2021.05.22
DGITL-375	Spectrum Analyzer	SCHWARZBECK	FSV40-N	6625-01-588-5515	2020.05.22	2021.05.22
DGITL-309	Horn Antenna	ETS Lindgren	3117	SN00152265	2020.07.04	2022.07.03
DGITL-363	Active Loop Antenna	SCHWARZBECK	FMZB 1519B	062	2020.07.04	2022.07.03
DGITL-308	Bilog Antenna	ETS• Lindgren	3142E	156975	2020.06.19	2022.06.19
DGITL-350	Wideband Amplifier Super Ultra	MInI-CIrcuits	ZVA-183X-S+	SN986401426	2020.05.22	2021.05.22

5 Test Results

5.1 E.U.T. test conditions

Test Voltage: DC 3V

Temperature: 23.2 -25.0 °C

Humidity: 38-50 % RH

Atmospheric Pressure: 1000 -1010 mbar

Requirements: **15.31(e):** For intentional radiators, measurements of the variation of the input power or the radiated signal level of the fundamental frequency component of the emission, as appropriate, shall be performed with the supply voltage varied between 85% and 115% of the nominal rated supply voltage. For battery operated equipment, the equipment tests shall be performed using a new battery.

15.32: Power supplies and CPU boards used with personal computers and for which separate authorizations are required to be obtained shall be tested as follows: Testing shall be in accordance with the procedures specified in Section 15.31 of this part.

Test frequencies and frequency range:

According to the 15.31(m) Measurements on intentional radiators or receivers, other than TV broadcast receivers, shall be performed and, if required, reported for each band in which the device can be operated with the device operating at the number of frequencies in each band specified in the following table:

According to the 15.33 (a) For an intentional radiator, the spectrum shall be investigated from the lowest radio frequency signal generated in the device, without going below 9 kHz, up to at least the frequency shown in the following table:

Number of fundamental frequencies to be tested in EUT transmit band

Frequency range in which	Number of	Location in frequency range
1 MHz or less	1	Middle
1 MHz	2	1 near top and 1 near bottom
More than 10 MHz	3	1 near top, 1 near middle and 1 near bottom

Frequency range of radiated emission measurements

Lowest frequency generated	Upper frequency range of measurement
9 kHz to below 10 GHz	10th harmonic of highest fundamental frequency or to 40 GHz,
At or above 10 GHz to below	5th harmonic of highest fundamental frequency or to 100 GHz,
At or above 30 GHz	5th harmonic of highest fundamental frequency or to 200 GHz,

EUT channels and frequencies list:

channel	Frequency
1	2402

Test frequencies are channel: 2402MHz

Test the EUT in continuous transmission mode, duty cycle > 98%.

5.2 Antenna requirement

Standard requirement

15.203 requirement:

For intentional device. According to 15.203. An intentional radiator shall be designed to ensure that no antenna other than that furnished by the responsible party shall be used with the device.

EUT Antenna

The antenna is a PIFA antenna and no consideration of replacement. The best case gain of the antenna is 1 dBi.

Test result: The unit does meet the FCC requirements.

5.3 Occupied Bandwidth

- Test Requirement: FCC PART 15 C section 15.215(c)
- (c) Intentional radiators operating under the alternative provisions to the general emission limits, as contained in §§ 15.217 through 15.257 and in subpart E of this part, must be designed to ensure that the 20 dB bandwidth of the emission, or whatever bandwidth may otherwise be specified in the specific rule section under which the equipment operates, is contained within the frequency band designated in the rule section under which the equipment is operated
- Test Method: ANSI C63.10:2013
- Test Status: Pre-Scan has been conducted to determine the worst-case mode from all possible combinations between available modulations, channels and antenna ports (if EUT with antenna diversity architecture). Following channel(s) was (were) selected for the final test as listed below.

Test Configuration:

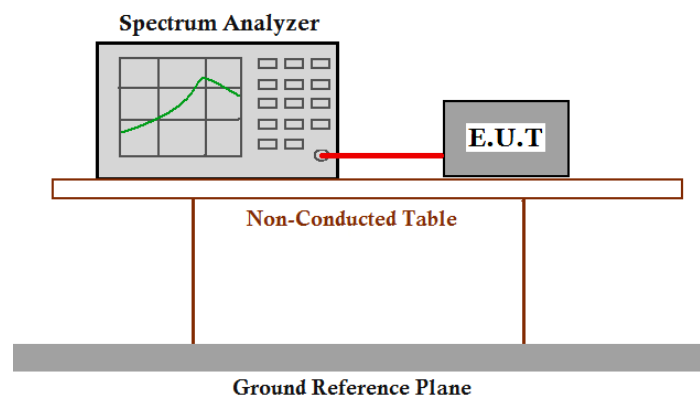

Test Procedure:

1. Remove the antenna from the EUT and then connect a low attention attenuation RF cable (Cable loss =0.5dB) from the antenna port to the spectrum.
 - a) The instrument center frequency was set to the nominal EUT channel center frequency. The frequency span for the spectrum analyzer was between 1.5 times and 5.0 times the OBW(20 dB Bandwidth).
 - b) The nominal IF filter bandwidth (3 dB RBW) was in the range of 1% to 5% of the OBW, and VBW was approximately three times the RBW.
 - c) Set the reference level of the instrument as required, keeping the signal from exceeding the maximum input mixer level for linear operation. In general, the peak of the spectral

envelope was more than $[10 \log (OBW/RBW)]$ below the reference level.

d) Step a) through step c) might require iteration to adjust within the specified range.

e) The dynamic range of the instrument at the selected RBW was more than 10 dB below the target “-20 dB down” requirement; that is, if the requirement calls for measuring the -20 dB OBW, the instrument noise floor at the selected RBW was at least 30 dB below the reference value.

f) Peak detection and max hold mode (until the trace stabilizes) was used.

g) Used the 20dB bandwidth function of the instrument and reported the measured bandwidth.

h) The occupied bandwidth was reported by providing plot(s) of the measuring instrument display; the plot axes and the scale units per division was clearly labeled. Tabular data was reported in addition to the plot(s).

20 dB bandwidth:

Channel No.	Frequency (MHz)	Measured 20dB bandwidth (MHz)	Limit	Result
1	2402	2.237	2400-2483.5 MHz	Pass

20dB bandwidth:

Result plot as follows:

Channel 1:2.402GHz:

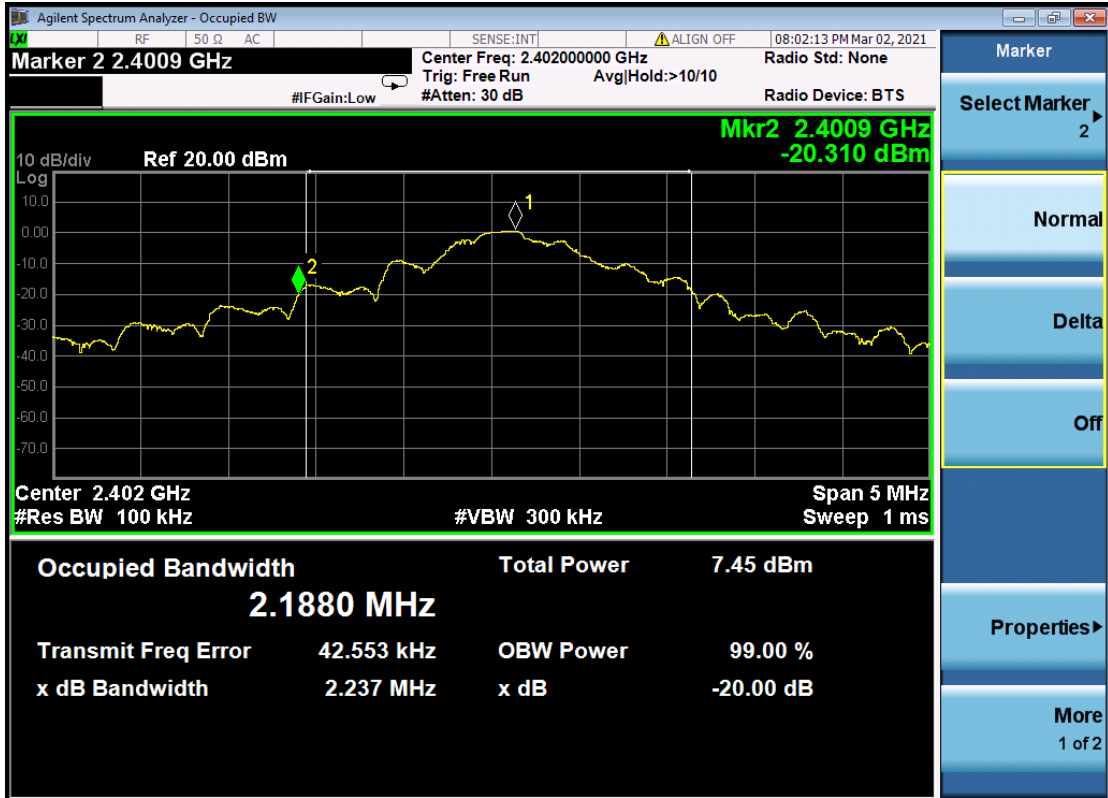

5.4 Radiated Spurious Emissions

Test Requirement: FCC PART 15 C section 15.249 (a), (d)
 (a) Except as provided in paragraph (b) of this section, the field strength of emissions from intentional radiators operated within these frequency bands shall comply with the following:

Fundamental Frequency (MHz)	Field Strength of Fundamental (dB μ V/m @ 3m)	Field Strength of Harmonics (dB μ V/m @ 3m)
902 to 928	94.0	54.0
2400 to 2483.5	94.0	54.0
5725 to 5875	94.0	54.0

Note: The limits shown in the above table are based on measurements using an average detector, except for the fundamental emission in the frequency band 902-928 MHz, which is based on measurements using a CISPR quasi-peak detector.

(d) Emissions radiated outside of the specified frequency bands, except for harmonics, shall be attenuated by at least 50 dB below the level of the fundamental or to the general radiated emission limits in § 15.209, whichever is the lesser attenuation.

Test Method: ANSI C63.10:2013 Clause 6.4, 6.5 and 6.6

Test Status: Pre-Scan has been conducted to determine the worst-case mode from all possible combinations between available modulations, channels and antenna ports (if EUT with antenna diversity architecture). Following channel(s) was (were) selected for the final test as listed below.

Detector: For PK value:

RBW = 1 MHz for $f \geq 1$ GHz, 100 kHz for $f < 1$ GHz

VBW \geq RBW

Sweep = auto

Detector function = peak

Trace = max hold

15.209 Limit: 40.0 dB μ V/m between 30MHz & 88MHz
 43.5 dB μ V/m between 88MHz & 216MHz
 46.0 dB μ V/m between 216MHz & 960MHz
 54.0 dB μ V/m above 960MHz

The average correction factor was computed by analyzing the on time in 100ms over one complete pulse train. Analysis of the remote transmitter on time in one complete pulse train, therefore the average value of fundamental frequency was: Average = Peak value + 20log

(Duty cycle), where the duty factor is calculated from following formula:

The duration of one cycle =0.36ms

Effective period of the cycle =8.96ms

DC =0.36/8.96=0.0402 or 4.02%

Therefore, the averaging factor is found by $20\lg 0.0402 = -27.92$

Please refer to below plots for more details.

Retest on all keys ,found that the worst case result was the “on” Key

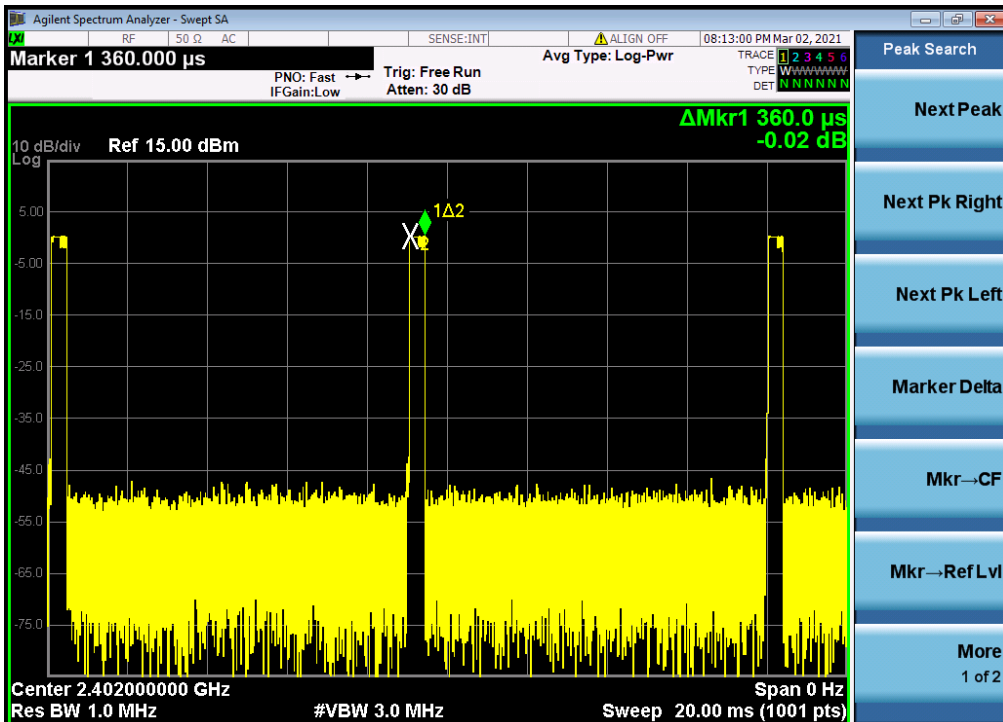
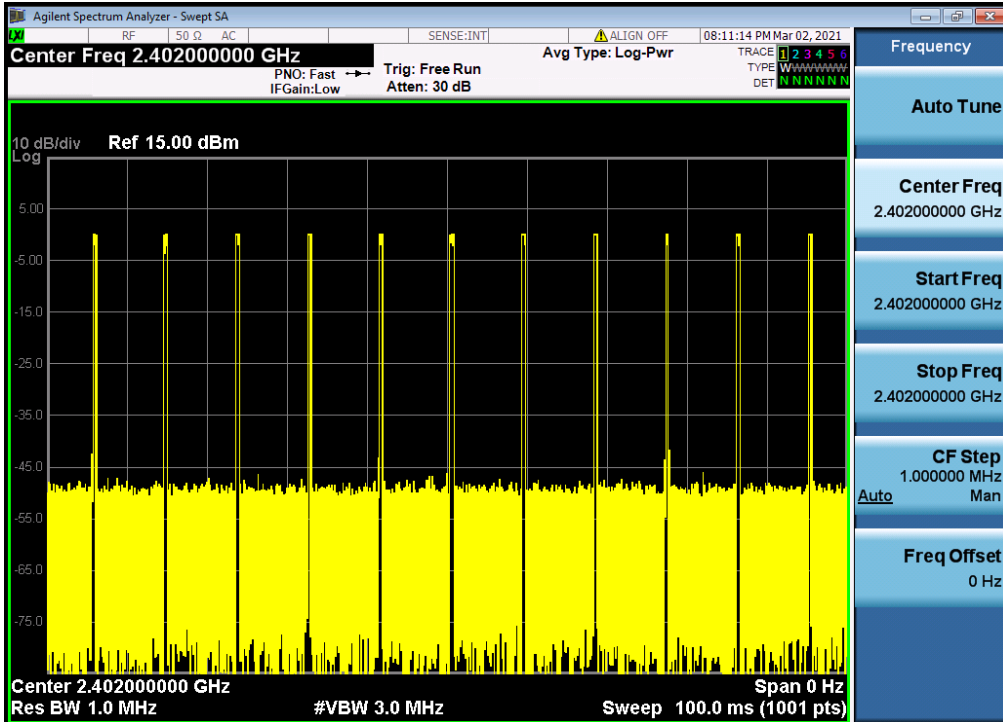

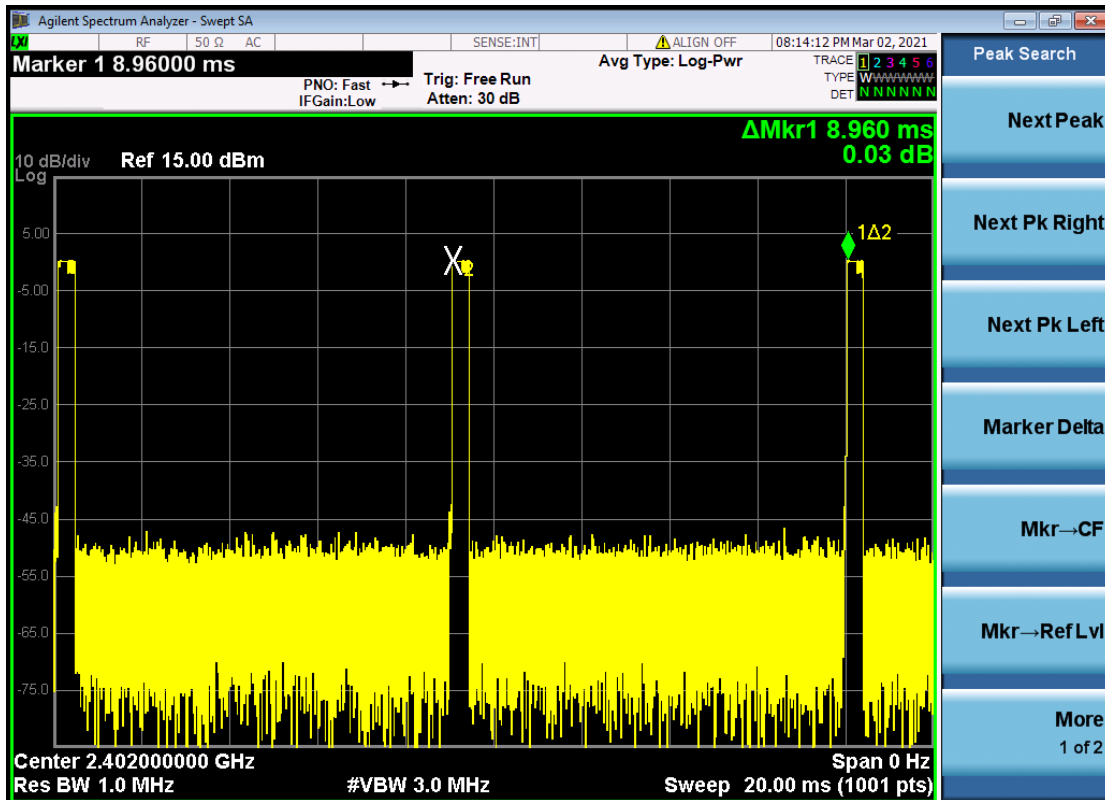

Section 15.205 Restricted bands of operation.

MHz	MHz	MHz	GHz
0.090 - 0.110	16.42 - 16.423	399.9 - 410	4.5 - 5.15
10.495 - 0.505	16.69475 - 16.69525	608 - 614	5.35 - 5.46
2.1735 - 2.1905	16.80425 - 16.80475	960 - 1240	7.25 - 7.75
4.125 - 4.128	25.5 - 25.67	1300 - 1427	8.025 - 8.5
4.17725 - 4.17775	37.5 - 38.25	1435 - 1626.5	9.0 - 9.2
4.20725 - 4.20775	73 - 74.6	1645.5 - 1646.5	9.3 - 9.5
6.215 - 6.218	74.8 - 75.2	1660 - 1710	10.6 - 12.7
6.26775 - 6.26825	108 - 121.94	1718.8 - 1722.2	13.25 - 13.4
6.31175 - 6.31225	123 - 138	2200 - 2300	14.47 - 14.5
8.291 - 8.294	149.9 - 150.05	2310 - 2390	15.35 - 16.2
8.362 - 8.366	156.52475 -	2483.5 - 2500	17.7 - 21.4
8.37625 - 8.38675	156.52525	2655 - 2900	22.01 - 23.12
8.41425 - 8.41475	156.7 - 156.9	3260 - 3267	23.6 - 24.0
12.29 - 12.293	162.0125 - 167.17	3332 - 3339	31.2 - 31.8
12.51975 - 12.52025	167.72 - 173.2	3345.8 - 3358	36.43 - 36.5
12.57675 - 12.57725	240 - 285	3600 - 4400	
13.36 - 13.41	322 - 335.4		

Test Configuration:

1) 9kHz to 30MHz emissions:

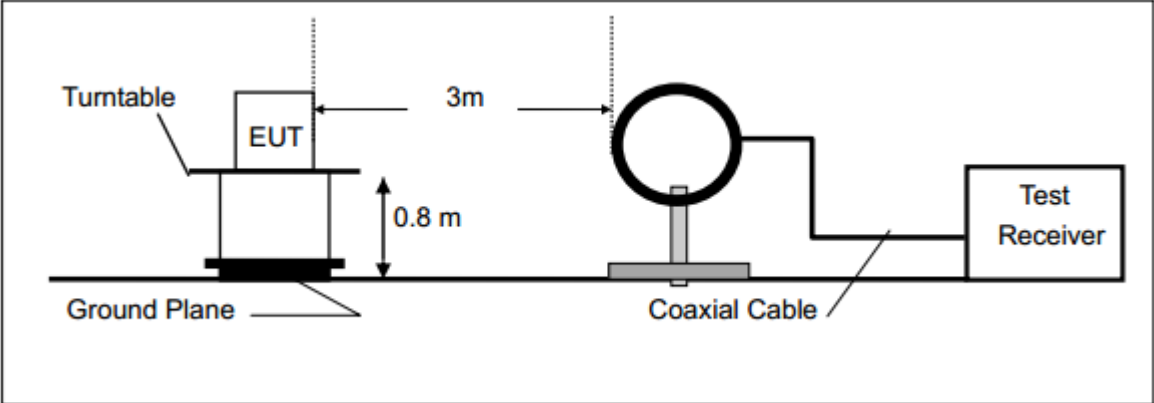

2) 30 MHz to 1 GHz emissions:

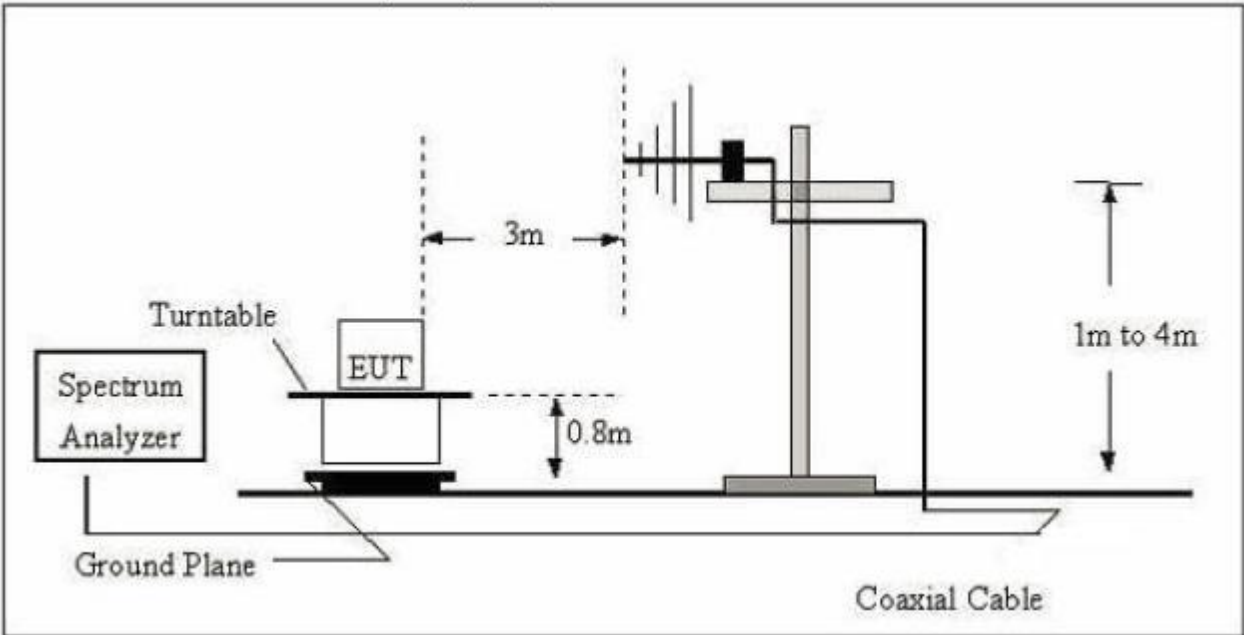

3) 1 GHz to 40 GHz emissions:

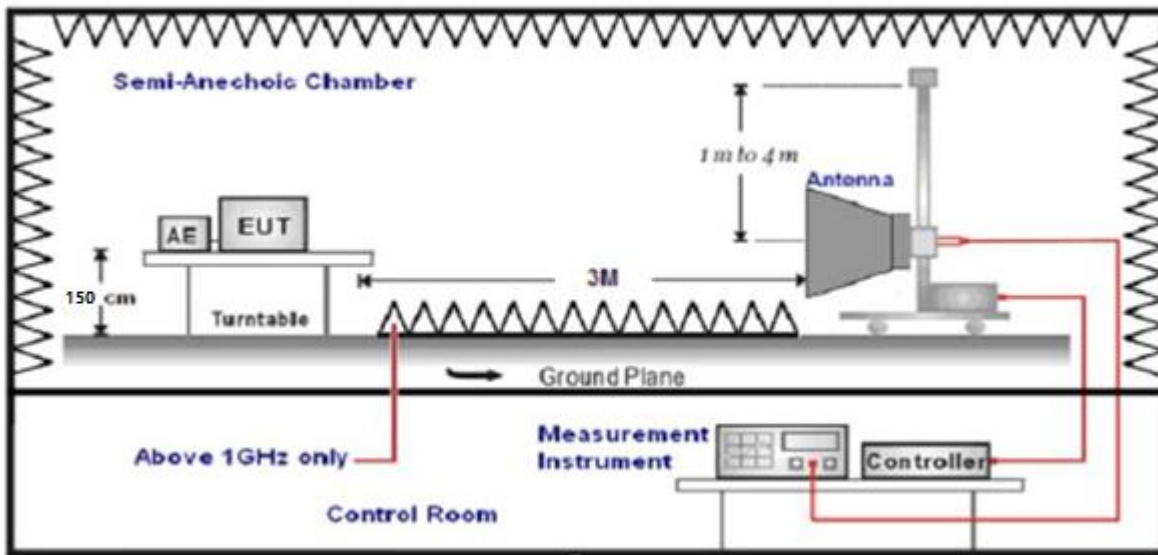
**Test Procedure:**

1) 9 kHz to 30 MHz emissions:

For testing performed with the loop antenna. The centre of the loop was positioned 1 m above the ground and positioned with its plane vertical at the special distance from the EUT. During testing the loop was rotated about its vertical axis for maximum response at each azimuth and also investigated with the loop positioned in the horizontal plane.

2) 30 MHz to 1 GHz emissions:

For testing performed with the bi-log type antenna. The measurement is performed with the EUT rotated 360°, the antenna height scanned between 1m and 4m, and the antenna rotated to repeat the measurement for both the horizontal and vertical antenna polarizations.

3) 1 GHz to 25 GHz emissions:

Test site with RF absorbing material covering the ground plane that met the site validation criterion called out in CISPR 16-1-4:2010 was used to perform radiated emission test above 1 GHz.

For testing performed with the horn antenna. The measurement is performed with the EUT rotated 360°, the antenna height scanned between 1m and 4m, and the antenna rotated to repeat the measurement for both the horizontal and vertical antenna polarizations.

4) The receiver was scanned from 9 kHz to 25 GHz. When an emission was found, the table was rotated to produce the maximum signal strength. An initial pre-scan was performed for in peak detection mode using the receiver. The EUT was measured for both the Horizontal and Vertical polarities and performed a pre-test three orthogonal planes. For intentional radiators, measurements of the variation of the input power or the radiated signal level of the fundamental frequency component of the emission, as appropriate, shall be performed with the supply voltage varied between 85% and 115% of the nominal rated supply voltage. The worst case emissions were reported.

The measurements with active loop antenna were greater than 20dB below the limit, so the test data were not recorded in the test report.

5.4.1 Harmonic and other spurious emissions

Test at Channel 1 (2.402 GHz) in transmitting status

9kHz~30MHz Test result

The Low frequency, which started from 9kHz to 30MHz, was pre-scanned and the result which was 20dB lower than the limit line per 15.31(o) was not report

30 MHz~1 GHz Spurious Emissions .Quasi-Peak Measurement

Horizontal:

Peak scan

Level (dBμV/m)

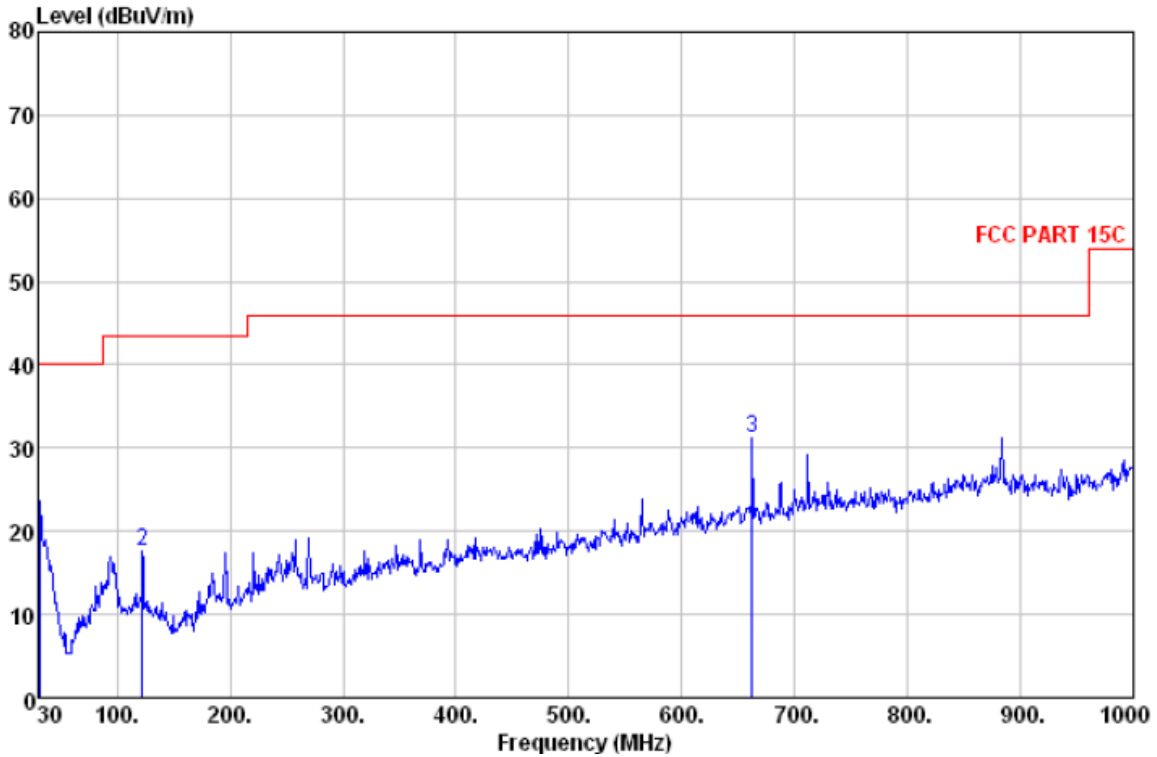

Quasi-peak measurement

No.	Freq MHz	Read Level dBuV	Antenna Factor dB	Cable Loss dB	Preamp Factor dB	Level dBuV/m	Limit Line dBuV/m	Over Limit dB	Pol/ Phase	Remark
1	30.970	25.00	26.59	0.64	28.52	23.71	40.00	-16.29	HORIZONTAL	QP
2	122.150	31.47	13.37	1.31	28.48	17.67	43.50	-25.83	HORIZONTAL	QP
3	662.440	34.75	21.64	3.23	28.50	31.12	46.00	-14.88	HORIZONTAL	QP

Level=Read Level + Antenna Factor + Cable Loss - Preamp Factor

Vertical:

Peak scan

Level (dBμV/m)

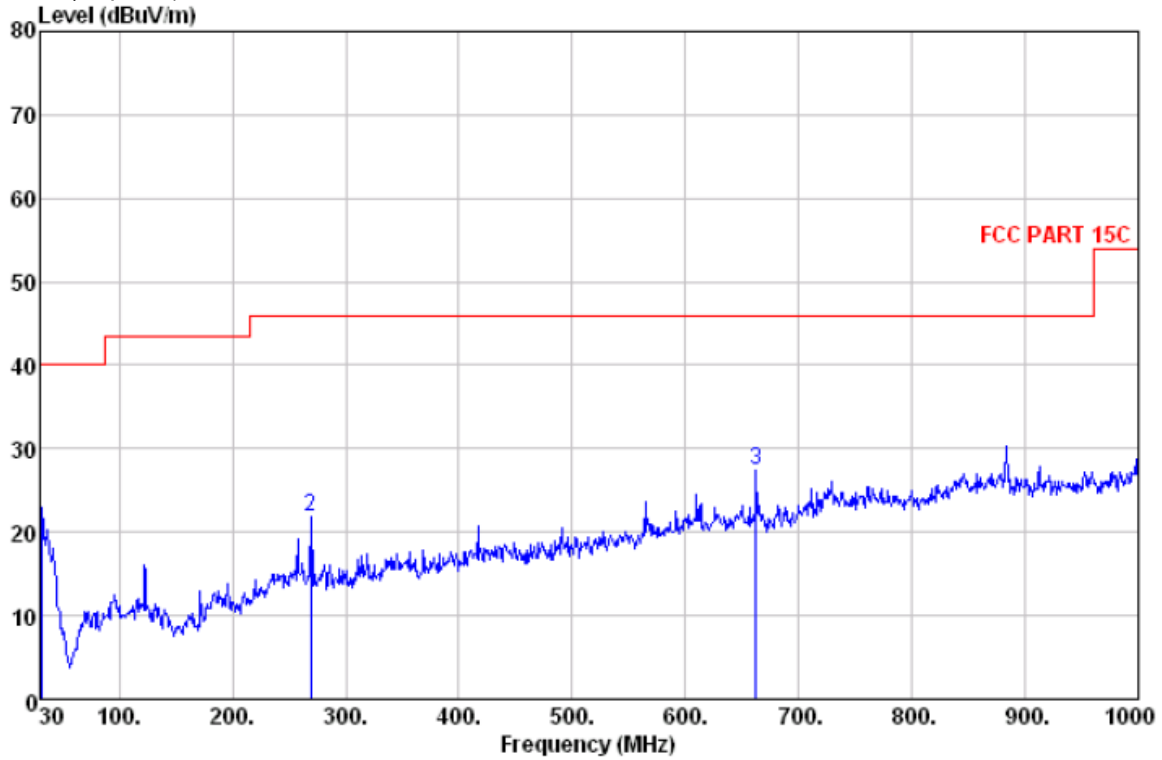

Quasi-peak measurement

No.	Freq MHz	Read Level dBμV	Antenna Factor dB	Cable Loss dB	Preamp Factor dB	Level dBμV/m	Limit Line dBμV/m	Over Limit dB	Pol/ Phase	Remark
1	30.970	24.31	26.59	0.64	28.52	23.02	40.00	-16.98	VERTICAL	QP
2	269.590	31.45	15.50	2.01	27.22	21.74	46.00	-24.26	VERTICAL	QP
3	662.440	31.10	21.64	3.23	28.50	27.47	46.00	-18.53	VERTICAL	QP

Level=Read Level + Antenna Factor + Cable Loss - Preamp Factor

Above 1G

Horizontal:

Peak scan

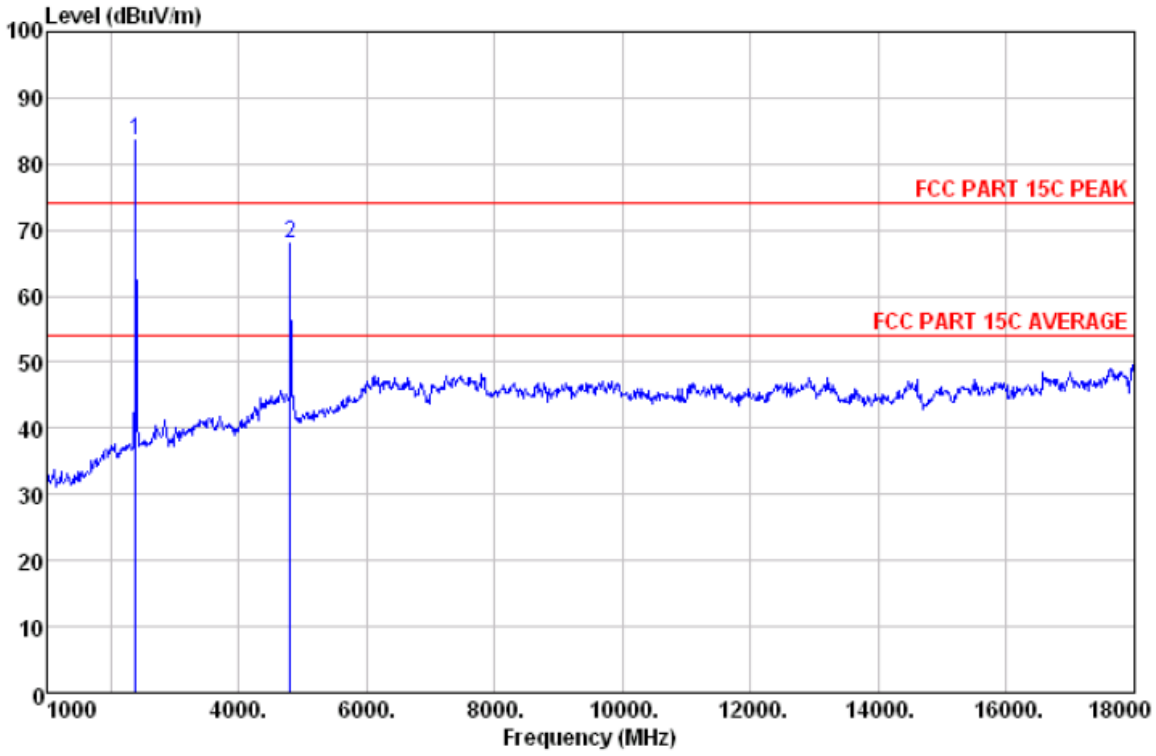

No.	Frequency (MHz)	Reading Level (dBuV)	Correct (dB/m)	Duty cycle Factor (dB)	Level (dBμV/m)	Limit (dBμV/m)	Margin (dB)	Antenna polarization	Remark
1	2402	83.29	0.16	N/A	83.45	114.00	-30.55	H	Peak
				-27.92	55.53	94.00	-38.47	H	AV
2	4804	62.30	5.73	N/A	68.03	74.00	-5.97	H	Peak
				-27.92	40.11	54.00	-13.89	H	AV

Vertical:

Peak scan

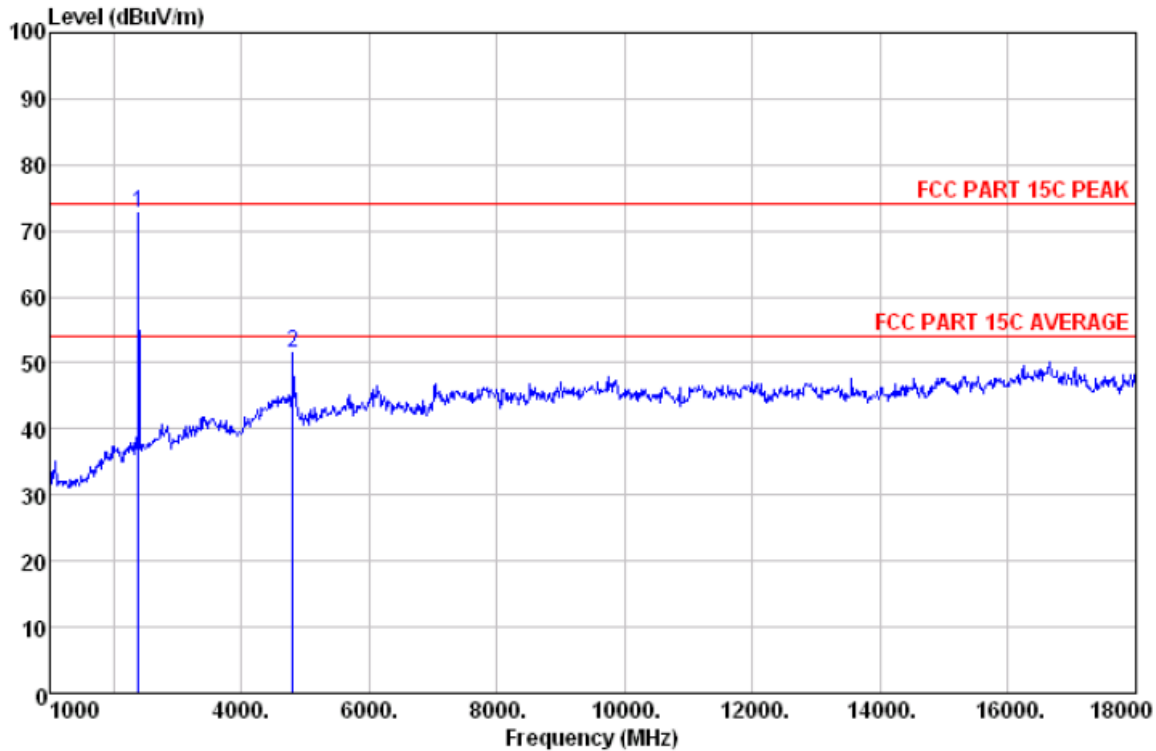

No.	Frequency (MHz)	Reading Level (dBUV)	Correct (dB/m)	Duty cycle Factor (dB)	Level (dBµV/m)	Limit (dBµV/m)	Margin (dB)	Antenna polarization	Remark
1	2402	66.18	6.61	N/A	72.79	114.00	-41.21	V	Peak
				-27.92	44.87	94.00	-49.13	V	AV
2	4804	36.21	15.30	N/A	51.52	74.00	-22.48	V	Peak
				-27.92	23.60	54.00	-30.40	V	AV

Remark:

- 1) .For this intentional radiator operates below 25 GHz. The spectrum shall be investigated to the tenth harmonics of the highest fundamental frequency. And above the third harmonic of this intentional radiator, the disturbance is very low. So the test result only displays to 3rd harmonic.
- 2). As shown in Section, for frequencies above 1000 MHz. the above field strength limits are based on average limits. However, the peak field strength of any emission shall not exceed the maximum permitted average limits specified above by more than 20 dB under any condition of modulation.
- 3). The test only perform the EUT in transmitting status since the test frequencies were over 1GHz only required transmitting status.

Test result: The unit does meet the FCC requirements.

5.5 Band Edges Requirement

Test Requirement:	FCC Part 15 C section 15.249 (d) Emissions radiated outside of the specified frequency bands, except for harmonics, shall be attenuated by at least 50 dB below the level of the fundamental or to the general radiated emission limits in § 15.209, whichever is the lesser attenuation.
Frequency Band:	2400 MHz to 2483.5 MHz
Test Method:	ANSI C63.10:2013
Test Status:	Pre-Scan has been conducted to determine the worst-case mode from all possible combinations between available modulations, channels and antenna ports (if EUT with antenna diversity architecture). Following channel(s) was (were) selected for the final test as listed below.
Test Configuration:	

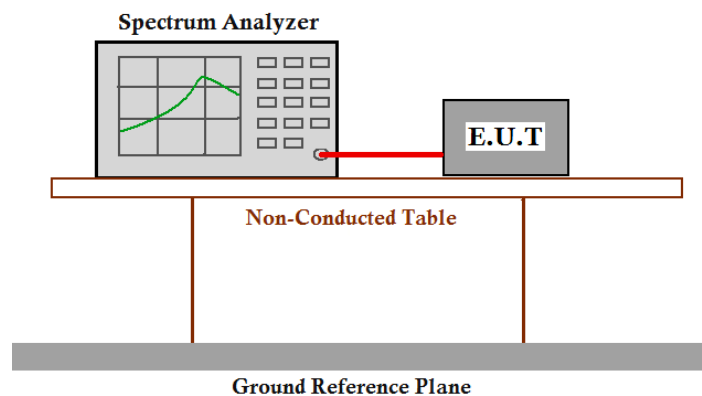

Result plot as follows:

Channel 1: 2.402 GHz

Horizontal:

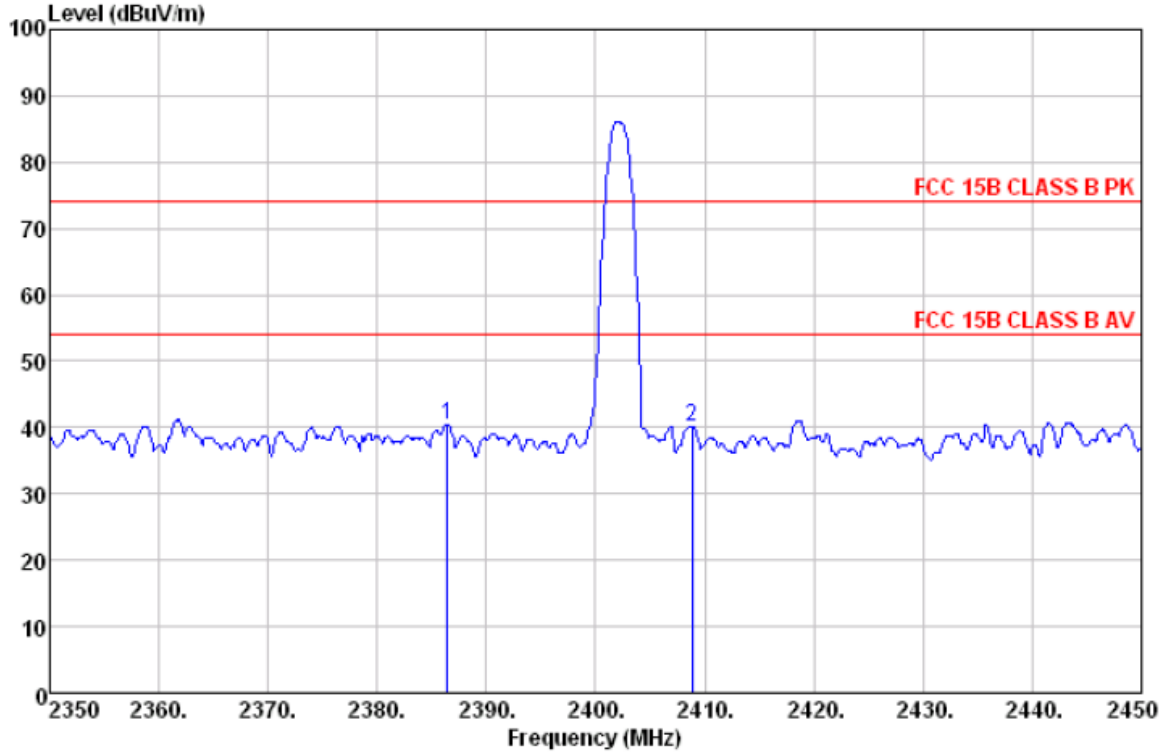

Frequency (MHz)	Reading Level (dBuV)	Meas. Time (ms)	Bandwidth (kHz)	Correct (dB/m)	Level (dBμV/m)	Limit (dBμV/m)	Margin (dB)	Antenna polarizatio n	Remark
2386.4	33.85	1000	1000	6.61	40.46	74	-33.54	H	Peak
2408.8	33.59	1000	1000	6.64	40.23	74	-33.77	H	Peak

Vertical:

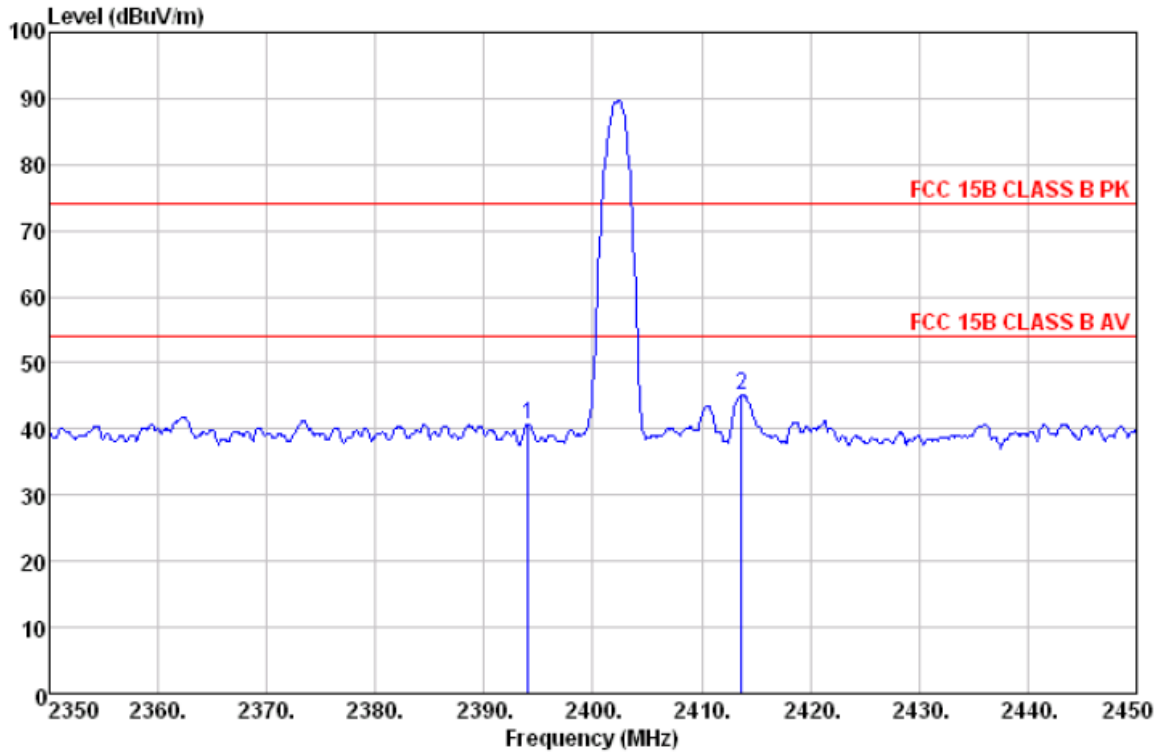

Frequency (MHz)	Reading Level (dBuV)	Meas. Time (ms)	Bandwidth (kHz)	Correct (dB/m)	Level (dBμV/m)	Limit (dBμV/m)	Margin (dB)	Antenna polarization	Remark
2394.0	34.10	1000	1000	6.22	40.32	74	-33.68	V	Peak
2413.7	38.45	1000	1000	6.64	45.09	74	-28.91	V	Peak

5.6 Conducted Emissions at Mains Terminals 150 kHz to 30MHz (N/A)

Test Requirement: FCC Part 15 C section 15.207

Test Method: ANSI C63.10:2013

Frequency Range: 150 kHz to 30 MHz

Detector: Peak for pre-scan (9 kHz Resolution Bandwidth)

Test Limit

Limits for conducted disturbance at the mains ports of class B

Frequency Range	Class B Limit dB(μ V)	
	Quasi-peak	Average
0.15 to 0.50	66 to 56	56 to 46
0.50 to 5	56	46
5 to 30	60	50

NOTE 1 The limit decreases linearly with the logarithm of the frequency in the range 0,15 MHz to 0,50 MHz.

-- End of test report --