

# **FCC RADIO TEST REPORT**

## **FCC ID:2AEB5M691**

**Product** : Tablet PC

**Trade Name** : AOC

**Model Number** : M691

**Serial Model** : N/A

**Report No.** : ISOT15031102R2

### **Prepared for**

AOC

8F-3, No. 166, Jian 1st Rd., Zhonghe Dist., New Taipei City 23511, Taiwan

### **Prepared by**

Shenzhen ISOTek Standards Technical Services Co.,Ltd.

13/F, HuaFengRui Building, XinHu Rd., XiXiang, Bao'an  
District,Shenzhen,China

Tel.: +86-755- 23087378 Fax.: +86-755-23087278

[Http://www.ISOTek.com.cn](http://www.ISOTek.com.cn)

### TEST RESULT CERTIFICATION

**Applicant's name** ..... AOC

Address ..... 8F-3, No. 166, Jian 1st Rd., Zhonghe Dist., New Taipei City 23511, Taiwan

**Manufacture's Name**... AOC

Address ..... 8F-3, No. 166, Jian 1st Rd., Zhonghe Dist., New Taipei City 23511, Taiwan

**Product description**

Product name ..... Tablet PC

Model and/or type reference ..... M691

Serial Model ..... N/A

**Standards** ..... FCC Part15.247: 01 Oct. 2014

Test procedure ..... ANSI C63.4-2009 and KDB 558074:June 5, 2014

This device described above has been tested by Shenzhen ISOTek, and the test results show that the equipment under test (EUT) is in compliance with the FCC requirements. And it is applicable only to the tested sample identified in the report.

This report shall not be reproduced except in full, without the written approval of Shenzhen ISOTek, this document may be altered or revised by Shenzhen ISOTek, personal only, and shall be noted in the revision of the document.

**Date of Test** .....

Date (s) of performance of tests ..... 03 Mar. 2015 ~14 Mar. 2015

Date of Issue..... 14 Mar. 2015

Test Result..... **Pass**

Compiled by:

  
\_\_\_\_\_

Lisa Huang/ Project Engineer

Approved by:

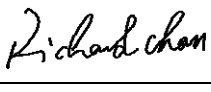
  
\_\_\_\_\_

Richard Chen/ Manager

## Table of Contents

	Page
<b>1 . SUMMARY OF TEST RESULTS</b>	<b>5</b>
1.1 TEST FACILITY	6
1.2 MEASUREMENT UNCERTAINTY	6
<b>2 . GENERAL INFORMATION</b>	<b>7</b>
2.1 GENERAL DESCRIPTION OF EUT	7
2.2 DESCRIPTION OF TEST MODES	9
2.3 BLOCK DIGRAM SHOWING THE CONFIGURATION OF SYSTEM TESTED	10
2.4 DESCRIPTION OF SUPPORT UNITS(CONDUCTED MODE)	11
2.5 EQUIPMENTS LIST FOR ALL TEST ITEMS	12
<b>3 . EMC EMISSION TEST</b>	<b>13</b>
3.1 CONDUCTED EMISSION MEASUREMENT	13
3.1.1 POWER LINE CONDUCTED EMISSION LIMITS	13
3.1.2 TEST PROCEDURE	14
3.1.3 DEVIATION FROM TEST STANDARD	14
3.1.4 TEST SETUP	14
3.1.5 EUT OPERATING CONDITIONS	14
3.1.6 TEST RESULTS	15
3.2 RADIATED EMISSION MEASUREMENT	17
3.2.1 RADIATED EMISSION LIMITS	17
3.2.2 TEST PROCEDURE	18
3.2.3 DEVIATION FROM TEST STANDARD	18
3.2.4 TEST SETUP	19
3.2.5 EUT OPERATING CONDITIONS	20
3.2.6 TEST RESULTS (BETWEEN 9KHZ – 30 MHZ)	21
3.2.7 TEST RESULTS (BETWEEN 30MHZ – 1GHZ)	22
3.2.8 TEST RESULTS (ABOVE 1000 MHZ)	24
<b>4 . POWER SPECTRAL DENSITY TEST</b>	<b>25</b>
4.1 APPLIED PROCEDURES / LIMIT	25
4.1.1 TEST PROCEDURE	25
4.1.2 DEVIATION FROM STANDARD	25
4.1.3 TEST SETUP	25
4.1.4 EUT OPERATION CONDITIONS	25
4.1.5 TEST RESULTS	26
<b>5 . BANDWIDTH TEST</b>	<b>34</b>
5.1 APPLIED PROCEDURES / LIMIT	34
5.1.1 TEST PROCEDURE	34

**Table of Contents**

	<b>Page</b>
<b>TEST SETUP</b>	<b>34</b>
<b>5.1.2 EUT OPERATION CONDITIONS</b>	<b>34</b>
<b>5.1.3 TEST RESULTS</b>	<b>35</b>
<b>6 . PEAK OUTPUT POWER TEST</b>	<b>43</b>
<b>6.1 APPLIED PROCEDURES / LIMIT</b>	<b>43</b>
<b>6.1.1 TEST PROCEDURE</b>	<b>43</b>
<b>6.1.2 DEVIATION FROM STANDARD</b>	<b>43</b>
<b>6.1.3 TEST SETUP</b>	<b>43</b>
<b>6.1.4 EUT OPERATION CONDITIONS</b>	<b>43</b>
<b>6.1.5 TEST RESULTS</b>	<b>44</b>
<b>7 . 100 KHZ BANDWIDTH OF FREQUENCY BAND EDGE</b>	<b>45</b>
<b>7.1 DEVIATION FROM STANDARD</b>	<b>45</b>
<b>7.2 TEST SETUP</b>	<b>45</b>
<b>7.3 EUT OPERATION CONDITIONS</b>	<b>45</b>
<b>7.4 TEST RESULTS</b>	<b>46</b>
<b>8 . ANTENNA REQUIREMENT</b>	<b>52</b>
<b>8.1 STANDARD REQUIREMENT</b>	<b>52</b>
<b>8.2 EUT ANTENNA</b>	<b>52</b>

## 1. SUMMARY OF TEST RESULTS

Test procedures according to the technical standards:

<b>FCC Part15 (15.247) , Subpart C</b>			
Standard Section	Test Item	Judgment	Remark
15.207	Conducted Emission	PASS	
15.247 (a)(2)	6dB Bandwidth	PASS	
15.247 (b)	Peak Output Power	PASS	
15.247 (c)	Radiated Spurious Emission	PASS	
15.247 (d)	Power Spectral Density	PASS	
15.205	Band Edge Emission	PASS	
15.203	Antenna Requirement	PASS	

**NOTE:**

(1) "N/A" denotes test is not applicable in this Test Report

### 1.1 TEST FACILITY

All the tests were performed at:

Shenzhen Huance Wei Testing Lab at 10th Floor West Logistics Information Center Build, Shenzhen, China

Shenzhen Huance Wei Testing Lab, EMC Laboratory has been registered and fully described in a report filed with the (FCC) Federal Communications Commission. The acceptance letter from the FCC is maintained in our files. Registration **369037** , Nov 07, 2016.

### 1.2 MEASUREMENT UNCERTAINTY

The reported uncertainty of measurement  $y \pm U$  , where expanded uncertainty  $U$  is based on a standard uncertainty multiplied by a coverage factor of  $k=2$  , providing a level of confidence of approximately **95 %** .

No.	Item	Uncertainty
1	Conducted Emission Test	$\pm 1.38\text{dB}$
2	RF power,conducted	$\pm 0.16\text{dB}$
3	Spurious emissions,conducted	$\pm 0.21\text{dB}$
4	All emissions,radiated(<1G)	$\pm 4.68\text{dB}$
5	All emissions,radiated(>1G)	$\pm 4.89\text{dB}$
6	Temperature	$\pm 0.5^{\circ}\text{C}$
7	Humidity	$\pm 2\%$

## 2. GENERAL INFORMATION

### 2.1 GENERAL DESCRIPTION OF EUT

Equipment	Tablet PC	
Trade Name	AOC	
Model Name	M691	
Serial Model	N/A	
Model Difference	N/A	
Product Description	The EUT is a Tablet PC	
	Operation Frequency:	802.11b/g/n(20MHz): 2412~2462MHz 802.11n(40MHz):2422~2452MHz
	Modulation Type:	CCK/OFDM/DBPSK/DAPSK
	Bit Rate of Transmitter	802.11b:11/5.5/2/1 Mbps 802.11g:54/48/36/24/18/12/9/6Mbps 802.11n(20MHz/40MHz):150/144.44/130/117/115.56/104/86.67/78/52/6.5Mbps
	Number Of Channel	802.11b/g/n20MHz:11CH 802.11n40MHz:7CH
	Antenna Designation:	Please see Note 3.
	Antenna Gain (dBi)	1.0 dBi
Channel List	Please refer to the Note 2.	
Ratings	DC 5V,1.5A	
Adapter	Model:XHY050150UUCH, Input: 100-240V~,50/60Hz Output: 5.0V $\overline{\text{---}}$ , 1.5A	
Battery	DC3.7V, 2800mAh	
Connecting I/O Port(s)	Please refer to the User's Manual	
Software version :	Android 4.2.2	
Hardware version :	MOLY.WR8.W1315.MD.WG.MP.V35.P2	

Note:

1. For a more detailed features description, please refer to the manufacturer's specifications or the User's Manual.

2.

Channel List for 802.11b/g/n(20 MHz)							
Channel	Frequency (MHz)	Channel	Frequency (MHz)	Channel	Frequency (MHz)	Channel	Frequency (MHz)
01	2412	04	2427	07	2442	10	2457
02	2417	05	2432	08	2447	11	2462
03	2422	06	2437	09	2452		

Channel List for 802.11n(40MHz)							
Channel	Frequency (MHz)	Channel	Frequency (MHz)	Channel	Frequency (MHz)	Channel	Frequency (MHz)
03	2422	06	2437	09	2452		
04	2427	07	2442				
05	2432	08	2447				

3.

Table for Filed Antenna

Ant	Brand	Model Name	Antenna Type	Connector	Gain (dBi)	NOTE
A	N/A	N/A	FPCB Antenna	N/A	1.0	Wifi Antenna



## 2.2 DESCRIPTION OF TEST MODES

To investigate the maximum EMI emission characteristics generates from EUT, the test system was pre-scanning tested base on the consideration of following EUT operation mode or test configuration mode which possible have effect on EMI emission level. Each of these EUT operation mode(s) or test configuration mode(s) mentioned above was evaluated respectively.

Pretest Mode	Description
Mode 1	802.11b CH1/ CH6/ CH11
Mode 2	802.11g CH1/ CH6/ CH11
Mode 3	802.11n/20MHz CH1/ CH6/ CH11
Mode 4	802.11n/40MHz CH3/ CH6/ CH9
Mode 5	Link Mode

For Conducted Emission	
Final Test Mode	Description
Mode 5	Link Mode

For Radiated Emission	
Final Test Mode	Description
Mode 1	802.11b CH1/ CH6/ CH11
Mode 2	802.11g CH1/ CH6/ CH11
Mode 3	802.11n/20MHz CH1/ CH6/ CH11
Mode 4	802.11n/40MHz CH3/ CH6/ CH9

Note:

- (1) The measurements are performed at the highest, middle, lowest available channels.
- (2) The measurements are performed at all Bit Rate of Transmitter, the worst data was reported
- (3) EUT configured to transmit continuously:
- (4) All 3-axis of the EUT have been investigated and only worst case(Y)reported.

Operated Mode for Worst Duty Cycle	
Test Signal Duty Cycle (x)	Average correction factor (dB)
100% - IEEE 802.11b	0
100% - IEEE 802.11g	0
100% - IEEE 802.11n (HT20)	0
100% - IEEE 802.11n (HT40)	0

**2.3 BLOCK DIGRAM SHOWING THE CONFIGURATION OF SYSTEM TESTED**

Conducted Emission Test

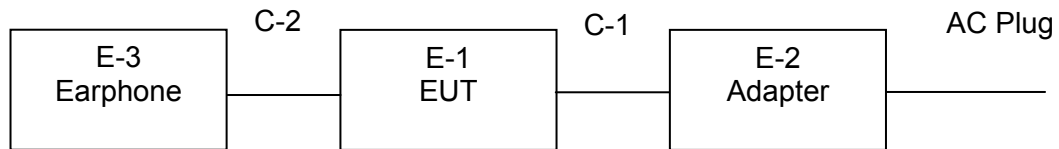

Radiated Spurious Emission Test

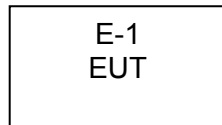

**2.4 DESCRIPTION OF SUPPORT UNITS(CONDUCTED MODE)**

The EUT has been tested as an independent unit together with other necessary accessories or support units. The following support units or accessories were used to form a representative test configuration during the tests.

Item	Equipment	Brand	Model/Type No.	Series No.	Note
E-1	Tablet PC	N/A	M691	N/A	EUT
E-2	Adapter	N/A	XHY050150UUCH		
E-3	Earphone	N/A	2688		

Item	Shielded Type	Ferrite Core	Length	Note
C-1	NO	NO	0.8m	
C-2	NO	NO	1.2m	

Note:

- (1) The support equipment was authorized by Declaration of Confirmation.
- (2) For detachable type I/O cable should be specified the length in cm in 『Length』 column.

**2.5 EQUIPMENTS LIST FOR ALL TEST ITEMS**

## Radiation Test equipment

Item	Kind of Equipment	Manufacturer	Type No.	Serial No.	Last calibration	Calibrated until	Calibration period
1	Spectrum Analyzer	Aglient	E4446A	US44300451	2014.07.06	2015.07.05	1 year
2	EMI Test Receiver	R&S	ESCI	101165	2014.06.07	2015.06.06	1 year
3	Bilog Antenna	Schwarzbeck	VULB 9168	VULB9168 - 438	2014.07.06	2015.07.05	1 year
4	Horn Antenna	Schwarzbeck	BBHA 9170	9170-182	2014.07.06	2015.07.05	1 year
5	Amplifier	Schwarzbeck	BBV9743	9743 - 019	2014.07.06	2015.07.05	1 year
6	Loop Antenna	ARA	PLA-1030/B	1029	2014.06.08	2015.06.07	1 year

## Conduction Test equipment

Item	Kind of Equipment	Manufacturer	Type No.	Serial No.	Last calibration	Calibrated until	Calibration period
1	LISN	messtec	AN3019	NO.1	Jul. 06, 2014	Jul. 05, 2015	1 year
2	LISN	SCHWARZBECK	NNLK 8129	8126466	Jul. 06, 2014	Jul. 05, 2015	1 year
3	Pulse Limiter	SCHWARZBECK	VTSD9596F	9618	Jul. 06, 2014	Jul. 05, 2015	1 year
4	EMI Test Receiver	R&S	ESCI	100843	Jul. 06, 2014	Jul. 05, 2015	1 year
5	Switch	Schwarzbeck	CX - 210	100196	Jul. 06, 2014	Jul. 05, 2015	1 year

### 3. EMC EMISSION TEST

#### 3.1 CONDUCTED EMISSION MEASUREMENT

##### 3.1.1 POWER LINE CONDUCTED EMISSION Limits (Frequency Range 150KHz-30MHz)

FREQUENCY (MHz)	Class A (dBuV)		Class B (dBuV)		Standard
	Quasi-peak	Average	Quasi-peak	Average	
0.15 -0.5	79.00	66.00	66 - 56 *	56 - 46 *	CISPR
0.50 -5.0	73.00	60.00	56.00	46.00	CISPR
5.0 -30.0	73.00	60.00	60.00	50.00	CISPR

0.15 -0.5	79.00	66.00	66 - 56 *	56 - 46 *	FCC
0.50 -5.0	73.00	60.00	56.00	46.00	FCC
5.0 -30.0	73.00	60.00	60.00	50.00	FCC

Note:

- (1) The tighter limit applies at the band edges.
- (2) The limit of " \* " marked band means the limitation decreases linearly with the logarithm of the frequency in the range.

The following table is the setting of the receiver

Receiver Parameters	Setting
Attenuation	10 dB
Start Frequency	0.15 MHz
Stop Frequency	30 MHz
IF Bandwidth	9 kHz

### 3.1.2 TEST PROCEDURE

- a. The EUT was placed 0.8 meters from the horizontal ground plane with EUT being connected to the power mains through a line impedance stabilization network (LISN). All other support equipments powered from additional LISN(s). The LISN provide 50 Ohm/ 50uH of coupling impedance for the measuring instrument.
- b. Interconnecting cables that hang closer than 40 cm to the ground plane shall be folded back and forth in the center forming a bundle 30 to 40 cm long.
- c. I/O cables that are not connected to a peripheral shall be bundled in the center. The end of the cable may be terminated, if required, using the correct terminating impedance. The overall length shall not exceed 1 m.
- d. LISN at least 80 cm from nearest part of EUT chassis.
- e. For the actual test configuration, please refer to the related Item –EUT Test Photos.

### 3.1.3 DEVIATION FROM TEST STANDARD

No deviation

### 3.1.4 TEST SETUP

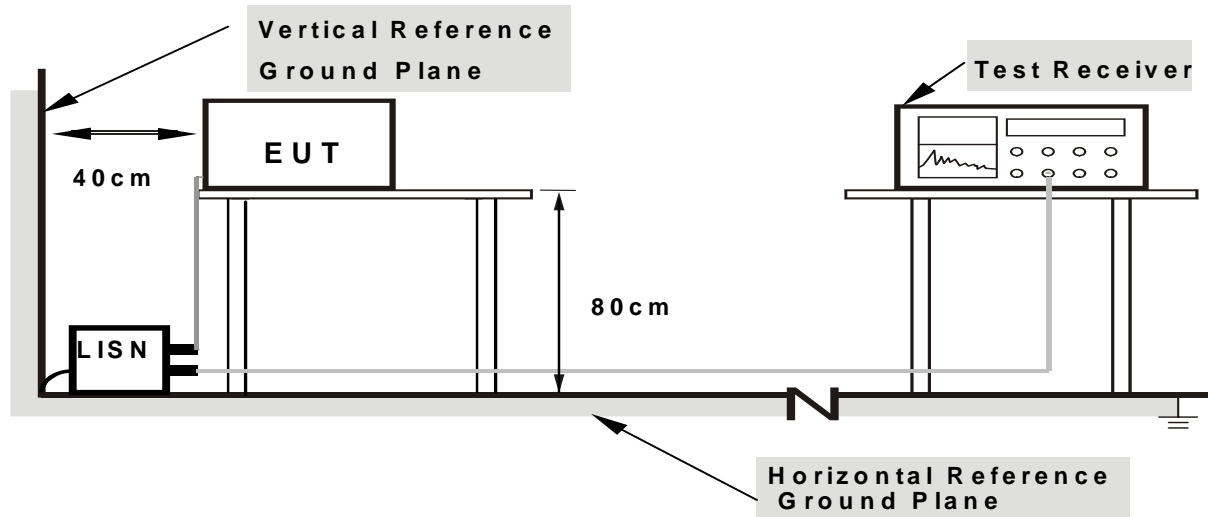

**Note: 1. Support units were connected to second LISN.**

**2. Both of LISNs (AMN) are 80 cm from EUT and at least 80 cm from other units and other metal planes**

### 3.1.5 EUT OPERATING CONDITIONS

The EUT was configured for testing in a typical fashion (as a customer would normally use it). The EUT has been programmed to continuously transmit during test. This operating condition was tested and used to collect the included data.

**3.1.6 TEST RESULTS**

EUT :	Tablet PC	Model Name. :	M691
Temperature :	26 °C	Relative Humidity :	56%
Pressure :	1010hPa	Phase :	L
Test Voltage :	DC 5.0V form Adapter AC 120V/60Hz	Test Mode :	Mode 5

Frequency (MHz)	Meter Reading (dBµV)	Factor (dB)	Emission Level (dBµV)	Limits (dBµV)	Margin (dB)	Remark
0.1740	46.96	10.45	57.41	64.76	-7.35	QP
0.1740	32.02	10.45	42.47	54.76	-12.29	AVG
0.2540	38.95	10.43	49.38	61.62	-12.24	QP
0.2540	22.86	10.43	33.29	51.62	-18.33	AVG
0.6100	28.14	10.41	38.55	56.00	-17.45	QP
0.6100	19.64	10.41	30.05	46.00	-15.95	AVG
2.3340	27.52	10.42	37.94	56.00	-18.06	QP
2.3340	20.59	10.42	31.01	46.00	-14.99	AVG
11.5899	25.68	10.69	36.37	60.00	-23.63	QP
11.5899	17.88	10.69	28.57	50.00	-21.43	AVG
23.8380	28.24	10.73	38.97	60.00	-21.03	QP
23.8380	22.01	10.73	32.74	50.00	-17.26	AVG

Remark:

1. All readings are Quasi-Peak and Average values.
2. Factor = Insertion Loss + Cable Loss.

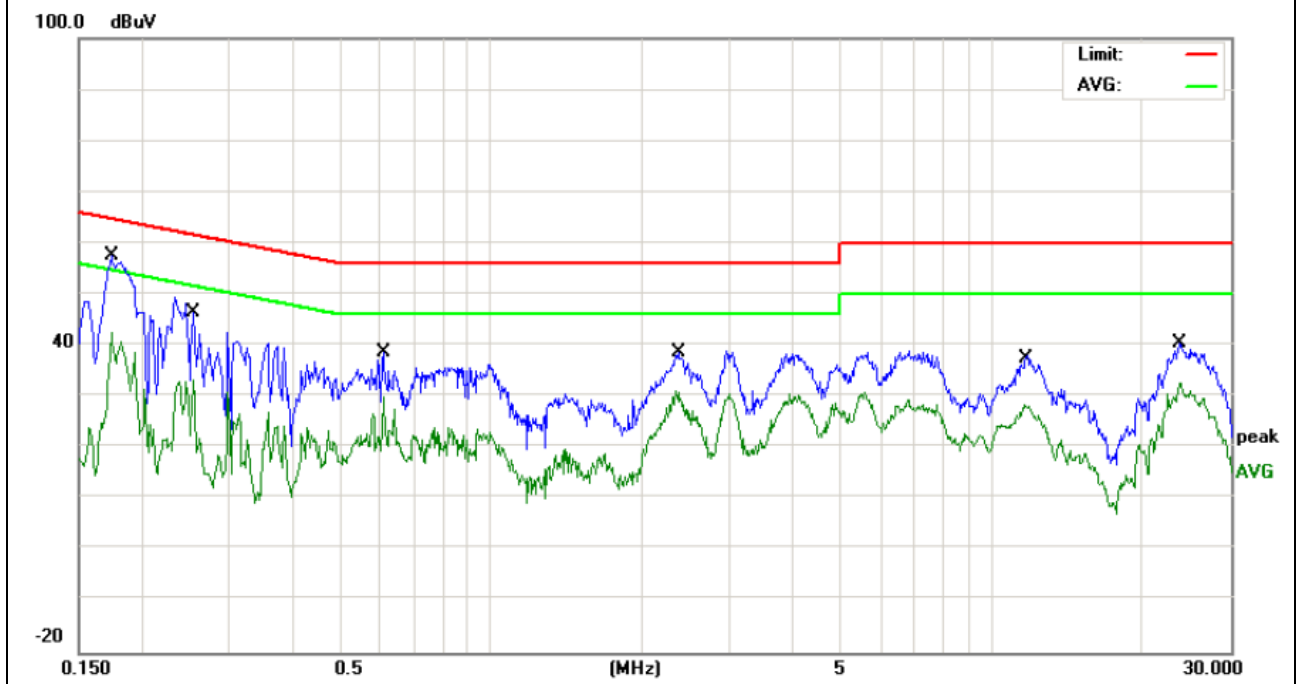

EUT :	Tablet PC	Model Name. :	M691
Temperature :	26 °C	Relative Humidity :	56%
Pressure :	1010hPa	Phase :	N
Test Voltage :	DC 5.0V form Adapter AC 120V/60Hz	Test Mode :	Mode 5

Frequency (MHz)	Meter Reading (dBμV)	Factor (dB)	Emission Level (dBμV)	Limits (dBμV)	Margin (dB)	Remark
0.1819	46.25	10.38	56.63	64.39	-7.76	QP
0.1819	32.77	10.38	43.15	54.39	-11.24	AVG
0.2548	35.09	10.43	45.52	61.60	-16.08	QP
0.2548	23.42	10.43	33.85	51.60	-17.75	AVG
0.2986	31.69	10.42	42.11	60.28	-18.17	QP
0.2986	18.66	10.42	29.08	50.28	-21.20	AVG
0.6060	28.95	10.40	39.35	56.00	-16.65	QP
0.6060	19.09	10.40	29.49	46.00	-16.51	AVG
2.3340	27.29	10.44	37.73	56.00	-18.27	QP
2.3340	21.00	10.44	31.44	46.00	-14.56	AVG
23.4619	27.15	10.77	37.92	60.00	-22.08	QP
23.4619	21.46	10.77	32.23	50.00	-17.77	AVG

Remark:

1. All readings are Quasi-Peak and Average values.
2. Factor = Insertion Loss + Cable Loss.

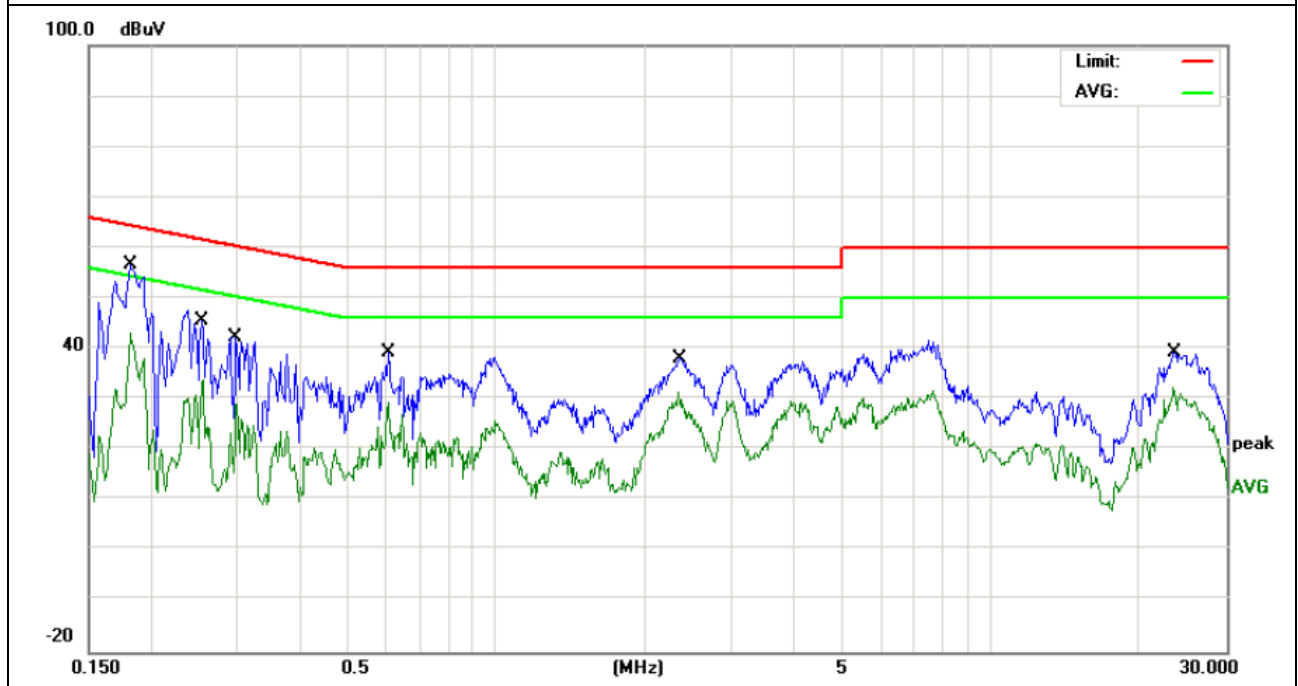



### 3.2 RADIATED EMISSION MEASUREMENT

#### 3.2.1 RADIATED EMISSION LIMITS (Frequency Range 9kHz-1000MHz)

20dBc in any 100 kHz bandwidth outside the operating frequency band. In case the emission fall within the restricted band specified on 15.205(a), then the 15.209(a) limit in the table below has to be followed.

Frequencies (MHz)	Field Strength (micorvolts/meter)	Measurement Distance (meters)
0.009~0.490	2400/F(KHz)	300
0.490~1.705	24000/F(KHz)	30
1.705~30.0	30	30
30~88	100	3
88~216	150	3
216~960	200	3
Above 960	500	3

#### LIMITS OF RADIATED EMISSION MEASUREMENT (Above 1000MHz)

FREQUENCY (MHz)	Class B (dBuV/m) (at 3M)	
	PEAK	AVERAGE
Above 1000	74	54

Notes:

- (1) The limit for radiated test was performed according to FCC PART 15C.
- (2) The tighter limit applies at the band edges.
- (3) Emission level (dBuV/m)=20log Emission level (uV/m).

Spectrum Parameter	Setting
Attenuation	Auto
Start Frequency	1000 MHz
Stop Frequency	10th carrier harmonic
RB / VB (emission in restricted band)	1 MHz / 1 MHz for Peak, 1 MHz / 10Hz for Average

Receiver Parameter	Setting
Attenuation	Auto
Start ~ Stop Frequency	9kHz~150kHz / RB 200Hz for QP
Start ~ Stop Frequency	150kHz~30MHz / RB 9kHz for QP
Start ~ Stop Frequency	30MHz~1000MHz / RB 120kHz for QP

### 3.2.2 TEST PROCEDURE

- a. The measuring distance of at 3 m shall be used for measurements at frequency up to 1GHz. For frequencies above 1GHz, any suitable measuring distance may be used.
- b. The EUT was placed on the top of a rotating table 0.8 meters above the ground at a 3 meter open area test site. The table was rotated 360 degrees to determine the position of the highest radiation.
- c. The height of the equipment or of the substitution antenna shall be 0.8 m; the height of the test antenna shall vary between 1 m to 4 m. Both horizontal and vertical polarizations of the antenna are set to make the measurement.
- d. The initial step in collecting conducted emission data is a spectrum analyzer peak detector mode pre-scanning the measurement frequency range. Significant peaks are then marked and then Quasi Peak detector mode re-measured.
- e. If the Peak Mode measured value compliance with and lower than Quasi Peak Mode Limit, the EUT shall be deemed to meet QP Limits and then no additional QP Mode measurement performed.
- f. For the actual test configuration, please refer to the related Item –EUT Test Photos.

Note:

Both horizontal and vertical antenna polarities were tested and performed pretest to three orthogonal axis. The worst case emissions were reported

During the radiated emission test, the Spectrum Analyzer was set with the following configurations:

Frequency Band (MHz)	Function	Resolution bandwidth	Video Bandwidth
30 to 1000	QP	120 kHz	300 kHz
Above 1000	Peak	1 MHz	1 MHz
	Average	1 MHz	10 Hz

### 3.2.3 DEVIATION FROM TEST STANDARD

No deviation

### 3.2.4 TEST SETUP

#### (A) Radiated Emission Test-Up Frequency Below 30MHz

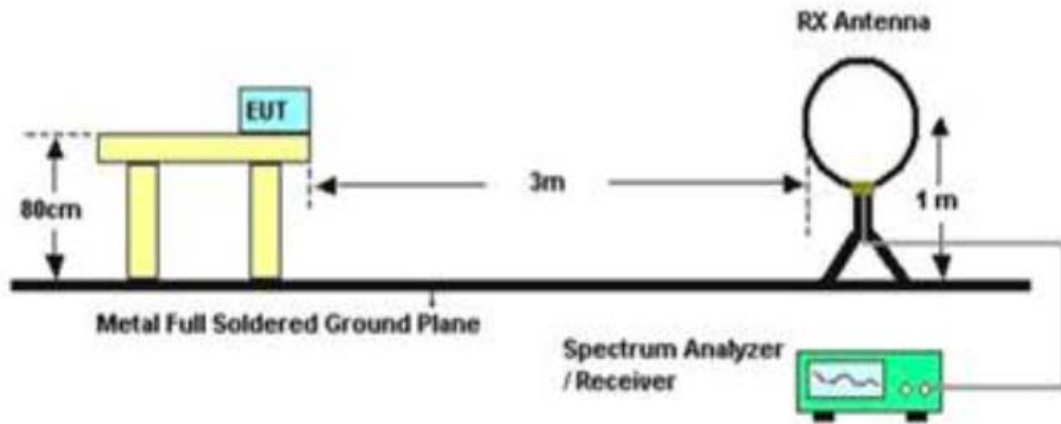

#### (B) Radiated Emission Test-Up Frequency 30MHz~1GHz

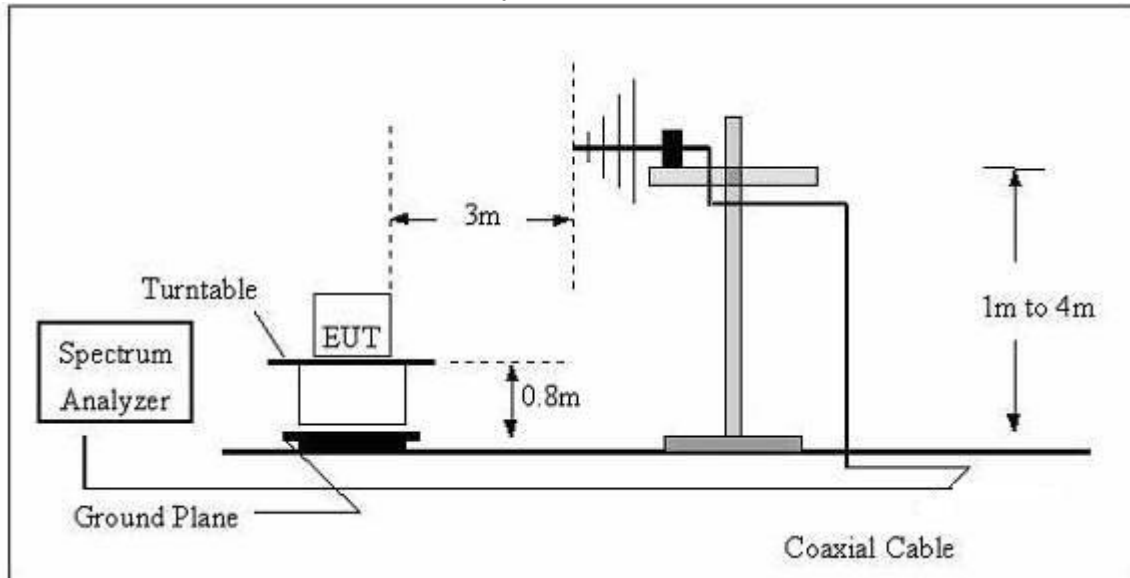

## (C) Radiated Emission Test-Up Frequency Above 1GHz

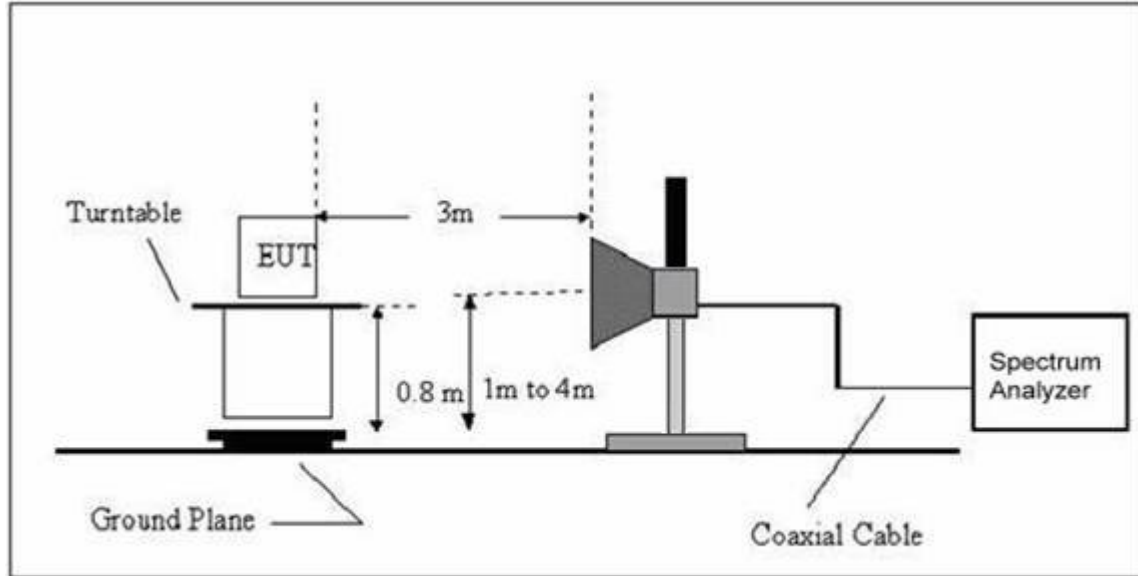
**3.2.5 EUT OPERATING CONDITIONS**

The EUT tested system was configured as the statements of 2.4 Unless otherwise a special operating condition is specified in the follows during the testing.

**3.2.6 TEST RESULTS (BETWEEN 9KHZ – 30 MHZ)**

EUT:	Tablet PC	Model Name. :	M691
Temperature:	20 °C	Relative Humidity:	48%
Pressure:	1010 hPa	Test Voltage :	DC 5.0V
Test Mode :	TX	Polarization :	--

Freq. (MHz)	Reading (dBuV/m)	Limit (dBuV/m)	Margin (dB)	State P/F
--	--	--	--	P
--	--	--	--	P

**NOTE:**

The amplitude of spurious emissions which are attenuated by more than 20dB below the permissible value has no need to be reported.

Distance extrapolation factor =  $40 \log(\text{specific distance}/\text{test distance})$ (dB);

Limit line = specific limits(dBuv) + distance extrapolation factor.

**3.2.7 TEST RESULTS (BETWEEN 30MHZ – 1GHZ)**

EUT :	Tablet PC	Model Name :	M691
Temperature :	20 °C	Relative Humidity :	48%
Pressure:	1010 hPa	Test Voltage :	DC 5V
Test Mode :	TX		

Polar (H/V)	Frequency	Meter Reading	Factor	Emission Level	Limits	Margin	Remark
	(MHz)	(dBuV)	(dB)	(dBuV/m)	(dBuV/m)	(dB)	
V	45.2165	21.03	11.87	32.90	40.00	-7.10	QP
V	67.2022	21.79	6.21	28.00	40.00	-12.00	QP
V	120.6991	14.62	12.08	26.70	43.50	-16.80	QP
V	164.9072	16.19	10.51	26.70	43.50	-16.80	QP
V	281.0074	25.86	13.93	39.79	46.00	-6.21	QP
V	562.6624	12.53	21.61	34.14	46.00	-11.86	QP

**Remark:**

Absolute Level= ReadingLevel+ Factor, Margin= Absolute Level - Limit

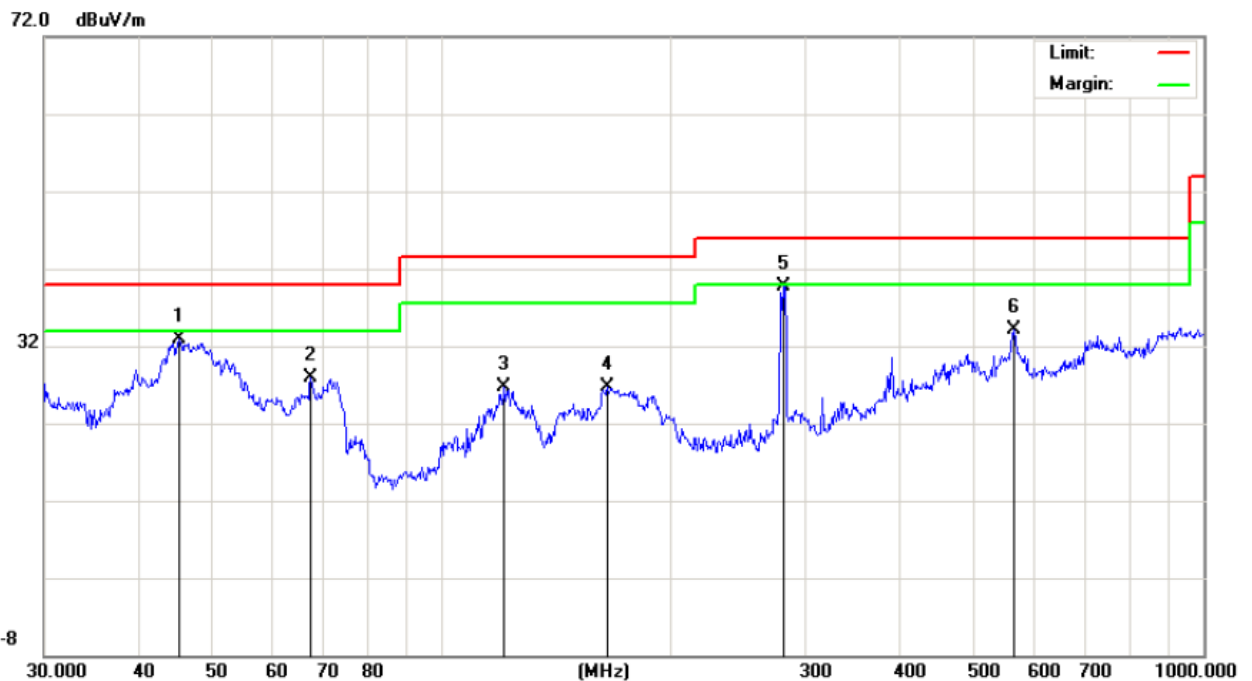

Polar (H/V)	Frequency	Meter Reading	Factor	Emission Level	Limits	Margin	Remark
	(MHz)	(dBuV)	(dB)	(dBuV/m)	(dBuV/m)	(dB)	
H	31.1798	6.81	18.78	25.59	40.00	-14.41	peak
H	43.9658	14.74	12.26	27.00	40.00	-13.00	peak
H	185.1379	17.26	10.67	27.93	43.50	-15.57	peak
H	281.9945	25.07	13.95	39.02	46.00	-6.98	peak
H	562.6624	13.11	21.61	34.72	46.00	-11.28	peak
H	845.0878	10.57	27.25	37.82	46.00	-8.18	peak

**Remark:**

Absolute Level= ReadingLevel+ Factor, Margin= Absolute Level - Limit

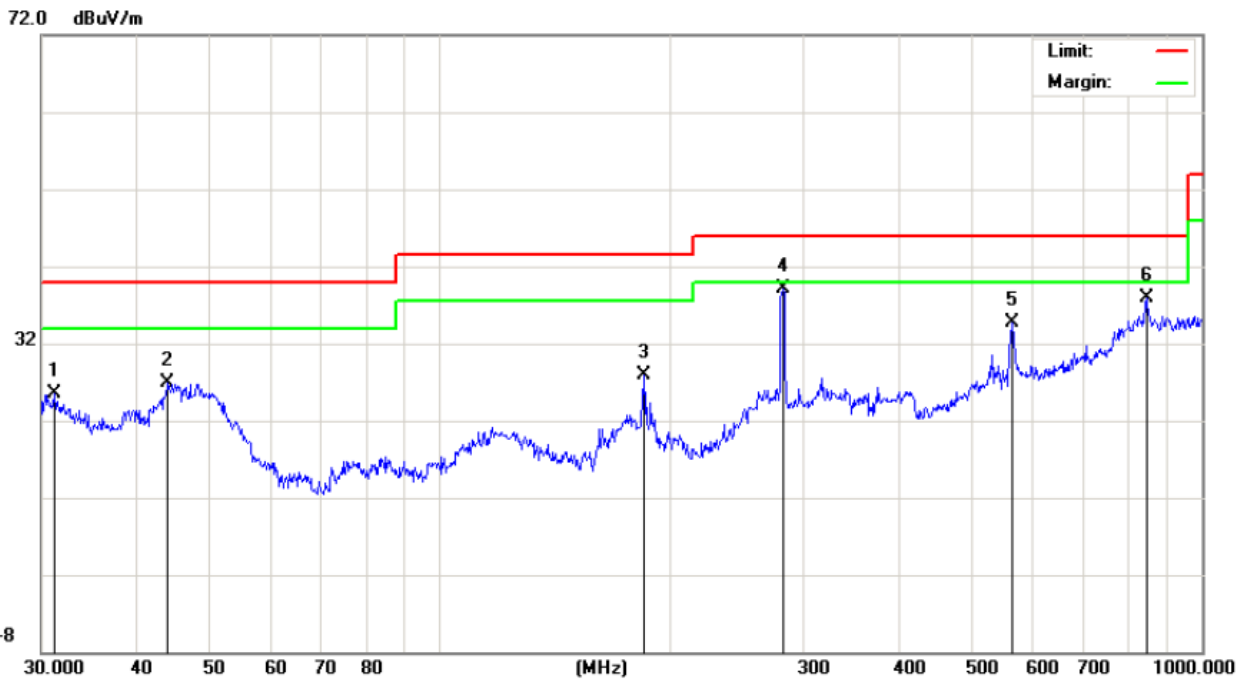

**3.2.8 TEST RESULTS (ABOVE 1000 MHZ)**

EUT :	Tablet PC	Model Name :	M691
Temperature :	20 °C	Relative Humidity :	48%
Pressure:	1010 hPa	Test Voltage :	DC 5V
Test Mode :	TX		

Frequency (MHz)	Meter Reading (dBμV)	Factor (dB)	Emission Level (dBμV/m)	Limits (dBμV/m)	Margin (dB)	Remark	Comment
Low Channel (2412 MHz)							
4824.241	53.31	10.44	63.75	74.00	-10.25	Pk	Vertical
4824.241	34.87	10.44	45.31	54.00	-8.69	Av	Vertical
7236.306	46.52	12.39	58.91	74.00	-15.09	Pk	Vertical
7236.306	30.83	12.39	43.22	54.00	-10.78	Av	Vertical
4824.258	55.06	10.44	65.50	74.00	-8.50	Pk	Horizontal
4824.258	35.78	10.44	46.22	54.00	-7.78	Av	Horizontal
7236.342	47.22	12.39	59.61	74.00	-14.39	Pk	Horizontal
7236.342	32.36	12.39	44.75	54.00	-9.25	Av	Horizontal
Middel Channel (2437 MHz)							
4874.305	52.14	10.40	62.54	74.00	-11.46	Pk	Vertical
4874.305	33.06	10.40	43.46	54.00	-10.54	Av	Vertical
7311.113	45.8	12.75	58.55	74.00	-15.45	Pk	Vertical
7311.113	28.79	12.75	41.54	54.00	-12.46	Av	Vertical
4874.254	52.91	10.40	63.31	74.00	-10.69	Pk	Horizontal
4874.254	34.14	10.40	44.54	54.00	-9.46	Av	Horizontal
7311.077	49.02	12.75	61.77	74.00	-12.23	Pk	Horizontal
7311.077	29.71	12.75	42.46	54.00	-11.54	Av	Horizontal
High Channel (2462 MHz)							
4924.148	52.08	10.39	62.47	74.00	-11.53	Pk	Vertical
4924.148	33.71	10.39	44.10	54.00	-9.90	Av	Vertical
7386.263	45.48	12.68	58.16	74.00	-15.84	Pk	Vertical
7386.263	29.12	12.68	41.80	54.00	-12.20	Av	Vertical
4924.147	52.11	10.39	62.50	74.00	-11.50	Pk	Horizontal
4924.147	34.21	10.39	44.60	54.00	-9.40	Av	Horizontal
7386.308	48.52	12.68	61.20	74.00	-12.80	Pk	Horizontal
7386.308	29.81	12.68	42.49	54.00	-11.51	Av	Horizontal

Note: "802.11b" mode is the worst mode.



## 4. POWER SPECTRAL DENSITY TEST

### 4.1 APPLIED PROCEDURES / LIMIT

FCC Part15 (15.247) , Subpart C				
Section	Test Item	Limit	Frequency Range (MHz)	Result
15.247	Power Spectral Density	8 dBm (in any 3KHz)	2400-2483.5	PASS

#### 4.1.1 TEST PROCEDURE

1. Set analyzer center frequency to DTS channel center frequency.
2. Set the span to 1.5 times the DTS channel bandwidth.
3. 3 kHz ≤ Set the RBW ≤ 100 kHz.
4. Set the VBW ≥ 3 x RBW.
5. Detector = peak.
6. Sweep time = auto couple.
7. Trace mode = max hold.
8. Allow trace to fully stabilize.
9. Use the peak marker function to determine the maximum amplitude level within the RBW.
10. If measured value exceeds limit, reduce RBW (no less than 3 kHz) and repeat.

#### 4.1.2 DEVIATION FROM STANDARD

No deviation.

#### 4.1.3 TEST SETUP

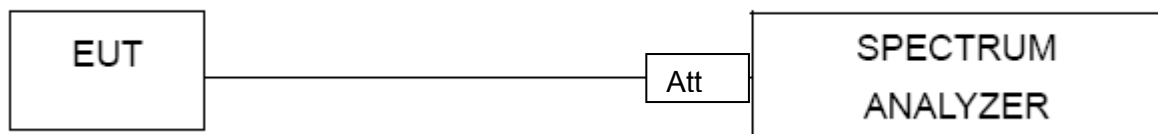

#### 4.1.4 EUT OPERATION CONDITIONS

The EUT tested system was configured as the statements of 2.1 Unless otherwise a special operating condition is specified in the follows during the testing.

#### 4.1.5 TEST RESULTS

EUT :	Tablet PC	Model Name :	M691
Temperature :	25 °C	Relative Humidity :	56%
Pressure :	1015 hPa	Test Voltage :	DC 5V
Test Mode :	TX b Mode /CH01, CH06, CH11		

Frequency	Power Density (dBm/3kHz)	Limit (dBm/3kHz)	Result
2412 MHz	-7.92	8	PASS
2437 MHz	-7.33	8	PASS
2462 MHz	-7.18	8	PASS

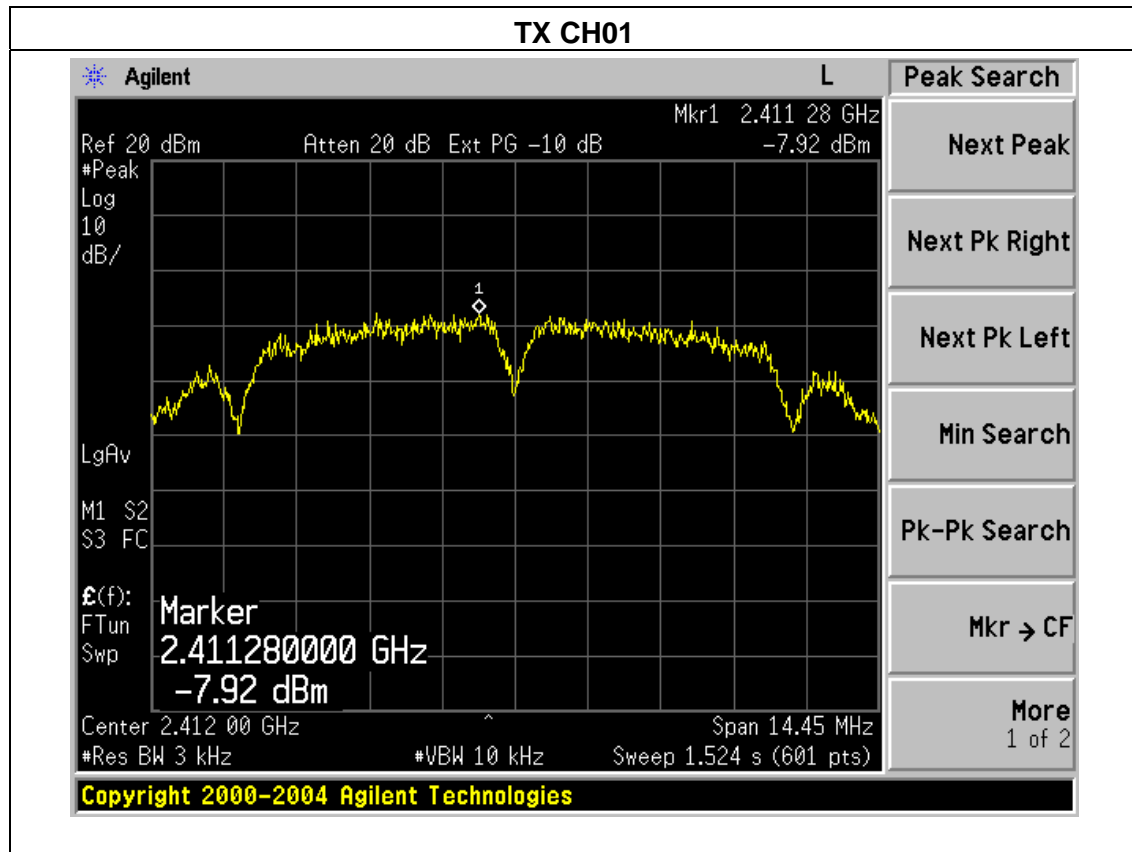

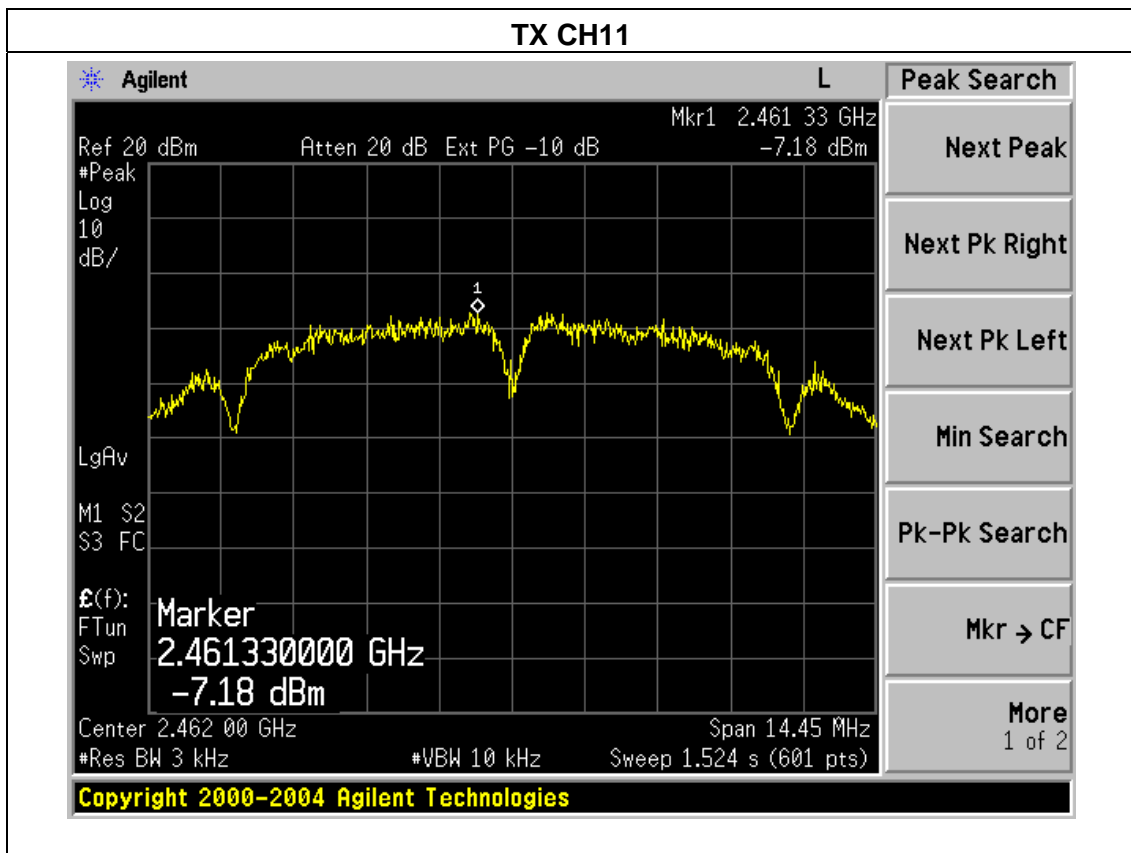
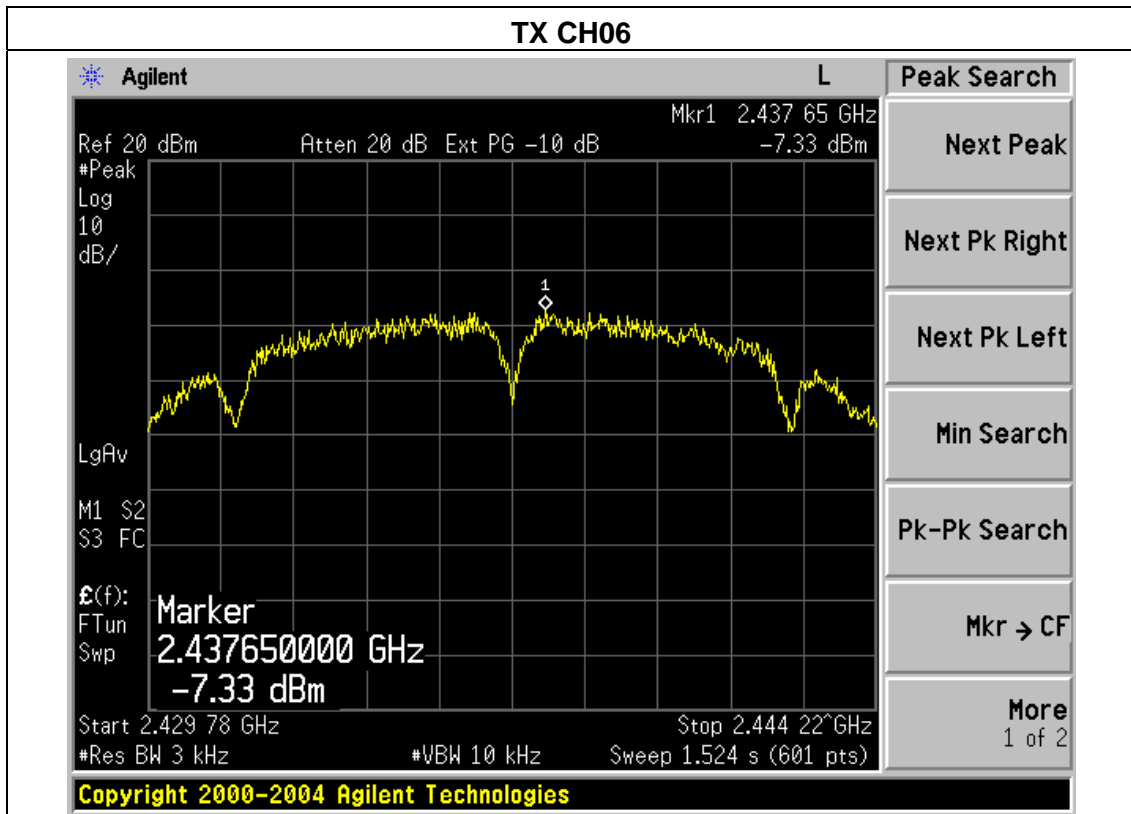

EUT :	Tablet PC	Model Name :	M691
Temperature :	25 °C	Relative Humidity :	56%
Pressure :	1015 hPa	Test Voltage :	DC 5V
Test Mode :	TX g Mode /CH01, CH06, CH11		

Frequency	Power Density (dBm/3kHz)	Limit (dBm/3kHz)	Result
2412 MHz	-12.36	8	PASS
2437 MHz	-10.69	8	PASS
2462 MHz	-12.61	8	PASS

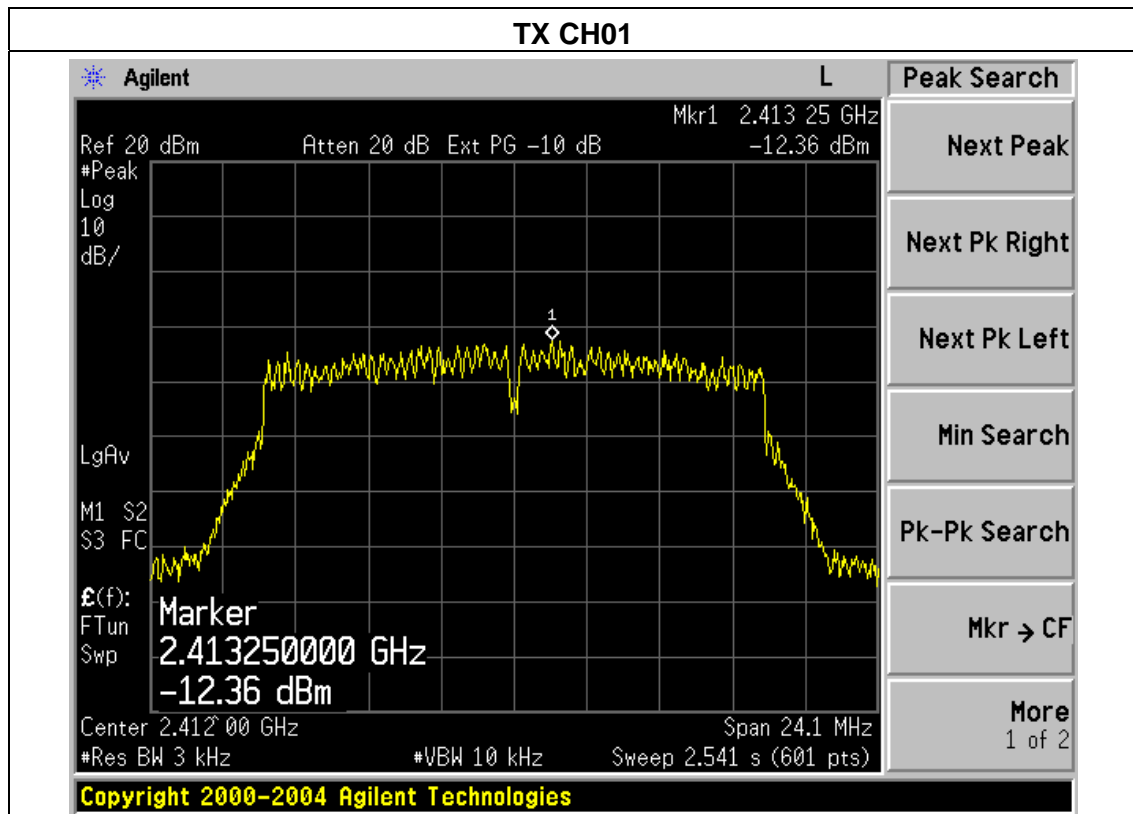

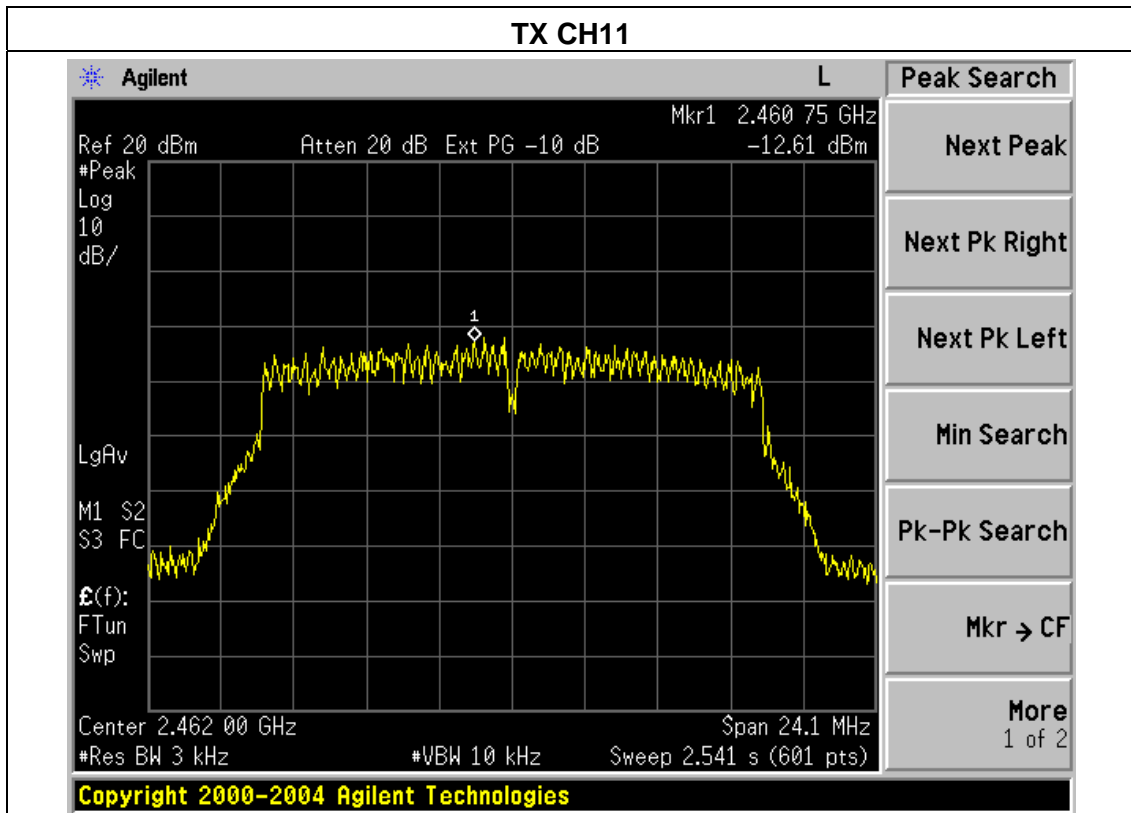
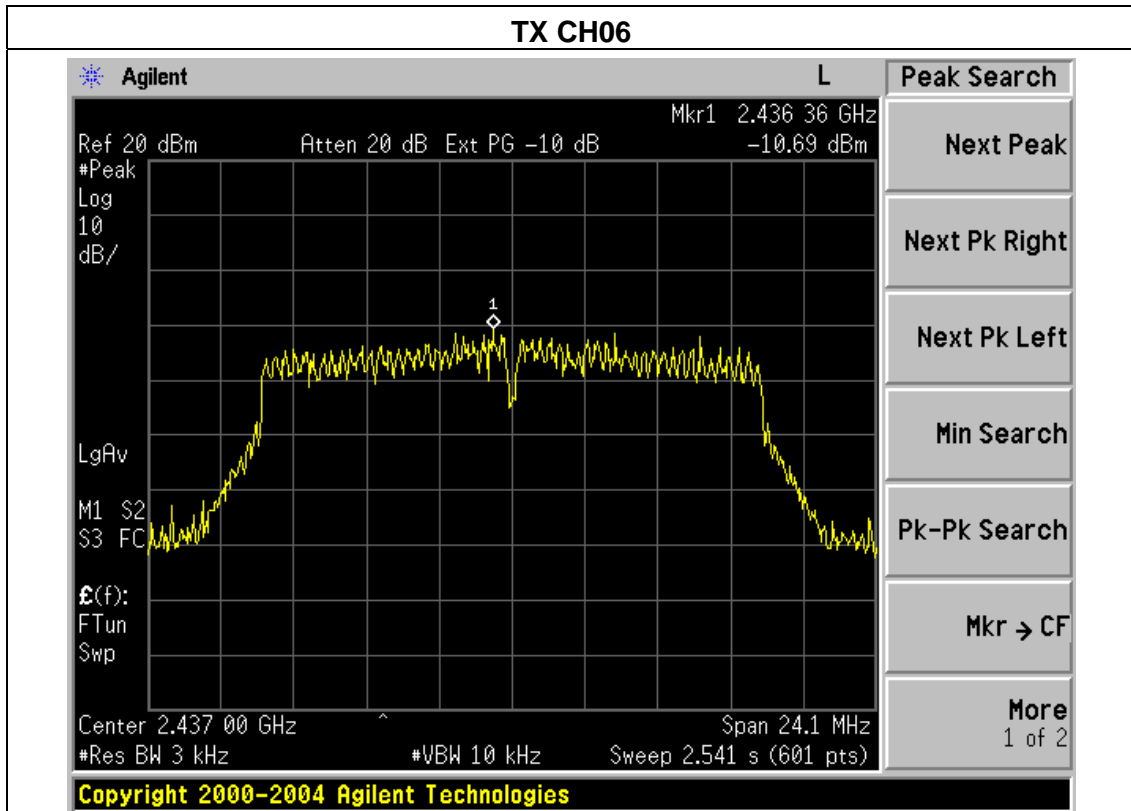

EUT :	Tablet PC	Model Name :	M691
Temperature :	25 °C	Relative Humidity :	56%
Pressure :	1015 hPa	Test Voltage :	DC 3.7V
Test Mode :	TX n Mode(20M) /CH01, CH06, CH11		

Frequency	Power Density (dBm/3kHz)	Limit (dBm/3kHz)	Result
2412 MHz	-12.40	8	PASS
2437 MHz	-11.18	8	PASS
2462 MHz	-11.85	8	PASS

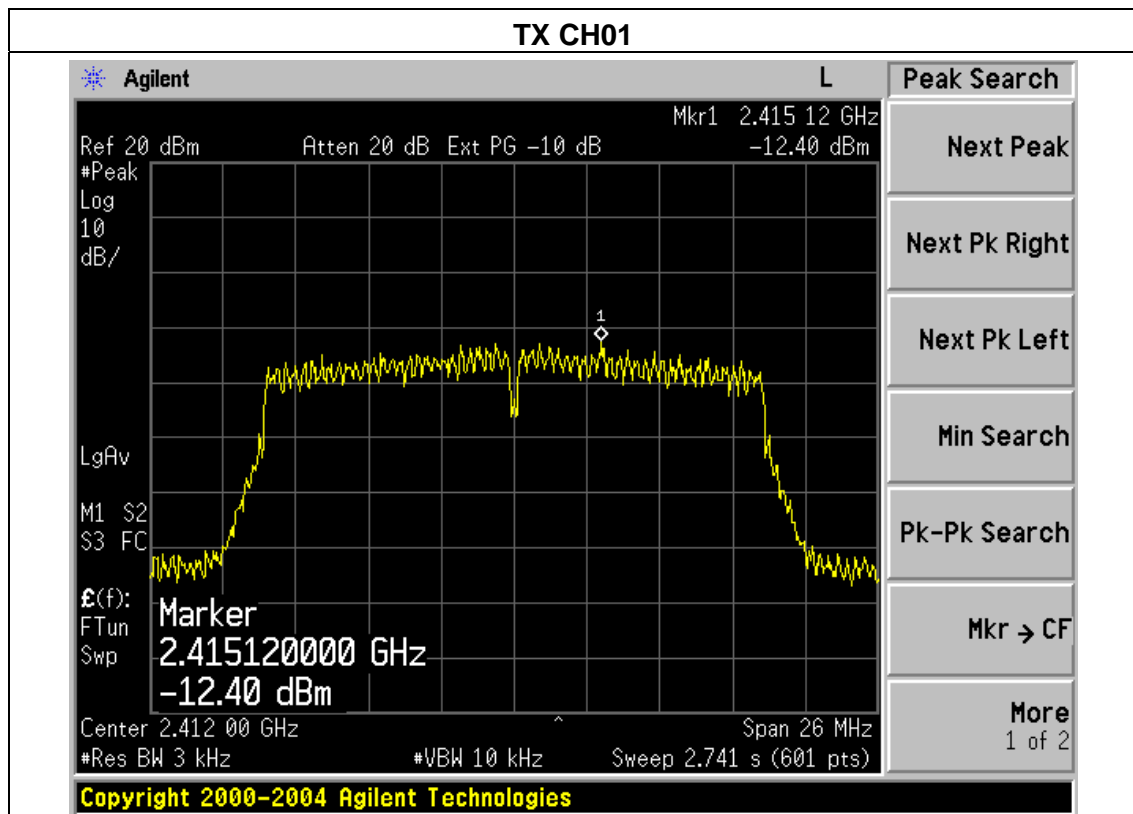

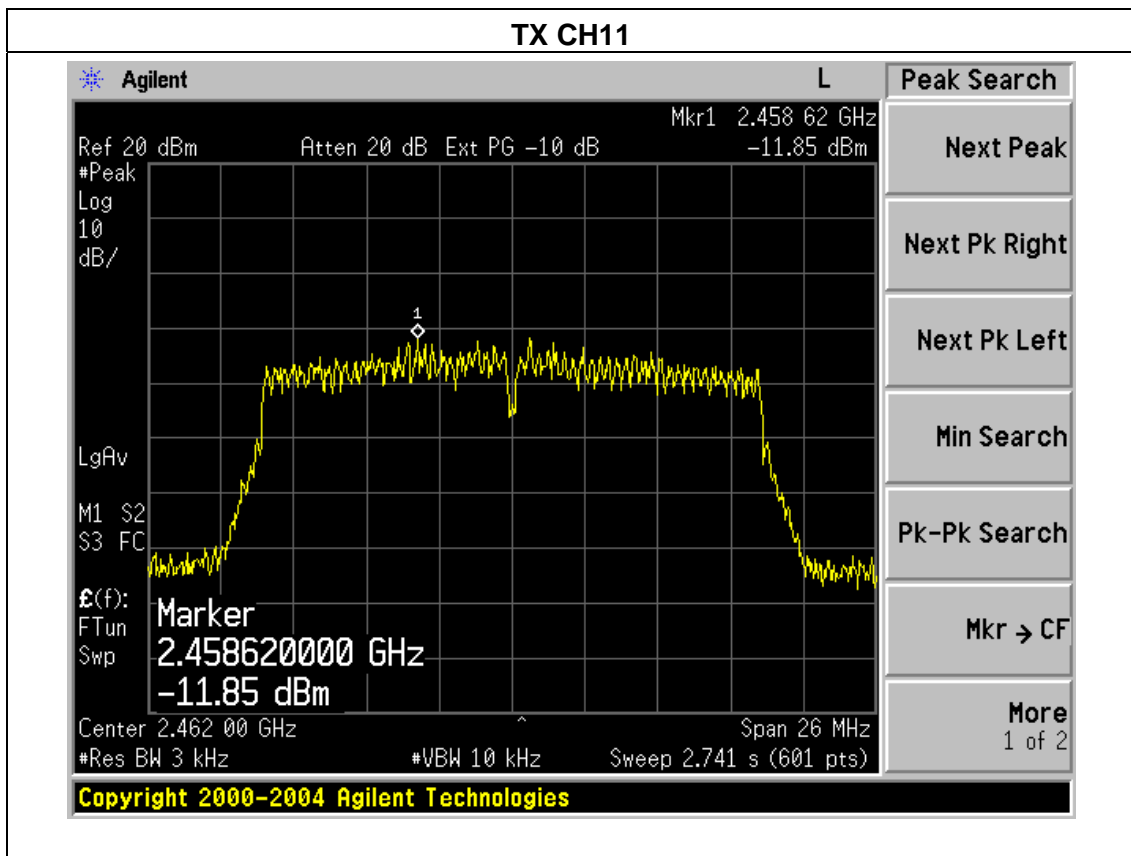
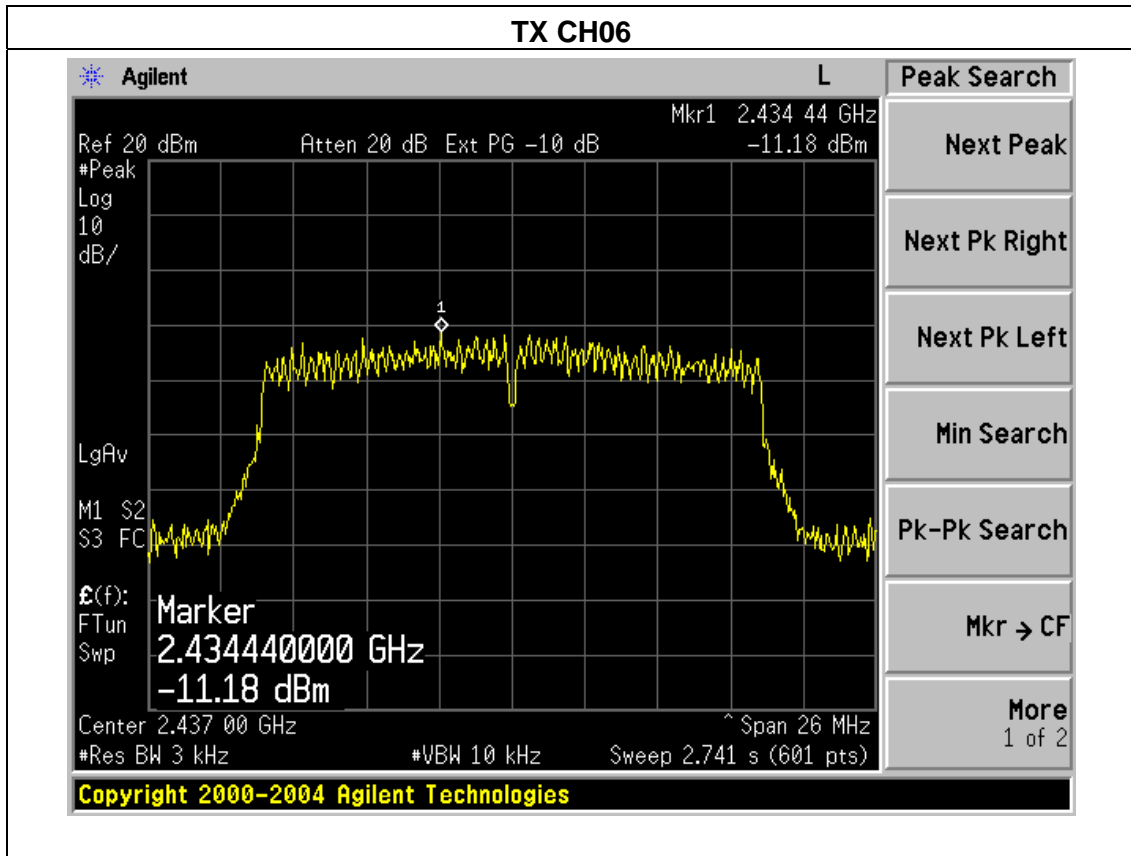

EUT :	Tablet PC	Model Name :	M691
Temperature :	25 °C	Relative Humidity :	56%
Pressure :	1015 hPa	Test Voltage :	DC 3.7V
Test Mode :	TX n Mode(40M) /CH03, CH06, CH09		

Frequency	Power Density (dBm/3kHz)	Limit (dBm/3kHz)	Result
2422 MHz	-18.04	8	PASS
2437 MHz	-15.26	8	PASS
2452 MHz	-17.72	8	PASS

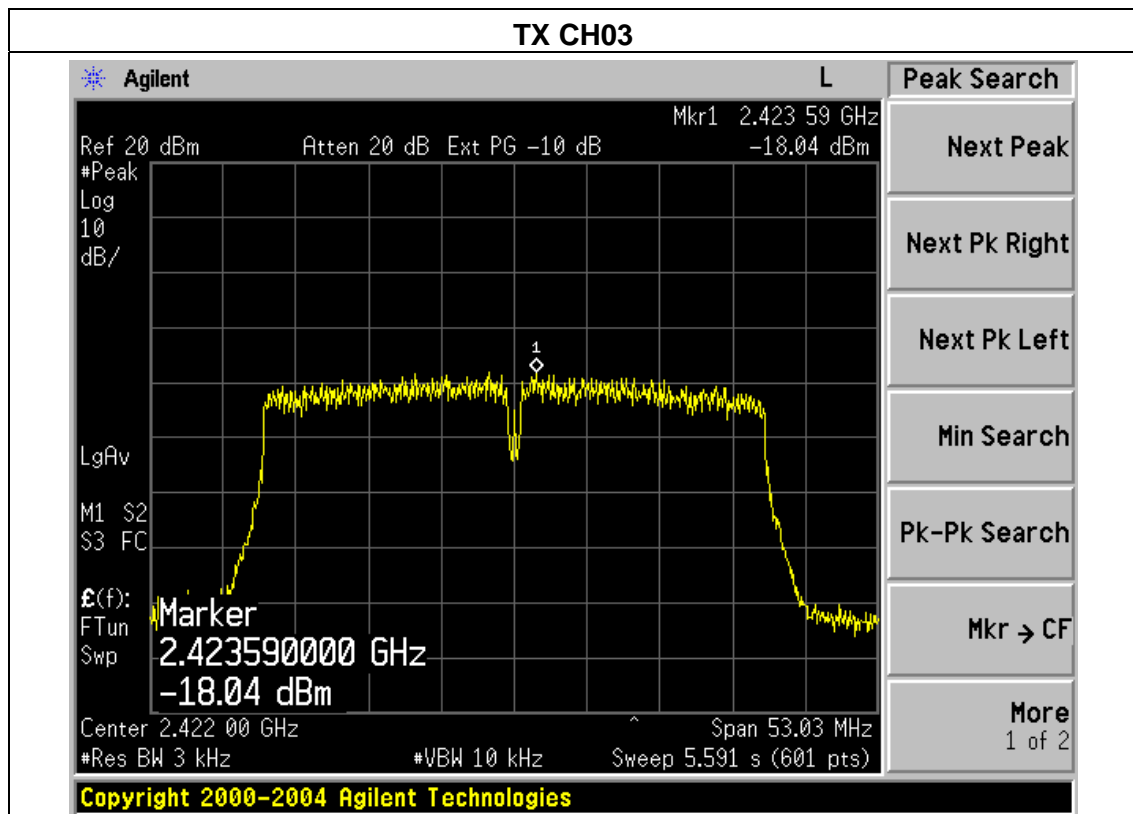



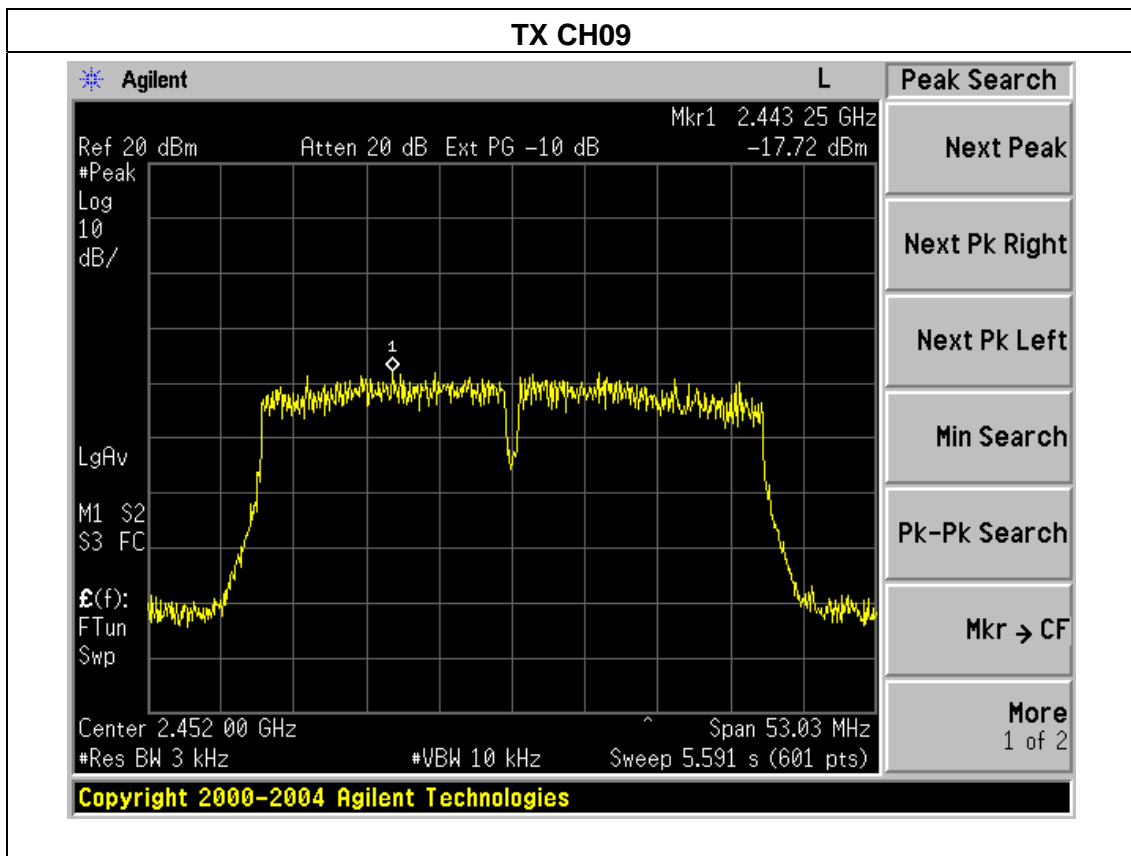
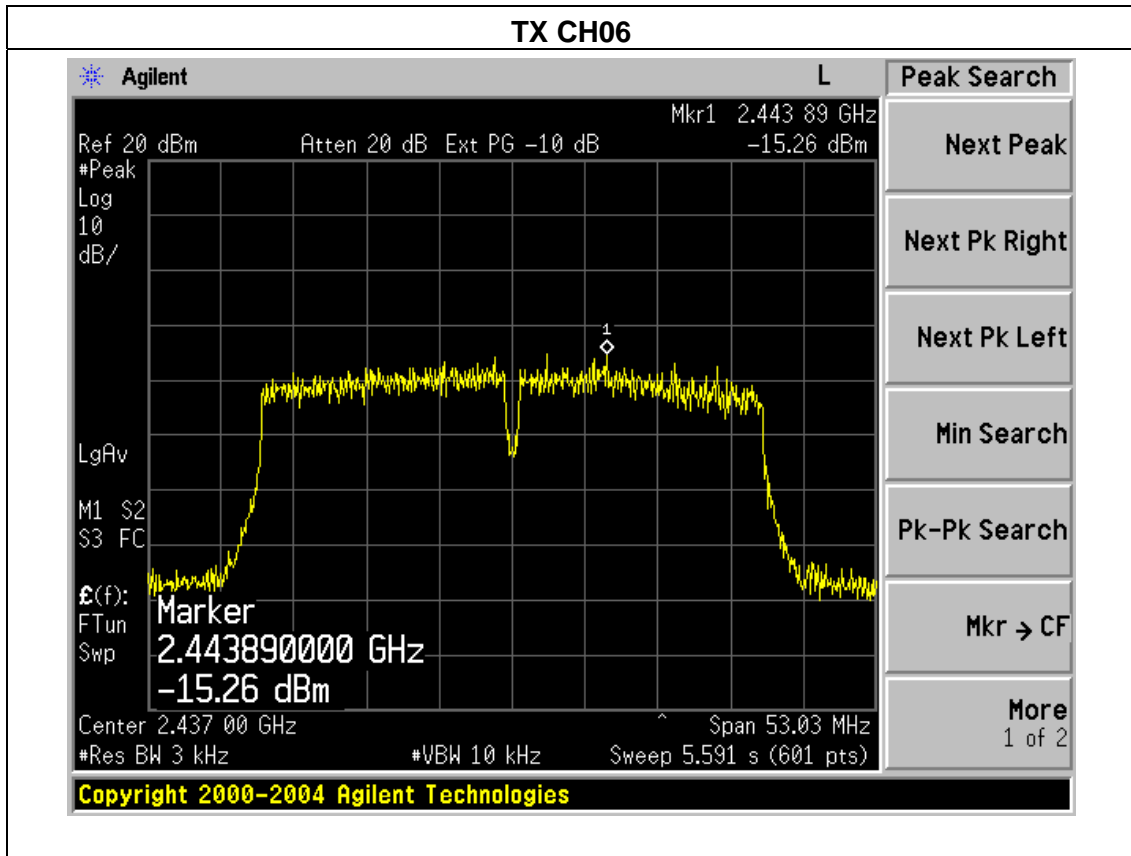

## 5. BANDWIDTH TEST

### 5.1 APPLIED PROCEDURES / LIMIT

FCC Part15 (15.247) , Subpart C				
Section	Test Item	Limit	Frequency Range (MHz)	Result
15.247(a)(2)	Bandwidth	$\geq 500\text{KHz}$ (6dB bandwidth)	2400-2483.5	PASS

#### 5.1.1 TEST PROCEDURE

1. Set RBW = 100 kHz.
2. Set the video bandwidth (VBW)  $\geq 3 \times$  RBW.
3. Detector = Peak.
4. Trace mode = max hold.
5. Sweep = auto couple.
6. Allow the trace to stabilize.
7. Measure the maximum width of the emission that is constrained by the frequencies associated with the two outermost amplitude points (upper and lower) that are attenuated by 6 dB relative to the maximum level measured in the fundamental emission.

#### TEST SETUP

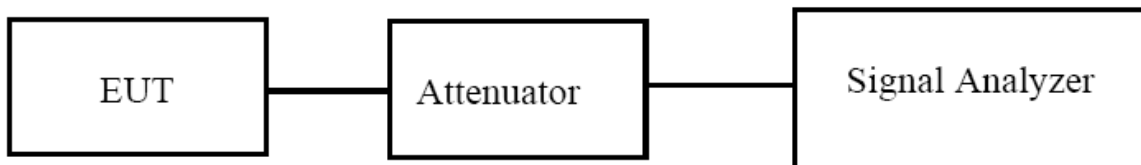

#### 5.1.2 EUT OPERATION CONDITIONS

The EUT tested system was configured as the statements of 2.4 Unless otherwise a special operating condition is specified in the follows during the testing.

**5.1.3 TEST RESULTS**

EUT :	Tablet PC	Model Name :	M691
Temperature :	25 °C	Relative Humidity :	56%
Pressure :	1012 hPa	Test Voltage :	DC 3.7V
Test Mode :	TX b Mode /CH01, CH06, CH11		

Channel	Frequency (MHz)	6dB bandwidth (MHz)	Limit (kHz)	Result
Low	2412	9.612	500	Pass
Middle	2437	9.631	500	Pass
High	2462	9.146	500	Pass

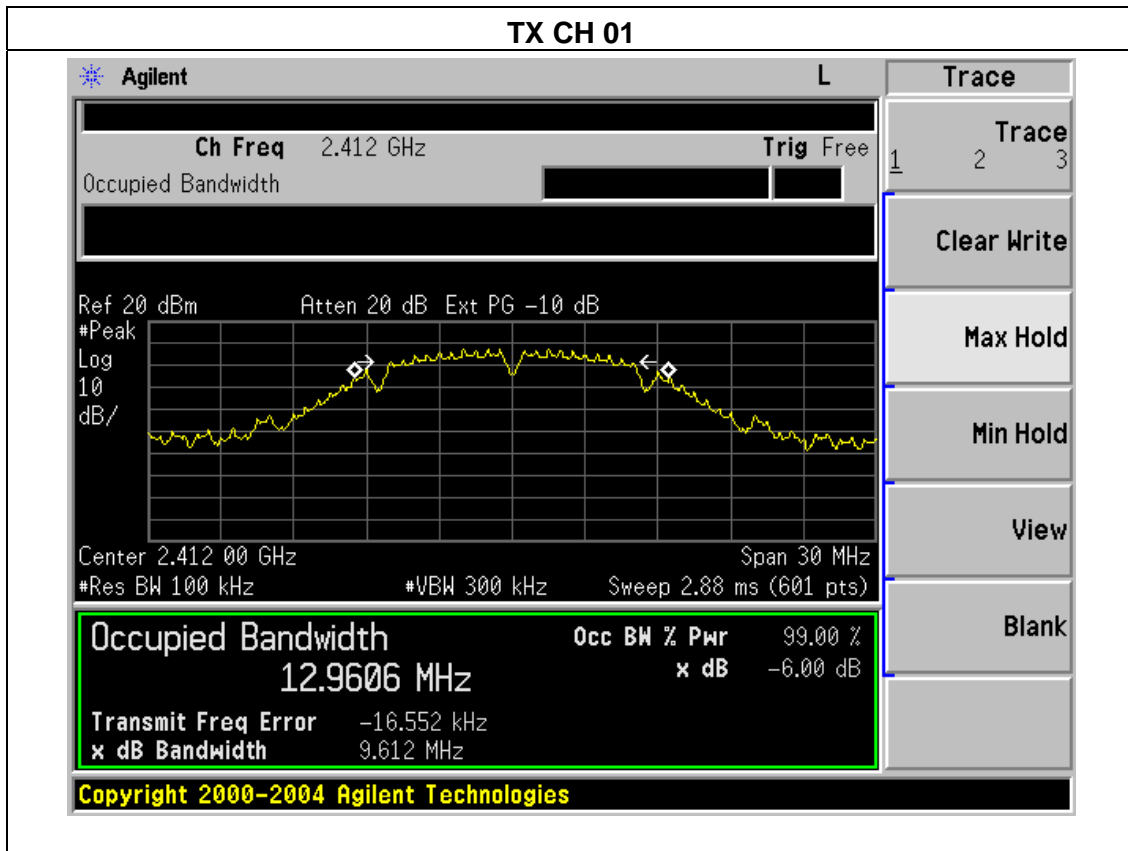

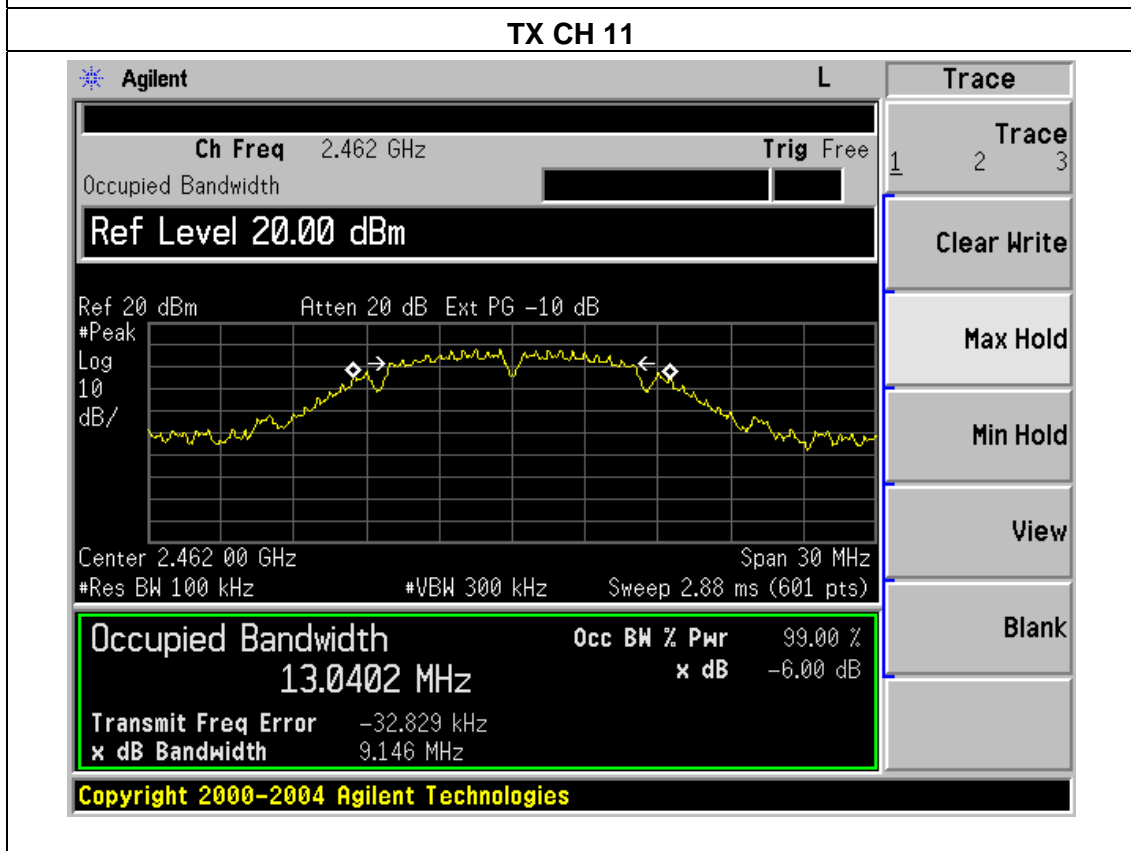
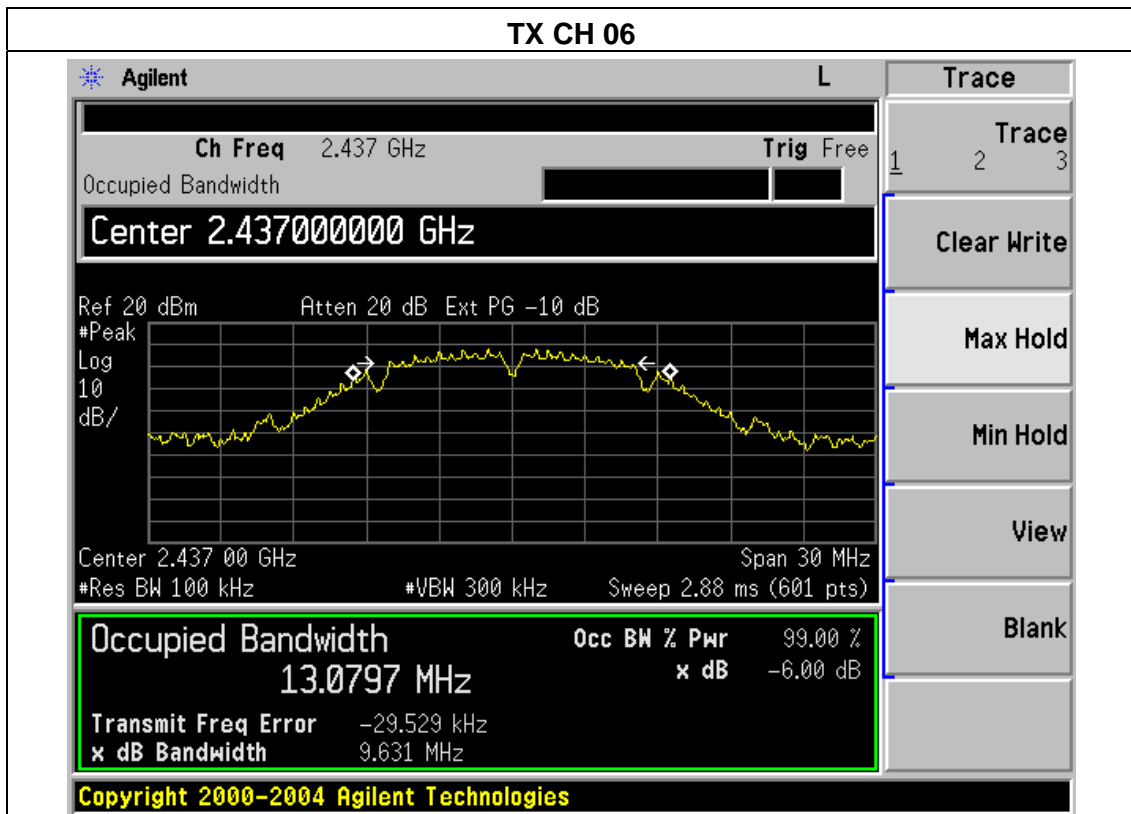

EUT :	Tablet PC	Model Name :	M691
Temperature :	25 °C	Relative Humidity :	60%
Pressure :	1012 hPa	Test Voltage :	DC 3.7V
Test Mode :	TX g Mode /CH01, CH06, CH11		

Channel	Frequency (MHz)	6dB bandwidth (MHz)	Limit (kHz)	Result
Low	2412	13.885	500	Pass
Middle	2437	15.122	500	Pass
High	2462	16.058	500	Pass

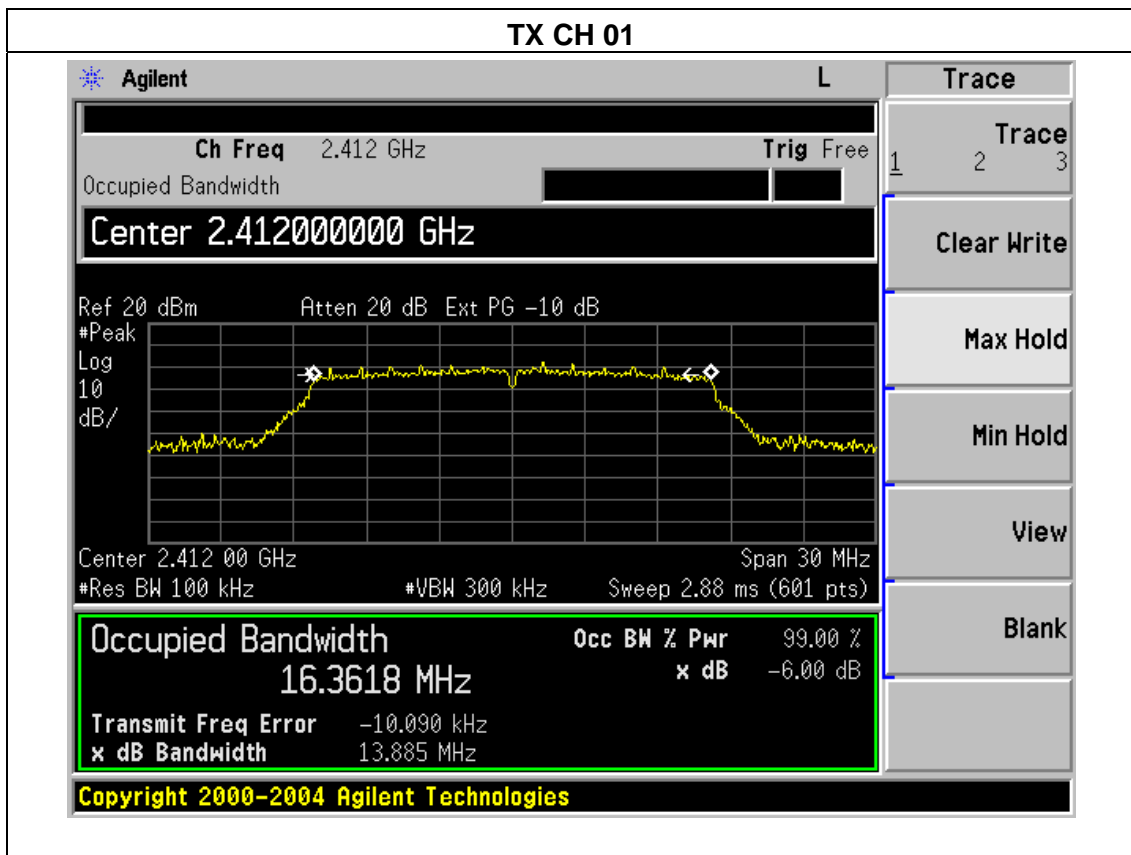

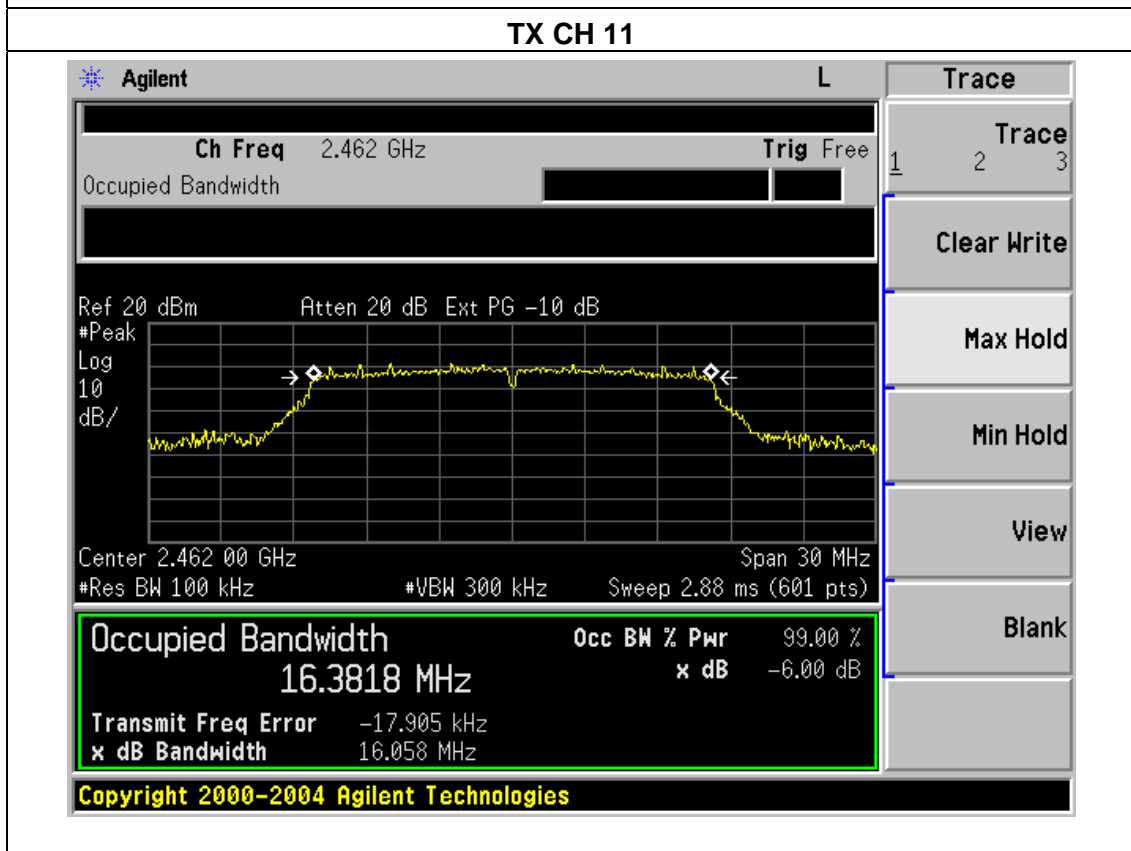
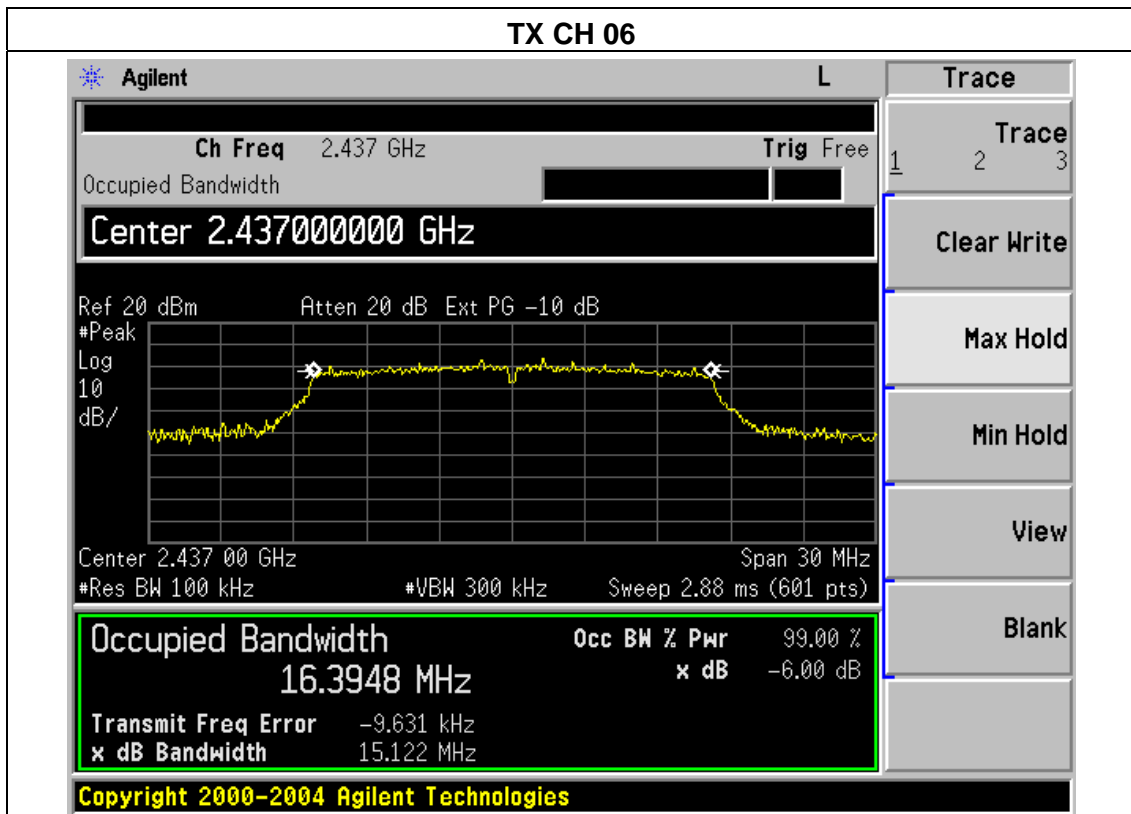

EUT :	Tablet PC	Model Name :	M691
Temperature :	25 °C	Relative Humidity :	56%
Pressure :	1012 hPa	Test Voltage :	DC 3.7V
Test Mode :	TX n Mode(20M) /CH01, CH06, CH11		

Channel	Frequency (MHz)	6dB bandwidth (MHz)	Limit (kHz)	Result
Low	2412	15.669	500	Pass
Middle	2437	17.300	500	Pass
High	2462	15.159	500	Pass

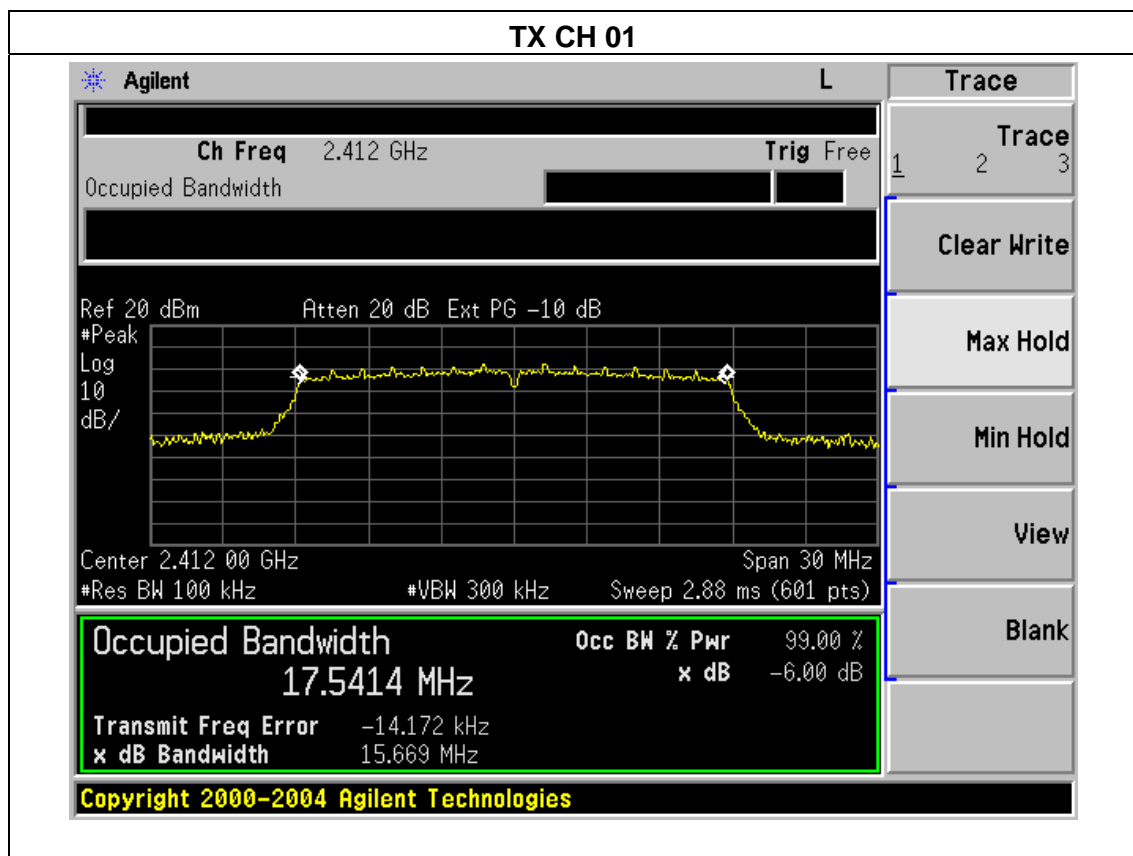

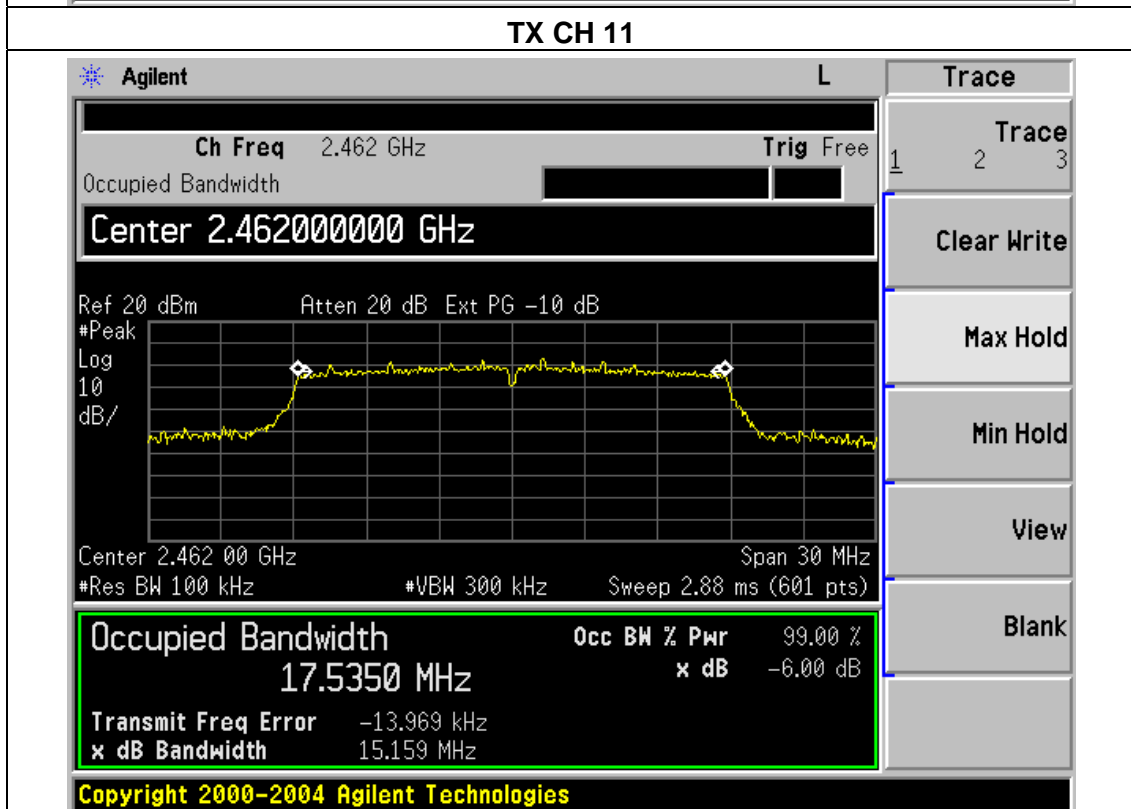
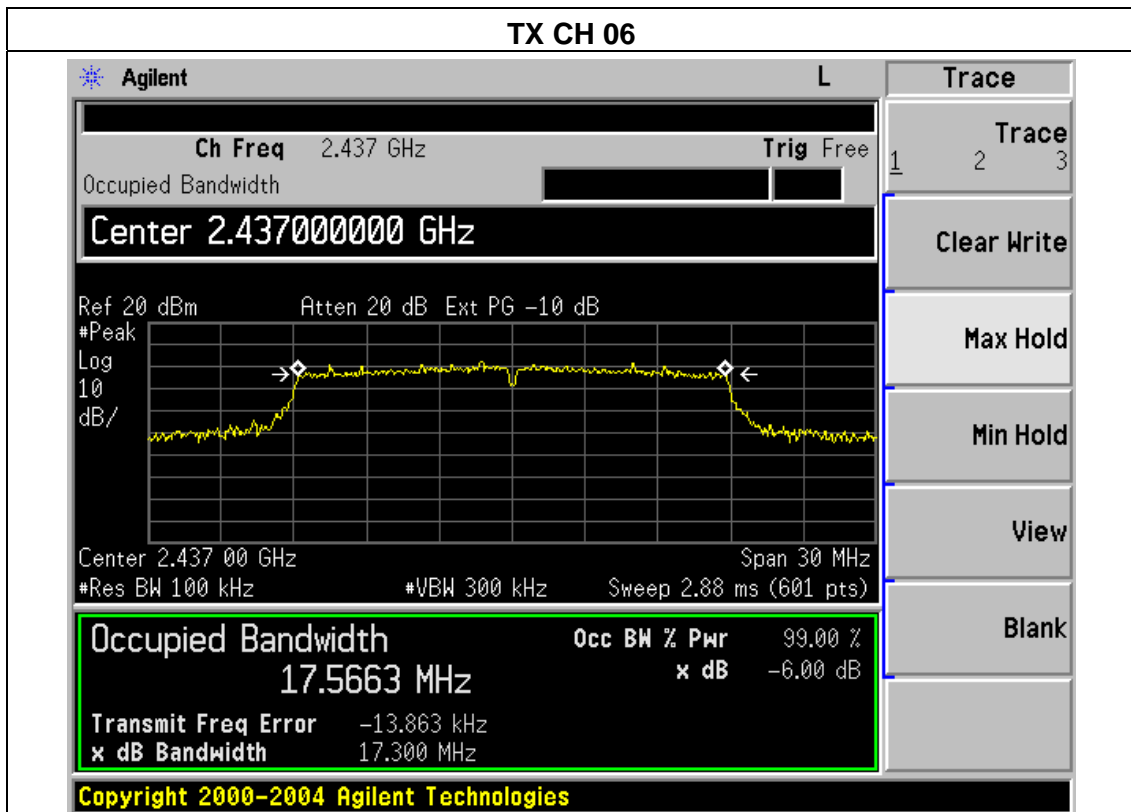



EUT :	Tablet PC	Model Name :	M691
Temperature :	25 °C	Relative Humidity :	56%
Pressure :	1012 hPa	Test Voltage :	DC 3.7V
Test Mode :	TX n Mode(40M) /CH03, CH06, CH09		

Channel	Frequency (MHz)	6dB bandwidth (MHz)	Limit (kHz)	Result
Low	2422	35.351	500	Pass
Middle	2437	35.217	500	Pass
High	2452	35.337	500	Pass

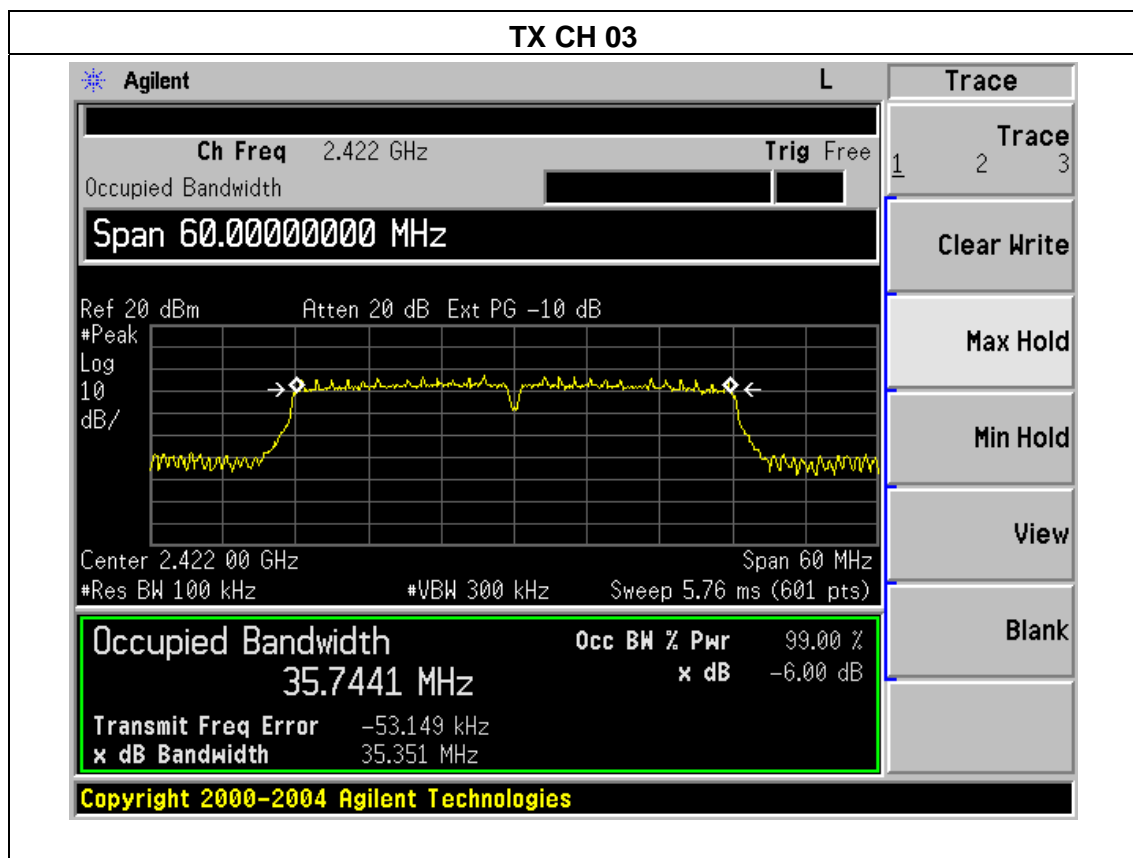

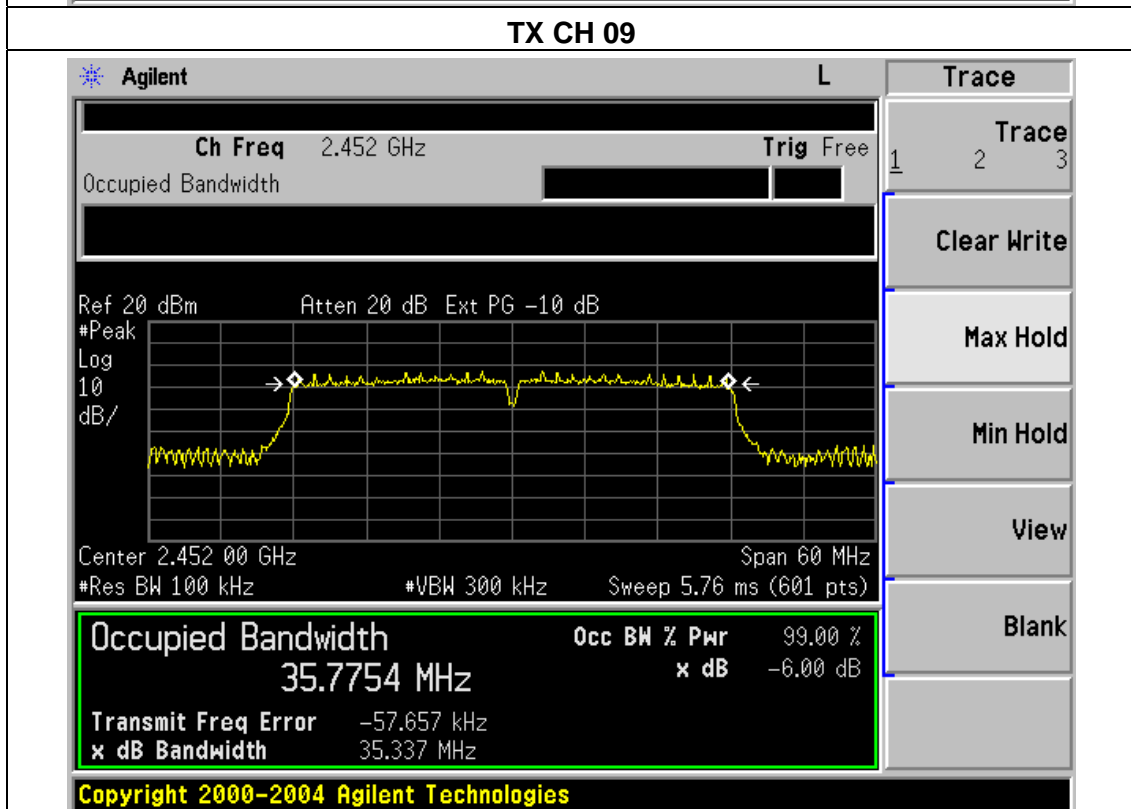
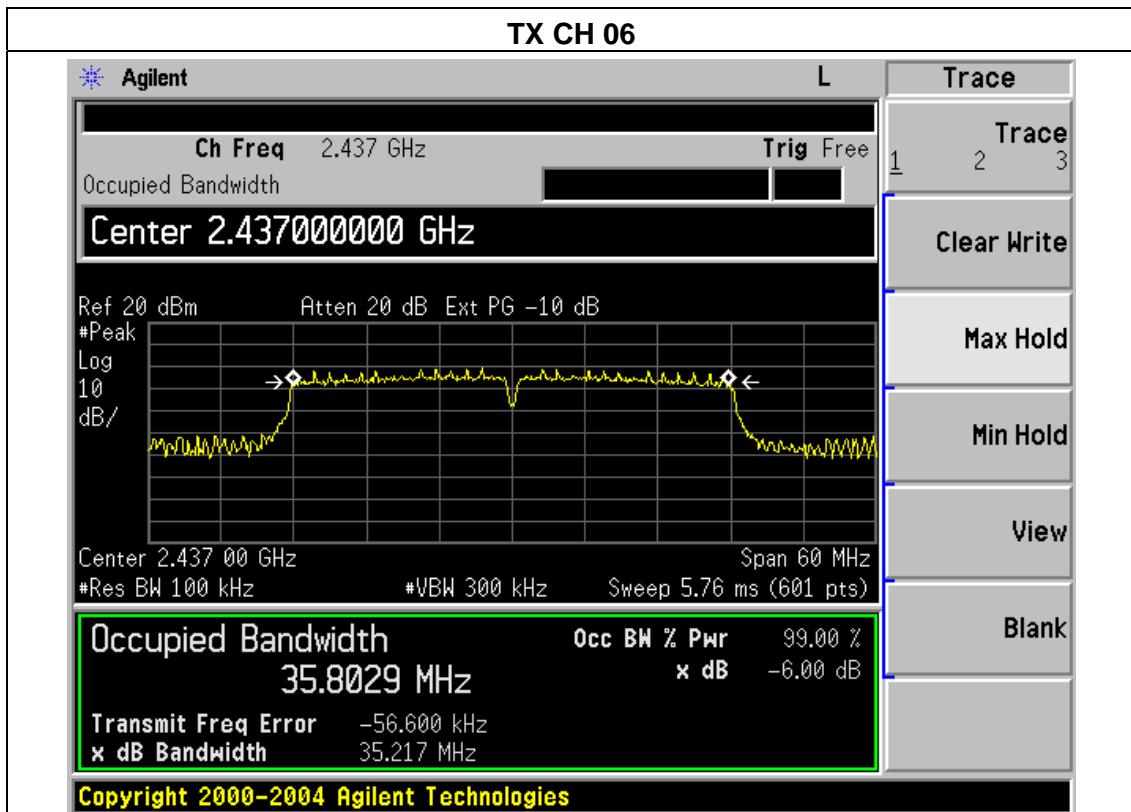

## 6. PEAK OUTPUT POWER TEST

### 6.1 APPLIED PROCEDURES / LIMIT

FCC Part15 (15.247) , Subpart C				
Section	Test Item	Limit	Frequency Range (MHz)	Result
15.247(b)(3)	Peak Output Power	1 watt or 30dBm	2400-2483.5	PASS

#### 6.1.1 TEST PROCEDURE

- a. The EUT was directly connected to the Power meter

#### 6.1.2 DEVIATION FROM STANDARD

No deviation.

#### 6.1.3 TEST SETUP



#### 6.1.4 EUT OPERATION CONDITIONS

The EUT tested system was configured as the statements of 2.4 Unless otherwise a special operating condition is specified in the follows during the testing.

**6.1.5 TEST RESULTS**

EUT :	Tablet PC	Model Name :	M691
Temperature :	25 °C	Relative Humidity :	60%
Pressure :	1012 hPa	Test Voltage :	DC 3.7V
Test Mode :	TX b/g/n20/n40 Mode		

<b>TX 802.11b Mode</b>				
Test Channel	Frequency	Maximum Conducted Output Power(PK)	Maximum Conducted Output Power(AV)	LIMIT
	(MHz)	(dBm)	(dBm)	(dBm)
CH01	2412	15.25	12.43	30
CH06	2437	15.38	12.56	30
CH11	2462	15.36	12.54	30
<b>TX 802.11g Mode</b>				
CH01	2412	13.97	10.84	30
CH06	2437	13.95	10.82	30
CH11	2462	13.88	10.75	30
<b>TX 802.11n-HT20 Mode</b>				
CH01	2412	13.39	11.16	30
CH06	2437	13.38	11.15	30
CH11	2462	13.34	11.11	30
<b>TX 802.11n-HT40 Mode</b>				
CH03	2422	12.59	10.17	30
CH06	2437	12.56	10.14	30
CH09	2452	12.57	10.15	30

## 7. 100 KHZ BANDWIDTH OF FREQUENCY BAND EDGE

### APPLICABLE STANDARD

In any 100 kHz bandwidth outside the frequency band in which the spread spectrum or digitally modulated intentional radiator is operating, the radio frequency power that is produced by the intentional radiator shall be at least 20 dB below that in the 100 kHz bandwidth within the band that contains the highest level of the desired power, based on either an RF conducted or a radiated measurement, provided the transmitter demonstrates compliance with the peak conducted power limits. If the transmitter complies with the conducted power limits based on the use of RMS averaging over a time interval, as permitted under paragraph (b)(3) of this section, the attenuation required under this paragraph shall be 30 dB instead of 20 dB. Attenuation below the general limits specified in §15.209(a) is not required. In addition, radiated emissions which fall in the restricted bands, as defined in §15.205(a), must also comply with the radiated emission limits specified in §15.209(a) (see §15.205(c)).

### TEST PROCEDURE

- a) Check the calibration of the measuring instrument using either an internal calibrator or a known signal from an external generator.
- b) Position the EUT without connection to measurement instrument. Turn on the EUT and connect its antenna terminal to measurement instrument via a low loss cable. Then set it to any one measured frequency within its operating range, and make sure the instrument is operated in its linear range.
- c) Set RBW to 100 kHz and VBW of spectrum analyzer to 300 kHz with a convenient frequency span including 100 kHz bandwidth from band edge.
- d) Measure the highest amplitude appearing on spectral display and set it as a reference level. Plot the graph with marking the highest point and edge frequency.
- e) Repeat above procedures until all measured frequencies were complete.

### 7.1 DEVIATION FROM STANDARD

No deviation.

### 7.2 TEST SETUP

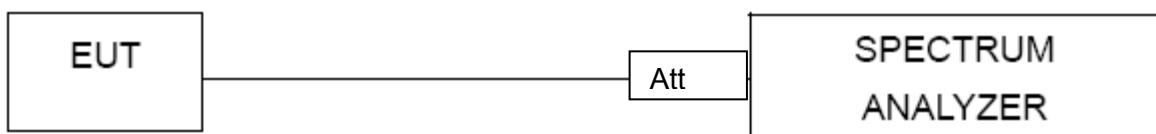

### 7.3 EUT OPERATION CONDITIONS

The EUT tested system was configured as the statements of 2.4 Unless otherwise a special operating condition is specified in the follows during the testing.

**7.4 TEST RESULTS**

EUT :	Tablet PC	Model Name :	M691
Temperature :	25 °C	Relative Humidity :	56%
Pressure :	1012 hPa	Test Voltage :	DC 3.7V

Frequency Band	Delta Peak to band emission (dBc)	> Limit (dBc)	Result
802.11b			
Left-band	39.75	20	Pass
Right-band	54.93	20	Pass
802.11g			
Left-band	32.25	20	Pass
Right-band	40.59	20	Pass
802.11n20			
Left-band	33.34	20	Pass
Right-band	39.74	20	Pass
802.11n40			
Left-band	37.00	20	Pass
Right-band	39.96	20	Pass

## Radiated band edge:

Frequency (MHz)	Meter Reading (dB $\mu$ V)	Factor (dB)	Emission Level (dB $\mu$ V/m)	Limits (dB $\mu$ V/m)	Margin (dB)	Detector Type	Comment
<b>802.11b</b>							
2390	58.82	-13.06	45.76	74	-28.24	peak	Vertical
2390	58.55	-13.06	45.49	74	-28.51	peak	Horizontal
2483.5	59.74	-12.78	46.96	74	-27.04	peak	Vertical
2483.5	59.76	-12.78	46.98	74	-27.02	peak	Horizontal
<b>802.11g</b>							
2390	58.45	-13.06	45.39	74	-28.61	peak	Vertical
2390	57.63	-13.06	44.57	74	-29.43	peak	Horizontal
2483.5	59.12	-12.78	46.34	74	-27.66	peak	Vertical
2483.5	59.51	-12.78	46.73	74	-27.27	peak	Horizontal
<b>802.11n20</b>							
2390	61.24	-13.06	48.18	74	-25.82	peak	Vertical
2390	61.02	-13.06	47.96	74	-26.04	peak	Horizontal
2483.5	61.16	-12.78	48.38	74	-25.62	peak	Vertical
2483.5	61.36	-12.78	48.58	74	-25.42	peak	Horizontal
<b>802.11n40</b>							
2390	62.32	-13.06	49.26	74	-24.74	peak	Vertical
2390	63.15	-13.06	50.09	74	-23.91	peak	Horizontal
2483.5	61.65	-12.78	48.87	74	-25.13	peak	Vertical
2483.5	61.62	-12.78	48.84	74	-25.16	peak	Horizontal

Note: Test method to see chapter 3.2 . When PK value is lower than the Average value limit, average not record.

802.11b: Band Edge, Left Side

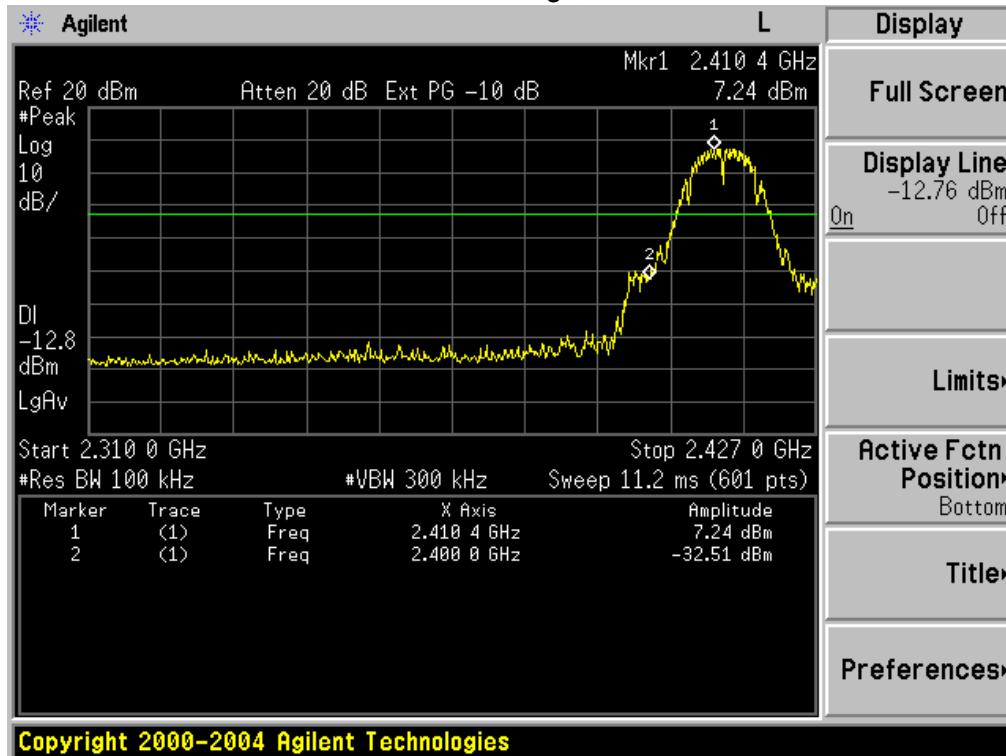

802.11b: Band Edge, Right Side

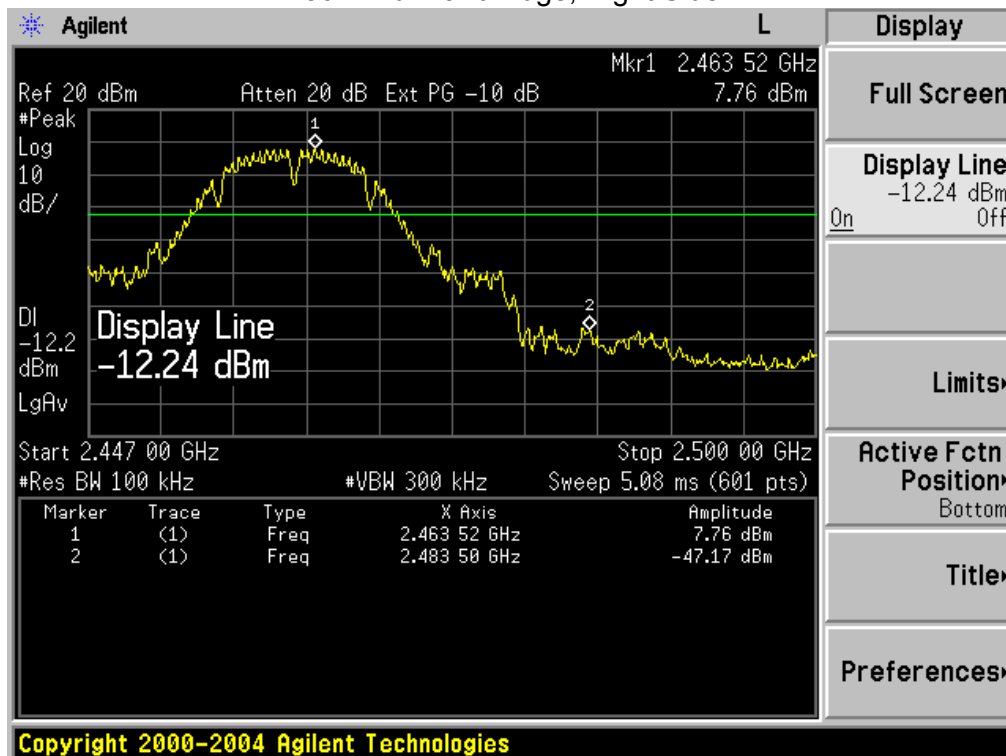



802.11g: Band Edge, Left Side

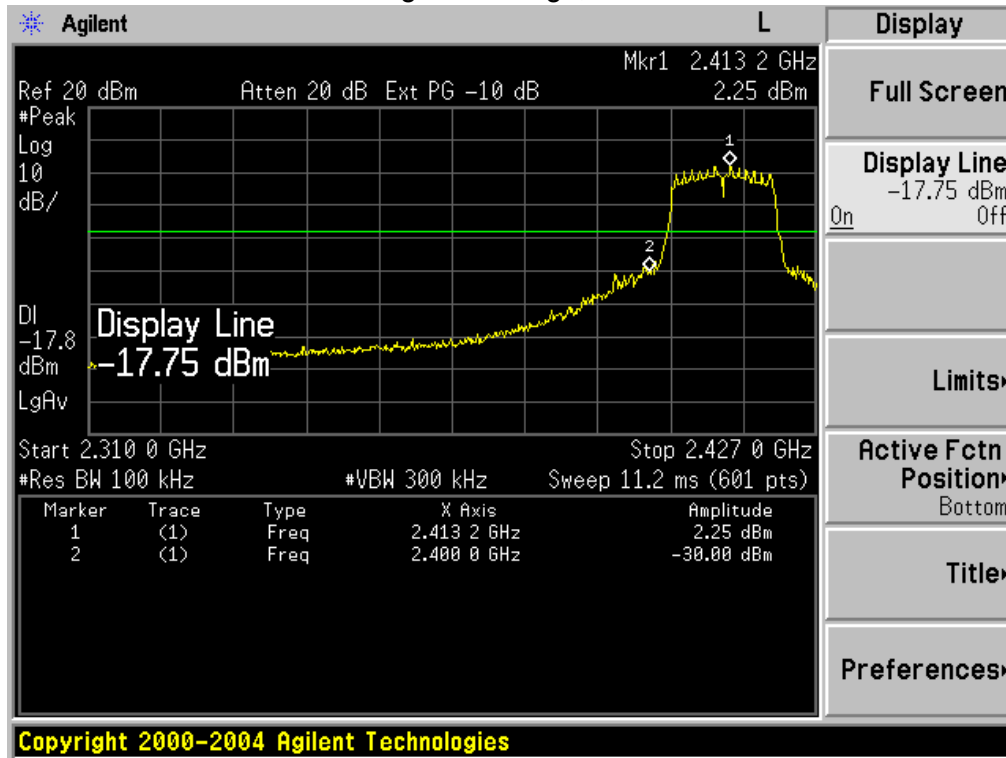

802.11g: Band Edge, Right Side

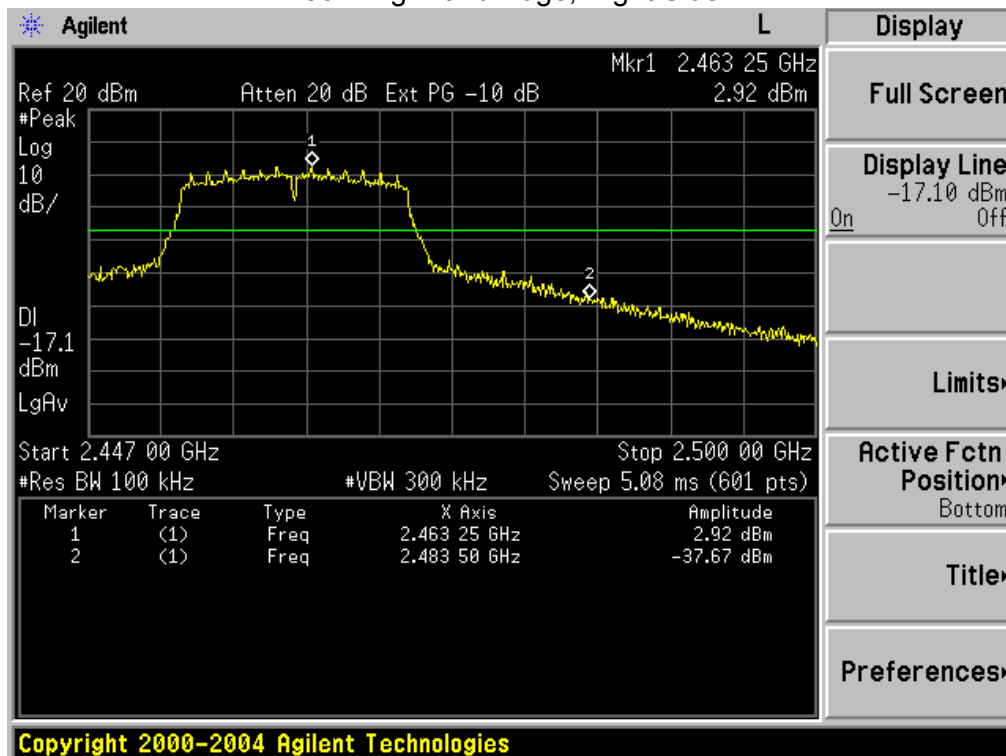

802.11n-HT20: Band Edge, Left Side

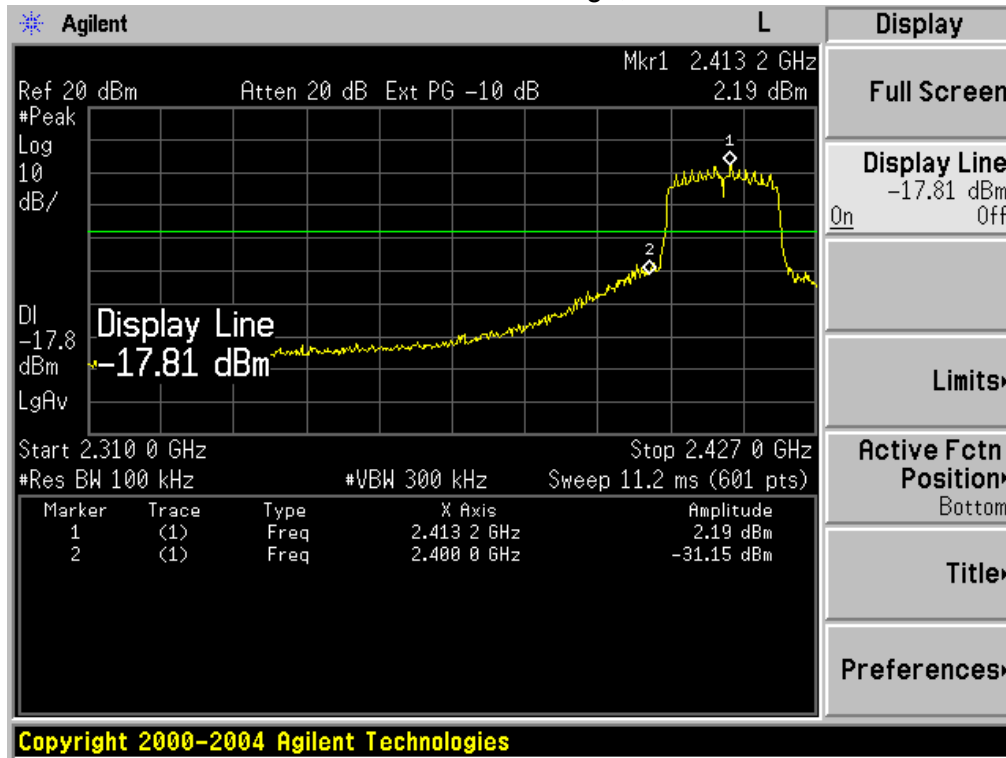

802.11n-HT20: Band Edge, Right Side

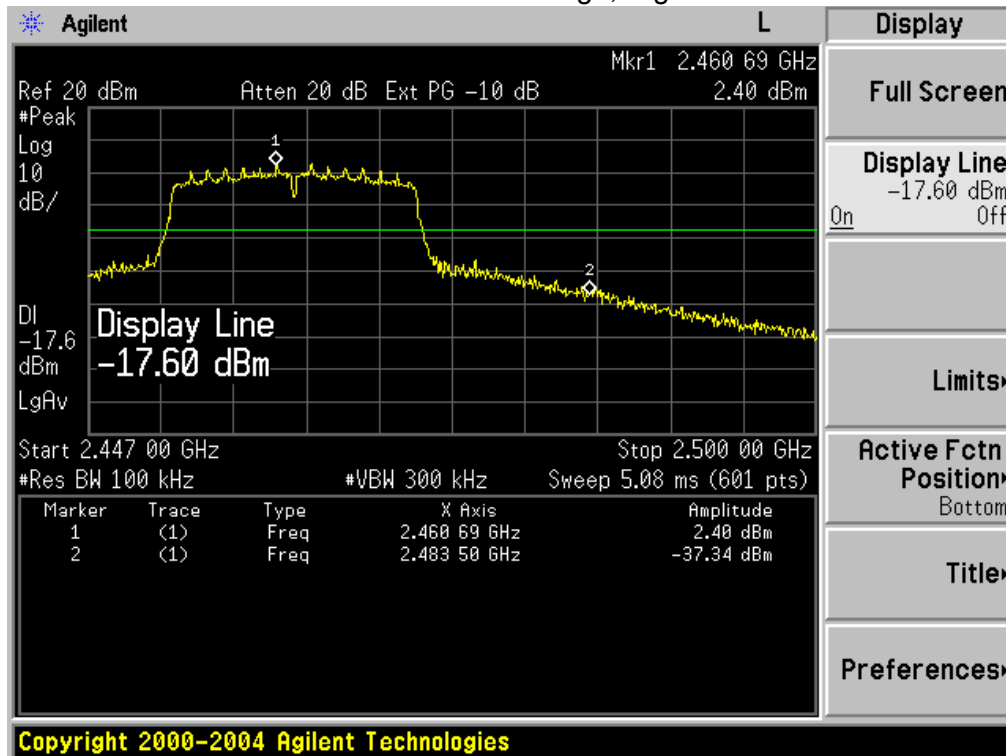

802.11n-HT40: Band Edge, Left Side

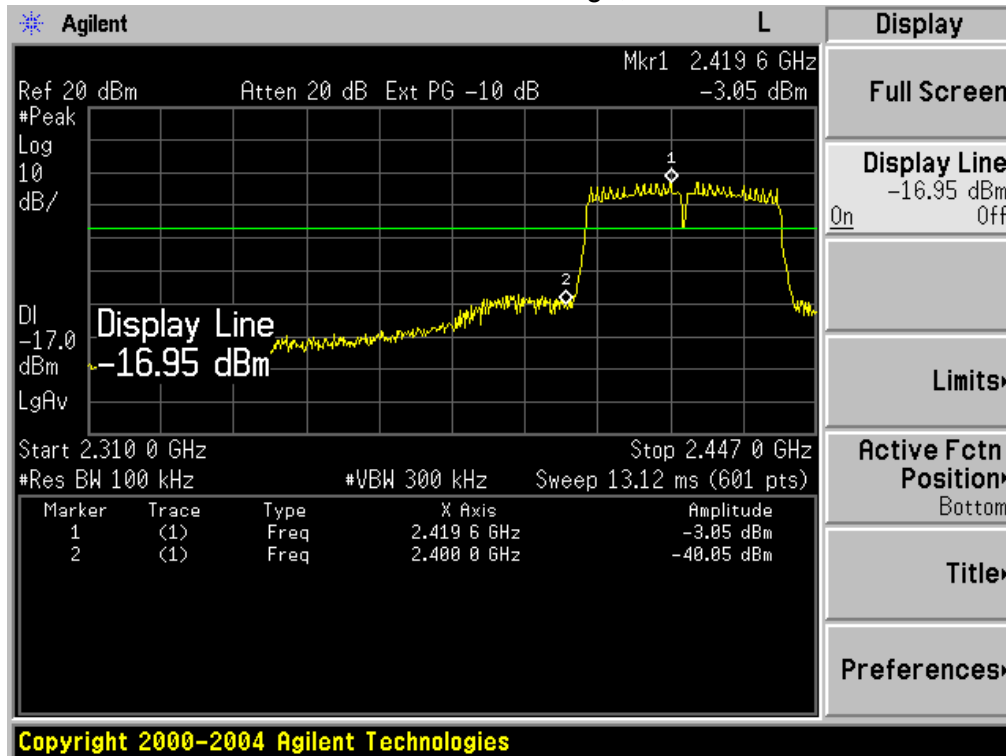

802.11n-HT40: Band Edge, Right Side

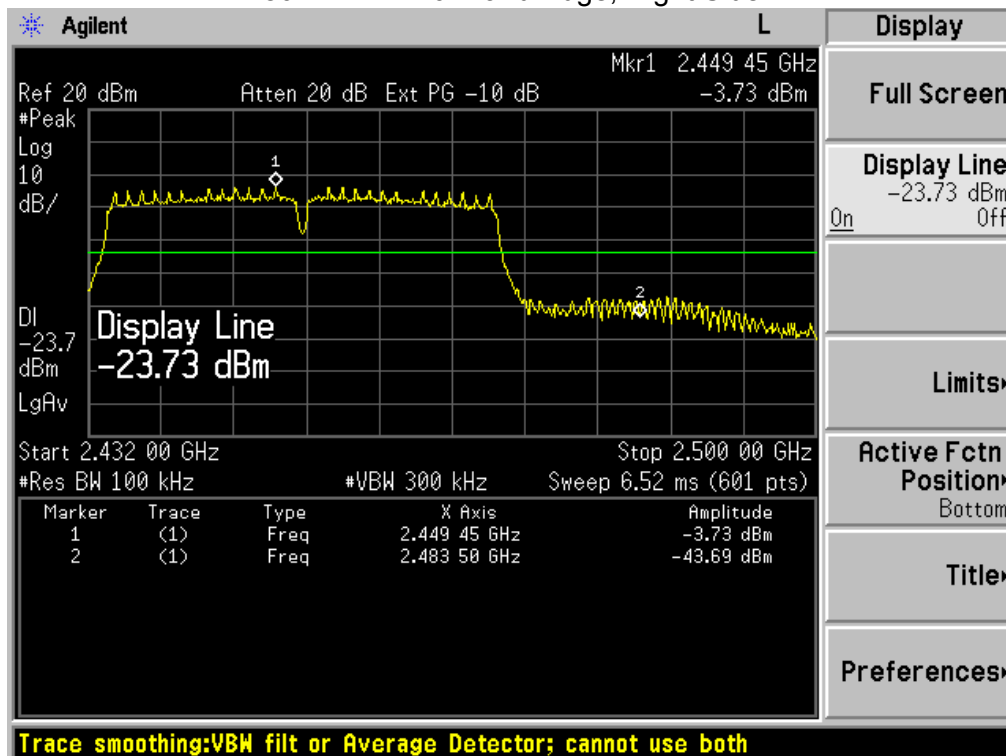

## **8. ANTENNA REQUIREMENT**

### **8.1 STANDARD REQUIREMENT**

15.203 requirement: For intentional device, according to 15.203: an intentional radiator shall be designed to ensure that no antenna other than that furnished by the responsible party shall be used with the device.

### **8.2 EUT ANTENNA**

The EUT antenna is permanent attached antenna. It comply with the standard requirement.

**----END OF REPORT----**