

### FCC Report (GSM&WCDMA)

**Applicant:** AOC

**Address of Applicant:** 8F-3, No. 166, Jian 1 Road, Zhonghe Dist., New Taipei City  
23511, Taiwan

**Equipment Under Test (EUT)**

Product Name: Smart phone

Model No.: E40

**FCC ID:** 2AEB5-E40

**Applicable standards:** FCC CFR Title 47 Part 2: 2014  
FCC CFR Title 47 Part22 Subpart H: 2014  
FCC CFR Title 47 Part24 Subpart E: 2014

**Date of sample receipt:** March 27, 2015

**Date of Test:** March 30-April 09, 2015

**Date of report issued:** April 10, 2015

**Test Result :** PASS \*

\* In the configuration tested, the EUT complied with the standards specified above.

Authorized Signature:



**Robinson Lo**

**Laboratory Manager**

This report details the results of the testing carried out on one sample. The results contained in this test report do not relate to other samples of the same product and does not permit the use of the GTS product certification mark. The manufacturer should ensure that all products in series production are in conformity with the product sample detailed in this report.

This report may only be reproduced and distributed in full. If the product in this report is used in any configuration other than that detailed in the report, the manufacturer must ensure the new system complies with all relevant standards. Any mention of GTS or testing done by GTS in connection with, distribution or use of the product described in this report must be approved by GTS in writing.

This document cannot be reproduced except in full, without prior written approval of the Company. Any unauthorized alteration, forgery or falsification of the content or appearance of this document is unlawful and offenders may be prosecuted to the fullest extent of the law. Unless otherwise stated the results shown in this test report refer only to the sample(s) tested and such sample(s) are retained for 90 days only.

## 2 Version

Version No.	Date	Description
00	April 10, 2015	Original

Prepared By:

*Edward Pan*

Date:

April 10, 2015

Project Engineer

Check By:

*Hank Yan*

Date:

April 10, 2015

Reviewer

### 3 Contents

Page

1	COVER PAGE .....	1
2	VERSION .....	2
3	CONTENTS .....	3
4	TEST SUMMARY .....	4
5	GENERAL INFORMATION .....	5
5.1	CLIENT INFORMATION.....	5
5.2	GENERAL DESCRIPTION OF EUT .....	5
5.3	RELATED SUBMITTAL(S) / GRANT (S) .....	7
5.4	TEST METHODOLOGY.....	7
5.5	TEST FACILITY .....	7
5.6	TEST LOCATION.....	7
6	TEST INSTRUMENTS LIST .....	8
7	SYSTEM TEST CONFIGURATION .....	9
7.1	TEST MODE .....	9
7.2	CONFIGURATION OF TESTED SYSTEM .....	10
7.3	CONDUCTED PEAK OUTPUT POWER .....	11
7.4	OCCUPY BANDWIDTH.....	13
7.5	MODULATION CHARACTERISTIC.....	21
7.6	OUT OF BAND EMISSION AT ANTENNA TERMINALS.....	21
7.7	ERP, EIRP MEASUREMENT .....	30
7.8	FIELD STRENGTH OF SPURIOUS RADIATION MEASUREMENT.....	38
7.9	FREQUENCY STABILITY V.S. TEMPERATURE MEASUREMENT.....	44
7.10	FREQUENCY STABILITY V.S. VOLTAGE MEASUREMENT .....	48
8	TEST SETUP PHOTO .....	52
9	EUT CONSTRUCTIONAL DETAILS .....	54

## 4 Test Summary

Test Item	Section in CFR 47	Result
RF Exposure (SAR)	Part 1.1307 Part 2.1093	Pass* (Please refer to SAR Report)
RF Output Power	Part 2.1046 Part 22.913 (a)(2) Part 24.232 (c)	Pass
Modulation Characteristics	Part 2.1047	Pass
99% & -26 dB Occupied Bandwidth	Part 2.1049 Part 22.917 Part 24.238	Pass
Spurious Emissions at Antenna Terminal	Part 2.1051 Part 22.917 (a) Part 24.238 (a)	Pass
Field Strength of Spurious Radiation	Part 2.1053 Part 22.917 (a) Part 24.238 (a)	Pass
Out of band emission, Band Edge	Part 22.917 (a) Part 24.238 (a)	Pass
Frequency stability vs. temperature	Part 2.1055(a)(1)(b)	Pass
Frequency stability vs. voltage	Part 2.1055(d)(1)(2)	Pass

*Pass: The EUT complies with the essential requirements in the standard.*

## 5 General Information

### 5.1 Client Information

Applicant:	AOC
Address of Applicant:	8F-3, No. 166, Jian 1 Road, Zhonghe Dist., New Taipei City 23511, Taiwan
Manufacturer:	New Flying
Address of Manufacturer:	10/F Block C, Tairan Building, Tairan 8 Road, Chegongmiao, District, Shenzhen City, Guangdong Province, China

### 5.2 General Description of EUT

Product Name:	Smart phone
Model No.:	E40
Support Networks:	GSM, GPRS, WCDMA
Support Bands:	GSM850, PCS1900, WCDMA Band II, Band V
TX Frequency:	GSM850: 824.20MHz-848.80MHz PCS1900: 1850.20MHz-1909.80MHz WCDMA Band II: 1852.40MHz -1907.60MHz WCDMA Band V: 826.40MHz -846.60MHz
GPRS Class:	12
Modulation type:	GSM/GPRS: GMSK WCDMA Band II/V: QPSK
IMEI:	357659060200443 357659060200450
Hardware Version:	A809TLTMB0270C
Software Version:	a809b_aoc_dr_72kk_band25_3g_2sim_wvga_es_kk1.mp7.v1.22.2.01_loger_20141225_14
Antenna type:	PIFA antenna
Antenna gain:	1.0dBi(GSM850) 1.0dBi(DCS1900)
Power supply:	Model No.: YHD-GH002S Input: AC 100-240V, 50/60Hz, 0.3A Output: DC 5.0V, 1A DC 3.7V Li-ion Battery

**Operation Frequency List:**

GSM 850		PCS1900		WCDMA Band V		WCDMA Band II	
Channel	Frequency (MHz)	Channel	Frequency (MHz)	Channel	Frequency (MHz)	Channel	Frequency (MHz)
128	824.20	512	1850.20	4132	826.40	9262	1852.40
129	824.40	513	1850.40	4133	826.60	9263	1852.60
· ∴	· ∴	· ∴	· ∴	· ∴	· ∴	· ∴	· ∴
189	836.40	660	1879.80	4181	836.20	9399	1879.80
190	836.60	661	1880.00	4182	836.40	9400	1880.00
191	836.80	662	1880.20	4183	836.60	9401	1880.20
· ∴	· ∴	· ∴	· ∴	· ∴	· ∴	· ∴	· ∴
250	848.60	809	1909.60	4232	846.40	9537	1907.40
251	848.80	810	1909.80	4233	846.60	9538	1907.60

Regards to the operating frequency range over 10 MHz, the Lowest frequency, the middle frequency, and the highest frequency of channel were selected to perform the test, and the selected channel see below:

**Final test channel:**

GSM 850		PCS1900		WCDMA Band V		WCDMA Band II	
Channel	Frequency (MHz)	Channel	Frequency (MHz)	Channel	Frequency (MHz)	Channel	Frequency (MHz)
128	824.20	512	1850.20	4132	826.40	9262	1852.40
190	836.60	661	1880.00	4183	836.60	9400	1880.00
251	848.80	810	1909.80	4233	846.60	9538	1907.60

### 5.3 Related Submittal(s) / Grant (s)

This submittal(s) (test report) is filing to comply with Section Part 22 subpart H and Part 24 subpart E of the FCC CFR 47 Rules.

### 5.4 Test Methodology

Both conducted and radiated testing were performed according to the procedures document on TIA/EIA 603 and FCC CFR 47.1046, 2.1047, 2.1049, 2.1051, 2.1053, 2.1055 and 2.1057

### 5.5 Test Facility

The test facility is recognized, certified, or accredited by the following organizations:

- **CNAS —Registration No.: CNAS L5775**

CNAS has accredited Global United Technology Services Co., Ltd. To ISO/IEC 17025 General Requirements for the competence of testing and calibration laboratories (CNAS-CL01 Accreditation Criteria for the Competence of Testing and Calibration Laboratories) for the competence in the field of testing.

- **FCC —Registration No.: 600491**

Global United Technology Services Co., Ltd., Shenzhen EMC Laboratory has been registered and fully described in a report filed with the (FCC) Federal Communications Commission. The acceptance letter from the FCC is maintained in files. Registration 600491, June 28, 2013.

- **Industry Canada (IC) —Registration No.: 9079A-2**

The 3m Semi-anechoic chamber of Global United Technology Services Co., Ltd. has been registered by Certification and Engineering Bureau of Industry Canada for radio equipment testing with Registration No.: 9079A-2, June 26, 2013.

### 5.6 Test Location

All tests were performed at:

Global United Technology Services Co., Ltd.

Address: Room 301-309, 3th Floor, Block A, Huafeng Jinyuan Business Building, No. 300 Laodong Industrial Zone, Xixiang Road, Baoan District, Shenzhen 518102

Tel: 0755-27798480

Fax: 0755-27798960

## 6 Test Instruments list

Item	Test Equipment	Manufacturer	Model No.	Inventory No.	Cal.Date (mm-dd-yy)	Cal.Due date (mm-dd-yy)
1	3m Semi- Anechoic Chamber	ZhongYu Electron	9.2(L)*6.2(W)* 6.4(H)	GTS250	Mar. 27 2015	Mar. 26 2016
2	Control Room	ZhongYu Electron	6.2(L)*2.5(W)* 2.4(H)	GTS251	N/A	N/A
3	EMI Test Receiver	Rohde & Schwarz	ESU26	GTS203	July 01 2014	June 30 2015
4	BiConiLog Antenna	SCHWARZBECK MESS-ELEKTRONIK	VULB9163	GTS214	July 01 2014	June 30 2015
5	Double -ridged waveguide horn	SCHWARZBECK MESS-ELEKTRONIK	9120D-829	GTS208	June 27 2014	June 26 2015
6	Horn Antenna	ETS-LINDGREN	3160	GTS217	Mar. 27 2015	Mar. 26 2016
7	EMI Test Software	AUDIX	E3	N/A	N/A	N/A
8	Coaxial Cable	GTS	N/A	GTS213	Mar. 28 2015	Mar. 27 2016
9	Coaxial Cable	GTS	N/A	GTS211	Mar. 28 2015	Mar. 27 2016
10	Coaxial cable	GTS	N/A	GTS210	Mar. 28 2015	Mar. 27 2016
11	Coaxial Cable	GTS	N/A	GTS212	Mar. 28 2015	Mar. 27 2016
12	Amplifier(100kHz-3GHz)	HP	8347A	GTS204	July 01 2014	June 30 2015
13	Amplifier(2GHz-20GHz)	HP	8349B	GTS206	July 01 2014	June 30 2015
14	Amplifier (18-26GHz)	Rohde & Schwarz	AFS33-18002 650-30-8P-44	GTS218	June 27 2014	June 26 2015
15	Band filter	Amindeon	82346	GTS219	Mar. 28 2015	Mar. 27 2016
16	Universal radio communication tester	Rohde & Schwarz	CMU200	GTS235	May 09 2014	May 08 2015
17	Signal Generator	Rohde & Schwarz	SML03	GTS236	May 09 2014	May 08 2015
18	Temp. Humidity/ Barometer	Oregon Scientific	BA-888	GTS248	May 09 2014	May 08 2015
19	D.C. Power Supply	Instek	PS-3030	GTS232	NA	NA
20	Splitter	Agilent	11636B	GTS237	May 09 2014	May 08 2015
21	Power meter	Rohde & Schwarz	NRVS	GTS238	May 09 2014	May 08 2015
22	Spectrum Analyzer	Agilent	E4440A	GTS533	Dec. 4 2014	Dec. 3 2015
23	Temp.&Humidity chamber	Chuang wei	GDS-225	GTS005-1	May 05 2014	May 06 2015
24	Highpass filter	Micro-Tronics	HPM50108	GTS549	Mar. 28 2015	Mar. 27 2016
25	Highpass filter	Micro-Tronics	HPM50111	GTS550	Mar. 28 2015	Mar. 27 2016



## 7 System test configuration

### 7.1 Test mode

During all testing, EUT is in link mode with base station emulator at maximum power level. The spurious emission measurements were carried out in semi-anechoic chamber with 3-meter test range, and EUT is rotated on three test planes to find out the worst emission.

Test modes		
Band	Radiated	Conducted
<b>GSM 850</b>	<ul style="list-style-type: none"> <li>■ GSM link</li> <li>■ GPRS 1 link</li> </ul>	<ul style="list-style-type: none"> <li>■ GSM link</li> <li>■ GPRS 1 link</li> </ul>
<b>PCS 1900</b>	<ul style="list-style-type: none"> <li>■ GSM link</li> <li>■ GPRS 1 link</li> </ul>	<ul style="list-style-type: none"> <li>■ GSM link</li> <li>■ GPRS 1 link</li> </ul>
<b>WCDMA II</b>	<ul style="list-style-type: none"> <li>■ RMC 12.2Kbps link</li> </ul>	<ul style="list-style-type: none"> <li>■ RMC 12.2Kbps link</li> </ul>
<b>WCDMA Band V</b>	<ul style="list-style-type: none"> <li>■ RMC 12.2Kbps link</li> </ul>	<ul style="list-style-type: none"> <li>■ RMC 12.2Kbps link</li> </ul>

Note: The maximum power levels are GSM mode for GMSK link, GPRS multi-slot class 8 mode for GMSK link, RMC12.2Kbps mode for WCDMA Band V. only these modes were used for all tests.

The conducted power tables are as follows:

Conducted Power (dBm)						
Band	GSM850			PCS1900		
Channel	128	190	251	512	661	810
Frequency	824.20	836.60	848.80	1850.20	1880.00	1909.80
GSM (GMSK, 1 TX slot)	32.35	32.38	32.38	28.22	28.22	28.13
GPRS (GMSK, 1 TX slot)	32.29	32.30	32.35	27.76	27.78	27.70
GPRS (GMSK, 2 TX slot)	31.30	31.16	31.27	27.28	27.17	27.06
GPRS (GMSK, 3 TX slot)	29.75	29.59	29.57	26.14	26.01	25.95
GPRS (GMSK, 4 TX slot)	28.98	28.72	28.72	25.40	25.18	24.84

Conducted Power (dBm)						
Band	WCDMA Band II			WCDMA Band V		
Channel	9262	9400	9538	4132	4183	4233
Frequency	1852.4	1880.0	1907.6	826.4	836.6	846.6
RMC 12.2Kbps	22.45	22.82	22.04	22.45	22.52	22.76
HSDPA Subtest-1	20.52	20.77	20.81	20.53	20.67	20.24
HSDPA Subtest-2	20.66	20.56	20.75	20.34	20.65	20.65
HSDPA Subtest-3	20.42	20.63	20.65	20.26	20.35	20.38
HSDPA Subtest-4	20.65	20.86	20.75	19.21	19.42	20.47
HSUPA Subtest-1	20.23	20.54	20.72	20.25	20.61	20.68
HSUPA Subtest-2	20.56	20.34	20.51	20.65	20.32	20.71
HSUPA Subtest-3	20.35	20.82	20.47	20.61	20.52	20.36
HSUPA Subtest-4	20.23	20.93	20.32	20.15	20.35	20.72
HSUPA Subtest-5	20.12	20.36	20.24	20.06	20.11	20.28
AMR	22.24	22.76	22.02	22.41	22.22	22.43

## 7.2 Configuration of Tested System

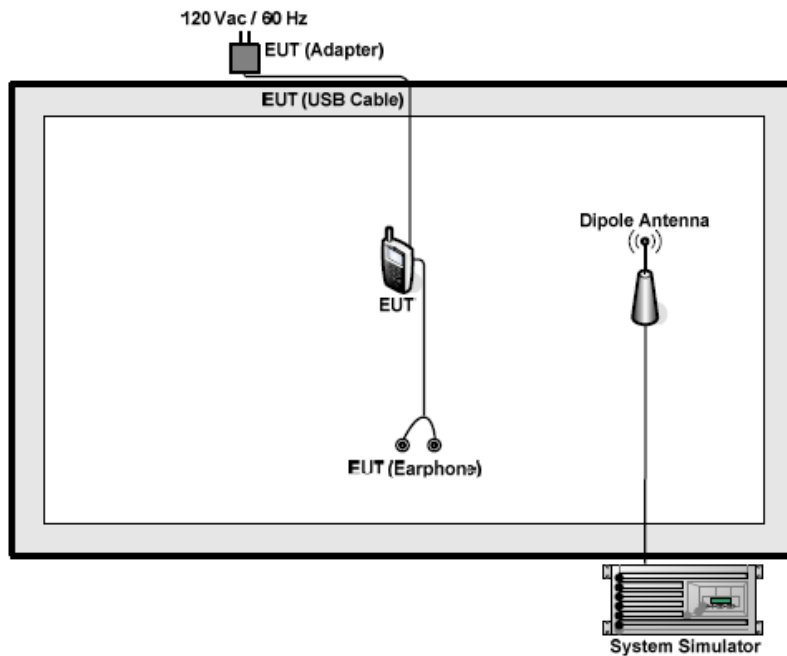

### 7.3 Conducted Peak Output Power

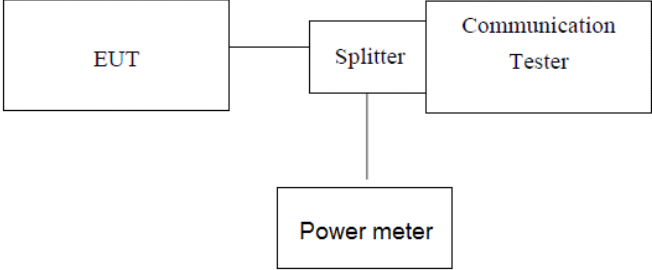
Test Requirement:	FCC part22.913(a) and FCC part24.232(b)
Test Method:	FCC part2.1046
Limit:	GSM850,: 7W PCS1900, WCDMA Band V: 2W
Test setup:	 <p style="text-align: center;"><i>Note: Measurement setup for testing on Antenna connector</i></p>
Test Procedure:	<ol style="list-style-type: none"> <li>1. The transmitter output port was connected to base station.</li> <li>2. The RF output of EUT was connected to the power meter by RF cable and attenuator, the path loss was compensated to the results for each measurement.</li> <li>3. Set EUT at maximum power through base station.</li> <li>4. Select lowest, middle, and highest channels for each band and different modulation.</li> <li>5. Measure the maximum burst average power.</li> </ol>
Test Instruments:	Refer to section 6.0 for details
Test mode:	Refer to section 5.3 for details
Test results:	Pass

Measurement Data

EUT Mode	Channel	Frequency (MHz)	PK power (dBm)
GSM 850 (GSM link)	128	824.20	32.35
	190	836.60	32.38
	251	848.80	32.38
GSM 850 (GPRS 1 link)	128	824.20	32.29
	190	836.60	32.30
	251	848.80	32.39
PCS 1900 (GSM link)	512	1850.20	28.22
	661	1880.00	28.22
	810	1909.80	28.13
PCS 1900 (GPRS 1 link)	512	1850.20	27.76
	661	1880.00	27.78
	810	1909.80	27.70
WCDMA Band V (RMC 12.2Kbps link)	4132	826.40	22.45
	4183	836.60	22.52
	4233	846.60	22.76
WCDMA Band II (RMC 12.2Kbps link)	9262	1852.4	22.45
	9400	1880.0	22.82
	9538	1907.6	22.04

## 7.4 Occupy Bandwidth

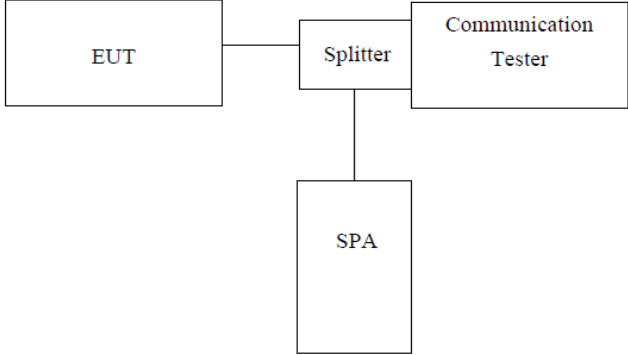
Test Requirement:	FCC part22.913(a) and FCC part24.232(b)
Test Method:	FCC part2.1049
Test setup:	 <p><i>Note: Measurement setup for testing on Antenna connector</i></p>
Test Procedure:	<ol style="list-style-type: none"> <li>1. The EUT's output RF connector was connected with a short cable to the spectrum analyzer</li> <li>2. RBW was set to about 1% of emission BW, VBW= 3 times RBW.</li> <li>3. -26dBc display line was placed on the screen (or 99% bandwidth), the occupied bandwidth is the delta frequency between the two points where the display line intersects the signal trace.</li> </ol>
Test Instruments:	Refer to section 6.0 for details
Test mode:	Refer to section 5.3 for details
Test results:	Pass

Measurement Data

EUT Mode	Channel	Frequency (MHz)	99% Occupy bandwidth (KHz)	-26dB bandwidth (KHz)
GSM 850 (GSM link)	128	824.20	249.999	321.946
	190	836.60	246.592	321.983
	251	848.80	249.621	323.315
GSM 850 (GPRS 1 link)	128	824.20	250.456	326.998
	190	836.60	241.175	311.411
	251	848.80	247.050	317.605
PCS 1900 (GSM link)	512	1850.20	242.370	314.419
	661	1880.00	247.598	315.870
	810	1909.80	254.304	323.346
PCS 1900 (GPRS 1 link)	512	1850.20	250.909	319.396
	661	1880.00	250.250	320.213
	810	1909.80	245.349	322.561
WCDMA Band V (RMC 12.2Kbps link)	4132	826.40	4173.00	4702.00
	4183	836.60	4154.50	4690.00
	4233	846.60	4154.70	4706.00
WCDMA Band II (RMC 12.2Kbps link)	9262	1852.4	4166.50	4712.00
	9400	1880.0	4164.40	4710.00
	9538	1907.6	4169.30	4731.00

Test plot as follows:

Test band: GSM 850 (GSM link)

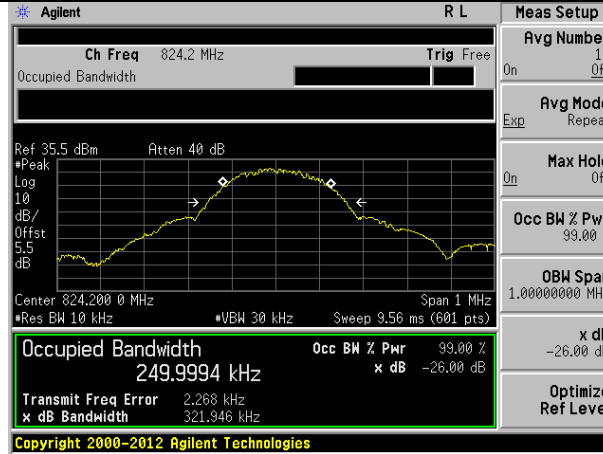

Lowest channel

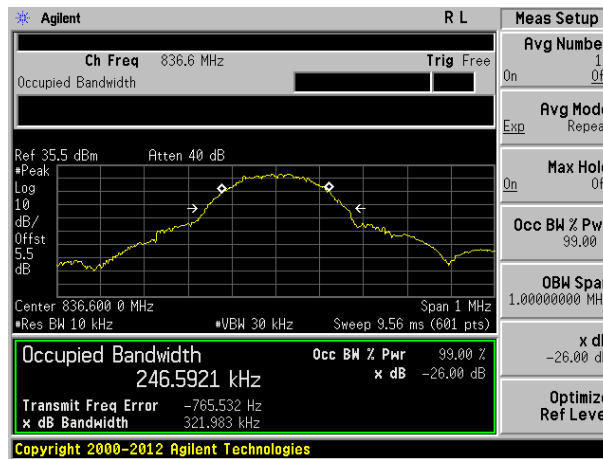

Middle channel

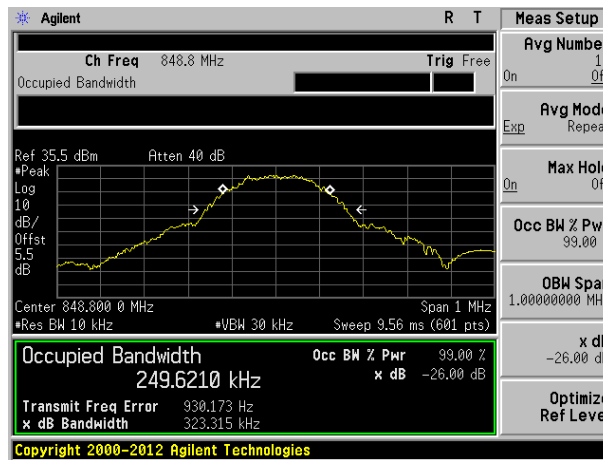

Highest channel

Test band: GSM 850 (GPRS 1 link)

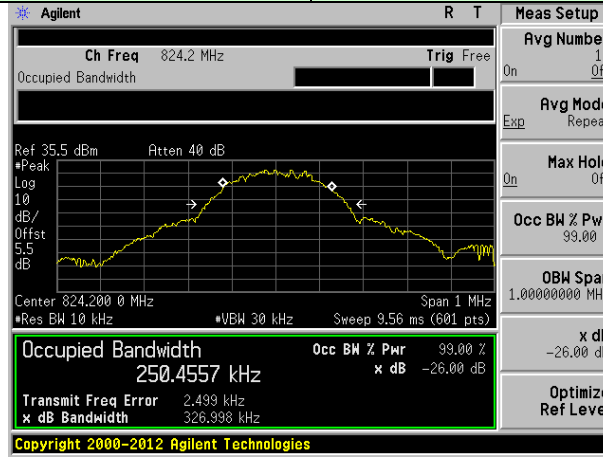

Lowest channel

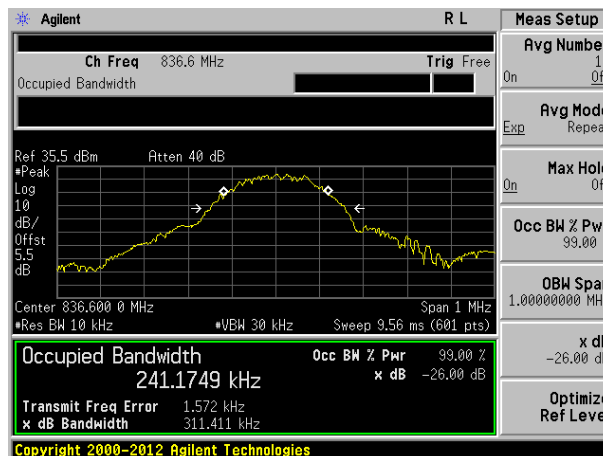

Middle channel

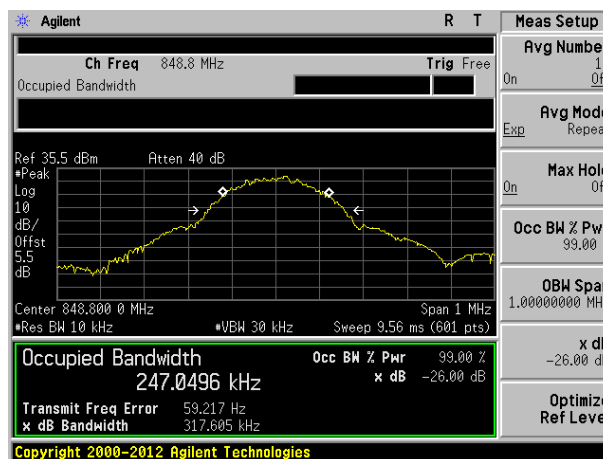

Highest channel



Test band: PCS 1900 (GSM link)

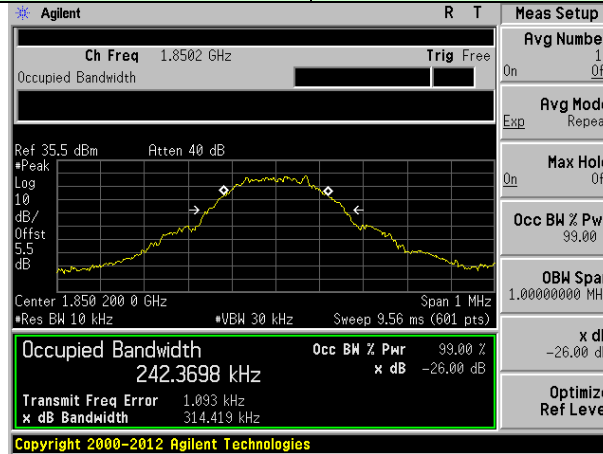

Lowest channel

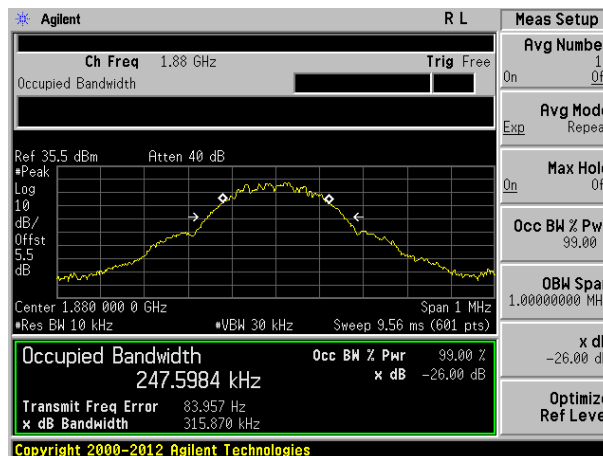

Middle channel

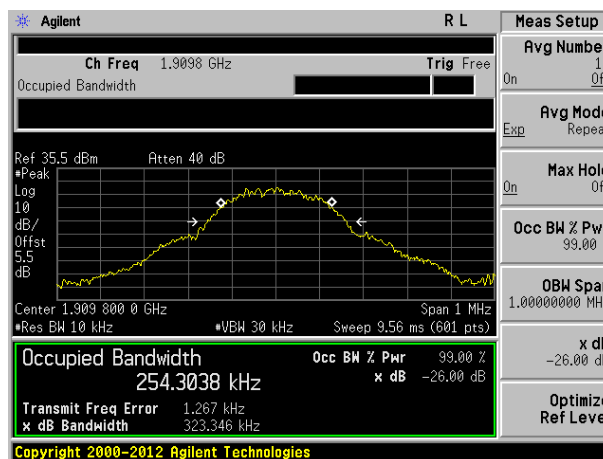

Highest channel

Test band: PCS 1900 (GPRS 1 link)

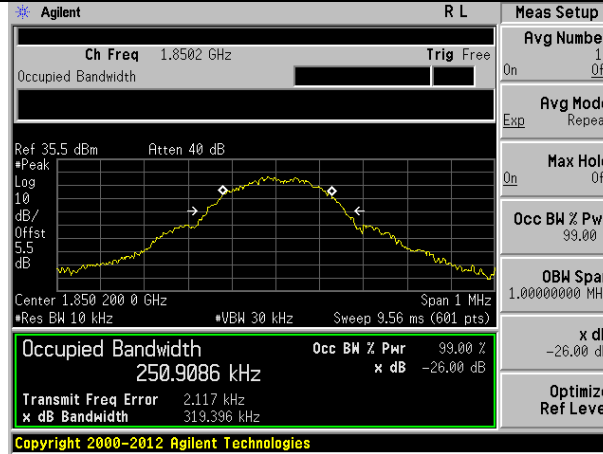

Lowest channel

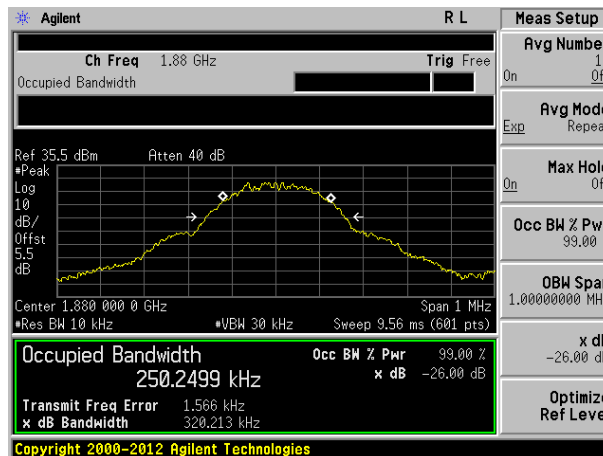

Middle channel

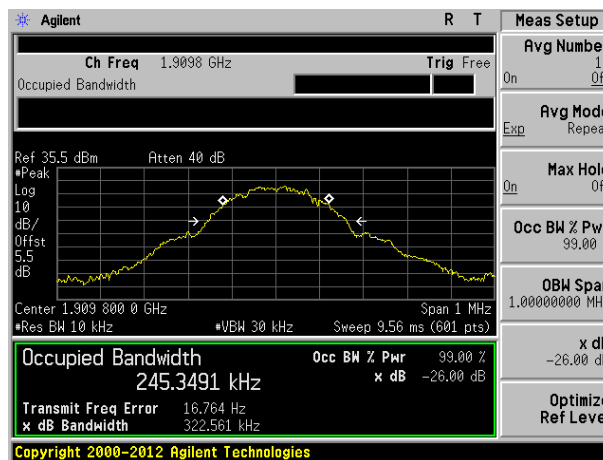

Highest channel

Test band: WCDMA Band V (RMC 12.2Kbps link)

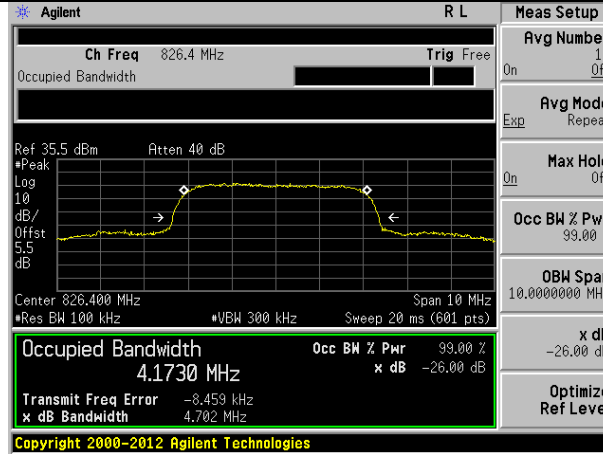

Lowest channel

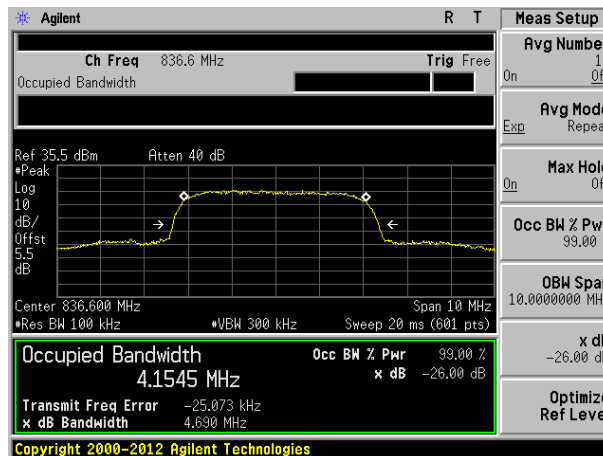

Middle channel

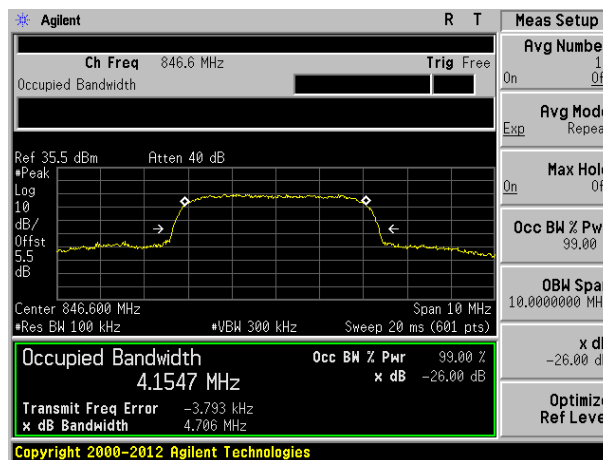

Highest channel:

Test band: WCDMA Band II (RMC 12.2Kbps link)

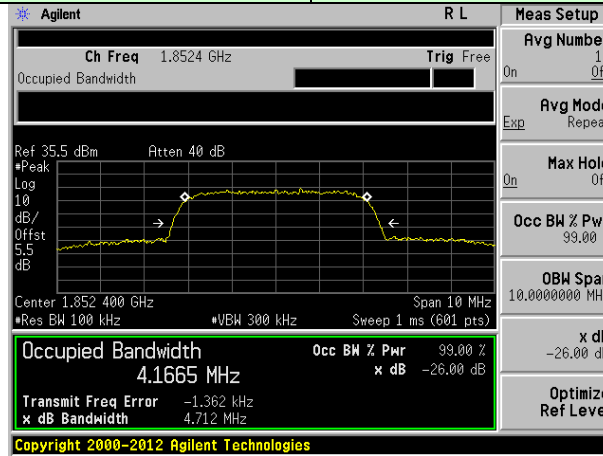

Lowest channel

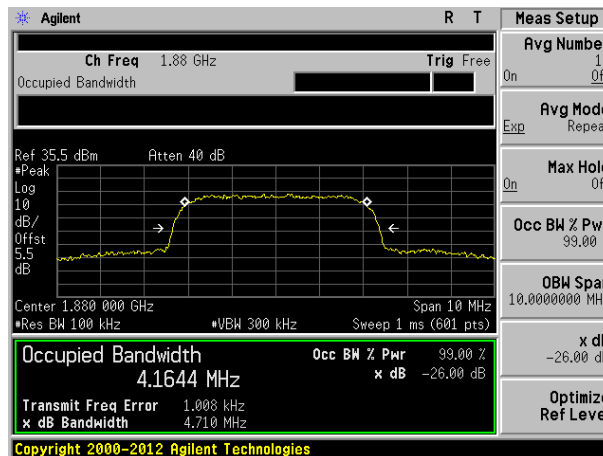

Middle channel

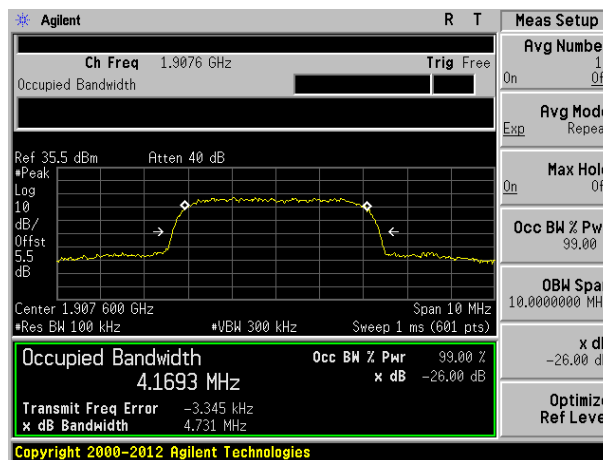

Highest channel:

## 7.5 MODULATION CHARACTERISTIC

According to FCC § 2.1047(d), Part 22H & 24E there is no specific requirement for digital modulation, therefore modulation characteristic is not presented.

## 7.6 Out of band emission at antenna terminals

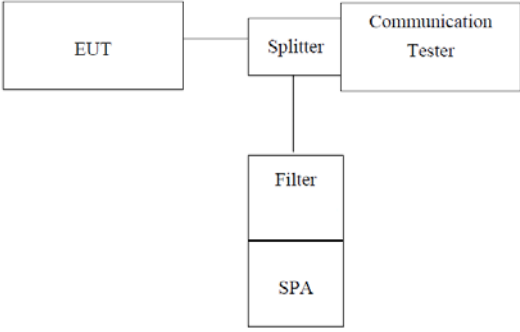
Test Requirement:	FCC part22.917(a) and FCC part24.238(a)
Test Method:	FCC part2.1051
Limit:	-13dBm
Test setup:	 <p style="text-align: center;"><i>Note: Measurement setup for testing on Antenna connector</i></p>
Test Procedure:	<ol style="list-style-type: none"> <li>1 The RF output of the transceiver was connected to a spectrum analyzer through appropriate attenuation.</li> <li>2 The resolution bandwidth of the spectrum analyzer was set at 1MHz, sufficient scans were taken to show the out of band Emissions if any up to 10th harmonic.</li> <li>3 For the out of band: Set the RBW, VBW = 1MHz, Start=30MHz, Stop= 10th harmonic.</li> <li>4 Band Edge Requirements: In the 1 MHz bands immediately outside and adjacent to the frequency block, a resolution bandwidth of at least 1 percent of the emission bandwidth of the fundamental emission of the transmitter may be employed to measure the out of band Emissions.</li> </ol>
Test Instruments:	Refer to section 6.0 for details
Test mode:	Refer to section 5.3 for details
Test results:	Pass

Test plot as follows:

Note: During the conducted spurious emission test, a band filter was used. The information of the filter is reported at section 6.0 (refer to item 24, 25).

Test Mode: Traffic mode GSM 850 (GSM link)

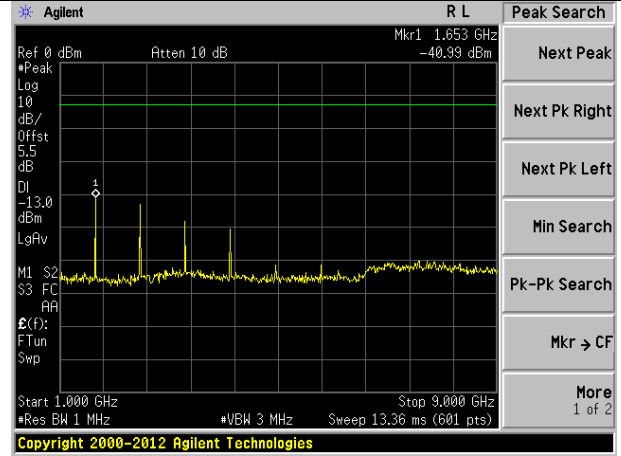
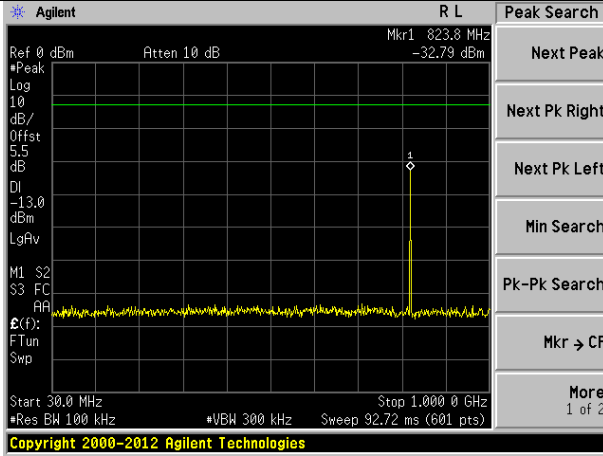

Lowest channel

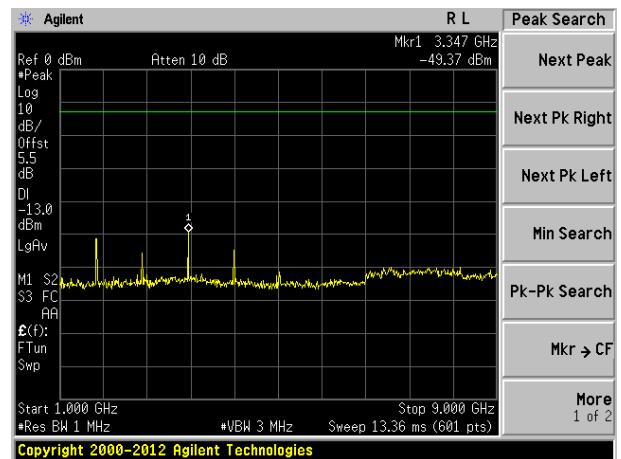
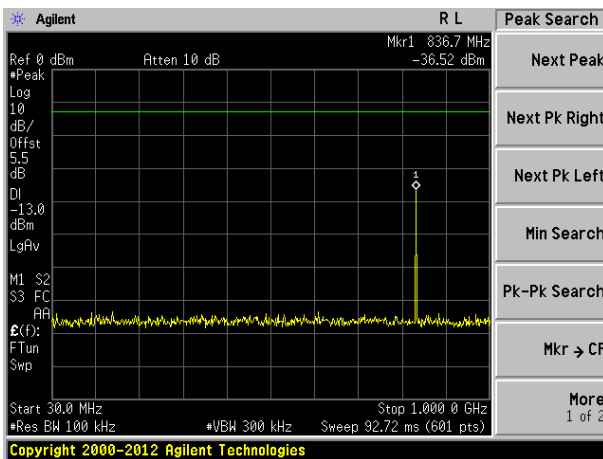

Middle channel

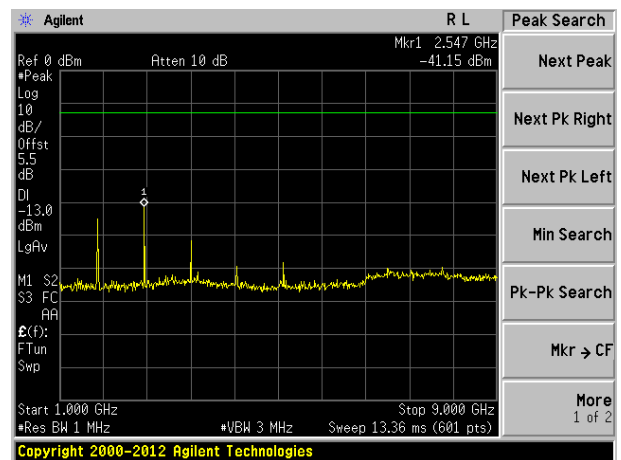
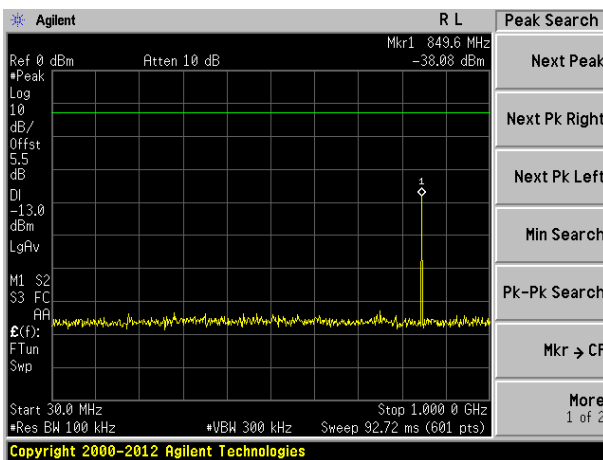

Highest channel

Test Mode: Traffic mode GSM 850 (GPRS 1 link)

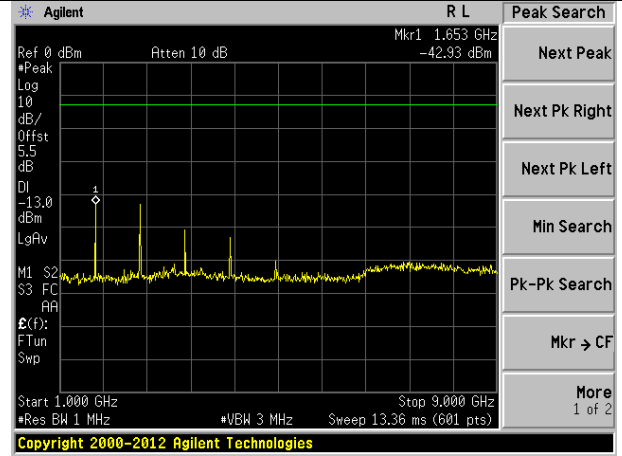
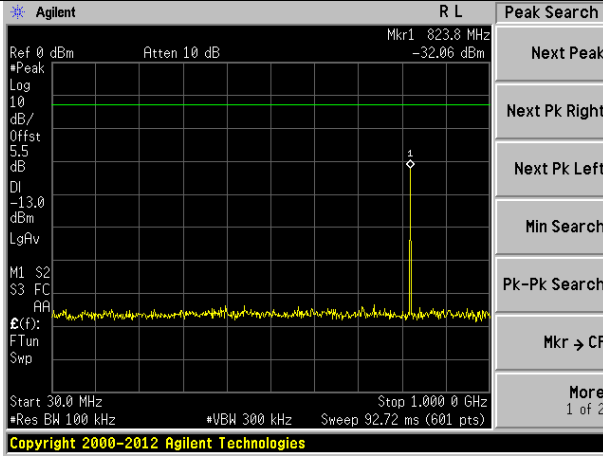

Lowest channel

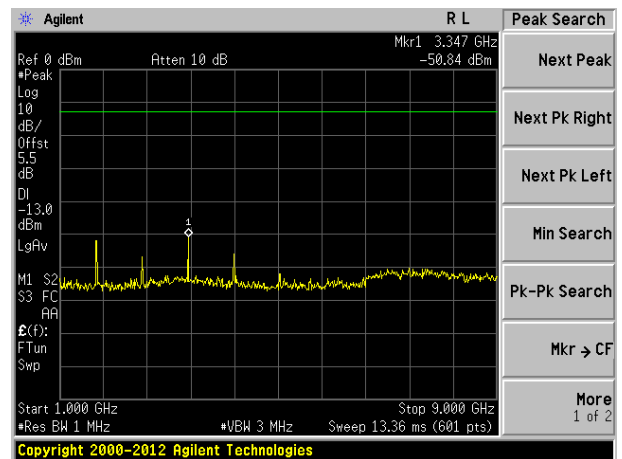
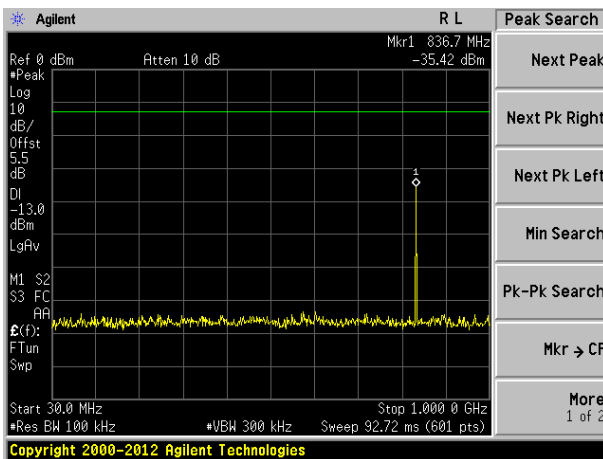

Middle channel

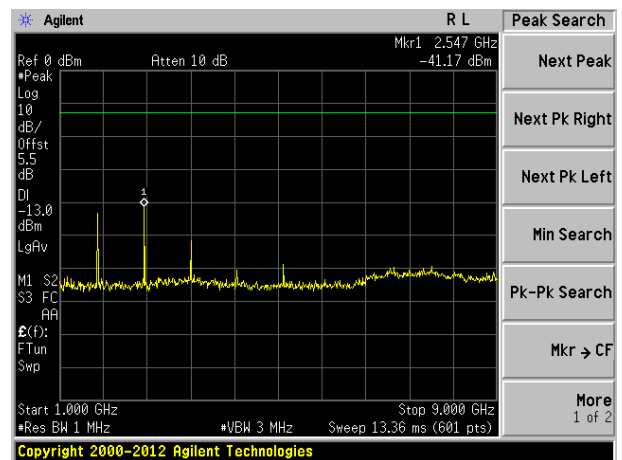
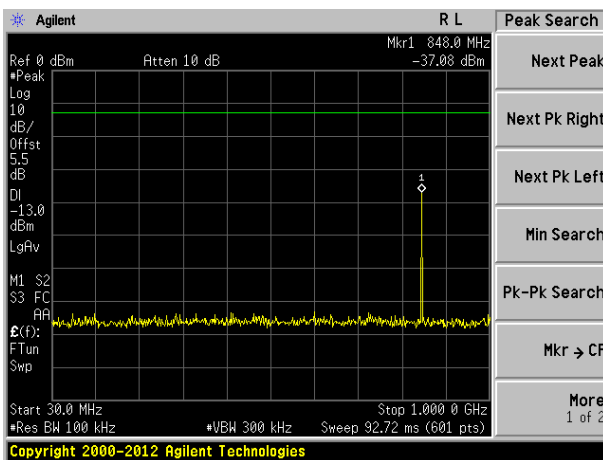

Highest channel

Test Mode: Traffic mode      PCS1900 (GSM link)

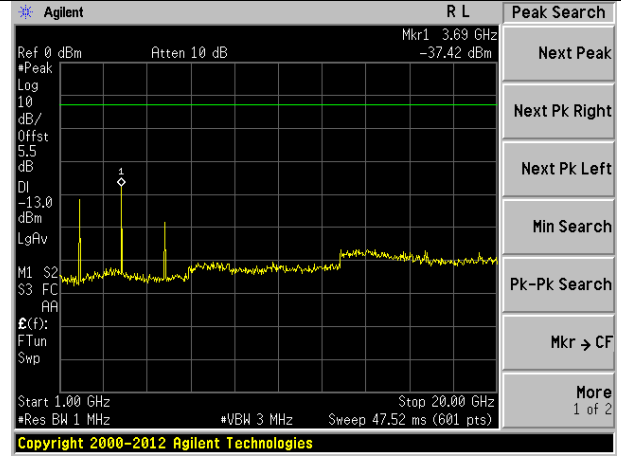
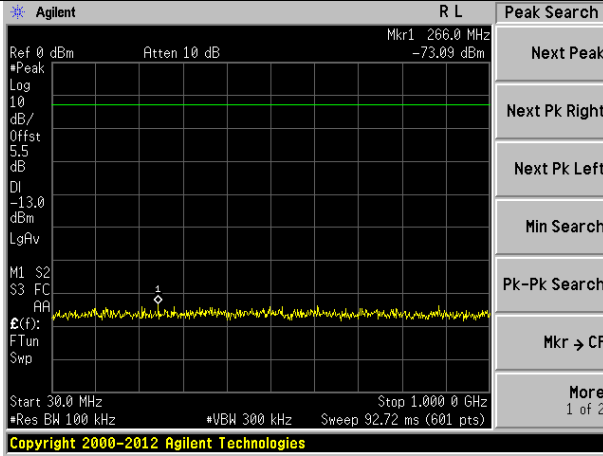

Lowest channel

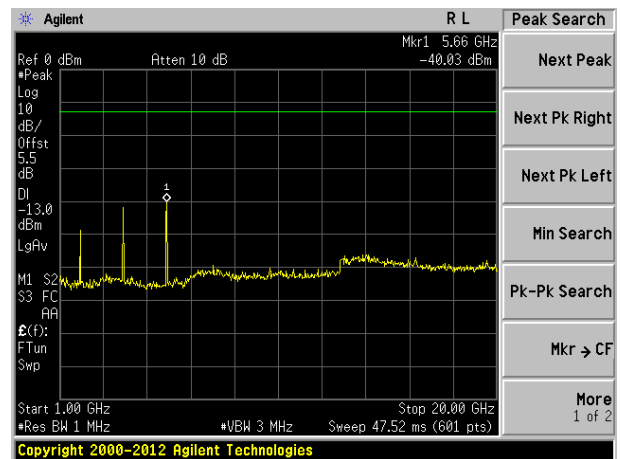
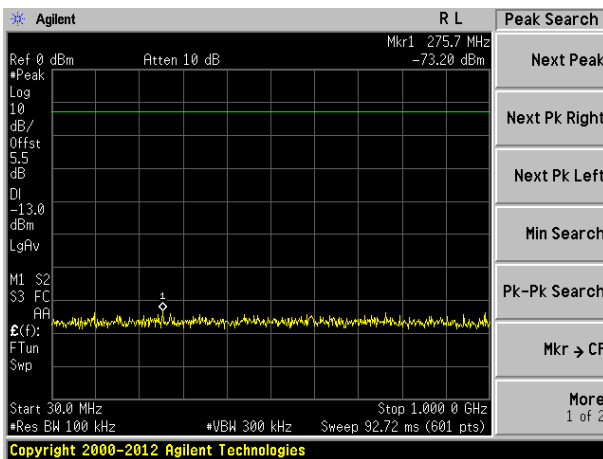

Middle channel

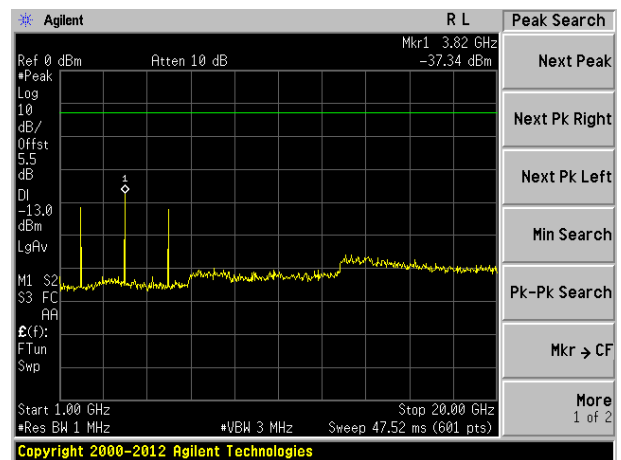
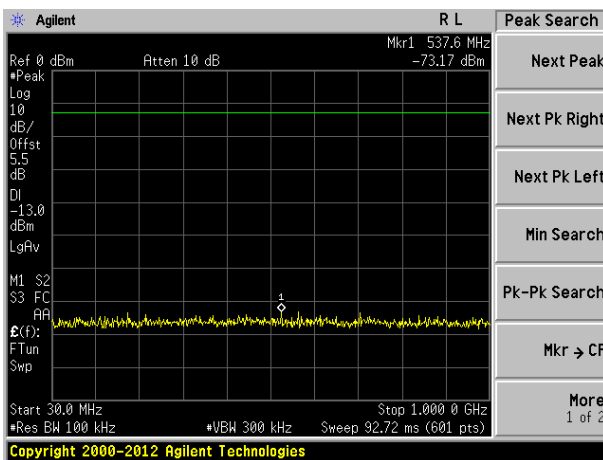

Highest channel



Test Mode: Traffic mode PCS1900 (GPRS 1 link)

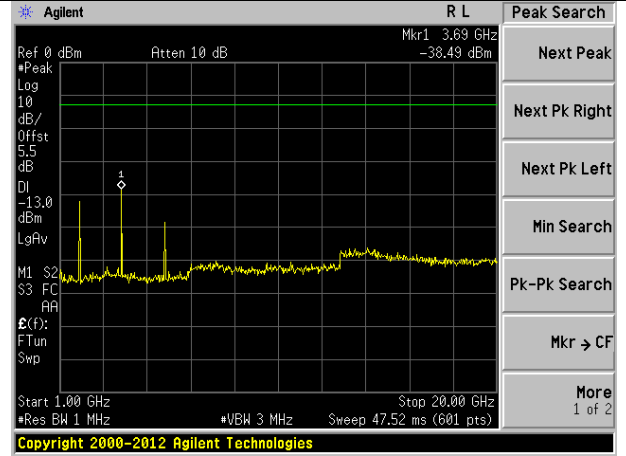
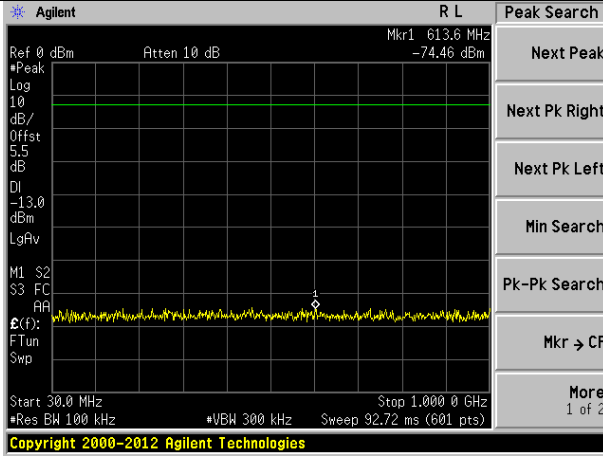

Lowest channel

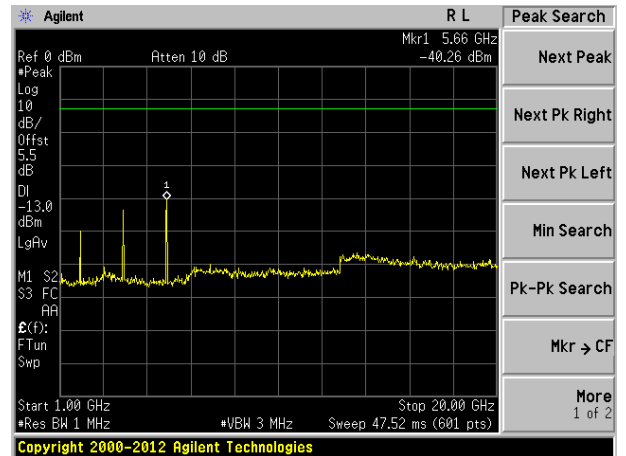
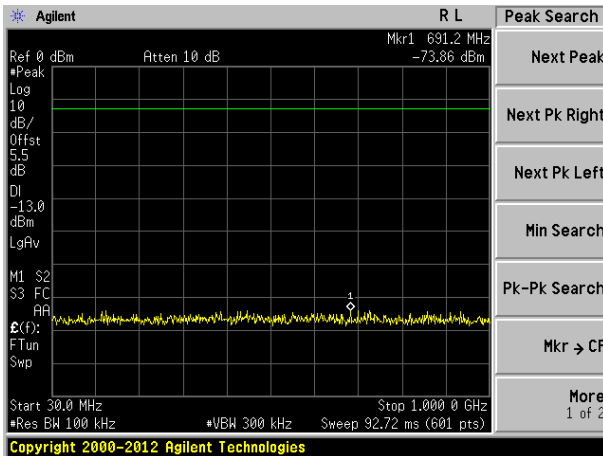

Middle channel

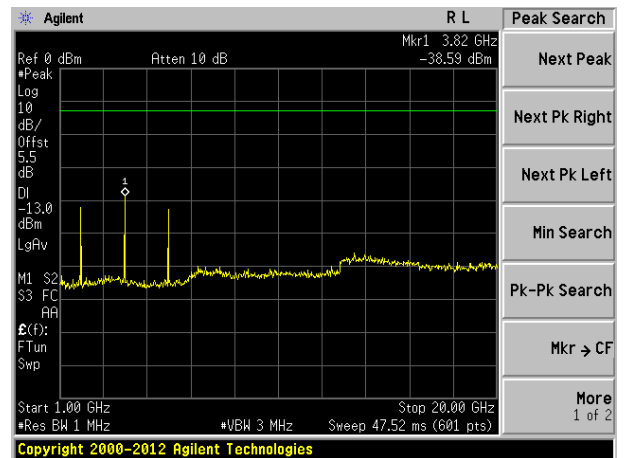
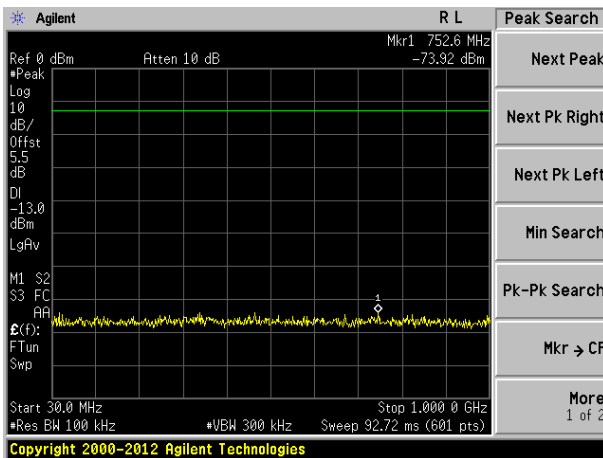

Highest channel

Test Mode: Traffic mode WCDMA Band II (RMC 12.2Kbps link)

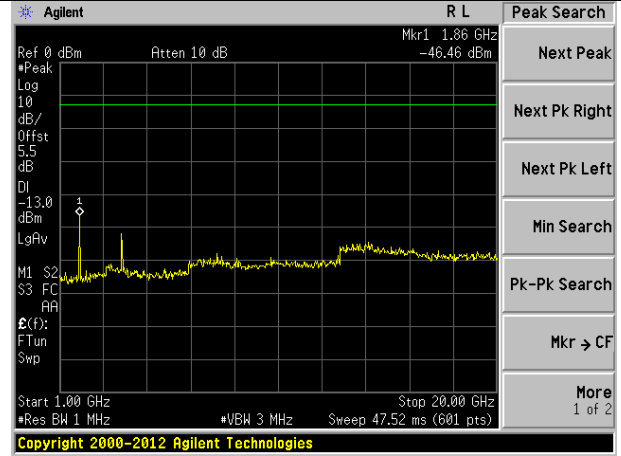
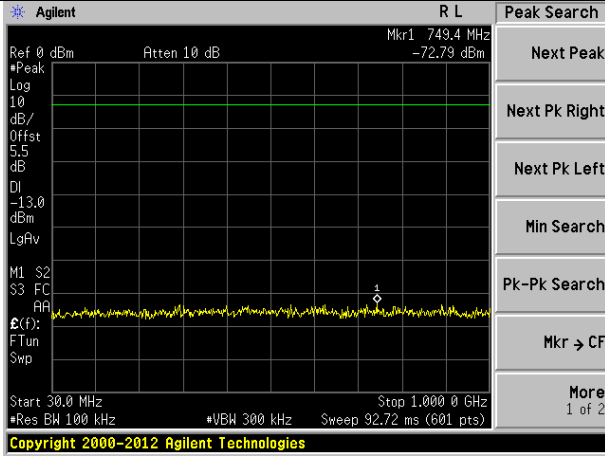

Lowest channel

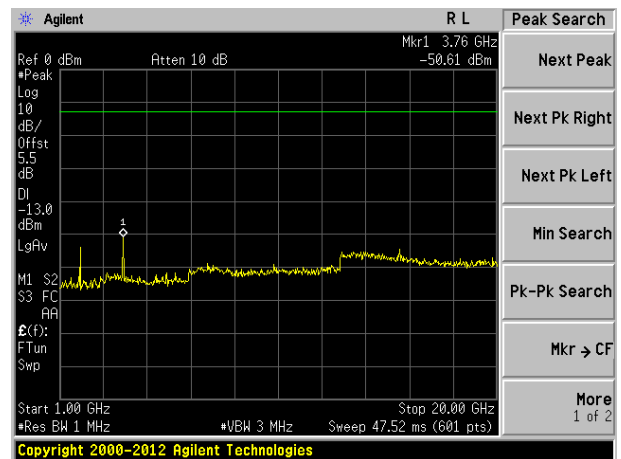
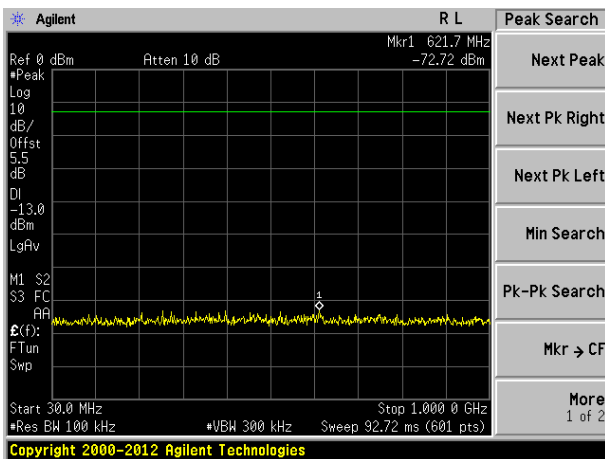

Middle channel

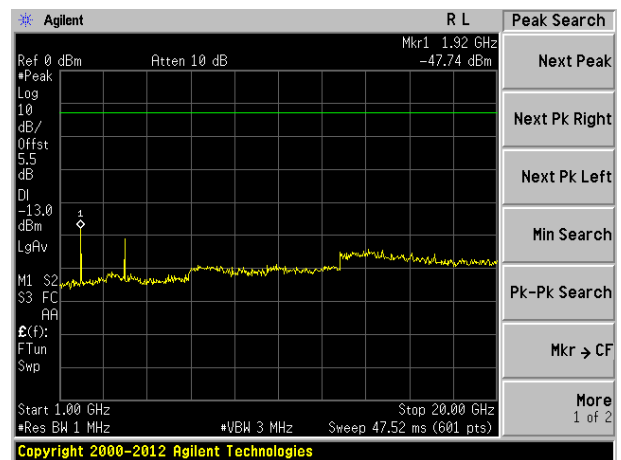
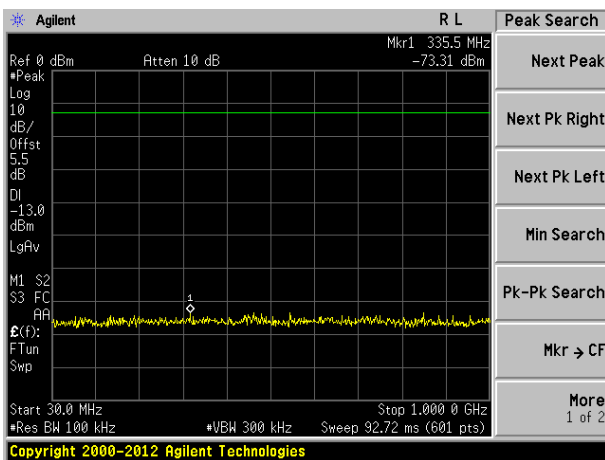

Highest channel

Test Mode: Traffic mode WCDMA Band V (RMC 12.2Kbps link)

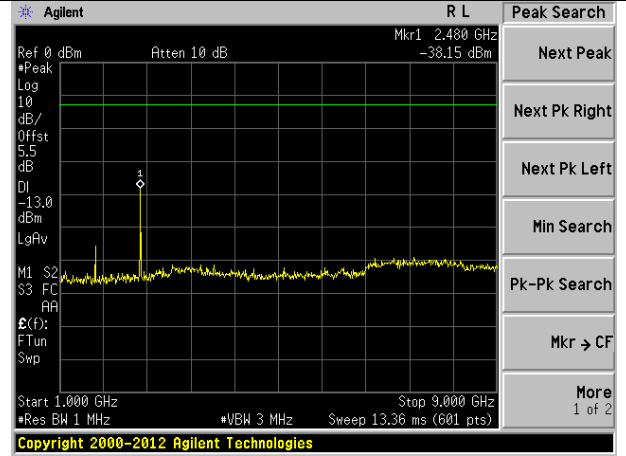
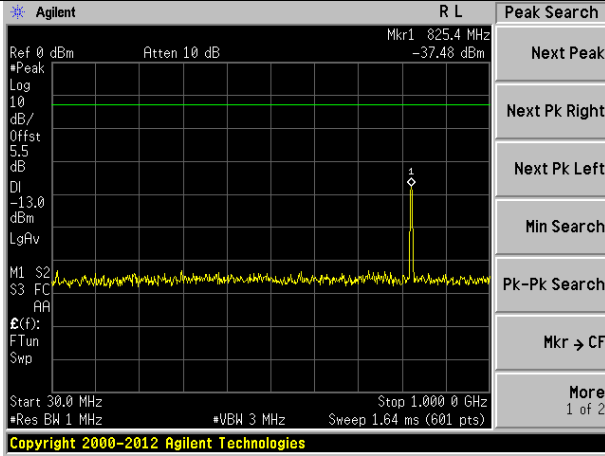

Lowest channel

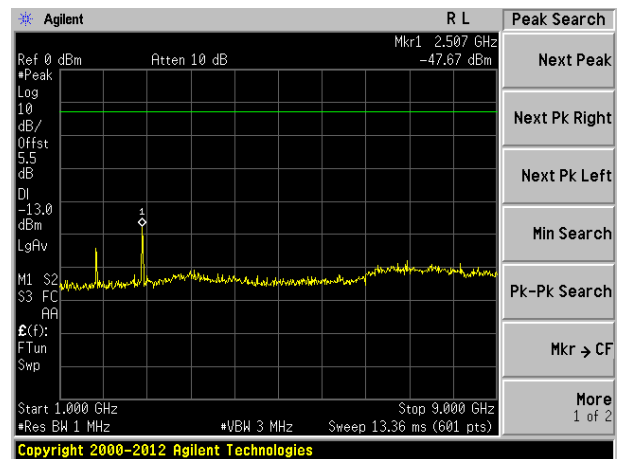
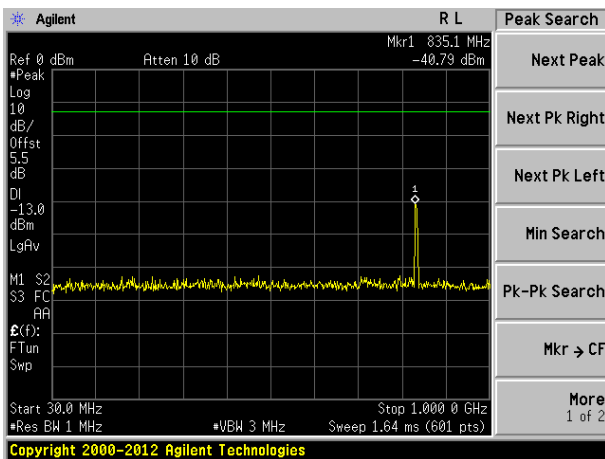

Middle channel

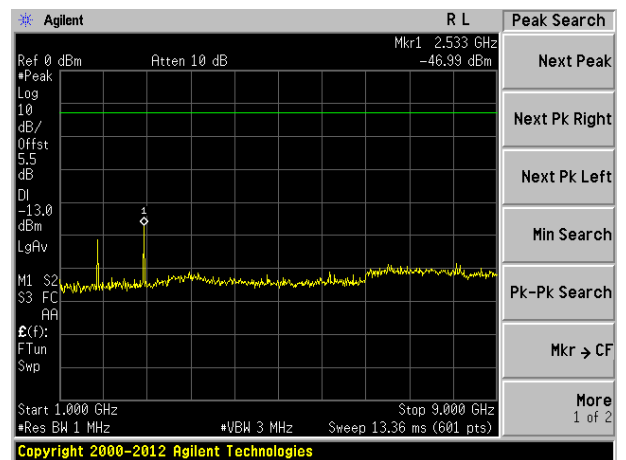
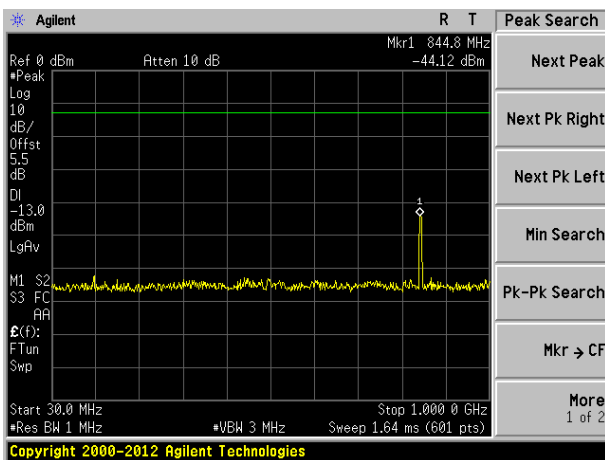

Highest channel

Band Edge:

Test Mode: Traffic mode GSM850 (GSM link)

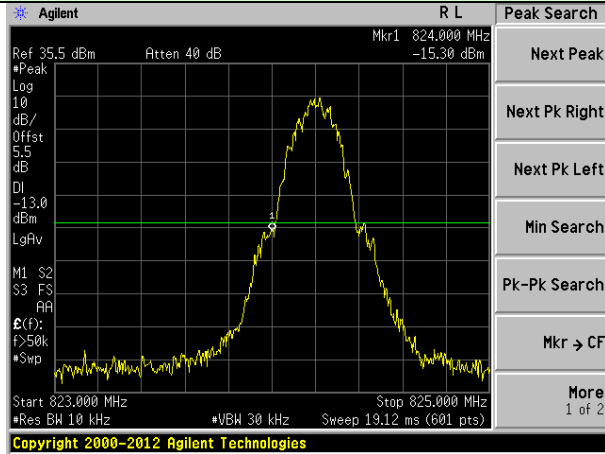

Lowest channel

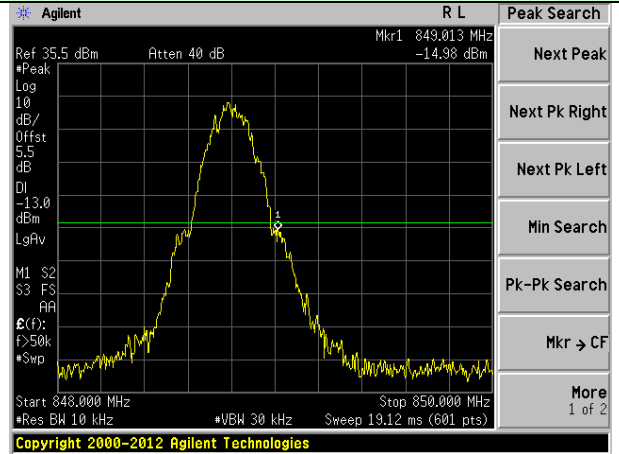

Highest channel

Test Mode: Traffic mode GSM850 (GPRS 1 link)

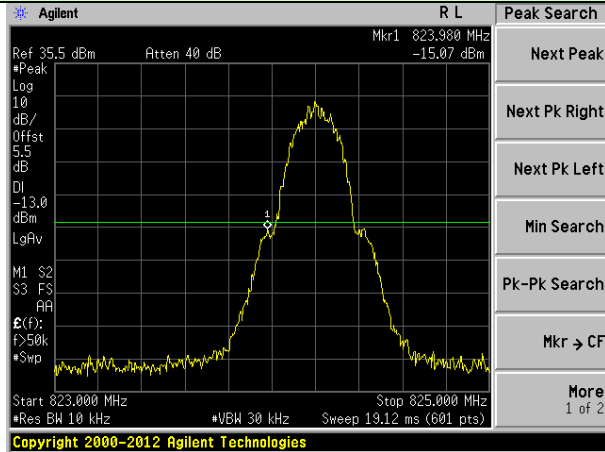

Lowest channel

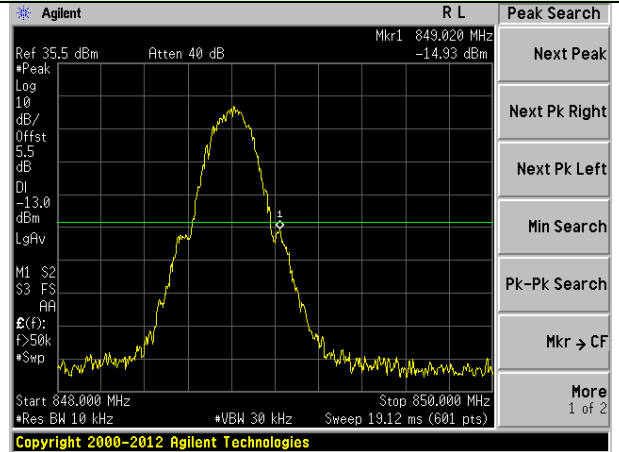

Highest channel

Test Mode: Traffic mode PCS1900 (GSM link)

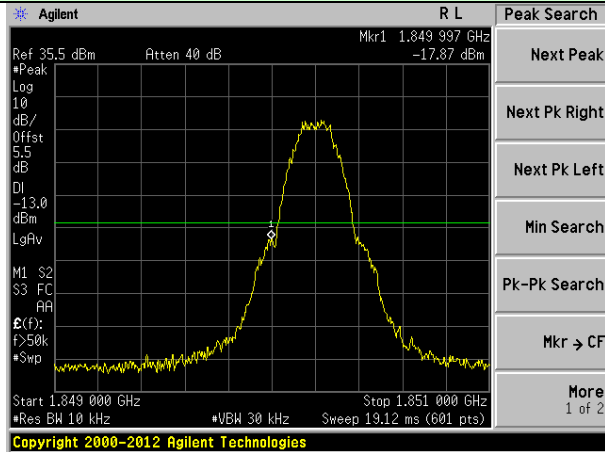

Lowest channel

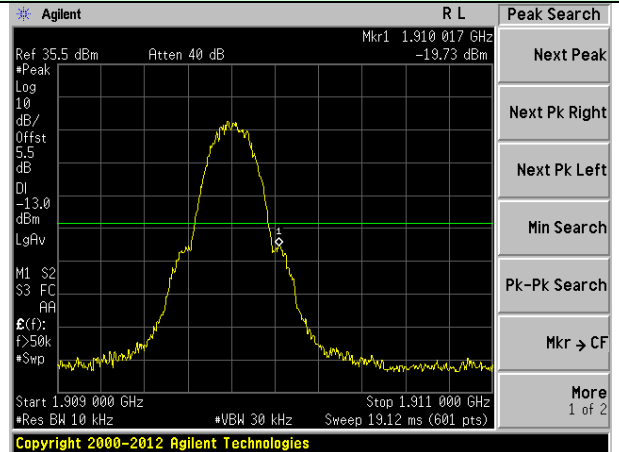

Highest channel

Test Mode: Traffic mode PCS1900 (GPRS 1 link)

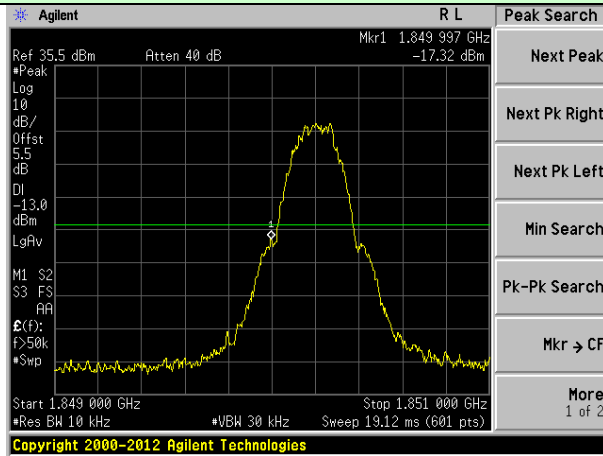

Lowest channel

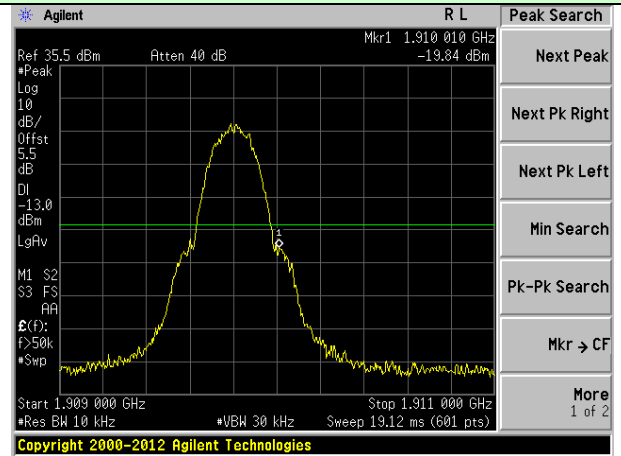

Highest channel

Test Mode: Traffic mode WCDMA Band II (RMC 12.2Kbps link)

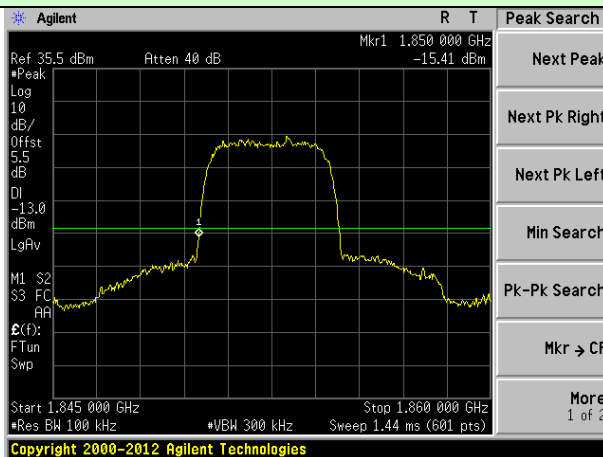

Lowest channel

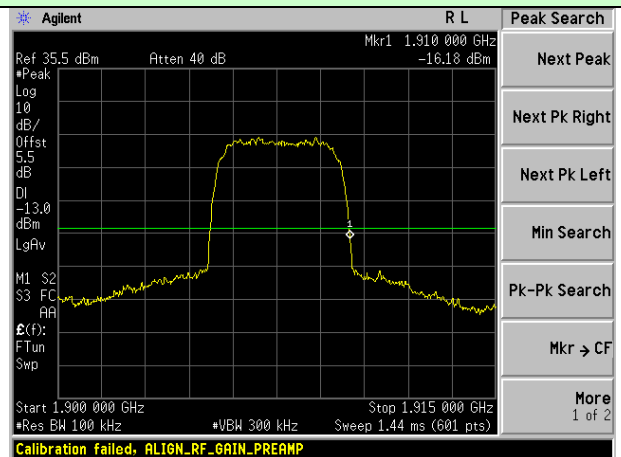

Highest channel

Test Mode: Traffic mode WCDMA Band V (RMC 12.2Kbps link)

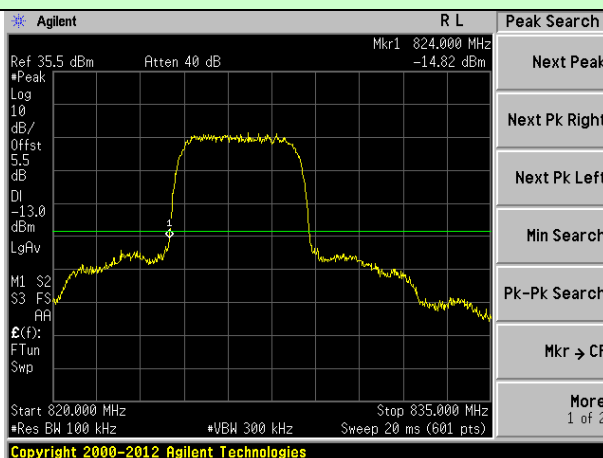

Lowest channel

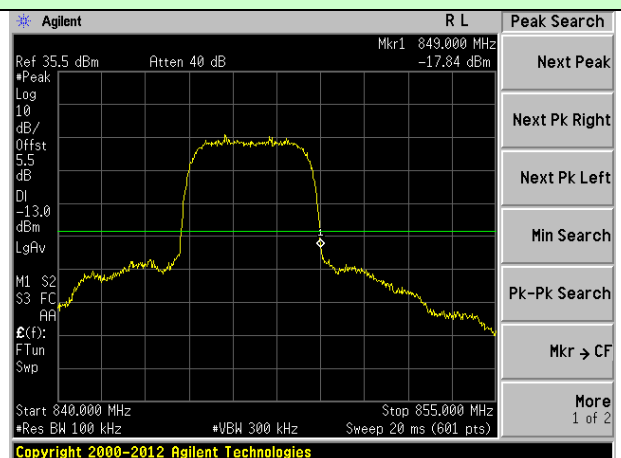

Highest channel

## 7.7 ERP, EIRP Measurement

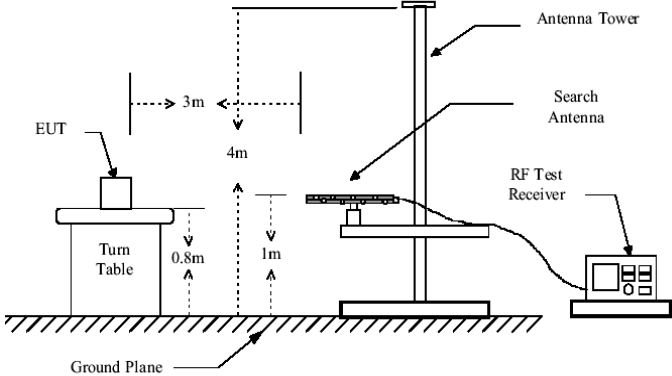
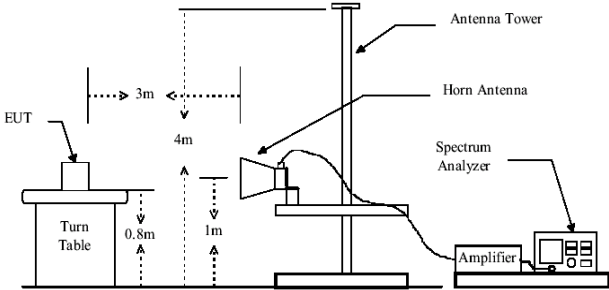
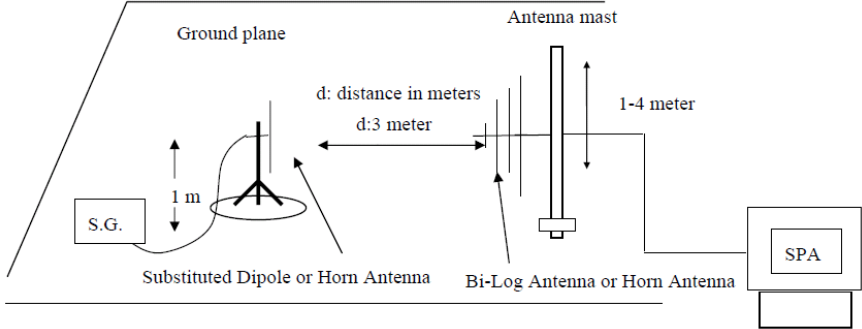
Test Requirement:	FCC part22.913(a) and FCC part24.232(b)
Test Method:	FCC part2.1046
Limit:	GSM850 7W ERP PCS1900 2W EIRP
Test setup:	<p>Below 1GHz</p>  <p>Above 1GHz</p>  <p>Substituted method:</p> 

<p>Test Procedure:</p>	<ol style="list-style-type: none"> <li>1. The EUT was placed on a non-conductive turntable using a non-conductive support. The radiated emission at the fundamental frequency was measured at 3 m with a test antenna and EMI spectrum analyzer.</li> <li>2. During the measurement, the EUT was in communication with the station. The highest emission was recorded with the rotation of the turntable and the lowering of the test antenna from 4m to 1m. The reading was recorded and the field strength (E in dBuV/m) was calculated.</li> <li>3. ERP in frequency band 824.2 –848.80.8MHz were measured using a substitution method. The EUT was replaced by a dipole antenna connected, the S.G. output was recorded and ERP was calculated as follows:  <math display="block">\text{ERP} = \text{S.G. output (dBm)} + \text{Antenna Gain (dBd)} - \text{Cable Loss (dB)}</math> </li> <li>4. EIRP in frequency band 1850.2 –1909.8MHz were measured using a substitution method. The EUT was replaced by a horn antenna connected, the S.G. output was recorded and EIRP was calculated as follows:  <math display="block">\text{EIRP} = \text{S.G. output (dBm)} + \text{Antenna Gain (dBi)} - \text{Cable Loss (dB)}</math> </li> </ol>
<p>Test Instruments:</p>	<p>Refer to section 6.0 for details</p>
<p>Test mode:</p>	<p>Refer to section 5.3 for details</p>
<p>Test results:</p>	<p>Pass</p>

Measurement Data

EUT mode	Channel	EUT Pol.	Antenna Pol.	ERP(dBm)	Limit (dBm)	Result
GSM850 (GSM link)	Lowest	H	V	32.83	38.45	Pass
			H	28.70		
		E1	V	23.32		
			H	28.83		
		E2	V	22.35		
			H	26.42		
	Middle	H	V	32.68	38.45	Pass
			H	28.46		
		E1	V	23.16		
			H	28.72		
		E2	V	23.94		
			H	26.93		
	Highest	H	V	32.59	38.45	Pass
			H	28.30		
		E1	V	23.23		
			H	27.73		
		E2	V	22.29		
			H	27.65		



EUT mode	Channel	EUT Pol.	Antenna Pol.	ERP(dBm)	Limit (dBm)	Result
GSM850 (GPRS 1 link)	Lowest	H	V	32.76	38.45	Pass
			H	28.19		
		E1	V	22.78		
			H	28.25		
		E2	V	21.73		
			H	25.76		
	Middle	H	V	32.65	38.45	Pass
			H	27.78		
		E1	V	22.43		
			H	27.94		
		E2	V	23.26		
			H	26.22		
	Highest	H	V	32.59	38.45	Pass
			H	27.67		
		E1	V	22.56		
			H	27.02		
		E2	V	21.75		
			H	27.08		

EUT mode	Channel	EUT Pol.	Antenna Pol.	EIRP (dBm)	Limit (dBm)	Result
PCS1900 (GSM link)	Lowest	H	V	28.57	33.01	Pass
			H	25.54		
		E1	V	20.75		
			H	25.73		
		E2	V	19.93		
			H	23.61		
	Middle	H	V	28.65	33.01	Pass
			H	25.52		
		E1	V	20.81		
			H	25.82		
		E2	V	21.46		
			H	24.17		
	Highest	H	V	28.79	33.01	Pass
			H	25.43		
		E1	V	20.92		
			H	24.98		
		E2	V	19.97		
			H	24.81		

EUT mode	Channel	EUT Pol.	Antenna Pol.	EIRP (dBm)	Limit (dBm)	Result
PCS1900 (GPRS 1 link)	Lowest	H	V	28.41	33.01	Pass
			H	24.99		
		E1	V	20.16		
			H	25.09		
		E2	V	19.26		
			H	22.89		
	Middle	H	V	28.56	33.01	Pass
			H	24.77		
		E1	V	20.01		
			H	24.97		
		E2	V	20.72		
			H	23.39		
	Highest	H	V	28.35	33.01	Pass
			H	24.74		
		E1	V	20.19		
			H	24.20		
		E2	V	19.39		
			H	24.19		

EUT mode	Channel	EUT Pol.	Antenna Pol.	EIRP(dBm)	Limit (dBm)	Result
WCDMA Band II	Lowest	H	V	22.08	33.01	Pass
			H	20.89		
		E1	V	17.26		
			H	20.61		
		E2	V	16.28		
			H	18.71		
	Middle	H	V	22.46	33.01	Pass
			H	20.01		
		E1	V	16.40		
			H	19.76		
		E2	V	17.16		
			H	18.90		
	Highest	H	V	22.89	33.01	Pass
			H	18.80		
		E1	V	15.36		
			H	18.06		
		E2	V	15.40		
			H	18.65		

EUT mode	Channel	EUT Pol.	Antenna Pol.	ERP(dBm)	Limit (dBm)	Result
WCDMA Band V	Lowest	H	V	22.51	38.45	Pass
			H	18.56		
		E1	V	14.67		
			H	17.74		
		E2	V	13.15		
			H	15.31		
	Middle	H	V	21.46	38.45	Pass
			H	16.41		
		E1	V	12.47		
			H	15.56		
		E2	V	13.63		
			H	15.10		
	Highest	H	V	21.49	38.45	Pass
			H	15.60		
		E1	V	11.89		
			H	14.33		
		E2	V	12.87		
			H	15.85		

## 7.8 Field strength of spurious radiation measurement

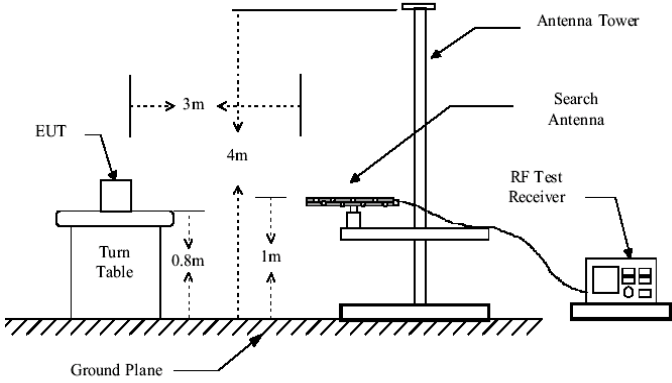
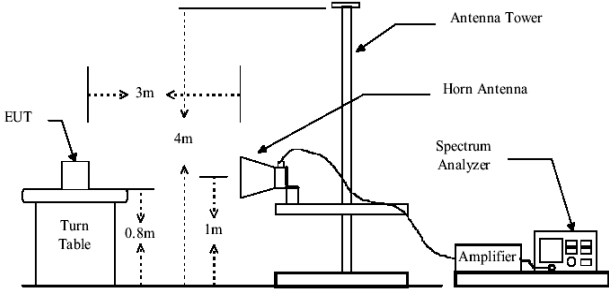
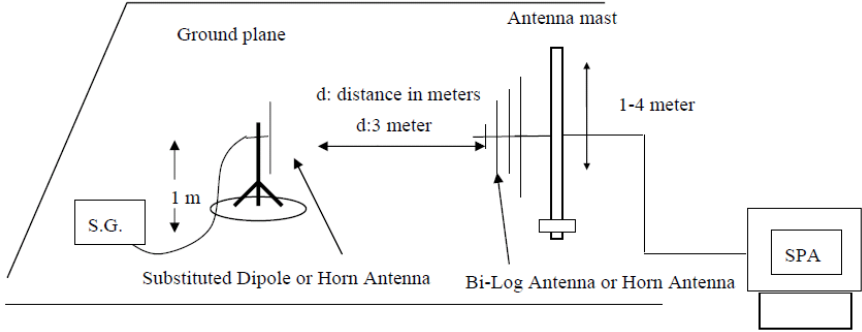
Test Requirement:	FCC part22.917(a) and FCC part24.238(a)
Test Method:	FCC part2.1053
Limit:	-13dBm
Test setup:	<p><b>Below 1GHz</b></p>  <p><b>Above 1GHz</b></p>  <p><b>Substituted method:</b></p> 

<p>Test Procedure:</p>	<ol style="list-style-type: none"> <li>1. The EUT was placed on a non-conductive turntable using a non-conductive support. The radiated emission at the fundamental frequency was measured at 3 m with a test antenna and EMI spectrum analyzer.</li> <li>2. During the tests, the antenna height and the EUT azimuth were varied in order to identify the maximum level of emissions from the EUT. This maximization process was repeated with the EUT positioned in each of its three orthogonal orientations.</li> <li>3. The frequency range up to tenth harmonic was investigated for each of three fundamental frequency (low, middle and high channels). Once spurious emission was identified, the power of the emission was determined using the substitution method.</li> <li>4. The spurious emissions attenuation was calculated as the difference between radiated power at the fundamental frequency and the spurious emissions frequency.  <math display="block">\text{ERP / EIRP} = \text{S.G. output (dBm)} + \text{Antenna Gain(dB/dBi)} - \text{Cable Loss (dB)}</math> </li> </ol>
<p>Test Instruments:</p>	<p>Refer to section 6.0 for details</p>
<p>Test mode:</p>	<p>Refer to section 5.3 for details</p>
<p>Test results:</p>	<p>Pass</p>

Measurement Data

Test mode:	GSM850		Test channel:	Lowest
Frequency (MHz)	Spurious Emission		Limit (dBm)	Result
	Polarization	Level (dBm)		
1648.40	Vertical	-35.86	-13.00	Pass
2472.60	V	-38.60		
3296.80	V	-40.87		
4121.00	V	-43.03		
4945.20	V	---		
1648.40	Horizontal	-41.11	-13.00	Pass
2472.60	H	-44.98		
3296.80	H	-46.56		
4121.00	H	-49.30		
4945.20	H	---		
Test mode:	GSM850		Test channel:	Middle
Frequency (MHz)	Spurious Emission		Limit (dBm)	Result
	Polarization	Level (dBm)		
1673.20	Vertical	-37.24	-13.00	Pass
2509.80	V	-39.52		
3346.40	V	-41.42		
4183.00	V	-43.23		
5019.60	V	---		
1673.20	Horizontal	-41.62	-13.00	Pass
2509.80	H	-44.85		
3346.40	H	-46.16		
4183.00	H	-48.44		
5019.60	H	---		
Test mode:	GSM850		Test channel:	Highest
Frequency (MHz)	Spurious Emission		Limit (dBm)	Result
	Polarization	Level (dBm)		
1697.60	Vertical	-37.49	-13.00	Pass
2546.40	V	-39.52		
3395.20	V	-41.20		
4244.00	V	-42.81		
5092.80	V	---		
1697.60	Horizontal	-41.38	-13.00	Pass
2546.40	H	-44.26		
3395.20	H	-45.42		
4244.00	H	-47.45		
5092.80	H	---		

Remark :

1. The emission behaviour belongs to narrowband spurious emission.
2. Remark"---" means that the emission level is too low to be measured
3. The emission levels of below 1 GHz are very lower than the limit and not show in test report.



Test mode:	PCS1900		Test channel:	Lowest
Frequency (MHz)	Spurious Emission		Limit (dBm)	Result
	Polarization	Level (dBm)		
3700.40	Vertical	-36.97	-13.00	Pass
5550.60	V	-39.36		
7400.80	V	-41.33		
9251.00	V	-43.23		
11101.20	V	---		
3700.40	Horizontal	-41.55	-13.00	Pass
5550.60	H	-44.93		
7400.80	H	-46.29		
9251.00	H	-48.66		
11101.20	H	---		
Test mode:	PCS1900		Test channel:	Middle
Frequency (MHz)	Spurious Emission		Limit (dBm)	Result
	Polarization	Level (dBm)		
3760.00	Vertical	-34.66	-13.00	Pass
5640.00	V	-37.12		
7520.00	V	-39.16		
9400.00	V	-41.13		
11280.00	V	---		
3760.00	Horizontal	-39.40	-13.00	Pass
5640.00	H	-42.89		
7520.00	H	-44.30		
9400.00	H	-46.76		
11280.00	H	---		
Test mode:	PCS1900		Test channel:	Highest
Frequency (MHz)	Spurious Emission		Limit (dBm)	Result
	Polarization	Level (dBm)		
3819.60	Vertical	-35.85	-13.00	Pass
5729.40	V	-38.24		
7639.20	V	-40.22		
9549.00	V	-42.12		
11458.80	V	---		
3819.60	Horizontal	-40.44	-13.00	Pass
5729.40	H	-43.83		
7639.20	H	-45.19		
9549.00	H	-47.57		
11458.80	H	---		

Remark:

1. The emission behaviour belongs to narrowband spurious emission.
2. Remark"---" means that the emission level is too low to be measured
3. The emission levels of below 1 GHz are very lower than the limit and not show in test report.

Test mode:		WCDMA Band II		Test channel:	Lowest
Frequency (MHz)	Spurious Emission		Limit (dBm)	Result	
	Polarization	Level (dBm)			
3704.46	Vertical	-38.56	-13.00	Pass	
5556.86	V	-41.65			
7409.26	V	-44.21			
9261.66	V	-46.67			
11114.40	V	---			
3704.46	Horizontal	-44.49	-13.00	Pass	
5556.86	H	-48.86			
7409.26	H	-50.63			
9261.66	H	-53.72			
11114.40	H	---			
Test mode:		WCDMA Band II		Test channel:	Middle
Frequency (MHz)	Spurious Emission		Limit (dBm)	Result	
	Polarization	Level (dBm)			
3759.83	Vertical	-39.36	-13.00	Pass	
5639.83	V	-42.29			
7519.83	V	-44.71			
9399.83	V	-47.04			
11280.00	V	---			
3759.83	Horizontal	-44.98	-13.00	Pass	
5639.83	H	-49.13			
7519.83	H	-50.80			
9399.83	H	-53.72			
11280.00	H	---			
Test mode:		WCDMA Band II		Test channel:	Highest
Frequency (MHz)	Spurious Emission		Limit (dBm)	Result	
	Polarization	Level (dBm)			
3815.03	Vertical	-38.64	-13.00	Pass	
5722.63	V	-41.38			
7630.23	V	-43.62			
9537.83	V	-45.81			
11445.60	V	---			
3815.03	Horizontal	-43.88	-13.00	Pass	
5722.63	H	-47.75			
7630.23	H	-49.30			
9537.83	H	-52.02			
11445.60	H	---			

Remark:

1. The emission behaviour belongs to narrowband spurious emission.
2. Remark"---" means that the emission level is too low to be measured
3. The emission levels of below 1 GHz are very lower than the limit and not show in test report.

Test mode:	WCDMA Band V		Test channel:	Lowest
Frequency (MHz)	Spurious Emission		Limit (dBm)	Result
	Polarization	Level (dBm)		
1652.80	Vertical	-37.65	-13.00	Pass
2479.20	V	-41.39		
3305.60	V	-44.11		
4132.00	V	-41.63		
4958.40	V	---		
1652.80	Horizontal	-40.43	-13.00	Pass
2479.20	H	-43.11		
3305.60	H	-48.51		
4132.00	H	-52.12		
4958.40	H	---		
Test mode:	WCDMA Band V		Test channel:	Middle
Frequency (MHz)	Spurious Emission		Limit (dBm)	Result
	Polarization	Level (dBm)		
1672.80	Vertical	-39.63	-13.00	Pass
2509.20	V	-40.93		
3345.60	V	-44.55		
4182.00	V	-47.01		
5018.40	V	---		
1672.80	Horizontal	-42.07	-13.00	Pass
2509.20	H	-43.97		
3345.60	H	-48.65		
4182.00	H	-51.02		
5018.40	H	---		
Test mode:	WCDMA Band V		Test channel:	Highest
Frequency (MHz)	Spurious Emission		Limit (dBm)	Result
	Polarization	Level (dBm)		
1693.20	Vertical	-38.10	-13.00	Pass
2539.80	V	-40.52		
3386.40	V	-43.14		
4233.00	V	-46.04		
5079.60	V	---		
1693.20	Horizontal	-41.43	-13.00	Pass
2539.80	H	-43.84		
3386.40	H	-45.21		
4233.00	H	-51.38		
5079.60	H	---		

Remark :

1. The emission behaviour belongs to narrowband spurious emission.
2. Remark"---" means that the emission level is too low to be measured
3. The emission levels of below 1 GHz are very lower than the limit and not show in test report.

## 7.9 Frequency stability V.S. Temperature measurement

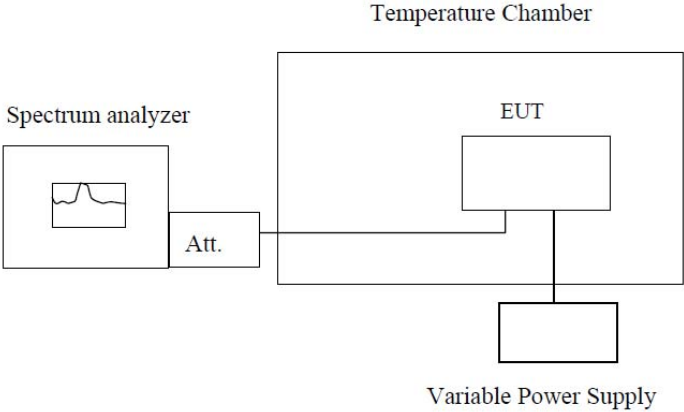
Test Requirement:	FCC Part2.1055(a)(1)(b)
Test Method:	FCC Part2.1055(a)(1)(b)
Limit:	2.5ppm
Test setup:	 <p><b>Note :</b> Measurement setup for testing on Antenna connector</p>
Test procedure:	<ol style="list-style-type: none"> <li>1. The equipment under test was connected to an external DC power supply and input rated voltage.</li> <li>2. RF output was connected to a frequency counter or spectrum analyzer via feed through attenuators.</li> <li>3. The EUT was placed inside the temperature chamber.</li> <li>4. Set the spectrum analyzer RBW low enough to obtain the desired frequency resolution and measure EUT 25°C operating frequency as reference frequency.</li> <li>5. Turn EUT off and set the chamber temperature to -20°C. After the temperature stabilized for approximately 30 minutes recorded the frequency.</li> <li>6. Repeat step measure with 10°C increased per stage until the highest temperature of +50°C reached.</li> </ol>
Test Instruments:	Refer to section 6.0 for details
Test mode:	Refer to section 5.3 for details
Test results:	Pass

### Measurement Data

Reference Frequency: GSM850 (GSM link) Middle channel=190 channel=836.6MHz					
Power supplied (Vdc)	Temperature (°C)	Frequency error		Limit (ppm)	Result
		Hz	ppm		
3.70	-30	31	0.0375	2.5	Pass
	-20	35	0.0415		
	-10	30	0.0361		
	0	26	0.0307		
	10	29	0.0348		
	20	26	0.0307		
	30	39	0.0469		
	40	36	0.0429		
	50	35	0.0415		
Reference Frequency: GSM850 (GPRS 1 link) Middle channel=190 channel=836.6MHz					
Power supplied (Vdc)	Temperature (°C)	Frequency error		Limit (ppm)	Result
		Hz	ppm		
3.70	-30	67	0.0798	2.5	Pass
	-20	78	0.0931		
	-10	65	0.0771		
	0	56	0.0664		
	10	63	0.0750		
	20	54	0.0646		
	30	94	0.1126		
	40	81	0.0974		
	50	77	0.0919		
	50	35	0.0418		

Reference Frequency: PCS1900 (GSM link) Middle channel=661 channel=1880MHz					
Power supplied (Vdc)	Temperature (°C)	Frequency error			Result
		Hz	ppm		
3.70	-30	51	0.0270	2.5	Pass
	-20	58	0.0309		
	-10	51	0.0270		
	0	45	0.0237		
	10	51	0.0270		
	20	46	0.0244		
	30	67	0.0355		
	40	59	0.0316		
	50	57	0.0303		
Reference Frequency: PCS1900 (GPRS 1 link) Middle channel=661 channel=1880MHz					
Power supplied (Vdc)	Temperature (°C)	Frequency error			Result
		Hz	ppm		
3.70	-30	91	0.0484	2.5	Pass
	-20	108	0.0573		
	-10	87	0.0464		
	0	71	0.0379		
	10	88	0.0470		
	20	74	0.0391		
	30	121	0.0646		
	40	101	0.0537		
	50	106	0.0565		

Reference Frequency: WCDMA Band II Middle channel=9400 channel=1880.0MHz					
Power supplied (Vdc)	Temperature (°C)	Frequency error		Limit (ppm)	Result
		Hz	ppm		
3.70	-30	109	0.0581	2.5	Pass
	-20	97	0.0516		
	-10	83	0.0443		
	0	78	0.0414		
	10	71	0.0378		
	20	62	0.0328		
	30	78	0.0414		
	40	87	0.0465		
	50	83	0.0443		
Reference Frequency: WCDMA Band V Middle channel=4183 channel=836.6MHz					
Power supplied (Vdc)	Temperature (°C)	Frequency error		Limit (ppm)	Result
		Hz	ppm		
3.70	-30	35	0.0421	2.5	Pass
	-20	49	0.0587		
	-10	55	0.0662		
	0	26	0.0315		
	10	39	0.0466		
	20	43	0.0511		
	30	63	0.0752		
	40	59	0.0707		
	50	70	0.0843		

## 7.10 Frequency stability V.S. Voltage measurement

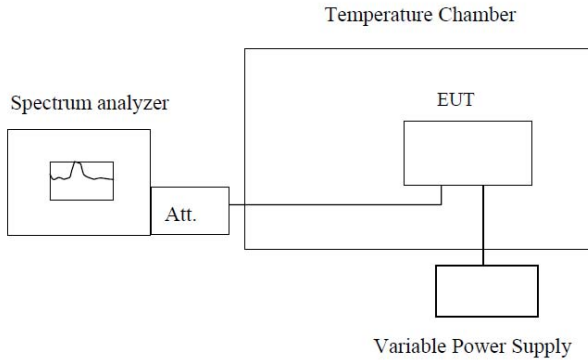
Test Requirement:	FCC Part2.1055(d)(1)(2)
Test Method:	FCC Part2.1055(d)(1)(2)
Limit:	2.5ppm
Test setup:	 <p style="text-align: center;">Temperature Chamber</p> <p style="text-align: center;">Spectrum analyzer</p> <p style="text-align: center;">Att.</p> <p style="text-align: center;">EUT</p> <p style="text-align: center;">Variable Power Supply</p> <p><b>Note :</b> Measurement setup for testing on Antenna connector</p>
Test procedure:	<ol style="list-style-type: none"> <li>1. Set chamber temperature to 25°C. Use a variable DC power source to power the EUT and set the voltage to rated voltage.</li> <li>2. Set the spectrum analyzer RBW low enough to obtain the desired frequency resolution and recorded the frequency.</li> <li>3. Reduce the input voltage to specified extreme voltage variation (+/- 15%) and endpoint, record the maximum frequency change.</li> </ol>
Test Instruments:	Refer to section 6.0 for details
Test mode:	Refer to section 5.3 for details
Test results:	Pass



Measurement Data

Reference Frequency: GSM850 (GSM link) Middle channel=190 channel=836.6MHz					
Temperature (°C)	Power supplied (Vdc)	Frequency error		Limit (ppm)	Result
		Hz	ppm		
25	4.25	21	0.0255	2.5	Pass
	3.70	24	0.0285		
	3.40	26	0.0315		
Reference Frequency: GSM850 (GPRS 1 link) Middle channel=190 channel=836.6MHz					
Temperature (°C)	Power supplied (Vdc)	Frequency error		Limit (ppm)	Result
		Hz	ppm		
25	4.25	34	0.0402	2.5	Pass
	3.70	39	0.0467		
	3.40	44	0.0529		

Reference Frequency: PCS1900 (GSM link) Middle channel=661 channel=1880MHz					
Temperature (°C)	Power supplied (Vdc)	Frequency error		Limit (ppm)	Result
		Hz	ppm		
25	4.25	11	0.0057	2.5	Pass
	3.70	17	0.0090		
	3.40	17	0.0090		
Reference Frequency: PCS1900 (GPRS 1 link) Middle channel=661 channel=1880MHz					
Temperature (°C)	Power supplied (Vdc)	Frequency error		Limit (ppm)	Result
		Hz	ppm		
25	4.25	103	0.0549	2.5	Pass
	3.70	118	0.0628		
	3.40	119	0.0631		

Reference Frequency: WCDMA Band II Middle channel=940 channel=1880.0MHz					
Temperature (°C)	Power supplied (Vdc)	Frequency error		Limit (ppm)	Result
		Hz	ppm		
25	4.25	46	0.0245	2.5	Pass
	3.70	37	0.0199		
	3.40	42	0.0225		
Reference Frequency: WCDMA Band V Middle channel=4183 channel=836.6MHz					
Temperature (°C)	Power supplied (Vdc)	Frequency error		Limit (ppm)	Result
		Hz	ppm		
25	4.25	31	0.0369	2.5	Pass
	3.70	40	0.0482		
	3.40	21	0.0256		

## 8 Test Setup Photo

### Radiated Emission

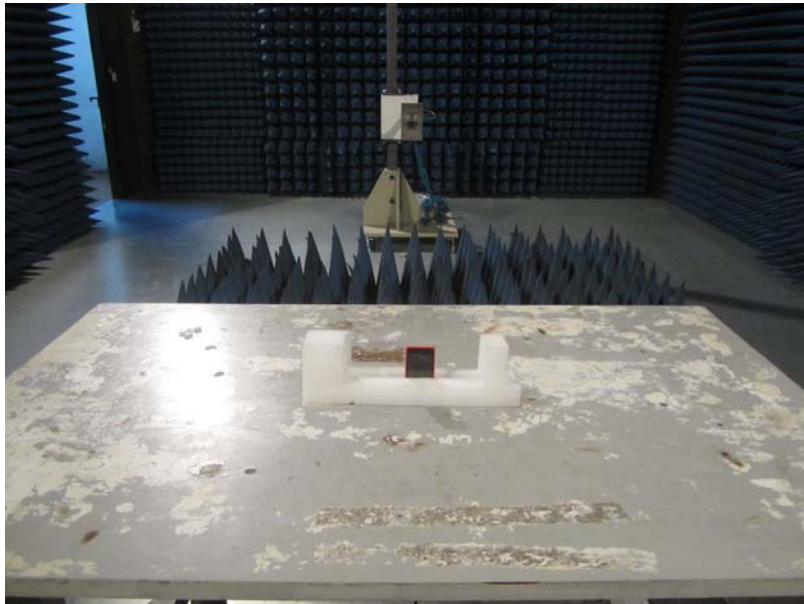
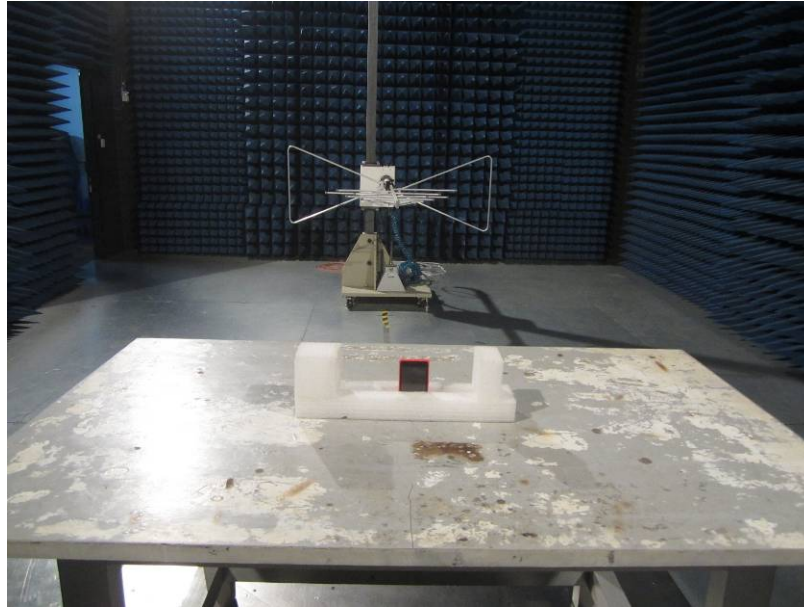

Conducted emission photo



Temperature chamber photo



## 9 EUT Constructional Details











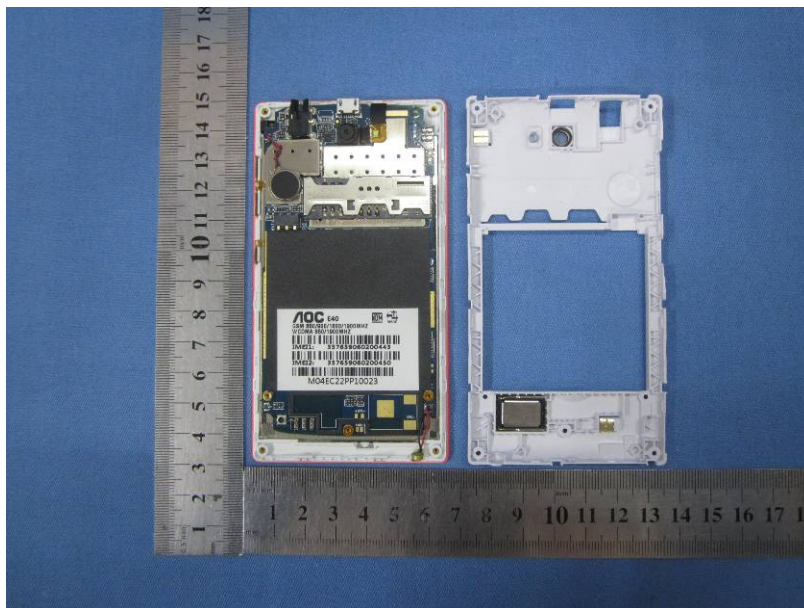

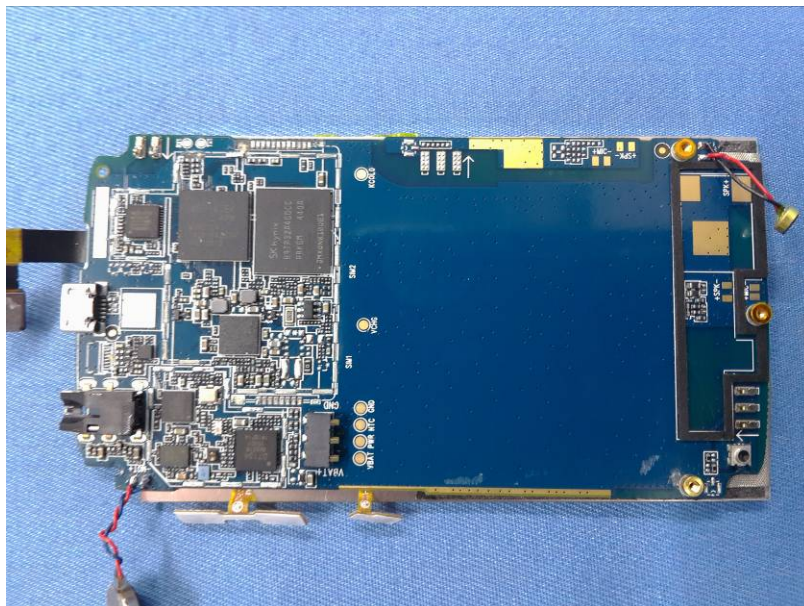

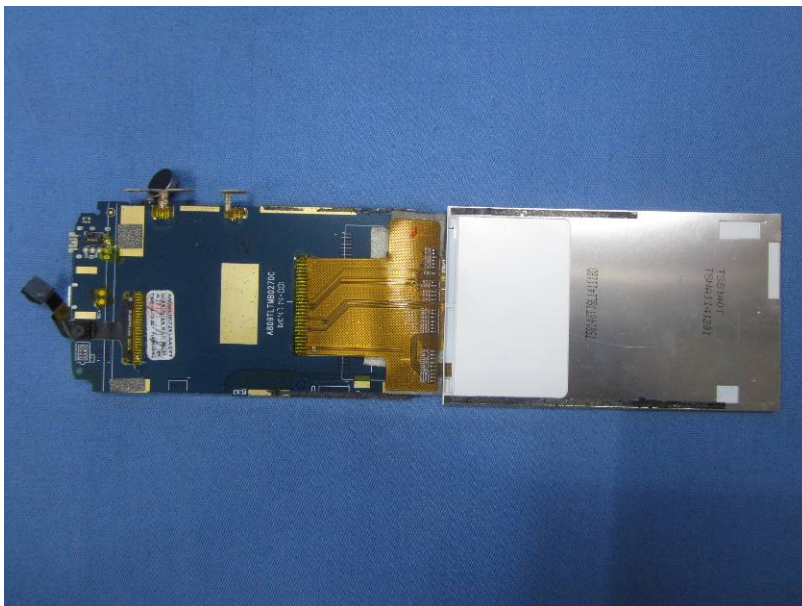
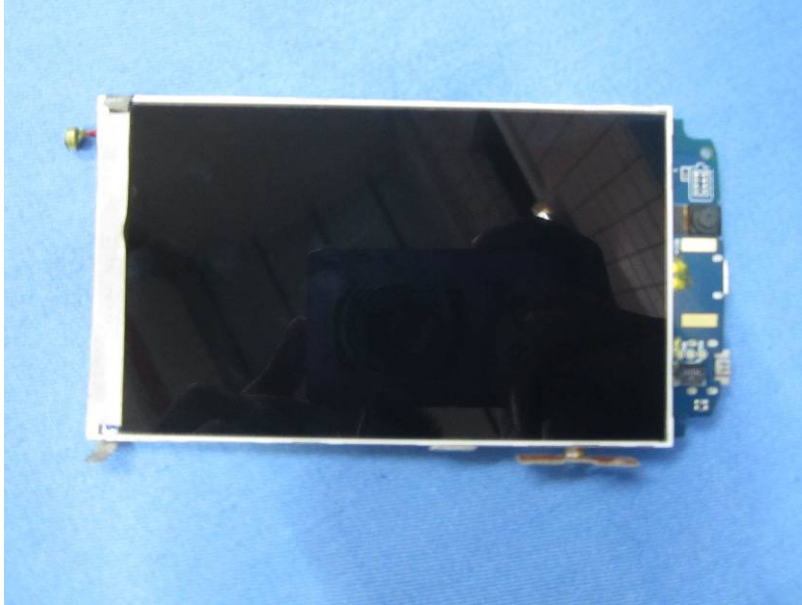

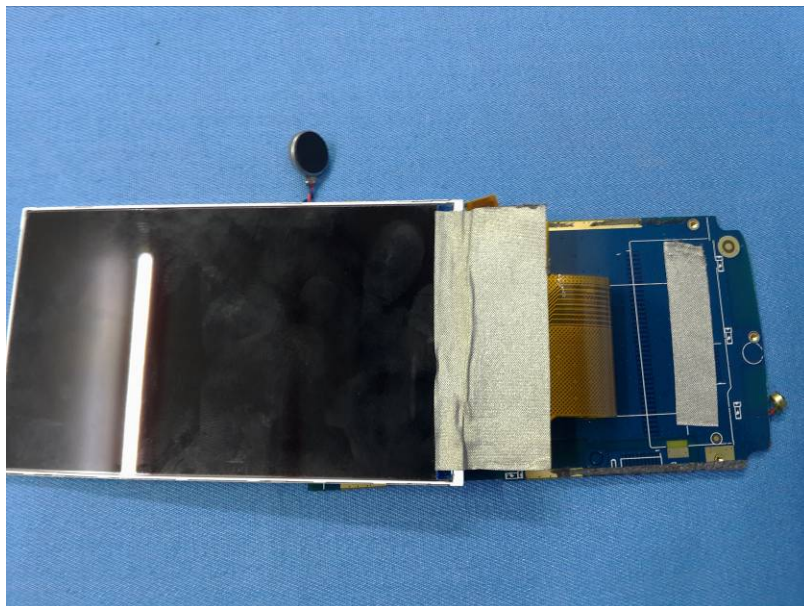
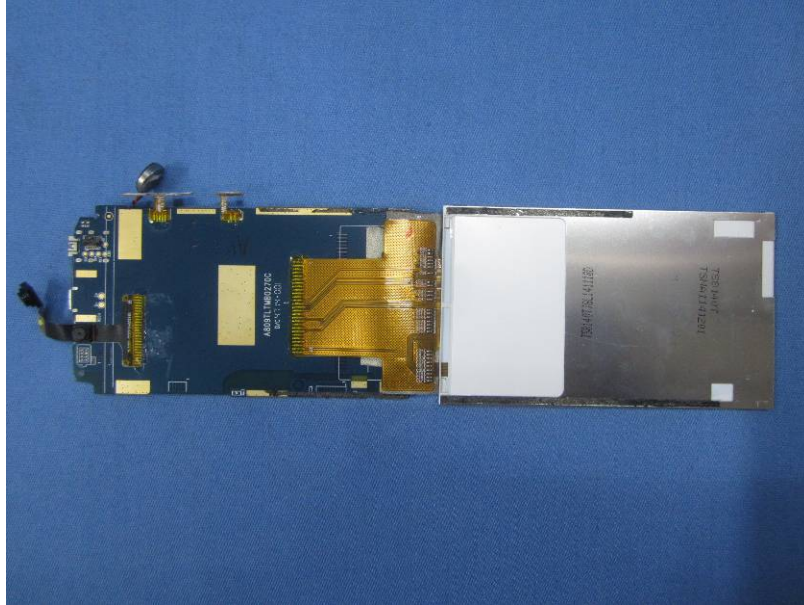

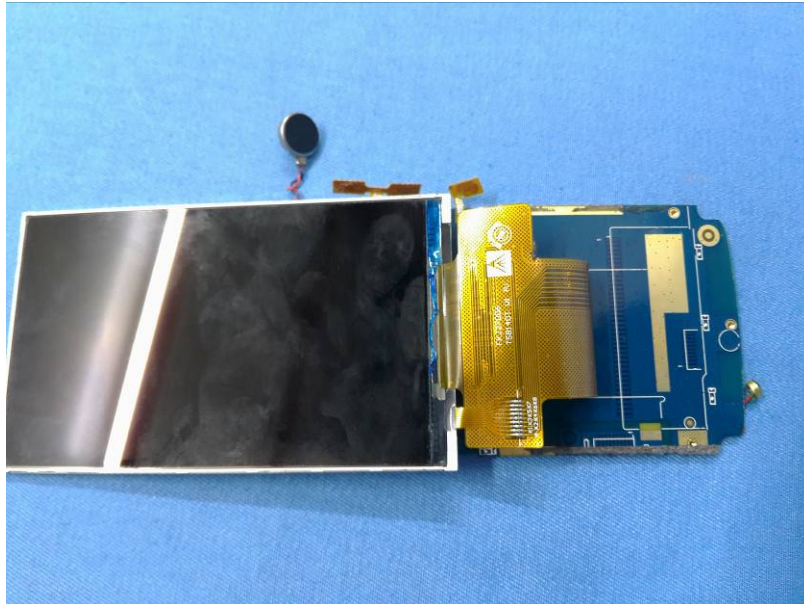



-----end-----