

FCC Report (LTE)

Applicant: Connected Holdings LLC

Address of Applicant: 4740 Von Karman Avenue, Suite 120, Newport Beach, California 92660, United States

Manufacturer: Gemtek Technology Co., Ltd.

Address of Manufacturer: No. 15-1 Zhonghua Road, Hsinchu Industrial Park, Hukou, Hsinchu, Taiwan, 30352

Equipment Under Test (EUT)

Product Name: GPS Tracker

Model No.: AR-4LA

Marketing Name: Arrow-L

FCC ID: 2AEB4ALV01

Applicable standards: FCC CFR Title 47 Part 2: 2017
FCC CFR Title 47 Part27: 2017

Date of sample receipt: July 03, 2017

Date of Test: July 04-10, 2017

Date of report issued: July 11, 2017

Test Result : PASS *

* In the configuration tested, the EUT complied with the standards specified above.

Authorized Signature:



Robinson Lo
Laboratory Manager

This results shown in this test report refer only to the sample(s) tested, this test report cannot be reproduced, except in full, without prior written permission of the company. The report would be invalid without specific stamp of test institute and the signatures of compiler and approver.

1 Version

Version No.	Date	Description
00	July 11, 2017	Original

Prepared By:



Date:

July 11, 2017

Project Engineer

Check By:

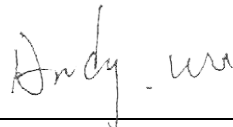

Date:

July 11, 2017

Reviewer

2 Contents

Page

COVER PAGE	1
1 VERSION	2
2 CONTENTS	3
3 TEST SUMMARY	4
4 GENERAL INFORMATION	5
4.1 GENERAL DESCRIPTION OF EUT	5
4.2 RELATED SUBMITTAL(S) / GRANT (S)	6
4.3 TEST METHODOLOGY.....	6
4.4 TEST FACILITY	6
4.5 TEST LOCATION.....	6
5 TEST INSTRUMENTS LIST	7
6 SYSTEM TEST CONFIGURATION	8
6.1 TEST MODE	8
6.2 CONFIGURATION OF TESTED SYSTEM	9
6.3 CONDUCTED PEAK OUTPUT POWER	10
6.4 PEAK-TO-AVERAGE RATIO	15
6.5 OCCUPY BANDWIDTH.....	29
6.6 MODULATION CHARACTERISTIC.....	44
6.7 OUT OF BAND EMISSION AT ANTENNA TERMINALS.....	44
6.8 ERP, EIRP MEASUREMENT	69
6.9 FIELD STRENGTH OF SPURIOUS RADIATION MEASUREMENT.....	83
6.10 FREQUENCY STABILITY V.S. TEMPERATURE MEASUREMENT.....	97
6.11 FREQUENCY STABILITY V.S. VOLTAGE MEASUREMENT	100
7 TEST SETUP PHOTO	102
8 EUT CONSTRUCTIONAL DETAILS	103

3 Test Summary

Test Item	Section in CFR 47	Result
RF Exposure (SAR)	Part 1.1307 Part 2.1091	Pass* (Please refer to MPE Report)
RF Output Power	Part 2.1046 Part 27.50(b)(9)/(d)(5)	Pass
Modulation Characteristics	Part 2.1047	N/A
99% & -26 dB Occupied Bandwidth	Part 2.1049 Part 27.53(h)/(c)(2)	Pass
Spurious Emissions at Antenna Terminal	Part 2.1051 Part 27.53(h)/(c)(2)	Pass
Field Strength of Spurious Radiation	Part 2.1053 Part 27.53(h)/(c)(2)	Pass
Out of band emission, Band Edge	Part 27.53(h)/(c)(2)	Pass
Frequency stability vs. temperature	Part 2.1055(a)(1)(b)	Pass
Frequency stability vs. voltage	Part 2.1055(d)(1)(2)	Pass
Peak-to-Average ratio	FCC part24.232(d)	Pass

Pass: The EUT complies with the essential requirements in the standard.

4 General Information

4.1 General Description of EUT

Product Name:	GPS Tracker
Model No.:	AR-4LA
Support Networks:	LTE
Support Bands:	LTE Band 4, LTE Band 13
Channel Bandwidth:	LTE Band 4: 1.4MHz; 3MHz; 5MHz; 10MHz; 15MHz; 20MHz LTE Band 13: 5MHz; 10MHz
TX Frequency:	LTE Band 4: 1710.70MHz-1754.30MHz LTE Band 13: 779.50MHz-784.50MHz
Modulation type:	LTE Band 4/13: QPSK, 16QAM
Antenna type:	Integral antenna
Antenna gain:	2.5dBi(Band 4), -0.5dBi(Band 4)
Power supply:	Battery: DC 3.7V, 296mWh Input: DC12V

4.2 Related Submittal(s) / Grant (s)

This submittal(s) (test report) is filing to comply with Section Part 27 of the FCC CFR 47 Rules.

4.3 Test Methodology

Both conducted and radiated testing were performed according to the procedures document on TIA/EIA 603 and FCC CFR 47.1046, 2.1047, 2.1049, 2.1051, 2.1053, 2.1055 and 2.1057

4.4 Test Facility

The test facility is recognized, certified, or accredited by the following organizations:

- **FCC —Registration No.: 600491**

Global United Technology Services Co., Ltd., Shenzhen EMC Laboratory has been registered and fully described in a report filed with the (FCC) Federal Communications Commission. The acceptance letter from the FCC is maintained in files. Registration 600491, June 22, 2016.

- **Industry Canada (IC) —Registration No.: 9079A-2**

The 3m Semi-anechoic chamber of Global United Technology Services Co., Ltd. has been registered by Certification and Engineering Bureau of Industry Canada for radio equipment testing with Registration No.: 9079A-2, August 15, 2016.

4.5 Test Location

All tests were performed at:

Global United Technology Services Co., Ltd.

Address: No. 301-309, 3/F., Jinyuan Business Building, No.2, Laodong Industrial Zone, Xixiang Road, Baoan District, Shenzhen, Guangdong, China 518102

Tel: 0755-27798480

Fax: 0755-27798960

5 Test Instruments list

Radiated Emission:						
Item	Test Equipment	Manufacturer	Model No.	Inventory No.	Cal.Date (mm-dd-yy)	Cal.Due date (mm-dd-yy)
1	3m Semi- Anechoic Chamber	ZhongYu Electron	9.0(L)*6.0(W)* 6.0(H)	GTS250	July. 03 2015	July. 02 2020
2	Control Room	ZhongYu Electron	6.2(L)*2.5(W)* 2.4(H)	GTS251	N/A	N/A
3	Spectrum Analyzer	Agilent	E4440A	GTS533	Jun. 29 2017	Jun. 28 2018
4	EMI Test Receiver	Rohde & Schwarz	ESU26	GTS203	Jun. 29 2017	Jun. 28 2018
5	BiConiLog Antenna	SCHWARZBECK MESS-ELEKTRONIK	VULB9163	GTS214	Jun. 29 2017	Jun. 28 2018
6	Double -ridged waveguide horn	SCHWARZBECK MESS-ELEKTRONIK	9120D-829	GTS208	Jun. 29 2017	Jun. 28 2018
7	Horn Antenna	ETS-LINDGREN	3160	GTS217	Jun. 29 2017	Jun. 28 2018
8	EMI Test Software	AUDIX	E3	N/A	N/A	N/A
9	Coaxial Cable	GTS	N/A	GTS213	Jun. 29 2017	Jun. 28 2018
10	Coaxial Cable	GTS	N/A	GTS211	Jun. 29 2017	Jun. 28 2018
11	Coaxial cable	GTS	N/A	GTS210	Jun. 29 2017	Jun. 28 2018
12	Coaxial Cable	GTS	N/A	GTS212	Jun. 29 2017	Jun. 28 2018
13	Amplifier(100kHz-3GHz)	HP	8347A	GTS204	Jun. 29 2017	Jun. 28 2018
14	Amplifier(2GHz-20GHz)	HP	8349B	GTS206	Jun. 29 2017	Jun. 28 2018
15	Amplifier (18-26GHz)	Rohde & Schwarz	AFS33-18002 650-30-8P-44	GTS218	Jun. 29 2017	Jun. 28 2018
16	Band filter	Amindeon	82346	GTS219	Jun. 29 2017	Jun. 28 2018
17	Universal Radio Communication tester	ROHDE&SCHWARZ	CMU 200	GTS538	Jun. 29 2017	Jun. 28 2018
18	Wideband Radio Communication Tester	ROHDE&SCHWARZ	CMW 500	GTS539	Jun. 29 2017	Jun. 28 2018

General used equipment:						
Item	Test Equipment	Manufacturer	Model No.	Inventory No.	Cal.Date (mm-dd-yy)	Cal.Due date (mm-dd-yy)
1	Barometer	ChangChun	DYM3	GTS257	Jun. 29 2017	Jun. 28 2018

6 System test configuration

6.1 Test mode

During all testing, EUT is in link mode with base station emulator at maximum power level. The spurious emission measurements were carried out in semi-anechoic chamber with 3-meter test range, and EUT is rotated on three test planes to find out the worst emission.

Test modes		
Band	Radiated	Conducted
LTE Band 4	■ QPSK and 16QAM link	■ QPSK and 16QAM link
LTE Band 13	■ QPSK and 16QAM link	■ QPSK and 16QAM link

6.2 Configuration of Tested System

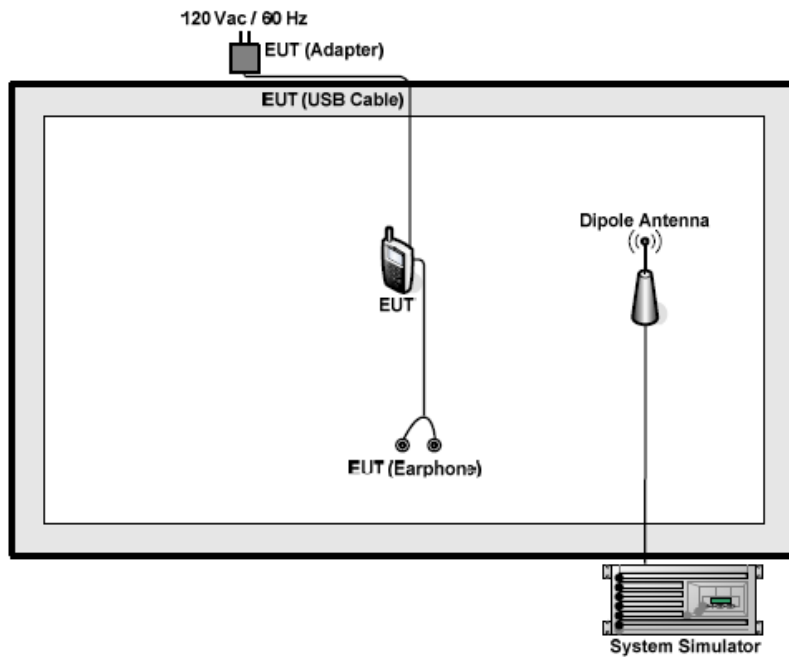

6.3 Conducted Peak Output Power

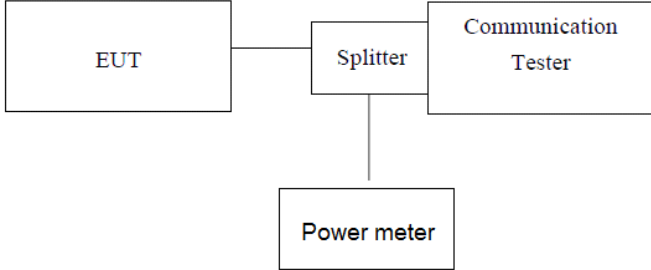
Test Requirement:	Part 27.50(b)(9)/(d)(5)
Test Method:	FCC part2.1046
Limit:	LTE Band 4: 1W LTE Band 13: 30W
Test setup:	 <p><i>Note: Measurement setup for testing on Antenna connector</i></p>
Test Procedure:	<ol style="list-style-type: none"> 1. The transmitter output port was connected to base station. 2. The RF output of EUT was connected to the power meter by RF cable and attenuator, the path loss was compensated to the results for each measurement. 3. Set EUT at maximum power through base station. 4. Select lowest, middle, and highest channels for each band and different modulation. 5. Measure the maximum burst average power.
Test Instruments:	Refer to section 6.0 for details
Test mode:	Refer to section 6.1 for details
Test results:	Pass

Measurement Data

Band 4						
Bandwidth	Mode	RB Size	RB Offset	Actual output power(dBm)		
				Channel 19957 1710.7MHz	Channel 20175 1732.5MHz	Channel 20393 1754.3MHz
1.4MHz	QPSK	1	0	21.41	21.51	21.52
		1	2	22.64	22.76	22.78
		1	5	23.09	23.15	23.16
		3	0	21.56	21.71	21.74
		3	1	22.46	22.56	22.57
		3	2	22.57	22.61	22.61
		6	0	23.18	23.26	23.28
	16QAM	1	0	21.28	21.38	21.39
		1	2	22.35	22.48	22.50
		1	5	22.93	22.95	22.96
		3	0	21.33	21.43	21.44
		3	1	22.41	22.48	22.49
		3	2	22.50	22.58	22.60
		6	0	23.05	23.11	23.12
Bandwidth	Mode	RB Size	RB Offset	Actual output power(dBm)		
				Channel 19965 1711.5MHz	Channel 20175 1732.5MHz	Channel 20385 1753.5MHz
3MHz	QPSK	1	0	21.37	21.48	21.49
		1	8	22.60	22.71	22.72
		1	14	23.07	23.15	23.16
		8	0	21.51	21.66	21.68
		8	4	22.43	22.52	22.54
		8	7	22.55	22.58	22.59
		15	0	23.15	23.24	23.26
	16QAM	1	0	21.24	21.34	21.35
		1	8	22.31	22.45	22.47
		1	15	22.92	22.94	22.95
		8	0	21.30	21.38	21.40
		8	4	22.38	22.45	22.47
		8	7	22.47	22.55	22.57
		15	0	23.02	23.09	23.10

Bandwidth	Mode	RB Size	RB Offset	Actual output power(dBm)		
				Channel 19975 1712.5MHz	Channel 20175 1732.5MHz	Channel 20375 1752.5MHz
5MHz	QPSK	1	0	21.32	21.42	21.44
		1	13	22.52	22.63	22.65
		1	24	23.05	23.11	23.12
		12	0	21.41	21.56	21.59
		12	6	22.37	22.46	22.48
		12	13	22.51	22.56	22.56
		25	0	23.10	23.19	23.20
	16QAM	1	0	21.18	21.28	21.29
		1	13	22.25	22.37	22.40
		1	24	22.90	22.93	22.93
		12	0	21.23	21.32	21.34
		12	6	22.34	22.41	22.42
		12	13	22.42	22.50	22.52
		25	0	22.98	23.05	22.89
Bandwidth	Mode	RB Size	RB Offset	Actual output power(dBm)		
				Channel 20000 1715.0MHz	Channel 20175 1732.5MHz	Channel 20350 1750.0MHz
10MHz	QPSK	1	0	21.31	21.41	21.42
		1	25	22.51	22.63	22.65
		1	49	23.04	23.10	23.11
		25	0	21.38	21.53	21.55
		25	13	22.35	22.44	22.46
		25	25	22.54	22.58	22.58
		50	0	23.04	23.12	23.13

Bandwidth	Mode	RB Size	RB Offset	Actual output power(dBm)		
				Channel 20025 1717.5MHz	Channel 20175 1732.5MHz	Channel 20325 1747.5MHz
15MHz	QPSK	1	0	21.28	21.38	21.39
		1	38	22.48	22.59	22.61
		1	74	23.02	23.08	23.09
		36	0	21.33	21.48	21.51
		36	18	22.32	22.41	22.43
		36	39	22.52	22.56	22.57
		75	0	23.01	23.09	23.11
Bandwidth	Mode	RB Size	RB Offset	Actual output power(dBm)		
				Channel 20050 1720.0MHz	Channel 20175 1732.5MHz	Channel 20300 1745.0MHz
20MHz	QPSK	1	0	21.24	21.34	21.36
		1	50	22.43	22.55	22.57
		1	99	23.00	23.06	23.07
		50	0	21.27	21.42	21.45
		50	25	22.29	22.38	22.39
		50	50	22.51	22.55	22.55
		100	0	22.98	23.06	23.07

Band 13						
Bandwidth	Mode	RB Size	RB Offset	Actual output power(dBm)		
				Channel 23205 779.5MHz	Channel 23230 782.0MHz	Channel 23255 784.5MHz
5MHz	QPSK	1	0	21.47	21.57	21.58
		1	13	22.70	22.81	22.83
		1	24	23.14	23.20	23.21
		12	0	21.64	21.80	21.82
		12	6	22.51	22.61	22.62
		12	13	22.58	22.62	22.63
		25	0	23.23	23.32	23.33
	16QAM	1	0	21.33	21.43	21.45
		1	13	22.44	22.57	22.59
		1	24	22.94	22.97	22.97
		12	0	21.37	21.47	21.48
		12	6	22.45	22.52	22.53
		12	13	22.55	22.63	22.64
		25	0	23.08	23.14	23.15
Bandwidth	Mode	RB Size	RB Offset	Actual output power(dBm)		
				---	Channel 23230 782.0MHz	---
10MHz	QPSK	1	0	---	21.54	---
		1	25	---	22.77	---
		1	49	---	23.22	---
		25	0	---	21.73	---
		25	13	---	22.59	---
		25	25	---	22.64	---
		50	0	---	23.25	---

Remark: "---" is not applicable.

6.4 Peak-to-Average Ratio

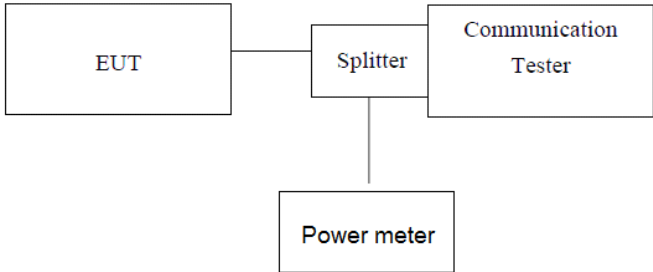
Test Requirement:	FCC part24.232(d)
Test Method:	FCC part2.1046
Limit:	13db
Test setup:	 <p style="text-align: center;"><i>Note: Measurement setup for testing on Antenna connector</i></p>
Test Procedure:	<ol style="list-style-type: none"> 1. The transmitter output port was connected to base station. 2. The RF output of EUT was connected to the power meter by RF cable and attenuator, the path loss was compensated to the results for each measurement. 3. Set EUT at maximum power through base station. 4. Select lowest, middle, and highest channels for each band and different modulation. 5. Measure the maximum burst average power. 6. Record the maximum peak-to-average ratio value.
Test Instruments:	Refer to section 6.0 for details
Test mode:	Refer to section 6.1 for details
Test results:	Pass

QPSK mode:

Test Band	Test mode	Peak to Average Ratio (dB)			Limit (dB)	Result
		Low Ch.	Middle Ch.	High Ch.		
LTE Band 4	LTE 1.4MHz Bandwidth	5.17	5.06	4.69	13	PASS
	LTE 3MHz Bandwidth	5.03	4.95	4.67	13	PASS
	LTE 5MHz Bandwidth	5.23	5.24	4.90	13	PASS
	LTE 10MHz Bandwidth	5.09	5.27	4.98	13	PASS
	LTE 15MHz Bandwidth	5.57	5.41	5.54	13	PASS
	LTE 20MHz Bandwidth	5.95	6.05	6.21	13	PASS
LTE Band 13	LTE 5MHz Bandwidth	4.61	4.39	4.85	13	PASS
	LTE 10MHz Bandwidth	---	4.95	---	13	PASS

16QAM mode:

Test Band	Test mode	Peak to Average Ratio (dB)			Limit (dB)	Result
		Low Ch.	Middle Ch.	High Ch.		
LTE Band 4	LTE 1.4MHz Bandwidth	5.17	5.02	4.69	13	PASS
	LTE 3MHz Bandwidth	5.07	4.93	4.66	13	PASS
	LTE 5MHz Bandwidth	5.16	5.24	4.95	13	PASS
LTE Band 13	LTE 5MHz Bandwidth	4.60	4.43	4.87	13	PASS

Test plot as follows:

QPSK mode:

Test band: LTE Band 4	Channel Bandwidth: 1.4MHz
-----------------------	---------------------------

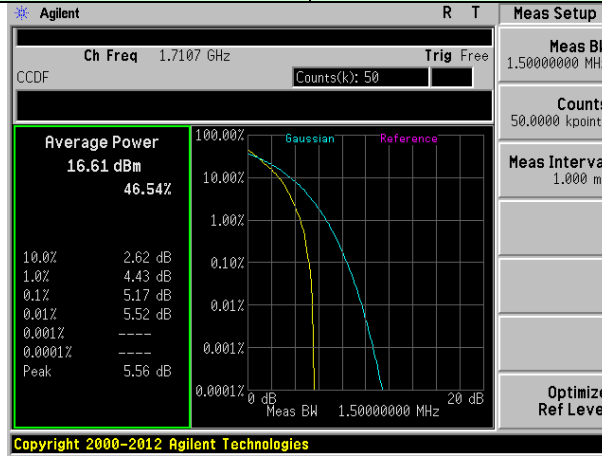

Lowest channel

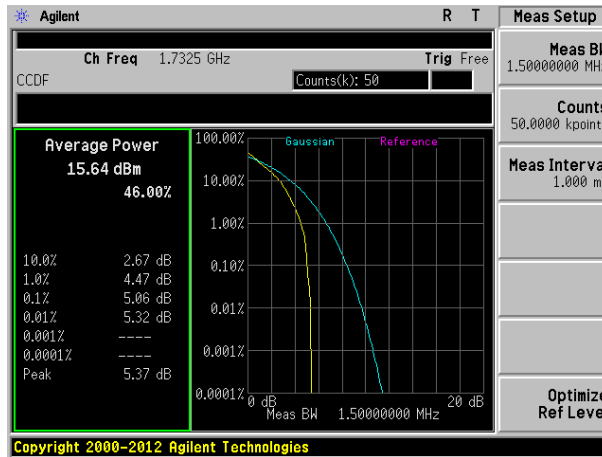

Middle channel

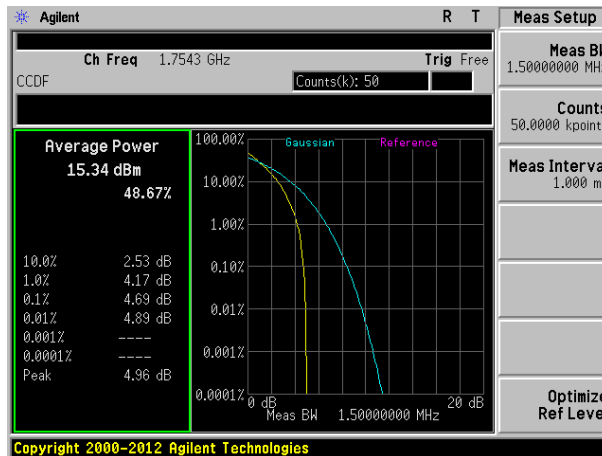

Highest channel

Test band: LTE Band 4 Channel Bandwidth: 3MHz

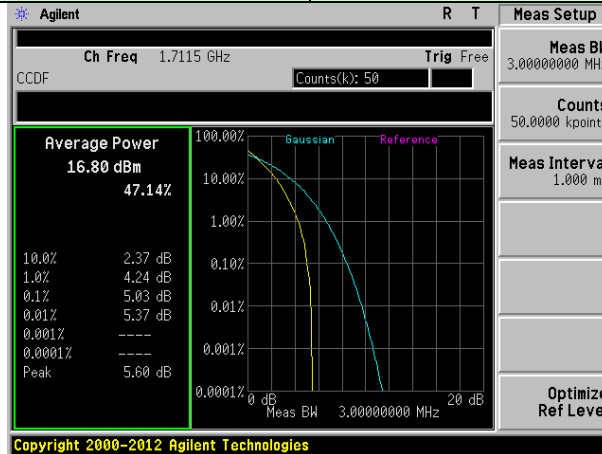

Lowest channel



Middle channel

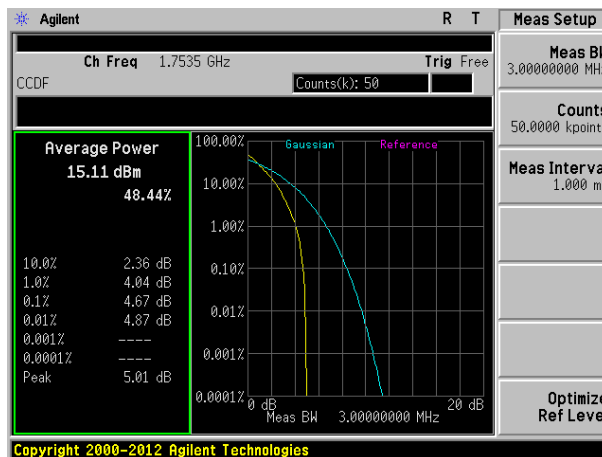

Highest channel

Test band: LTE Band 4 Channel Bandwidth: 5MHz

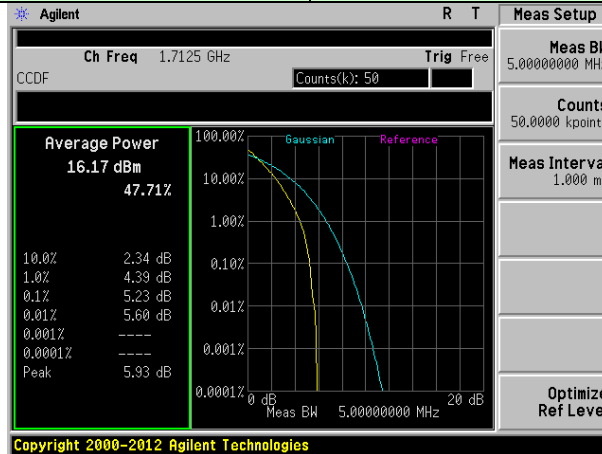

Lowest channel

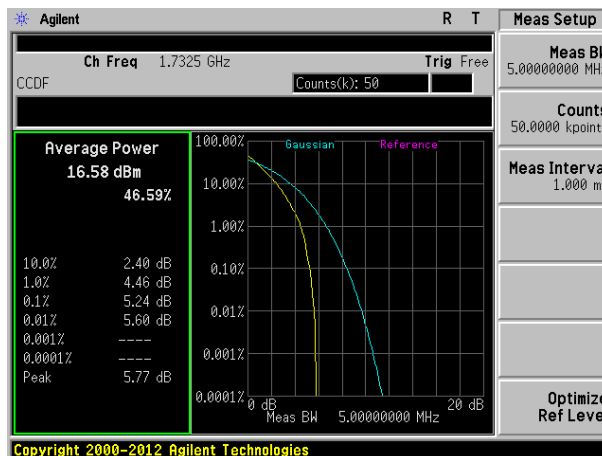

Middle channel

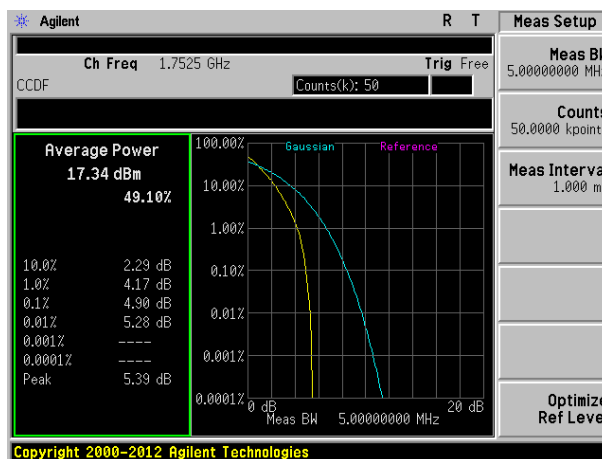

Highest channel

Test band: LTE Band 4 Channel Bandwidth: 10MHz

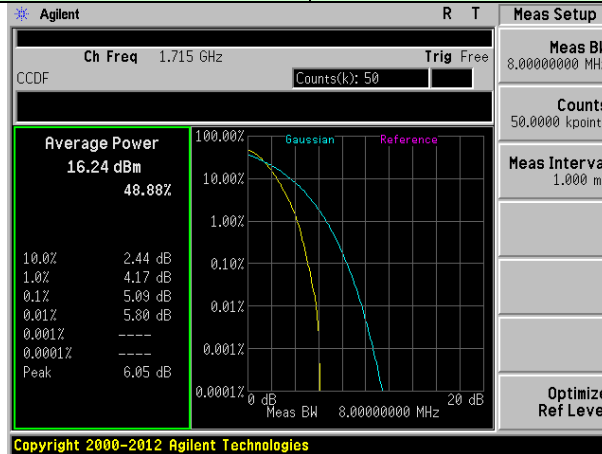

Lowest channel

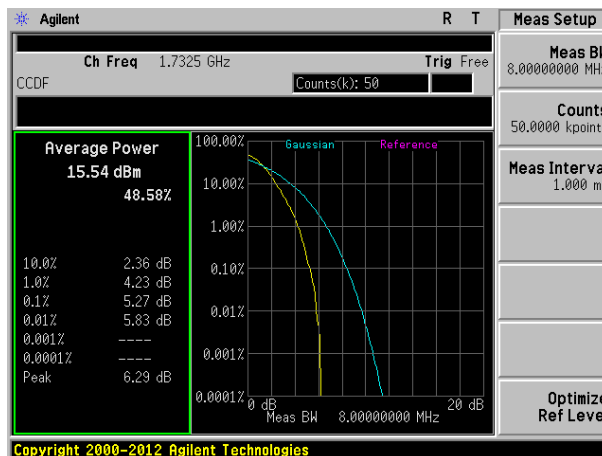

Middle channel

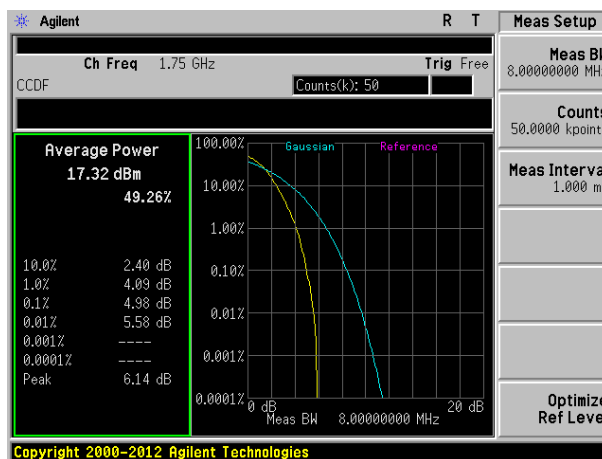

Highest channel

Test band: LTE Band 4 Channel Bandwidth: 15MHz

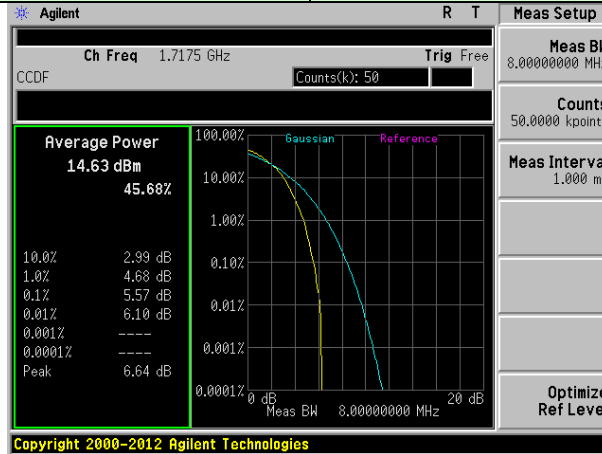

Lowest channel



Middle channel

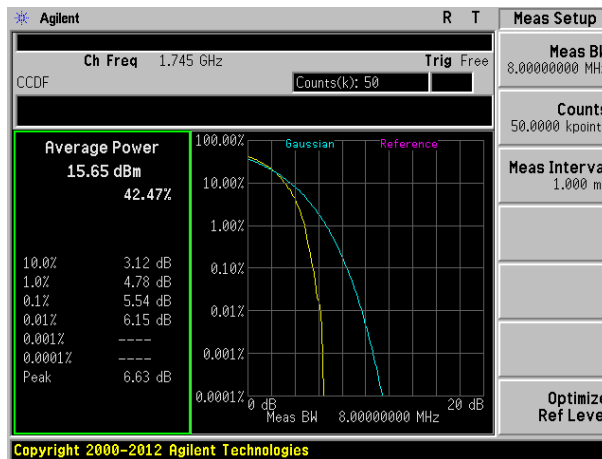

Highest channel

Test band: LTE Band 4 Channel Bandwidth: 20MHz

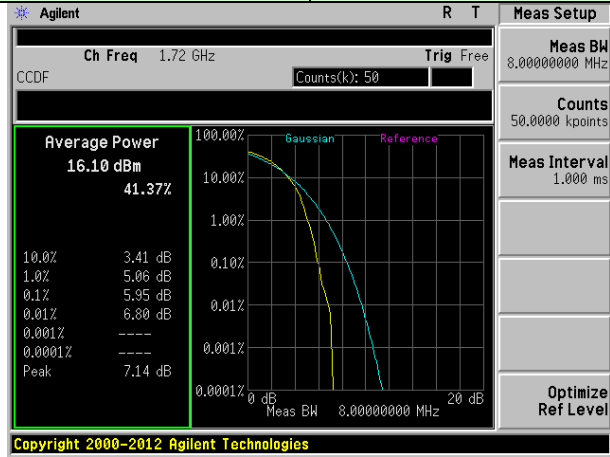

Lowest channel

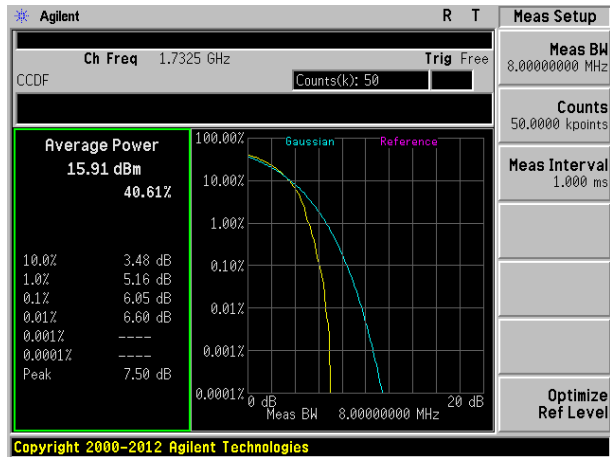

Middle channel

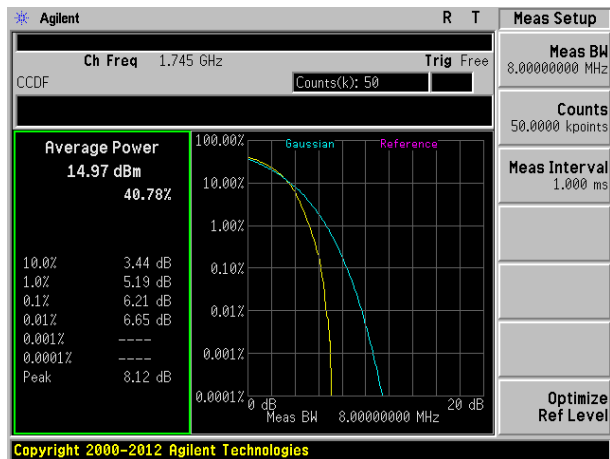

Highest channel

Test band: LTE Band 13 Channel Bandwidth: 5MHz

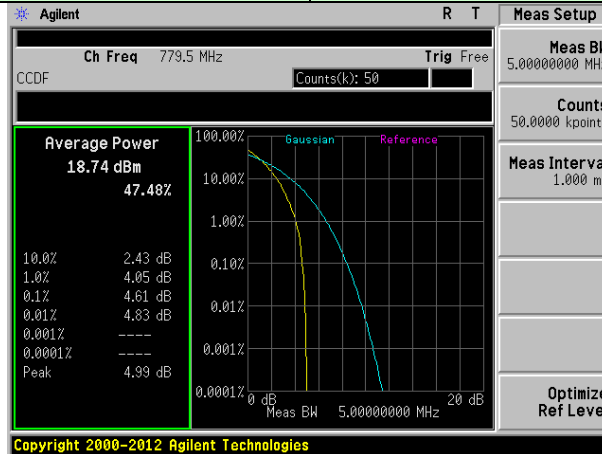

Lowest channel

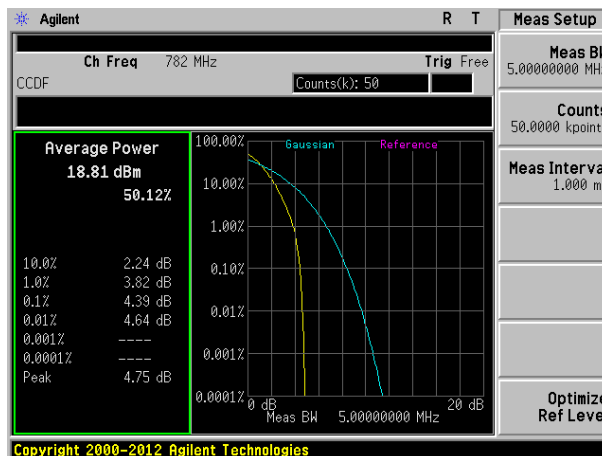

Middle channel

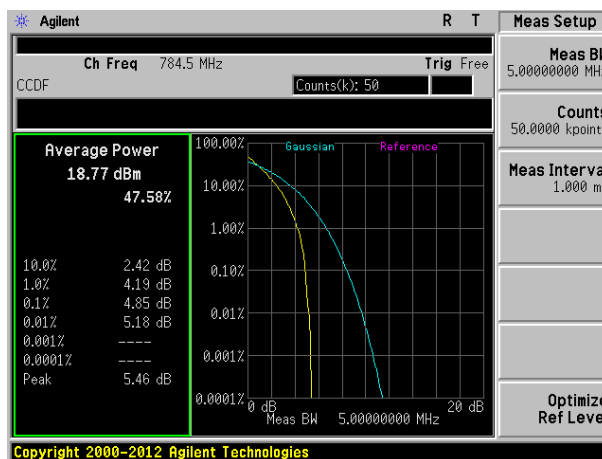

Highest channel

Test band: LTE Band 13 Channel Bandwidth: 10MHz

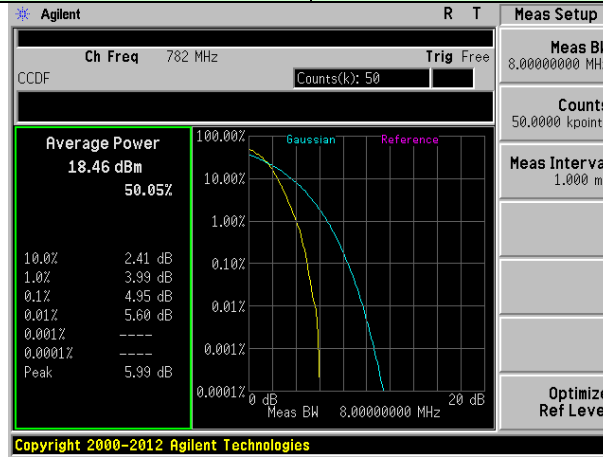

Middle channel

16QAM mode:

Test band: LTE Band 4	Channel Bandwidth: 1.4MHz
-----------------------	---------------------------

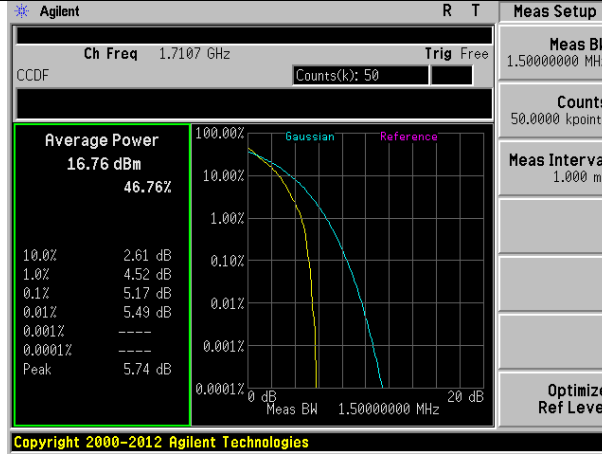

Lowest channel

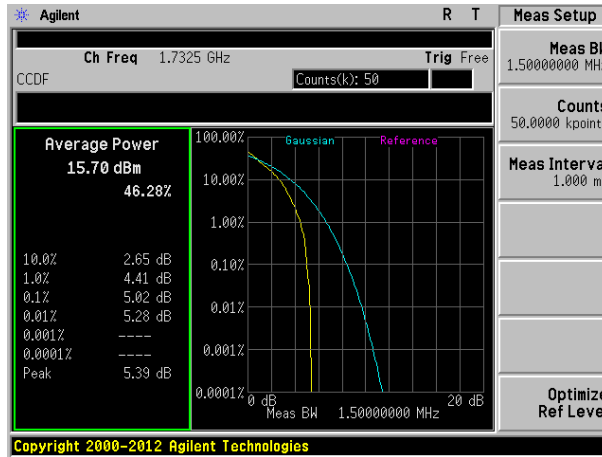

Middle channel

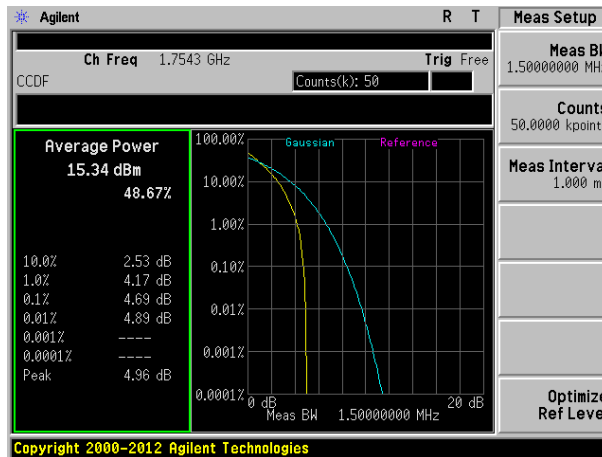

Highest channel

Test band: LTE Band 4 Channel Bandwidth: 3MHz

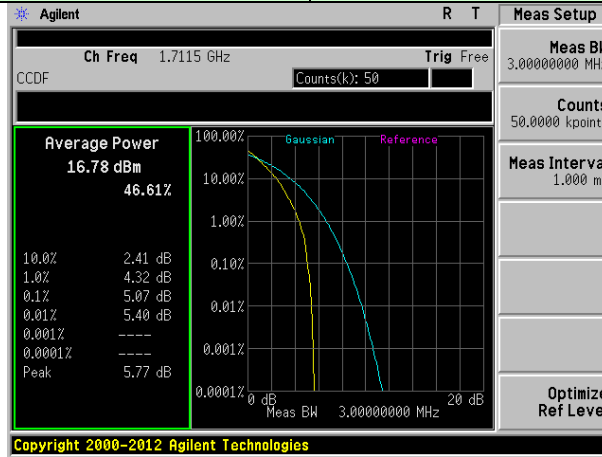

Lowest channel

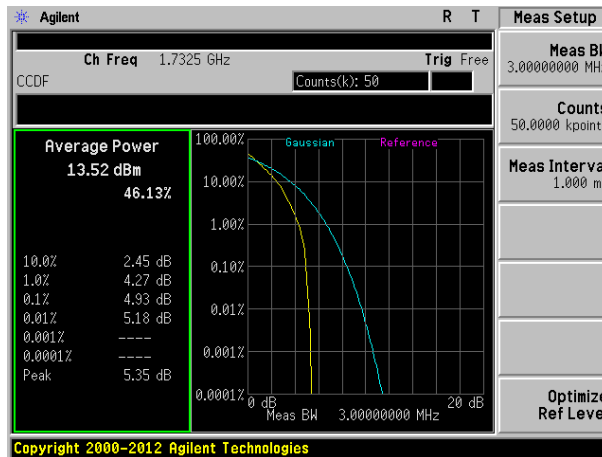

Middle channel

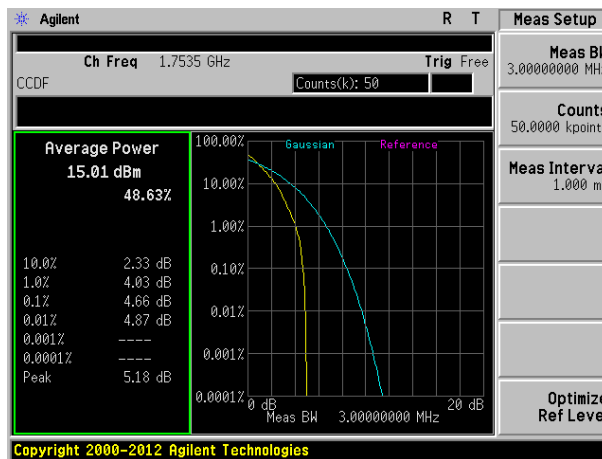

Highest channel

Test band: LTE Band 4 Channel Bandwidth: 5MHz

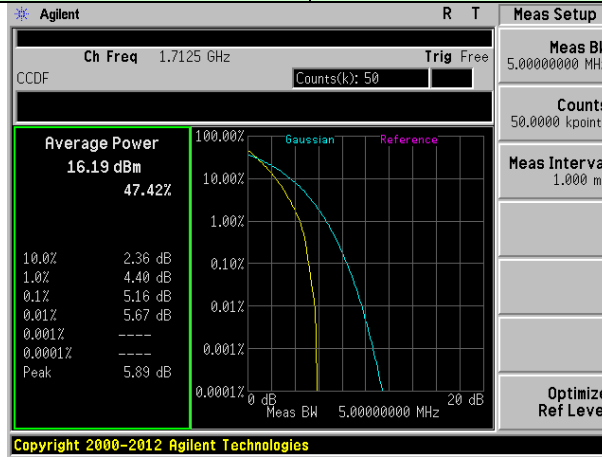

Lowest channel

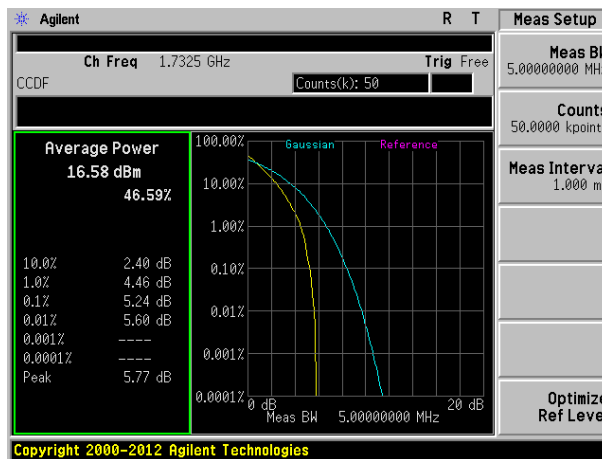

Middle channel

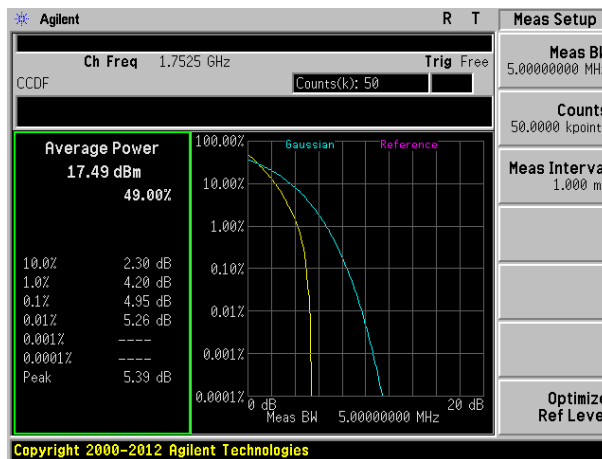

Highest channel

Test band: LTE Band 13 Channel Bandwidth: 5MHz

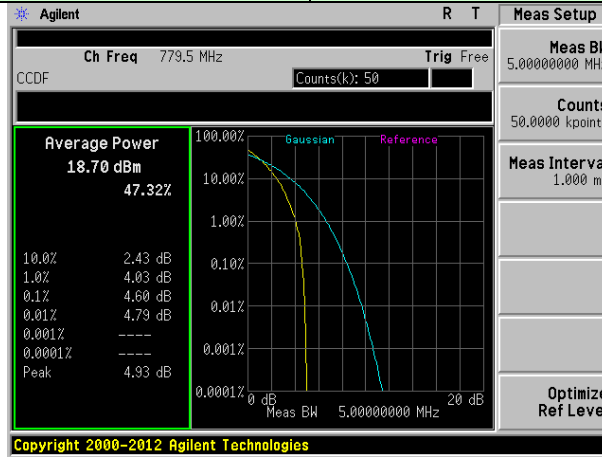

Lowest channel

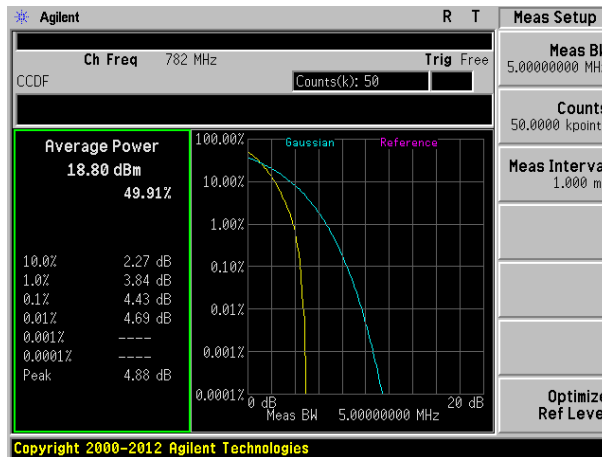

Middle channel

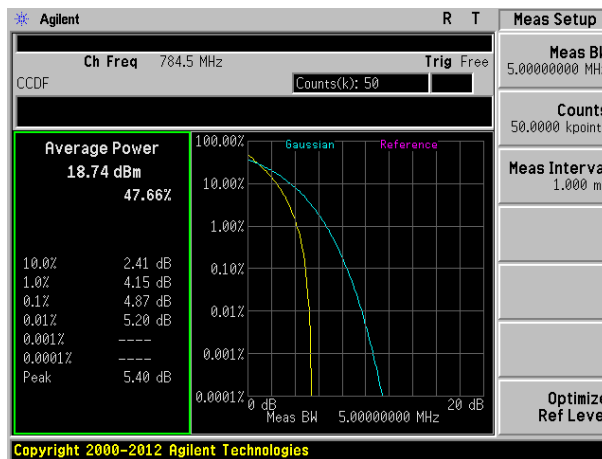

Highest channel

6.5 Occupancy Bandwidth

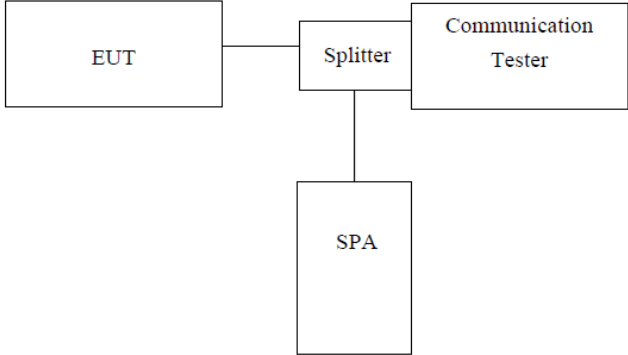
Test Requirement:	FCC Part 27.53(h)/(c)(2)
Test Method:	FCC part2.1049
Test setup:	 <p><i>Note: Measurement setup for testing on Antenna connector</i></p>
Test Procedure:	<ol style="list-style-type: none"> 1. The EUT's output RF connector was connected with a short cable to the spectrum analyzer 2. RBW was set to about 1% of emission BW, VBW= 3 times RBW. 3. -26dBc display line was placed on the screen (or 99% bandwidth), the occupied bandwidth is the delta frequency between the two points where the display line intersects the signal trace.
Test Instruments:	Refer to section 6.0 for details
Test mode:	Refer to section 6.1 for details
Test results:	Pass

Measurement Data

QPSK mode:

EUT Mode	Channel Bandwidth	Channel	RB Configure		99% Occupy bandwidth (KHz)	-26dB bandwidth (KHz)
			RB Size	RB Offset		
LTE Band 4	1.4MHz	Low range	6	0	1094.70	1296.00
		Mid range	6	0	1091.70	1301.00
		High range	6	0	1101.00	1280.00
	3MHz	Low range	15	0	2685.10	2936.00
		Mid range	15	0	2684.30	2955.00
		High range	15	0	2687.60	2937.00
	5MHz	Low range	25	0	4524.00	5015.00
		Mid range	25	0	4517.50	4997.00
		High range	25	0	4511.60	4976.00
	10MHz	Low range	50	0	8927.10	9734.00
		Mid range	50	0	8935.10	9725.00
		High range	50	0	8939.70	9618.00
	15MHz	Low range	75	0	13410.90	14671.00
		Mid range	75	0	13451.80	14650.00
		High range	75	0	13393.90	14678.00
	20MHz	Low range	100	0	17753.20	19048.00
		Mid range	100	0	17855.20	19350.00
		High range	100	0	17798.10	19374.00
EUT Mode	Channel Bandwidth	Channel	RB Configure		99% Occupy bandwidth (KHz)	-26dB bandwidth (KHz)
LTE Band 13	5MHz	Low range	25	0	4512.20	4998.00
		Mid range	25	0	4503.60	4991.00
		High range	25	0	4521.00	5034.00
	10MHz	Mid range	50	0	8922.00	9664.00

16QAM mode:

EUT Mode	Channel Bandwidth	Channel	RB Configure		99% Occupy bandwidth (KHz)	-26dB bandwidth (KHz)
			RB Size	RB Offset		
LTE Band 4	1.4MHz	Low range	6	0	1092.6	1283.00
		Mid range	6	0	1095.1	1304.00
		High range	6	0	1106.0	1322.00
	3MHz	Low range	15	0	2681.3	2925.00
		Mid range	15	0	2681.8	2931.00
		High range	15	0	2683.4	2944.00
	5MHz	Low range	25	0	4509.9	4971.00
		Mid range	25	0	4511.7	4970.00
		High range	25	0	4500.3	5015.00
EUT Mode	Channel Bandwidth	Channel	RB Configure		99% Occupy bandwidth (KHz)	-26dB bandwidth (KHz)
			RB Size	RB Offset		
LTE Band 13	5MHz	Low range	25	0	4513.8	5002.00
		Mid range	25	0	4520.3	4949.00
		High range	25	0	4545.3	5024.00

Test plot as follows:

QPSK mode:

Test band: LTE Band 4	Channel Bandwidth: 1.4MHz
-----------------------	---------------------------

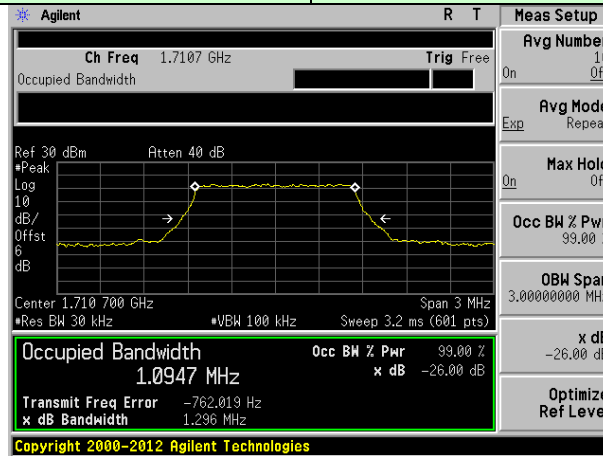

Lowest channel

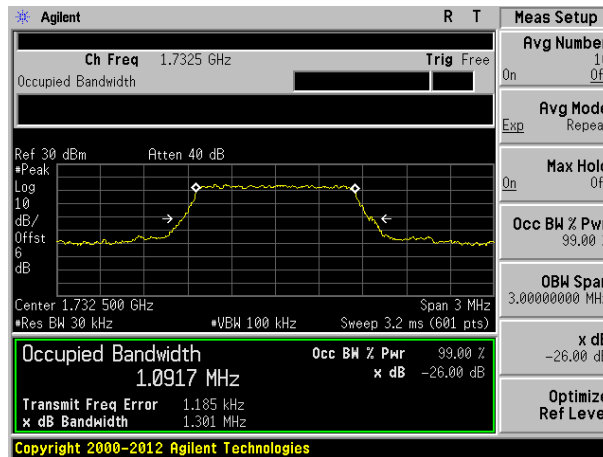

Middle channel

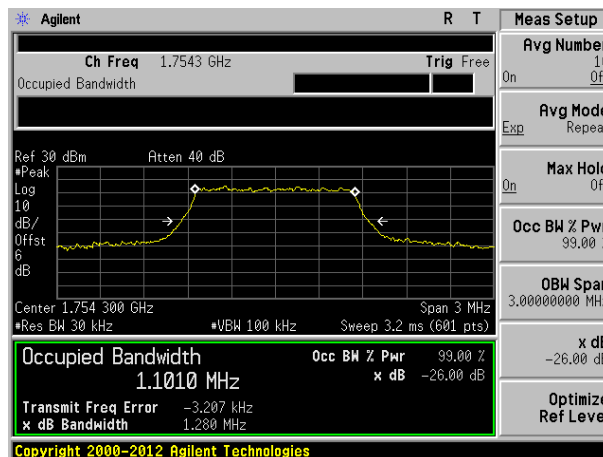

Highest channel

Test band: LTE Band 4 Channel Bandwidth: 3MHz

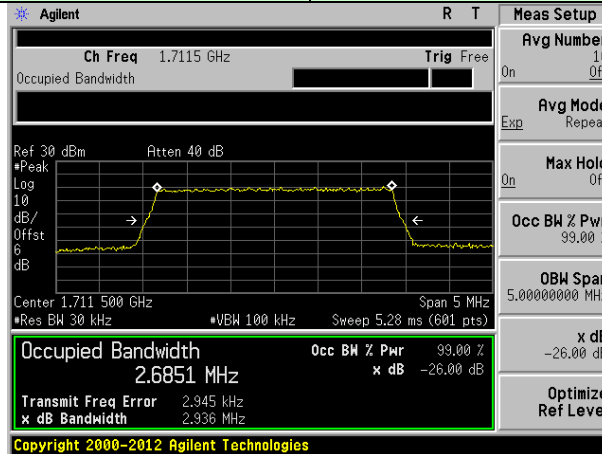

Lowest channel

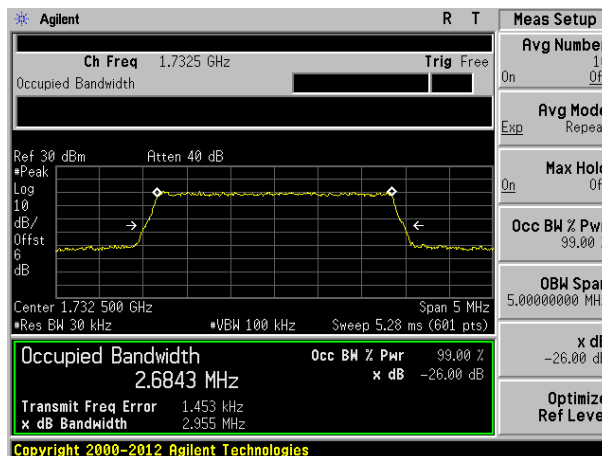

Middle channel

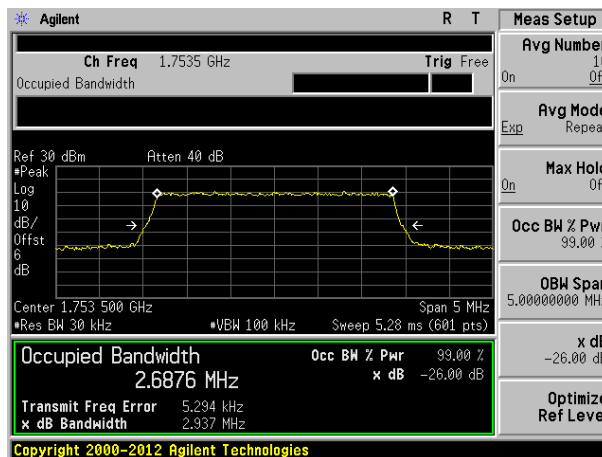

Highest channel

Test band: LTE Band 4 Channel Bandwidth: 5MHz

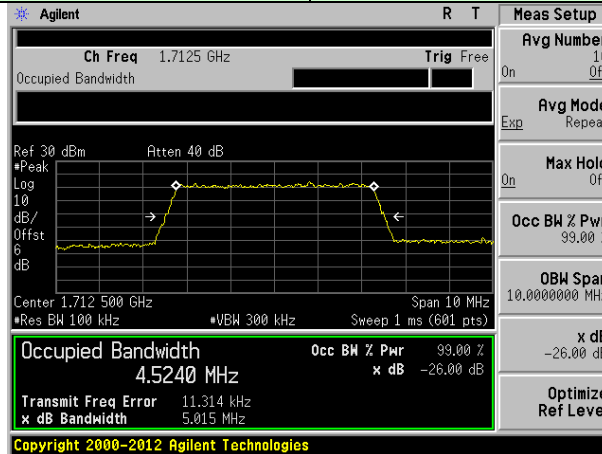

Lowest channel

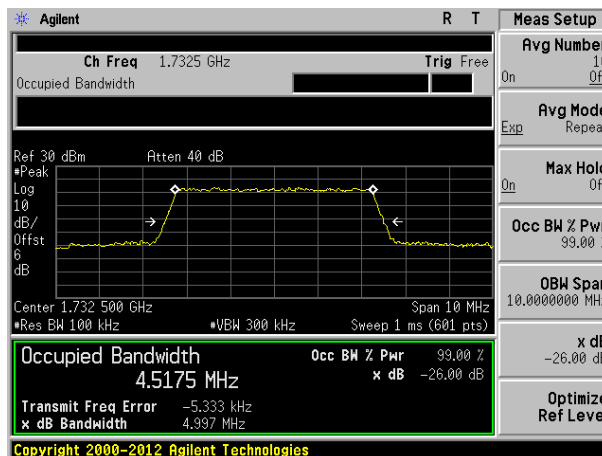

Middle channel

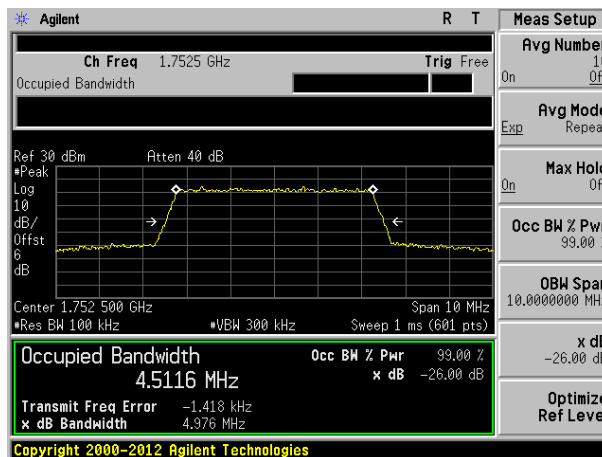

Highest channel

Test band: LTE Band 4 Channel Bandwidth: 10MHz

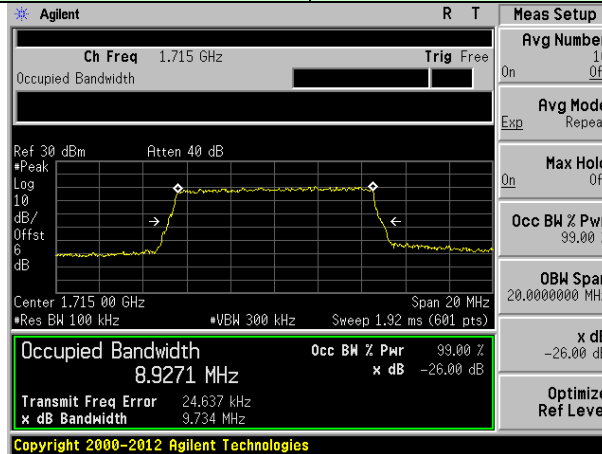

Lowest channel

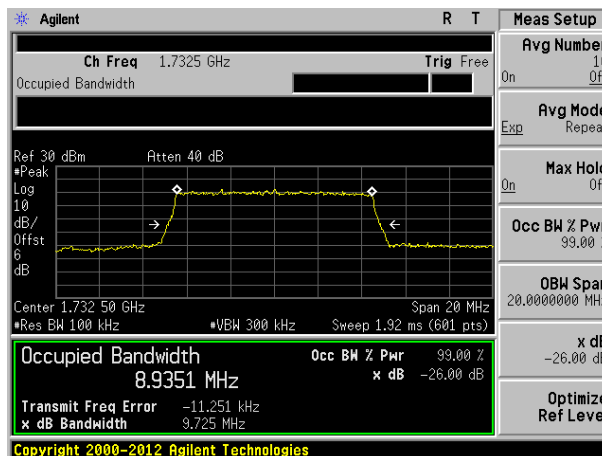

Middle channel

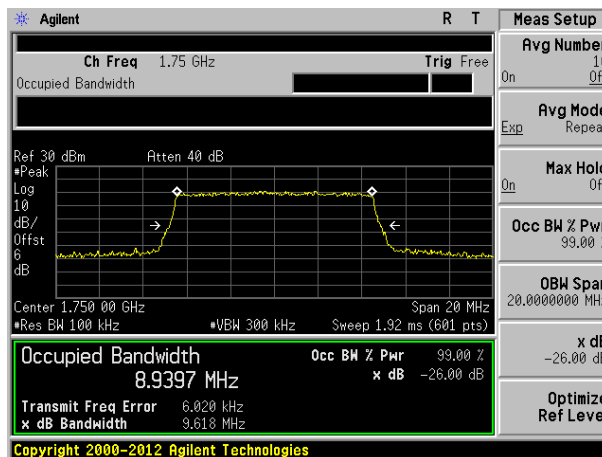

Highest channel

Test band: LTE Band 4 Channel Bandwidth: 15MHz

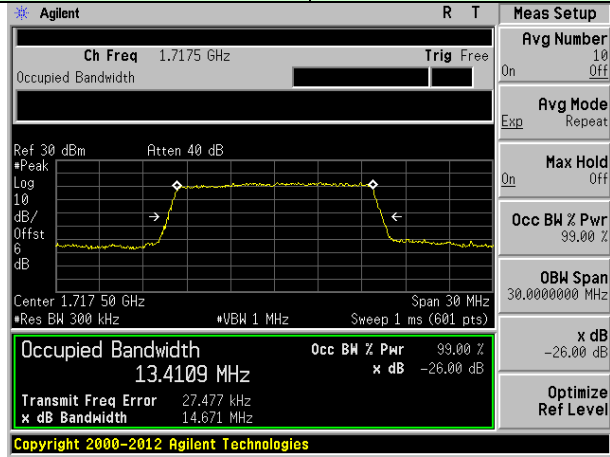

Lowest channel

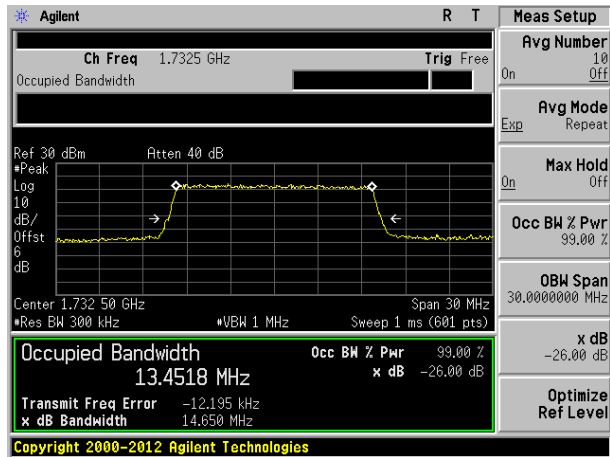

Middle channel

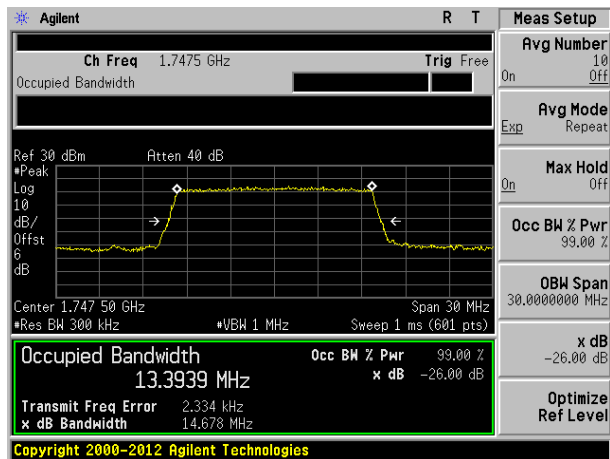

Highest channel

Test band: LTE Band 4 Channel Bandwidth: 20MHz

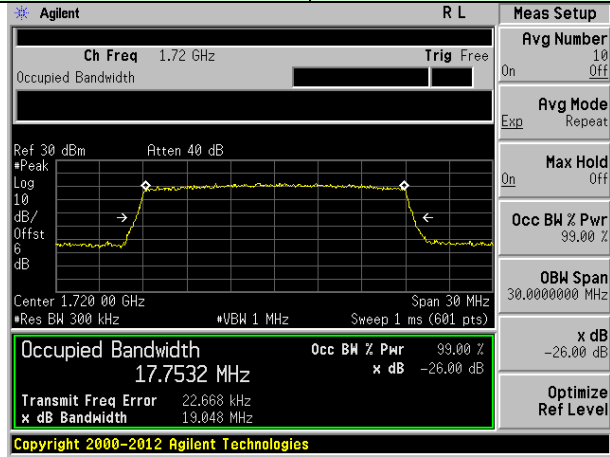

Lowest channel

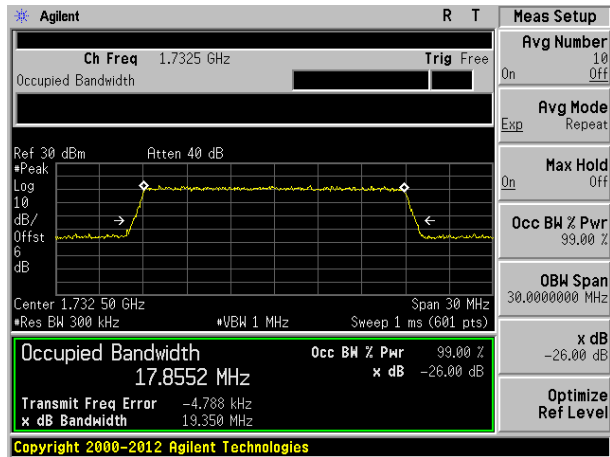

Middle channel

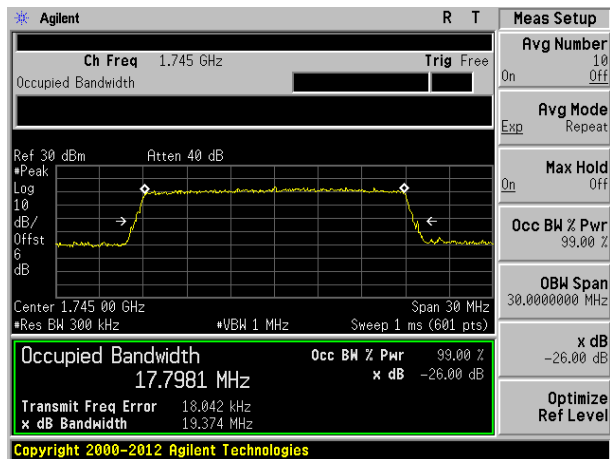

Highest channel

Test band: LTE Band 13 Channel Bandwidth: 5MHz

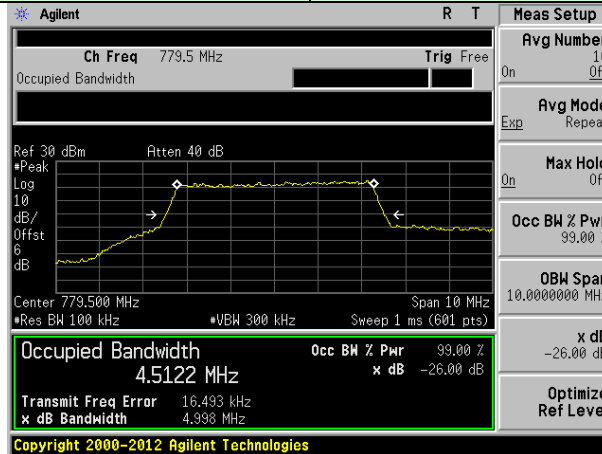

Lowest channel

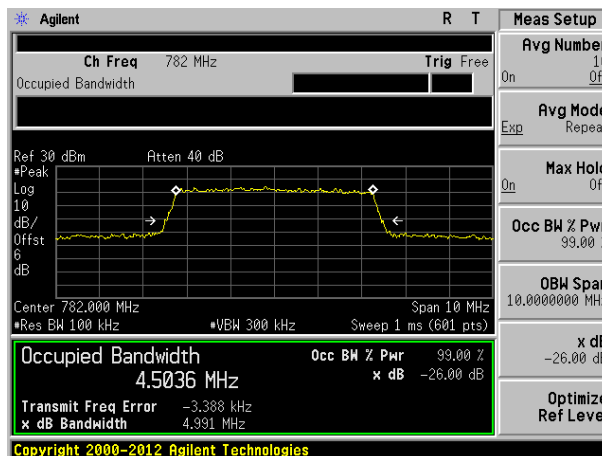

Middle channel

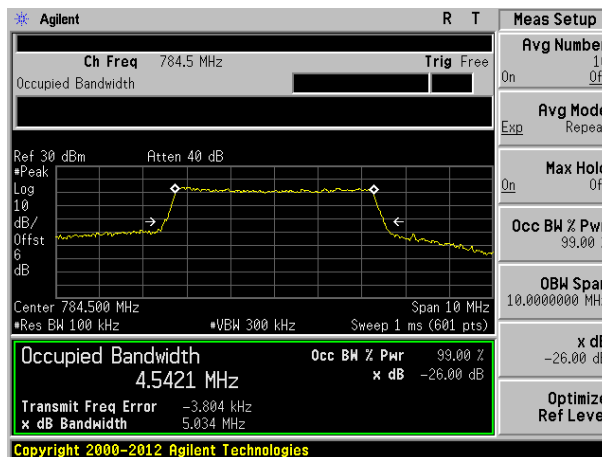

Highest channel

Test band: LTE Band 13 Channel Bandwidth: 10MHz

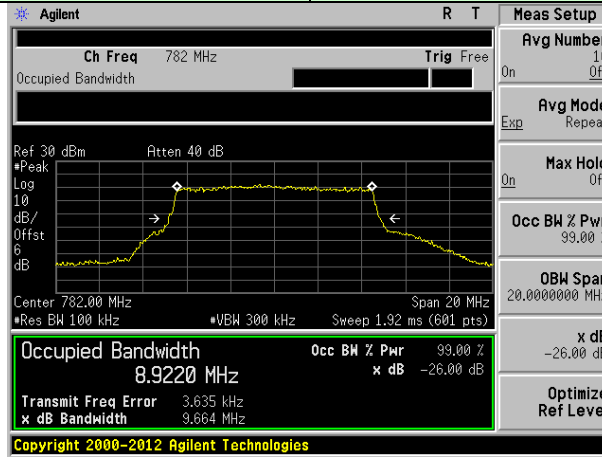

Middle channel

16QAM mode:

Test band: LTE Band 4	Channel Bandwidth: 1.4MHz
-----------------------	---------------------------

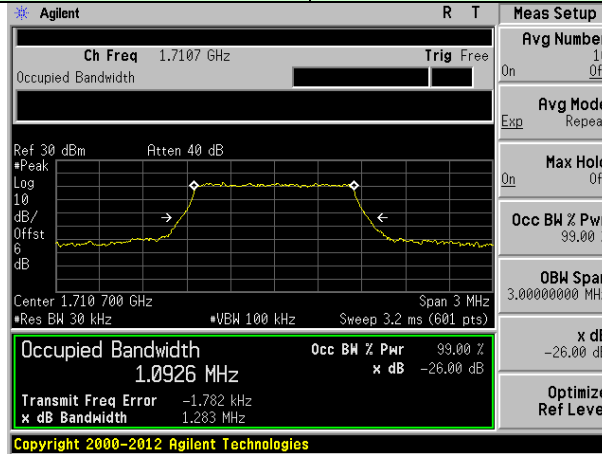

Lowest channel

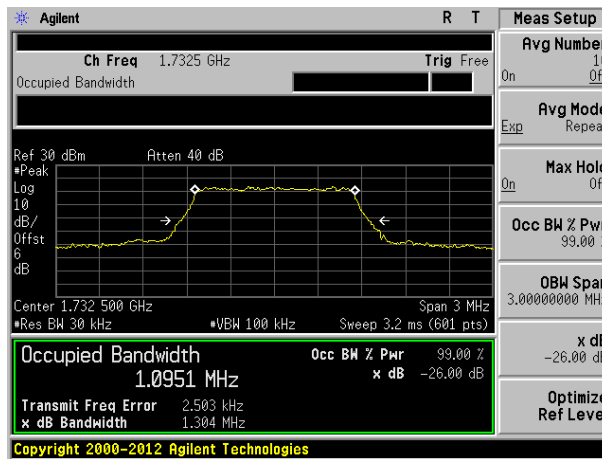

Middle channel

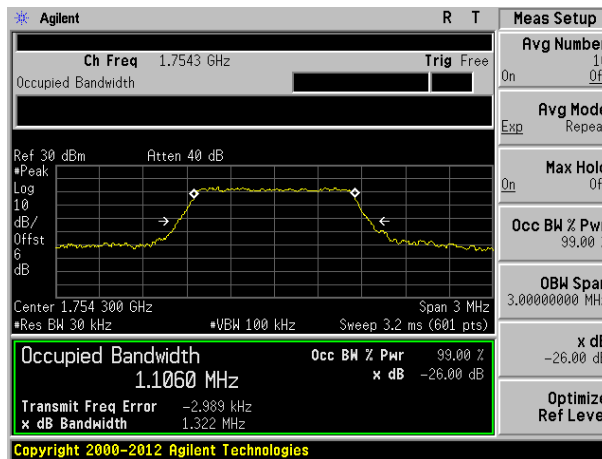

Highest channel

Test band: LTE Band 4 Channel Bandwidth: 3MHz

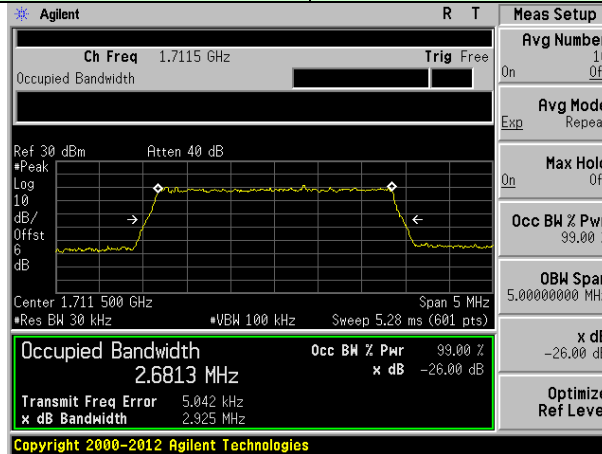

Lowest channel

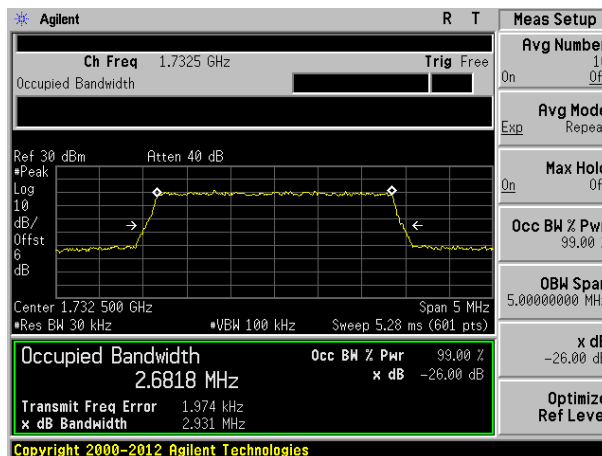

Middle channel

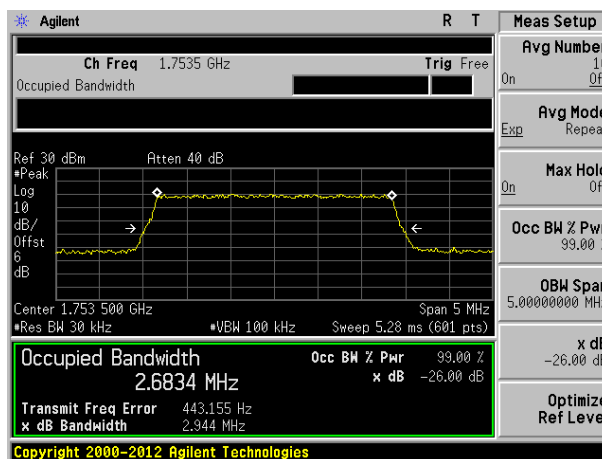

Highest channel

Test band: LTE Band 4 Channel Bandwidth: 5MHz

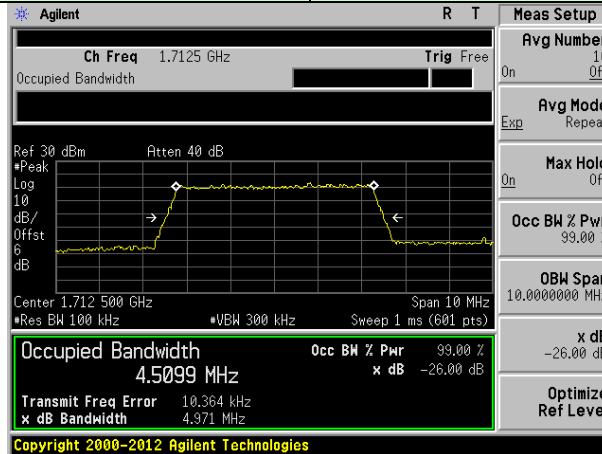

Lowest channel

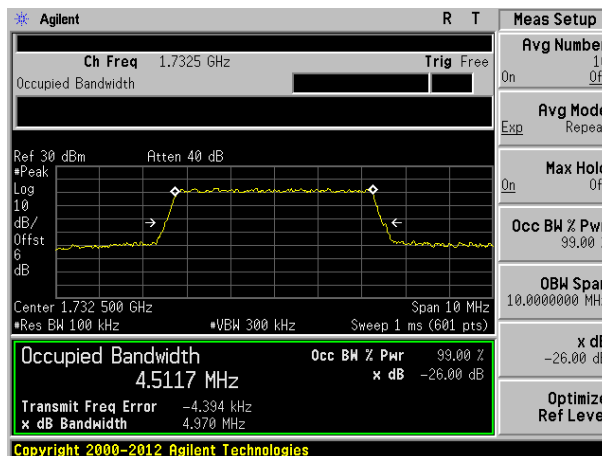

Middle channel

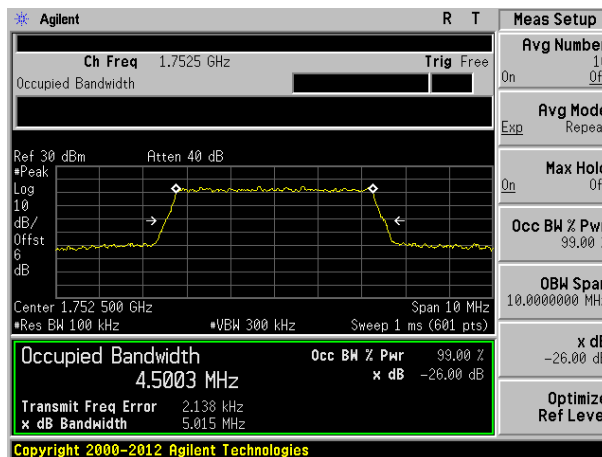

Highest channel

Test band: LTE Band 13 Channel Bandwidth: 5MHz

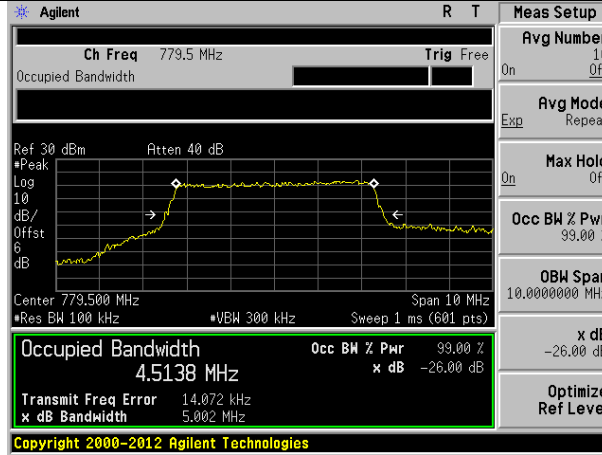

Lowest channel

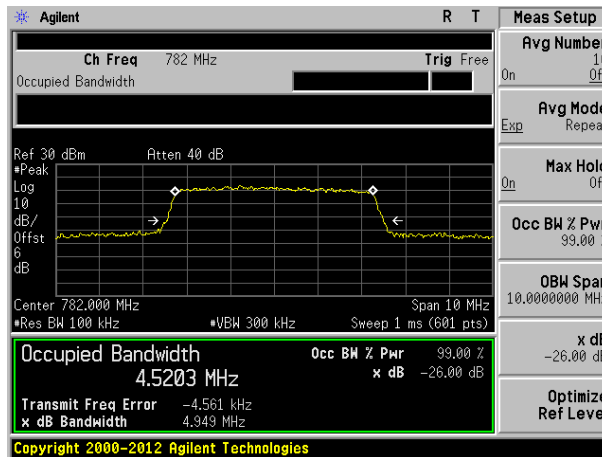

Middle channel

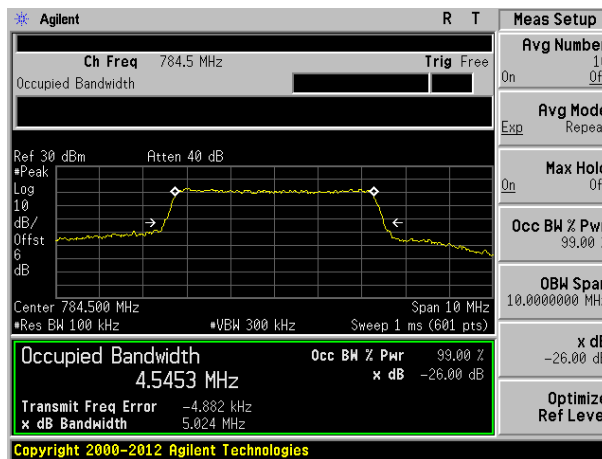

Highest channel

6.6 MODULATION CHARACTERISTIC

According to FCC § 2.1047(d), Part 27 there is no specific requirement for digital modulation, therefore modulation characteristic is not presented.

6.7 Out of band emission at antenna terminals

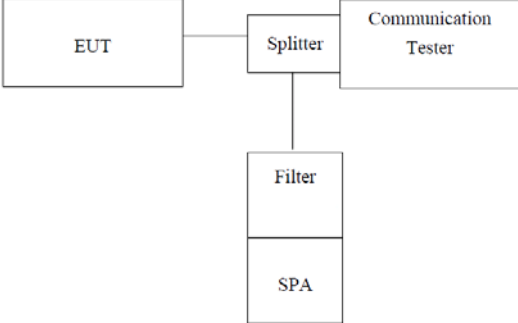
Test Requirement:	FCC Part 27.53(h)/(c)(2)
Test Method:	FCC part2.1051
Limit:	-13dBm For operations in the 746-758 MHz, 775-788 MHz, and 805-806 MHz bands, emissions in the band 1559-1610 MHz shall be limited to -70 dBW/MHz equivalent isotropically radiated power (EIRP) for wideband signals.
Test setup:	 <p><i>Note: Measurement setup for testing on Antenna connector</i></p>
Test Procedure:	<ol style="list-style-type: none"> 1 The RF output of the transceiver was connected to a spectrum analyzer through appropriate attenuation. 2 The resolution bandwidth of the spectrum analyzer was set at 1MHz, sufficient scans were taken to show the out of band Emissions if any up to 10th harmonic. 3 For the out of band: Set the RBW, VBW = 1MHz, Start=30MHz, Stop= 10th harmonic. 4 Band Edge Requirements: In the 1 MHz bands immediately outside and adjacent to the frequency block, a resolution bandwidth of at least 1 percent of the emission bandwidth of the fundamental emission of the transmitter may be employed to measure the out of band Emissions.
Test Instruments:	Refer to section 6.0 for details
Test mode:	Refer to section 6.1 for details
Test results:	Pass

Test plot as follows:

QPSK mode:

Test Mode: LTE Band 4 Channel Bandwidth: 1.4MHz

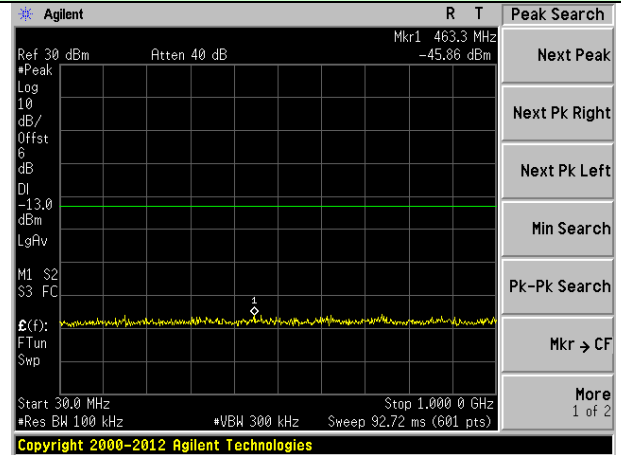
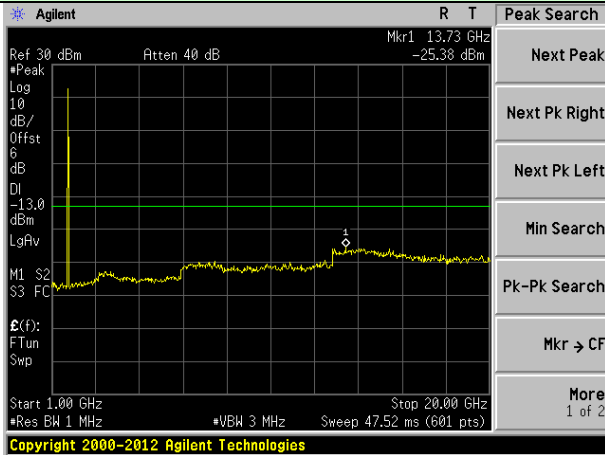

Lowest channel

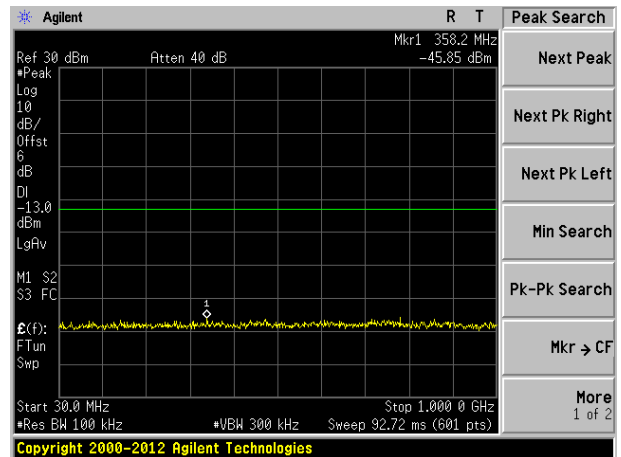
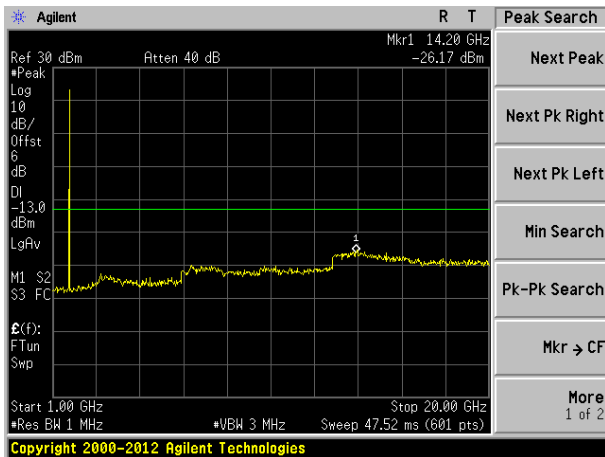

Middle channel

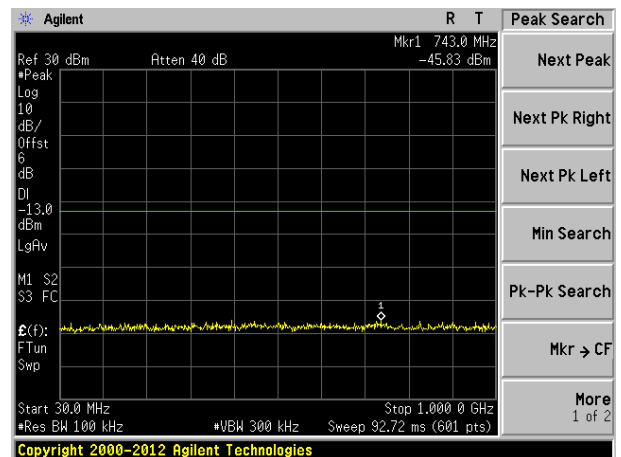
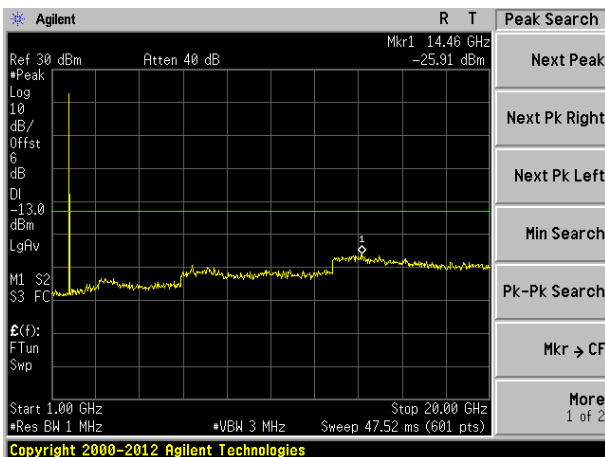

Highest channel

Test Mode: LTE Band 4 Channel Bandwidth: 3MHz

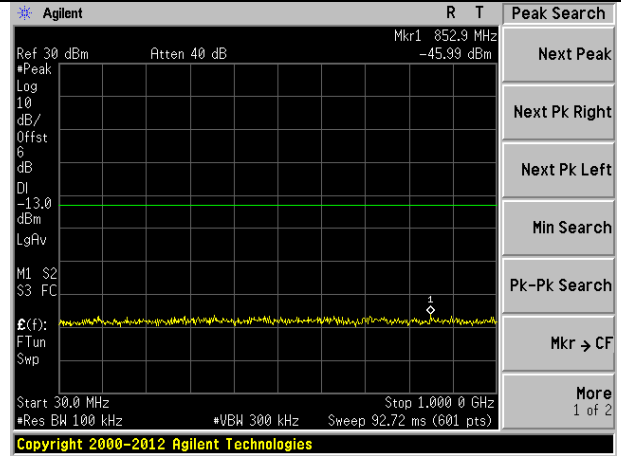
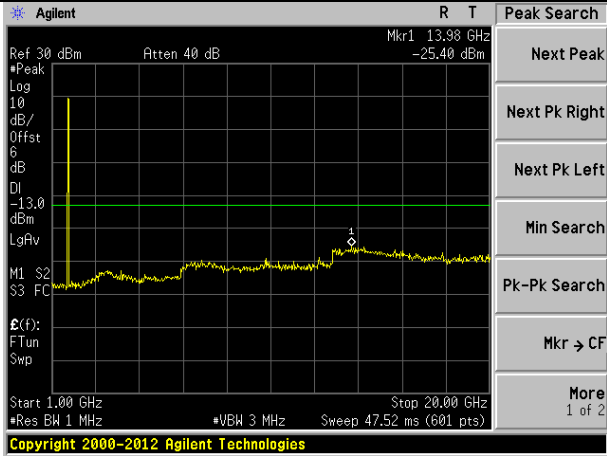

Lowest channel

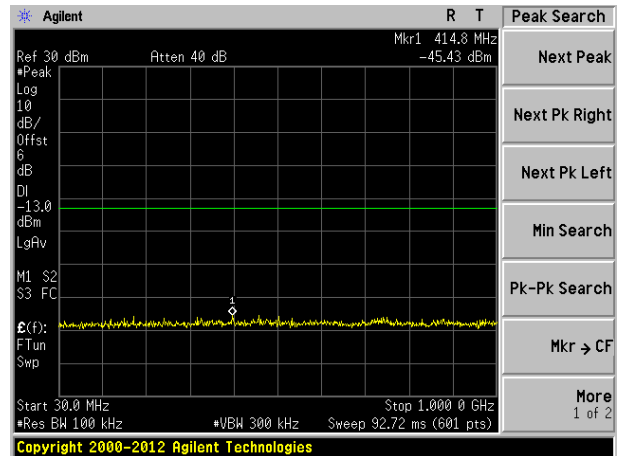
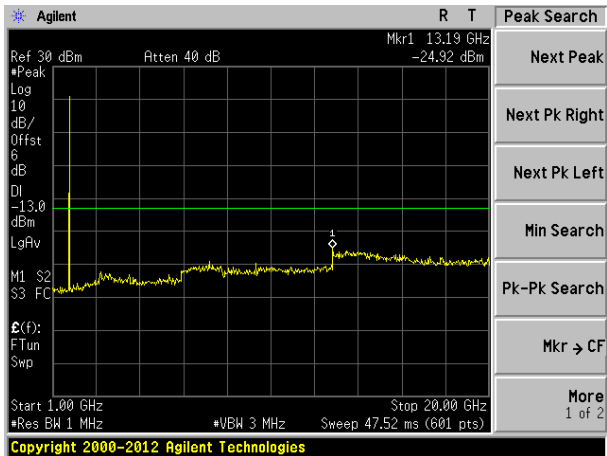

Middle channel

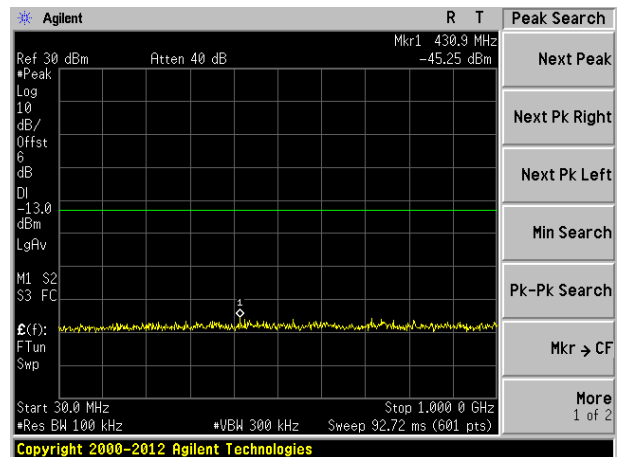
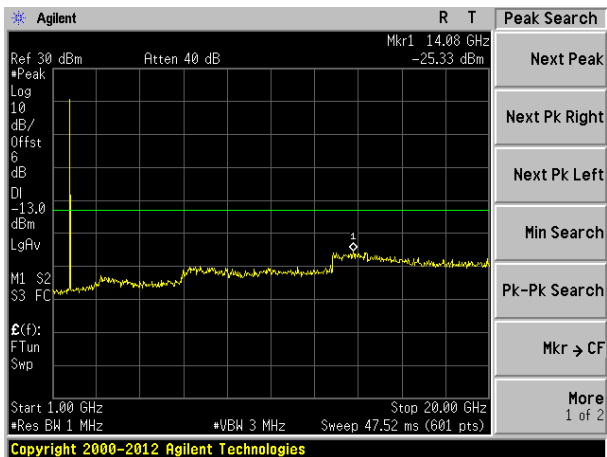

Highest channel

Test Mode: LTE Band 4 Channel Bandwidth: 5MHz

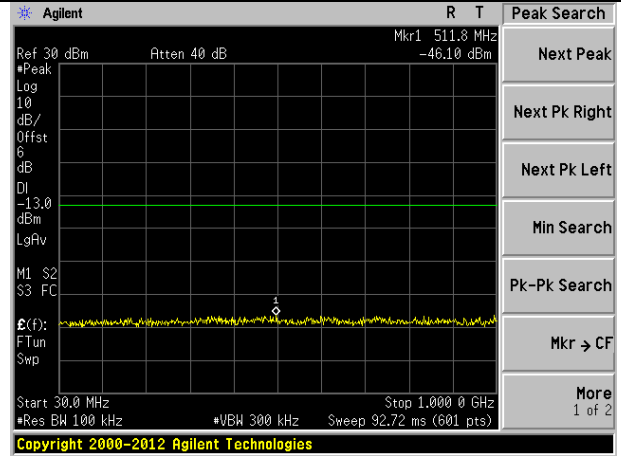
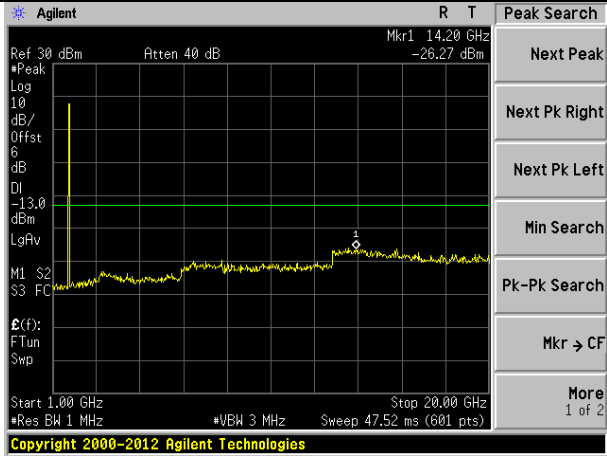

Lowest channel

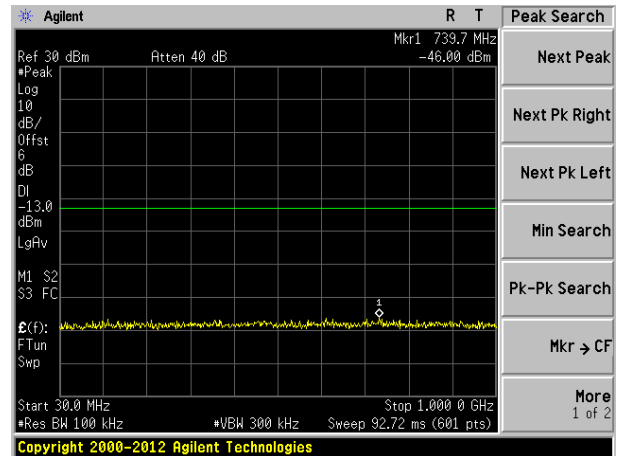
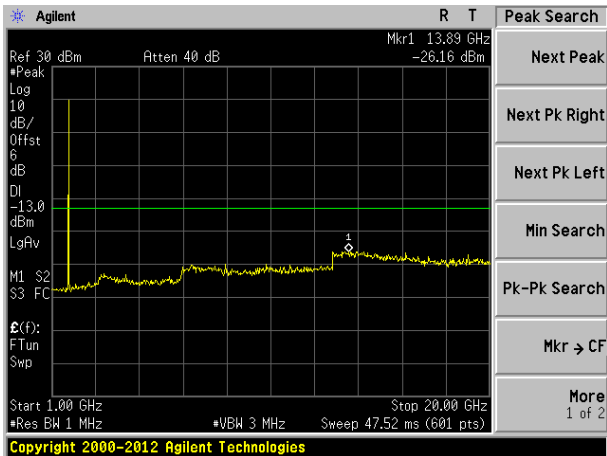

Middle channel

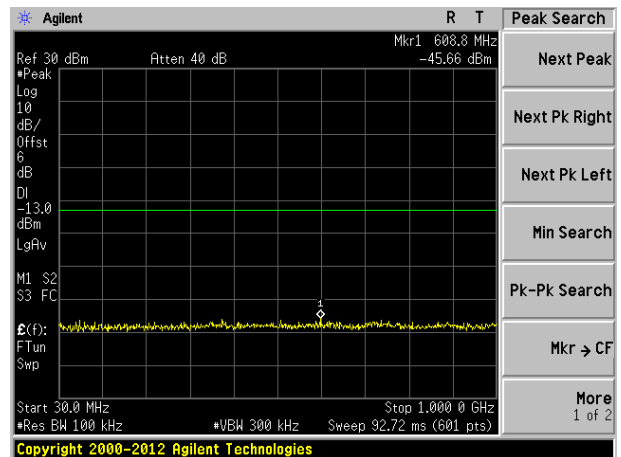
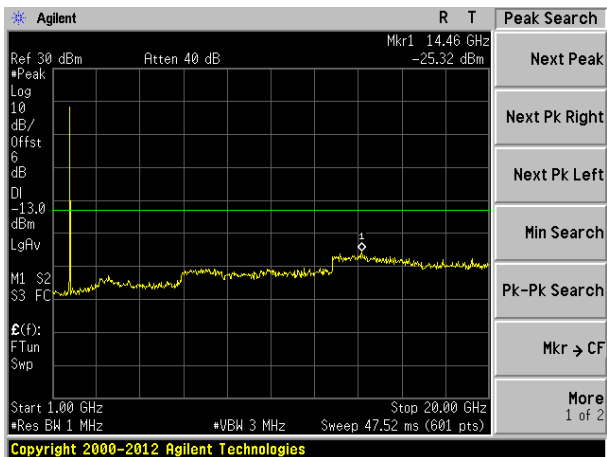

Highest channel

Test Mode: LTE Band 4 Channel Bandwidth: 10MHz

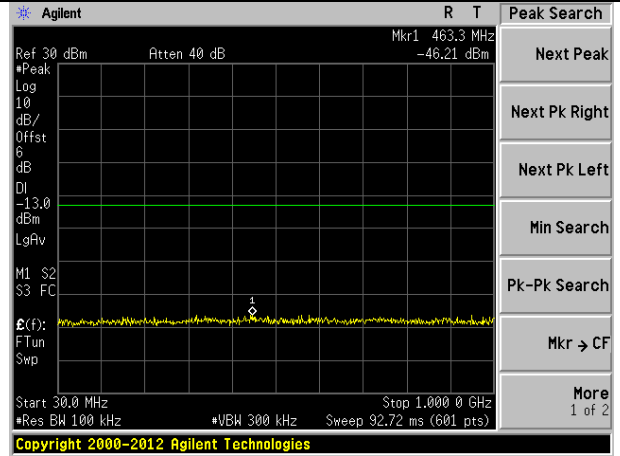
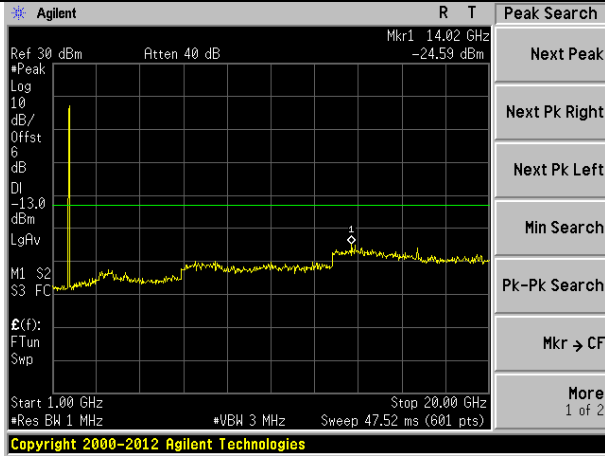

Lowest channel

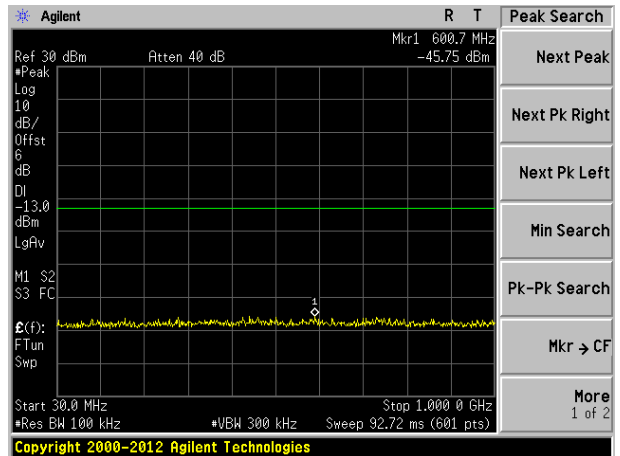
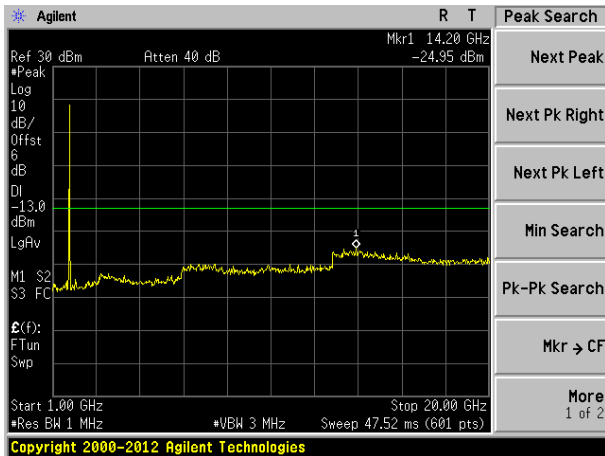

Middle channel

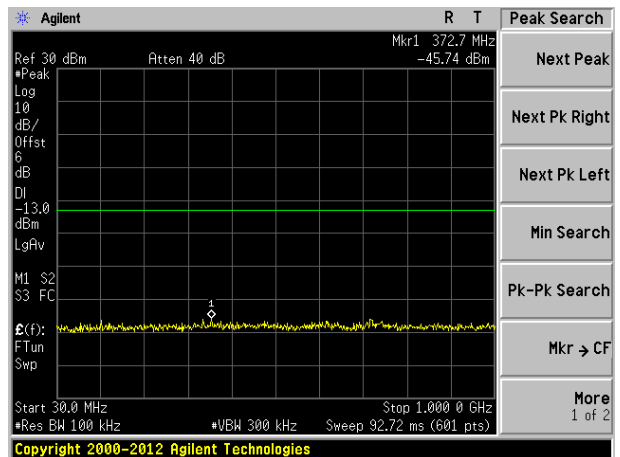
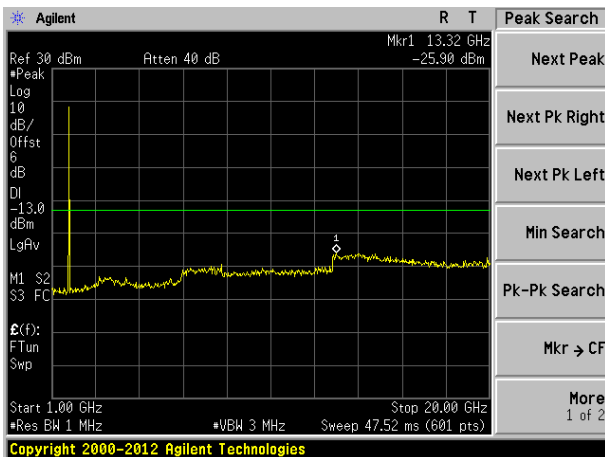

Highest channel

Test Mode: LTE Band 4 Channel Bandwidth: 15MHz

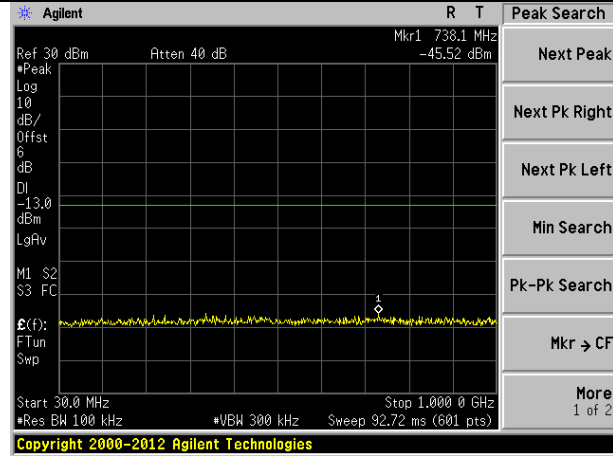
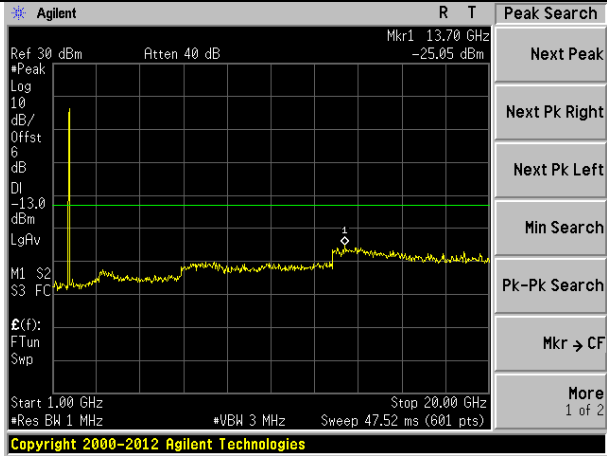

Lowest channel

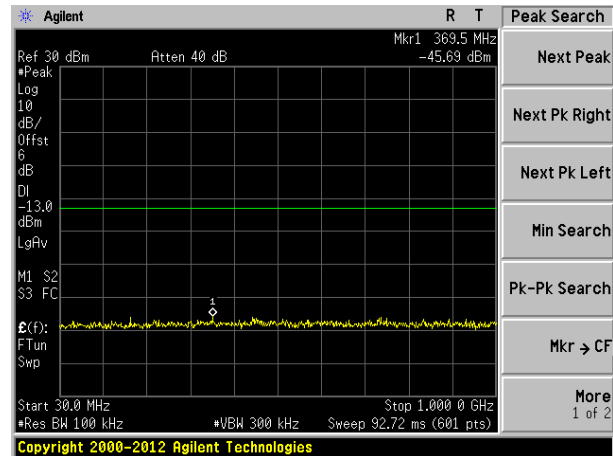
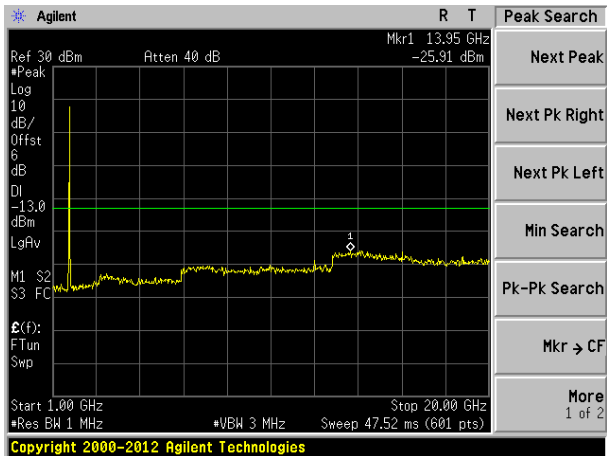

Middle channel

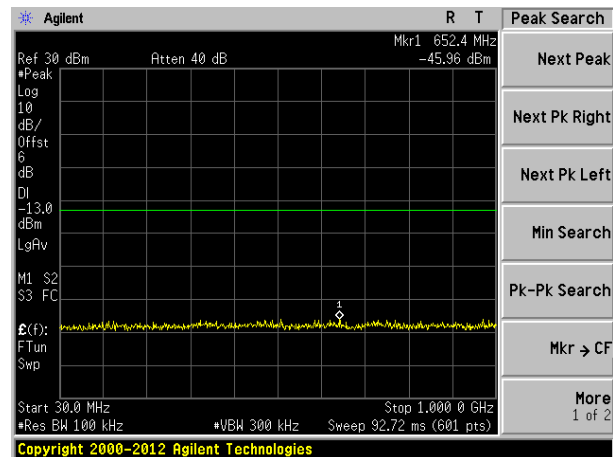
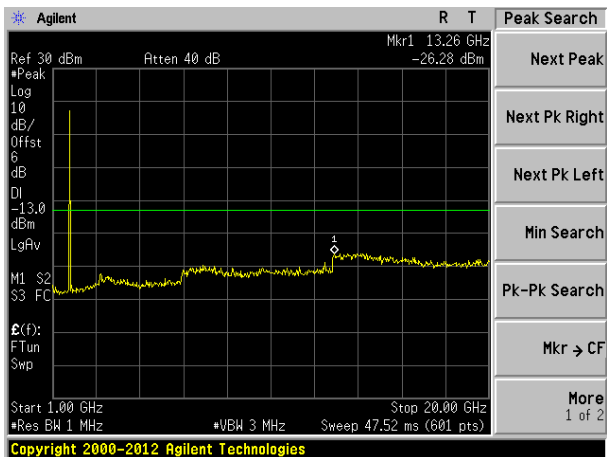

Highest channel

Test Mode: LTE Band 4 Channel Bandwidth: 20MHz

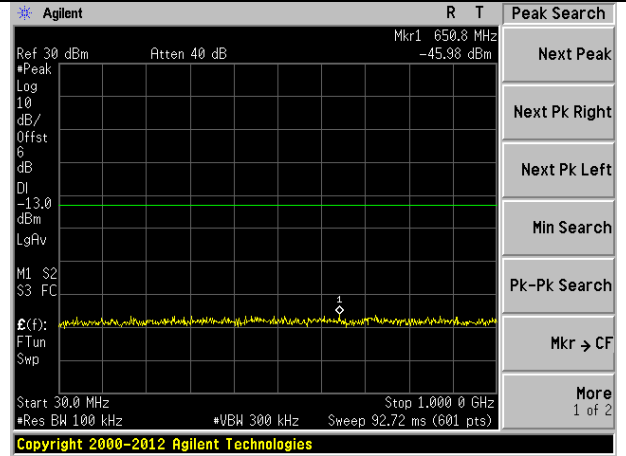
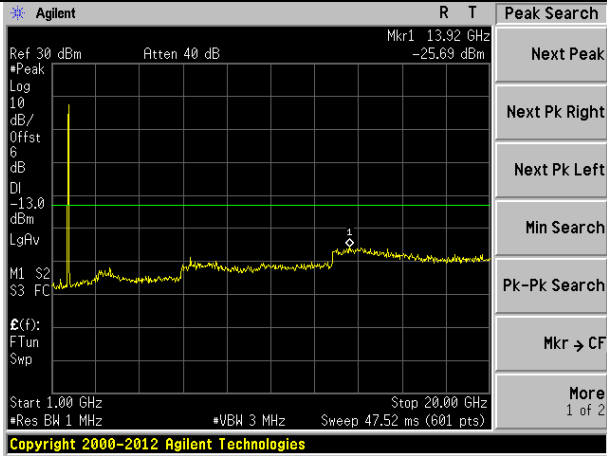

Lowest channel

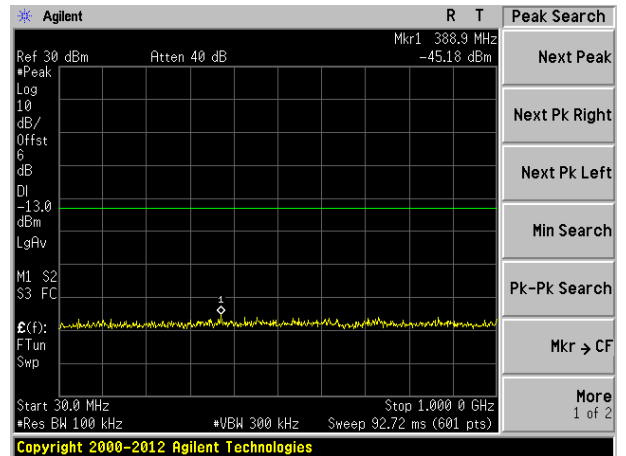
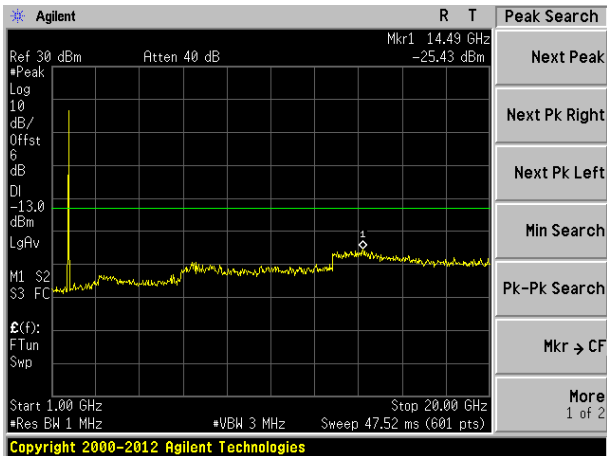

Middle channel

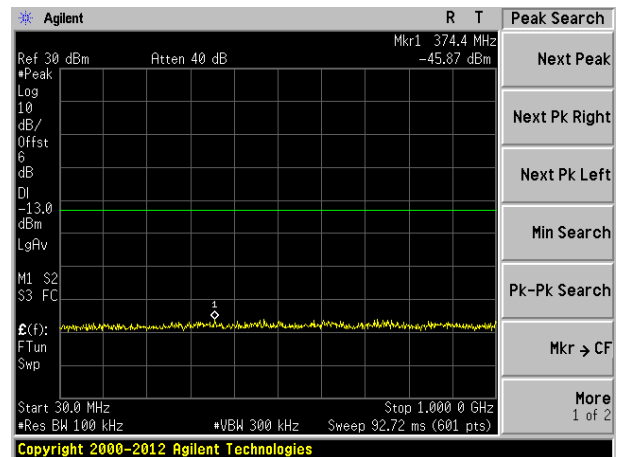
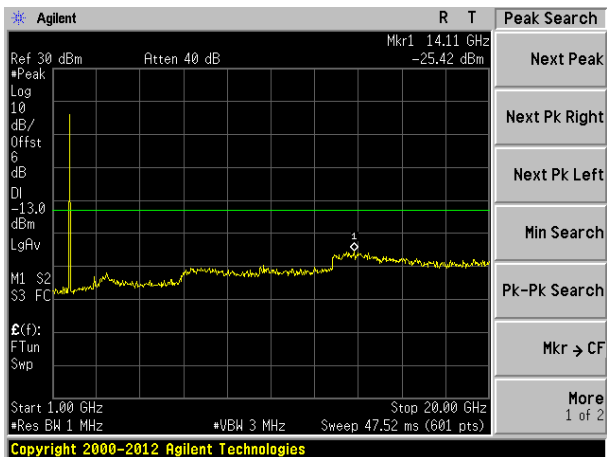

Highest channel

Test Mode: LTE Band 13

Channel Bandwidth: 5MHz

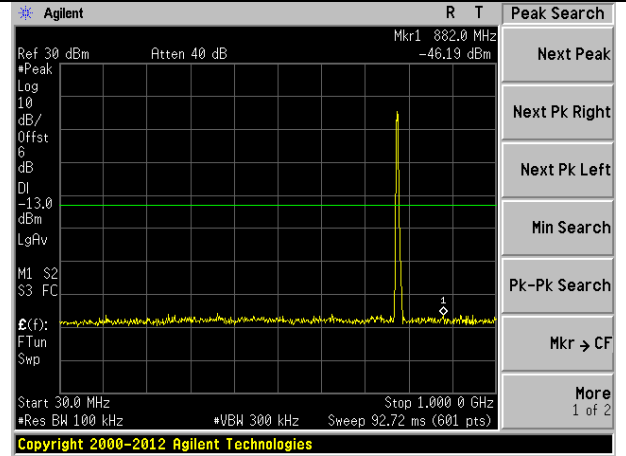
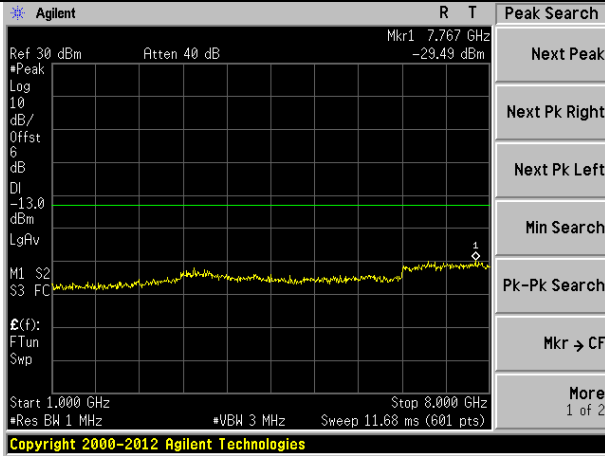

Lowest channel

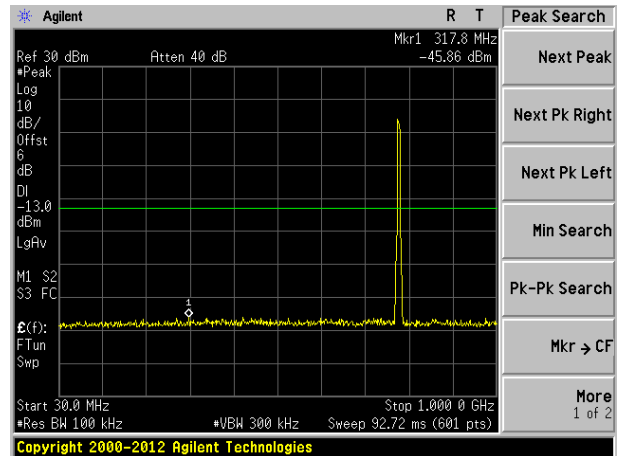
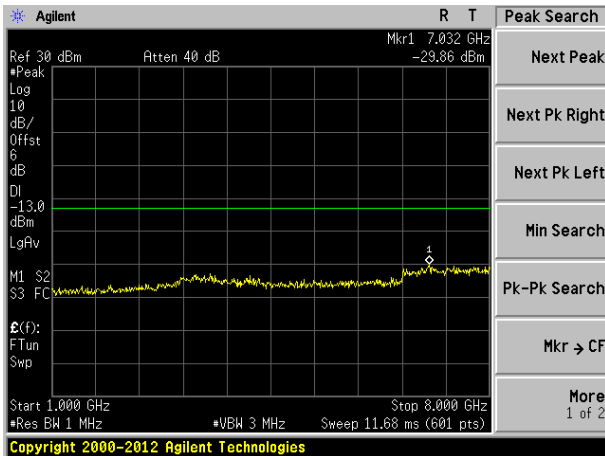

Middle channel

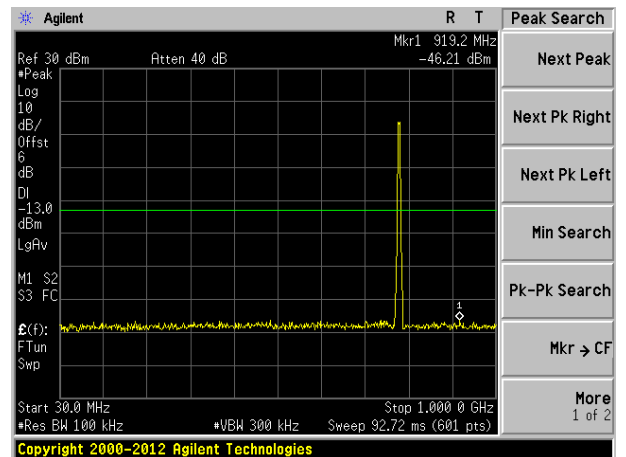
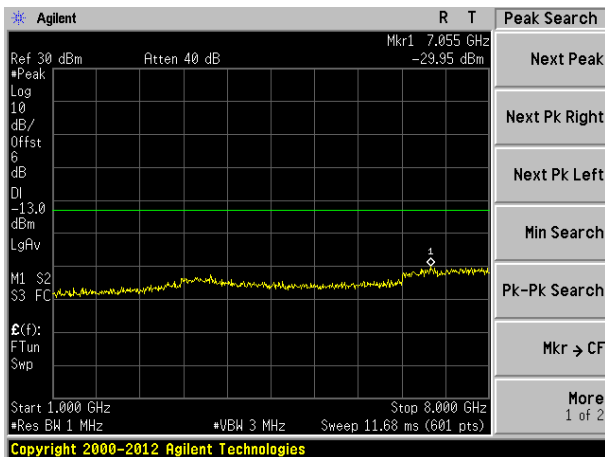

Highest channel

Test Mode: LTE Band 13 Channel Bandwidth: 10MHz

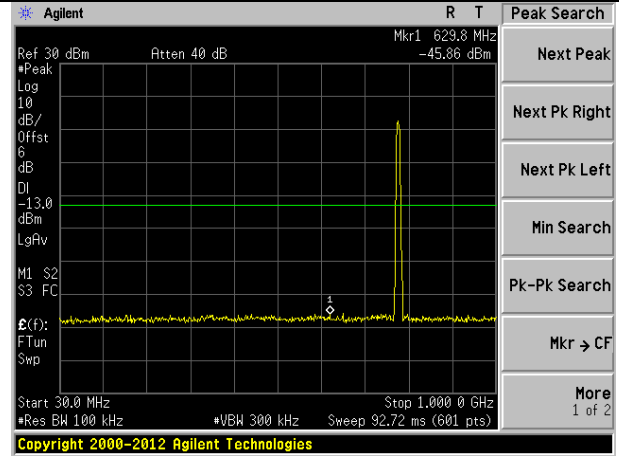
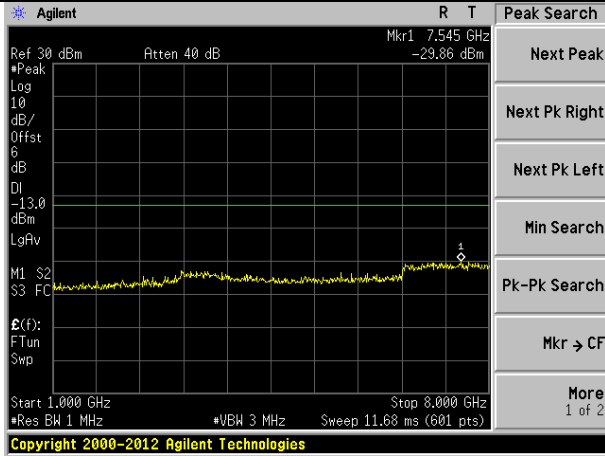

Middle channel

16QAM mode:

Test Mode: LTE Band 4 Channel Bandwidth: 1.4MHz

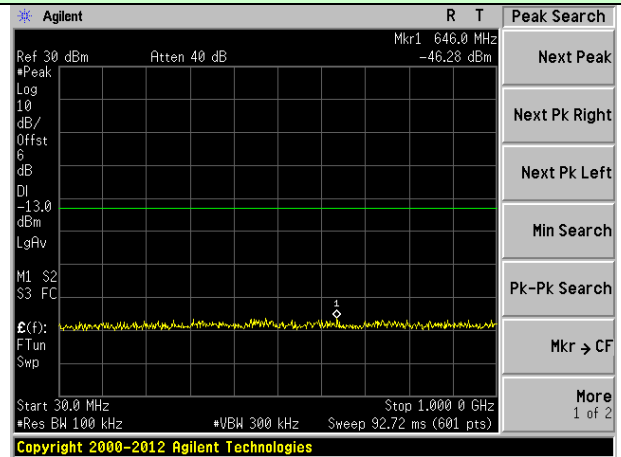
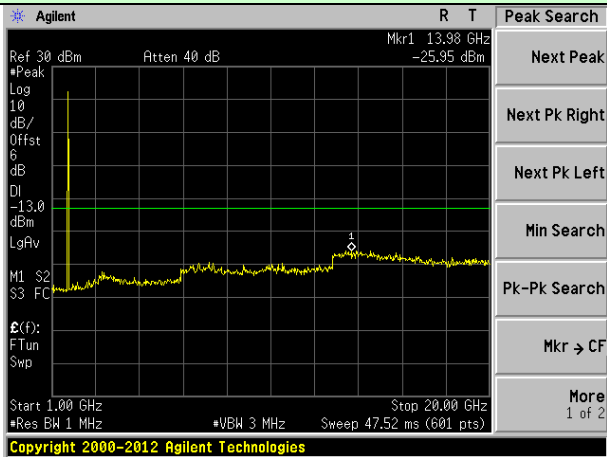

Lowest channel

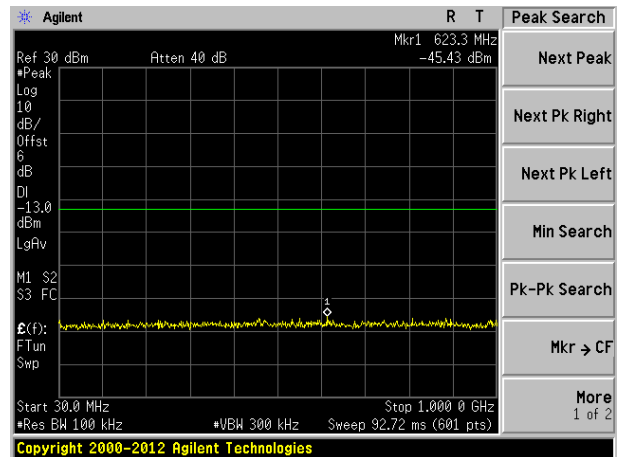
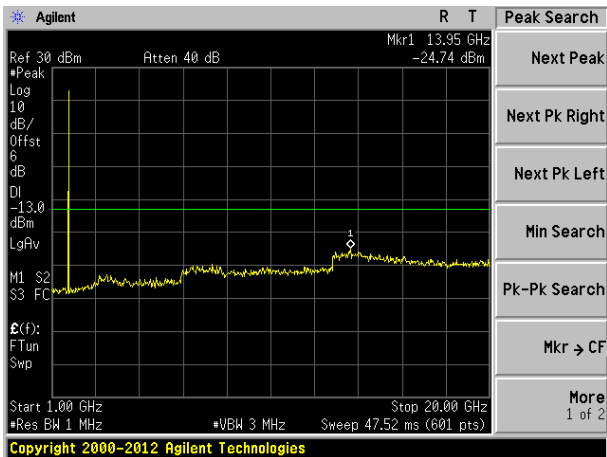

Middle channel

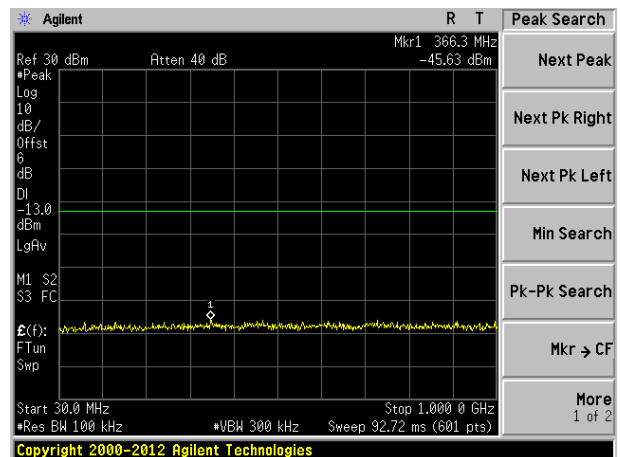
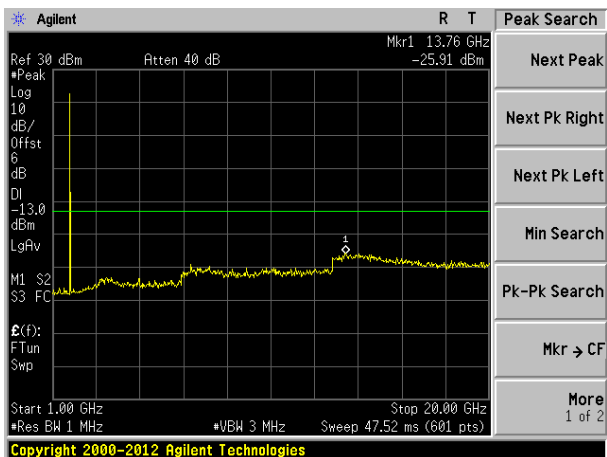

Highest channel

Test Mode: LTE Band 4 Channel Bandwidth: 3MHz

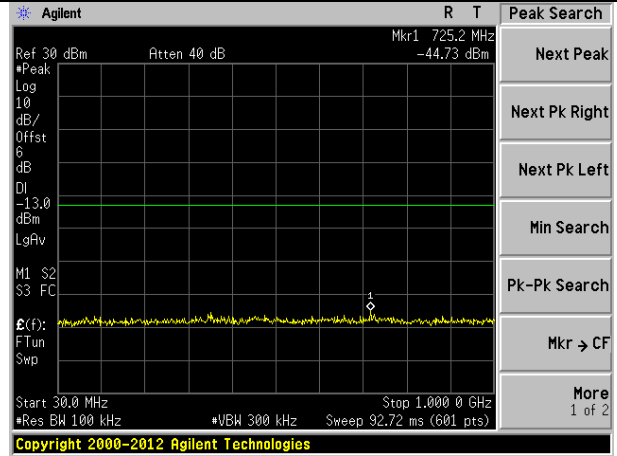
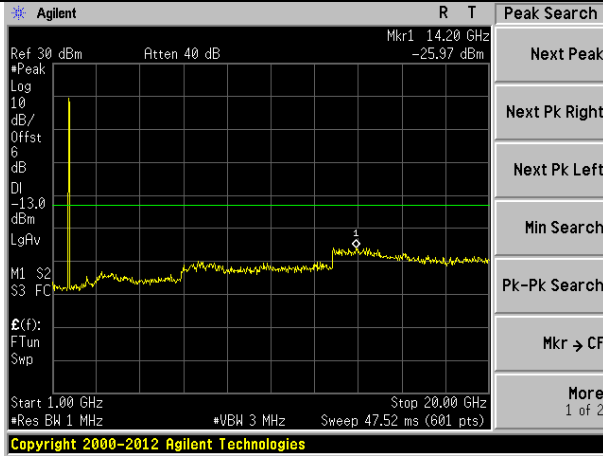

Lowest channel

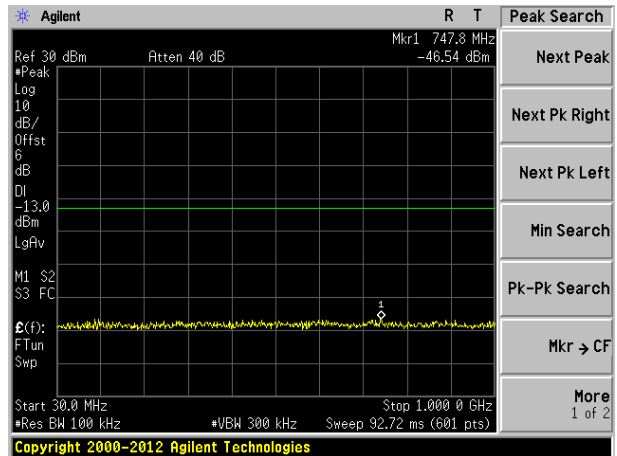
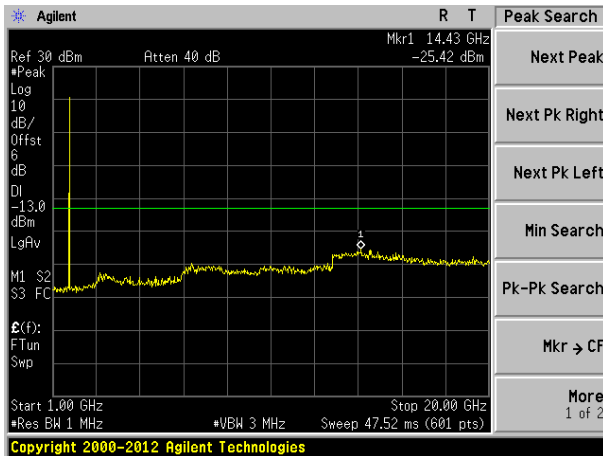

Middle channel

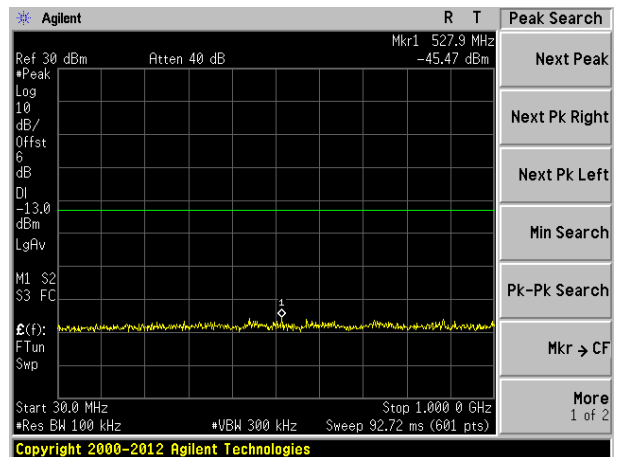
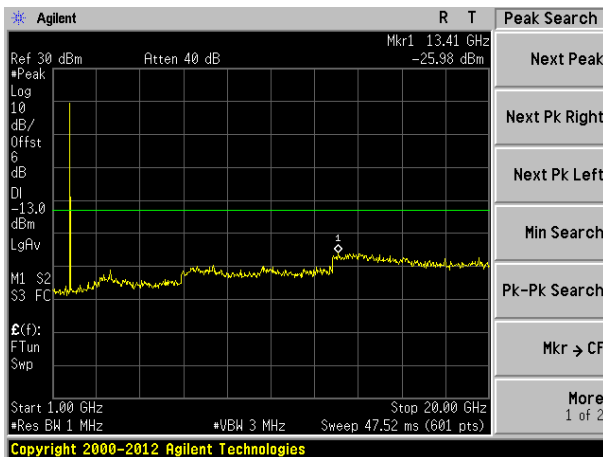

Highest channel

Test Mode: LTE Band 4 Channel Bandwidth: 5MHz

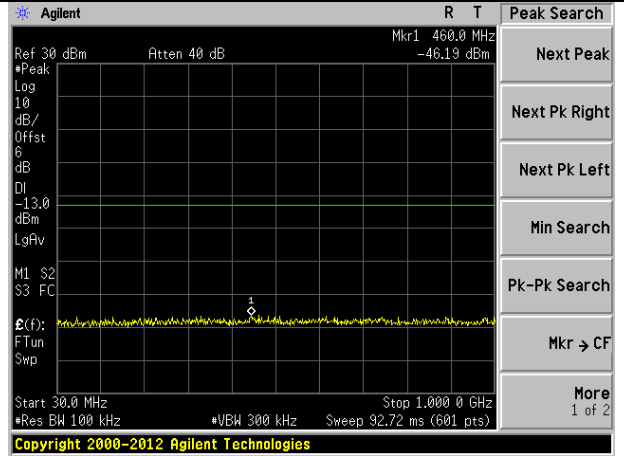
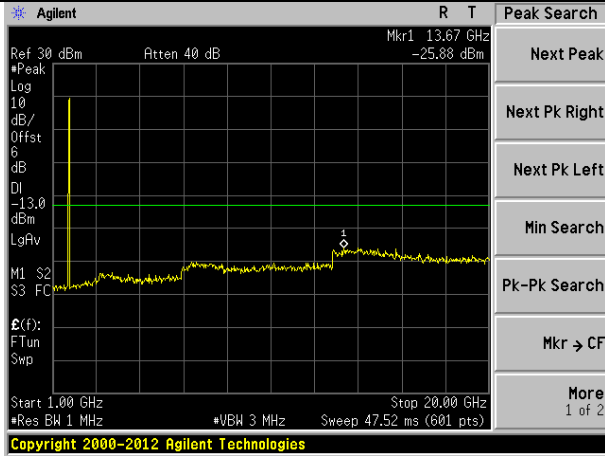

Lowest channel

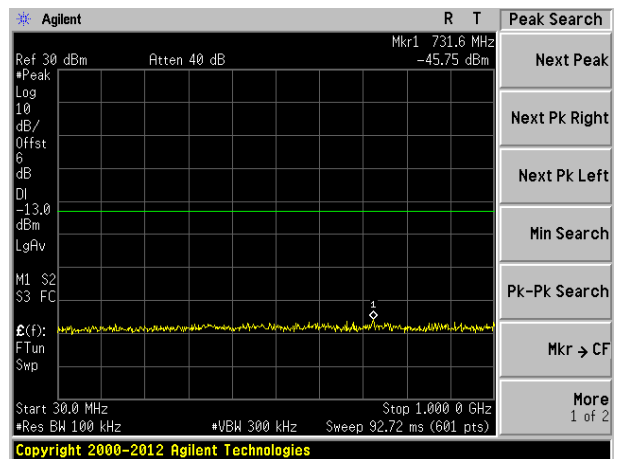
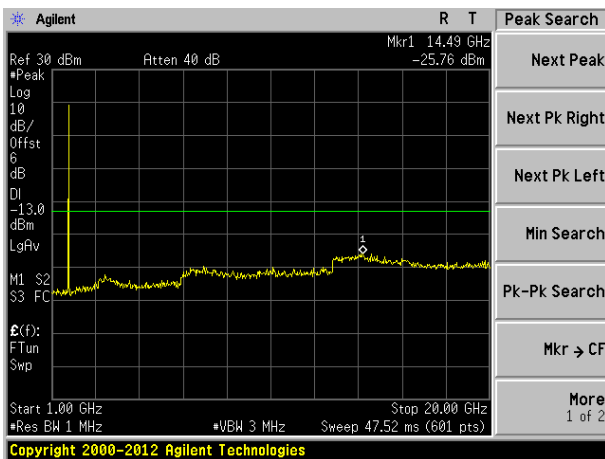

Middle channel

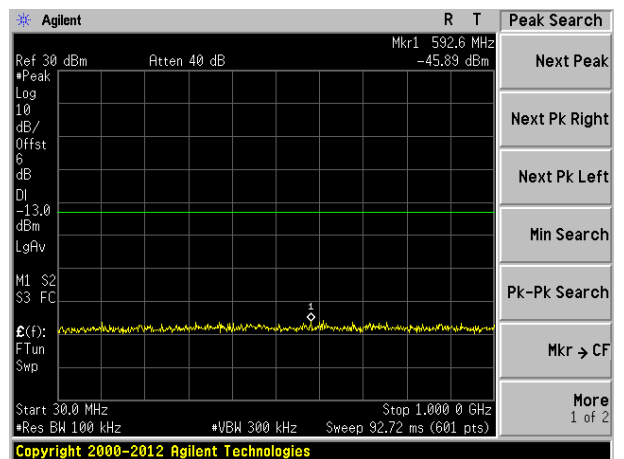
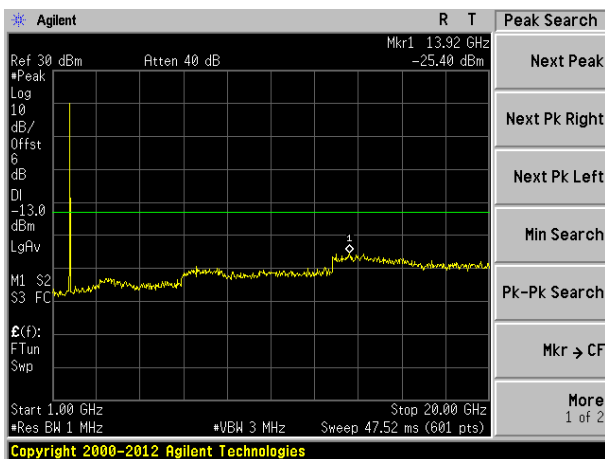

Highest channel

Test Mode: LTE Band 13 Channel Bandwidth: 5MHz

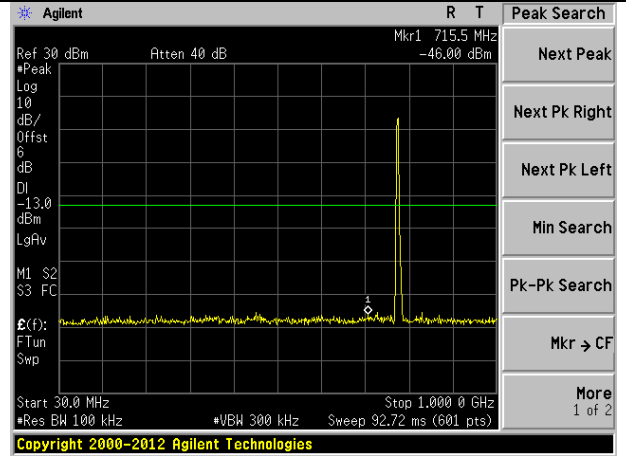
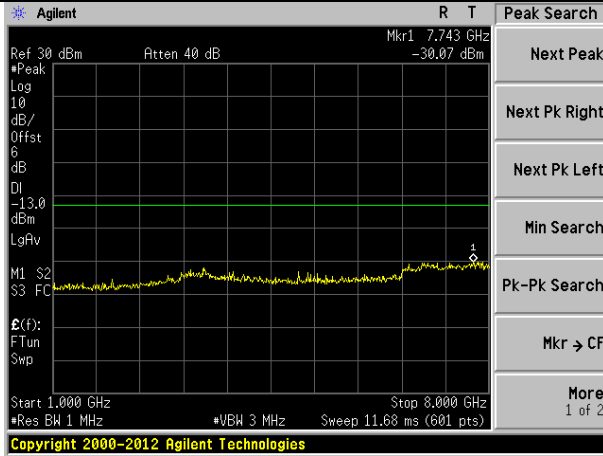

Lowest channel

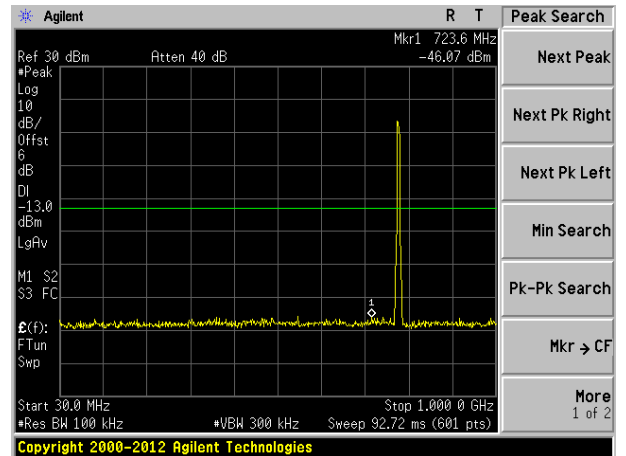
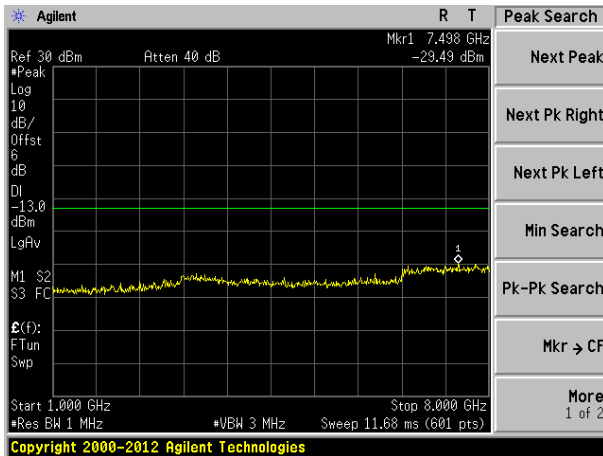

Middle channel

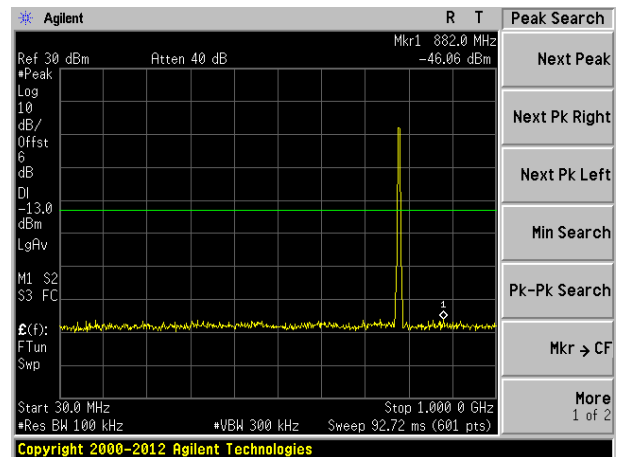
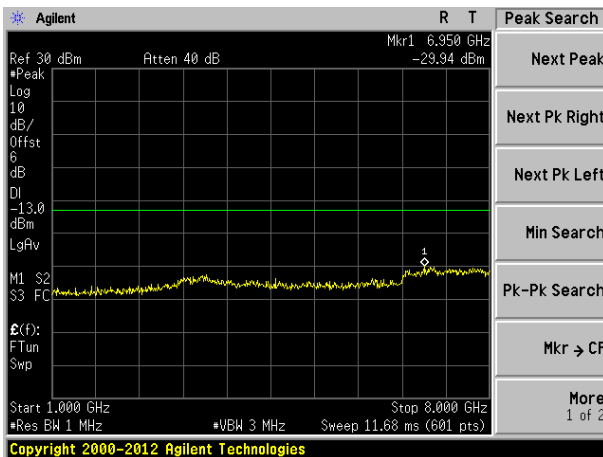

Highest channel

Band Edge:
LTE Band 4(QPSK mode):

1.4MHz Bandwidth (RB size:1# RB offset:0#) 1.4MHz Bandwidth (RB size:1# RB offset:5#)

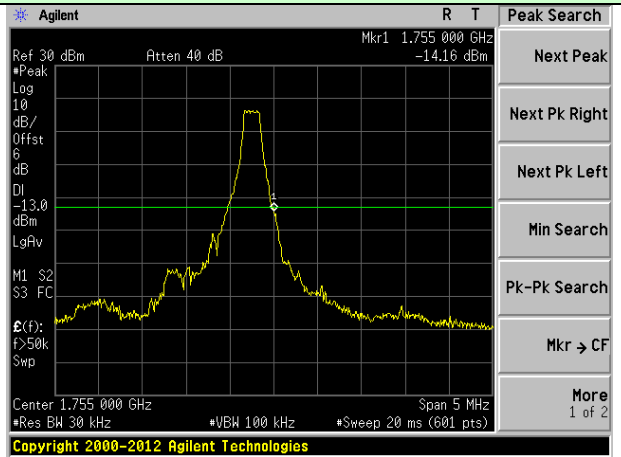
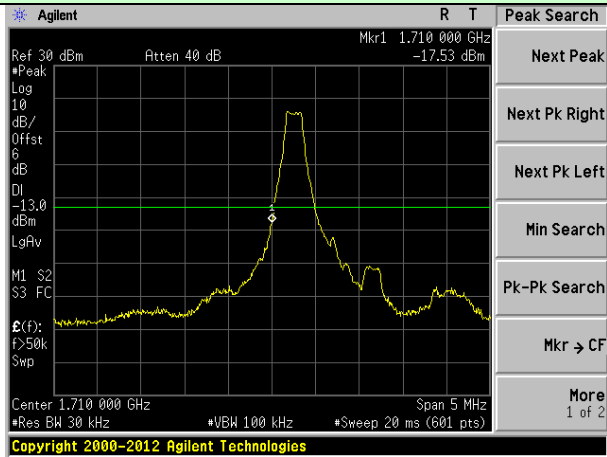

Lowest channel

Highest channel

1.4MHz Bandwidth (RB size:3# RB offset:0#) 1.4MHz Bandwidth (RB size:3# RB offset:2#)

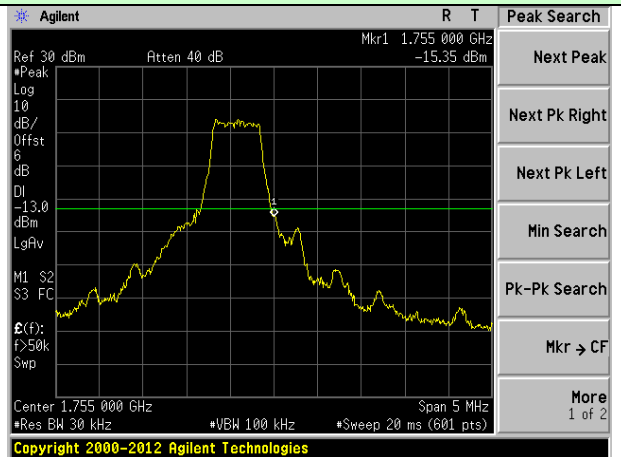
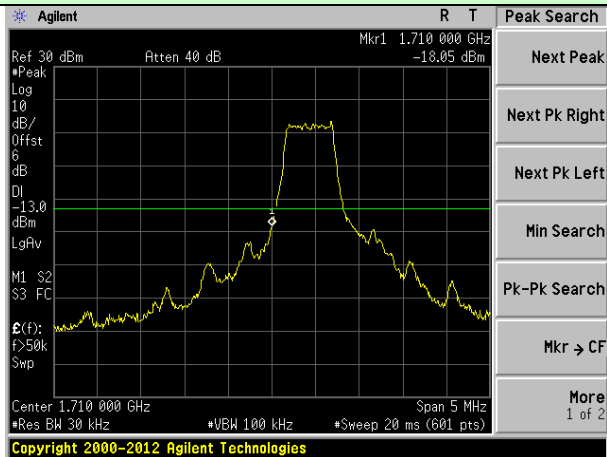

Lowest channel

Highest channel

1.4MHz Bandwidth (RB size:6# RB offset:0#) 1.4MHz Bandwidth (RB size:6# RB offset:0#)

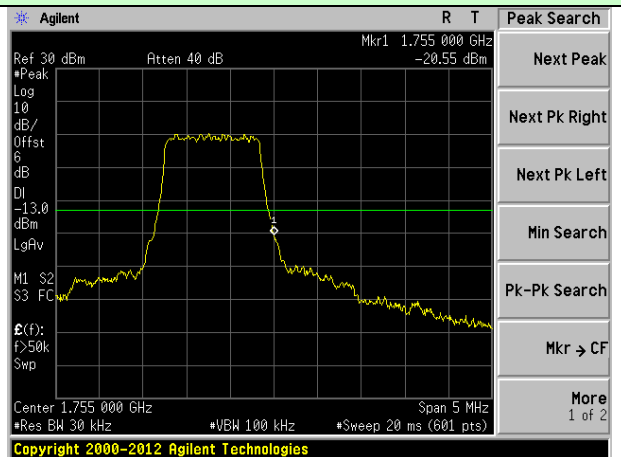
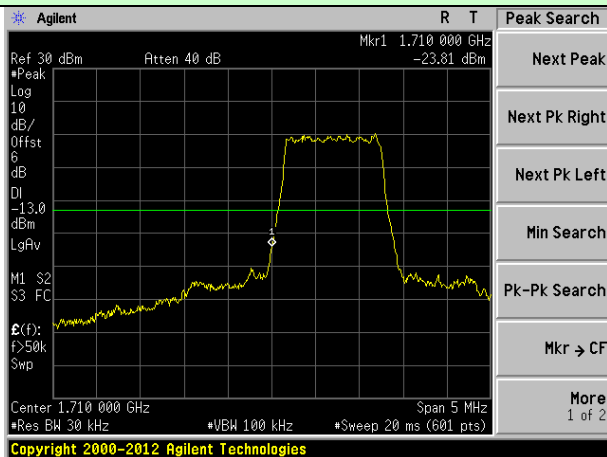

Lowest channel

Highest channel

3MHz Bandwidth (RB size:1# RB offset:0#) **3MHz Bandwidth (RB size:1# RB offset:14#)**

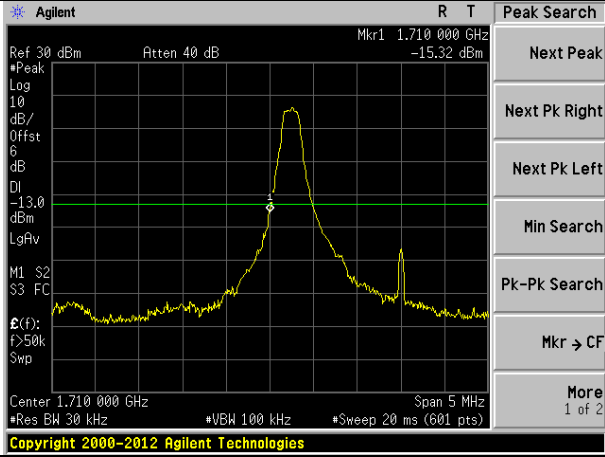

Lowest channel

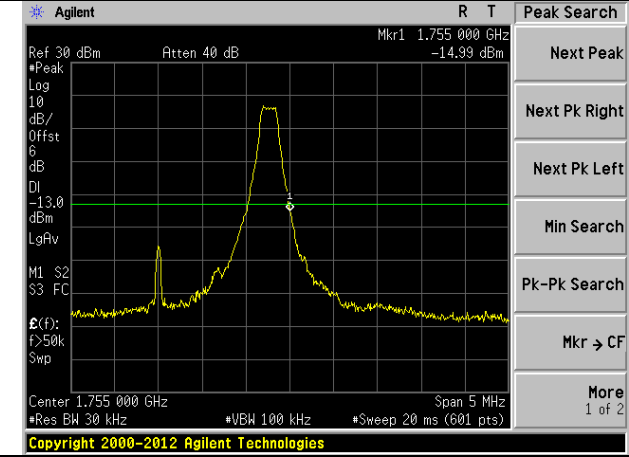

Highest channel

3MHz Bandwidth (RB size:8# RB offset:0#) **3MHz Bandwidth (RB size:8# RB offset:7#)**

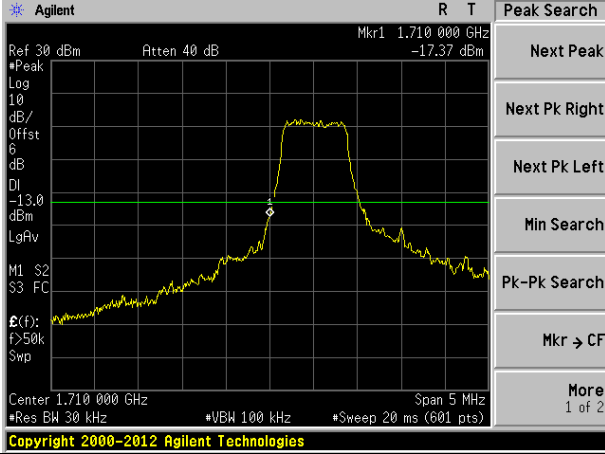

Lowest channel

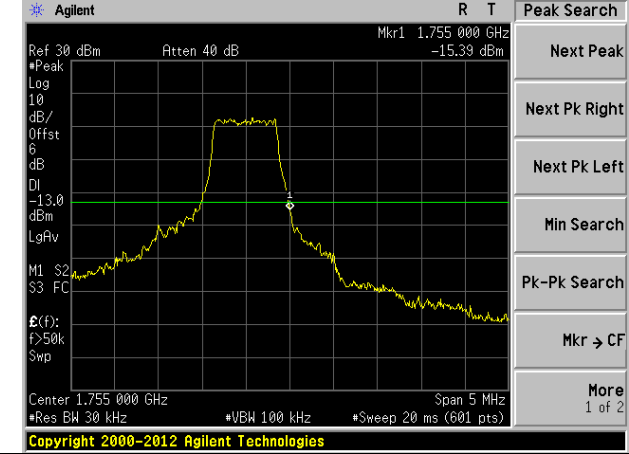

Highest channel

3MHz Bandwidth (RB size:15# RB offset:0#) **3MHz Bandwidth (RB size:15# RB offset:0#)**

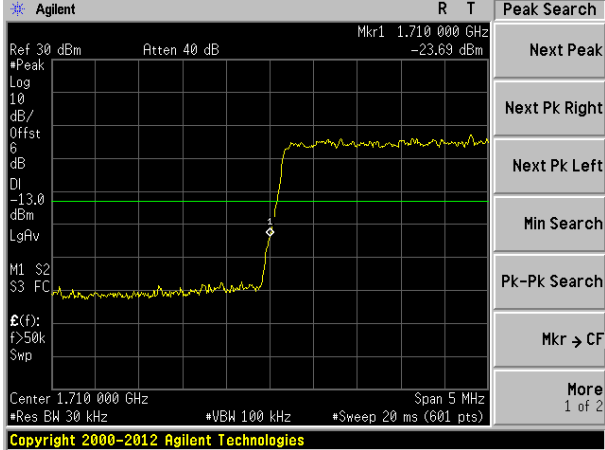

Lowest channel

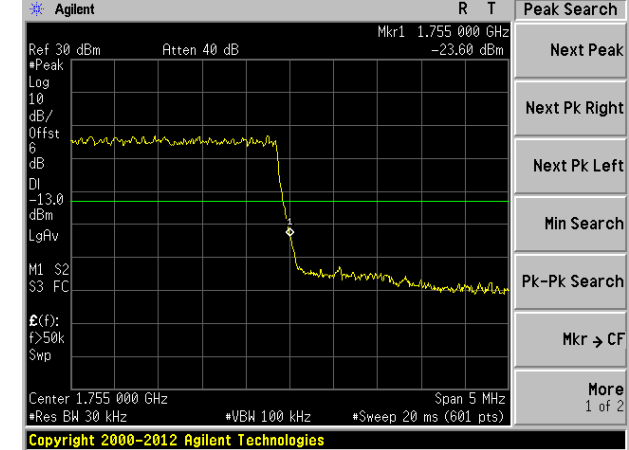

Highest channel

5MHz Bandwidth (RB size:1# RB offset:0#) 5MHz Bandwidth (RB size:1# RB offset:24#)

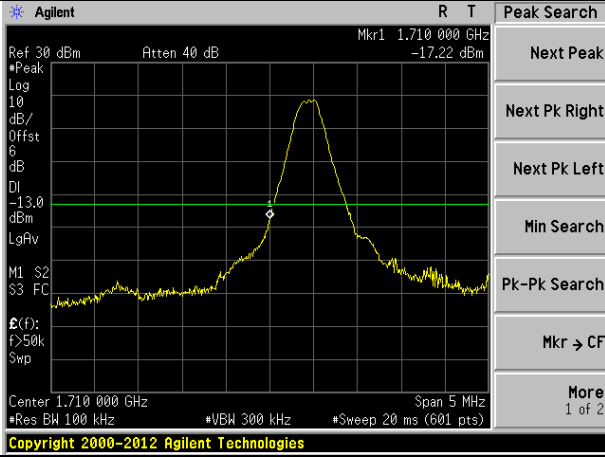

Lowest channel

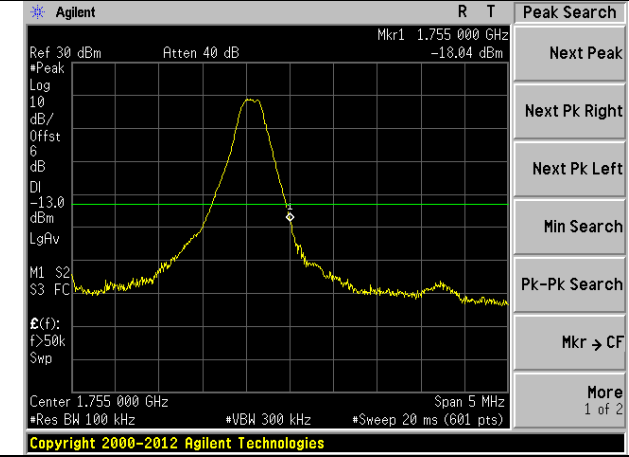

Highest channel

5MHz Bandwidth (RB size:12# RB offset:0#) 5MHz Bandwidth (RB size:12# RB offset:13#)

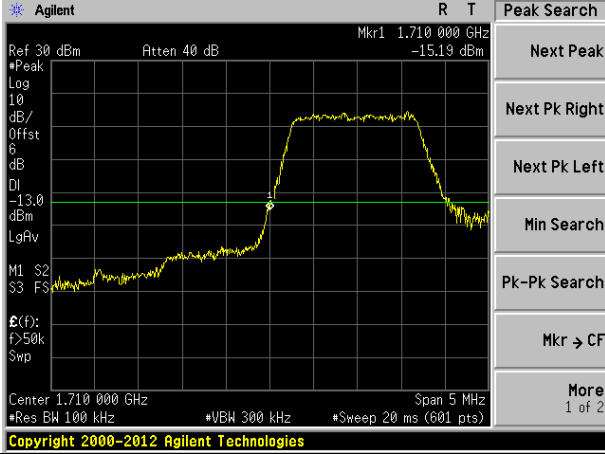

Lowest channel

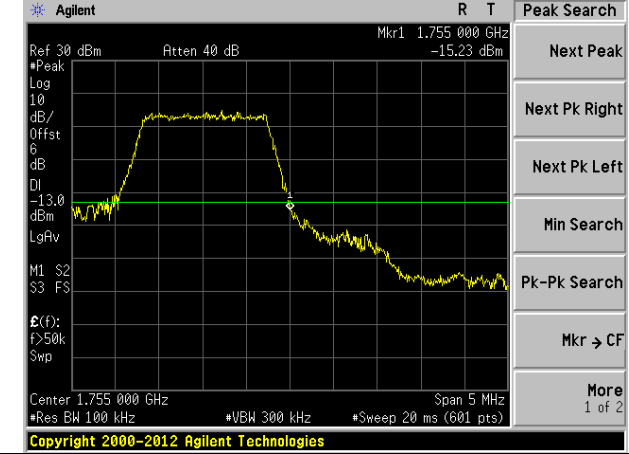

Highest channel

5MHz Bandwidth (RB size:25# RB offset:0#) 5MHz Bandwidth (RB size:25# RB offset:0#)

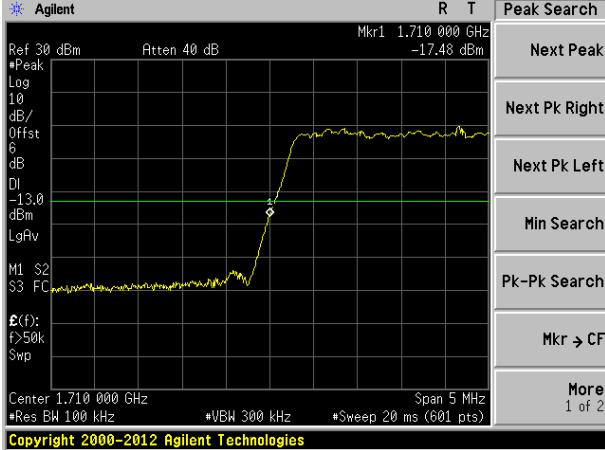

Lowest channel

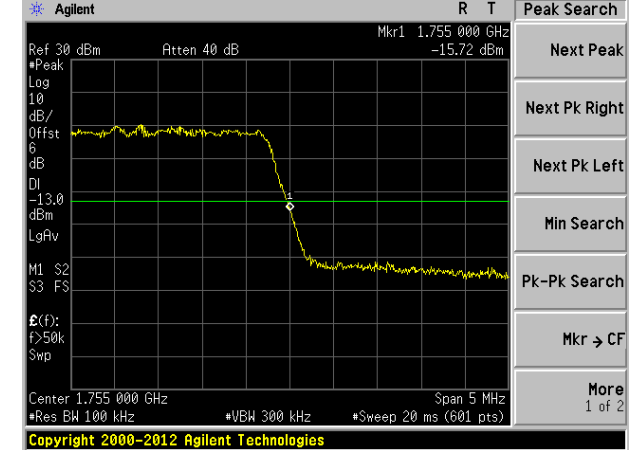

Highest channel

10MHz Bandwidth (RB size:1# RB offset:0#) 10MHz Bandwidth (RB size:1# RB offset:49#)

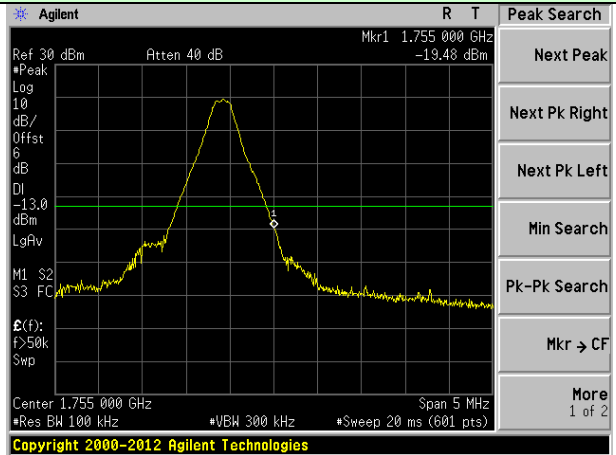
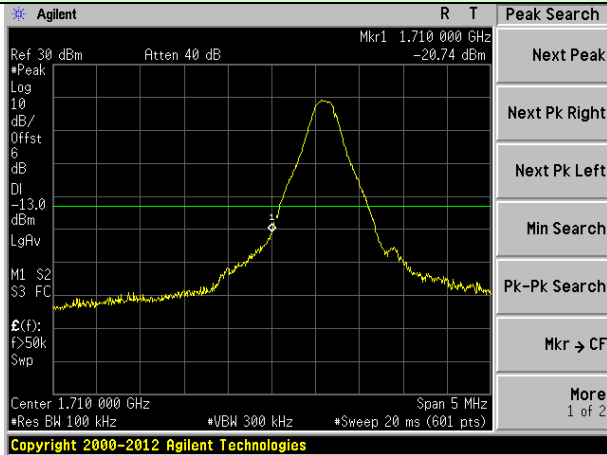

Lowest channel

Highest channel

10MHz Bandwidth (RB size:25# RB offset:0#) 10MHz Bandwidth (RB size:25# RB offset:25#)

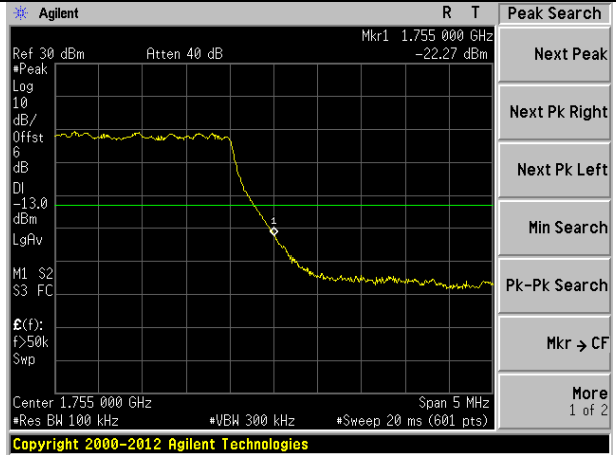
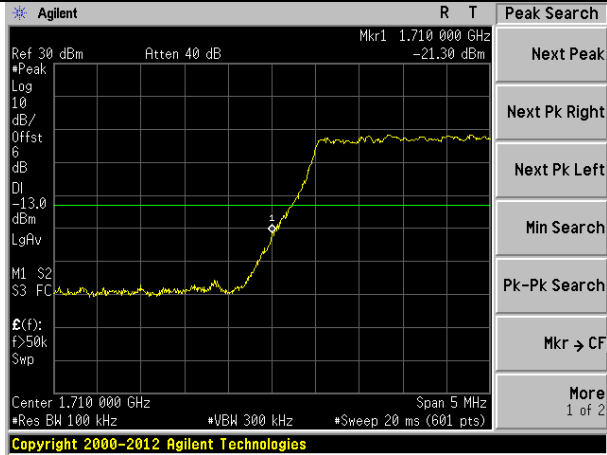

Lowest channel

Highest channel

10MHz Bandwidth (RB size:50# RB offset:0#) 10MHz Bandwidth (RB size:50# RB offset:0#)

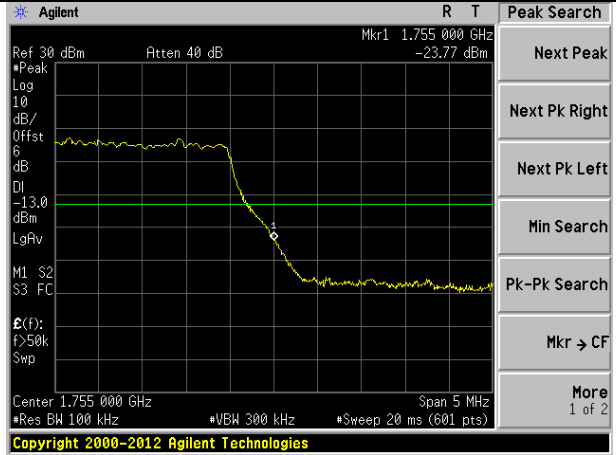
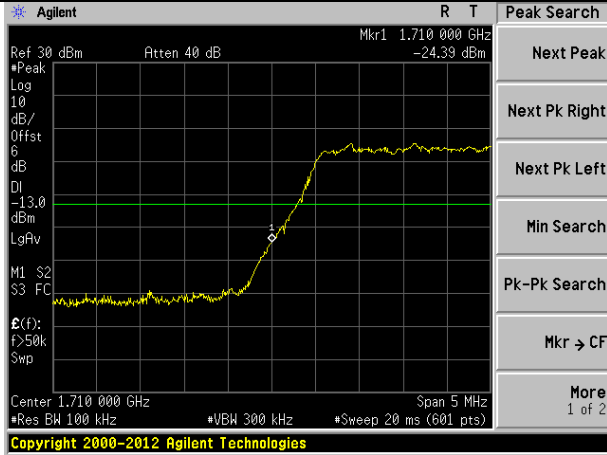

Lowest channel

Highest channel

15MHz Bandwidth (RB size:1# RB offset:0#) 15MHz Bandwidth (RB size:1# RB offset:74#)

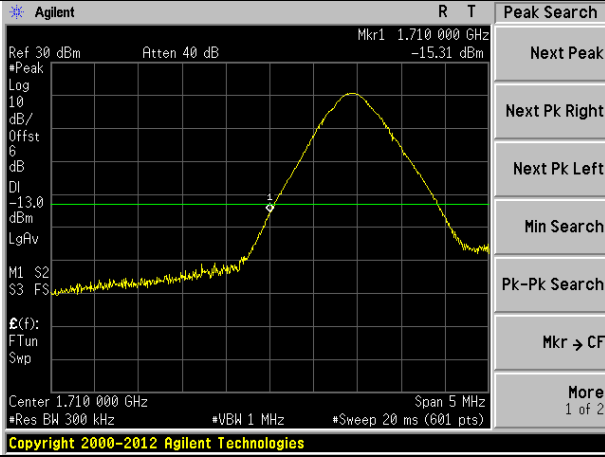

Lowest channel

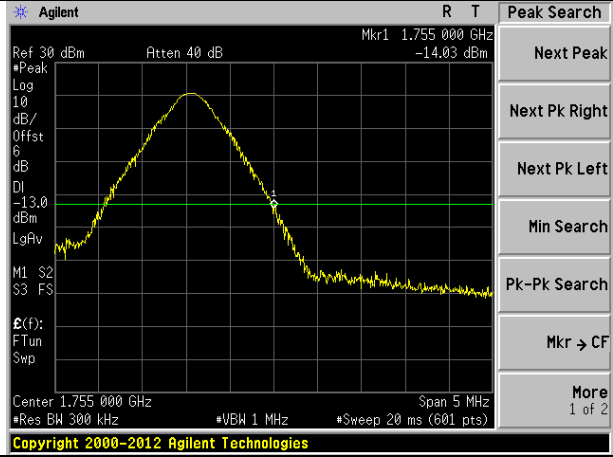

Highest channel

15MHz Bandwidth (RB size:36# RB offset:0#) 15MHz Bandwidth (RB size:36# RB offset:39#)

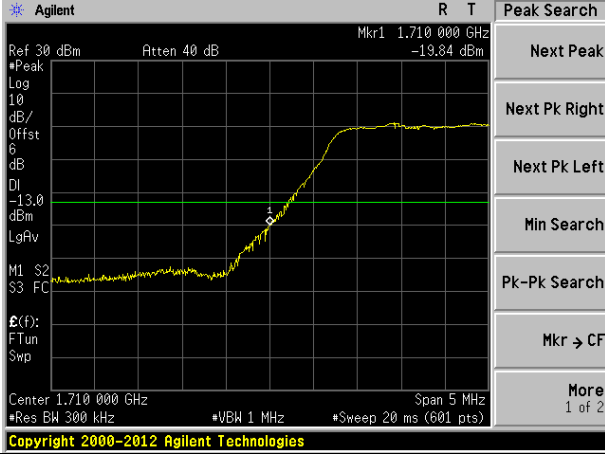

Lowest channel

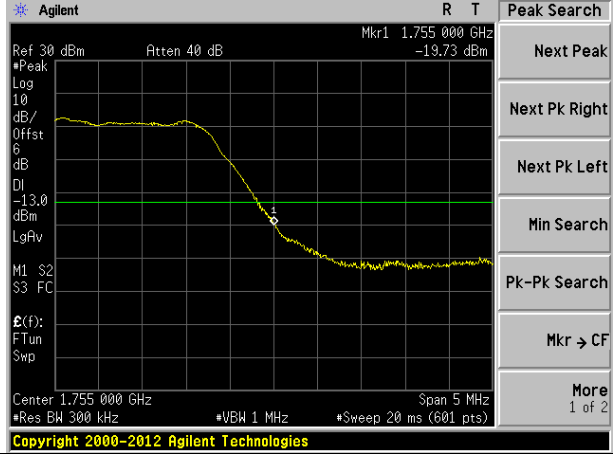

Highest channel

15MHz Bandwidth (RB size:75# RB offset:0#) 15MHz Bandwidth (RB size:75# RB offset:0#)

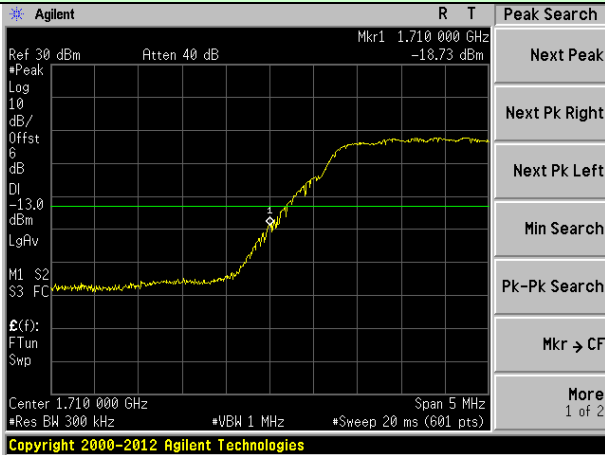

Lowest channel

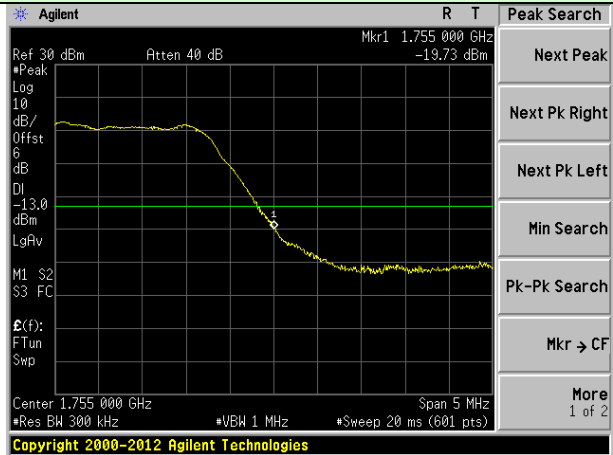

Highest channel

20MHz Bandwidth (RB size:1# RB offset:0#) 20MHz Bandwidth (RB size:1# RB offset:99#)

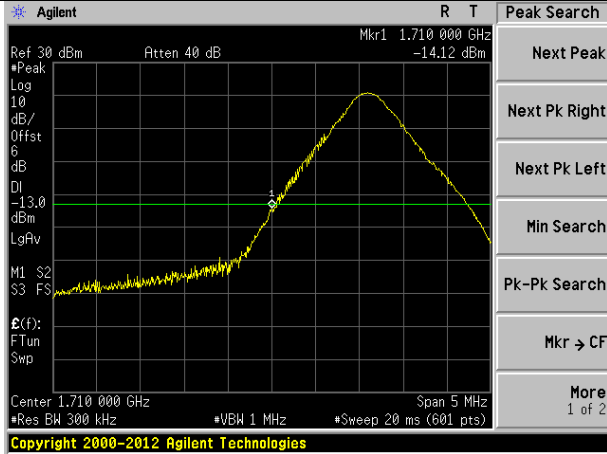

Lowest channel

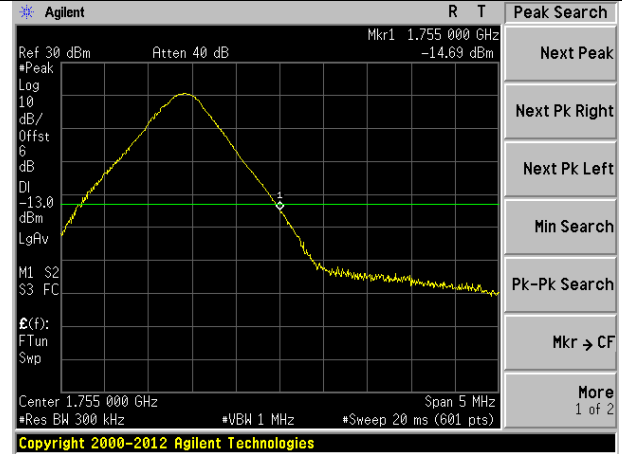

Highest channel

20MHz Bandwidth (RB size:50# RB offset:0#) 20MHz Bandwidth (RB size:50# RB offset:50#)

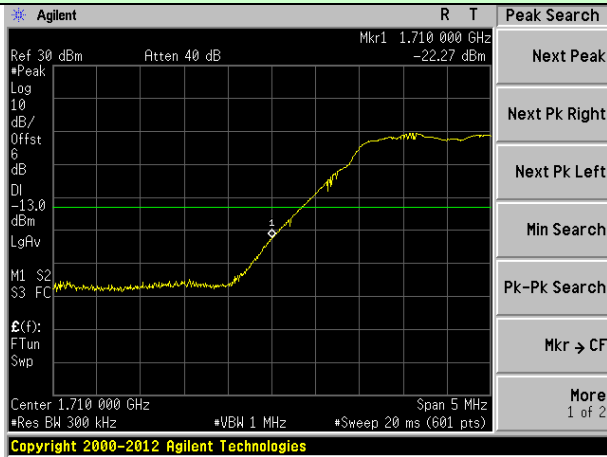

Lowest channel

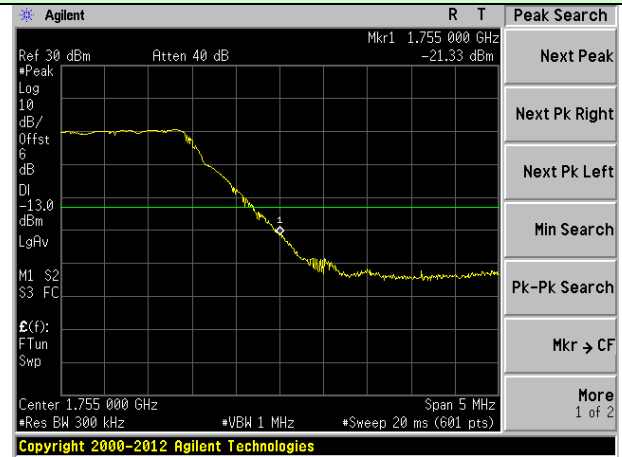

Highest channel

20MHz Bandwidth (RB size:100# RB offset:0#) 20MHz Bandwidth (RB size:100# RB offset:0#)

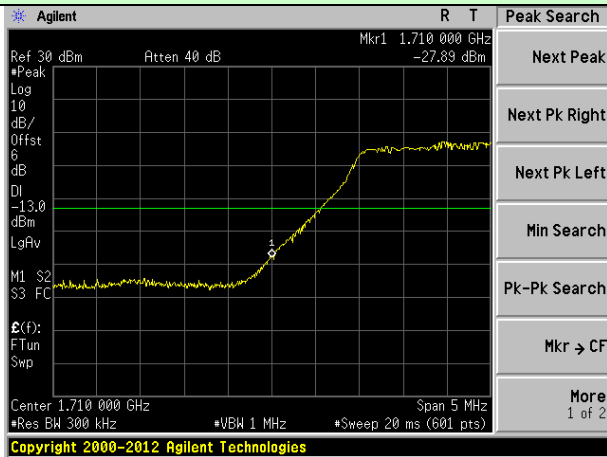

Lowest channel



Highest channel

LTE Band 13(QPSK mode):

5MHz Bandwidth (RB size:1# RB offset:0#) 5MHz Bandwidth (RB size:1# RB offset:24#)

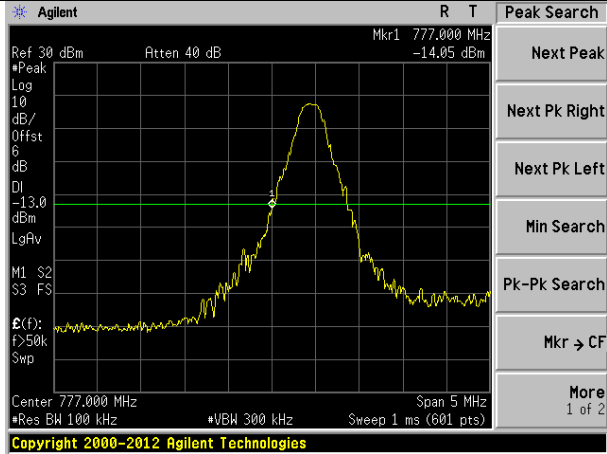

Lowest channel

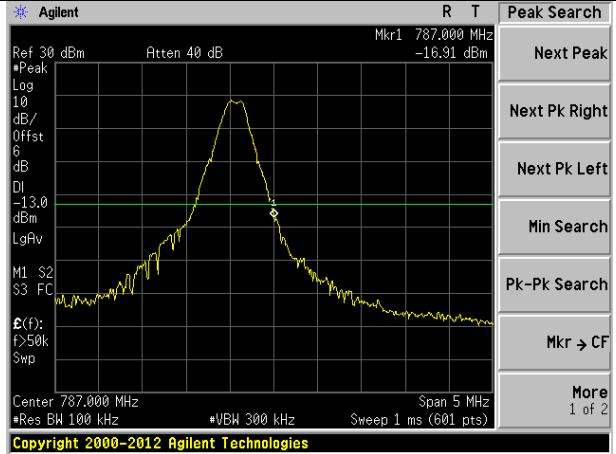

Highest channel

5MHz Bandwidth (RB size:12# RB offset:0#) 5MHz Bandwidth (RB size:12# RB offset:13#)

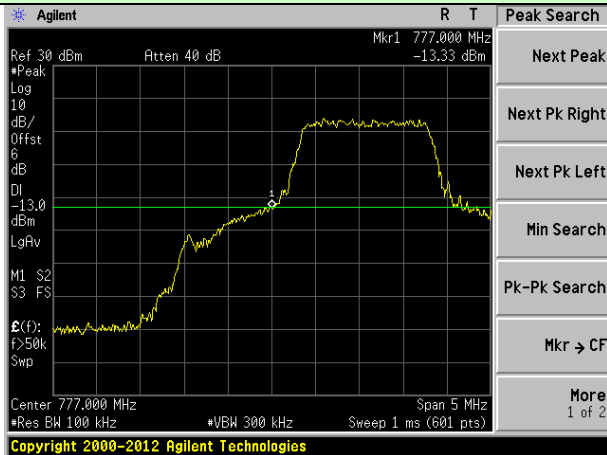

Lowest channel

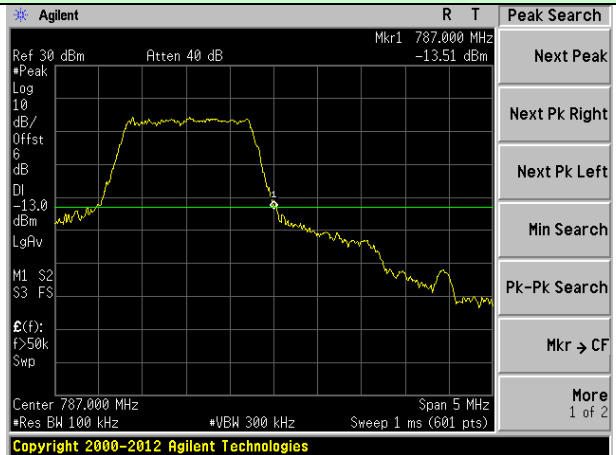

Highest channel

5MHz Bandwidth (RB size:25# RB offset:0#) 5MHz Bandwidth (RB size:25# RB offset:0#)

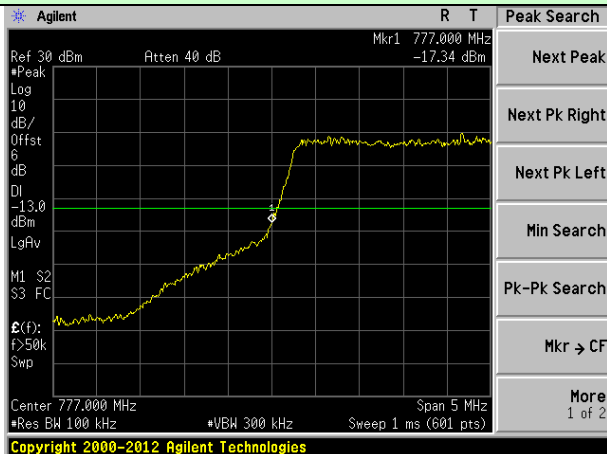

Lowest channel

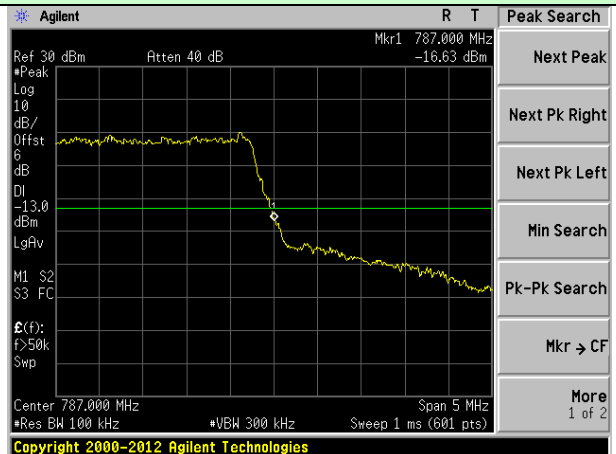

Highest channel

10MHz Bandwidth (RB size:1# RB offset:0#) 10MHz Bandwidth (RB size:1# RB offset:49#)

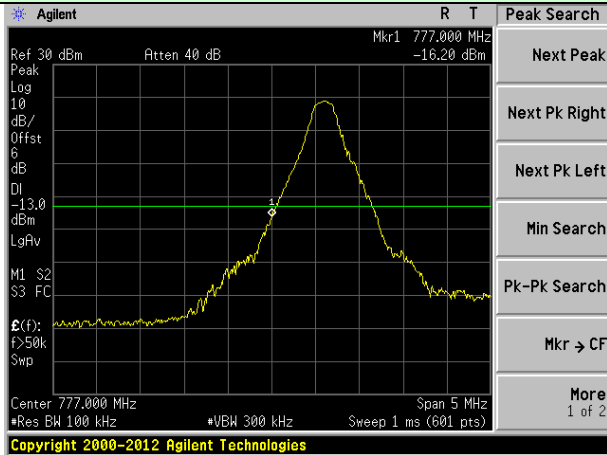

Lowest channel

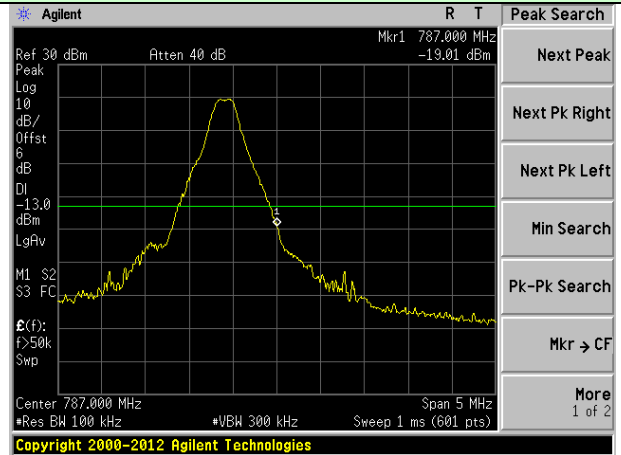

Highest channel

10MHz Bandwidth (RB size:25# RB offset:0#) 10MHz Bandwidth (RB size:25# RB offset:25#)

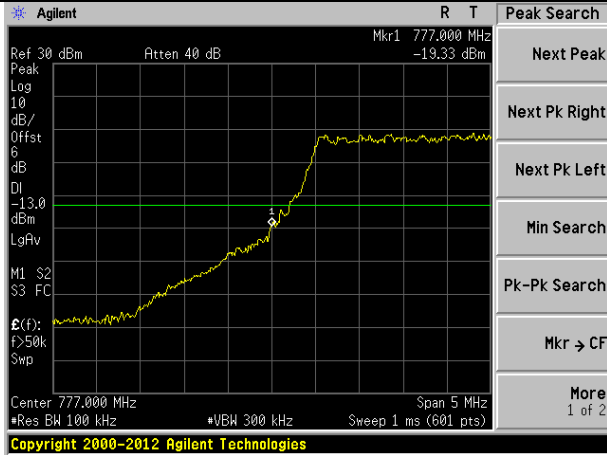

Lowest channel

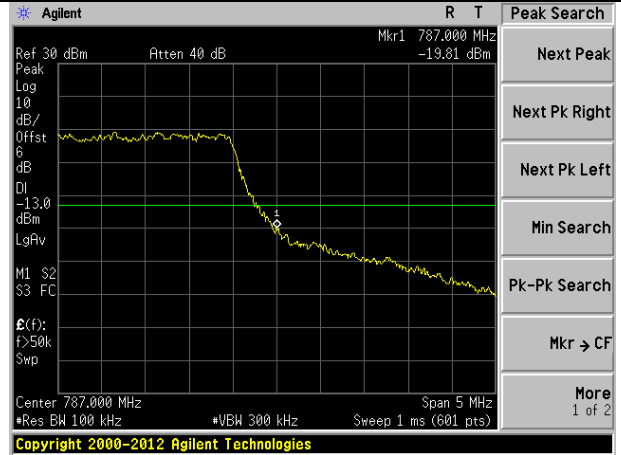

Highest channel

10MHz Bandwidth (RB size:50# RB offset:0#) 10MHz Bandwidth (RB size:50# RB offset:0#)

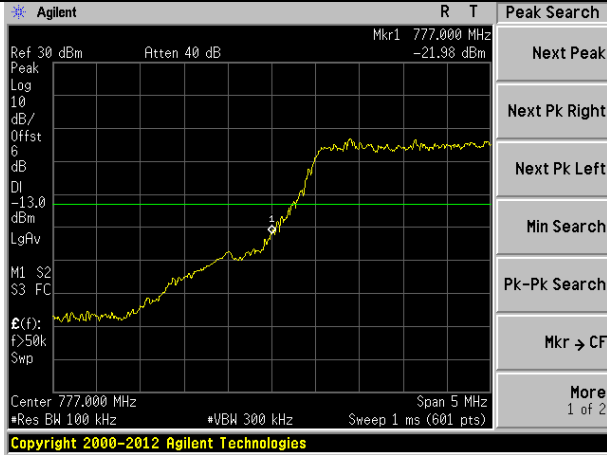

Lowest channel

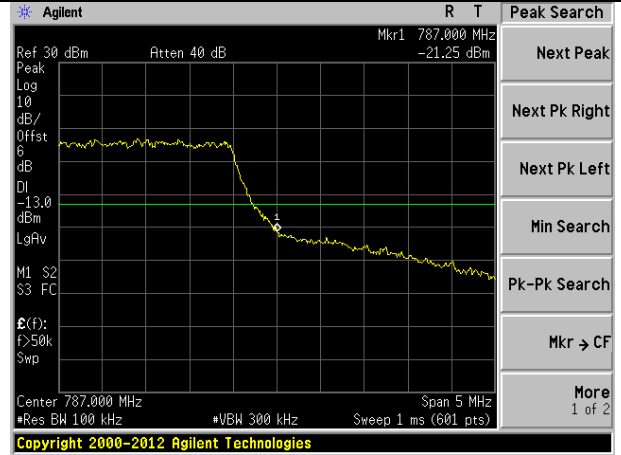

Highest channel

LTE Band 4(16QAM mode):

1.4MHz Bandwidth (RB size:1# RB offset:0#)

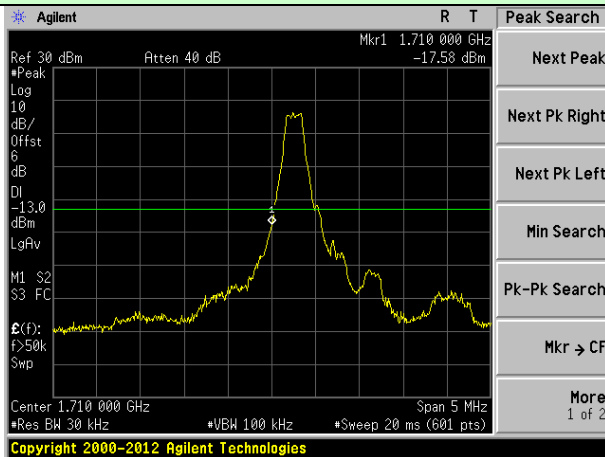

Lowest channel

1.4MHz Bandwidth (RB size:1# RB offset:5#)

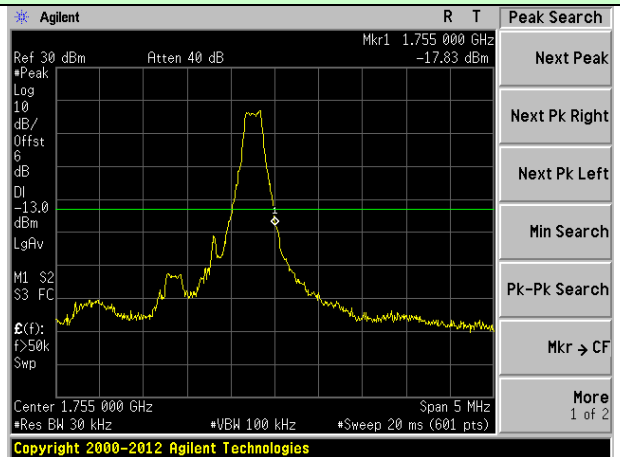

Highest channel

1.4MHz Bandwidth (RB size:3# RB offset:0#)



Lowest channel

1.4MHz Bandwidth (RB size:3# RB offset:2#)

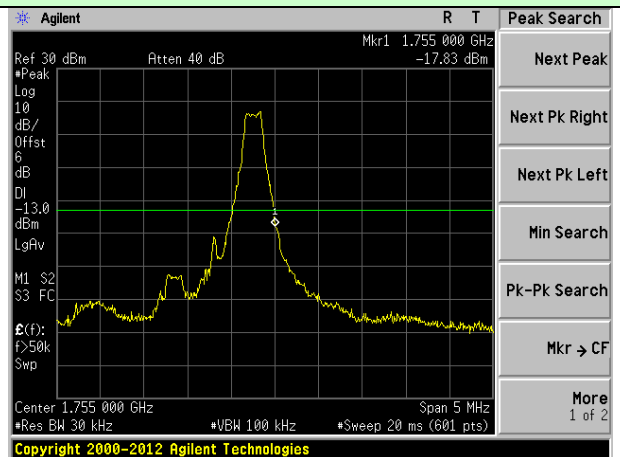

Highest channel

1.4MHz Bandwidth (RB size:6# RB offset:0#)

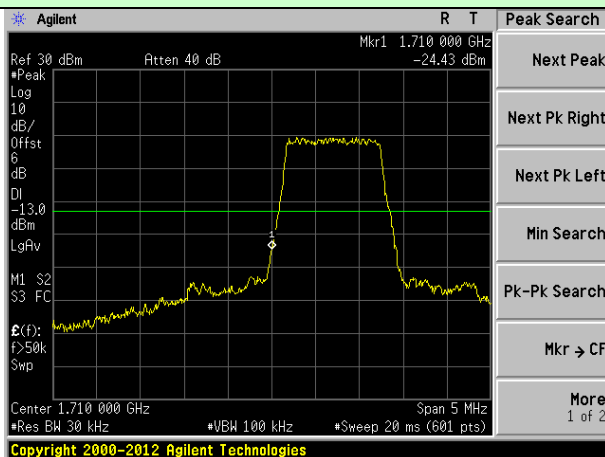

Lowest channel

1.4MHz Bandwidth (RB size:6# RB offset:0#)

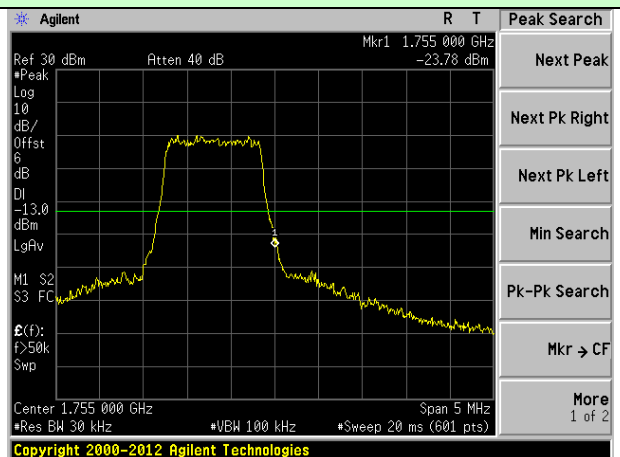

Highest channel

3MHz Bandwidth (RB size:1# RB offset:0#) **3MHz Bandwidth (RB size:1# RB offset:14#)**

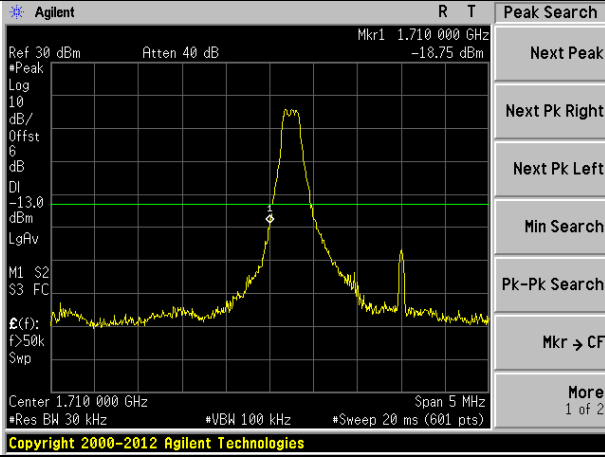

Lowest channel

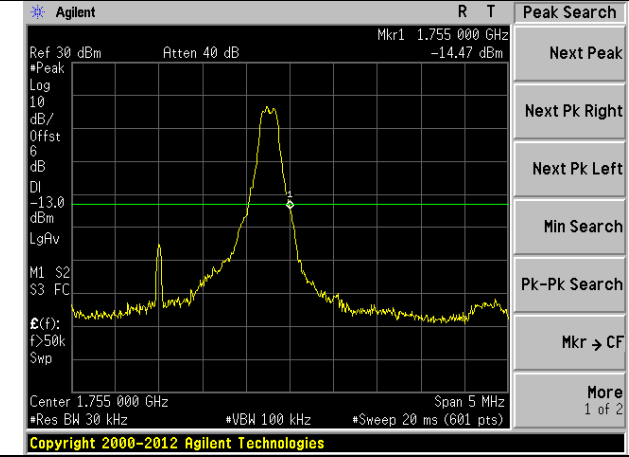

Highest channel

3MHz Bandwidth (RB size:8# RB offset:0#) **3MHz Bandwidth (RB size:8# RB offset:7#)**

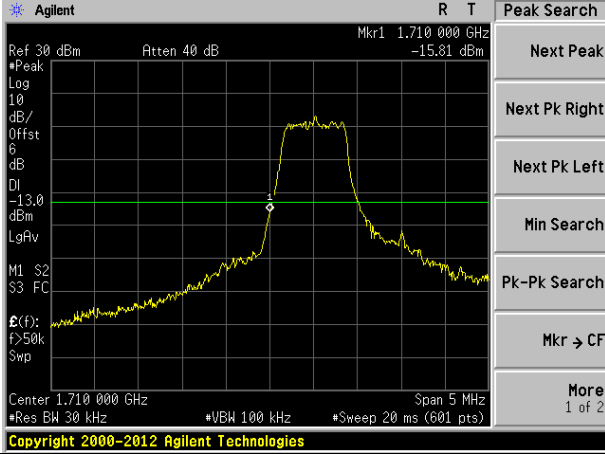

Lowest channel

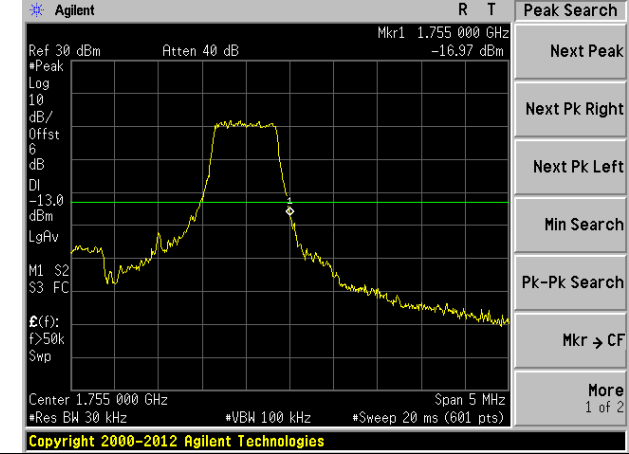

Highest channel

3MHz Bandwidth (RB size:15# RB offset:0#) **3MHz Bandwidth (RB size:15# RB offset:0#)**

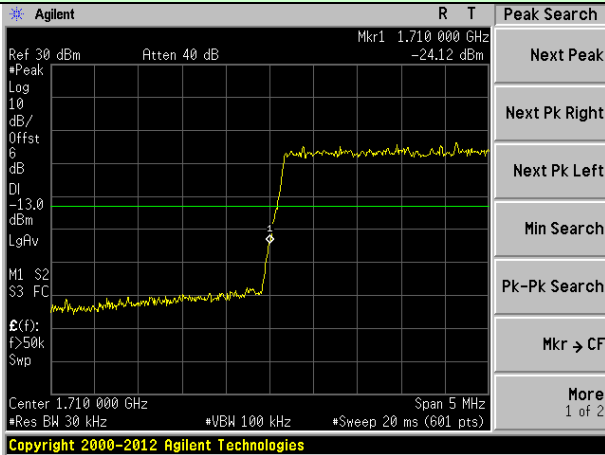

Lowest channel

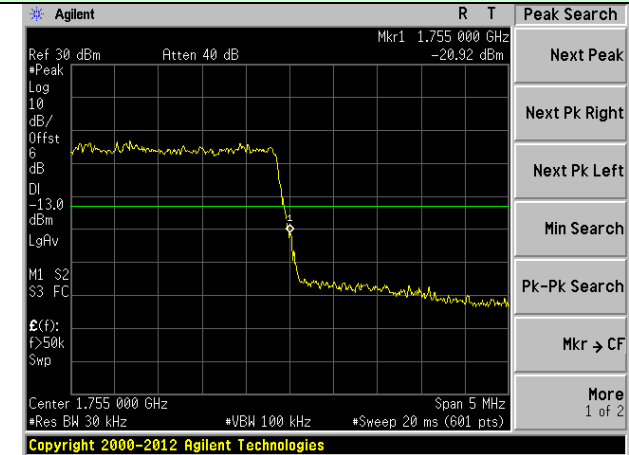

Highest channel

5MHz Bandwidth (RB size:1# RB offset:0#) 5MHz Bandwidth (RB size:1# RB offset:24#)

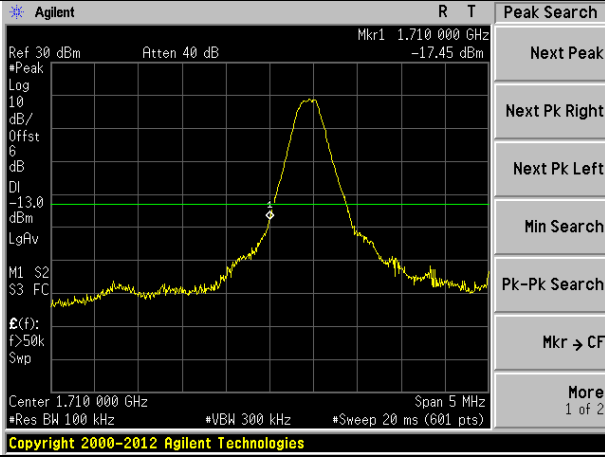

Lowest channel

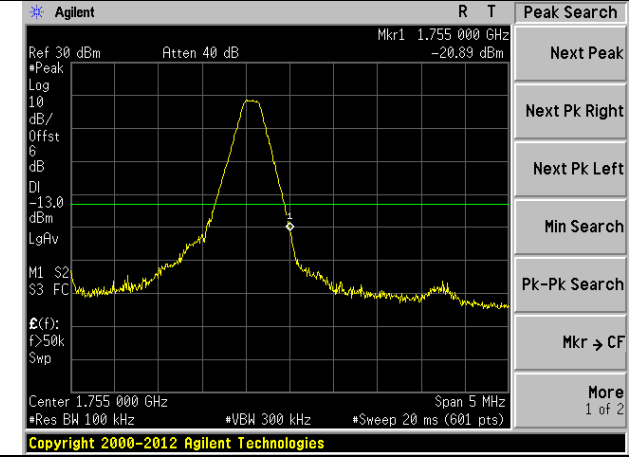

Highest channel

5MHz Bandwidth (RB size:12# RB offset:0#) 5MHz Bandwidth (RB size:12# RB offset:13#)

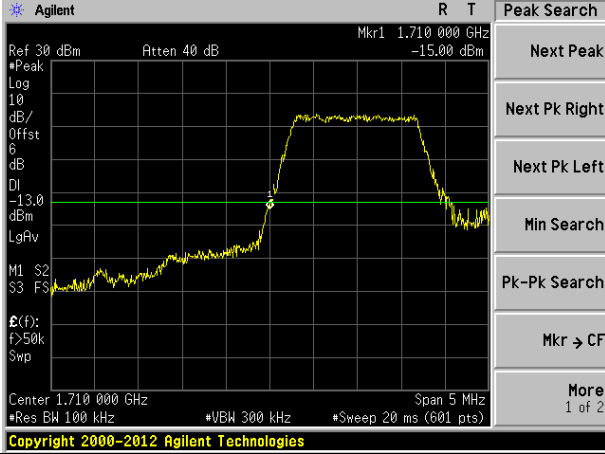

Lowest channel

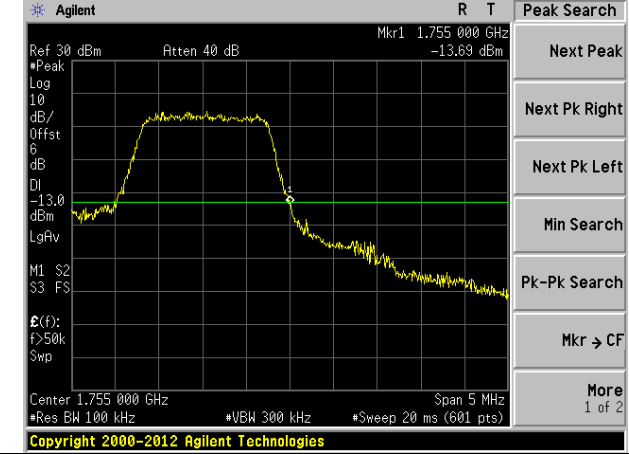

Highest channel

5MHz Bandwidth (RB size:25# RB offset:0#) 5MHz Bandwidth (RB size:25# RB offset:0#)

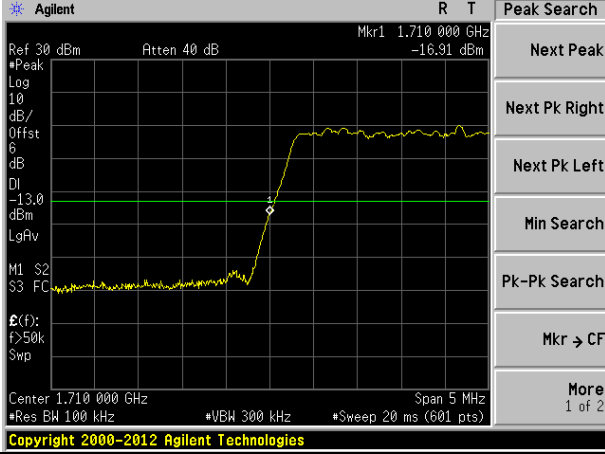

Lowest channel

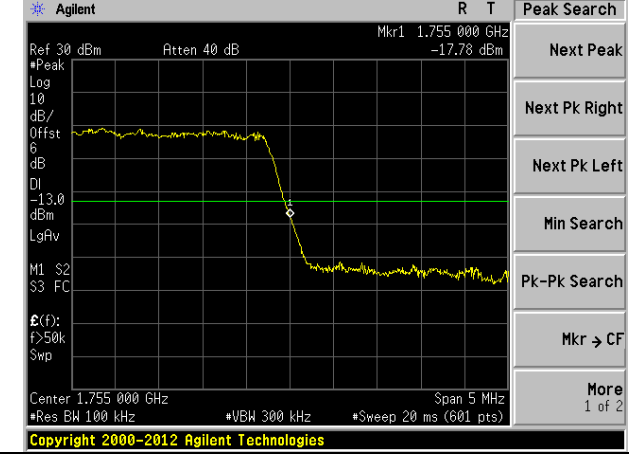

Highest channel

LTE Band 13(16QAM mode):

5MHz Bandwidth (RB size:1# RB offset:0#) 5MHz Bandwidth (RB size:1# RB offset:24#)

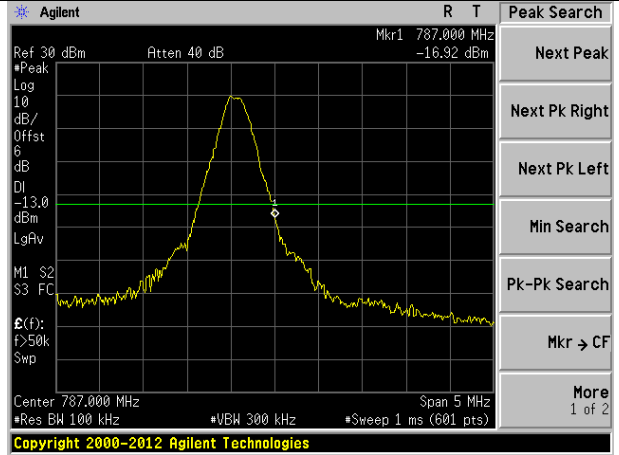
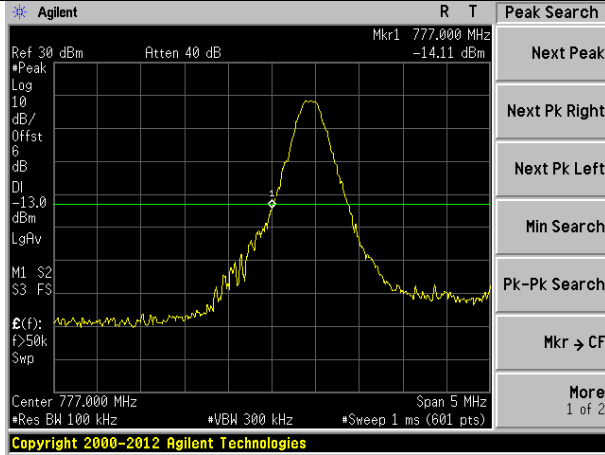

Lowest channel

Highest channel

5MHz Bandwidth (RB size:12# RB offset:0#) 5MHz Bandwidth (RB size:12# RB offset:13#)

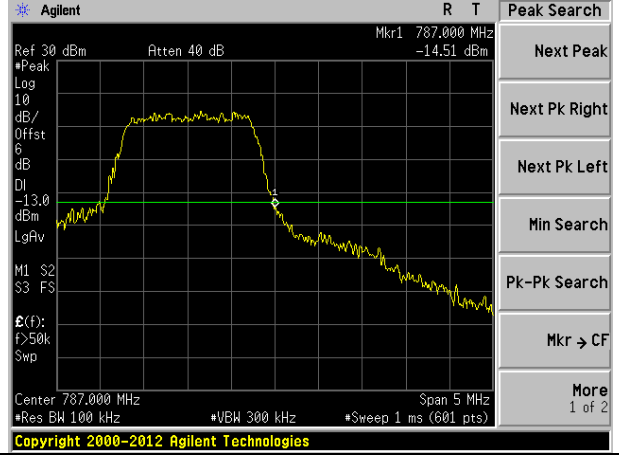
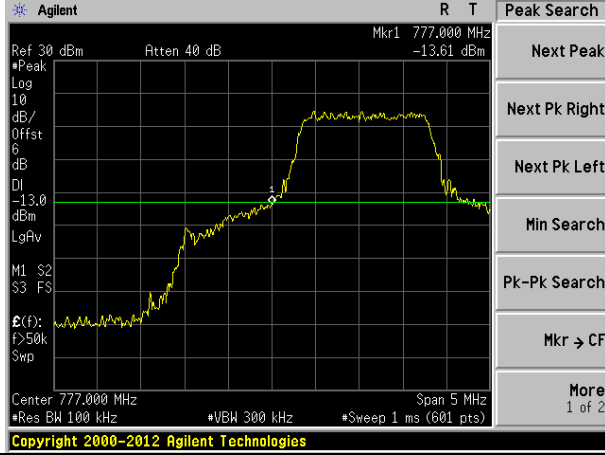

Lowest channel

Highest channel

5MHz Bandwidth (RB size:25# RB offset:0#) 5MHz Bandwidth (RB size:25# RB offset:0#)

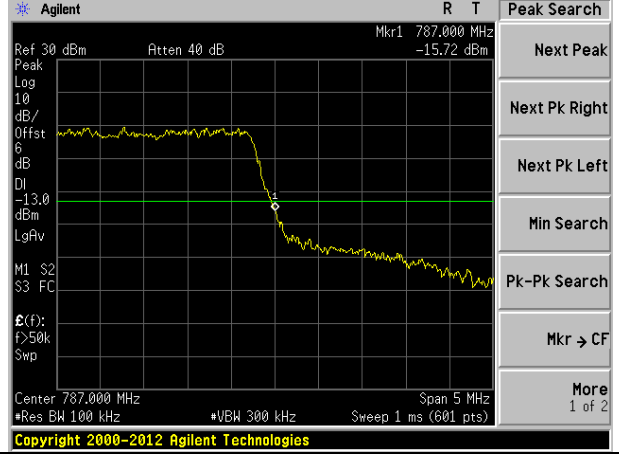
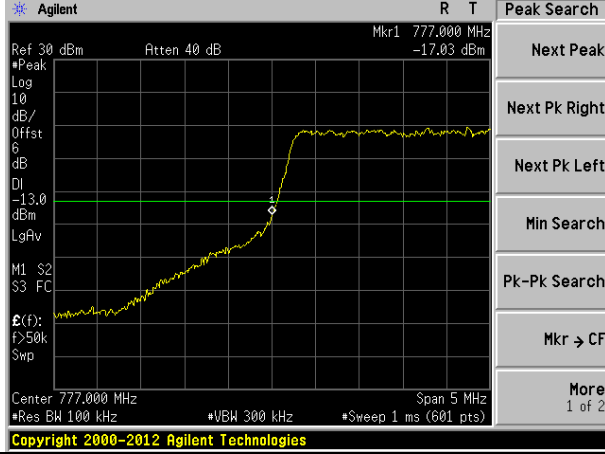

Lowest channel

Highest channel

6.8 ERP, EIRP Measurement

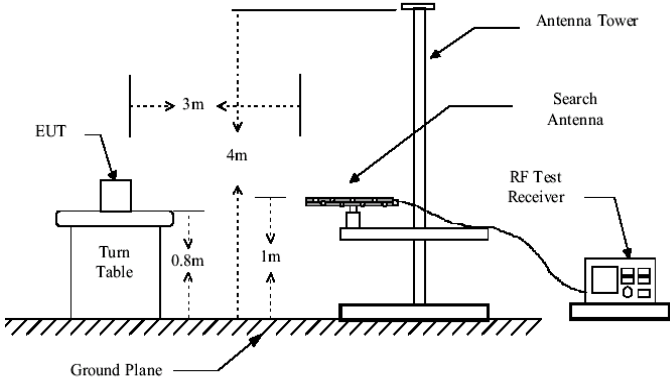
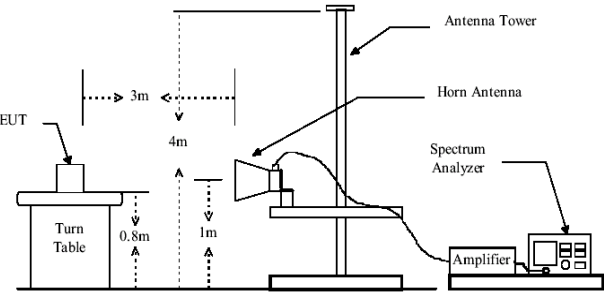
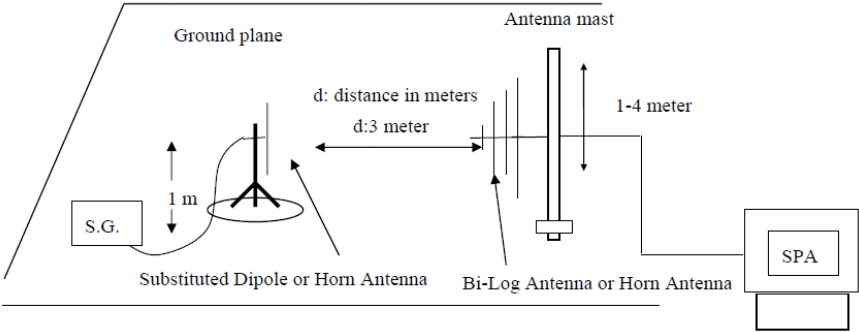
Test Requirement:	Part 27.50(b)(9)/(d)(4)
Test Method:	FCC part2.1046
Limit:	LTE Band 4: 1W (EIRP) LTE Band 13: 30W (ERP)
Test setup:	<p>Below 1GHz</p>  <p>Above 1GHz</p>  <p>Substituted method:</p> 

<p>Test Procedure:</p>	<ol style="list-style-type: none"> 1. The EUT was placed on an non-conductive turntable using a non-conductive support. The radiated emission at the fundamental frequency was measured at 3 m with a test antenna and EMI spectrum analyzer. 2. During the measurement, the EUT was communication with the station. The highest emission was recorded with the rotation of the turntable and the lowering of the test antenna from 4m to 1m. The reading was recorded and the field strength (E in dBuV/m) was calculated. 3. ERP in frequency band 777–787MHz were measured using a substitution method. The EUT was replaced by dipole antenna connected, the S.G. output was recorded and ERP was calculated asfollows: $\text{ERP} = \text{S.G. output (dBm)} + \text{Antenna Gain (dBd)} - \text{Cable Loss (dB)}$ 4. EIRP in frequency band 1710–1755MHz were measured using a substitution method. The EUT was replaced by or horn antenna connected, the S.G. output was recorded and EIRP was calculated as follows: $\text{EIRP} = \text{S.G. output (dBm)} + \text{Antenna Gain (dBi)} - \text{Cable Loss (dB)}$
<p>Test Instruments:</p>	<p>Refer to section 6.0 for details</p>
<p>Test mode:</p>	<p>Refer to section 6.1 for details</p>
<p>Test results:</p>	<p>Pass</p>

Measurement Data

QPSK mode:

EUT mode	Channel	EUT Pol.	Antenna Pol.	EIRP(dBm)	Limit (dBm)	Result
LTE Band 4 (1.4MHz)	Lowest	H	V	22.64	30.00	Pass
			H	20.59		
		E1	V	22.31		
			H	19.94		
		E2	V	21.55		
			H	18.70		
	Middle	H	V	22.68	30.00	Pass
			H	19.96		
		E1	V	22.23		
			H	19.77		
		E2	V	22.05		
			H	18.96		
	Highest	H	V	22.39	30.00	Pass
			H	20.11		
		E1	V	22.16		
			H	19.85		
		E2	V	21.88		
			H	19.32		

EUT mode	Channel	EUT Pol.	Antenna Pol.	EIRP(dBm)	Limit (dBm)	Result
LTE Band 4 (3MHz)	Lowest	H	V	22.73	30.00	Pass
			H	20.69		
		E1	V	22.42		
			H	20.07		
		E2	V	21.68		
			H	18.84		
	Middle	H	V	22.81	30.00	Pass
			H	20.12		
		E1	V	22.40		
			H	19.96		
		E2	V	22.21		
			H	19.12		
	Highest	H	V	22.52	30.00	Pass
			H	20.25		
		E1	V	22.31		
			H	20.01		
		E2	V	21.99		
			H	19.44		

EUT mode	Channel	EUT Pol.	Antenna Pol.	EIRP(dBm)	Limit (dBm)	Result
LTE Band 4 (5MHz)	Lowest	H	V	22.79	30.00	Pass
			H	20.79		
		E1	V	22.51		
			H	20.14		
		E2	V	21.78		
			H	18.98		
	Middle	H	V	22.91	30.00	Pass
			H	20.26		
		E1	V	22.53		
			H	20.07		
		E2	V	22.32		
			H	19.25		
	Highest	H	V	22.61	30.00	Pass
			H	20.35		
		E1	V	22.42		
			H	20.15		
		E2	V	22.08		
			H	19.52		

EUT mode	Channel	EUT Pol.	Antenna Pol.	EIRP(dBm)	Limit (dBm)	Result
LTE Band 4 (10MHz)	Lowest	H	V	22.85	30.00	Pass
			H	20.85		
		E1	V	22.57		
			H	20.21		
		E2	V	21.86		
			H	19.06		
	Middle	H	V	22.98	30.00	Pass
			H	20.35		
		E1	V	22.63		
			H	20.18		
		E2	V	22.41		
			H	19.35		
	Highest	H	V	22.69	30.00	Pass
			H	20.43		
		E1	V	22.51		
			H	20.24		
		E2	V	22.14		
			H	19.59		

EUT mode	Channel	EUT Pol.	Antenna Pol.	EIRP(dBm)	Limit (dBm)	Result
LTE Band 4 (15MHz)	Lowest	H	V	22.29	30.00	Pass
			H	20.21		
		E1	V	21.87		
			H	19.44		
		E2	V	21.01		
			H	18.14		
	Middle	H	V	22.17	30.00	Pass
			H	19.37		
		E1	V	21.56		
			H	19.04		
		E2	V	21.45		
			H	18.32		
	Highest	H	V	21.89	30.00	Pass
			H	19.56		
		E1	V	21.57		
			H	19.23		
		E2	V	21.45		
			H	18.83		

EUT mode	Channel	EUT Pol.	Antenna Pol.	EIRP(dBm)	Limit (dBm)	Result
LTE Band 4 (20MHz)	Lowest	H	V	21.95	30.00	Pass
			H	19.84		
		E1	V	21.45		
			H	18.97		
		E2	V	20.51		
			H	17.59		
	Middle	H	V	21.69	30.00	Pass
			H	18.79		
		E1	V	20.93		
			H	18.36		
		E2	V	20.88		
			H	17.71		
	Highest	H	V	21.42	30.00	Pass
			H	19.04		
		E1	V	21.01		
			H	18.63		
		E2	V	21.04		
			H	18.38		

EUT mode	Channel	EUT Pol.	Antenna Pol.	ERP(dBm)	Limit (dBm)	Result
LTE Band 13 (5MHz)	Lowest	H	V	22.83	44.77	Pass
			H	20.83		
		E1	V	22.56		
			H	20.20		
		E2	V	21.84		
			H	19.04		
	Middle	H	V	22.97	44.77	Pass
			H	20.32		
		E1	V	22.61		
			H	20.15		
		E2	V	22.39		
			H	19.33		
	Highest	H	V	22.67	44.77	Pass
			H	20.41		
		E1	V	22.49		
			H	20.22		
		E2	V	22.13		
			H	19.57		

EUT mode	Channel	EUT Pol.	Antenna Pol.	ERP(dBm)	Limit (dBm)	Result
LTE Band 13 (10MHz)	Middle	H	V	22.88	44.77	Pass
			H	20.88		
		E1	V	22.62		
			H	20.26		
		E2	V	21.91		
			H	19.12		

16QAM mode:

EUT mode	Channel	EUT Pol.	Antenna Pol.	EIRP(dBm)	Limit (dBm)	Result
LTE Band 4 (1.4MHz)	Lowest	H	V	22.91	30.00	Pass
			H	20.91		
		E1	V	22.65		
			H	20.30		
		E2	V	21.95		
			H	19.16		
	Middle	H	V	23.07	30.00	Pass
			H	20.45		
		E1	V	22.74		
			H	20.30		
		E2	V	22.51		
			H	19.46		
	Highest	H	V	22.77	30.00	Pass
			H	20.52		
		E1	V	22.61		
			H	20.35		
		E2	V	22.21		
			H	19.67		

EUT mode	Channel	EUT Pol.	Antenna Pol.	EIRP(dBm)	Limit (dBm)	Result
LTE Band 4 (3MHz)	Lowest	H	V	22.75	30.00	Pass
			H	20.74		
		E1	V	22.45		
			H	20.08		
		E2	V	21.72		
			H	18.90		
	Middle	H	V	22.84	30.00	Pass
			H	20.18		
		E1	V	22.45		
			H	19.98		
		E2	V	22.25		
			H	19.17		
	Highest	H	V	22.55	30.00	Pass
			H	20.28		
		E1	V	22.34		
			H	20.07		
		E2	V	22.02		
			H	19.46		

EUT mode	Channel	EUT Pol.	Antenna Pol.	EIRP(dBm)	Limit (dBm)	Result
LTE Band 4 (5MHz)	Lowest	H	V	22.45	30.00	Pass
			H	20.40		
		E1	V	22.08		
			H	19.67		
		E2	V	21.27		
			H	18.41		
	Middle	H	V	22.41	30.00	Pass
			H	19.66		
		E1	V	21.88		
			H	19.38		
		E2	V	21.74		
			H	18.63		
	Highest	H	V	22.13	30.00	Pass
			H	19.82		
		E1	V	21.85		
			H	19.53		
		E2	V	21.66		
			H	19.06		

EUT mode	Channel	EUT Pol.	Antenna Pol.	ERP(dBm)	Limit (dBm)	Result
LTE Band 13 (5MHz)	Lowest	H	V	22.31	44.77	Pass
			H	20.24		
		E1	V	21.90		
			H	19.47		
		E2	V	21.05		
			H	18.18		
	Middle	H	V	22.21	44.77	Pass
			H	19.42		
		E1	V	21.61		
			H	19.09		
		E2	V	21.50		
			H	18.37		
	Highest	H	V	21.93	44.77	Pass
			H	19.60		
		E1	V	21.61		
			H	19.28		
		E2	V	21.49		
			H	18.87		

6.9 Field strength of spurious radiation measurement

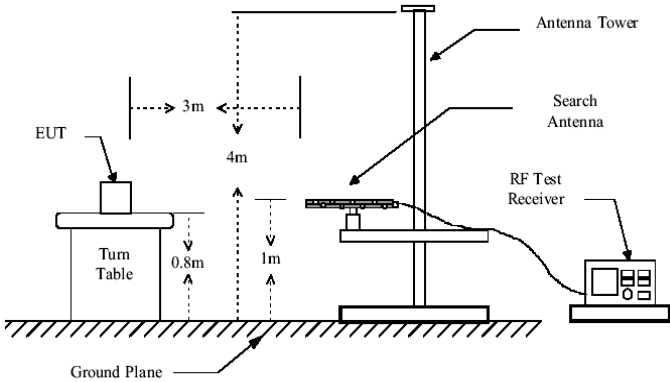
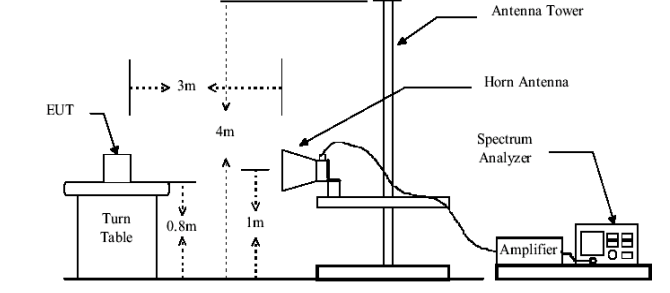
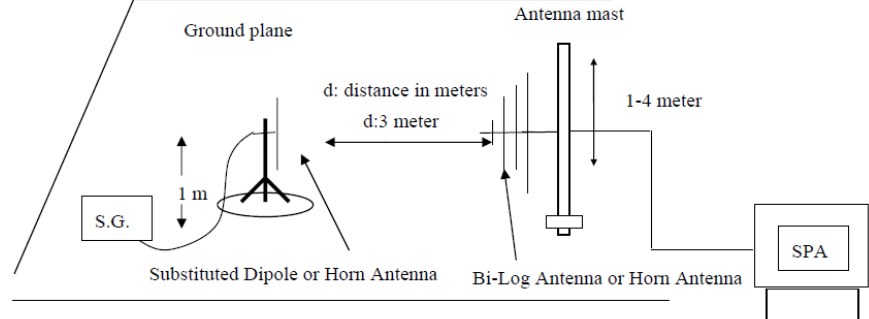
Test Requirement:	FCC Part 27.53(h)/(f)/(c)(2)
Test Method:	FCC part2.1053
Limit:	<p>Band 4/13:-13dBm,</p> <p>For operations in the 746-758 MHz, 775-788 MHz, and 805-806 MHz bands, emissions in the band 1559-1610 MHz shall be limited to -70 dBW/MHz equivalent isotropically radiated power (EIRP) for wideband signals.</p>
Test setup:	<p>Below 1GHz</p>  <p>Above 1GHz</p>  <p>Substituted method:</p> 

<p>Test Procedure:</p>	<ol style="list-style-type: none"> 1. The EUT was placed on a non-conductive turntable using a non-conductive support. The radiated emission at the fundamental frequency was measured at 3 m with a test antenna and EMI spectrum analyzer. 2. During the tests, the antenna height and the EUT azimuth were varied in order to identify the maximum level of emissions from the EUT. This maximization process was repeated with the EUT positioned in each of its three orthogonal orientations. 3. The frequency range up to tenth harmonic was investigated for each of three fundamental frequency (low, middle and high channels). Once spurious emission was identified, the power of the emission was determined using the substitution method. 4. The spurious emissions attenuation was calculated as the difference between radiated power at the fundamental frequency and the spurious emissions frequency. $\text{ERP / EIRP} = \text{S.G. output (dBm)} + \text{Antenna Gain(dB/dBi)} - \text{Cable Loss (dB)}$
<p>Test Instruments:</p>	<p>Refer to section 6.0 for details</p>
<p>Test mode:</p>	<p>Refer to section 6.1 for details</p>
<p>Test results:</p>	<p>Pass</p>

Measurement Data

QPSK mode:

Test mode:		LTE Band 4(1.4MHz)		Test channel:	Lowest
Frequency (MHz)	Spurious Emission		Limit (dBm)	Result	
	Polarization	Level (dBm)			
3421.40	Vertical	-34.83	-13.00	Pass	
5132.10	V	-37.42			
6842.80	V	-39.46			
8553.50	V	-41.55			
10264.20	V	---			
3421.40	Horizontal	-39.66	-13.00	Pass	
5132.10	H	-43.81			
6842.80	H	-45.08			
8553.50	H	-47.83			
10264.20	H	---			
Test mode:		LTE Band 4(1.4MHz)		Test channel:	Middle
Frequency (MHz)	Spurious Emission		Limit (dBm)	Result	
	Polarization	Level (dBm)			
3465.00	Vertical	-36.00	-13.00	Pass	
5197.50	V	-38.14			
6930.00	V	-39.82			
8662.50	V	-41.56			
10395.00	V	---			
3465.00	Horizontal	-39.98	-13.00	Pass	
5197.50	H	-43.50			
6930.00	H	-44.52			
8662.50	H	-46.82			
10395.00	H	---			
Test mode:		LTE Band 4(1.4MHz)		Test channel:	Highest
Frequency (MHz)	Spurious Emission		Limit (dBm)	Result	
	Polarization	Level (dBm)			
3508.60	Vertical	-36.30	-13.00	Pass	
5262.90	V	-38.19			
7017.20	V	-39.65			
8771.50	V	-41.19			
10525.80	V	---			
3508.60	Horizontal	-39.79	-13.00	Pass	
5262.90	H	-42.96			
7017.20	H	-43.82			
8771.50	H	-45.86			
10525.80	H	---			

Remark:

1. The emission behaviour belongs to narrowband spurious emission.
2. Remark"---" means that the emission level is too low to be measured
3. The emission levels of below 1 GHz are very lower than the limit and not show in test report.

Test mode:		LTE Band 4(3MHz)		Test channel:	Lowest
Frequency (MHz)	Spurious Emission		Limit (dBm)	Result	
	Polarization	Level (dBm)			
3423.00	Vertical	-35.99	-13.00	Pass	
5134.50	V	-38.22			
6846.00	V	-39.97			
8557.50	V	-41.79			
10269.00	V	---			
3423.00	Horizontal	-40.15	-13.00	Pass	
5134.50	H	-43.81			
6846.00	H	-44.85			
8557.50	H	-47.23			
10269.00	H	---			
Test mode:		LTE Band 4(3MHz)		Test channel:	Middle
Frequency (MHz)	Spurious Emission		Limit (dBm)	Result	
	Polarization	Level (dBm)			
3465.00	Vertical	-33.67	-13.00	Pass	
5197.50	V	-35.99			
6930.00	V	-37.79			
8662.50	V	-39.69			
10395.00	V	---			
3465.00	Horizontal	-38.00	-13.00	Pass	
5197.50	H	-41.76			
6930.00	H	-42.86			
8662.50	H	-45.33			
10395.00	H	---			
Test mode:		LTE Band 4(3MHz)		Test channel:	Highest
Frequency (MHz)	Spurious Emission		Limit (dBm)	Result	
	Polarization	Level (dBm)			
3507.00	Vertical	-34.72	-13.00	Pass	
5260.50	V	-36.97			
7014.00	V	-38.72			
8767.50	V	-40.55			
10521.00	V	---			
3507.00	Horizontal	-38.91	-13.00	Pass	
5260.50	H	-42.58			
7014.00	H	-43.63			
8767.50	H	-46.03			
10521.00	H	---			

Remark:

1. The emission behaviour belongs to narrowband spurious emission.
2. Remark"---" means that the emission level is too low to be measured
3. The emission levels of below 1 GHz are very lower than the limit and not show in test report.

Test mode:		LTE Band 4(5MHz)		Test channel:	Lowest
Frequency (MHz)	Spurious Emission		Limit (dBm)	Result	
	Polarization	Level (dBm)			
3425.00	Vertical	-37.56	-13.00	Pass	
5137.50	V	-40.50			
6850.00	V	-42.82			
8562.50	V	-45.21			
10275.00	V	---			
3425.00	Horizontal	-43.07	-13.00	Pass	
5137.50	H	-47.72			
6850.00	H	-49.18			
8562.50	H	-52.27			
10275.00	H	---			
Test mode:		LTE Band 4(5MHz)		Test channel:	Middle
Frequency (MHz)	Spurious Emission		Limit (dBm)	Result	
	Polarization	Level (dBm)			
3465.00	Vertical	-38.49	-13.00	Pass	
5197.50	V	-41.26			
6930.00	V	-43.44			
8662.50	V	-45.70			
10395.00	V	---			
3465.00	Horizontal	-43.68	-13.00	Pass	
5197.50	H	-48.10			
6930.00	H	-49.46			
8662.50	H	-52.38			
10395.00	H	---			
Test mode:		LTE Band 4(5MHz)		Test channel:	Highest
Frequency (MHz)	Spurious Emission		Limit (dBm)	Result	
	Polarization	Level (dBm)			
3505.00	Vertical	-37.47	-13.00	Pass	
5257.50	V	-40.06			
7010.00	V	-42.09			
8762.50	V	-44.20			
10515.00	V	---			
3505.00	Horizontal	-42.30	-13.00	Pass	
5257.50	H	-46.46			
7010.00	H	-47.71			
8762.50	H	-50.45			
10515.00	H	---			

Remark:

1. The emission behaviour belongs to narrowband spurious emission.
2. Remark"---" means that the emission level is too low to be measured
3. The emission levels of below 1 GHz are very lower than the limit and not show in test report.

Test mode:		LTE Band 4(10MHz)		Test channel:	Lowest
Frequency (MHz)	Spurious Emission		Limit (dBm)	Result	
	Polarization	Level (dBm)			
3430.00	Vertical	-36.07	-13.00	Pass	
5145.00	V	-39.87			
6860.00	V	-42.38			
8575.00	V	-40.03			
10290.00	V	---			
3430.00	Horizontal	-38.86	-13.00	Pass	
5145.00	H	-41.30			
6860.00	H	-46.69			
8575.00	H	-50.38			
10290.00	H	---			
Test mode:		LTE Band 4(10MHz)		Test channel:	Middle
Frequency (MHz)	Spurious Emission		Limit (dBm)	Result	
	Polarization	Level (dBm)			
3465.00	Vertical	-38.31	-13.00	Pass	
5197.50	V	-39.66			
6930.00	V	-43.05			
8662.50	V	-45.64			
10395.00	V	---			
3465.00	Horizontal	-40.73	-13.00	Pass	
5197.50	H	-42.37			
6930.00	H	-47.03			
8662.50	H	-49.47			
10395.00	H	---			
Test mode:		LTE Band 4(10MHz)		Test channel:	Highest
Frequency (MHz)	Spurious Emission		Limit (dBm)	Result	
	Polarization	Level (dBm)			
3500.00	Vertical	-36.33	-13.00	Pass	
5250.00	V	-38.83			
7000.00	V	-41.25			
8750.00	V	-44.27			
10500.00	V	---			
3500.00	Horizontal	-39.68	-13.00	Pass	
5250.00	H	-41.87			
7000.00	H	-43.24			
8750.00	H	-49.50			
10500.00	H	---			

Remark:

1. The emission behaviour belongs to narrowband spurious emission.
2. Remark"---" means that the emission level is too low to be measured
3. The emission levels of below 1 GHz are very lower than the limit and not show in test report.

Test mode:		LTE Band 4(15MHz)		Test channel:	Lowest
Frequency (MHz)	Spurious Emission		Limit (dBm)	Result	
	Polarization	Level (dBm)			
3435.00	Vertical	-38.98	-13.00	Pass	
5152.50	V	-39.72			
6870.00	V	-40.91			
8587.50	V	-43.26			
10305.00	V	---			
3435.00	Horizontal	-42.14	-13.00	Pass	
5152.50	H	-43.53			
6870.00	H	-44.43			
8587.50	H	-47.39			
10305.00	H	---			
Test mode:		LTE Band 4(15MHz)		Test channel:	Middle
Frequency (MHz)	Spurious Emission		Limit (dBm)	Result	
	Polarization	Level (dBm)			
3465.00	Vertical	-39.53	-13.00	Pass	
5197.50	V	-41.69			
6930.00	V	-43.04			
8662.50	V	-47.26			
10395.00	V	---			
3465.00	Horizontal	-42.69	-13.00	Pass	
5197.50	H	-43.30			
6930.00	H	-45.51			
8662.50	H	-48.62			
10395.00	H	---			
Test mode:		LTE Band 4(15MHz)		Test channel:	Highest
Frequency (MHz)	Spurious Emission		Limit (dBm)	Result	
	Polarization	Level (dBm)			
3495.00	Vertical	-37.15	-13.00	Pass	
5242.50	V	-38.62			
6990.00	V	-40.47			
8737.50	V	-41.67			
10485.00	V	---			
3495.00	Horizontal	-42.94	-13.00	Pass	
5242.50	H	-46.53			
6990.00	H	-48.60			
8737.50	H	-51.66			
10485.00	H	---			

Remark:

1. The emission behaviour belongs to narrowband spurious emission.
2. Remark"---" means that the emission level is too low to be measured
3. The emission levels of below 1 GHz are very lower than the limit and not show in test report.

Test mode:		LTE Band 4(20MHz)		Test channel:	Lowest
Frequency (MHz)	Spurious Emission		Limit (dBm)	Result	
	Polarization	Level (dBm)			
3440.00	Vertical	-34.82	-13.00	Pass	
5160.00	V	-37.60			
6880.00	V	-39.64			
8600.00	V	-41.91			
10320.00	V	---			
3440.00	Horizontal	-40.03	-13.00	Pass	
5160.00	H	-43.64			
6880.00	H	-45.18			
8600.00	H	-47.96			
10320.00	H	---			
Test mode:		LTE Band 4(20MHz)		Test channel:	Middle
Frequency (MHz)	Spurious Emission		Limit (dBm)	Result	
	Polarization	Level (dBm)			
3465.00	Vertical	-36.01	-13.00	Pass	
5197.50	V	-38.33			
6930.00	V	-40.01			
8662.50	V	-41.93			
10395.00	V	---			
3465.00	Horizontal	-40.36	-13.00	Pass	
5197.50	H	-43.33			
6930.00	H	-44.62			
8662.50	H	-46.96			
10395.00	H	---			
Test mode:		LTE Band 4(20MHz)		Test channel:	Highest
Frequency (MHz)	Spurious Emission		Limit (dBm)	Result	
	Polarization	Level (dBm)			
3490.00	Vertical	-36.32	-13.00	Pass	
5235.00	V	-38.40			
6980.00	V	-39.85			
8725.00	V	-41.58			
10470.00	V	---			
3490.00	Horizontal	-40.18	-13.00	Pass	
5235.00	H	-42.80			
6980.00	H	-43.94			
8725.00	H	-46.02			
10470.00	H	---			

Remark:

1. The emission behaviour belongs to narrowband spurious emission.
2. Remark"---" means that the emission level is too low to be measured
3. The emission levels of below 1 GHz are very lower than the limit and not show in test report.

Test mode:		LTE Band 13(5MHz)		Test channel:	Lowest
Frequency (MHz)	Spurious Emission		Limit (dBm)	Result	
	Polarization	Level (dBm)			
1559.00	Vertical	-44.37	-40.00	Pass	
2338.50	V	-37.46	-13.00		
3118.00	V	-39.25			
3897.50	V	-41.28			
4677.00	V	---			
1559.00	Horizontal	-45.42	-40.00	Pass	
2338.50	H	-42.78	-13.00		
3118.00	H	-44.15			
3897.50	H	-46.62			
4677.00	H	---			
Test mode:		LTE Band 13(5MHz)		Test channel:	Middle
Frequency (MHz)	Spurious Emission		Limit (dBm)	Result	
	Polarization	Level (dBm)			
1564.00	Vertical	-44.36	-40.00	Pass	
2346.00	V	-39.54	-13.00		
3128.00	V	-40.74			
3910.00	V	-43.10			
4692.00	V	---			
1564.00	Horizontal	-44.97	-40.00	Pass	
2346.00	H	-43.37	-13.00		
3128.00	H	-44.27			
3910.00	H	-47.25			
4692.00	H	---			
Test mode:		LTE Band 13(5MHz)		Test channel:	Highest
Frequency (MHz)	Spurious Emission		Limit (dBm)	Result	
	Polarization	Level (dBm)			
1569.00	Vertical	-44.21	-40.00	Pass	
2353.50	V	-38.77	-13.00		
3138.00	V	-41.19			
3922.50	V	-44.21			
4707.00	V	---			
1569.00	Horizontal	-45.61	-40.00	Pass	
2353.50	H	-41.81	-13.00		
3138.00	H	-43.18			
3922.50	H	-49.45			
4707.00	H	---			

Remark:

1. The emission behaviour belongs to narrowband spurious emission.
2. Remark"---" means that the emission level is too low to be measured
3. The emission levels of below 1 GHz are very lower than the limit and not show in test report.

Test mode:	LTE Band 13(10MHz)		Test channel:	Middle
Frequency (MHz)	Spurious Emission		Limit (dBm)	Result
	Polarization	Level (dBm)		
1564.00	Vertical	-43.39	-40.00	Pass
2346.00	V	-39.56	-13.00	
3128.00	V	-42.96		
3910.00	V	-45.54		
4692.00	V	---		
1564.00	Horizontal	-44.33	-40.00	Pass
2346.00	H	-42.28	-13.00	
3128.00	H	-46.95		
3910.00	H	-49.39		
4692.00	H	---		

Remark:

1. The emission behaviour belongs to narrowband spurious emission.
2. Remark"---" means that the emission level is too low to be measured
3. The emission levels of below 1 GHz are very lower than the limit and not show in test report.

16QAM mode:

Test mode:		LTE Band 4(1.4MHz)		Test channel:	Lowest
Frequency (MHz)	Spurious Emission		Limit (dBm)	Result	
	Polarization	Level (dBm)			
3421.40	Vertical	-34.71	-13.00	Pass	
5132.10	V	-37.50			
6842.80	V	-39.54			
8553.50	V	-41.81			
10264.20	V	---			
3421.40	Horizontal	-39.93	-13.00	Pass	
5132.10	H	-43.54			
6842.80	H	-45.09			
8553.50	H	-47.88			
10264.20	H	---			
Test mode:		LTE Band 4(1.4MHz)		Test channel:	Middle
Frequency (MHz)	Spurious Emission		Limit (dBm)	Result	
	Polarization	Level (dBm)			
3465.00	Vertical	-35.91	-13.00	Pass	
5197.50	V	-38.24			
6930.00	V	-39.92			
8662.50	V	-41.85			
10395.00	V	---			
3465.00	Horizontal	-40.27	-13.00	Pass	
5197.50	H	-43.25			
6930.00	H	-44.55			
8662.50	H	-46.89			
10395.00	H	---			
Test mode:		LTE Band 4(1.4MHz)		Test channel:	Highest
Frequency (MHz)	Spurious Emission		Limit (dBm)	Result	
	Polarization	Level (dBm)			
3508.60	Vertical	-36.25	-13.00	Pass	
5262.90	V	-38.33			
7017.20	V	-39.78			
8771.50	V	-41.51			
10525.80	V	---			
3508.60	Horizontal	-40.12	-13.00	Pass	
5262.90	H	-42.74			
7017.20	H	-43.88			
8771.50	H	-45.96			
10525.80	H	---			

Remark:

1. The emission behaviour belongs to narrowband spurious emission.
2. Remark"---" means that the emission level is too low to be measured
3. The emission levels of below 1 GHz are very lower than the limit and not show in test report.

Test mode:		LTE Band 4(3MHz)		Test channel:	Lowest
Frequency (MHz)	Spurious Emission		Limit (dBm)	Result	
	Polarization	Level (dBm)			
3423.00	Vertical	-35.10	-13.00	Pass	
5134.50	V	-37.55			
6846.00	V	-39.34			
8557.50	V	-41.36			
10269.00	V	---			
3423.00	Horizontal	-39.70	-13.00	Pass	
5134.50	H	-42.86			
6846.00	H	-44.22			
8557.50	H	-46.69			
10269.00	H	---			
Test mode:		LTE Band 4(3MHz)		Test channel:	Middle
Frequency (MHz)	Spurious Emission		Limit (dBm)	Result	
	Polarization	Level (dBm)			
3465.00	Vertical	-33.53	-13.00	Pass	
5197.50	V	-36.03			
6930.00	V	-37.84			
8662.50	V	-39.93			
10395.00	V	---			
3465.00	Horizontal	-38.23	-13.00	Pass	
5197.50	H	-41.46			
6930.00	H	-42.85			
8662.50	H	-45.36			
10395.00	H	---			
Test mode:		LTE Band 4(3MHz)		Test channel:	Highest
Frequency (MHz)	Spurious Emission		Limit (dBm)	Result	
	Polarization	Level (dBm)			
3507.00	Vertical	-34.55	-13.00	Pass	
5260.50	V	-36.99			
7014.00	V	-38.75			
8767.50	V	-40.77			
10521.00	V	---			
3507.00	Horizontal	-39.12	-13.00	Pass	
5260.50	H	-42.26			
7014.00	H	-43.59			
8767.50	H	-46.03			
10521.00	H	---			

Remark:

1. The emission behaviour belongs to narrowband spurious emission.
2. Remark"---" means that the emission level is too low to be measured
3. The emission levels of below 1 GHz are very lower than the limit and not show in test report.

Test mode:		LTE Band 4(5MHz)		Test channel:	Lowest
Frequency (MHz)	Spurious Emission		Limit (dBm)	Result	
	Polarization	Level (dBm)			
3425.00	Vertical	-37.25	-13.00	Pass	
5137.50	V	-40.39			
6850.00	V	-42.73			
8562.50	V	-45.31			
10275.00	V	---			
3425.00	Horizontal	-43.16	-13.00	Pass	
5137.50	H	-47.28			
6850.00	H	-49.04			
8562.50	H	-52.18			
10275.00	H	---			
Test mode:		LTE Band 4(5MHz)		Test channel:	Middle
Frequency (MHz)	Spurious Emission		Limit (dBm)	Result	
	Polarization	Level (dBm)			
3465.00	Vertical	-38.33	-13.00	Pass	
5197.50	V	-41.30			
6930.00	V	-43.48			
8662.50	V	-45.93			
10395.00	V	---			
3465.00	Horizontal	-43.91	-13.00	Pass	
5197.50	H	-47.79			
6930.00	H	-49.43			
8662.50	H	-52.40			
10395.00	H	---			
Test mode:		LTE Band 4(5MHz)		Test channel:	Highest
Frequency (MHz)	Spurious Emission		Limit (dBm)	Result	
	Polarization	Level (dBm)			
3505.00	Vertical	-37.51	-13.00	Pass	
5257.50	V	-40.28			
7010.00	V	-42.30			
8762.50	V	-44.60			
10515.00	V	---			
3505.00	Horizontal	-42.71	-13.00	Pass	
5257.50	H	-46.32			
7010.00	H	-47.85			
8762.50	H	-50.62			
10515.00	H	---			

Remark:

1. The emission behaviour belongs to narrowband spurious emission.
2. Remark"---" means that the emission level is too low to be measured
3. The emission levels of below 1 GHz are very lower than the limit and not show in test report.

Test mode:	LTE Band 13(5MHz)		Test channel:	Lowest
Frequency (MHz)	Spurious Emission		Limit (dBm)	Result
	Polarization	Level (dBm)		
1559.00	Vertical	-43.58	-40.00	Pass
2338.50	V	-39.60	-13.00	
3118.00	V	-42.99		
3897.50	V	-45.58		
4677.00	V	---		
1559.00	Horizontal	-44.97	-40.00	Pass
2338.50	H	-42.32	-13.00	
3118.00	H	-46.98		
3897.50	H	-49.42		
4677.00	H	---		
Test mode:	LTE Band 13(5MHz)		Test channel:	Middle
Frequency (MHz)	Spurious Emission		Limit (dBm)	Result
	Polarization	Level (dBm)		
1564.00	Vertical	-44.10	-40.00	Pass
2346.00	V	-38.95	-13.00	
3128.00	V	-41.37		
3910.00	V	-44.39		
4692.00	V	---		
1564.00	Horizontal	-43.65	-40.00	Pass
2346.00	H	-41.98	-13.00	
3128.00	H	-43.34		
3910.00	H	-49.60		
4692.00	H	---		
Test mode:	LTE Band 13(5MHz)		Test channel:	Highest
Frequency (MHz)	Spurious Emission		Limit (dBm)	Result
	Polarization	Level (dBm)		
1569.00	Vertical	-43.30	-40.00	Pass
2353.50	V	-39.70	-13.00	
3138.00	V	-40.89		
3922.50	V	-43.25		
4707.00	V	---		
1569.00	Horizontal	-44.15	-40.00	Pass
2353.50	H	-43.51	-13.00	
3138.00	H	-44.41		
3922.50	H	-47.37		
4707.00	H	---		

Remark:

1. The emission behaviour belongs to narrowband spurious emission.
2. Remark"---" means that the emission level is too low to be measured
3. The emission levels of below 1 GHz are very lower than the limit and not show in test report.

6.10 Frequency stability V.S. Temperature measurement

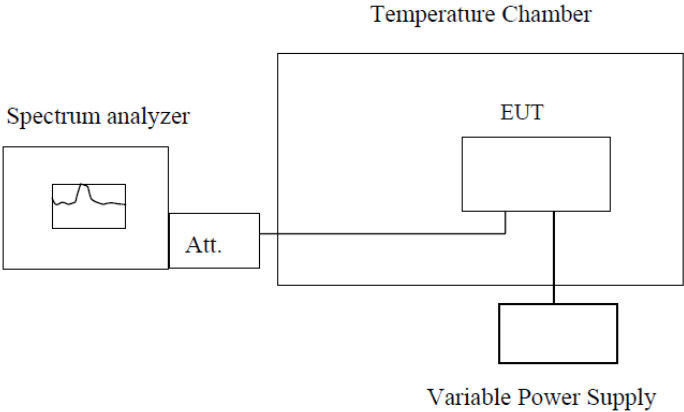
Test Requirement:	FCC Part2.1055(a)(1)(b)
Test Method:	FCC Part2.1055(a)(1)(b)
Limit:	2.5ppm
Test setup:	 <p style="text-align: center;">Note : Measurement setup for testing on Antenna connector</p>
Test procedure:	<ol style="list-style-type: none"> 1. The equipment under test was connected to an external DC power supply and input rated voltage. 2. RF output was connected to a frequency counter or spectrum analyzer via feed through attenuators. 3. The EUT was placed inside the temperature chamber. 4. Set the spectrum analyzer RBW low enough to obtain the desired frequency resolution and measure EUT 25°C operating frequency as reference frequency. 5. Turn EUT off and set the chamber temperature to -20°C. After the temperature stabilized for approximately 30 minutes recorded the frequency. 6. Repeat step measure with 10°C increased per stage until the highest temperature of +50°C reached.
Test Instruments:	Refer to section 6.0 for details
Test mode:	Refer to section 6.1 for details
Test results:	Pass

Measurement Data

QPSK mode:

Reference Frequency: LTE Band 4 Middle channel=20175 channel=1732.5MHz					
Power supplied (Vdc)	Temperature (°C)	Frequency error		Limit (ppm)	Result
		Hz	ppm		
12.0	-30	30	0.0173	2.5	Pass
	-20	34	0.0196		
	-10	31	0.0179		
	0	28	0.0162		
	10	29	0.0167		
	20	28	0.0162		
	30	39	0.0225		
	40	34	0.0196		
	50	34	0.0196		
Reference Frequency: LTE Band 13 Middle channel=23230 channel=782MHz					
Power supplied (Vdc)	Temperature (°C)	Frequency error			Result
		Hz	ppm		
12.0	-30	53	0.0678	2.5	Pass
	-20	64	0.0818		
	-10	53	0.0678		
	0	46	0.0588		
	10	51	0.0652		
	20	45	0.0575		
	30	75	0.0959		
	40	65	0.0831		
	50	63	0.0806		

16QAM mode:

Reference Frequency: LTE Band 4 Middle channel=20175 channel=1732.5MHz					
Power supplied (Vdc)	Temperature (°C)	Frequency error		Limit (ppm)	Result
		Hz	ppm		
12.0	-30	23	0.0133	2.5	Pass
	-20	27	0.0156		
	-10	24	0.0139		
	0	22	0.0127		
	10	23	0.0133		
	20	22	0.0127		
	30	29	0.0167		
	40	25	0.0144		
	50	27	0.0156		
Reference Frequency: LTE Band 13 Middle channel=23230 channel=782MHz					
Power supplied (Vdc)	Temperature (°C)	Frequency error			Result
		Hz	ppm		
12.0	-30	51	0.0652	2.5	Pass
	-20	61	0.0780		
	-10	51	0.0652		
	0	44	0.0563		
	10	49	0.0627		
	20	44	0.0563		
	30	72	0.0921		
	40	62	0.0793		
	50	61	0.0780		

6.11 Frequency stability V.S. Voltage measurement

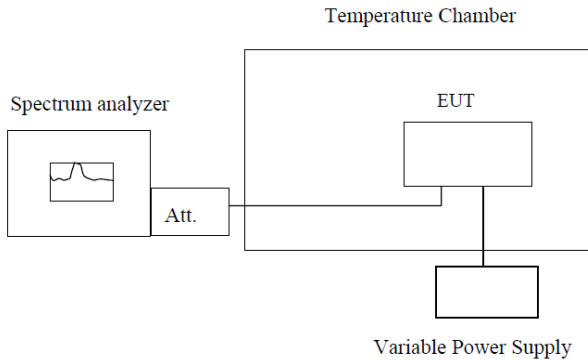
Test Requirement:	FCC Part2.1055(d)(1)(2)
Test Method:	FCC Part2.1055(d)(1)(2)
Limit:	2.5ppm
Test setup:	 <p style="text-align: center;">Temperature Chamber</p> <p style="text-align: center;">Spectrum analyzer</p> <p style="text-align: center;">Att.</p> <p style="text-align: center;">EUT</p> <p style="text-align: center;">Variable Power Supply</p> <p>Note : Measurement setup for testing on Antenna connector</p>
Test procedure:	<ol style="list-style-type: none"> 1. Set chamber temperature to 25°C. Use a variable DC power source to power the EUT and set the voltage to rated voltage. 2. Set the spectrum analyzer RBW low enough to obtain the desired frequency resolution and recorded the frequency. 3. Reduce the input voltage to specified extreme voltage variation (+/- 15%) and endpoint, record the maximum frequency change.
Test Instruments:	Refer to section 6.0 for details
Test mode:	Refer to section 6.1 for details
Test results:	Pass

Measurement Data

QPSK mode:

Reference Frequency: LTE Band 4 Middle channel=20175 channel=1732.5MHz					
Temperature (°C)	Power supplied (Vdc)	Frequency error		Limit (ppm)	Result
		Hz	ppm		
25	13.2	24	0.0139	2.5	Pass
	12.0	17	0.0098		
	10.8	20	0.0115		
Reference Frequency: LTE Band 13 Middle channel=23230channel=782MHz					
Temperature (°C)	Power supplied (Vdc)	Frequency error		Limit (ppm)	Result
		Hz	ppm		
25	13.2	25	0.0320	2.5	Pass
	12.0	31	0.0396		
	10.8	35	0.0448		

16QAM mode:

Reference Frequency: LTE Band 4 Middle channel=20175 channel=1732.5MHz					
Temperature (°C)	Power supplied (Vdc)	Frequency error		Limit (ppm)	Result
		Hz	ppm		
25	13.2	29	0.0371	2.5	Pass
	12.0	21	0.0269		
	10.8	24	0.0307		
Reference Frequency: LTE Band 13 Middle channel=23230channel=782MHz					
Temperature (°C)	Power supplied (Vdc)	Frequency error		Limit (ppm)	Result
		Hz	ppm		
25	13.2	28	0.0162	2.5	Pass
	12.0	34	0.0196		
	10.8	39	0.0225		

7 Test Setup Photo

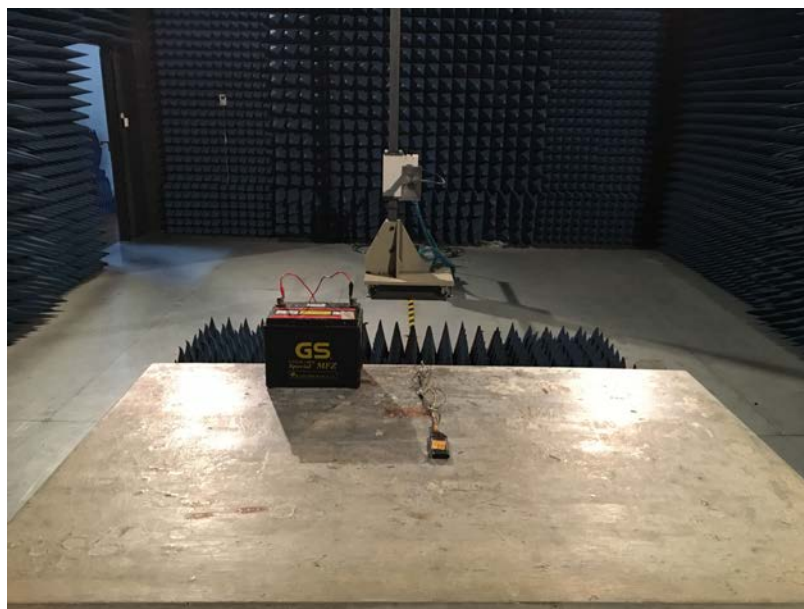

8 EUT Constructional Details





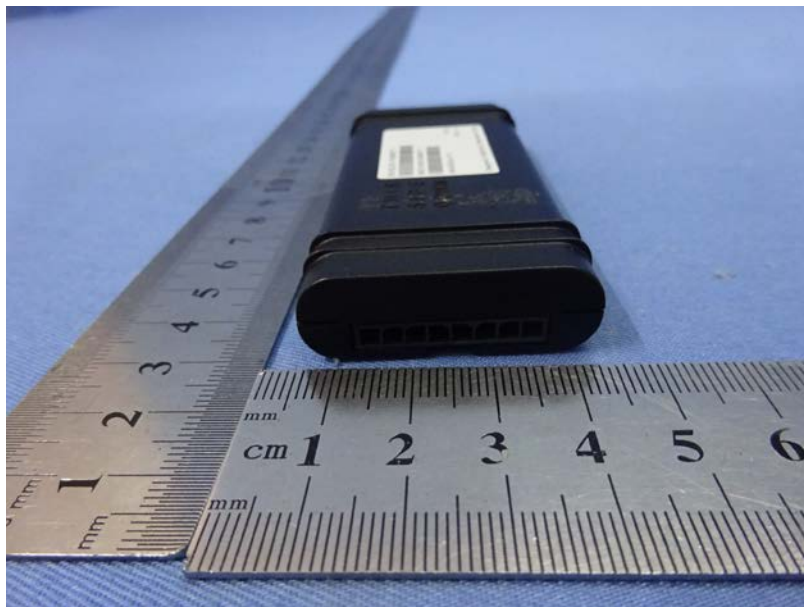

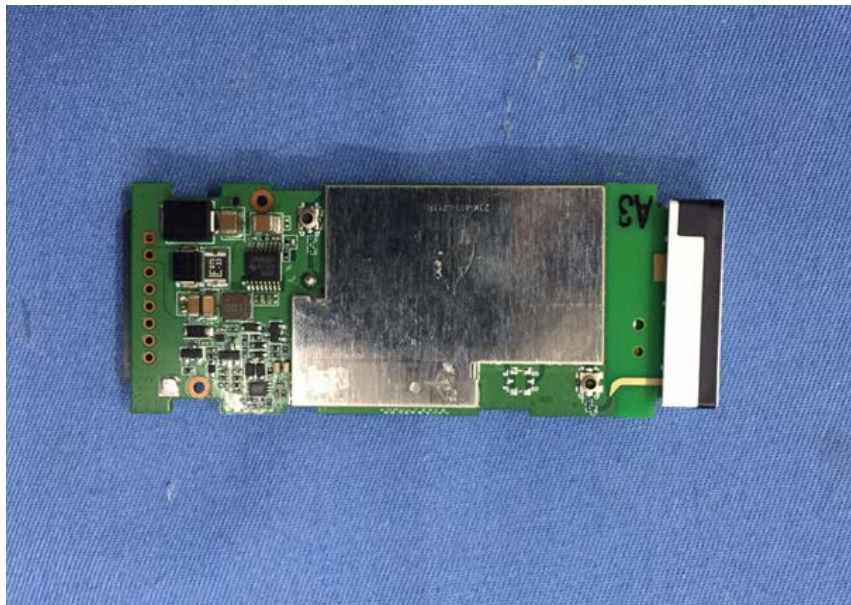



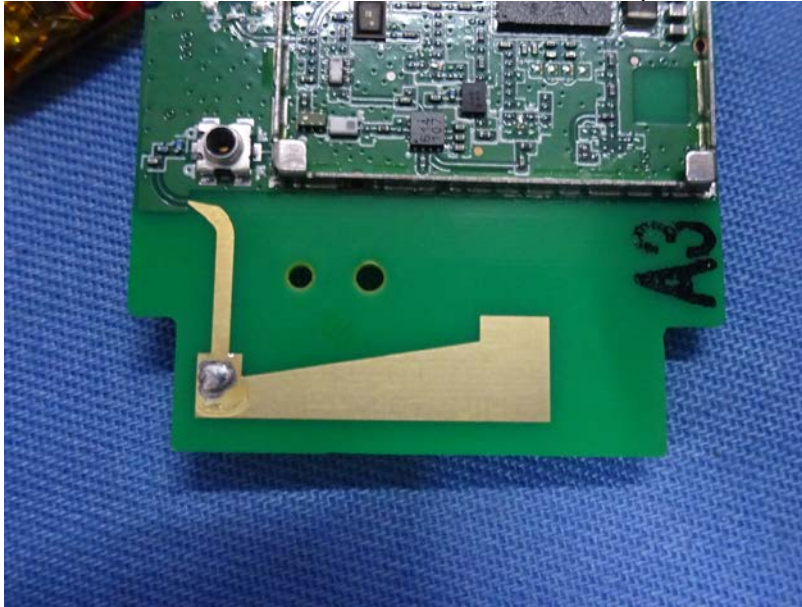



-----End-----