

FCC Report

Applicant: Connected Holdings LLC

Address of Applicant: 4740 Von Karman Avenue, Suite 120 Newport Beach, CA
92660

Equipment Under Test (EUT)

Product Name: GPS Tracker

Model No.: AR-2CX, SR-2CU , S4N-2CU , S6N-2CU, KT-2CU

FCC ID: 2AEB4AC20

Applicable standards: FCC CFR Title 47 Part 2:2014
FCC CFR Title 47 Part22 Subpart H:2014
FCC CFR Title 47 Part24 Subpart E:2014

Date of sample receipt: March 07, 2016

Date of Test: March 07-09, 2016

Date of report issued: March 10, 2016

Test Result : PASS *

* In the configuration tested, the EUT complied with the standards specified above.

2 Version

Version No.	Date	Description
00	March 10, 2016	Original

Prepared By:

Edward Pan

Date:

March 10, 2016

Project Engineer

Check By:

Hank Yan

Date:

March 10, 2016

Reviewer

3 Contents

Page

1	COVER PAGE	1
2	VERSION	2
3	CONTENTS	3
4	TEST SUMMARY	4
5	GENERAL INFORMATION	5
5.1	CLIENT INFORMATION.....	5
5.2	GENERAL DESCRIPTION OF EUT	5
5.3	RELATED SUBMITTAL(S) / GRANT (S)	6
5.4	TEST METHODOLOGY.....	6
5.5	DESCRIPTION OF SUPPORT UNITS	6
6	TEST INSTRUMENTS LIST	7
7	SYSTEM TEST CONFIGURATION	8
7.1	EUT CONFIGURATION.....	8
7.2	EUT EXERCISE	8
7.3	CONFIGURATION OF TESTED SYSTEM	8
7.4	DESCRIPTION OF TEST MODES	8
7.5	CONDUCTED PEAK OUTPUT POWER	10
7.6	OCCUPY BANDWIDTH.....	11
7.7	MODULATION CHARACTERISTIC.....	15
7.8	OUT OF BAND EMISSION AT ANTENNA TERMINALS.....	15
7.9	ERP, EIRP MEASUREMENT	19
7.10	FIELD STRENGTH OF SPURIOUS RADIATION MEASUREMENT.....	23
7.11	FREQUENCY STABILITY V.S. TEMPERATURE MEASUREMENT.....	27
7.12	FREQUENCY STABILITY V.S. VOLTAGE MEASUREMENT.....	29
8	TEST SETUP PHOTO	31
9	EUT CONSTRUCTIONAL DETAILS	32

4 Test Summary

Test Item	Section in CFR 47	Result
RF Output Power	Part 2.1046 Part 22.913 (a)(2) Part 24.232 (c)	Pass
Modulation Characteristics	Part 2.1047	Pass
99% & -26 dB Occupied Bandwidth	Part 2.1049 Part 22.917 Part 24.238	Pass
Spurious Emissions at Antenna Terminal	Part 2.1051 Part 22.917 (a) Part 24.238 (a)	Pass
Field Strength of Spurious Radiation	Part 2.1053 Part 22.917 (a) Part 24.238 (a)	Pass
Out of band emission, Band Edge	Part 22.917 (a) Part 24.238 (a)	Pass
Frequency stability vs. temperature	Part 2.1055(a)(1)(b)	Pass
Frequency stability vs. voltage	Part 2.1055(d)(1)(2)	Pass

Pass: The EUT complies with the essential requirements in the standard.

Remark :Test according to ANSI C63.4:2014.

4.1 Measurement Uncertainty

Test Item	Frequency Range	Measurement Uncertainty	Notes
Radiated Emission	9kHz ~ 30MHz	± 4.34dB	(1)
Radiated Emission	30MHz ~ 1000MHz	± 4.24dB	(1)
Radiated Emission	1GHz ~ 26.5GHz	± 4.68dB	(1)
AC Power Line Conducted Emission	0.15MHz ~ 30MHz	± 3.45dB	(1)

Note (1): The measurement uncertainty is for coverage factor of k=2 and a level of confidence of 95%.

5 General Information

5.1 Client Information

Applicant:	Connected Holdings LLC
Address of Applicant:	4740 Von Karman Avenue, Suite 120 Newport Beach, CA 92660
Manufacturer:	Asiatelco Technologies Co.
Address of Manufacturer:	#289 Bisheng Road, Building-8, 3F Zhangjiang Hi-Tech Park, Pudong, Shanghai, 201204 China

5.2 General Description of EUT

Product Name:	GPS Tracker
Model No.:	AR-2CX, SR-2CU, S4N-2CU, S6N-2CU, KT-2CU
Support Networks:	1xRTT
Support Bands:	CDMA Cellular / CDMA PCS
TX Frequency:	CDMA2000 BC0: 824.70MHz ~ 848.31MHz CDMA2000 BC1: 1851.25MHz ~ 1908.75MHz
Modulation type:	QPSK
Hardware Version:	P4
Software Version:	2.0.1
Antenna type:	Spring loaded antenna
Antenna gain:	2dBi(CDMA Cellular) 2dBi(CDMA PCS)
Power supply:	DC 12V

5.3 Related Submittal(s) / Grant (s)

This submittal(s) (test report) is filing to comply with Section Part 22 subpart H and Part 24 subpart E of the FCC CFR 47 Rules.

5.4 Test Methodology

Both conducted and radiated testing were performed according to the procedures document on TIA/EIA 603 and FCC CFR 47.1046, 2.1047, 2.1049, 2.1051, 2.1053, 2.1055 and 2.1057

5.5 Description of Support Units

Manufacturer	Description	Model	Serial Number	FCC Approval
AQUILSTAR	AC/DC Adapter	ASSA1A-120100	N/A	Verification

5.6 Test Location

All tests were performed at:
Global United Technology Services Co., Ltd.

FCC Registration No.: 600491

No. 301-309, 3/F., Jinyuan Business Building, No.2, Laodong Industrial Zone, Xixiang Road, Baoan District, Shenzhen, Guangdong, China

Tel: 0755-27798480

Fax: 0755-27798960

6 Test Instruments list

Item	Test Equipment	Manufacturer	Model No.	Inventory No.	Cal.Date (mm-dd-yy)	Cal.Due date (mm-dd-yy)
1	3m Semi- Anechoic Chamber	ZhongYu Electron	9.2(L)*6.2(W)* 6.4(H)	GTS250	Mar. 27 2015	Mar. 26 2016
2	Control Room	ZhongYu Electron	6.2(L)*2.5(W)* 2.4(H)	GTS251	N/A	N/A
3	EMI Test Receiver	Rohde & Schwarz	ESU26	GTS203	June 30 2015	June 29 2016
4	BiConiLog Antenna	SCHWARZBECK MESS-ELEKTRONIK	VULB9163	GTS214	June 30 2015	June 29 2016
5	Double -ridged waveguide horn	SCHWARZBECK MESS-ELEKTRONIK	9120D-829	GTS208	June 26 2015	June 25 2016
6	Horn Antenna	ETS-LINDGREN	3160	GTS217	Mar. 27 2015	Mar. 26 2016
7	EMI Test Software	AUDIX	E3	N/A	N/A	N/A
8	Coaxial Cable	GTS	N/A	GTS213	Mar. 28 2015	Mar. 27 2016
9	Coaxial Cable	GTS	N/A	GTS211	Mar. 28 2015	Mar. 27 2016
10	Coaxial cable	GTS	N/A	GTS210	Mar. 28 2015	Mar. 27 2016
11	Coaxial Cable	GTS	N/A	GTS212	Mar. 28 2015	Mar. 27 2016
12	Amplifier(100kHz-3GHz)	HP	8347A	GTS204	June 30 2015	June 29 2016
13	Amplifier(2GHz-20GHz)	HP	8349B	GTS206	June 30 2015	June 29 2016
14	Amplifier (18-26GHz)	Rohde & Schwarz	AFS33-18002 650-30-8P-44	GTS218	June 26 2015	June 25 2016
15	Band filter	Amindeon	82346	GTS219	Mar. 28 2015	Mar. 27 2016
16	Universal radio communication tester	Rohde & Schwarz	CMU200	GTS235	Mar. 28 2015	May 27 2016
17	Signal Generator	Rohde & Schwarz	SML03	GTS236	Mar. 28 2015	May 27 2016
18	Temp. Humidity/ Barometer	Oregon Scientific	BA-888	GTS248	Mar. 28 2015	May 27 2016
19	D.C. Power Supply	Instek	PS-3030	GTS232	NA	NA
20	Splitter	Agilent	11636B	GTS237	Mar. 28 2015	May 27 2016
21	Power meter	Rohde & Schwarz	NRVS	GTS238	Mar. 28 2015	May 27 2016
22	Spectrum Analyzer	Agilent	E4440A	GTS533	Dec. 3 2015	Dec. 2 2016

7 System test configuration

7.1 EUT Configuration

The EUT configuration for testing is installed on RF field strength measurement to meet the Commissions requirement and operating in a manner which intends to maximize its emission characteristics in a continuous normal application.

7.2 EUT Exercise

The EUT (Transmitter) was operated in the engineering mode to fix the Tx frequency which was for the purpose of the measurements.

7.3 Configuration of Tested System

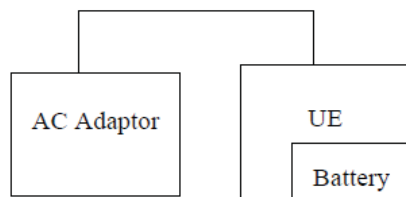

Remote Side

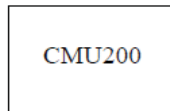

7.4 Description of Test modes

During all testing, EUT is in link mode with base station emulator at maximum power level. The spurious emission measurements were carried out in semi-anechoic chamber with 3-meter test range, and EUT is rotated on three test planes to find out the worst emission.

Frequency range investigated for radiated emission is as follows:

30 MHz to 10000 MHz for CDMA2000 BC0.

30 MHz to 20000 MHz for CDMA2000 BC1.

Test modes		
Band	Radiated	Conducted
CDMA2000 BC0	1XRTT Link Mode	1XRTT Link Mode
CDMA2000 BC1	1XRTT Link Mode	1XRTT Link Mode

Note: The maximum RF output power levels are 1xRTT RC3 SO32 (+F-SCH) mode for CDMA2000 BC0 and 1xRTT RC1 SO55 mode for CDMA2000 BC1 on QPSK Link; only these modes were used for all tests.

The conducted power tables are as follows:

Conducted Power (dBm)						
Band	CDMA2000 BC0			CDMA2000 BC1		
Channel	1013	384	777	25	600	1175
Frequency (MHz)	824.70	836.52	848.31	1851.25	1880.00	1908.75
1xRTT RC1 SO55	23.30	23.57	23.47	23.34	23.29	23.33
1xRTT RC3 SO55	23.34	23.66	23.62	23.27	23.19	23.21
1xRTT RC3 SO32 (+F-SCH)	23.47	23.97	23.84	23.07	23.11	23.02
1xRTT RC3 SO32 (+SCH)	23.30	23.71	23.53	23.30	23.26	23.13

7.5 Conducted Peak Output Power

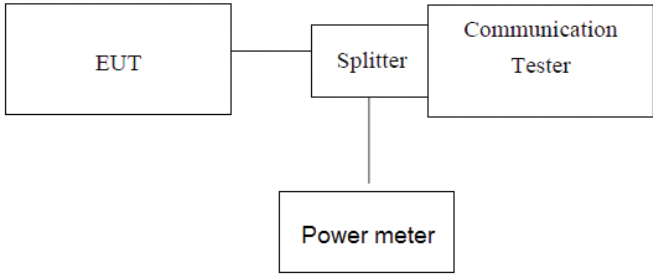
Test Requirement:	FCC part22.913(a) and FCC part24.232(b)
Test Method:	FCC part2.1046
Test setup:	 <p style="text-align: center;"><i>Note: Measurement setup for testing on Antenna connector</i></p>
Test Procedure:	<ol style="list-style-type: none"> 1. The transmitter output port was connected to base station. 2. The RF output of EUT was connected to the power meter by RF cable and attenuator, the path loss was compensated to the results for each measurement. 3. Set EUT at maximum power through base station. 4. Select lowest, middle, and highest channels for each band and different modulation. 5. Measure the maximum burst average power.
Test Instruments:	Refer to section 6.0 for details
Test mode:	Refer to section 7.4 for details
Test results:	Pass

Measurement Data

EUT Mode	Channel	Frequency (MHz)	PK power (dBm)
CDMA2000 BC0	1013	824.70	23.47
	384	836.52	23.97
	777	848.31	23.84
CDMA2000 BC1	25	1851.25	23.34
	600	1880.00	23.29
	1175	1908.75	23.33

7.6 Occupy Bandwidth

Test Requirement:	FCC part22.913(a) and FCC part24.232(b)
Test Method:	FCC part2.1049
Test setup:	<pre> graph LR EUT[EUT] --- Splitter[Splitter] Splitter --- CT[Communication Tester] Splitter --- SPA[SPA] </pre> <p><i>Note: Measurement setup for testing on Antenna connector</i></p>
Test Procedure:	<ol style="list-style-type: none"> 1. The EUT's output RF connector was connected with a short cable to the spectrum analyzer 2. RBW was set to about 1% of emission BW, VBW= 3 times RBW. 3. -26dBc display line was placed on the screen (or 99% bandwidth), the occupied bandwidth is the delta frequency between the two points where the display line intersects the signal trace.
Test Instruments:	Refer to section 6.0 for details
Test mode:	Refer to section 5.3 for details
Test results:	Pass

Measurement Data

EUT Mode	Channel	Frequency (MHz)	99% Occupy bandwidth (MHz)	-26dB bandwidth (MHz)
CDMA2000 BC0	1013	824.70	1.2587	1.415
	384	836.52	1.2629	1.428
	777	848.31	1.2631	1.430
CDMA2000 BC1	25	1851.25	1.2691	1.435
	600	1880.00	1.2657	1.427
	1175	1908.75	1.2657	1.430

Test plot as follows:

Test band: CDMA2000 BC0 (1xRTT RC3 SO32 (+F-SCH))

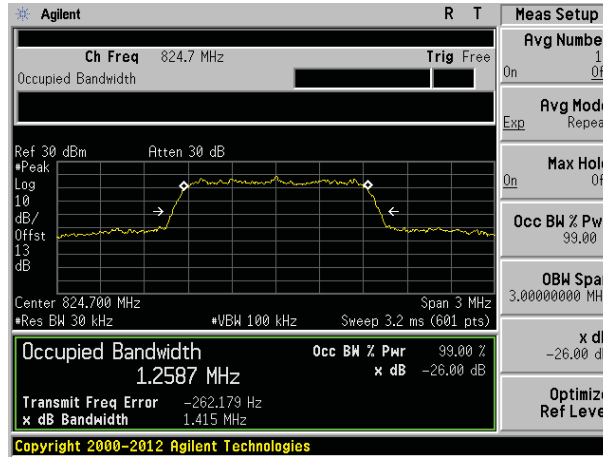

Lowest channel

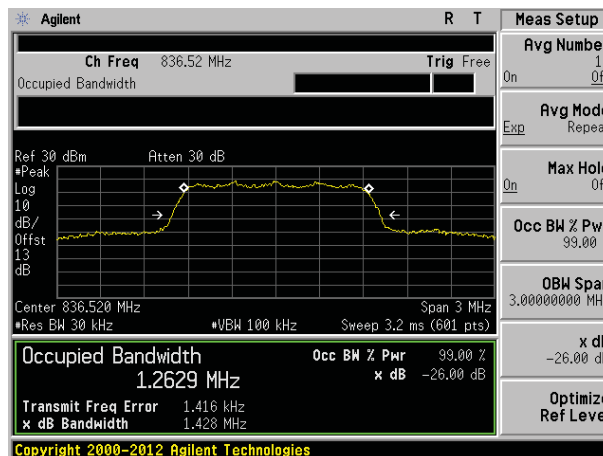

Middle channel

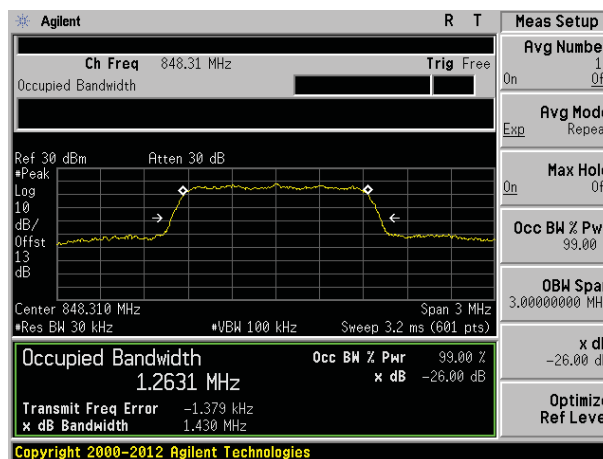

Highest channel

Test band: CDMA2000 BC1 (1xRTT RC1 SO55)

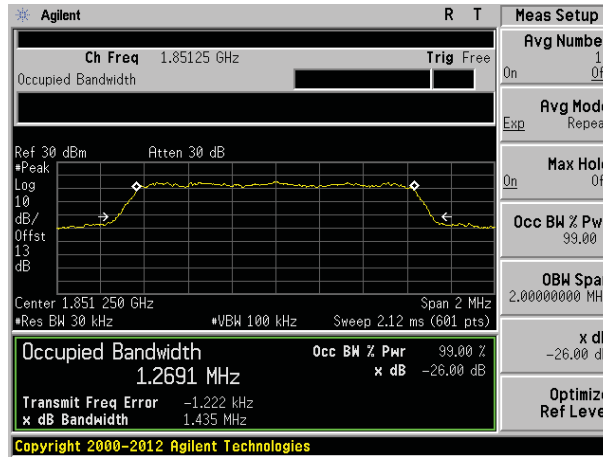

Lowest channel

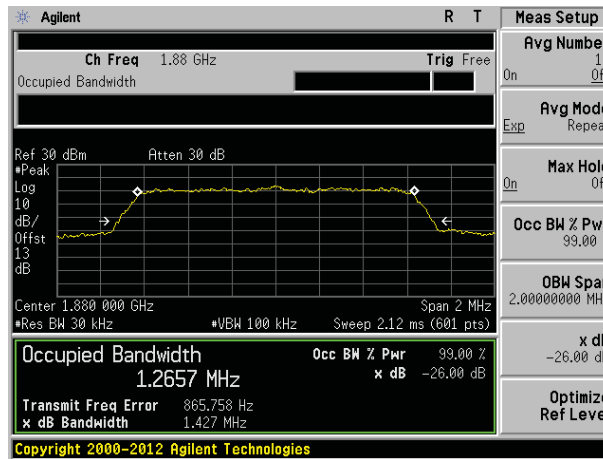

Middle channel

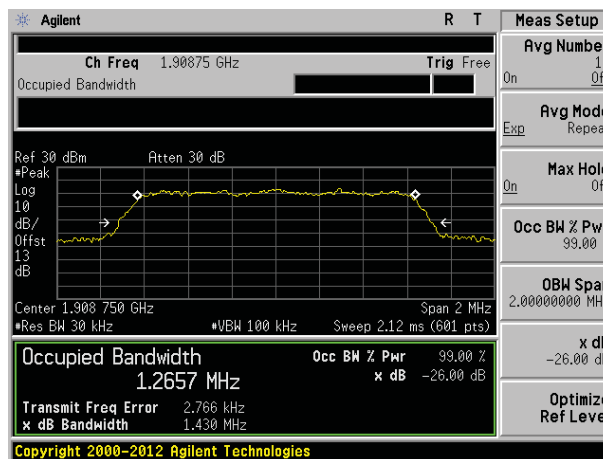

Highest channel

7.7 MODULATION CHARACTERISTIC

According to FCC § 2.1047(d), Part 22H & 24E there is no specific requirement for digital modulation, therefore modulation characteristic is not presented.

7.8 Out of band emission at antenna terminals

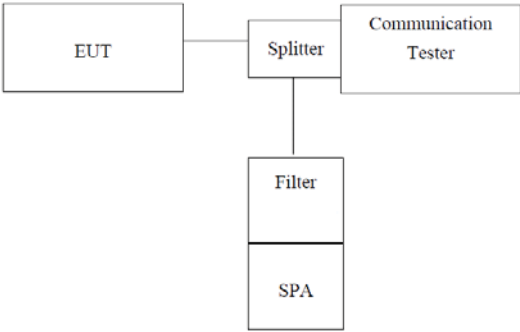
Test Requirement:	FCC part22.917(a) and FCC part24.238(a)
Test Method:	FCC part2.1051
Limit:	-13dBm
Test setup:	 <p style="text-align: center;"><i>Note: Measurement setup for testing on Antenna connector</i></p>
Test Procedure:	<ol style="list-style-type: none"> 1 The RF output of the transceiver was connected to a spectrum analyzer through appropriate attenuation. 2 The resolution bandwidth of the spectrum analyzer was set at 1MHz, sufficient scans were taken to show the out of band Emissions if any up to 10th harmonic. 3 For the out of band: Set the RBW, VBW = 1MHz, Start=30MHz, Stop= 10th harmonic. 4 Band Edge Requirements: In the 1 MHz bands immediately outside and adjacent to the frequency block, a resolution bandwidth of at least 1 percent of the emission bandwidth of the fundamental emission of the transmitter may be employed to measure the out of band Emissions.
Test Instruments:	Refer to section 6.0 for details
Test mode:	Refer to section 5.3 for details
Test results:	Pass

Test plot as follows:

Test Mode: 1xRTT RC3 SO32 (+F-SCH)	CDMA2000 BC0
------------------------------------	--------------

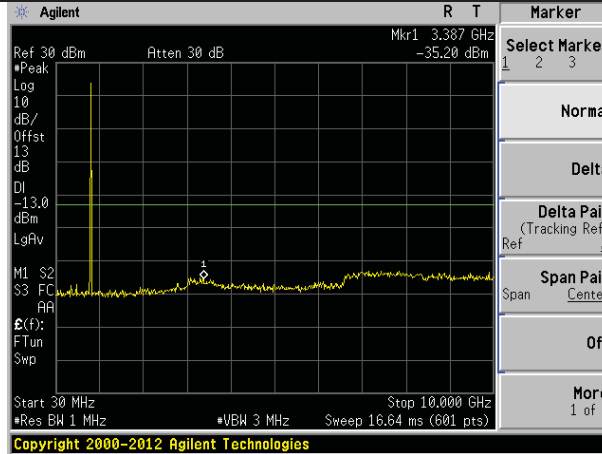

Lowest channel

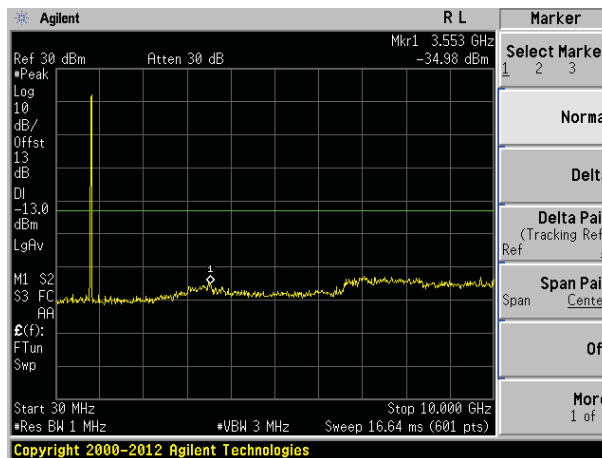

Middle channel

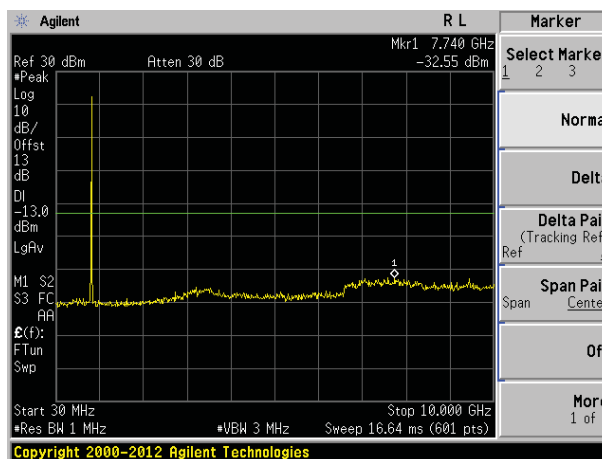

Highest channel

Test Mode: 1xRTT RC1 SO55 CDMA2000 BC1

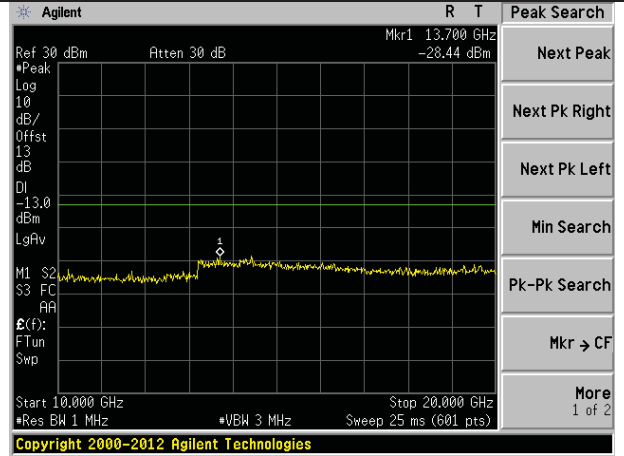
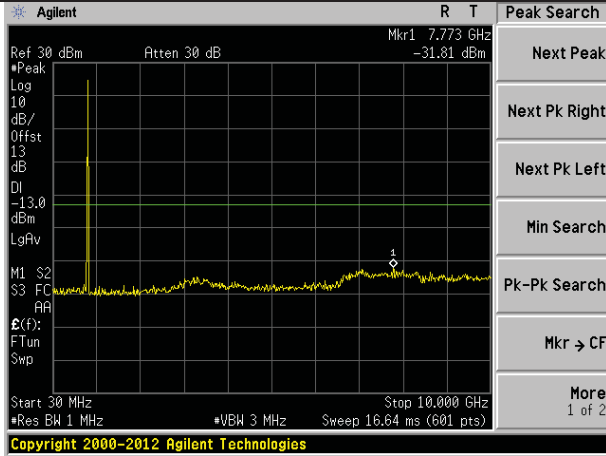

Lowest channel

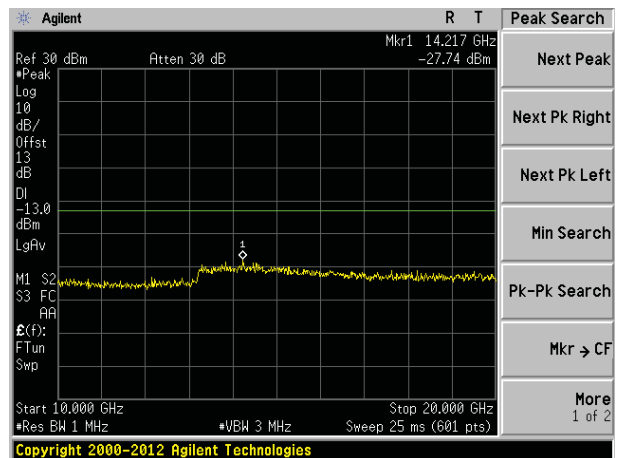
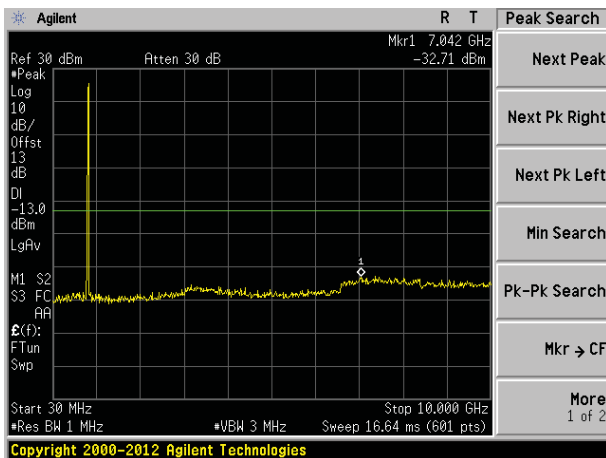

Middle channel

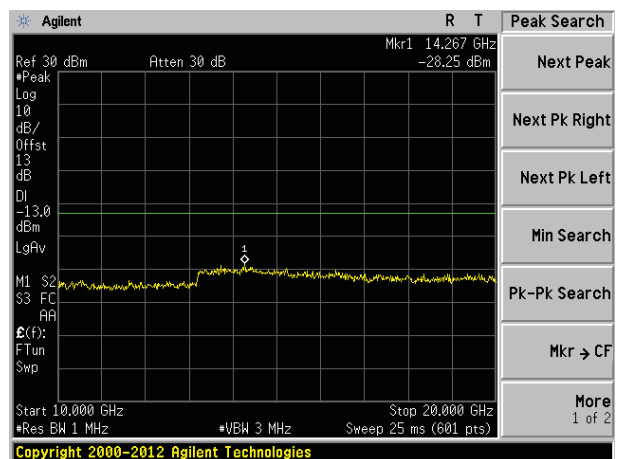
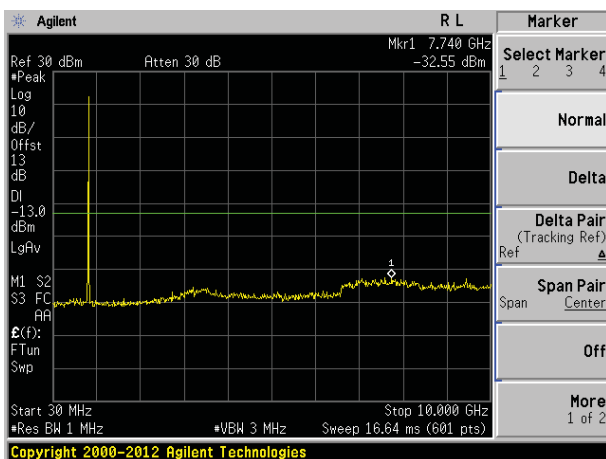

Highest channel

Band Edge:

Test Mode: 1xRTT RC3 SO32 (+F-SCH) CDMA2000 BC0

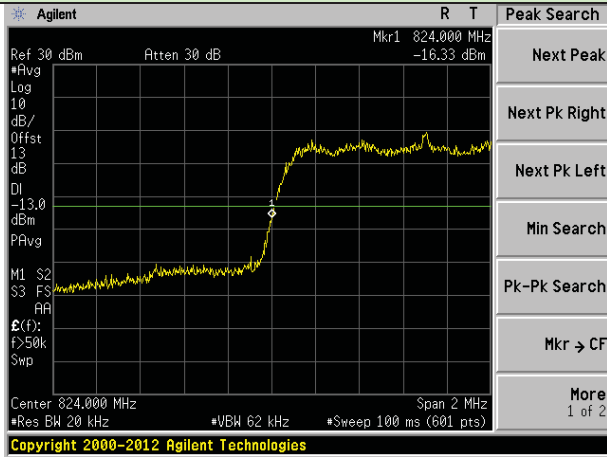

Lowest channel

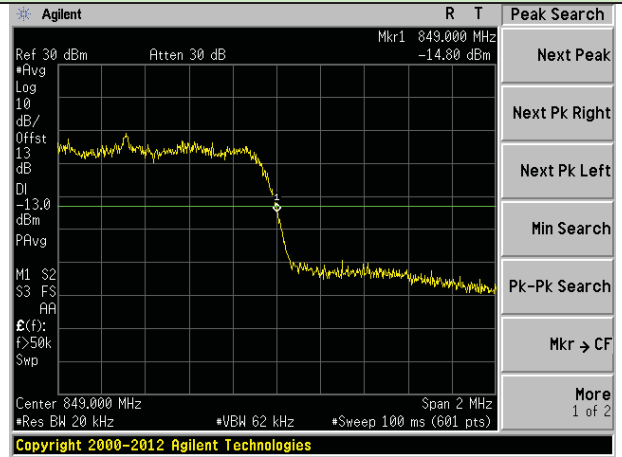

Highest channel

Test Mode: 1xRTT RC1 SO55 CDMA2000 BC1

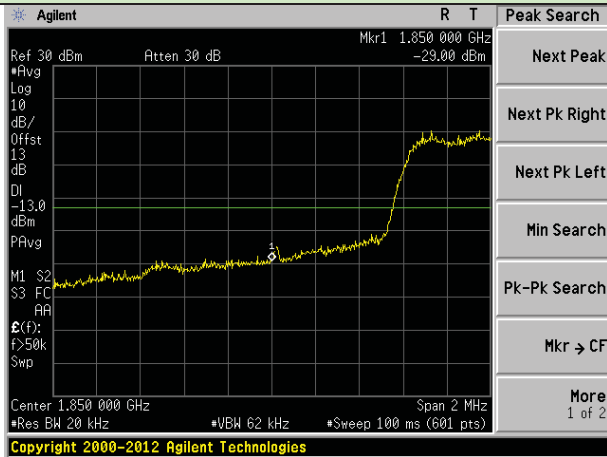

Lowest channel

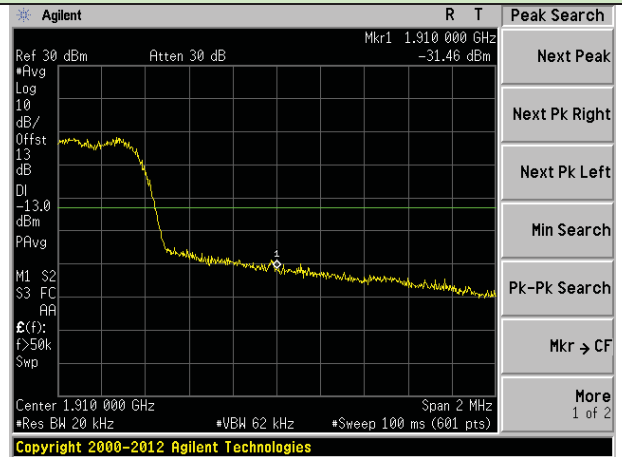

Highest channel

7.9 ERP, EIRP Measurement

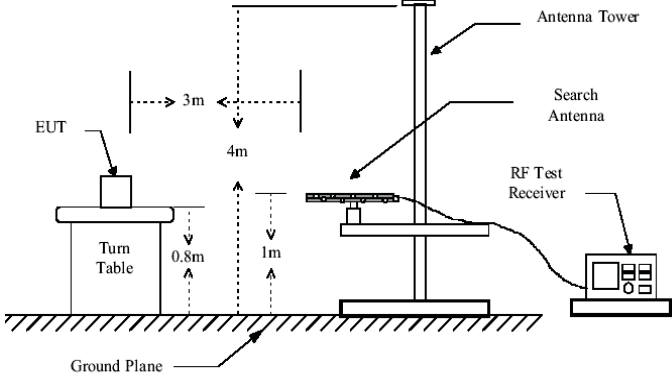
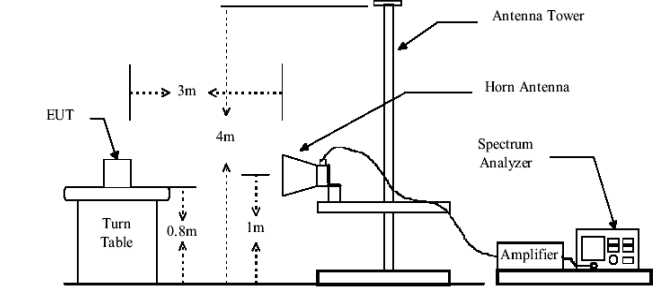
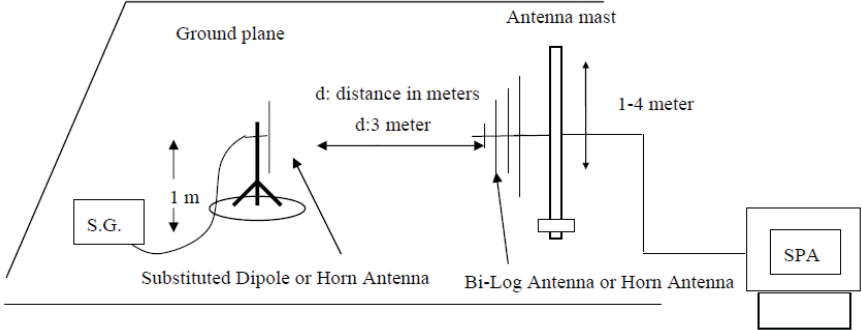
Test Requirement:	FCC part22.913(a) and FCC part24.232(b)
Test Method:	FCC part2.1046
Limit:	CDMA2000 BC0 7W ERP CDMA2000 BC1 2W EIRP
Test setup:	<p>Below 1GHz</p>  <p>Above 1GHz</p>  <p>Substituted method:</p> 

Test Procedure:	<ol style="list-style-type: none"> 1. The EUT was placed on a non-conductive turntable using a non-conductive support. The radiated emission at the fundamental frequency was measured at 3 m with a test antenna and EMI spectrum analyzer. 2. During the measurement, the EUT was in communication with the station. The highest emission was recorded with the rotation of the turntable and the lowering of the test antenna from 4m to 1m. The reading was recorded and the field strength (E in dBuV/m) was calculated. 3. ERP in frequency band 824.2 –848.80.8MHz were measured using a substitution method. The EUT was replaced by a dipole antenna connected, the S.G. output was recorded and ERP was calculated as follows: $\text{ERP} = \text{S.G. output (dBm)} + \text{Antenna Gain (dBd)} - \text{Cable Loss (dB)}$ 4. EIRP in frequency band 1850.2 –1909.8MHz were measured using a substitution method. The EUT was replaced by a horn antenna connected, the S.G. output was recorded and EIRP was calculated as follows: $\text{EIRP} = \text{S.G. output (dBm)} + \text{Antenna Gain (dBi)} - \text{Cable Loss (dB)}$
Test Instruments:	Refer to section 6.0 for details
Test mode:	Refer to section 5.3 for details
Test results:	Pass

Measurement Data

EUT mode	Channel	EUT Pol.	Antenna Pol.	ERP(dBm)	Limit (dBm)	Result
CDMA2000 BC0 (1xRTT RC3 SO32 (+F-SCH))	Lowest	H	V	24.63	38.45	Pass
			H	22.65		
		E1	V	19.22		
			H	22.77		
		E2	V	18.64		
			H	21.27		
	Middle	H	V	24.72	38.45	Pass
			H	22.72		
		E1	V	19.36		
			H	22.93		
		E2	V	19.82		
			H	21.76		
	Highest	H	V	23.60	38.45	Pass
			H	21.21		
		E1	V	17.97		
			H	20.88		
		E2	V	17.31		
			H	20.76		

EUT mode	Channel	EUT Pol.	Antenna Pol.	EIRP(dBm)	Limit (dBm)	Result
CDMA2000 BC1 (1xRTT RC1 SO55)	Lowest	H	V	23.86	33.00	Pass
			H	21.78		
		E1	V	18.25		
			H	21.70		
		E2	V	17.47		
			H	20.00		
	Middle	H	V	23.60	33.00	Pass
			H	21.38		
		E1	V	17.89		
			H	21.36		
		E2	V	18.50		
			H	20.34		
	Highest	H	V	23.49	33.00	Pass
			H	20.01		
		E1	V	16.68		
			H	19.48		
		E2	V	16.37		
			H	19.71		

7.10 Field strength of spurious radiation measurement

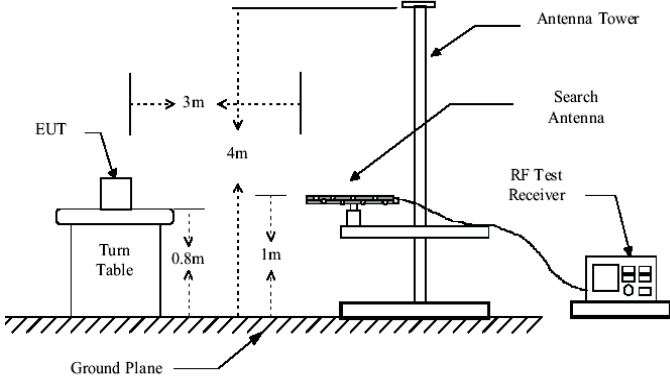
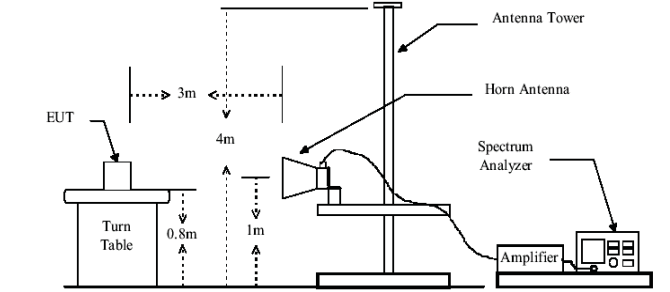
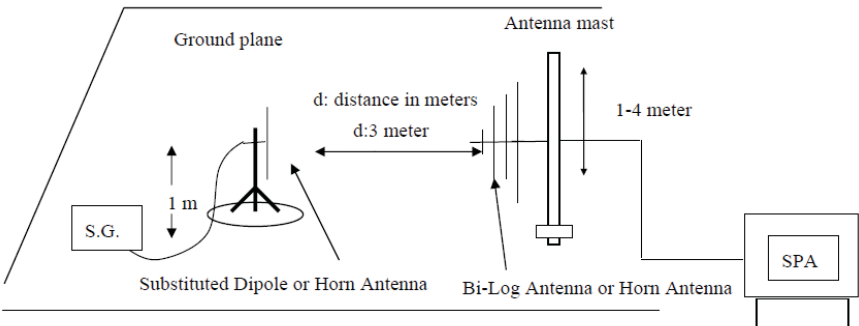
Test Requirement:	FCC part22.917(a) and FCC part24.238(a)
Test Method:	FCC part2.1053
Limit:	-13dBm
Test setup:	<p>Below 1GHz</p>  <p>Above 1GHz</p>  <p>Substituted method:</p> 

Test Procedure:	<ol style="list-style-type: none"> 1. The EUT was placed on a non-conductive turntable using a non-conductive support. The radiated emission at the fundamental frequency was measured at 3 m with a test antenna and EMI spectrum analyzer. 2. During the tests, the antenna height and the EUT azimuth were varied in order to identify the maximum level of emissions from the EUT. This maximization process was repeated with the EUT positioned in each of its three orthogonal orientations. 3. The frequency range up to tenth harmonic was investigated for each of three fundamental frequency (low, middle and high channels). Once spurious emission was identified, the power of the emission was determined using the substitution method. 4. The spurious emissions attenuation was calculated as the difference between radiated power at the fundamental frequency and the spurious emissions frequency. $\text{ERP / EIRP} = \text{S.G. output (dBm)} + \text{Antenna Gain(dB/dBi)} - \text{Cable Loss (dB)}$
Test Instruments:	Refer to section 6.0 for details
Test mode:	Refer to section 5.3 for details
Test results:	Pass

Measurement Data

Test mode:	CDMA2000 BC0 (1xRTT RC3 SO32 (+F-SCH))		Test channel:	Lowest
Frequency (MHz)	Spurious Emission		Limit (dBm)	Result
	Polarization	Level (dBm)		
1649.40	Vertical	-36.13	-13.00	Pass
2474.10	V	-38.86		
3298.80	V	-41.11		
4123.50	V	-43.27		
4948.20	V	---		
1649.40	Horizontal	-41.35	-13.00	Pass
2474.10	H	-45.21		
3298.80	H	-46.77		
4123.50	H	-49.50		
4948.20	H	---		
Test mode:	CDMA2000 BC0 (1xRTT RC3 SO32 (+F-SCH))		Test channel:	Middle
Frequency (MHz)	Spurious Emission		Limit (dBm)	Result
	Polarization	Level (dBm)		
1673.04	Vertical	-37.46	-13.00	Pass
2509.56	V	-39.73		
3346.08	V	-41.62		
4182.60	V	-43.42		
5019.12	V	---		
1673.04	Horizontal	-41.82	-13.00	Pass
2509.56	H	-45.04		
3346.08	H	-46.34		
4182.60	H	-48.61		
5019.12	H	---		
Test mode:	CDMA2000 BC0 (1xRTT RC3 SO32 (+F-SCH))		Test channel:	Highest
Frequency (MHz)	Spurious Emission		Limit (dBm)	Result
	Polarization	Level (dBm)		
1696.62	Vertical	-37.67	-13.00	Pass
2544.93	V	-39.69		
3393.24	V	-41.36		
4241.55	V	-42.97		
5089.86	V	---		
1696.62	Horizontal	-41.55	-13.00	Pass
2544.93	H	-44.41		
3393.24	H	-45.57		
4241.55	H	-47.59		
5089.86	H	---		

Test mode:	CDMA2000 BC1 (1xRTT RC1 SO55)		Test channel:	Lowest
Frequency (MHz)	Spurious Emission		Limit (dBm)	Result
	Polarization	Level (dBm)		
3702.50	Vertical	-36.96	-13.00	Pass
5553.75	V	-39.35		
7405.00	V	-41.32		
9256.25	V	-43.22		
11107.50	V	---		
3702.50	Horizontal	-41.54	-13.00	Pass
5553.75	H	-44.92		
7405.00	H	-46.28		
9256.25	H	-48.65		
11107.50	H	---		
Test mode:	CDMA2000 BC1 (1xRTT RC1 SO55)		Test channel:	Middle
Frequency (MHz)	Spurious Emission		Limit (dBm)	Result
	Polarization	Level (dBm)		
3760.00	Vertical	-34.64	-13.00	Pass
5640.00	V	-37.11		
7520.00	V	-39.15		
9400.00	V	-41.12		
11280.00	V	---		
3760.00	Horizontal	-39.39	-13.00	Pass
5640.00	H	-42.87		
7520.00	H	-44.29		
9400.00	H	-46.75		
11280.00	H	---		
Test mode:	CDMA2000 BC1 (1xRTT RC1 SO55)		Test channel:	Highest
Frequency (MHz)	Spurious Emission		Limit (dBm)	Result
	Polarization	Level (dBm)		
3817.50	Vertical	-35.84	-13.00	Pass
5726.25	V	-38.23		
7635.00	V	-40.21		
9543.75	V	-42.11		
11452.50	V	---		
3817.50	Horizontal	-40.43	-13.00	Pass
5726.25	H	-43.82		
7635.00	H	-45.18		
9543.75	H	-47.56		
11452.50	H	---		

Remark:

1. The emission behaviour belongs to narrowband spurious emission.
2. Remark"---" means that the emission level is too low to be measured
3. The emission levels of below 1 GHz are very lower than the limit and not show in test report.

7.11 Frequency stability V.S. Temperature measurement

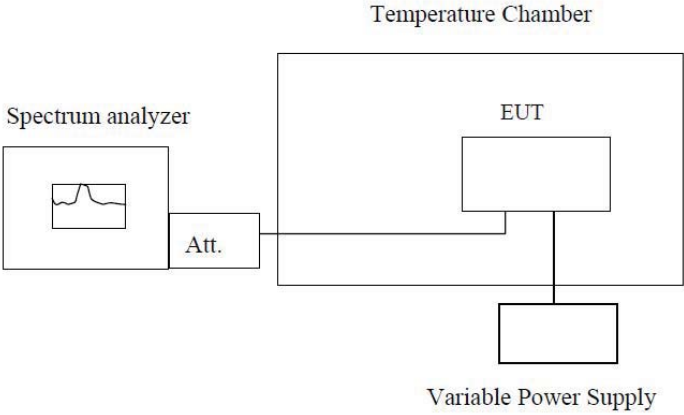
Test Requirement:	FCC Part2.1055(a)(1)(b)
Test Method:	FCC Part2.1055(a)(1)(b)
Limit:	2.5ppm
Test setup:	 <p style="text-align: center;">Temperature Chamber</p> <p style="text-align: center;">Spectrum analyzer</p> <p style="text-align: center;">Att.</p> <p style="text-align: center;">EUT</p> <p style="text-align: center;">Variable Power Supply</p> <p>Note : Measurement setup for testing on Antenna connector</p>
Test procedure:	<ol style="list-style-type: none"> 1. The equipment under test was connected to an external DC power supply and input rated voltage. 2. RF output was connected to a frequency counter or spectrum analyzer via feed through attenuators. 3. The EUT was placed inside the temperature chamber. 4. Set the spectrum analyzer RBW low enough to obtain the desired frequency resolution and measure EUT 25°C operating frequency as reference frequency. 5. Turn EUT off and set the chamber temperature to -20°C. After the temperature stabilized for approximately 30 minutes recorded the frequency. 6. Repeat step measure with 10°C increased per stage until the highest temperature of +50°C reached.
Test Instruments:	Refer to section 6.0 for details
Test mode:	Refer to section 5.3 for details
Test results:	Pass

Measurement Data

Reference Frequency: CDMA2000 BC0 (1xRTT RC3 SO32 (+F-SCH)) Middle channel=384 channel=836.52MHz					
Power supplied (Vdc)	Temperature (°C)	Frequency error		Limit (ppm)	Result
		Hz	ppm		
12.0	-30	37	0.0447	2.5	Pass
	-20	41	0.0493		
	-10	36	0.0431		
	0	31	0.0370		
	10	35	0.0416		
	20	31	0.0370		
	30	46	0.0555		
	40	43	0.0509		
	50	41	0.0493		
Reference Frequency: CDMA2000 BC1 (1xRTT RC1 SO55) Middle channel=600 channel=1880.00MHz					
Power supplied (Vdc)	Temperature (°C)	Frequency error		Limit (ppm)	Result
		Hz	ppm		
12.0	-30	56	0.0296	2.5	Pass
	-20	70	0.0370		
	-10	56	0.0296		
	0	44	0.0234		
	10	56	0.0296		
	20	46	0.0246		
	30	86	0.0457		
	40	72	0.0382		
	50	67	0.0358		

7.12 Frequency stability V.S. Voltage measurement

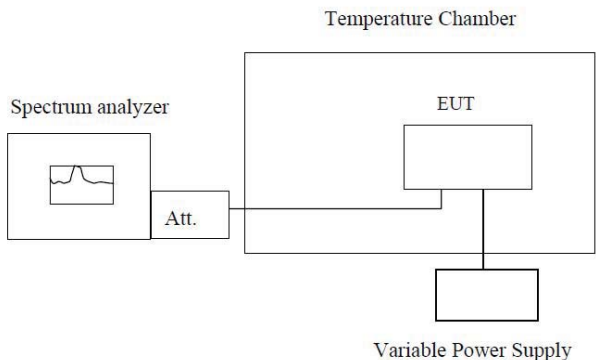
Test Requirement:	FCC Part2.1055(d)(1)(2)
Test Method:	FCC Part2.1055(d)(1)(2)
Limit:	2.5ppm
Test setup:	 <p style="text-align: center;">Temperature Chamber</p> <p style="text-align: center;">Spectrum analyzer Att. EUT</p> <p style="text-align: center;">Variable Power Supply</p> <p>Note : Measurement setup for testing on Antenna connector</p>
Test procedure:	<ol style="list-style-type: none"> 1. Set chamber temperature to 25°C. Use a variable DC power source to power the EUT and set the voltage to rated voltage. 2. Set the spectrum analyzer RBW low enough to obtain the desired frequency resolution and recorded the frequency. 3. Reduce the input voltage to specified extreme voltage variation (+/- 15%) and endpoint, record the maximum frequency change.
Test Instruments:	Refer to section 6.0 for details
Test mode:	Refer to section 5.3 for details
Test results:	Pass

Measurement Data

Reference Frequency: CDMA2000 BC0 (1xRTT RC3 SO32 (+F-SCH)) Middle channel=384 channel=836.52MHz					
Temperature (°C)	Power supplied (Vdc)	Frequency error		Limit (ppm)	Result
		Hz	ppm		
25	10.2	37	0.0438	2.5	Pass
	12.0	40	0.0475		
	13.8	43	0.0512		
Reference Frequency: CDMA2000 BC1 (1xRTT RC1 SO55) Middle channel=600 channel=1880MHz					
Temperature (°C)	Power supplied (Vdc)	Frequency error		Limit (ppm)	Result
		Hz	ppm		
25	10.2	57	0.0301	2.5	Pass
	12.0	67	0.0355		
	13.8	67	0.0355		

8 Test Setup Photo

Radiated Emission

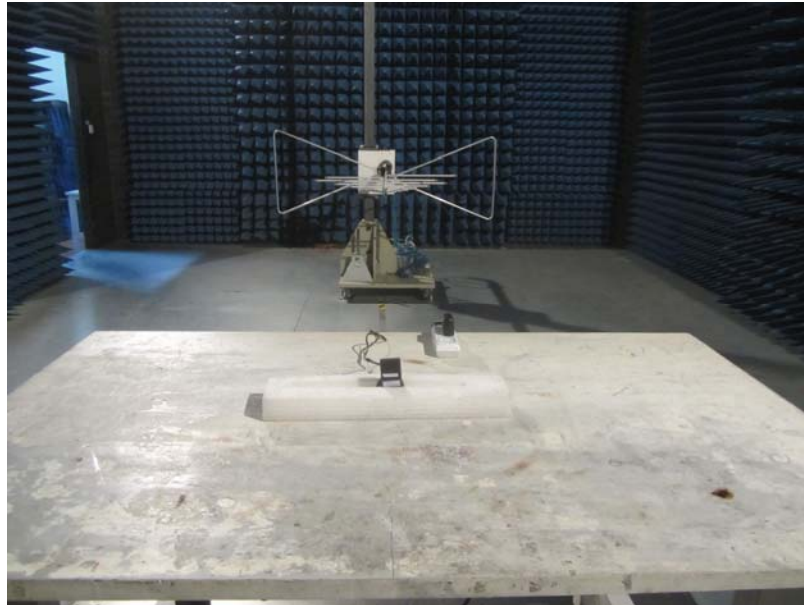

9 EUT Constructional Details

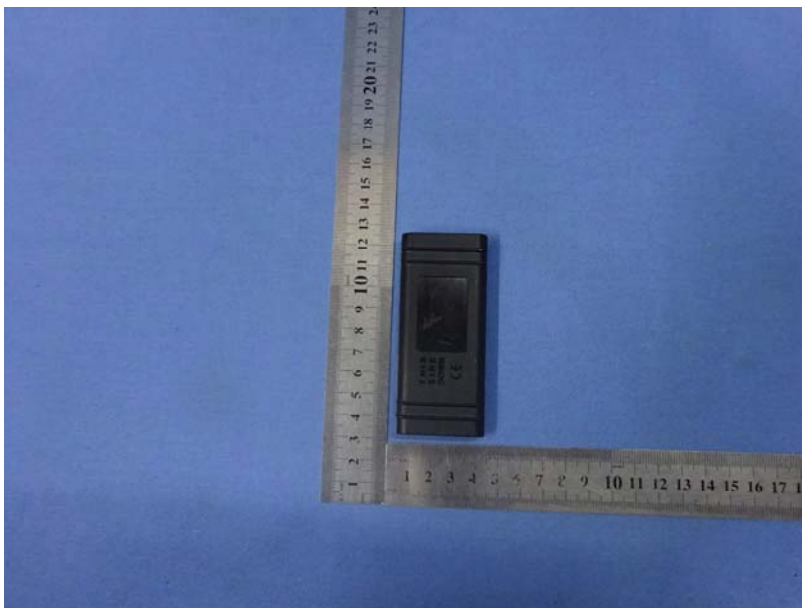

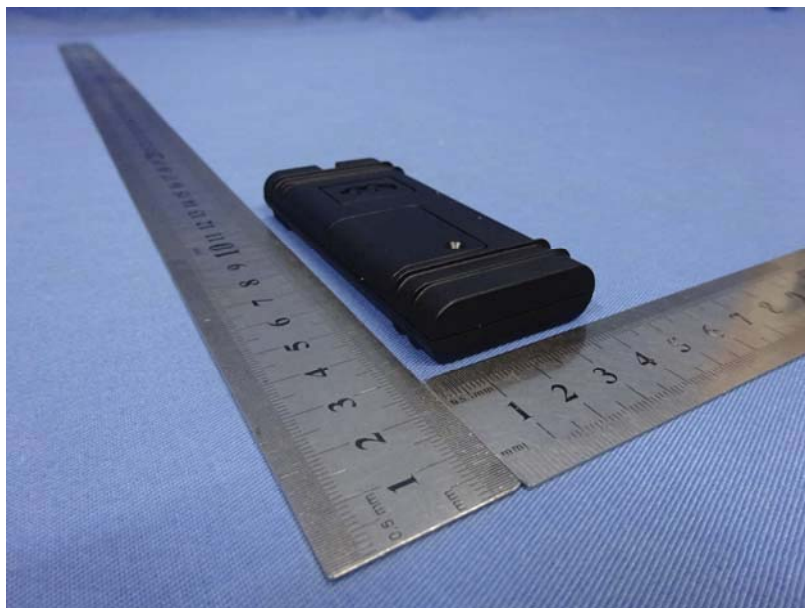

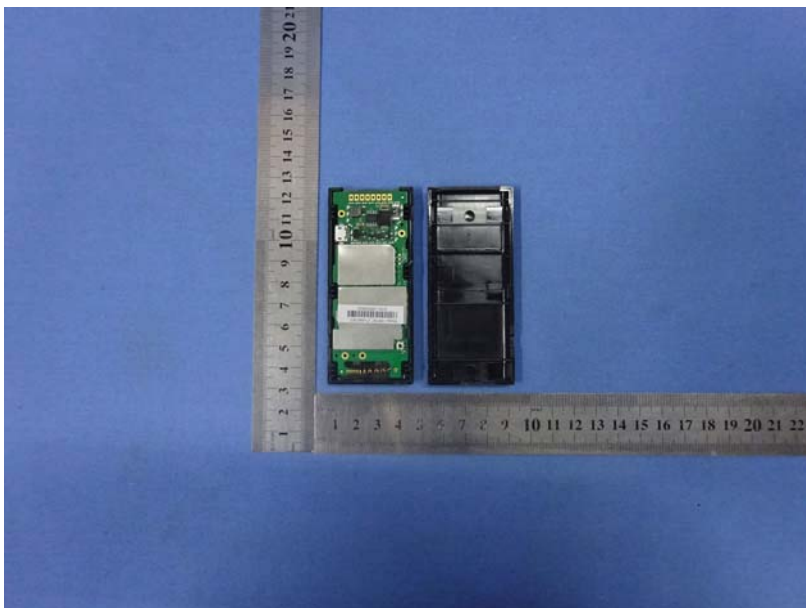
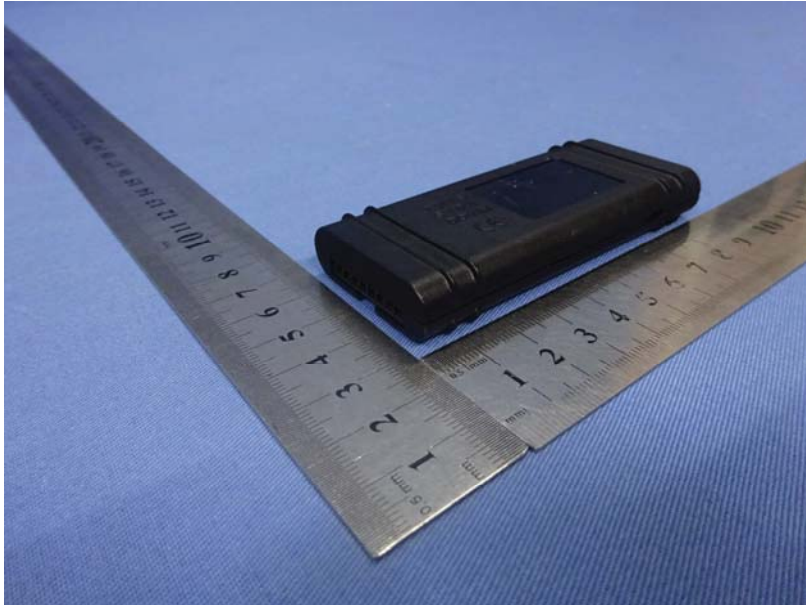

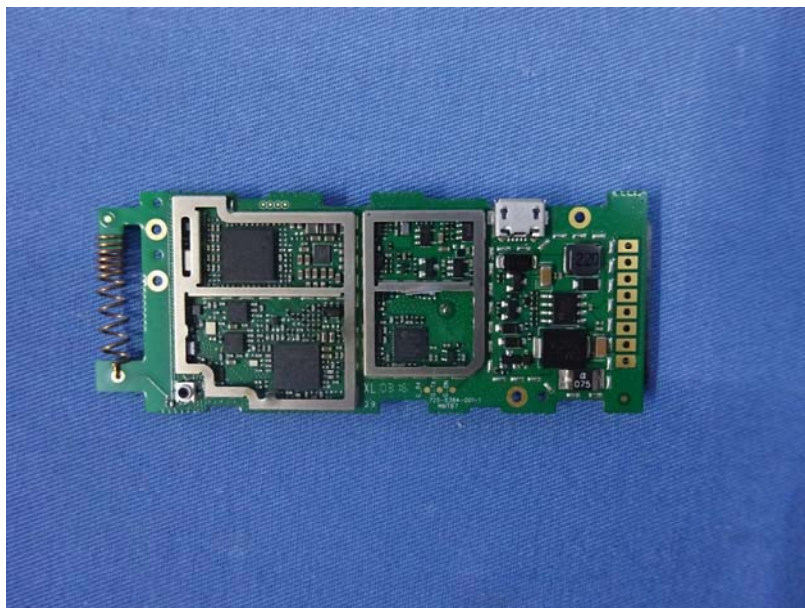



-----End-----