



FCC/IC Test Report

FOR:

Rosemount Aerospace Inc.

Model Name:
8730L1-5

Product Description:

Aircraft Interface Device

FCC ID: 2AEAK8730L1-5
IC ID: 12766A-8730L15

Per:
47 CFR Part 15.247 (DTS)
RSS-247 Issue 1 (DTS) & RSS- Gen Issue 4

Report #: EMC-UTCAE-018-16501_FCC_15.247
Date: October 19, 2016



CETECOM Inc.

411 Dixon Landing Road • Milpitas, CA 95035 • U.S.A.

Phone: + 1 (408) 586 6200 • Fax: + 1 (408) 586 6299 • E-mail: info@cetecom.com • <http://www.cetecom.com>
CETECOM Inc. is a Delaware Corporation with Corporation number: 2905571



Test Report #:	EMC-UTCAE-018-16501_FCC_15.247	FCC ID: 2AEAK870L1-5	
Date of Report	October 19, 2016	Page 2 of 39	

TABLE OF CONTENTS

1	ASSESSMENT	3
2	ADMINISTRATIVE DATA.....	4
2.1	IDENTIFICATION OF THE TESTING LABORATORY ISSUING THE EMC TEST REPORT.....	4
2.2	IDENTIFICATION OF THE CLIENT	4
2.3	IDENTIFICATION OF THE MANUFACTURER	4
3	EQUIPMENT UNDER TEST (EUT).....	5
3.1	EUT SPECIFICATIONS	5
3.2	EUT SAMPLE DETAILS.....	7
3.3	ACCESSORY EQUIPMENT (AE) DETAILS.....	7
3.1	ANCILLARY EQUIPMENT (AE) DETAILS	7
3.2	EUT SAMPLE CONFIGURATION	7
3.3	ENVIRONMENTAL CONDITIONS DURING TEST:	7
4	SUBJECT OF INVESTIGATION.....	8
5	MEASUREMENT RESULTS SUMMARY	9
6	MEASUREMENTS.....	10
6.1	MEASUREMENT UNCERTAINTY.....	10
6.2	ENVIRONMENTAL CONDITIONS DURING TESTING:.....	10
6.3	DATES OF TESTING:.....	10
7	MEASUREMENT PROCEDURES.....	11
7.1	RADIATED MEASUREMENT	11
7.2	SAMPLE CALCULATIONS FOR FIELD STRENGTH MEASUREMENTS	14
7.3	POWER LINE CONDUCTED MEASUREMENT PROCEDURE.....	14
7.4	RF CONDUCTED MEASUREMENT PROCEDURE.....	15
8	MAXIMUM CONDUCTED OUTPUT POWER VERIFICATION	16
8.1	MEASUREMENT SETTINGS.....	16
8.2	LIMITS:.....	16
8.3	TEST CONDITIONS AND SETUP:	16
8.4	MEASUREMENT RESULT:.....	17
9	RADIATED TRANSMITTER SPURIOUS EMISSIONS AND RESTRICTED BANDS	18
9.1	MEASUREMENT SETTINGS.....	18
9.2	LIMITS: §15.247/15.205/15.209.....	18
9.3	TEST CONDITIONS AND SETUP:	20
9.4	MEASUREMENT RESULT:.....	21
9.5	MEASUREMENT PLOTS:	22
10	SETUP PICTURES	37
11	TEST EQUIPMENT AND ANCILLARIES USED FOR TESTING	38
12	REVISION HISTORY	39

Test Report #:	EMC-UTCAE-018-16501_FCC_15.247	FCC ID: 2AEAK870L1-5	
Date of Report	October 19, 2016	Page 3 of 39	

1 Assessment

The following device was evaluated against the applicable criteria specified in FCC rules Parts 15.247 of Title 47 of the Code of Federal Regulations and ISED RSS-247 Issue 1.

No deviations were ascertained during the course of testing performed.

Company	Description	Model #
Rosemount Aerospace Inc.	Aircraft Interface Device	8730L1-5

Review:

October 19, 2016	Compliance	Kris Lazarov (EMC Engineer)	 Digitally signed by Kris Lazarov DN: cn=Kris Lazarov, o, ou, email=kris.lazarov@cetecom.com, c=US
Date	Section	Name	Signature

Responsible for evaluation and report:

October 19, 2016	Compliance	James Donnellan (Sr. EMC Engineer)	 Digitally signed by James Donnellan DN: cn=James Donnellan, c=US, o=Cetecom Inc., ou=Compliance, email=james.donnellan@cetecom.com Date: 2016.11.18 19:27:46 -08'00'
Date	Section	Name	Signature

The test results of this test report relate exclusively to the test item specified in Section 3.

CETECOM Inc. USA does not assume responsibility for any conclusions and generalizations drawn from the test results with regard to other specimens or samples of the type of the equipment represented by the test item. The test report may only be reproduced or published in full. Reproduction or publication of extracts from the report requires the prior written approval of CETECOM Inc. USA.

Test Report #:	EMC-UTCAE-018-16501_FCC_15.247	FCC ID: 2AEAK870L1-5	
Date of Report	October 19, 2016	Page 4 of 39	

2 Administrative Data

2.1 Identification of the Testing Laboratory Issuing the EMC Test Report

Company Name:	CETECOM Inc.
Department:	Compliance
Address:	411 Dixon Landing Road Milpitas, CA 95035 U.S.A.
Telephone:	+1 (408) 586 6200
Fax:	+1 (408) 586 6299
Manager Compliance Services:	Franz Engert
Project Engineer:	Issa Ghanma

2.2 Identification of the Client

Clients Name:	Rosemount Aerospace Inc.
Clients Address:	14300 Judicial Road
City/Zip Code	Burnsville, MN 55306
Country	USA

2.3 Identification of the Manufacturer

Manufacturer's Name:	Same as client
Manufacturers Address:	Same as client
City/Zip Code	Same as client
Country	Same as client

Test Report #:	EMC-UTCAE-018-16501_FCC_15.247	FCC ID: 2AEAK870L1-5	
Date of Report	October 19, 2016	Page 5 of 39	

3 Equipment Under Test (EUT)

3.1 EUT Specifications

Model #:	8730L1-5
HW Version :	08730-0427-0005/K
SW Version :	08730-0459-0002
FCC-ID :	2AEAK8730L1-5
HVIN:	8730L1-5
PMN:	Aircraft Interface Device
Product Description:	Aircraft Interface Device
Regulatory Band:	Nominal band: 2400 – 2483.5 MHz
Channels Used:	2412 MHz (Ch. 1) – 2462 (Ch.11), 11 channels
Type(s) of Modulation:	802.11b/g/n with CCK, DQPSK, DBPSK + DSSS QBSK, BPSK, 16 QAM, 64 QAM + OFDM
Modes of Operation:	802.11b/g/n Client only
Integrated Module Info:	SparKLAN WUBA-171GN FCC-ID RYK-WUBA171GN IC-ID 6158A-WUBA171GN
Antenna Type:	Laird WTS2450 External Two-Way Radio Antenna
Max. Declared Antenna Gain:	2.1dBi
Maximum Conducted Output Power from modular grant:	29.5dBm for modulation and bandwidth which is not specified in module grant or report
Power Supply:	No Power supply is part of the sales package.
Rated Operating Voltage Range:	Vmin: 18V dc/ Vnom: 28V dc / Vmax: 32.2V dc
Operating Temperature Range:	Tlow: -40° C/Tnom: 25° C/ Tmax: 55° C

Test Report #:	EMC-UTCAE-018-16501_FCC_15.247	FCC ID: 2AEAK870L1-5	
Date of Report	October 19, 2016	Page 6 of 39	

Other Radios included in the Device:	LTE Band 2/25, Band 4, Band 5/26, Band 7, Band 12, Band 13, Band 30, Band 41 UMTS Band II, IV, V
Sample Revision:	<input type="checkbox"/> Prototype; <input checked="" type="checkbox"/> Production; <input type="checkbox"/> Pre-Production

Note: Obtained from Sections 3.2.5 and 3.2.6 of the referenced module report. Please see Section 6.4 of this report.

Test Report #:	EMC-UTCAE-018-16501_FCC_15.247	FCC ID: 2AEAK870L1-5	
Date of Report	October 19, 2016	Page 7 of 39	

3.2 EUT Sample details

EUT #	Serial Number	HW Version	SW Version	Notes/Comments
1	8730L-2-2	08730-0427-0005/K	08730-0459-0002	Laird WTS2450 connected on SMA connector

3.3 Accessory Equipment (AE) details

AE #	Type	Model	Manufacturer	Serial Number
1	N/A	N/A	N/A	N/A

3.1 Ancillary Equipment (AE) details

AE #	Type	Model	Manufacturer	Serial Number
1	Power supply	3003B	Proteck	H012771
2	CISCO AP	AIR-CAP3702E-A-K9	CISCO	FIX18167223
3	Router	EBR 2310	D-Link	F3113A400406

3.2 EUT Sample Configuration

EUT Set-Up #	Combination of AE used for test set up	Comments
1	EUT#1 + AE2 + AE 3	The Radio was stimulated via iperf with full buffer traffic. A connection was created with a CISCO AP Model AIR-CAP3702E-A-K9

3.3 Environmental conditions during Test:

The following environmental conditions were maintained during the course of testing:

Ambient Temperature: 20-25°C

Relative humidity: 40-60%

Test Report #:	EMC-UTCAE-018-16501_FCC_15.247	FCC ID: 2AEAK870L1-5	
Date of Report	October 19, 2016	Page 8 of 39	

4 Subject of Investigation

The objective of the measurements done by CETECOM Inc. was to assess the performance of the EUT per the relevant requirements specified in FCC rules Part 15.247 of Title 47 of the Code of Federal Regulations and ISED RSS-247 Issue 1.

This test report is to support a request for equipment authorization as the WLAN module is implemented together with another radio module and thus the initial modular grant conditions are no longer met.

A power verification has been performed in order to justify leveraging the conducted measurement results of the modular report on file (Sporton Lab. FCC Test Report FR351115-01). The verification has been carried out on worst case mode of operation as of modular report 802.11g.

Testing procedures are based on ANSI 63.10 (2013) and "GUIDANCE FOR PERFORMING COMPLIANCE MEASUREMENTS ON DIGITAL TRANSMISSION SYSTEMS (DTS) OPERATING UNDER §15.247; April 8, 2016" by the Federal Communications Commission, Office of Engineering and Technology, Laboratory Division.

5 Measurement Results Summary

Test Specification	Test Case	Temperature and Voltage Conditions	Mode	Pass	Fail	NA	NP	Result
§15.247(e)	Power Spectral Density	Nominal	802.11g	<input type="checkbox"/>	<input type="checkbox"/>	<input type="checkbox"/>	<input checked="" type="checkbox"/>	Covered by modular report
§15.247(a)(1)	Emission Bandwidth	Nominal	802.11g	<input type="checkbox"/>	<input type="checkbox"/>	<input type="checkbox"/>	<input checked="" type="checkbox"/>	Covered by modular report
§15.247(b)(1)	Maximum Conducted Output Power and EIRP	Nominal	802.11g	<input checked="" type="checkbox"/>	<input type="checkbox"/>	<input type="checkbox"/>	<input type="checkbox"/>	Verification performed and passed
§15.247/15.209/15.205	Band edge compliance-Restricted Band Edges	Nominal	802.11g	<input type="checkbox"/>	<input type="checkbox"/>	<input type="checkbox"/>	<input checked="" type="checkbox"/>	Covered by modular report
§15.247(d)	Band edge compliance-Unrestricted Band Edges	Nominal	802.11g	<input type="checkbox"/>	<input type="checkbox"/>	<input type="checkbox"/>	<input checked="" type="checkbox"/>	Covered by modular report
§15.247(d) §15.209	TX Spurious emissions-Radiated	Nominal	802.11b/g	<input checked="" type="checkbox"/>	<input type="checkbox"/>	<input type="checkbox"/>	<input type="checkbox"/>	Complies
§15.207(a)	AC Conducted Emissions	Nominal	802.11b/g	<input type="checkbox"/>	<input type="checkbox"/>	<input checked="" type="checkbox"/>	<input type="checkbox"/>	NA. DC power connected to aircraft bus.

6 Measurements

6.1 Measurement Uncertainty

Where relevant, the following measurement uncertainty levels have been estimated for tests performed on the apparatus, with 95% confidence interval (in dB delta to result), based on a coverage factor k=1.

	Uncertainty in dB radiated <30MHz	Uncertainty in dB radiated 30MHz - 1GHz	Uncertainty in dB radiated > 1GHz	Uncertainty in dB Conducted measurement
standard deviation k=1	2.48	1.94	2.16	0.64
95% confidence interval in dB	4.86	3.79	4.24	1.25
95% confidence interval in dB in delta to Result (rounded up to next decimal point)	+/- 2.5 dB	+/- 2.0 dB	+/- 2.3dB	+/- 0.7dB

6.2 Environmental Conditions During Testing:

The following environmental conditions were maintained during the course of testing:

- Ambient Temperature: 20-25°C
- Relative humidity: 40-60%

6.3 Dates of Testing:

August 18, 2016 – September 21, 2016

7 Measurement Procedures

7.1 Radiated Measurement

The radiated measurement is performed according to:

ANSI C63.10 (2013)

- The exploratory measurement is accomplished by running sweeps at 1 and 4m antenna heights over the required frequency range with R&S Test-SW EMC32 for both antenna polarizations. During each frequency scan the turntable rotates by no more than 10deg.
- The 10 highest emissions are selected with an automatic algorithm of EMC32 searching for peaks in the noise floor and ensuring that broadband signals are not selected multiple times.
- The maxima are then again maximized through a fine search in frequency domain, maximized in the 360deg range of the turntable, and maximized over antenna height between 1m and 4m and for positioning of the EUT.
- The above procedure is repeated for transmission low mid and high channel.
- In case there are no emissions above noise floor level only the maximum trace is reported as described above.
- The results are split up into up to 4 frequency ranges due to antenna bandwidth restrictions. A magnetic loop is used from 9 kHz to 30 MHz, a Biconilog antenna is used from 30 MHz to 3 GHz, and horn antenna is used to cover frequencies up to 40 GHz.

Radiated Emissions Test Setup Below 30MHz Measurements

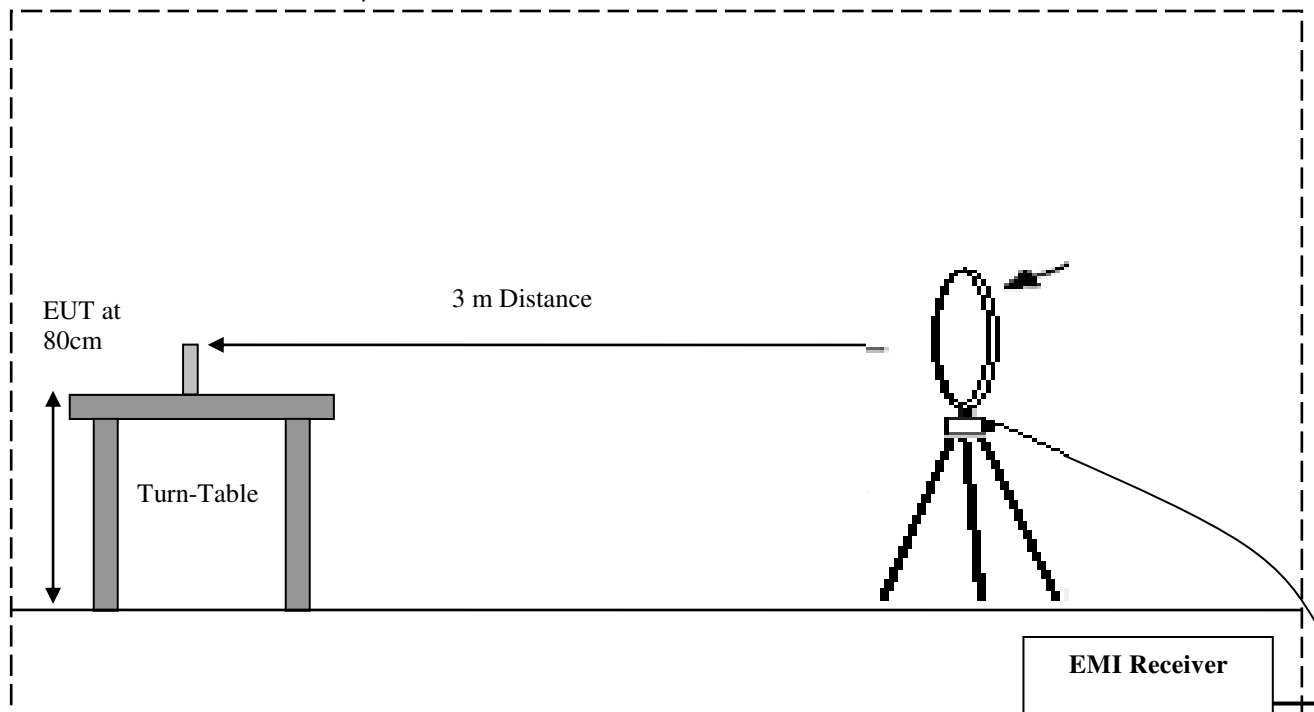

Radiated Emissions Test Setup 30MHz-1GHz Measurements

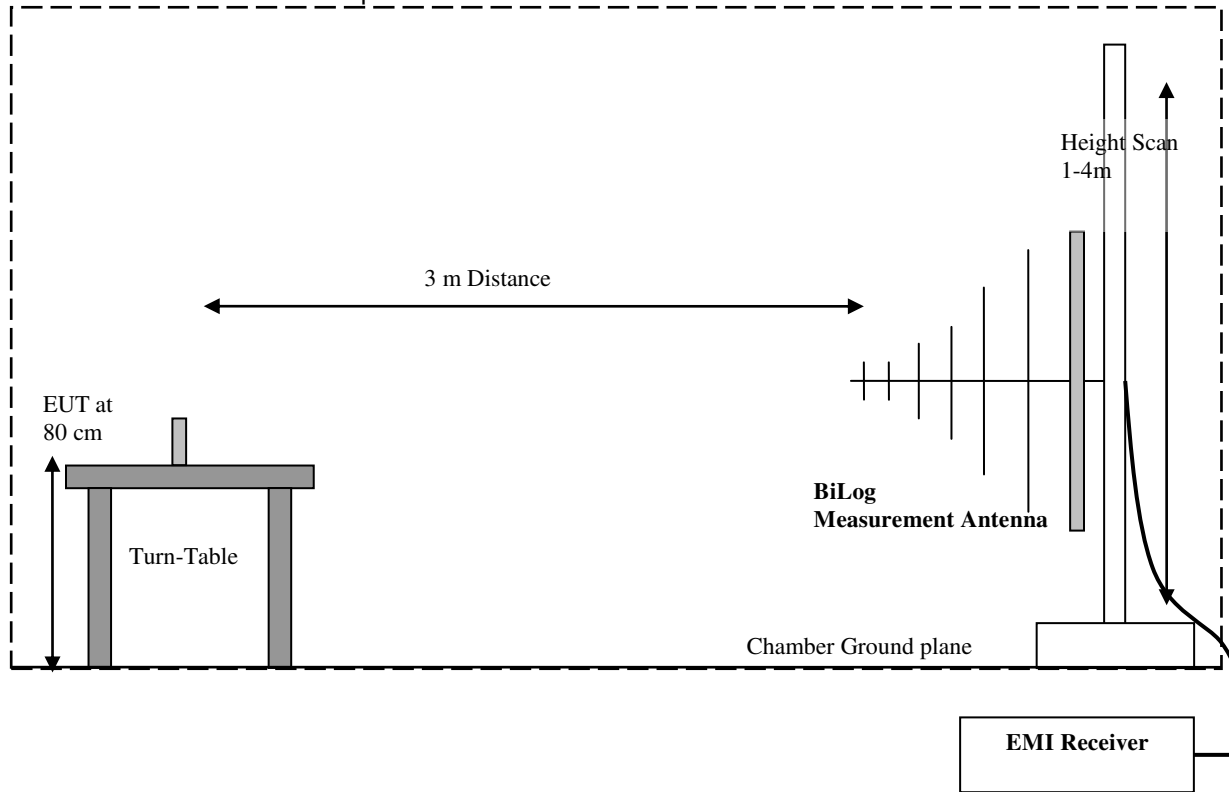

Radiated Emissions Test Setup 1-18GHz Measurements

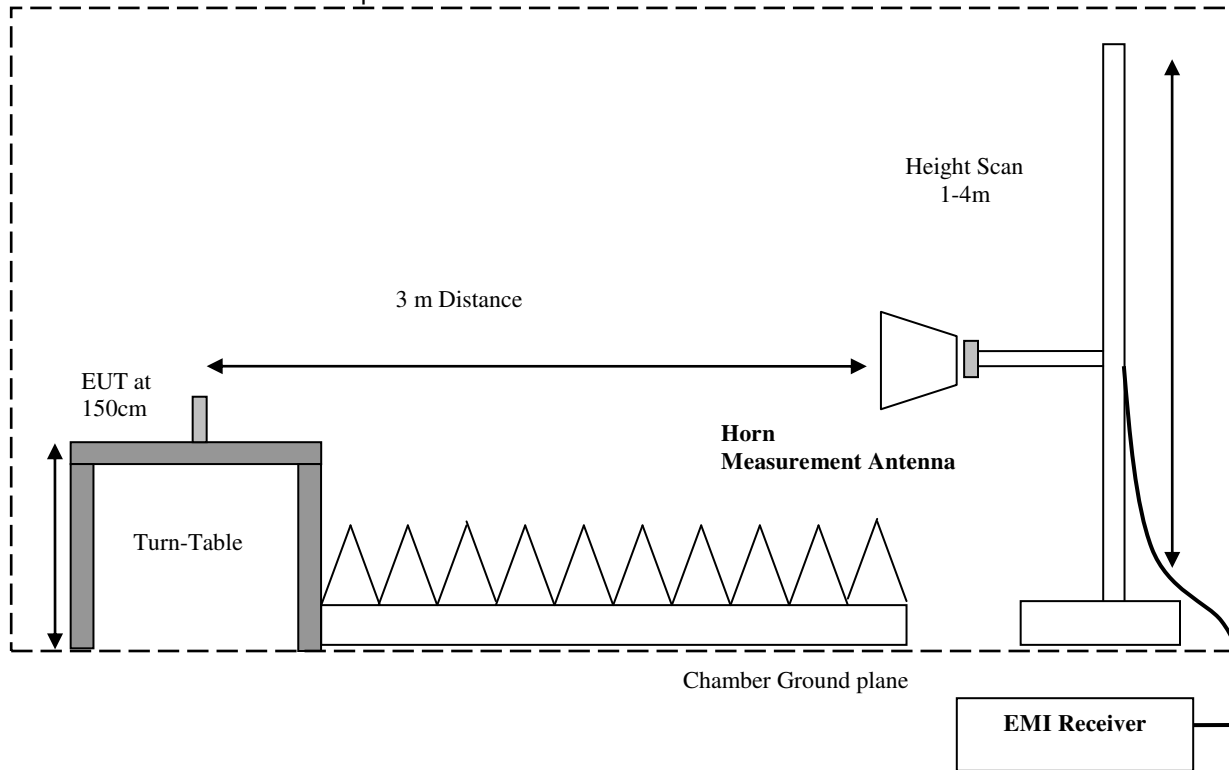

Radiated Emissions Test Setup 18-26GHz Measurements

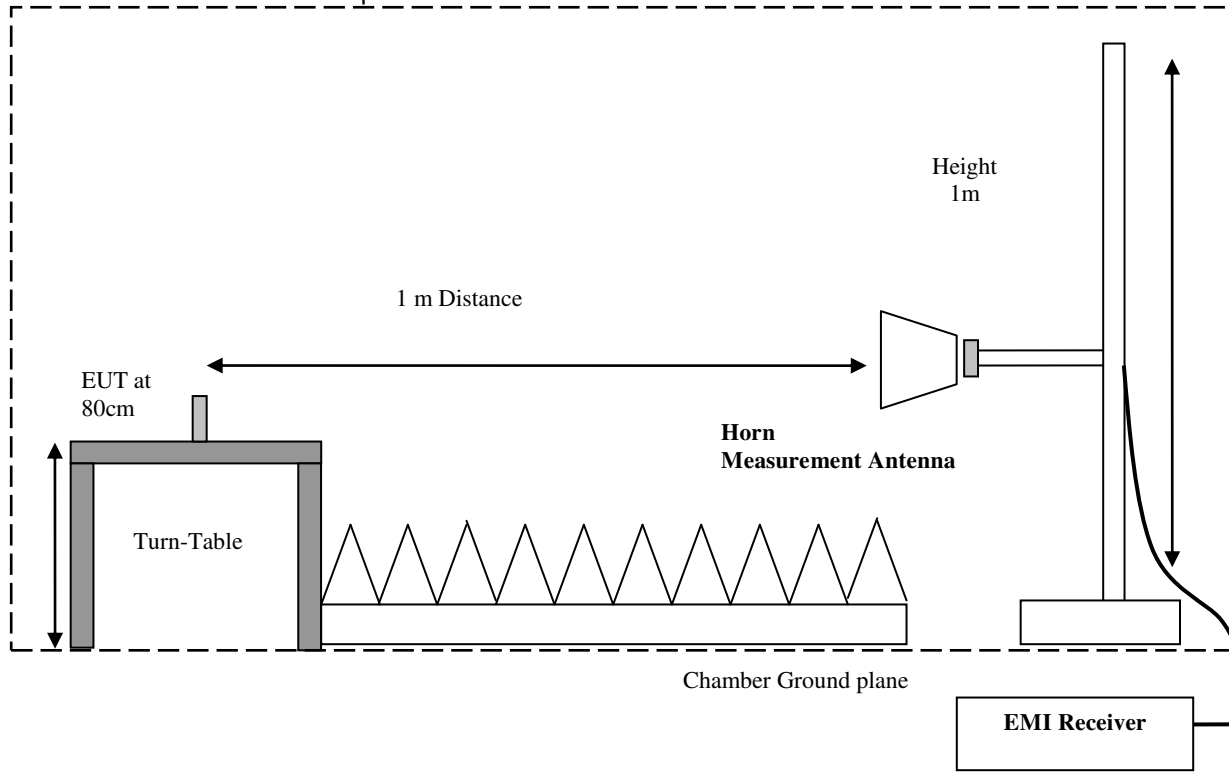

7.2 Sample Calculations for Field Strength Measurements

Field Strength is calculated from the Spectrum Analyzer/ Receiver readings, taking into account the following parameters:

1. Measured reading in dB μ V
2. Cable Loss between the receiving antenna and SA in dB and
3. Antenna Factor in dB/m

All radiated measurement plots in this report are taken from a test SW that calculates the Field Strength based on the following equation:

$$FS \text{ (dB}\mu\text{V/m)} = \text{Measured Value on SA (dB}\mu\text{V)} - \text{Cable Loss (dB)} + \text{Antenna Factor (dB/m)}$$

Example:

Frequency (MHz)	Measured SA (dB μ V)	Cable Loss (dB)	Antenna Factor Correction (dB)	Field Strength Result (dB μ V/m)
1000	80.5	3.5	14	98.0

7.3 Power Line Conducted Measurement Procedure

AC Power Line conducted emissions measurements performed according to:

ANSI C63.4 (2014)

7.4 RF Conducted Measurement Procedure

7.4.1 Conducted Measurement Setup without companion device

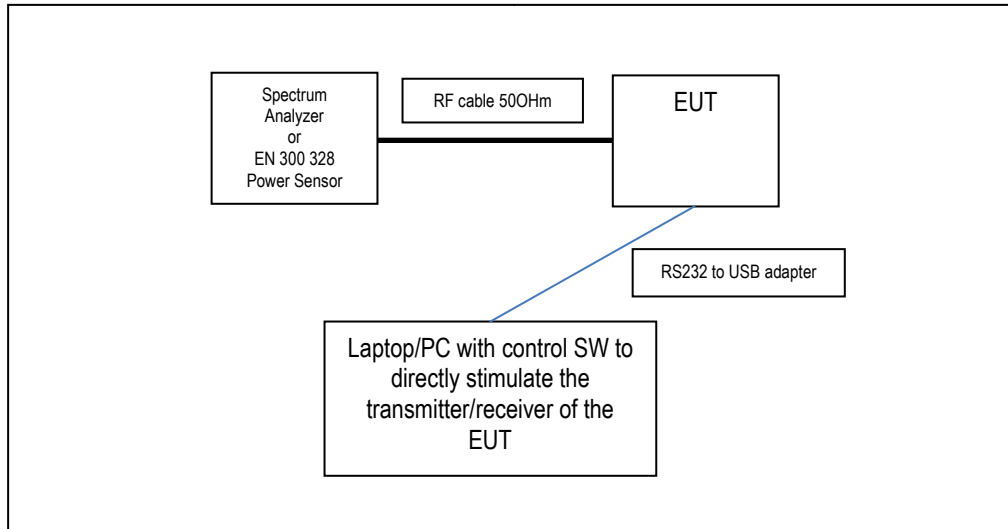

Test Report #:	EMC-UTCAE-018-16501_FCC_15.247	FCC ID: 2AEAK870L1-5	
Date of Report	October 19, 2016	Page 16 of 39	

8 Maximum Conducted Output Power Verification

8.1 Measurement Settings

Conducted RMS power measurements were taken according to ANSI C63.10-2013 Section 11.9.2.3.2, using a gated RF average power meter capable of 5 MS/s RMS measurements (Equipment number 19 in section 12).

Conducted Peak power measurements were taken according to ANSI C63.10-2013 Section 11.9.1.3, using a gated power meter.

8.2 Limits:

Part 2.1043

(a) Except as provided in paragraph (b)(3) of this section, changes to the basic frequency determining and stabilizing circuitry (including clock or data rates), frequency multiplication stages, basic modulator circuit or maximum power or field strength ratings shall not be performed without application for and authorization of a new grant of certification. Variations in electrical or mechanical construction, other than these indicated items, are permitted provided the variations either do not affect the characteristics required to be reported to the Commission or the variations are made in compliance with the other provisions of this section. Changes to the software installed in a transmitter that do not affect the radio frequency emissions do not require any additional filings and may be made by parties other than the holder of the grant of certification.

(b) Three classes of permissive changes may be made in certificated equipment without requiring a new application for and grant of certification. None of the classes of changes shall result in a change in identification.

....

(2) A Class II permissive change includes those modifications which degrade the performance characteristics as reported to the Commission at the time of the initial certification. Such degraded performance must still meet the minimum requirements of the applicable rules. When a Class II permissive change is made by the grantee, the grantee shall provide complete information and the results of tests of the characteristics affected by such change. The modified equipment shall not be marketed under the existing grant of certification prior to acknowledgement that the change is acceptable.

8.3 Test conditions and setup:

Ambient Temperature	EUT Set-Up #	EUT operating mode	Power Input
23° C	1	Tx	120 Vac 60 Hz

8.4 Measurement result:

RMS Output Power

Frequency (MHz)	Mode	Data Rate (Mbps)	Measurement Result uncorrected RMS (dBm)	Correction for path loss	Conducted RMS Output Power (dBm)	Conducted RMS Output Power From Modular Report	Result
2412MHz ch1	802.11b	1	-8.63	21.7	13.07	29.5	Strong degradation of performance as compared to grant. Either new certification or C2PC required according to Part2 J 1043
2437MHz ch6	802.11b	1	-7.45	21.7	14.25	29.5	
2462MHz ch11	802.11b	1	-7	21.7	14.7	29.5	
Max channel from above ch11	802.11b	1	-7	21.7	14.7	29.5	
	802.11g	6	-7.5	21.7	14.2	29.5	
	802.11n	M0	-7.1	21.7	14.6	29.5	

Test Report #:	EMC-UTCAE-018-16501_FCC_15.247	FCC ID: 2AEAK870L1-5	
Date of Report	October 19, 2016	Page 18 of 39	

9 Radiated Transmitter Spurious Emissions and Restricted Bands

9.1 Measurement Settings

Measurement according to ANSI C63.10 (2013)

Analyzer Settings:

Frequency = 9 KHz – 30 MHz

RBW = 9 KHz

Detector: Peak

Frequency = 30 MHz – 1 GHz

Detector = Peak / Quasi-Peak

RBW=120 KHz (<1GHz)

Frequency > 1 GHz

Detector = Peak / Average

RBW= 1MHz

Plots reported here represent the worst case emissions for horizontal and vertical antenna polarizations and for three orientations of the EUT. Unless mentioned otherwise, the emissions outside the limit lines in the plots are from the transmit signal.

9.2 Limits: §15.247/15.205/15.209

(a) Except as shown in paragraph (d) of this section, only spurious emissions are permitted in any of the frequency bands listed below:

MHz	MHz	MHz	GHz
0.090 - 0.110	16.42 - 16.423	399.9 - 410	4.5 - 5.15
¹ 0.495 - 0.505	16.69475 - 16.69525	608 - 614	5.35 - 5.46
2.1735 - 2.1905	16.80425 - 16.80475	960 - 1240	7.25 - 7.75
4.125 - 4.128	25.5 - 25.67	1300 - 1427	8.025 - 8.5
4.17725 - 4.17775	37.5 - 38.25	1435 - 1626.5	9.0 - 9.2
4.20725 - 4.20775	73 - 74.6	1645.5 - 1646.5	9.3 - 9.5
6.215 - 6.218	74.8 - 75.2	1660 - 1710	10.6 - 12.7
6.26775 - 6.26825	108 - 121.94	1718.8 - 1722.2	13.25 - 13.4
6.31175 - 6.31225	123 - 138	2200 - 2300	14.47 - 14.5
8.291 - 8.294	149.9 - 150.05	2310 - 2390	15.35 - 16.2
8.362 - 8.366	156.52475 - 156.52525	2483.5 - 2500	17.7 - 21.4
8.37625 - 8.38675	156.7 - 156.9	2690 - 2900	22.01 - 23.12
8.41425 - 8.41475	162.0125 - 167.17	3260 - 3267	23.6 - 24.0
12.29 - 12.293	167.72 - 173.2	3332 - 3339	31.2 - 31.8
12.51975 - 12.52025	240 - 285	3345.8 - 3358	36.43 - 36.5
12.57675 - 12.57725	322 - 335.4	3600 - 4400	(²)
13.36 - 13.41			

Radiated emissions which fall in the restricted bands, as defined in §15.205(a), must also comply with the radiated emission limits specified in §15.209(a) (see §15.205(c)).

*PEAK LIMIT= 74dBµV/m

*AVG. LIMIT= 54dBµV/m

Table 1:

Frequency of emission (MHz)	Field strength @ 3m (µV/m)	Field strength @ 3m (dBµV/m)
30-88	100	40dBµV/m
88-216	150	43.5 dBµV/m
216-960	200	46 dBµV/m
Above 960	500	54 dBµV/m

Table 2:

Frequency of emission (MHz)	Field strength (µV/m) / (dBuV/m)	Measurement Distance (m)
0.009-0.490	2400/F(kHz) / -----	300
0.490-1.705	24000/F(kHz) / -----	30
1.705-30.0	30 / (29.5)	30

Radiated spurious emissions shall be measured for the transmit frequencies, transmit power, and data rate for the middle channel in each frequency band of operation and for the highest gain antenna for each antenna type, and using the appropriate parameters and test requirements described in 5.4.

Test Report #:	EMC-UTCAE-018-16501_FCC_15.247	FCC ID: 2AEAK870L1-5	
Date of Report	October 19, 2016	Page 20 of 39	

For testing at distance other than the specified in the standard, the limit conversion is calculated by using 40 dB/decade extrapolation factors as follow:

$$\text{Conversion factor (CF)} = 40 \log (D/d) = 40 \log (300\text{m} / 3\text{m}) = 80\text{dB}$$

9.3 Test conditions and setup:

Please see section 7.1 for detailed test setup. Equipment numbers 1-16 in section 16 of this report were used for this test case in a semi-anechoic chamber.

Due to the discrepancy of the conducted peak output power from the measurements and the module report (section 8.4), full testing was done on all 802.11g mode channels.

For 802.11b mode, only mid channel was tested as the highest RMS output power in the module report referenced in section 6.4 was the mid channel for each technology.

Ambient Temperature	EUT Set-Up #	EUT operating mode	Power Input
23° C	1	Tx	120 Vac 60 Hz

9.4 Measurement result:

9.4.1 Measurement summary result

Channel #	Plot #	Scan Frequency	Result	Frequency of highest emission [MHz]	Highest Emission [dBuV/m]
1	1	9 KHz – 30 MHz	Pass		
	2	30 MHz – 1 GHz	Pass	750	35
	3	1 GHz – 3 GHz	Pass	2774	50
	4	3 GHz – 18 GHz	Pass	15879	54
	5	18 GHz – 40 GHz	Pass		
6	6	9 KHz – 30 MHz	Pass	0.15	89
	7	30 MHz – 1 GHz	Pass	374.9	35.6
	8	1 GHz – 3 GHz	Pass	2000	38.6
	9	3 GHz – 18 GHz	Pass	16275	54.1
	10	18 GHz – 40 GHz	Pass	39989	52.5
11	11	9 KHz – 30 MHz	Pass		
	12	30 MHz – 1 GHz	Pass	750	34.4
	13	1 GHz – 3 GHz	Pass	1999	47.5
	14	3 GHz – 18 GHz	Pass	16280	49.3
	15	18 GHz – 40 GHz	Pass	39949	52.2

9.5 Measurement Plots:

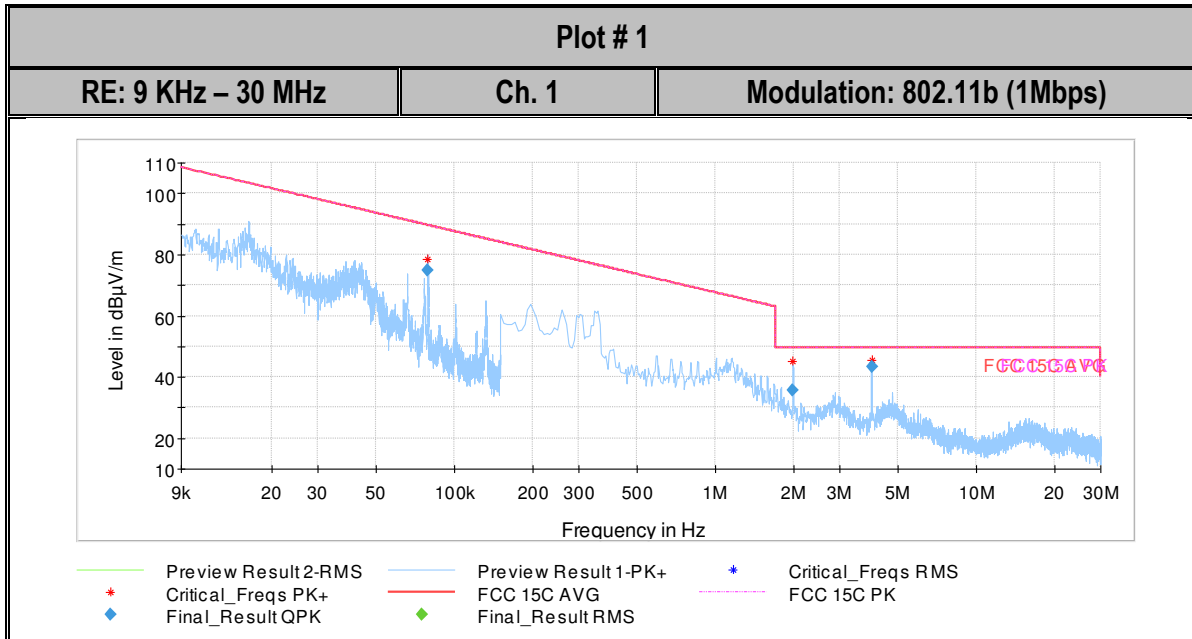

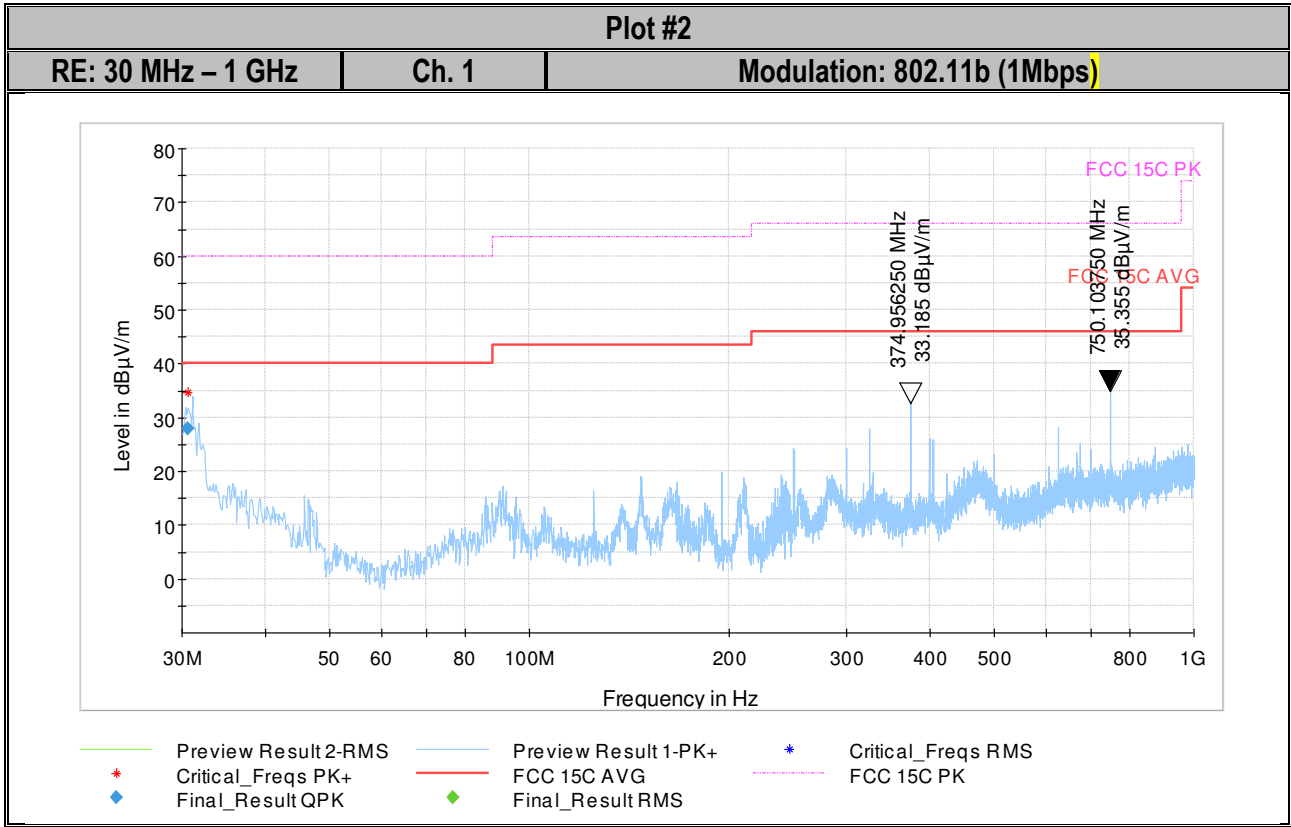

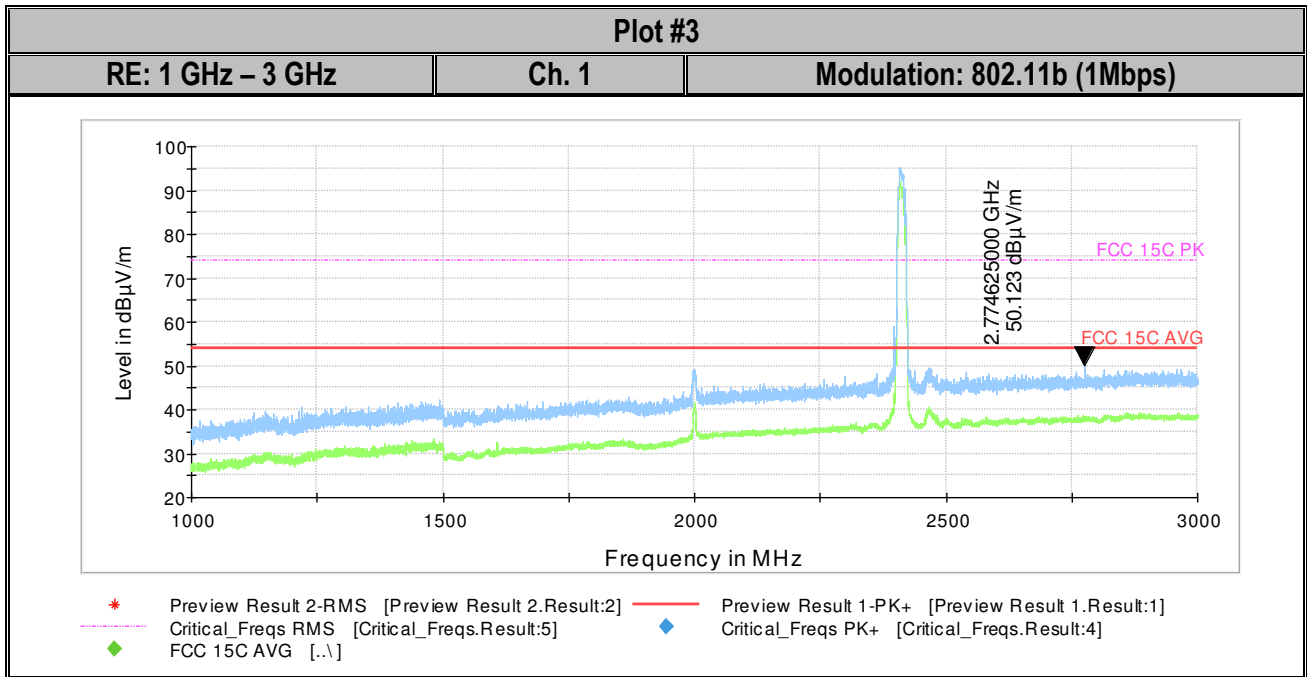

Note: The emission above the limit is the Tx Ch.1.

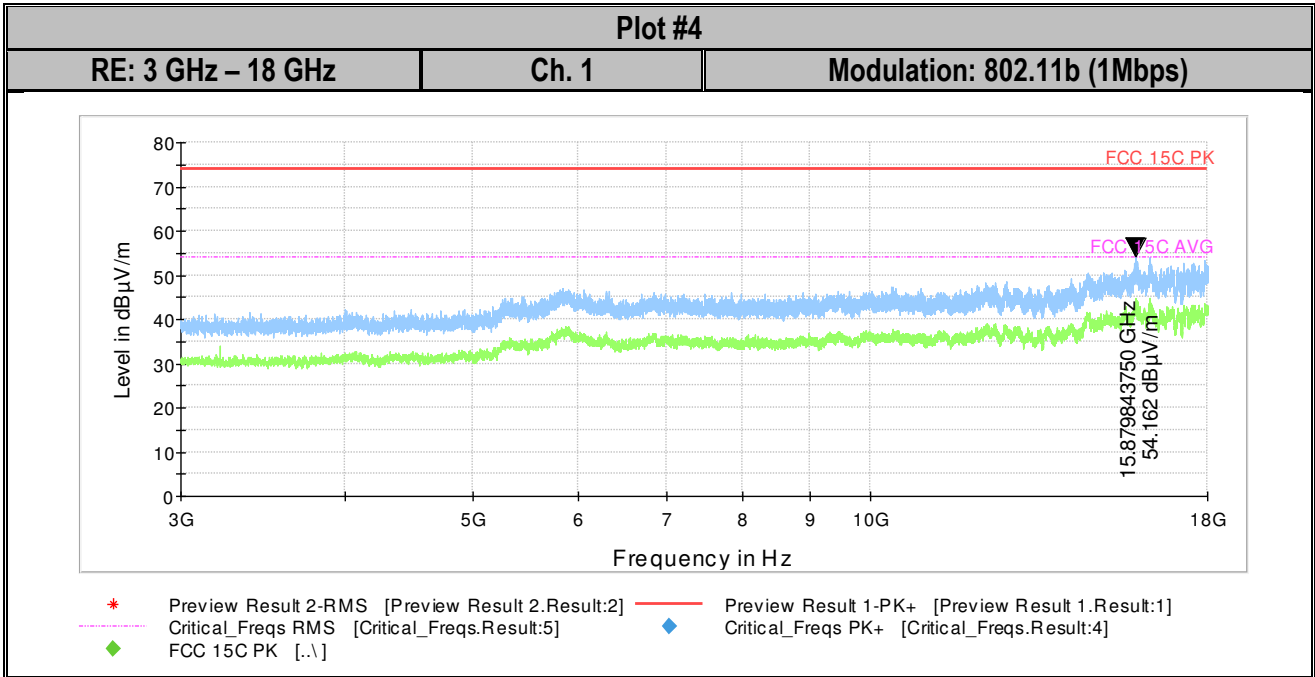

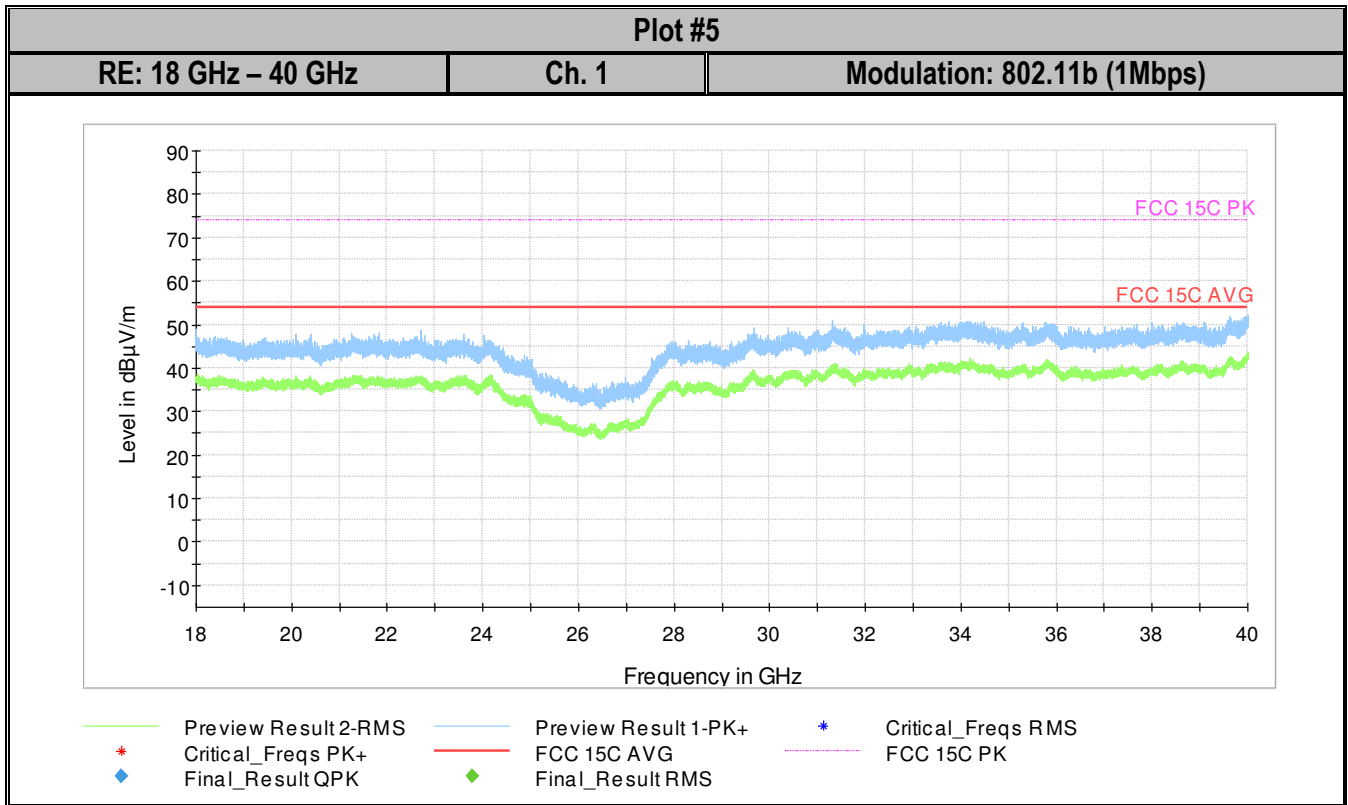

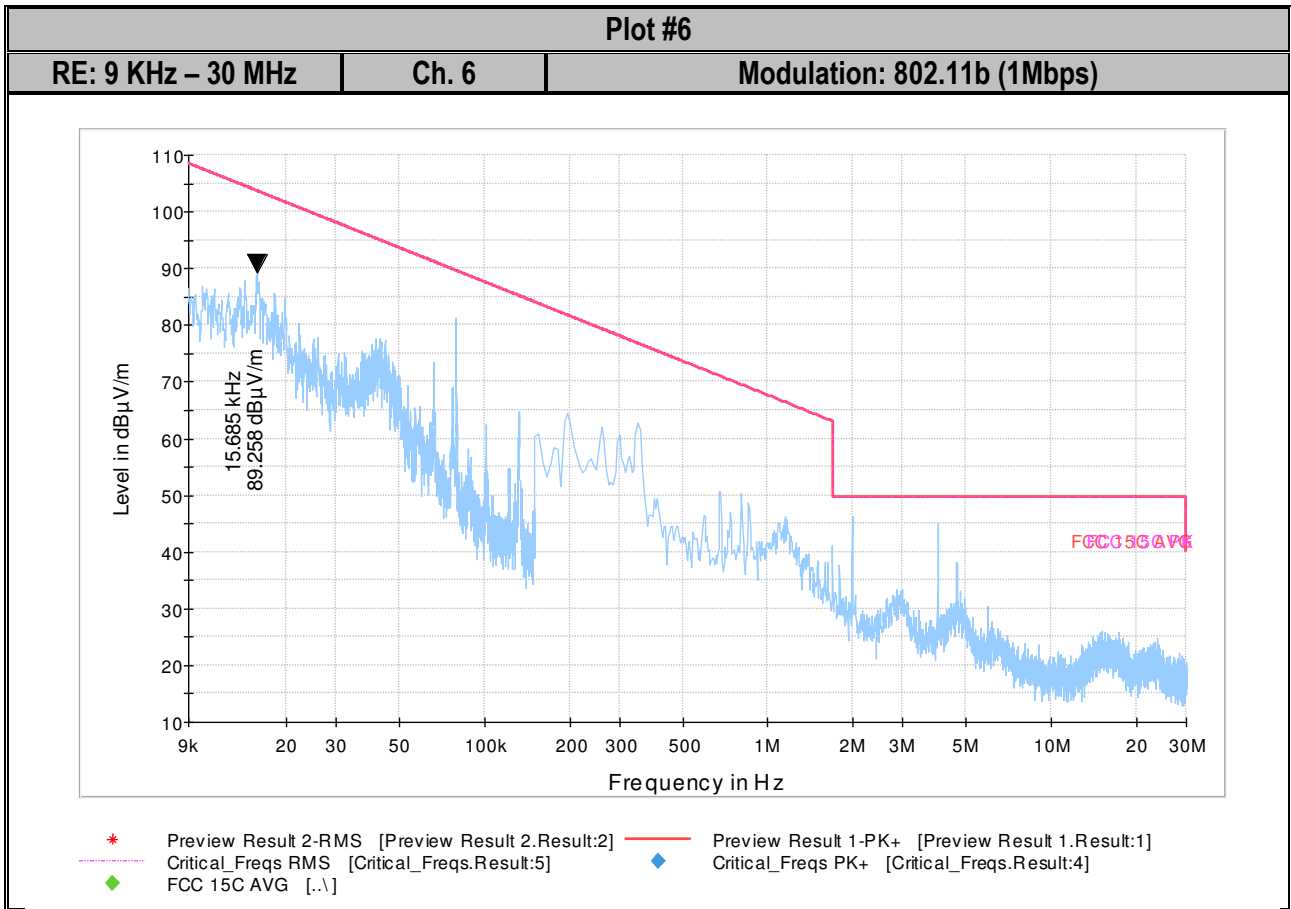

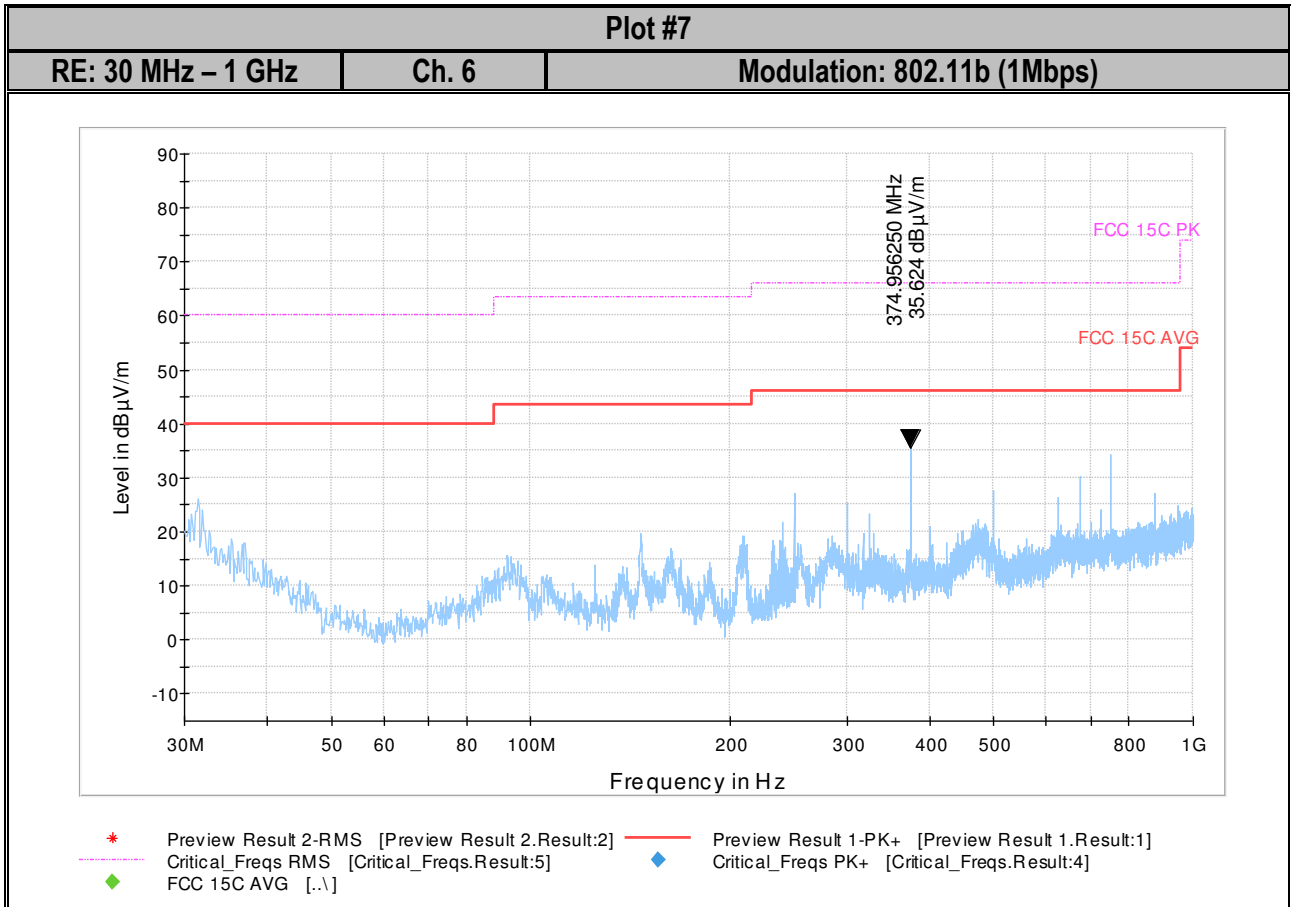

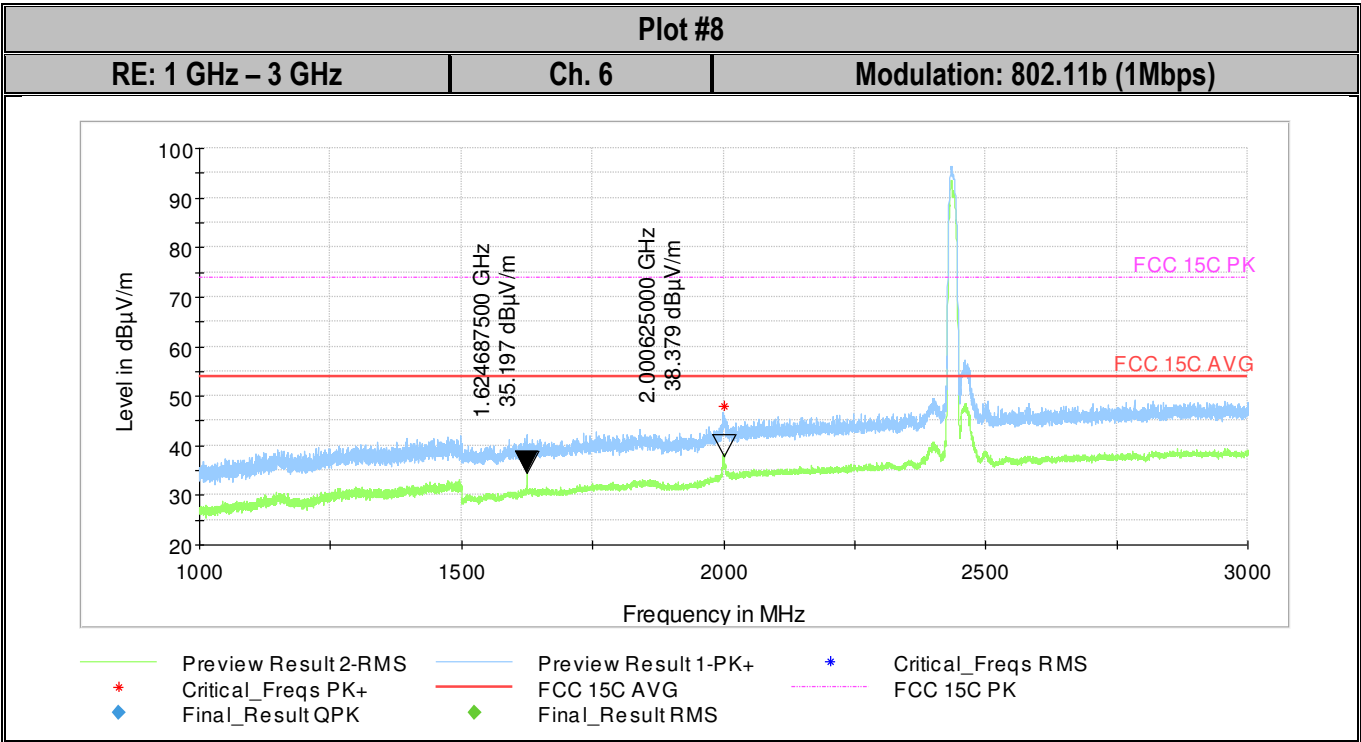

Note: The emission above the limit is the Tx Ch.6.

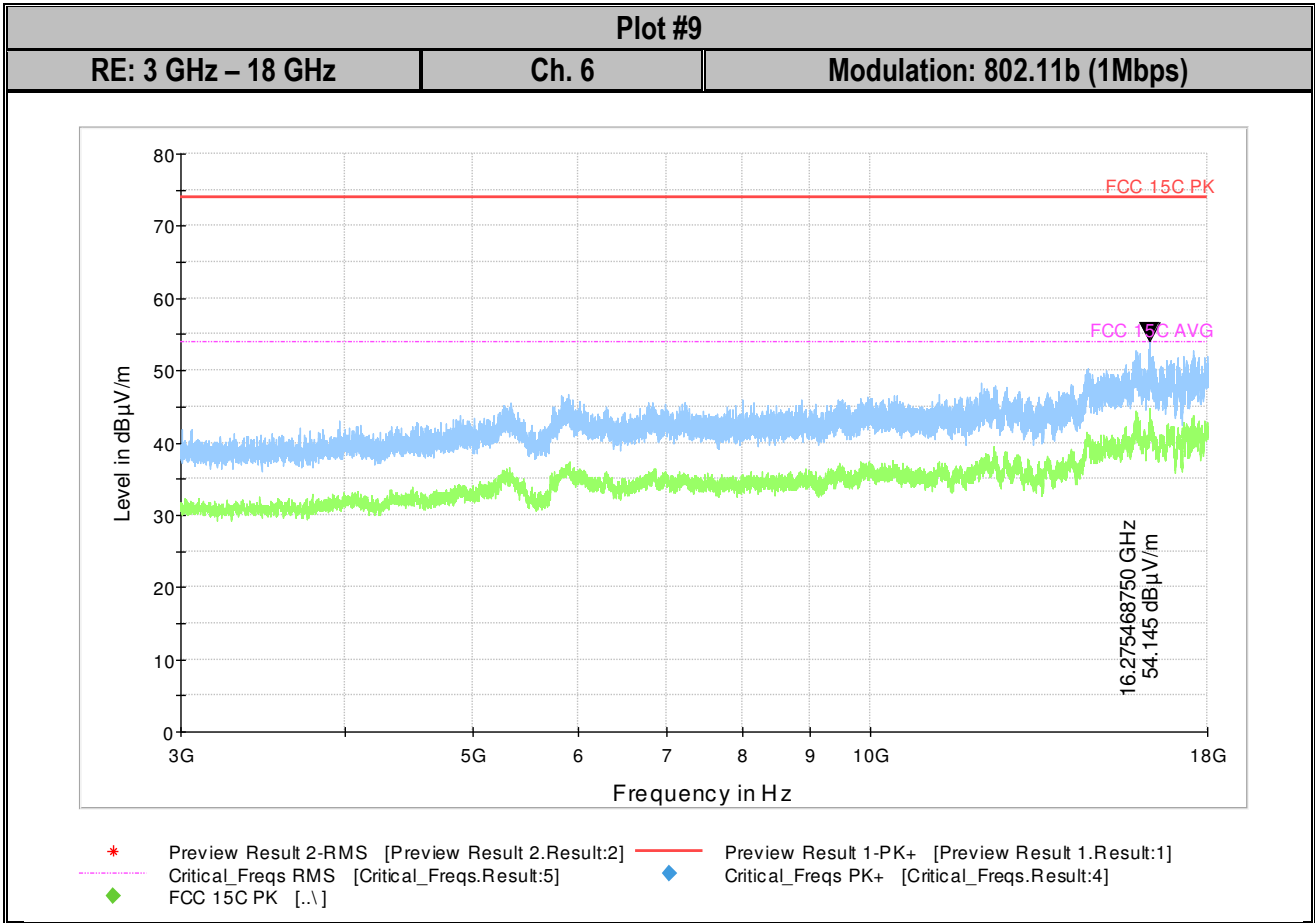

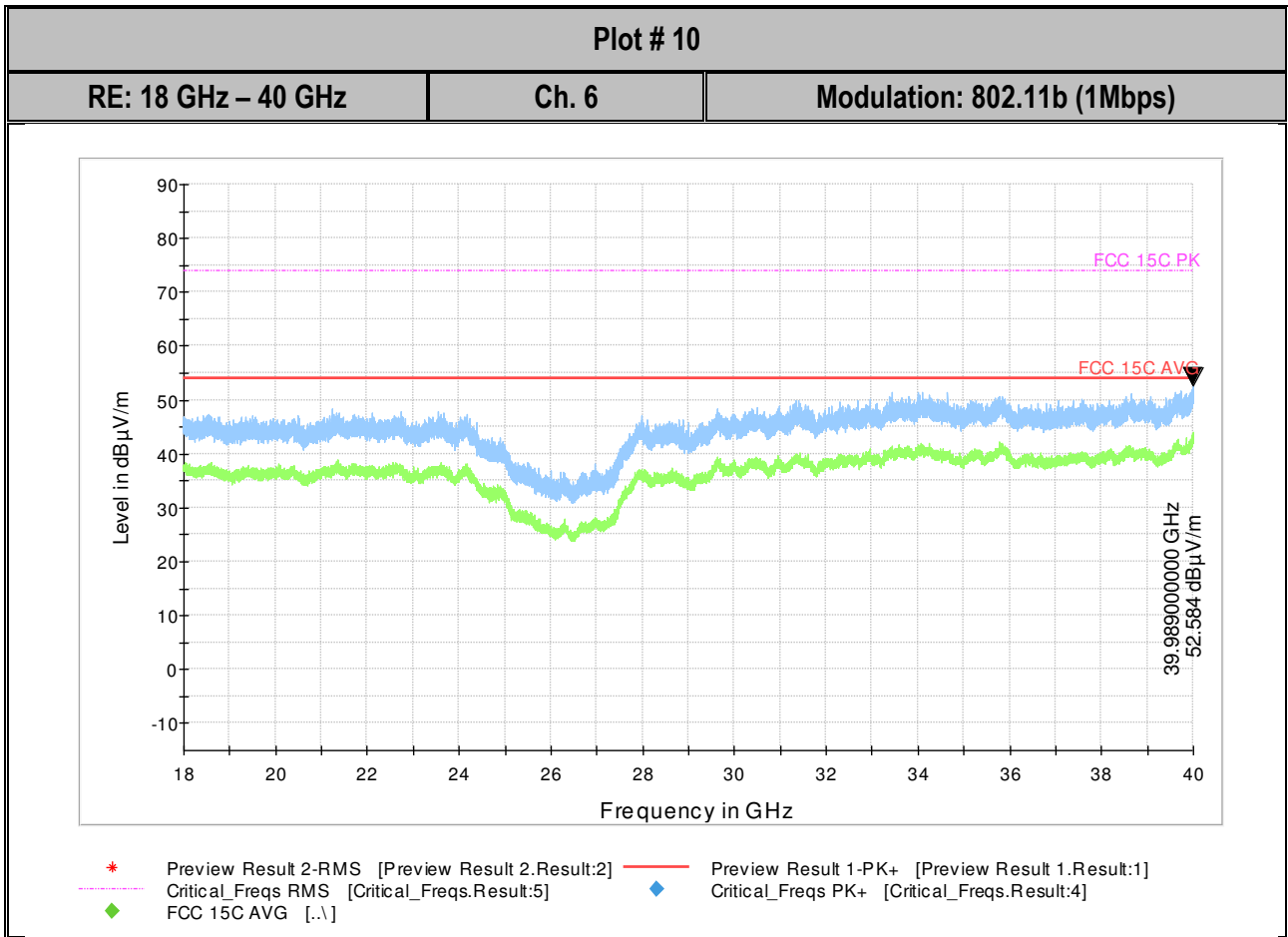

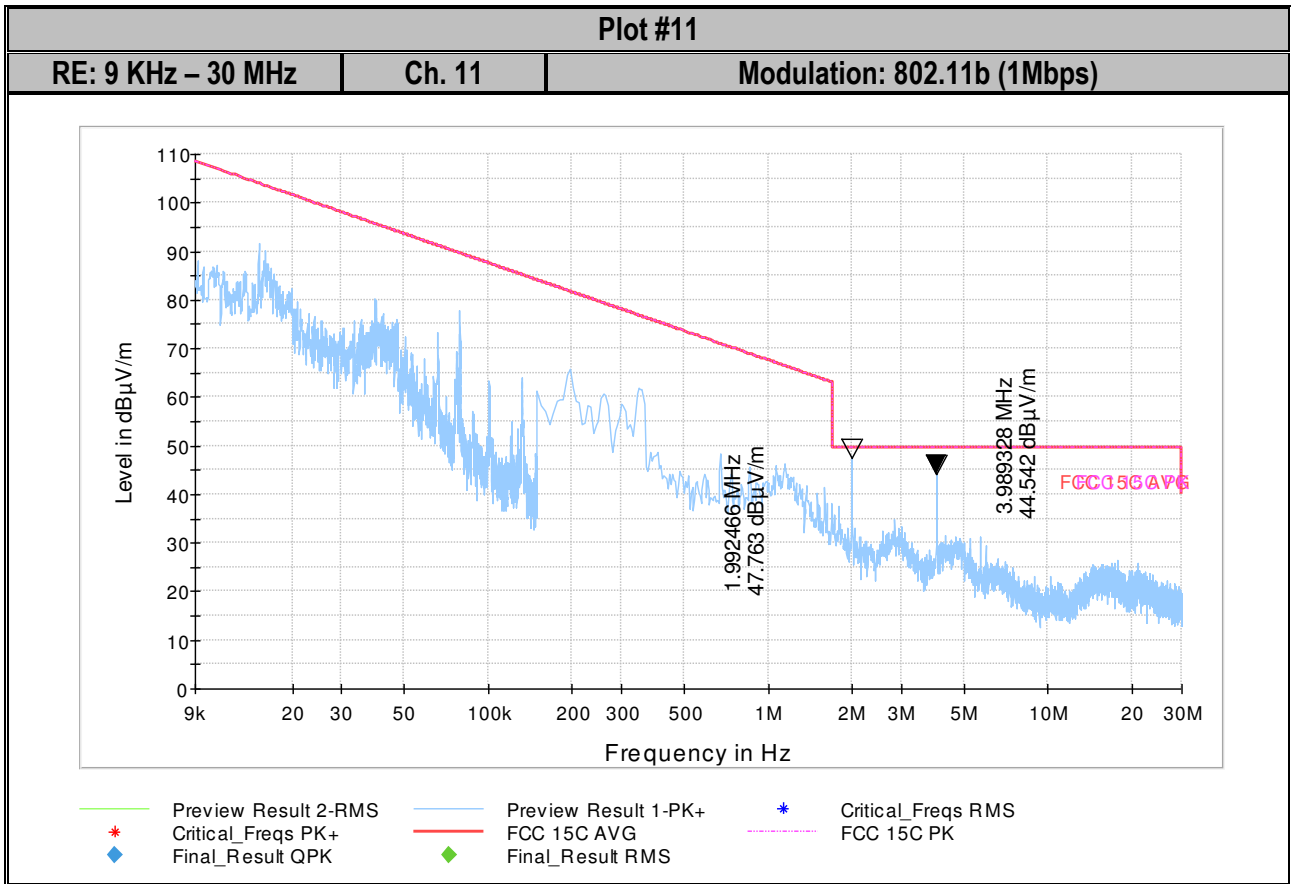

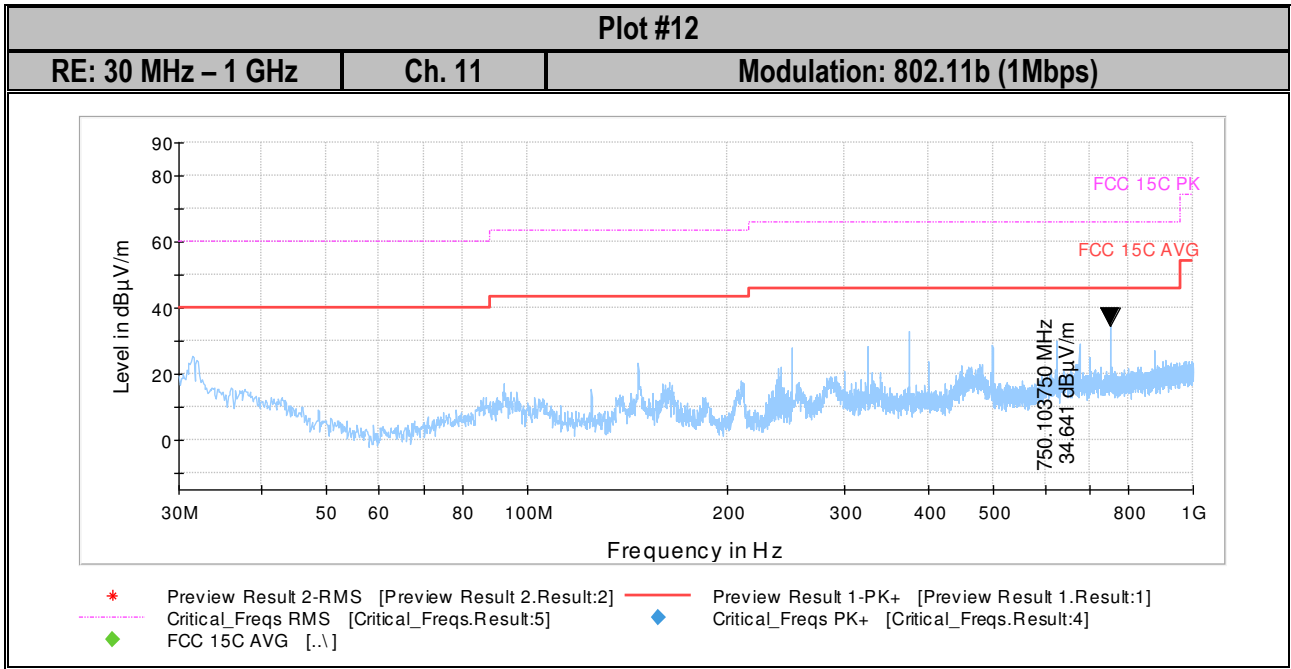

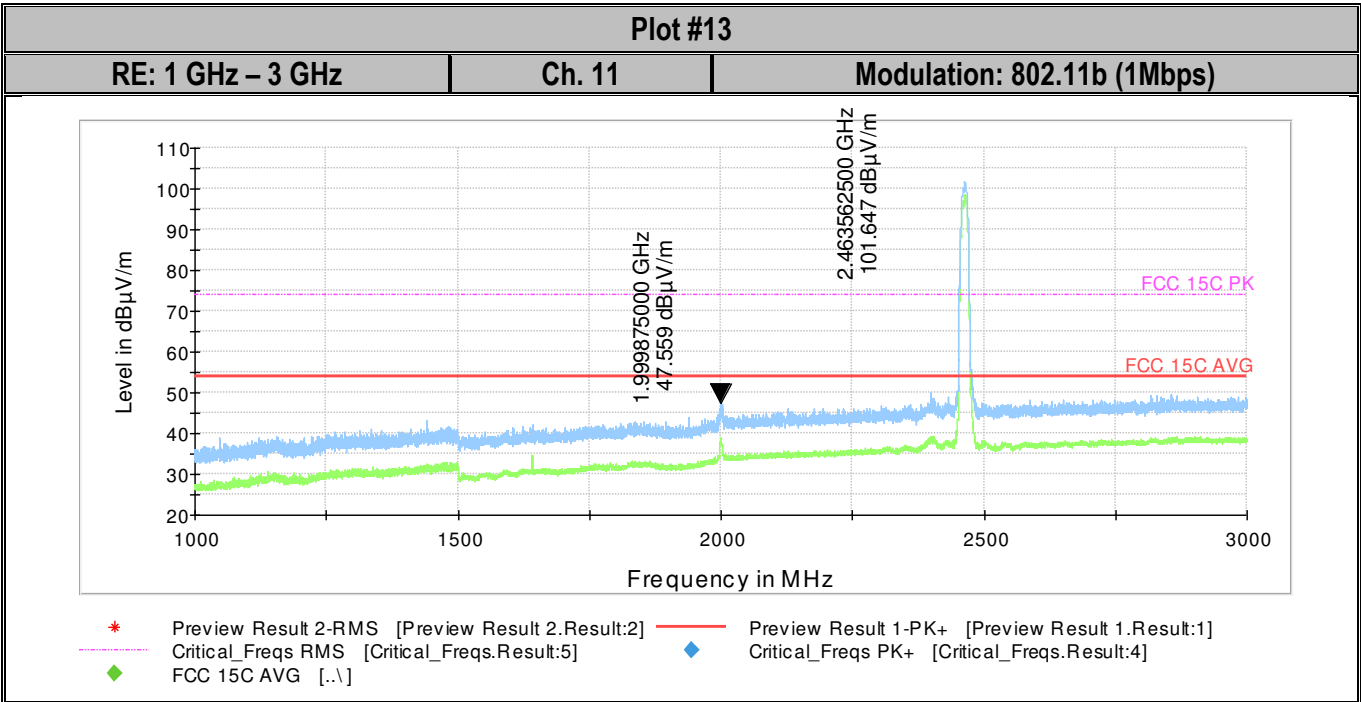

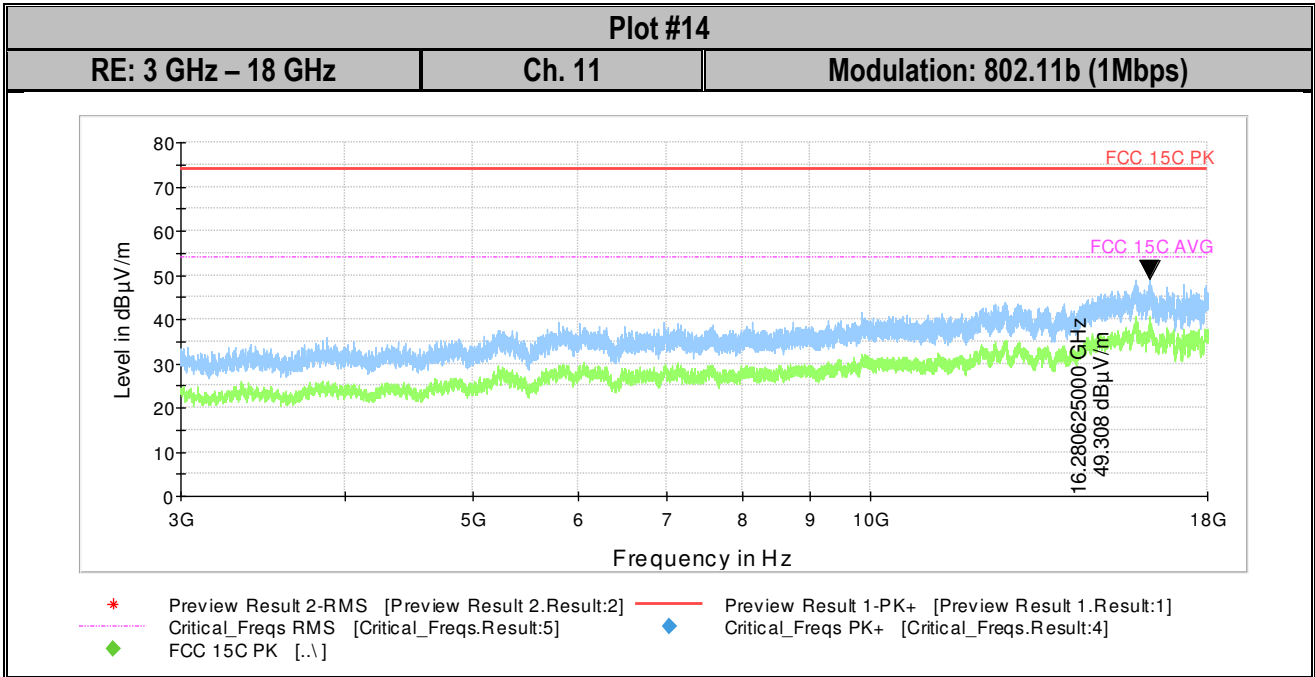

Note: The emission above the limit is the Tx Ch.11

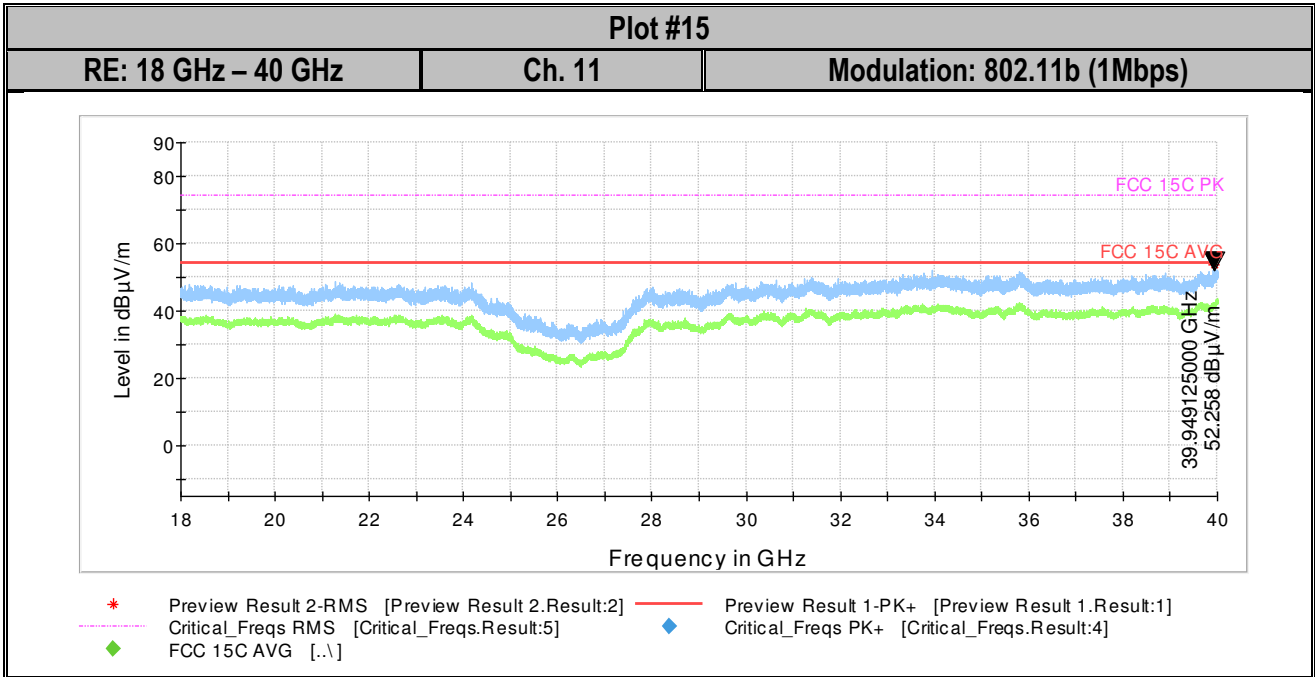



Test Report #:	EMC-UTCAE-018-16501_FCC_15.247	FCC ID: 2AEAK870L1-5	
Date of Report	October 19, 2016	Page 37 of 39	

10 Setup Pictures

Setup photos are included in supporting file name: "EMC-UTCAE-018-16501_TestSetupPhotos.pdf"

11 Test Equipment and Ancillaries Used For Testing

Item Name	Equipment Type	Manufacturer	Model	Serial #	Calibration Cycle	Last Calibration Date
Antenna Loop 6512	Loop (Passive)	ETS Lindgren	6512	00164698	3 years	7/22/2014
Antenna Biconilog	Biconilog (Type 3)	Rohde & Schwarz	HL652	100495	3 years	6/24/2015
Antenna Horn 3116	DTG Horn(Small 1)	ETS Lindgren	3116C-PA	00169535	3 years	8/14/2014
Antenna Horn 3117	DTG Horn(Medium)	ETS Lindgren	3117-PA	00167061	3 years	8/13/2014
Digital Barometer	Compact Digital Barometer	Control Company	35519-055	91119547	3 Years	4/7/2015
Digital Radio Comm. Tester CMU 200 #1	Digital Radio Comm. Tester	R&S	CMU 200 #1	101821	2 Years	7/4/2015
Signal Analyzer	Receiver/FSV 40	R&S	ESU 40	101022	3 years	7/28/2014
MT8820C	Radio communication analyzer	Anritsu	MT8820C	6201381652	3 years	4/29/2016
Thermometer Humidity TM320	Thermometer Humidity	Dickson	TM320	5280063	3 Year	7/29/2016
EMPower	Power meter gated	ETS Lindgren	7002-006	00160436	3 Year	8/18/2015

Equipment used meets the measurement uncertainty requirements as required per applicable standards for 95% confidence levels.

Calibration due dates, unless defined specifically, falls on the last day of the month. Items indicated "N/A" for cal status either do not specifically require calibration or is internally characterized before use.

Test Report #:	EMC-UTCAE-018-16501_FCC_15.247	FCC ID: 2AEAK870L1-5	
Date of Report	October 19, 2016	Page 39 of 39	

12 Revision History

Date	Report Name	Changes to report	Report prepared by
October 19, 2016	EMC-UTCAE-018-16501_FCC_15.247	Initial Version	Issa Ghanma