



omnitracs

innovation. driven.

Omnitracs Intelligent Vehicle Gateway (IVG)

Installation and Troubleshooting Guide

80-JE026-1 Rev. J

July 2018

Omnitracs, LLC
717 N. Harwood Street, Suite 1300
Dallas, TX 75201

Copyright © 2015-2018 Omnitracs, LLC. All rights reserved.

Omnitracs is a trademark of Omnitracs, LLC. All other trademarks are the property of their respective owners.

Omnitracs endeavors to ensure that the information in this document is correct and fairly stated, but Omnitracs is not liable for any errors or omissions. Published information may not be up to date, and it is important to confirm current status with Omnitracs.

This technical data may be subject to U.S. and international export, re-export or transfer (export) laws. Diversion contrary to U.S. and international law is strictly prohibited.

Specifications subject to change without notice.

80-JE026-1 Rev. J

July 2018

Table of Contents

Before You Begin.....	vi
Safety Definitions	vi
Safety Advice	vi
1 Component Overview.....	1
IVG Display	2
Power I/O Cables.....	3
9-Pin Power I/O Cable with Standard Black Flange Connector	3
6-Pin Power I/O Cable with Standard Gray Flange Connector	4
OBDII Style Power I/O Cable for Volvo/Mack 2014 and Newer.....	4
9-pin Power I/O Cable with Black Panel Mount Connector (PACCAR).....	5
9-pin Power I/O Cable with Green Panel Mount Connector (PACCAR)	5
9-pin Power I/O Cable with Green Flange Connector	6
9-pin Power I/O Cable with Green Panel Mount	6
9-pin Power I/O Cable with Green Panel Mount (Western Star)	7
Telematics Connector I/O Cable for Hino with Blue and White Connectors.....	7
RAM Mount and Backing Plate	7
Product Documentation	8
2 Activation.....	9
Activate Online.....	9
Application Management	14
3 Installation Considerations.....	17
FCC/IC Compliance Statement	17
Installation Guidelines	18
Typical Installation Steps.....	18
Safety, Reliability, and Accessibility.....	18
Tools and Supplies Recommended for Installation	18
4 Power I/O Cable Connection	19
Connect the Power I/O Cable	20

5	IVG Installation.....	22
	Installing the Display	24
6	Optional Accessories	26
	Wired Ignition Sense	26
	Wired Ignition Sense Installation.....	26
	PTO (Power Take-off)	27
	PTO Installation	28
	Wiring to Switched +12VDC Circuit	28
	Wiring to Switched Ground Circuit.....	28
	PTO Wiring and Data Verification.....	29
	PTO Data Verification	30
	Trailer Management System.....	31
	Trailer Management System Installation	31
7	System Verification.....	33
8	Troubleshooting Best Practices.....	37
	Keep Known Good IVG Component Spares in the Shop	37
	Use a Test Cart to Perform Bad Part Verification/Double Checking	37
	Perform a Visual Inspection of the Installed IVG.....	38
	Reseat Cable.....	38
	Verify IVG Display LED Indicators are in a Normal State	38
	Check System Voltage Measurements and Grounding	38
	Replace Only Faulty Parts	38
	Determine If the Problem Is Intermittent.....	38
9	Display Screen Issues.....	39
	Screen is Dark or Blank.....	39
	Display Goes Blank When Engine is Turned Off.....	40
10	IVG Display Problems.....	41
	IVG Display Overview.....	41
	Problem: Touchscreen Non-responsive/Calibration	43
11	Cannot Send Messages.....	44

12	Cellular End to End Problems.....	45
13	Cellular Signal Strength Problems	46
14	CDD Database Sync Problem.....	48
15	GPS Fix Problem	49
16	J1587 Packet Detection Problem	51
17	J1939 Packet Detection Problem	52
18	Ignition On Detection Problem	53
19	Core Data Problem.....	54
20	IVG Display and Diagnostic LED Definitions.....	56
21	Performance Monitoring Troubleshooting.....	59
	System Overview.....	59
	Normal Performance	59
	Performance Monitoring Faults and Descriptions	61
22	Critical Event Reporting Troubleshooting.....	63
	Normal Performance	63
	Troubleshoot Abnormal Performance.....	63
	CER Verify Configuration	64
	Send a Manual CER Event.....	68
	Events Triggered in Error	68
23	Wi-Fi Troubleshooting.....	69
A	Wiring Diagrams and Charts	70
	9-Pin Power I/O Cable with Standard Black Flange Connector.....	70
	6-Pin Power I/O Cable with Standard Gray Flange Connector	72
	OBDII Power I/O Cable for Volvo/Mack 2014 and Newer	74
	9-pin Power I/O Cable with Black Panel Mount Connector (PACCAR).....	76
	9-pin Power I/O Cable with Green Panel Mount (PACCAR).....	78
	9-pin Power I/O Cable with Green Flange Connector	80
	9-pin Power I/O Cable with Green Panel Mount (New Cascadia)	82
	9-pin Power I/O Adapter Cable with Green Panel Mount (Western Star)**	84
	Telematics Connector I/O Cable for Hino with Blue and White Connectors.....	86

B	Environmental and Power Requirements	88
C	General Wiring and Installation Guidelines	89
	Standard Installation Electrical Connections	89
	Light Duty or Pick-up Truck Installation (to include any vehicle less than class 7): Cut/Splice Power I/O Cable.....	89
	Approved Omnitrac Electrical Connectors.....	90
	Wire Stripping.....	90
	Butt-Splicing	91
	Crimping.....	91
	Ring Terminals	94
	Proper Grounding.....	95
	General Installation Guidelines.....	96
	Routing and Protecting Cables	96
	Special Interior Routing Guidelines	96
	Storing Excess Cabling.....	96
	Stress Relief.....	96
D	Standard RMA Procedure	97
E	Upgrade the IVG Using USB Memory Sticks	98
	Before You Begin	98
	Requirements for Specific Services	98
	Firmware Identification and Upgrade	99
	Identify the Firmware and VIOP Versions	99
	Upgrade the IVG Firmware	100
	Upgrade the IVG Operating System.....	102
	Upgrade the IVG Map Data.....	103
	Verify the Installation	104
F	Preventive Maintenance Inspection	105
	How Often Should Inspections Be Performed?.....	105
	Performing System Verification.....	105
	Inspect the IVG Unit	106

G	Component Information	107
H	Installation Form	111
I	RF Exposure Information (SAR)	112
J	Icon Definitions.....	113

Safety Definitions

The following caution and warning definitions are intended to advise the driver when it is safe to use a display unit or when there is the potential for injury or damage during installation.

CAUTION indicates a potentially hazardous situation which, if not avoided, may result in minor or moderate injury. It may also be used to alert against unsafe practices.

WARNING indicates a potentially hazardous situation which, if not avoided, could result in death or serious injury.

Safety Advice

The following safety advice is provided for drivers, installers, and application developers who use and/or locate all types of display units.

Drivers – Do not use a display unit when the vehicle is in motion.

Installers – Do not locate the display unit, including third-party devices, where it obstructs the driver's field of vision, distracts the driver from the driving task, or interferes with the driver's operation of controls or instruments. The following is displayed when ignition is turned on.

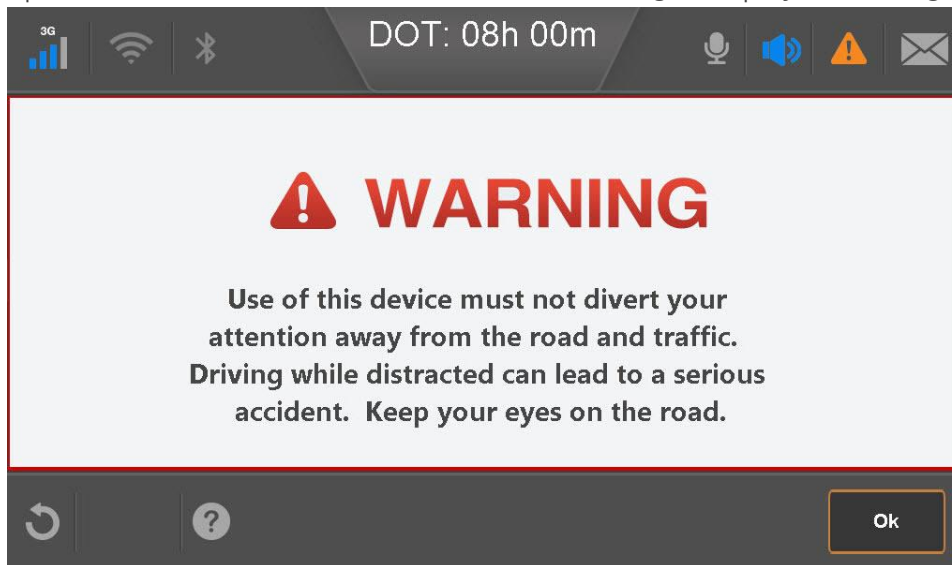

If you are a third-party device manufacturer or application developer, you must provide appropriate warnings regarding the safe use of your device(s) in conjunction with Omnitrac's equipment. Applications should not require the driver to divert his attention from the road while driving a vehicle.

1 Component Overview



The IVG system components include:

- Color, graphical touchscreen display and holster
- Power I/O cable
- RAM mount
- Hardware and fasteners

IVG Display

- On the front
 - Color, graphical touchscreen
 - Virtual on-screen keyboard
 - Home button and volume/brightness controls at the bottom, center
- On the right side
 - USB v2.0 ports
 - Diagnostic LEDs
- On the left side
 - Micro SD slot
 - Reset button



The diagnostic LEDs used in troubleshooting are detailed in *Chapter 20: IVG Diagnostic LEDs*.



The holster provides a secure mount for the display when it is unused while the truck is moving.



Power I/O Cables

Power I/O cables are either generic or may be specific to the year, make, and model of your truck. Be sure to have the correct cable on hand before you begin your installation.

9-Pin Power I/O Cable with Standard Black Flange Connector

This cable connects to a truck's 9-pin diagnostic connector for power and vehicle data on either J1587 or J1939 data links. This connector, used on most 2006 to 2015 trucks, has a flange around the plug as it clips into the truck's mounting place vacated by the factory plug where it connects to the truck's dash.



6-Pin Power I/O Cable with Standard Gray Flange Connector

This cable connects to older model year trucks (1993 to 2005 models) that have a 6-pin diagnostic connector for power and vehicle data on J1708/J1587 data link.



OBDII Style Power I/O Cable for Volvo/Mack 2014 and Newer

This cable is used for Volvo trucks 2014 or newer with Volvo engines and Mack trucks 2014 or newer with Mack engines using a diagnostic connector that resembles a standard automotive OBDII connector. This connector provides constant power and vehicle data from J1939, not via the OBDII protocol.



9-pin Power I/O Cable with Black Panel Mount Connector (PACCAR)

For use with approximately 2008 through 2015 Peterbilt and Kenworth trucks using a plastic nut to secure connector to dash. This cable connects to a truck's 9-pin diagnostic connector for power and vehicle data on either J1587 or J1939 (pin C and pin D) data links. The panel mount connector is secured to the dash with a plastic nut.



9-pin Power I/O Cable with Green Panel Mount Connector (PACCAR)

This cable is for Peterbilt and Kenworth trucks built in 2016 and later with green diagnostic connectors. It connects to the truck's 9-pin green diagnostic connector for power and the J1939 (pin F and pin G) for vehicle data. The panel mount connector is secured to the dash with a plastic nut.



9-pin Power I/O Cable with Green Flange Connector

This cable is for 2016 and newer Classic Cascadia Freightliner's P3 and M2 trucks with green diagnostic connectors. These are trucks with 500 kbps, green diagnostic connectors. It connects to a truck's 9-pin diagnostic connector for power and J1939 500 kbps vehicle data. This connector has a flange on the end where connected to the truck's dash.



9-pin Power I/O Cable with Green Panel Mount

This cable is for the Freightliner New Cascadia (P4) trucks built in 2017 and later with green panel mount diagnostic connectors. It connects to the truck's 9-pin green diagnostic connector for power and the J1939 vehicle splice pack located near the 9-pin diagnostic connector for vehicle data. The panel mount connector is secured to the dash with a plastic nut.



9-pin Power I/O Cable with Green Panel Mount (Western Star)

2017 and newer Western Star trucks use a unique panel mount connector with a plastic nut. You must install the Freightliner flange mount cable with the Western Star adapter cable.



Telematics Connector I/O Cable for Hino with Blue and White Connectors

This cable is for late model 2011 and 2012 or newer Hino trucks, and lets you connect directly to the Hino Telematics connector. The white connector is for Japanese manufactured trucks and the blue connector is for U.S.-manufactured trucks (only one or the other is used on each truck and they do not “Y” into the truck).

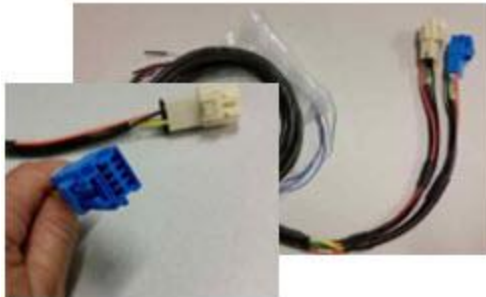

RAM Mount and Backing Plate

Used for mounting the display holster to the dash (it has a 3-inch arm).



Always use the supplied backing plate and screws to strengthen the support for the RAM mount.



There is a mounting kit specific to the Freightliner Columbia or Century with a different backing plate. See *Appendix G: Component Information* for details.

Product Documentation

Ensure you leave the following documents in the cab of the vehicle.

- IVG Getting Started Guide (80-JE014-1)
- HOS DOT Quick Reference Card for IVG (80-JE015-1) – for US drivers
- HOS MOT Quick Reference Card for IVG (80-JE016-1) – for Canadian driver

2 Activation

IVG units purchased directly from Omnitrac's don't require activation. Units purchased from a channel partner must be activated.

Online activation process must be completed at least 24 hours prior to installation. This assigns the unit to the correct customer account and registers it on the cellular network.

Activate Online

IVG activation requires access to the Customer Portal and permission to activate units. Because the online activation process may take **up to two hours to complete**, contractors and Service Centers must coordinate with customers to activate and install units.

To perform the online activation:

1. Using your supplied credentials, log into: <https://customer.omnitrac.com>.
2. Click **Activations**.

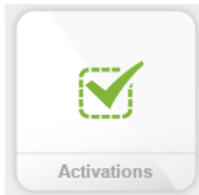









3. Under *Omnitracs IVG System Activation*, click **Continue**.

Activate MCP50 and Omnitracs® IVG Units

 **IMPORTANT** Activate your new or replacement units prior to installation. Activate only those units you intend to install. You need the MCP50 VTM or Omnitracs® IVG serial number, and [verification codes if purchased from a partner](#). There is a new process to activate your units. See the video [here](#).

 You have units that are not active. Activate them 2 hours before installation.

Please Make a Selection

<p> MCP50 System Activation</p> <p>Activate MCP50 VTMs on the terrestrial network</p> <p>Continue </p>	<p> Search Unit Activations</p> <p>Search by serial number to see activation status</p> <p>Continue </p>
<p> Omnitracs® IVG System Activation</p> <p>Activate Omnitracs® IVG units on the terrestrial network</p> <p>Continue </p>	<p> Activation History</p> <p>Activation Request History</p> <p>Continue </p>

4. Select the UA of units you plan to install.

Select Omnitrac® IVG Units to activate

Select Omnitrac® IVG Units from the list below or enter the serial number on the optional Enter Units tab.

Click **Add Selected Units** and then click **Continue**.



Omnitrac® IVG

Select Units | Enter Units

Select	SerialNumber
<input type="checkbox"/>	108001069
<input type="checkbox"/>	108001070
<input type="checkbox"/>	108001071
<input type="checkbox"/>	108001076
<input type="checkbox"/>	108001082

110 Available
0 Selected

Add Selected Units

Cancel | Continue

5. Click **Add Selected Units**. The VTM's added will be shown in the top right corner.

Select Omnitrac® IVG Units to activate

Select Omnitrac® IVG Units from the list below or enter the serial number on the optional Enter Units tab.
Click **Add Selected Units** and then click **Continue**.

Omnitrac® IVG

Select Units | Enter Units

Select	SerialNumber
<input type="checkbox"/>	108001070
<input type="checkbox"/>	108001071
<input type="checkbox"/>	108001076
<input type="checkbox"/>	108001082
<input type="checkbox"/>	108001083

109 Available
0 Selected

Add Selected Units

Cancel | Continue

If you have a list of units to activate, click the Enter Units tab, paste the list, and click **Validate & Add**.

6. Click **Continue**.
7. Verify that these are the units you want to install; then click **Submit**.

Review units to activate [modify](#)

Confirm that these are the units you're going to install.

1 Omnitrac® IVG(s)

Serial Number
108001069

Cancel | Submit

You are notified that the activation process has begun. This process could take up to two hours to complete.

To verify that the unit you are installing is activated:

1. Under *Activation History*, click **Continue**.
2. Choose what types of activations you want to see.

A screen similar to the following displays.

Reference #	Activation Type	Date Submitted	Status	Submitted By
117404	NEW	02/15/2016	Closed	Analilia Najera
69928	NEW	11/07/2014	Closed	
66816	NEW	10/10/2014	Closed	
66411	NEW	10/07/2014	Closed	
66046	NEW	10/02/2014	Closed	
66045	NEW	10/02/2014	Closed	
63591	NEW	09/08/2014	Closed	
63259	NEW	09/03/2014	Closed	
63258	NEW	09/03/2014	Closed	
60445	NEW	08/01/2014	Closed	Victor Aidis

Total: 28

If your unit is listed here, it's ready to be installed.

Application Management

Customers enable applications on units through operational profiles. Applications that are not enabled cannot be selected on the IVG display and are grayed out.

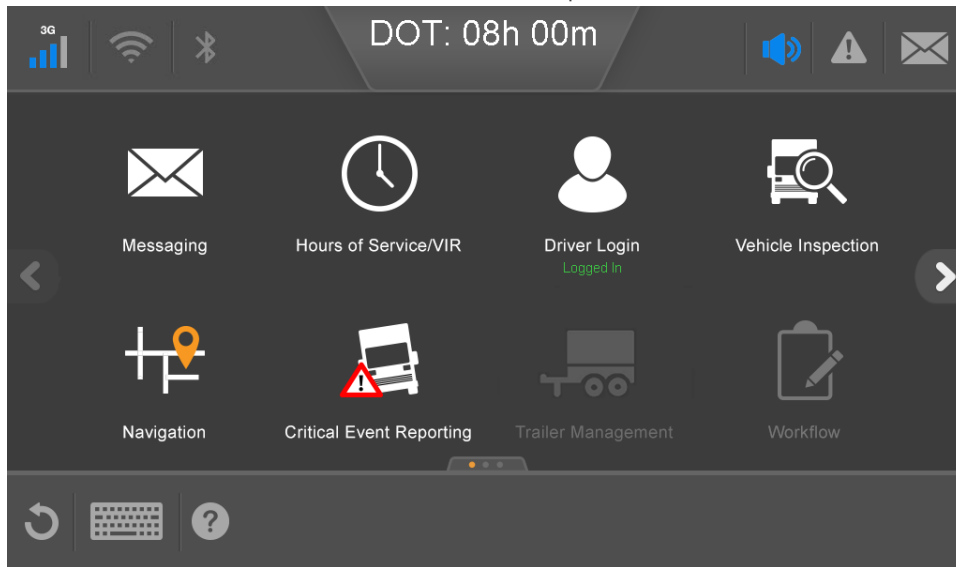

A driver must be logged in for enabled applications to be selectable.

1. To make changes to any operational profile, from the Customer Portal home page, click **Op Profiles**.

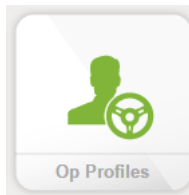











2. Click **Continue** under *Manage Operational Profiles*.

Operational Profiles



Operational Profiles are used to group trucks or vehicles by a set of active applications. You will see an initial Operational Profile for active units and another one for inactive units. You will need to create additional profiles as necessary.

Please Make a Selection

 Manage Operational Profiles Click to view current profiles Continue 	 Create New Profiles Click to create a new or copy an existing profile. Continue 
 Move Units Click to move units between profiles. Continue 	 Locate a Unit Click to find the profile a unit is in. Continue 
 Deleted Profiles Click to view previously deleted profiles Continue 	 Data Plan Usage Reports Click to review terrestrial browsing usage data Continue 

From the Operational Profile page you can create or modify existing op profiles. See the Customer Portal Support for details.

Operational Profiles
Create New Profile

Omnitracs® IVG

Click here to disable Platform Apps

Total Units 239 [View Reduced App List](#)

Profile Name	# of Units	Services	Last Modified	Action
032016_ERD	1	Premium Plan CER Add-on - ABS CER Add-on - Forward Collision Warning and Follow Time Violation CER Add-on - Over Speed Events Critical Event Reporting Driver Login Fault Monitoring Hours of Service Odometer Positions Performance Monitoring State Miles Counter Vehicle Inspection Report	04/30/2016	I want to...
102815-IVG	0	Performance Plan Critical Event Reporting Odometer Positions Performance Monitoring State Miles Counter	10/18/2015	I want to...

3 Installation Considerations

FCC/IC Compliance Statement

This device complies with part 15 of the FCC Rules. Operation is subject to the following two conditions:

- This device may not cause harmful interference, and
- This device must accept any interference received, including interference that may cause undesired operation.

This equipment has been tested and found to comply with the limits for a Class A digital device, pursuant to part 15 of the FCC Rules. These limits are designed to provide reasonable protection against harmful interference when the equipment is operated in a commercial environment. This equipment generates, uses, and can radiate radio frequency energy and, if not installed and used in accordance with the instruction manual, may cause harmful interference to radio communications. Operation of this equipment in a residential area is likely to cause harmful interference in which case the user will be required to correct the interference at his own expense.

CAUTION

Any changes or modifications not expressly approved by the party responsible for compliance to this equipment would void the user's authority to operate this device.

This device complies with Industry Canada's license-exempt RSSs. Operation is subject to the following two conditions:

- This device may not cause interference.
- This device must accept any interference, including interference that may cause undesired operation of the device.

Le présent appareil est conforme aux CNR d'Industrie Canada applicables aux appareils radio exempts de licence. L'exploitation est autorisée aux deux conditions suivantes:

- 1) l'appareil ne doit pas produire de brouillage;
- 2) l'utilisateur de l'appareil doit accepter tout brouillage radioélectrique subi, même si le brouillage est susceptible d'en compromettre le fonctionnement.

CAN ICES-3 (A)/NMB-3(A)

Refer to *Appendix I: RF Exposure (SAR)* for specific absorption rates information.

Installation Guidelines

Typical Installation Steps

1. Activate the IVG online at least one day prior to installation.
2. Install the power I/O cable then the IVG display.
3. Run system verification.

Safety, Reliability, and Accessibility

- Use eye protection when using a drill/performing work that may be hazardous to the eyes.
- Use ear protection in noisy work areas.
- Wear appropriate clothing/uniforms and safety shoes.
- Maintain three points of contact when climbing in and out of cab.
- Make sure you know what is behind the area before you drill.
- Install equipment so it will not cause damage to the vehicle or work loose over time.
- Make sure there are no loose components/cables and no unsecured components.
- Use solid mounting surfaces.
- Route all cables away from hot or abrasive areas.
- Choose installation locations where components can be easily serviced.
- Choose installation locations where components are safe from tampering and damage.

Tools and Supplies Recommended for Installation

- Crimpers
- Diagonal wire cutters
- Wire strippers
- Screwdrivers: Phillips #2 and slotted
- Torx drivers: #10, #20 and #25
- Volt/Ohm meter
- Flush cutters
- Flash/Drop light

4 Power I/O Cable Connection

The power I/O cable is used to connect to a truck's diagnostic connector. It provides both power and the necessary vehicle data for the IVG system. There are multiple masterpacks depending on the truck type. See the individual *Truck Installation Suggestion* documents for more information. See Appendix G: Component Information for more information.

Cable	Trucks
9-Pin Power I/O Cable with Black Standard Flange Connector	Most 2006 to 2015 trucks
6-Pin Power I/O Cable with Grey Standard Flange Connector	Most 2005 and older trucks
Power I/O Cable with OBDII Style Connector	Volvo Trucks 2014 or newer with Volvo Engines and Mack Trucks 2014 or newer with Mack Engines
9-Pin Power I/O Cable with Black Panel Mount Connector (PACCAR)	For approx. 2008 through 2015 Peterbilt and Kenworth trucks using ring nut to secure connector to dash
9-Pin Power I/O Cable with Green Standard Flange Connector	For 2016 or newer Daimler and Navistar vehicles trucks with green diagnostic connectors
9-Pin Power I/O Cable with Green Panel Mount Connector (PACCAR)	For 2016 or newer Peterbilt and Kenworth vehicles trucks with green panel mount diagnostic connectors using plastic nut to secure connector to dash.
9-Pin Power I/O Cable with Green Panel Mount Connector (Freightliner – New Cascadia P4)	For 2017 and newer Freightliner NEW CASCADIA (P4) trucks with green diagnostic connectors using plastic nut to secure connector to dash.
Telematics Connector I/O Cable for Hino with Blue and White Connectors	For late model 2011 and 2012 or newer Hino trucks



If the power I/O cable connector does not connect to the truck's diagnostic connector, you must cut off the Y portion of the power I/O cable and crimp-splice the wires. See *Appendix C General Wiring and Installation Guidelines* for instructions.

Connect the Power I/O Cable

1. With the truck's ignition off, remove and push back existing truck diagnostic connector; then check the connector to verify it's clean of debris and there are no bent pins.
2. Connect the power I/O cable's mating connector to the truck's diagnostic connector, verifying that the outer ring twists-and-clicks into place so that the ends are not accidentally disconnected; then verify by pull-testing the connector.



3. Put the unused power I/O cable end where the truck's diagnostic connector was located in the dash panel.
4. Route the power cable to the IVG display location.
5. Remove the Torx 10 screws from the door panel on back side of IVG display and connect the power cable to the IVG display. Ensure the cable latches solidly with the ridge side of the connector facing outward.



6. Replace door panel and secure any excess cable using tie-wraps.

5 IVG Installation

Before you begin the installation, inspect the vehicle to determine an installation location.

WARNING

Do not locate the display unit where it obstructs the driver's field of vision, distracts the driver from the driving task, interferes with the driver's operation of controls or displays, or creates a safety hazard. Follow all laws and regulations governing the placement of equipment and mounts.

DO locate the display where it:

- Can be safely installed on a secured bracket that is robust enough to minimize any vibration and sustain the weight of the display.
- Has a flat mounting surface that is strong enough to support the mounting hardware.
- Is in the driver's line-of-sight, easy to touch, but does not block the view of the road or mirrors.
- Is clear of dash controls and gauges.
- Is not mounted in constant, direct sunlight.
- Does not limit a passenger's leg room or block access to any other compartments.
- Does not interfere with anyone entering or exiting the vehicle cab.
- Is not likely to impact the driver or passenger in case of an accident or collision.

DO NOT locate the display where it:

- Obstructs the driver's field of vision.
- Distracts the driver from the driving task.
- Interferes with the driver's operation of controls or shifting.
- Obstructs the area swept by the windshield wipers.
- Blocks the deployment of an airbag.

Additional information for selecting an installation location:

- Installations should not obstruct the driver's field of vision while operating the vehicle, and should comply with all applicable federal and state laws and regulations regarding appropriate installation locations (including restrictions against the mounting of objects on a vehicle's windshield) and driver distraction.
- Consider the owner's preference in selecting the installation location and whether there is a team or a single driver.



- To adhere to the ELD mandate, the IVG display must reach to both the driver and passenger windows.



Installing the Display

Included with the IVG system is RAM mounting hardware. Always use the supplied backing plate and screws to strengthen the support for the mount. **Never use tech screws.**

1. After a suitable location is selected, verify that there is nothing behind the mounting surface that might be damaged by drilling holes.
2. Drill 3/16" or 1/4" holes for the mounting bracket and backing plate using the backing plate as a template.



3. Attach the RAM mount ball joint to the dash using the supplied 8x32 screws, lock washers, and backing plate. This hardware is included with the RAM mount kit.
4. Attach the other RAM mount ball-joint to the holster using supplied screws and lock washers. The supplied screws are 1/2" long. **DO NOT** use screws that are too long or they will protrude into the holster and bubble the surface.



5. Join the holster-side ball joint to the dash-side ball joint using the RAM mount arm. Loosen the arm lever and adjust the holster to the desired position; then tighten the arm lever to secure assembly into place. Be sure the arm is loosened prior to making

adjustments; then re-tightened to secure in place.



6. Snap the display into the holster by placing the bottom into the lower holster tabs and then push the top into the upper holster tab.
7. Allow enough display cable slack so the display can reach the driver and passenger windows.

WARNING

Excess cable can be a tripping hazard. Ensure cable is not draped where it will interfere with either the driver or passenger as they move within the cab.

8. Add a tiewrap strain relief to the display cable where it comes out from under or behind the dash so it can't be pulled out further. Verify that the display can reach both the driver and passenger windows and secure with tie wrap.

6 Optional Accessories

Optional accessories include:

- Wired Ignition Sense (AUX_IN/DIGIN_2)
- PTO (power take-off) (PTO/DIGIN_1)
- Trailer Management System (TTRACS_IN)
- Panic Button (PANIC_LOW and PANIC_HIGH)
- Detect Tamper (DT)

Wired Ignition Sense

By default, an IVG system automatically senses ignition state and detects if the truck's ignition is ON or OFF with engine running only. When the IVG's power I/O cable is connected to the truck's diagnostic connector, it senses ignition when RPMs are detected from the truck's databus. This means the engine must be started/running for ignition to be detected as ON. Turning the key to the ON position does not wakeup an IVG unit that is asleep with FW less than DA0500R.

Alternatively, you can hard wire the AUX_IN/DIGIN_2 wire to a 12-volt ignition-switched source in the truck. To use this method, the IVG system will need to be configured properly by Omnitracs. With this option, ignition state is sensed when the IVG senses a 12-volt signal on the AUX_IN/DIGIN_2 wire and the engine doesn't have to be started to wake up a sleeping IVG. If connecting the AUX_IN/DIGIN_2 wire, call the hotline and ask that CDEF444 be disabled on that IVG unit.

Wired Ignition Sense Installation

1. Use a multimeter to identify a good, 12-volt ignition-switched source in the truck (not accessory).

Because Freightliner Cascadia truck have a multiplexed source that will experience voltage drops, we do not recommend going to the ignition switch.

2. Connect the AUX_IN/DIGIN_2 wire to the ignition source and add a fused connector (not supplied). A 3amp fuse should be used.



3. Contact Omnitracs Support at 800-541-7490 and request that CDEF444, auto ignition sense, be disabled.

PTO (Power Take-off)

This option lets you identify and segregate the time the vehicle engine is used for operational idle purposes, such as when it is powering auxiliary devices using a pump or compressor.

The screenshot displays the 'Performance Monitoring' interface for driver FABIAN ARROYO. The DOT is 07h 43m. The 'PTO' tab is selected, showing the following data:

Driver: FABIAN ARROYO		Total Active Time: 02:10:04
PTO: Enabled	Compressor Revs: 0	Compressor: ● N
Delay: 0m00s	Pump Revs: 0	Pump: ● Y
PTO Fuel: 0.0 g	Eng/1708 Revs: 0	Engine: ● N
PTO Time: 0m00s		

To log PTO time, you must connect the loose white/black wire labeled PTO/DIGIN_1 in the power I/O cable. The IVG system detects an active PTO device when it sees 12 volts (active high) on this PTO/DIGIN_1 wire, non-zero RPMs, and speed < 20 MPH. A PTO switch that goes active to ground will require a relay for the 12-volt detection.

PTO Installation

Use a multimeter to determine which type of PTO circuit you are connecting to when engaging the PTO switch.

Wiring to Switched +12VDC Circuit

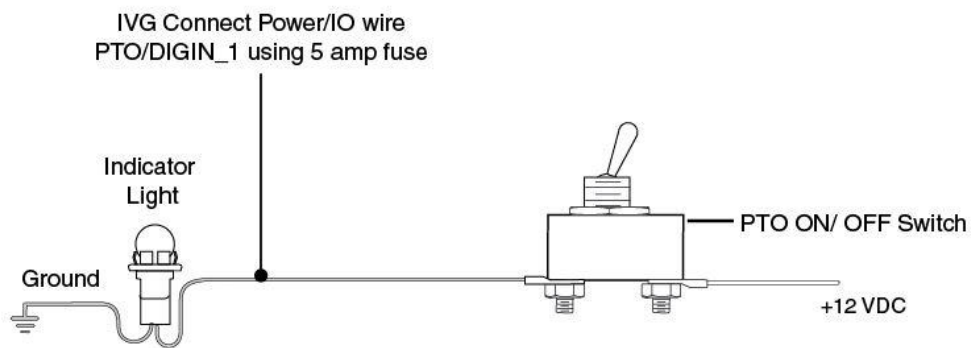

04AAA_217AQMCP

Wiring to Switched Ground Circuit

If you have a switched circuit that is activated to the ground to detect PTO time, a relay must be used.

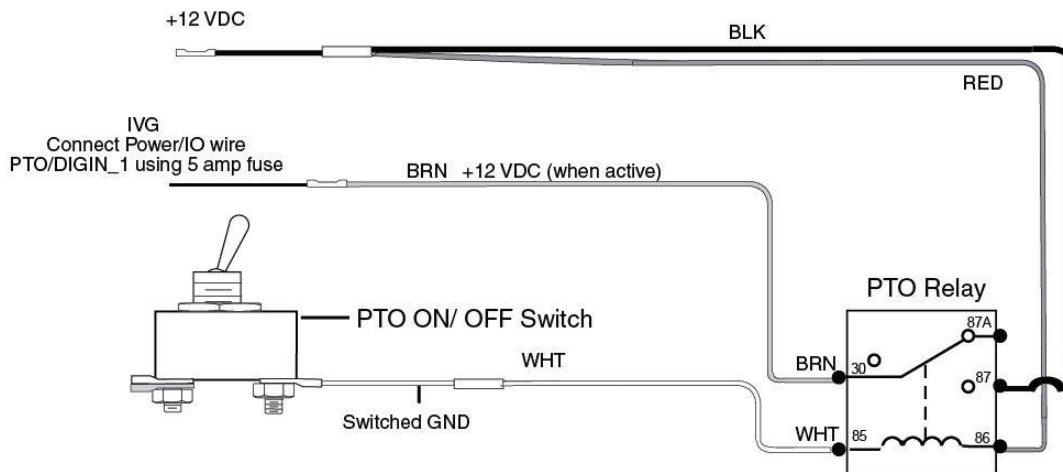

08AAA_062

PTO Wiring and Data Verification

1. Start the vehicle.
2. Turn the PTO switch ON.
3. Navigate to the **System VDS** screen.
4. Tap the **Load VDS UI** button.

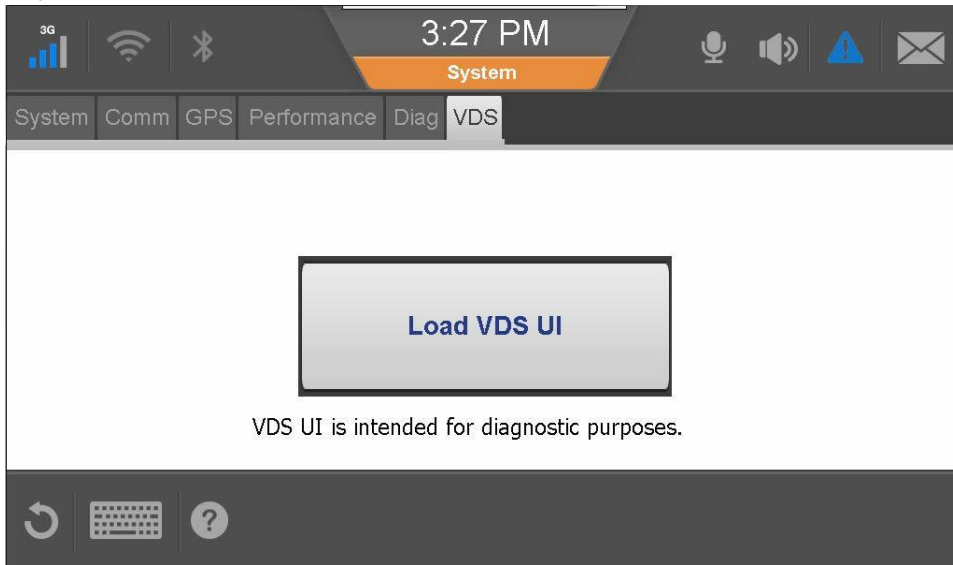

5. Verify the PTOC has a green dot under the Index column and shows "On" under the **State** column.

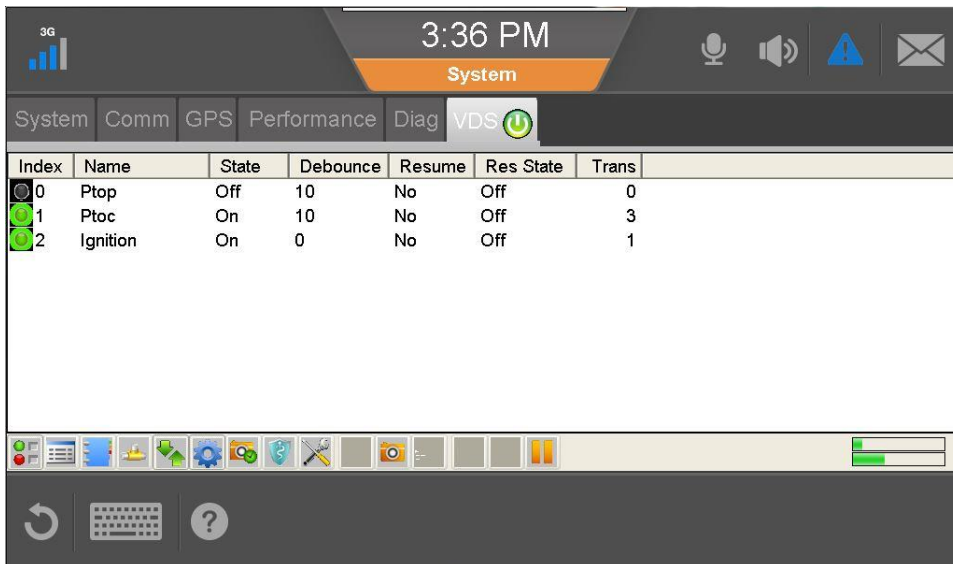

The field PTOC corresponds to PTO/DIGIN_1 in wire in the wire harness. If PTOC is not showing a green dot or ON, check the PTO wire connections.

6. Turn off PTO device. The green dot and state change to a black dot and "Off".

The PTO wire installation verification is complete. Now you can verify that the application is recording data correctly.

PTO Data Verification

1. Start the vehicle and with the PTO switch **ON**, navigate to Performance Monitoring.
2. Navigate to the PTO screen, tap the **Performance Monitoring** button; then tap the **PTO** tab.

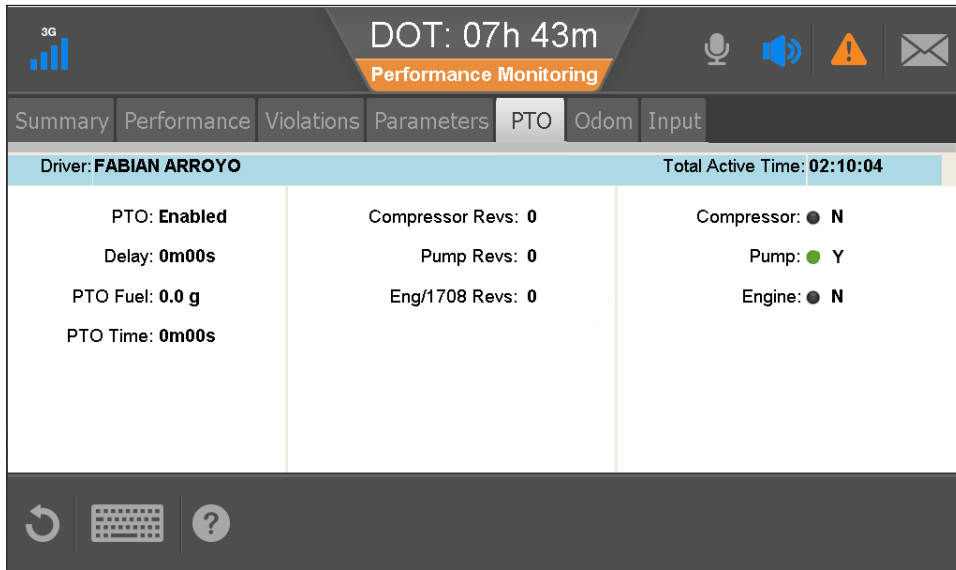

If the Performance Monitoring button is grayed out, Performance Monitoring is not enabled and you must contact the company admin for Omnitrac to have it enabled. Additionally, the IVG must download Performance Monitoring parameters for Performance Monitoring metrics to be recorded correctly.

3. Verify that: PTO is Enabled, a green indicator light displays next to the active PTO device, and the active Compressor or Pump displays a Y.
4. Check that the **PTO Time** field is incrementing.
 - If yes, PTO verification is complete.
 - If no, check the wire connections.
5. Turn off PTO device. PTO time should now stop incrementing.

For PTO time to be recorded in Performance Monitoring, RPM must be >0, speed <20 mph, and the customer-configured PTO time delay must be reached.

Trailer Management System

Trailer Management or Trailer Tracks monitors trailer connects and disconnects; then passes the date, time, and location to dispatch. Additionally, if an Omnitrac TT100, TT200, or TT210 system is connected to the trailer's refrigeration unit, alarms and regular temperature readings can be passed on to dispatch.

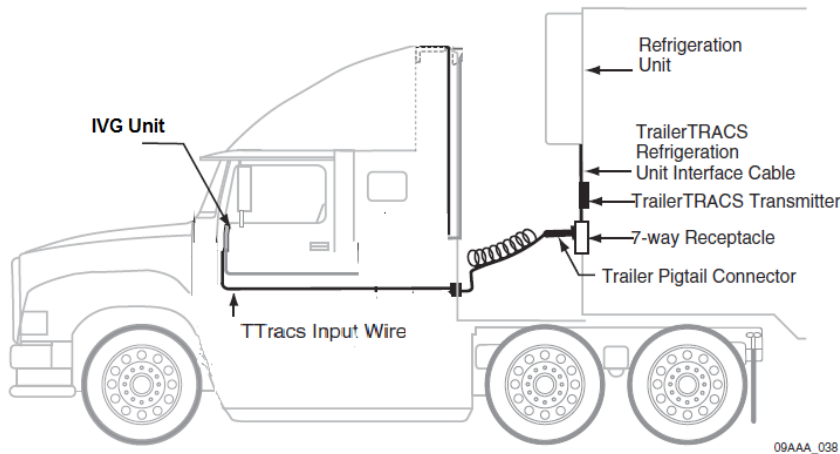

Trailer Management System Installation

1. Install a 5-amp fuse to the TTRACS_IN wire in the IVG's power I/O cable.
2. Butt-splice the protected end of the 5-amp fuse to the trailer auxiliary connection point.

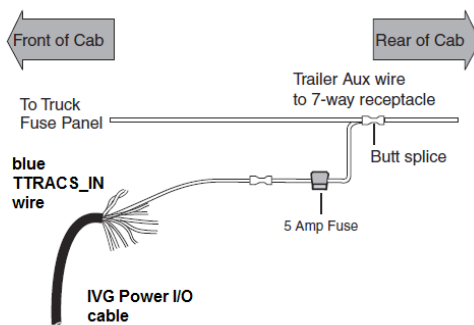

3. Connect the IVG-equipped tractor to a trailer equipped with an Omnitrac TT100, TT200, or TT210 unit.

4. On the IVG, tap the Trailer Management button.

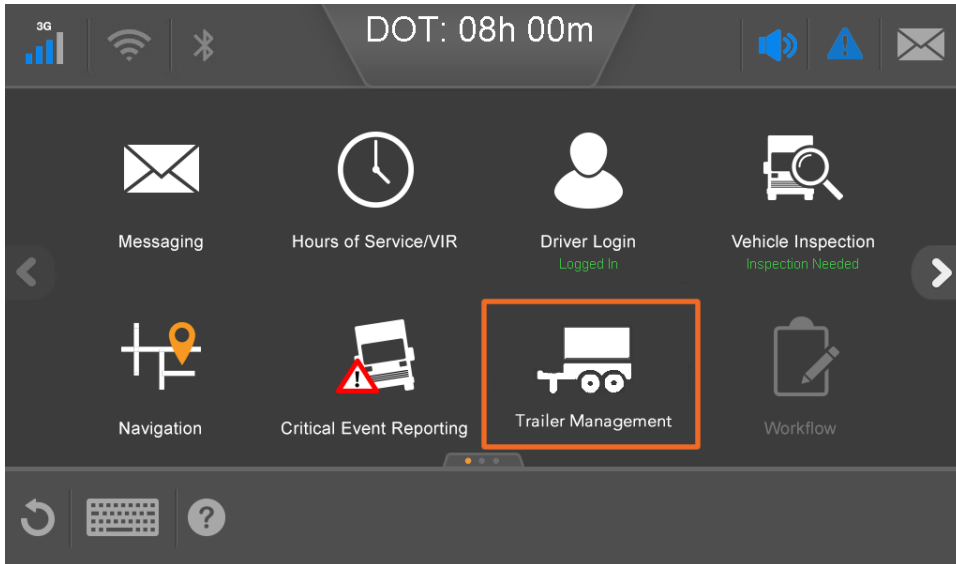

5. With the tractor's engine running, the TT100, TT200, or TT210 share its ID with the IVG system and displays on the screen.

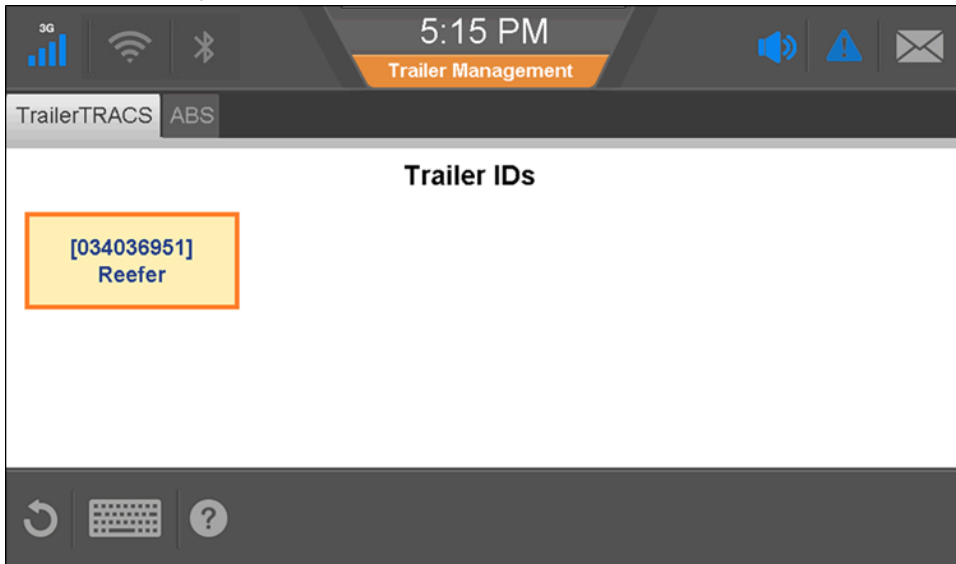

7 System Verification

Shortly after you power up the IVG and the engine is started, the **Driver Warning** screen appears. After tapping the **OK** button, the IVG **Home** screen displays.

1. Tap the arrow on the right until you see the System button, then tap the **System** button.

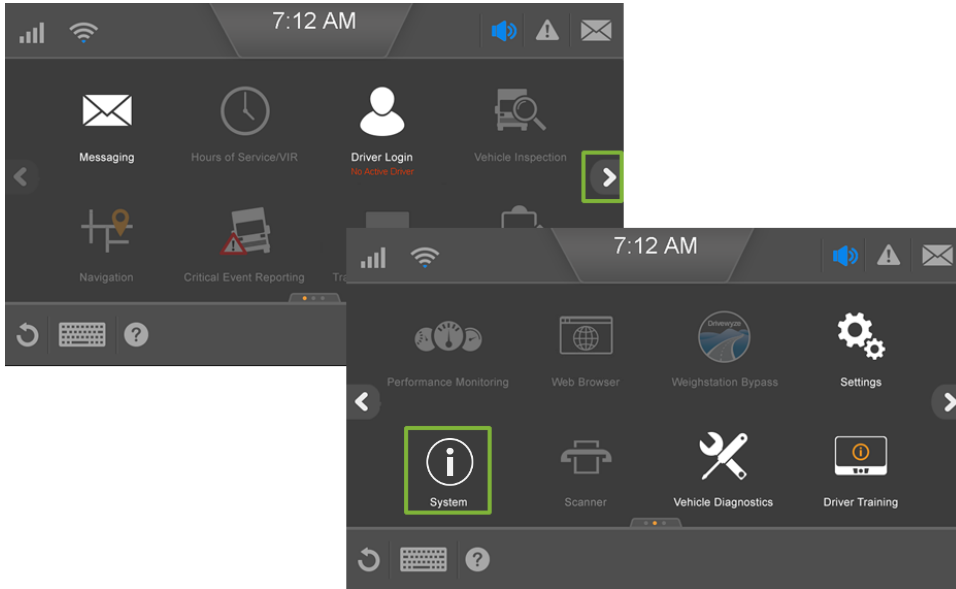

2. Tap the **Diag** tab.

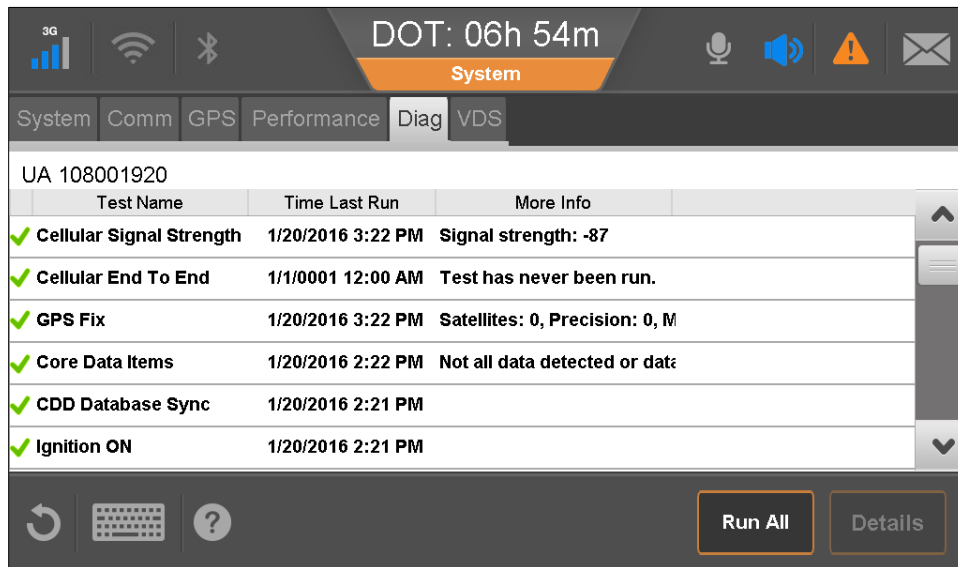

3. With the engine running, tap the **Run All** button at the bottom of the screen. The system runs tests on all listed items; then displays the results. There are double-headed

orange arrows in front of each test while it runs.

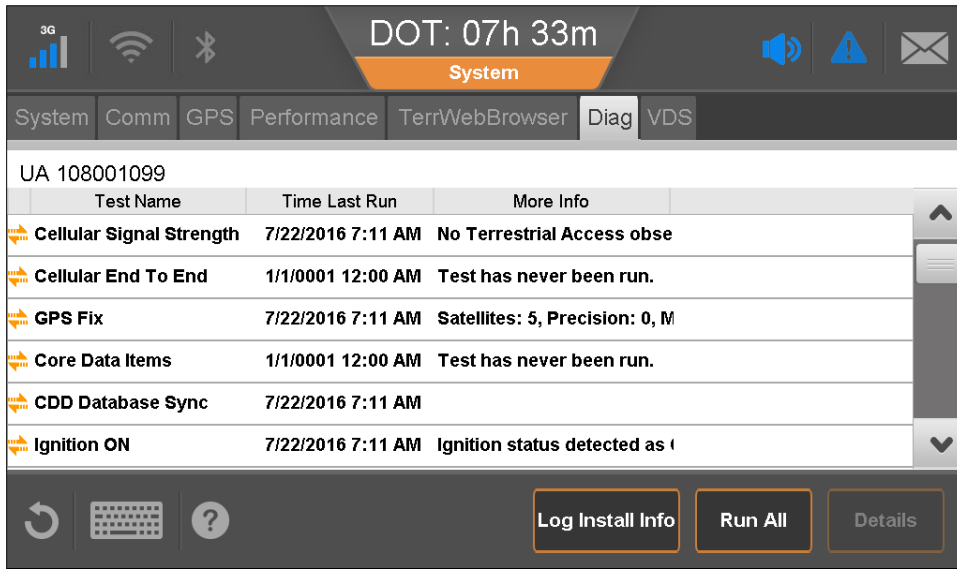

If the test passes, a green check (✓) is shown. If the test fails, a red X is shown.

Green checkmarks next to Cellular Signal Strength, Cellular End to End, GPS, and Core Data Items are required for the IVG system to be ready.

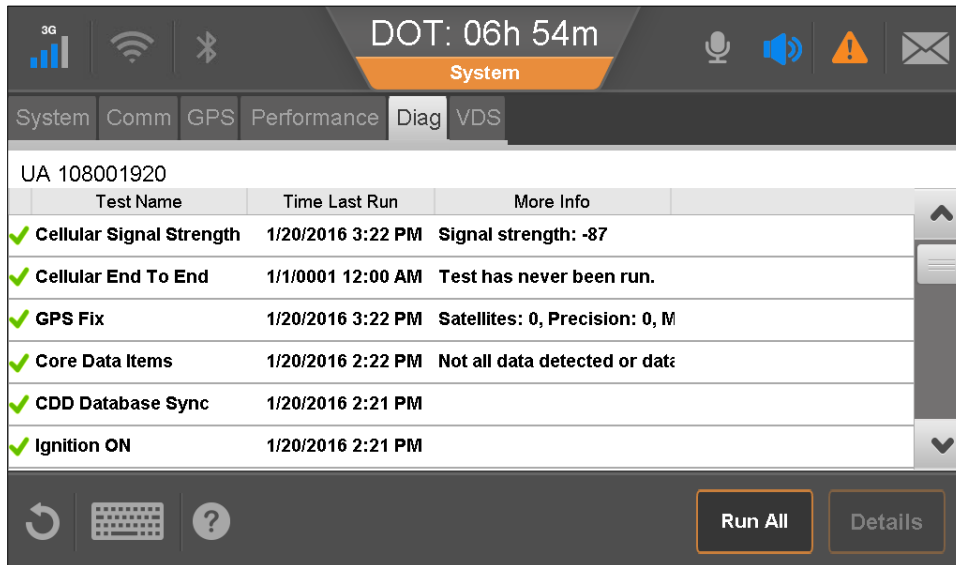

Item	Description
Cellular Signal Strength	Passed – you’re in good cellular network coverage. Failed – see <i>Chapter 13: Cellular Signal Strength Problems</i> .
Cellular End To End	Passed – the unit successfully communicated with Omnitrac and received an acknowledgement. Failed – see <i>Chapter 12: Cellular End to End Problems</i> .
GPS fix test	Passed – the GPS network is detected and getting a 3D fix. Failed – see <i>Chapter 15: GPS Fix Problem</i> .
Core Data Items	Passed – the Speed, RPM, Distance LTD, and Fuel LTD is being detected. Failed – see <i>Chapter 19: Core Data Problem</i> .
CDD Database Sync	Passed – the IVG’s database synchronized with Omnitrac network operations center (usually take 5 to 10 minutes after unit is first powered up). Failed – see <i>Chapter 14: CDD Database Sync Problem</i> .
Ignition On	Passed – the IVG can detect that ignition is ON. Failed – see <i>Chapter 18: Ignition On Detection Problem</i> .

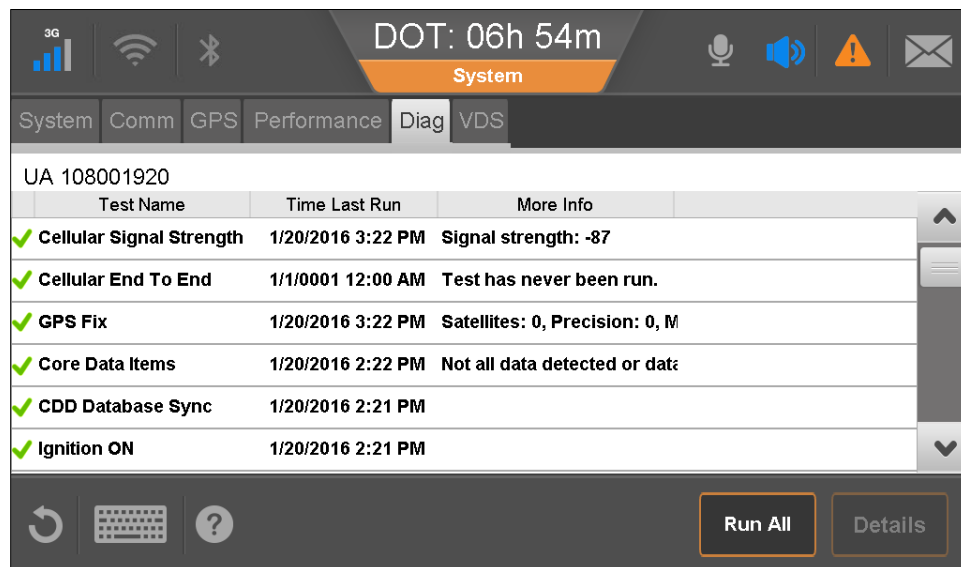

Field	Definition
J1939 Packet Detection	Passed – the IVG is connected to the J1939 databus, and the running vehicle is providing J1939 data. Some vehicles do not have the J1939 bus. Failed – see <i>Chapter 17: J1939 Packet Detection Problem</i> .
J1587 Packet Detection	Passed – the IVG is connected to the J1587 databus, and the running vehicle is providing J1587 data. Some vehicles do not have the J1587 bus. Failed – see <i>Chapter 16: J1587 Packet Detection Problem</i> .
CDD and Ignition On	Show green checkmarks.

Select a parameter and click **Details** for more information. *Chapter 19: Core Data Problem*, provides troubleshooting steps for the Core Data Items.

If the results of the **Run All** tests are acceptable, send a test message from the IVG and verify that it gets a green check mark (may take up to 1 minute). After that is complete, look in the OUT BOX on the display to see if you have received a green check mark on your test message. You have successfully sent and received a message back to the display if you see the green check marks.

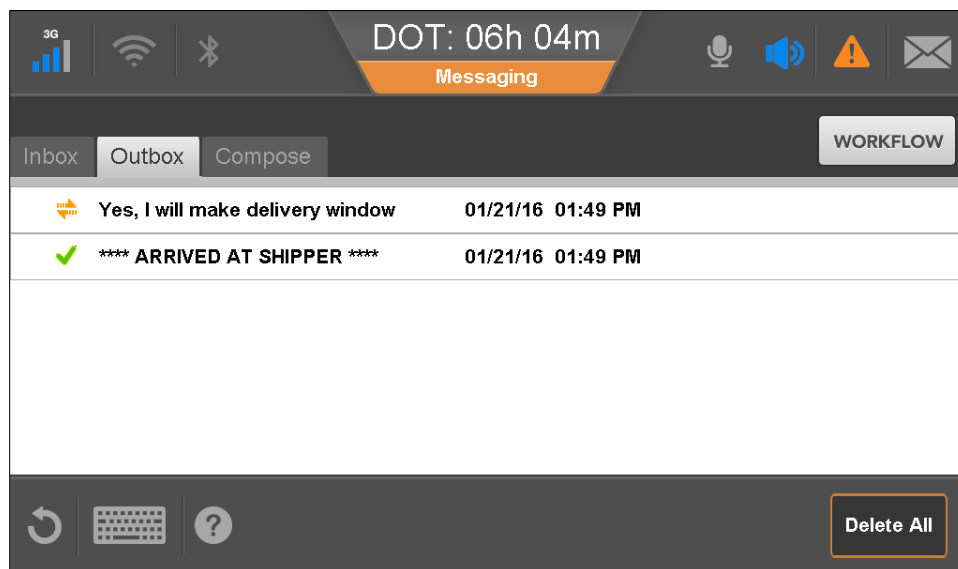

When you are done with these steps, System Verification is complete.

8 Troubleshooting Best Practices

Keep Known Good IVG Component Spares in the Shop

Spare parts should include:

- IVG system
- IVG power I/O cable

Use a Test Cart to Perform Bad Part Verification/Double Checking

If an Omnitrac's IVG part is diagnosed "bad" on a truck, install the failed part on a test cart or another truck that has an installation that is known to be good.

- If the part continues to fail, the part should be RMA-ed or replaced.
- If the suspect part does not fail on the test cart, further troubleshooting is necessary.



Perform a Visual Inspection of the Installed IVG

- Check for damaged cables, improper electrical connections, loose connections, and the integrity of the installation.
- Bad mounts can contribute to system problems.
- Loose diagnostic connectors or parts that are not installed properly can allow excessive vibration which can affect system performance.

Reseat Cable

- Always inspect and reseat the cable connector prior to replacing the IVG display.
- Check for pinched cables.
- Inspect for corrosion and bent, broken, pushed-in, missing pins, and/or sockets.

Verify IVG Display LED Indicators are in a Normal State

When booting up, several of the LEDs will blink. See *Chapter 20: IVG Display LED Indicators* for different indicator states.

Check System Voltage Measurements and Grounding

- Use the same ground reference in diagnostic connector.
- Verify that vehicle battery and cables are in good condition.
- Verify that vehicle has a constant battery reading at the diagnostic connector (see Appendix A for Diagnostic cable pin-outs).
- Check voltages. See *Appendix A: Wiring Diagrams and Charts* for more information.

Replace Only Faulty Parts

Typically, only one part is bad. After the system is operating, you can substitute suspect parts back into the system to verify which part is bad, or use a test cart equipped with known-good spare parts to retest suspect parts.

Determine If the Problem Is Intermittent

Check for bad or loose electrical connections including cable connectors, ring terminals, butt-splices, and power/ground connections. These can contribute to intermittent system performance.

9 Display Screen Issues

Screen is Dark or Blank

The display could be blank or dark if the:

- Engine is not running and unit is asleep (i.e. ignition detected as OFF and power down timer exceeded)
- Power source or power I/O cable has problem
- Display is faulty

To test the display

1. Start the vehicle engine.
2. See if the LEDs on the right side of the IVG display are active. See *Chapter 20: IVG Display LED Indicators* for normal LED operation.



3. If all LEDs are off, use a digital volt meter to check for power at the truck's diagnostic connector. Pin-outs for the 6-pin and 9-pin connectors are in the *Appendix A: Wiring Diagrams and Charts*.
4. If LEDs are ON, locate the reset button on left side of display, and press and hold the reset button for 10 or more seconds until the unit reboots.

Display Goes Blank When Engine is Turned Off

When engine is turned OFF, the display should stay on for the “power down” time defined by dispatch.

The power-down time must be longer than five minutes.

The display screen could immediately blank when the ignition is turned OFF if:

- The IVG power-down time or total time is set to zero.
- The Constant 12-volt power at diagnostic connector is switched voltage (can be turned off with key).

Have the customer Omnitrac administrator check the power down timer configuration and verify that the diagnostic connector power is ON both when the ignition is on and off (it cannot be switched-power.)

See, *Appendix A: Wiring Diagrams and Charts*, for wire diagrams and schematics of the different diagnostic connectors.

10 IVG Display Problems

IVG Display Overview

The IVG has a color, graphic touchscreen display. When the vehicle's engine is running, the display screen should be on. It stays on until the engine is turned off and the IVG power-down timer expires; then it goes dark when it enters sleep mode. The power-down timer is configured by the customer's Omnitracs administrator.

When the engine is running, an image displays on the display screen. To adjust the brightness, use the brightness buttons located to the left of the **Home** button. Press the + (plus) button to increase brightness or - (minus) button to decrease brightness.



When the brightness buttons are pressed, a pop-up window appears on the screen indicating the current brightness level.

Text-to-speech is played through the display's two speakers. To adjust the volume, press the volume buttons located to the right of the **Home** button. Press the volume increase (top) or volume decrease (bottom) buttons to adjust. When the volume controls are used, a pop-up window appears on the screen indicated the current volume level.



When messages are waiting or alerts are generated by applications on the IVG, the Home button has a colored halo. The halo remains lit until the message is read or alert is cancelled/corrected. The halo color represents the notification's importance.

- Off – no waiting messages
- Red – unread Emergency message waiting to be read
- Orange – unread Important message waiting to be read or system Alert
- Blue – unread Normal message waiting to be read

If a driver receives messages of different priorities, the highest priority lights; then when read, the next highest priority lights.



Problem: Touchscreen Non-responsive/Calibration

If you are tapping on the touchscreen and it is not responding quickly or the screen arrow is not where the screen was touched, the touchscreen may not be calibrated properly.

To recalibrate the touchscreen settings

1. From the Home screen, tap the **Settings** button; then tap the **Calibration** tab.
2. Tap **Calibrate**.
3. When the targets display, carefully tap and hold down each of the **targets (+)** in the center and release when instructed. It is best to use your finger to calibrate.
4. After the last target is touched, tap anywhere on the screen to save the calibration.

If you cannot get to the Calibration screen using the touchscreen, connect a USB mouse to use as a pointer. After you get to the targets, use your finger to calibrate.



5. If the touchscreen/display is still unresponsive, use the reset button on the left side of the display to reboot the unit. It takes several minutes to reboot.

11 Cannot Send Messages

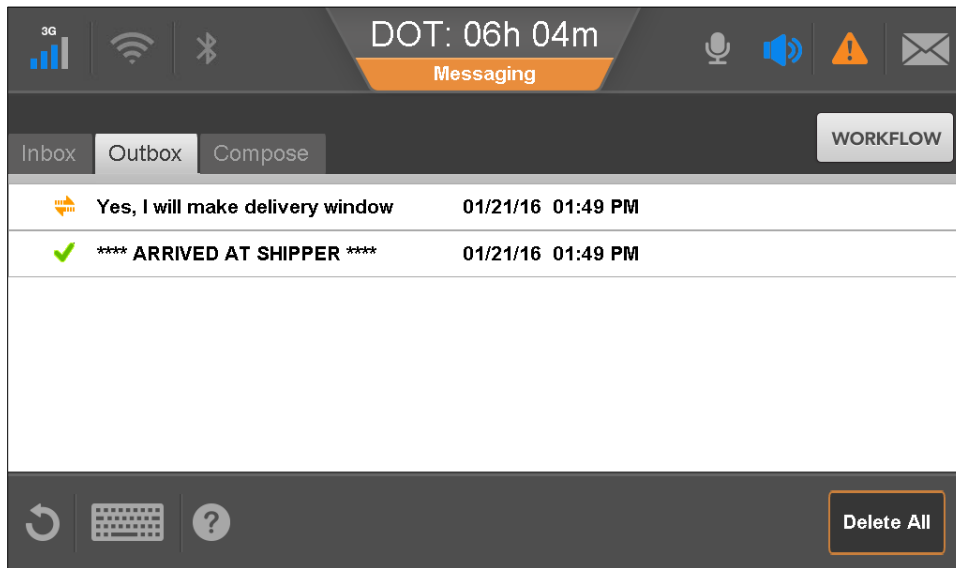

If a message has been queued and shows up in the Messaging Outbox with orange arrow indicators for more than a minute, do the following:

1. Verify the Cellular End To End test under the System Diag Run All test passes. See *Chapter 12: Cellular End to End Problems*.
2. Verify the Cellular Signal Strength indicator shows the unit has acceptable signal. See *Chapter 13: Cellular Signal Strength Problems*.
3. If both the Cellular End To End and Cellular Signal Strength are good:
4. Reboot the unit by pressing the reset button on the left side of the display. Give the unit time to boot up and reacquire cellular signal before checking the message status indicators.
5. If problem still persists, Call Omnitrac's Customer Support at 800-541-7490.

12 Cellular End to End Problems

If the Cellular End to End test fails when you perform a system verification, the IVG may not be properly activated.

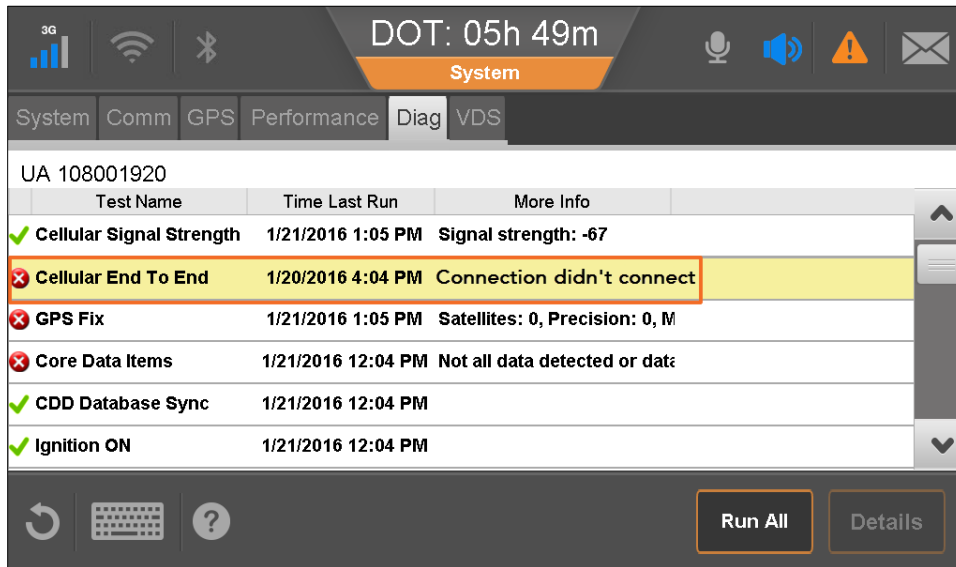

To see the details of the Cellular End to End test:

1. Tap to highlight the Cellular End To End line.
2. Tap Details and review the content at the bottom of the screen.

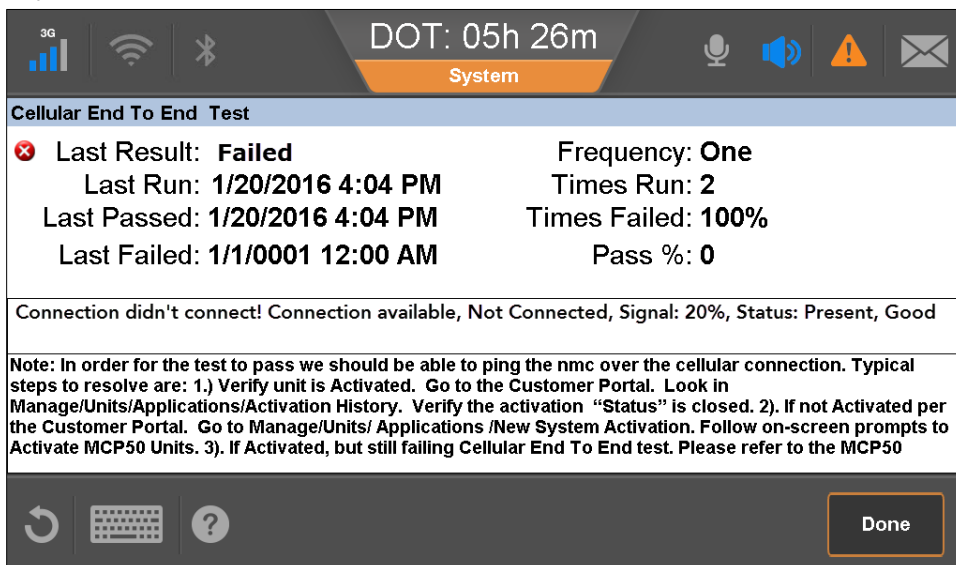

3. Tap **Done**; then tap **Run All** again.
4. If it fails again, have the company's Omnitracs administrator confirm that the unit is activated.

13 Cellular Signal Strength Problems

If the Cellular Signal Strength test fails when you perform a system verification, or the cellular icon at the top of the screen shows a red X and no colored bars, follow the steps in this chapter.

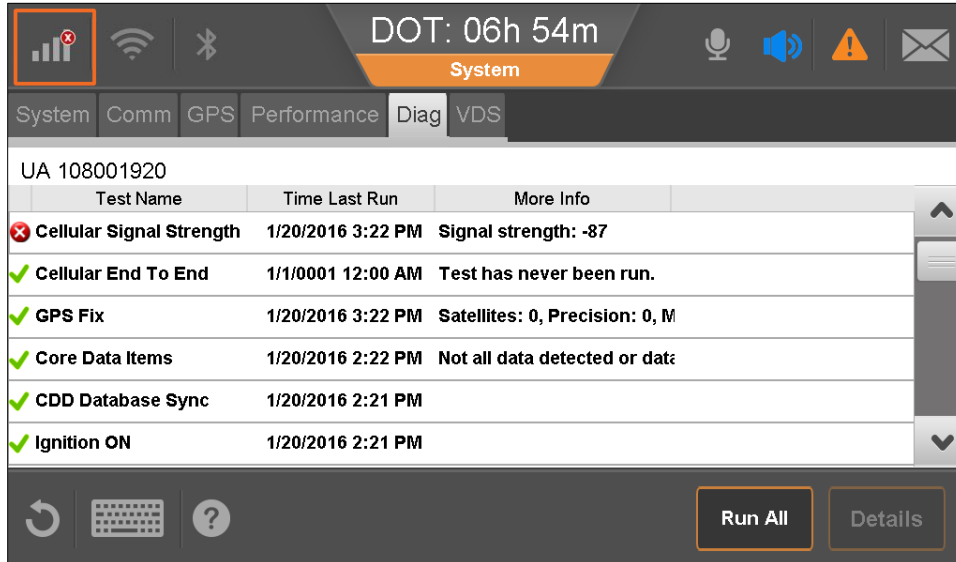

1. Verify that the truck is at a location where you know there is good cellular coverage.
2. Ensure there are no metal obstructions above the IVG display.
3. Navigate to and tap the **System** button on the IVG home screen; then tap the **Comm** tab.

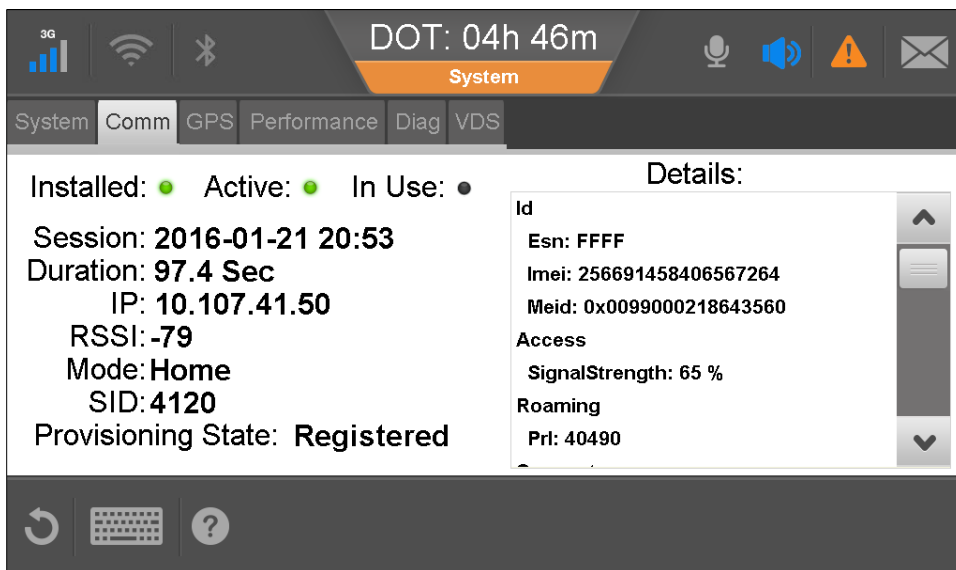

4. Move the truck to a known-good cellular signal location; if the problem continues, call Omnitrac's Customer support at 800-541-7490.

Received Signal Strength Indicator (RSSI)	Number of Bars
-50 to -75	4
-76 to -85	3
-86 to -95	2
-96 to -105	1
-106 to -109	0
-110 to -200	0, and the "no signal light" illuminates

5. If the problem continues, call Omnitrac's Customer Support at 800-541-7490.

You may be directed to replace or RMA the unit.

14 CDD Database Sync Problem

After an IVG is installed and powers up with both good signal and line-of-sight to GPS satellites, it usually takes about *10 minutes* for it to download all of the company-defined settings and configurations. After it acquires the settings and configurations, it indicates that the CDD Database Sync is complete.

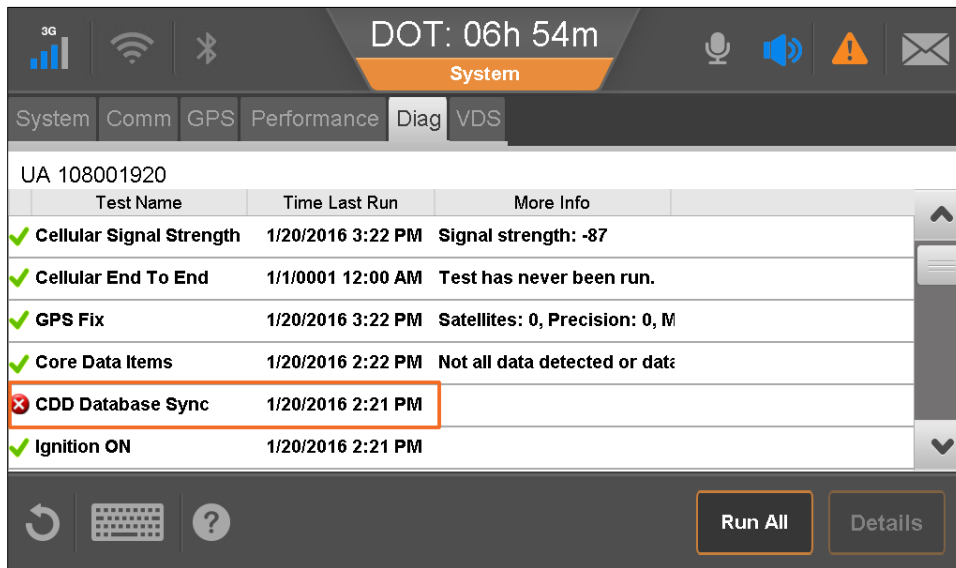

If an IVG is installed and powers up, but does not show that the CCD Database Sync is complete within 10 minutes, you'll have to troubleshoot.

1. Verify that the unit has cellular signal and is able to connect. See *Chapter 13: Cellular Signal Strength Problems*.
2. Verify that the unit has been properly activated. Be sure it passes the Cellular End To End test. See *Chapter 2: Activation*.
3. If it is activated/registered and able to connect, but will not go to a Sync complete state, call Omnitrac's Customer Support at 800-541-7490 and ask for Out of Sync command. You may be directed to replace or RMA the unit.

15 GPS Fix Problem

If the GPS Fix test fails, the IVG cannot provide position reports.

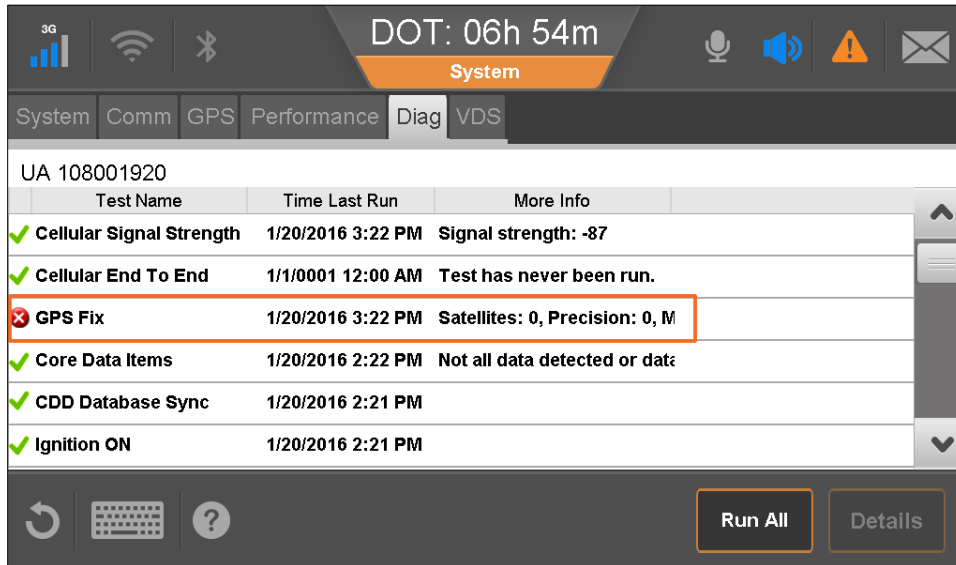

Details about GPS status are on the **System > GPS** tab. Normally the GPS positioning system updates positioning data every second at the IVG, as shown in the Last Update field of the **System > GPS** tab.

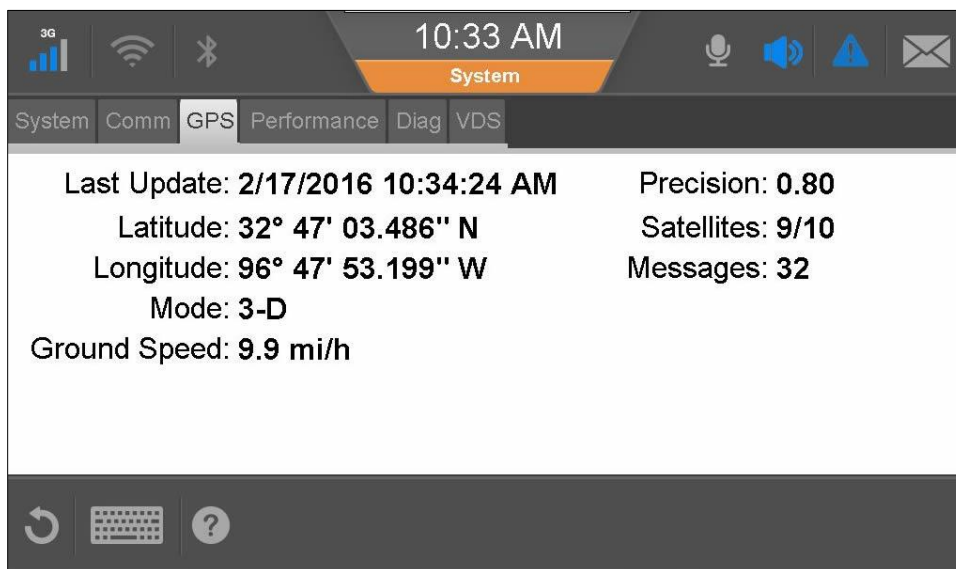

If the vehicle is in the open with a clear view of the sky (no metal roof above):

- **Mode** = 3-D
- **Precision** \leq 2
- **Satellites** \geq 5
- **Last Update** = current time
- **Precision** $<$ 2

If after sitting in the open for 5 minutes, the IVG cannot acquire those values:

- Verify that the IVG display is in the holster (not laying on the seat or floor of truck) and its view to the sky is not blocked or obstructed.
- Check for and remove any metal obstructions, such as metal clipboards, wires, or cables directly above the display that may block or degrade the GPS signals.

To help you troubleshoot, the GPS screen has a couple of indicators which may point to a problem with obstruction:

- If Precision is consistently above 2.00, it is likely that something is interfering with the GPS signals.
- The Satellites field shows xx/yy, where xx is the number of satellites used in the position fix, and yy is the number of satellites recently viewed. If the value of xx is less than 5, there is likely some obstruction.

16 J1587 Packet Detection Problem

The engine must be running for the IVG to retrieve vehicle data.

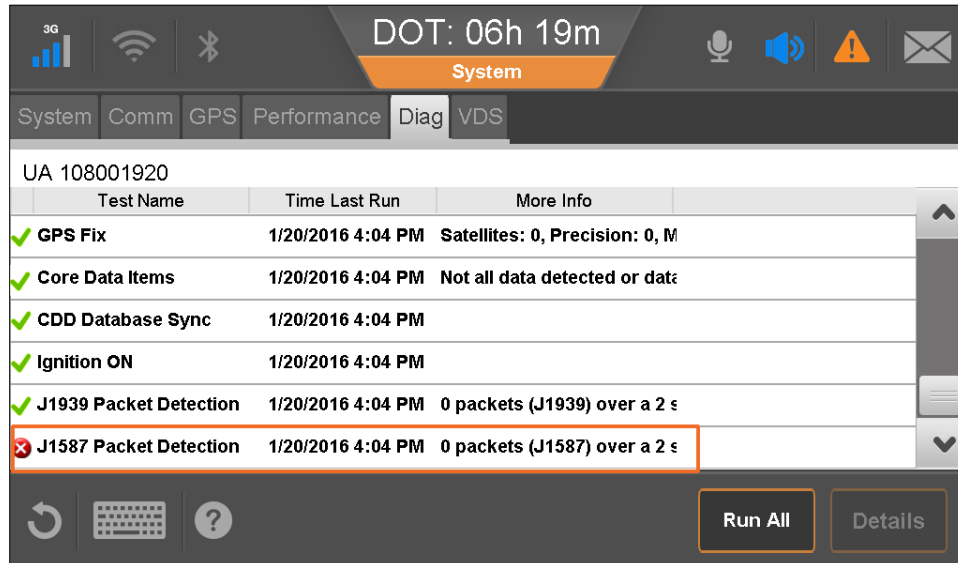

If the Core Data Items and J1939 Packet Detection tests pass, it's not a problem if the J1587 Packet Detection test fails. This indicates that the IVG system is getting its vehicle data from the J1939 link. Some 2012 and newer trucks do not supply J1587 data.

To get J1587 data, a truck's engine must supply J1587 data and a connection must be made to the J1587 wires (power I/O cable). If data are not detected, check and reseal the power I/O "Y" connections at the truck's diagnostic plug.

Many newer trucks do not provide J1587 data. The IVG system auto-detects the data bus, including J1587 bus traffic, and automatically select the most reliable data source for vehicle data.

17 J1939 Packet Detection Problem

The engine must be running for the truck to broadcast/supply vehicle data.

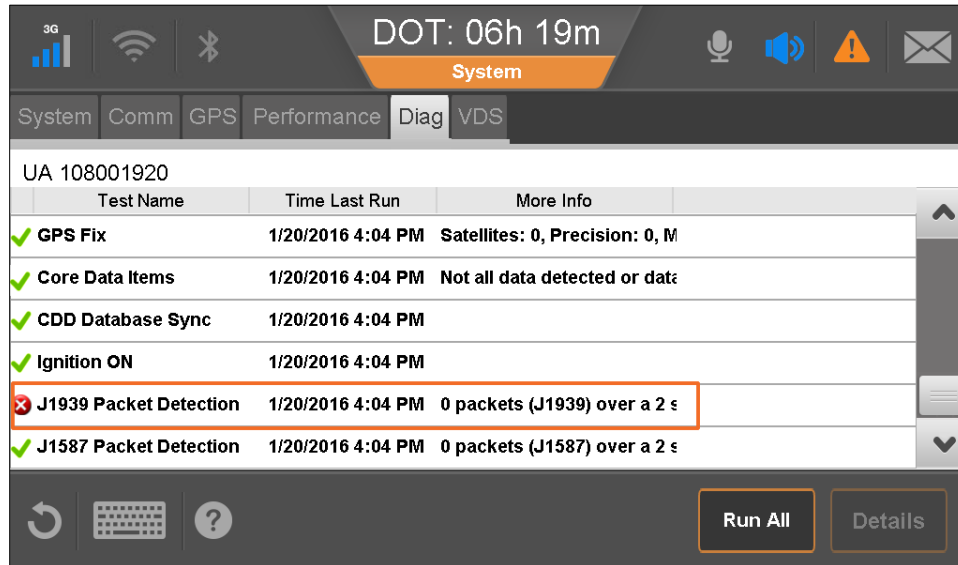

Many pre-2007 trucks do not broadcast J1939 packets. If the Core Data Items and J1587 tests pass, it's not a problem if the J1939 Packet Detection test fails. This would mean that the IVG system is getting its vehicle data from the J1587 Data link.

The IVG system will auto-detect bus traffic, including J1939 bus traffic (250 kbps and 500 kbps), and automatically select the most reliable source for vehicle data.

In order to get J1939 data, a truck's engine must be supplying the J1939 data, a connection must be made to the J1939 wires (power I/O cable). Many older trucks/engines do not transmit J1939 packets.

18 Ignition On Detection Problem

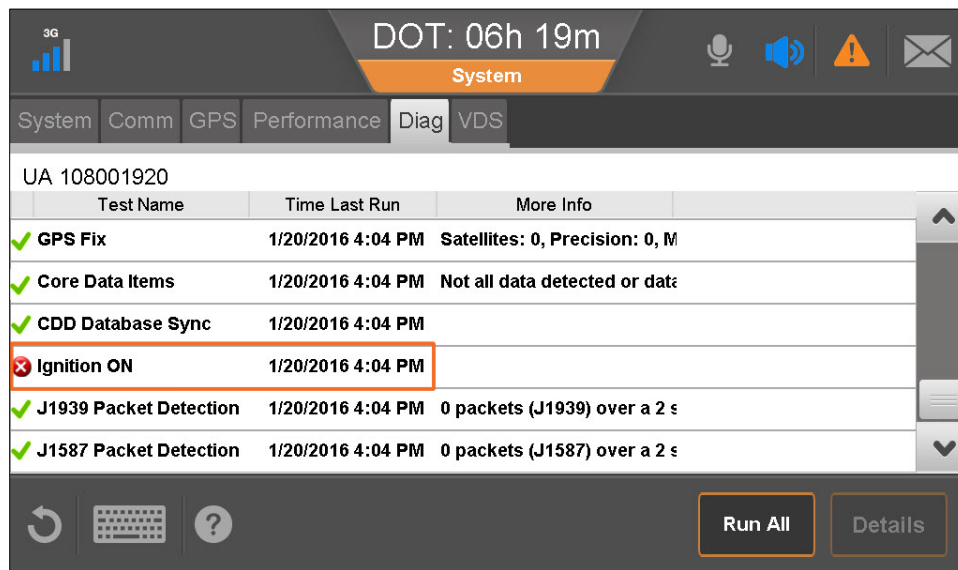

The IVG system auto-detects when the ignition is on by detecting engine RPMs. The engine must be running for the system to detect ignition is ON.

If the *Ignition On* test fails, ensure the truck's engine is running. If engine is running, the problem could be in the truck's diagnostic connector. If the diagnostic connector is faulty, you could connect the optional ignition lead of the power I/O cable to a 12 VDC key switched to source. Ensure that wire is connected and secure. CDEF444 will need to be disabled.

1. Verify the fuse in the ignition wire has not blown.
2. If it continues to fail, check the ignition source used and the associated truck fuse. Use a digital volt meter to verify that the source has approximately 12 VDC when key is in the ignition ON position and shows 0 VDC in the OFF position.

Many newer model trucks have multiplex wiring systems that require specific ignition connection points. To ensure correct ignition connection points, refer to the individual truck specific installation instructions for more details.

19 Core Data Problem

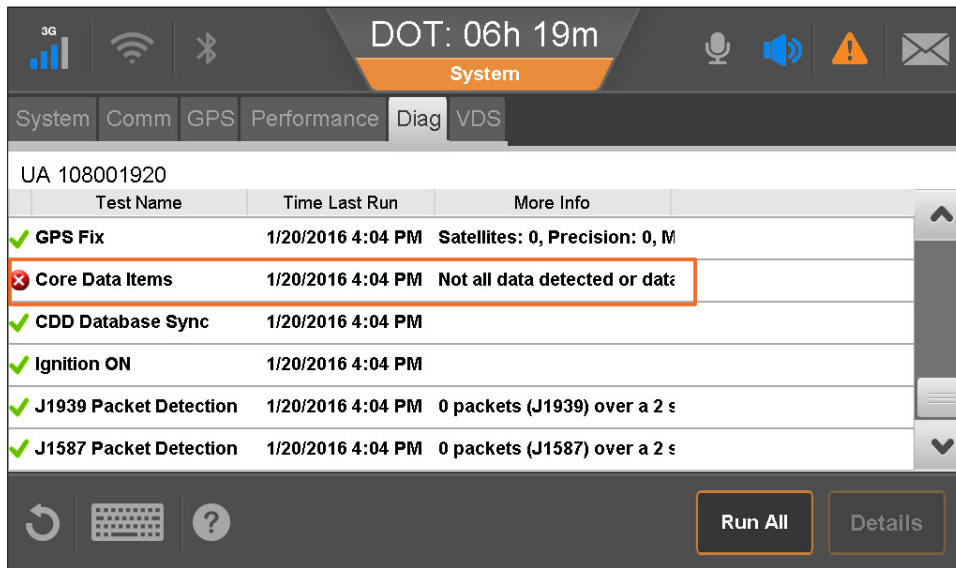

The engine must be running to detect vehicle data.

The Core Data Items test verifies that specific engine items are being received from one or both of the data links (J1587/J1939). Those items are:

- Speed
- RPM
- Distance LTD
- Fuel LTD

If any of these items are not receiving data when the test is run, the failed status is indicated by a red X. To identify missing data items, as well as detected data items:

1. Tap the **Core Data Items**: then tap the **Details**.

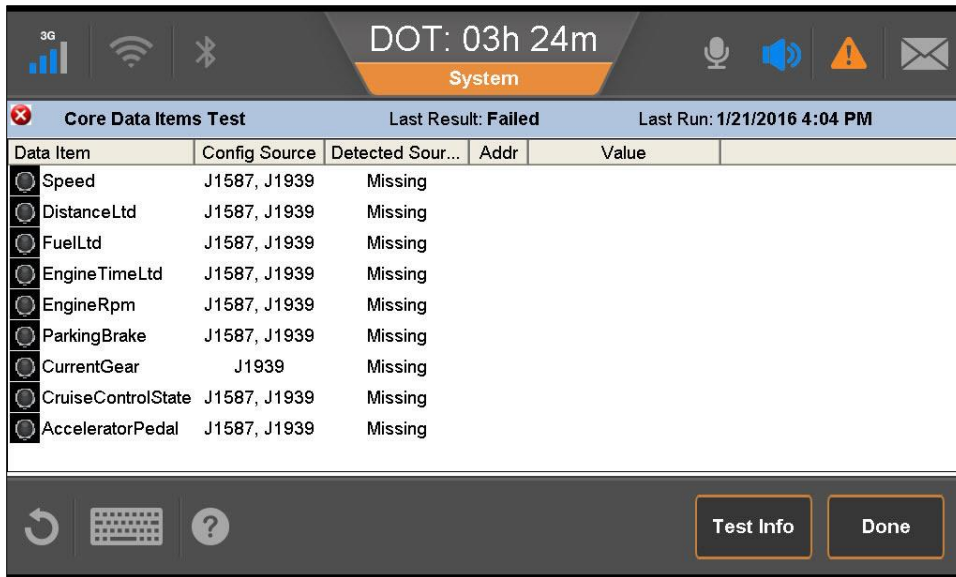

2. Verify that ignition test passes. The engine must be running. If the ignition test does not pass, see Chapter 18: Ignition On Detection Problem.
3. Verify one of the J1587 or J1939 packet detection tests passes. This means that the IVG system is getting data from at least one data source. Check connections.
 - If J1587 fails, see *Chapter 16: J1587 Packet Detection Problem*.
 - If J1939 fails, see *Chapter 17: J1939 Packet Detection Problem*.
4. If IVG is receiving data and the core data item test still fails, it could be a special configuration is needed for the truck type. Call Omnitracs Customer Support at 800-541-7490.

20 IVG Display and Diagnostic LED Definitions

The IVG display has the following icons/functions.

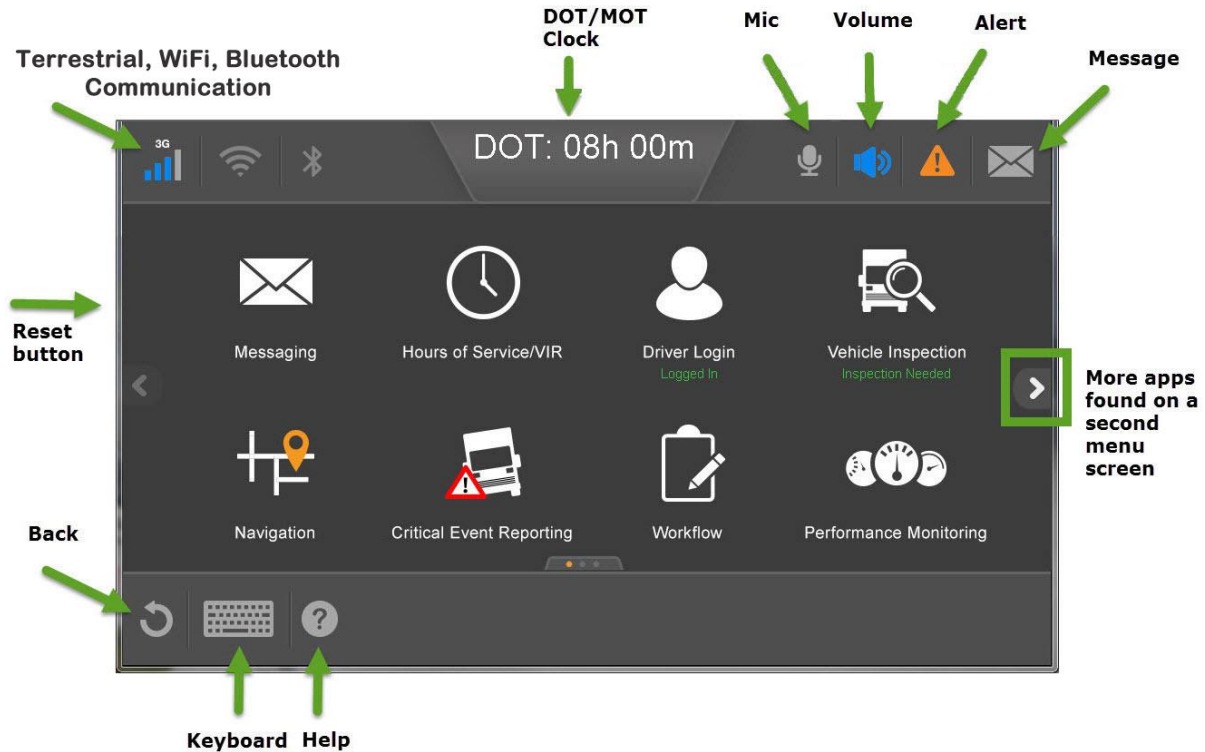

The IVG display hardware has the following features.



The halo around the Home button lights when the driver receives an alert from an application or message. The halo remains lit until the message is read or alert is cancelled/corrected. The halo color represents the notification's importance. The colors indicate:

- Blue – Normal operation
- Orange – There is an urgent message or alert waiting
- Red – there is an emergency message or alert waiting

If the driver receives messages of different priorities, the highest priority lights; then, when read, the next highest priority lights.

When operating normally, all three diagnostic LEDs on the right side of the display blink blue.



From top to bottom the IVG display LEDs indicate:

LEDs	Meaning
Top	<p>Power/VIOP identifies power and ignition states</p> <ul style="list-style-type: none"> • Blinking blue once every second means good power and unit active • Blinking blue once every 12 seconds means good power and units is asleep because ignition is off • Blinking red means loss of truck power and unit powering down • OFF means no power • Solid red means internal problem (Bootloader failure or PAPI failure • Blinking blue/green means Bootloader is OK, OS is OK, awaiting PAPI launch
Middle	<p>APPS/PAPI/OS</p> <ul style="list-style-type: none"> • Blinking blue once every second means VIOP, WIN, PAPI, and Apps are up and running • Solid green means VIOP up and Windows booting • Blinking green means VIOP up, Windows up, and PAPI is booting • Blinking blue/red means VIOP up, Windows up, PAPI or App is in a timeout state • Blinking red means VIOP up, Windows is not booting • OFF means nothing is booting or running
Bottom	<p>COMM/GPS/Core Items</p> <ul style="list-style-type: none"> • Blinking blue once every second means GPS, COMM, and data bus are good • Solid blue means bad GPS <p>Five satellites used and GPS Precision of two is good.</p> <ul style="list-style-type: none"> • Blinking red means bad COMM (out of coverage) • Solid red means bad data bus (indicates Speed, LTD Distance, LTD Fuel, or RPMs is bad) Note: Normal state when engine is not running.

Additionally, the following states may occur where all LEDs are:

- Blinking blue/green means the GPS and COMM are bad
- Blinking blue/red means the GPS and data bus are bad
- Blinking green/red means the COMM and data bus are bad
- Blinking green every 5 seconds means unit is in an active data call over CDMA
- Blinking green every 10 seconds means unit is in an active data call over GSM

21 Performance Monitoring Troubleshooting

System Overview

To use the Performance Monitoring application, you must connect the IVG to the truck's data link using the power I/O cable.

The Performance Monitoring application records data from the vehicle such as speed, distance, RPMs, and total fuel used. The data is retrieved from the truck by the IVG and sent to the host, either manually or automatically at preset intervals.

The hardware installation on the vehicle consists of connecting the IVG power I/O cable to the truck's diagnostic connector.

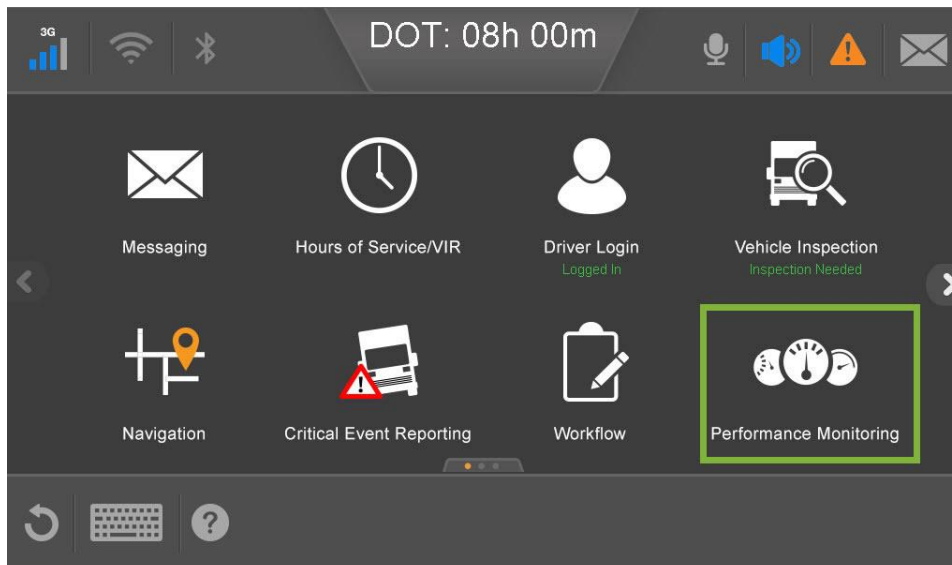

If a driver is logged in and the Performance Monitoring icon is grayed out, the Performance Monitoring application is not enabled. Call your company dispatch to have this application enabled.

Normal Performance

After you connect the power I/O cable to the truck's diagnostic connector, company-defined parameters are sent to the unit. Performance monitoring data is then recorded at the mobile and uploaded to the host system periodically and on demand.

To confirm normal performance, first verify that performance monitoring parameters have been sent to the unit and received. Tap the **Parameters** tab within the Performance Monitoring application and verify the tag field is not "0."

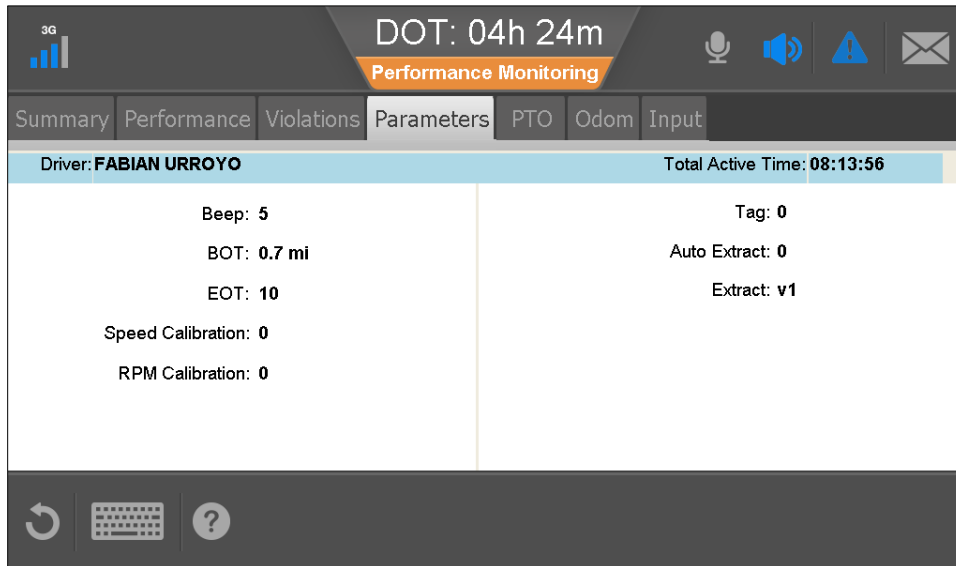

A tag of "0" indicates that the unit did not download its parameters. Call your company dispatch administrator and ask them to resend the parameters. A non-zero tag indicates that the unit received parameters.

The Core Data Items test checks for all essential data items for Performance Monitoring. With the engine running, review data that is available listed under the **System > Diag > Core Data Items > Details**.

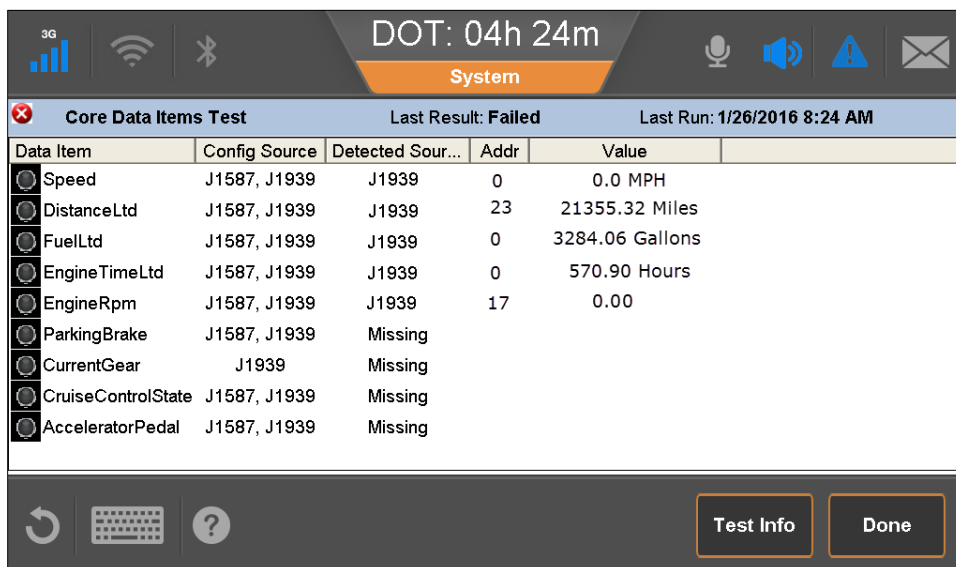

At a minimum, Performance Monitoring needs current data from Speed, EngineRPM, Fuel, and DistanceLTD. These are checked when a system verification is run. The Core Data Items test indicates if these values are received. The screen above shows how the unit is configured, if an item is detected, and the source address if detected.

If any data items are not present, ensure the IVG is set to auto-detect the databus traffic by calling the Omnitracs Customer Support at 800-541-7490. Call Customer Support if problems continue.

Performance Monitoring Faults and Descriptions

Monitored Active Faults are controlled by the customer-specified parameters sent to the unit. The chart on the following page shows possible faults.

The screenshot shows a mobile application interface for Performance Monitoring. At the top, it displays 'DOT: 04h 55m' and 'Performance Monitoring'. Below this is a navigation bar with tabs for Summary, Performance, Violations, Parameters, PTO, Odom, and Input. The main content area is divided into two tables. The left table lists Data Items with their values, sources, and counts. The right table lists Faults with their IDs. At the bottom, there are icons for refresh, keyboard, and help.

Data Item	Value	Source	Count	Fault	Id
● Speed	0.0 mi/h	None	0	● NoPower	0x00
● EngineRpm	0	None	0	● RPMZero	0x01
● DistanceLtd	0.0 mi	None	0	● BadIgnition	0x02
● EngineTimeLtd	0.0 h	None	0	● J1708RPM	0x03
● FuelLtd	0.0 g	None	0	● J1708Speed	0x04
● AcceleratorPedal	0.0%	None	0	● J1708LTDMis...	0x09
● ParkingBrake	Off	None	0	● BadSpeed	0x0A
● PtoEngineStatus	Off	None	0	● ZeroSpeedAn...	0x0B
● CurrentGear		None	0	● SteadySpeed	0x...
● CruiseControlState		None	0	● HardBraking	0x0E

Fault	Description/Symptom	Possible Cause
No Power	Power detected OFF for more than the wake-up time.	Main power was lost, causing the IVG to stay asleep longer than its wake-up interval.
RPM Zero	RPM zero when speed is non-zero.	<ul style="list-style-type: none"> - RPM sensor or connection problem. - J1708 selection parameter set wrong. - In rare cases, no idle can be caused by faulty axle sensor input (e.g., wires reversed) causing a positive reading for speed while the vehicle is stationary.
Bad Ignition	Ignition OFF and speed or RPM non-zero.	Problem with the IVG's ignition sense or unit rebooted while moving.
RPM Sensor	Engine posted PID (194) and PID (190).	RPM sensor or connection problem to the engine, detected by the engine's diagnostics.
Speed Sensor	Engine posted PID (194) and PID (84).	Speed sensor or connection problem to engine, detected by the engine's diagnostics.
LTD Mismatch	LTD mismatch with stored IVG data.	<ul style="list-style-type: none"> - Engine run with main power disconnected. - Engine run with data link disconnected. - Engine run with ignition line disconnected.
Bad Speed	More than 2 hrs IGN = ON with Spd = 0, RPM greater than 1300.	<ul style="list-style-type: none"> - Speed sensor or connection problem: engine. - Engine speed sensor parameter not enabled.
0 Spd and RPM	More than 2 hrs with IGN = ON with Spd = 0, RPM = 0.	<ul style="list-style-type: none"> - Data link connection problem - IVG detection of ignition problem.
IVG Speed	Speed signal constant for more than 5 minutes.	A pulse generator may have been connected to either the IVG or the engine.
Hard Braking Event	Speed is suddenly decreased by more than 9 MPH/second (speed must be above 20 MPH for this fault to occur).	Driver is braking too quickly.

22 Critical Event Reporting Troubleshooting

Critical Event Reporting (CER) captures and reports vehicle critical event information (e.g., hard braking, vehicle overspeed, stability control, lane departure warning (LDW), and manually triggered events). With each event, five minutes of speed and location information is recorded and sent to the CER host system. Events are processed two minutes after they occur.

Normal Performance

For the CER feature to function, the IVG must be connected to the vehicle's data bus via the power I/O cable. Critical events can be triggered by the following events:

- Hard Brake
- Stability Control (if available on vehicle)
- Lane Departure Warning (LDW) (if option is installed on vehicle)
- Collision Warning
- Manually triggered

Text-to-speech (TTS) can be enabled so CER events can be audibly conveyed to the driver. Critical Events are noted in the Alert Manager.

Troubleshoot Abnormal Performance

If any of the above events do not trigger a CER event, or if a critical event is reported in error, there is a problem. A problem is usually caused by one or more of the following:

- Loose or bad connection to the datalink
- Intermittent data supplied by stability control device or lane departure warning device
- Intermittent data supplied by ECM of vehicle
- Configuration setting may filter events

If events are not triggered as expected or there are spurious events reported, verify the installation; then trigger a manual event.

CER Verify Configuration

1. From the IVG Home screen, tap the **Critical Event Reporting** button. If this button is grayed out, then CER must be enabled on this unit from the Customer Portal.

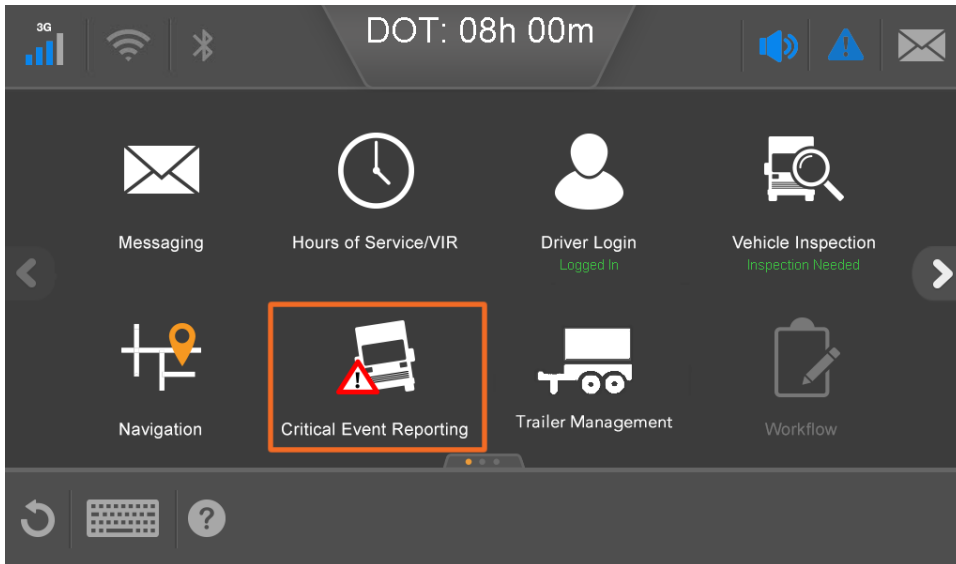

2. A pop-up will appear. Tap the **Diagnostics** button at the bottom right of the screen.

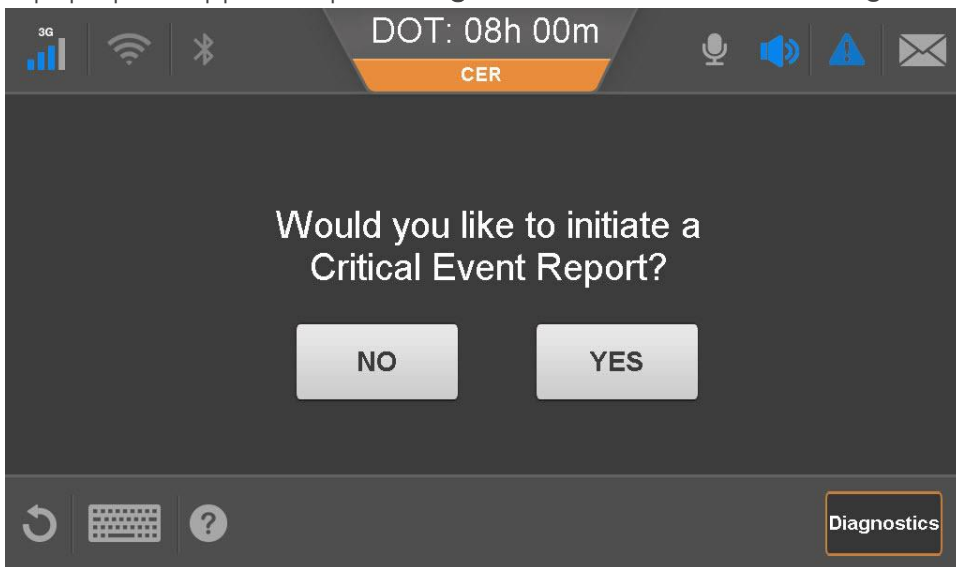

3. Select a tab, review the settings; then click **Done**.

General

3G [Wi-Fi] [Bluetooth] DOT: 08h 00m [Microphone] [Speaker] [Warning] [Mail]

CER

General | Roll Stability | Lane Departure | Collision Warning | ABS

CER Enabled: **True** Speech Enabled: **False**

Hard Braking Trigger Optional Triggers Enabled

Min Speed: **20 mph** Roll Stability: **False**
 Decel Rate: **9 mph/s** Lane Departure: **False**
 Following Time Violation: **False**
 Forward Collision Warning: **False**
 ABS Hard Brake: **False**

[Refresh] [Keyboard] [Help] **Done**

Roll Stability

3G [Wi-Fi] [Bluetooth] DOT: 08h 00m [Microphone] [Speaker] [Warning] [Mail]

CER

General | Roll Stability | Lane Departure | Collision Warning | ABS

Trigger Enabled: **False** Min Speed: **8**
 Bus: **None** On Threshold: **2**
 VDC Data: **Not seen** Off Threshold: **4**
 Bits Tracked: **BrakeOrEngine**

[Refresh] [Keyboard] [Help] **Done**

Lane Departure

3G [Wi-Fi] [Bluetooth] DOT: 08h 00m [Microphone] [Speaker] [Warning] [Mail]

CER

General | Roll Stability | Lane Departure | Collision Warning | ABS

Trigger Enabled: **False** Left/Right Disablement
 Bus: **None** Min Speed: **30** **30**
 LDW Data: **Not seen** On Thresh: **1** **1**
 Off Thresh: **1** **1**
 Events Count: **3** **3**
 Events Time (mins): **2** **60**

[Refresh] [Keyboard] [Help] **Done**

Collision Warning

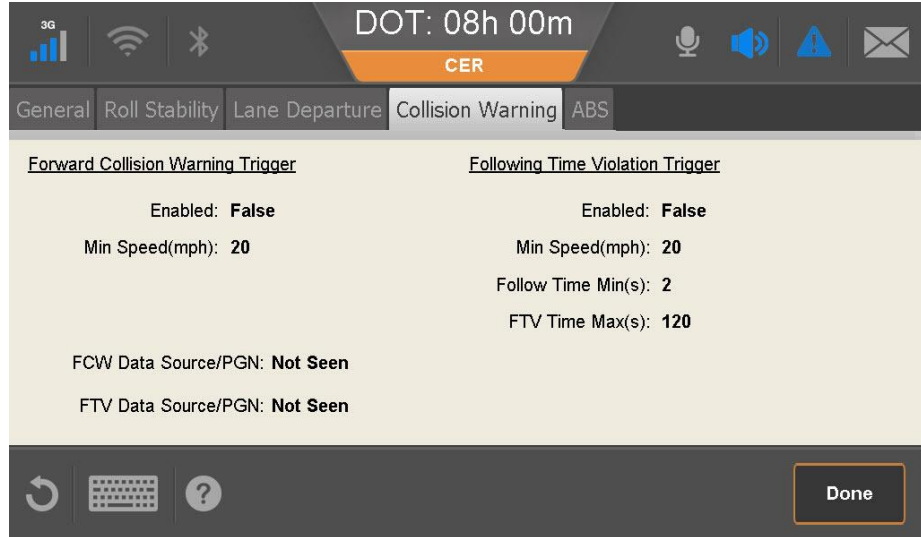

3G | [Wi-Fi] | [Bluetooth] | DOT: 08h 00m | [Microphone] | [Speaker] | [Warning] | [Envelope]

CER

General | Roll Stability | Lane Departure | Collision Warning | ABS

Forward Collision Warning Trigger

Enabled: **False**
Min Speed(mph): **20**
FCW Data Source/PGN: **Not Seen**
FTV Data Source/PGN: **Not Seen**

Following Time Violation Trigger

Enabled: **False**
Min Speed(mph): **20**
Follow Time Min(s): **2**
FTV Time Max(s): **120**

[Refresh] [Keyboard] [Help] [Done]

ABS

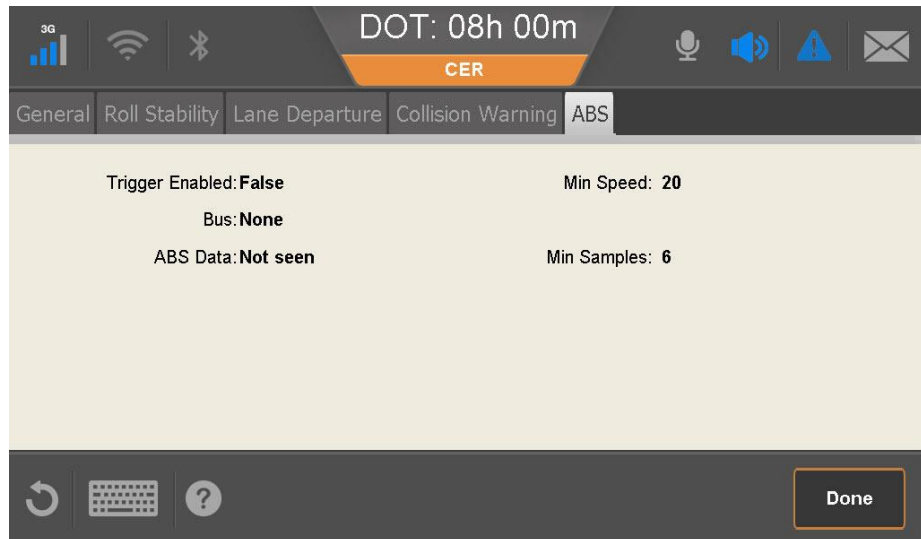

3G | [Wi-Fi] | [Bluetooth] | DOT: 08h 00m | [Microphone] | [Speaker] | [Warning] | [Envelope]

CER

General | Roll Stability | Lane Departure | Collision Warning | ABS

Trigger Enabled: **False**
Bus: **None**
ABS Data: **Not seen**

Min Speed: **20**
Min Samples: **6**

[Refresh] [Keyboard] [Help] [Done]

CER Configuration Fields	Definitions
CER Enabled/Disabled	If enabled, the IVG captures CER events.
Speech Enabled/Disabled	If enabled, the text in the alert pop-ups is spoken.
Hard Braking Minimum Speed	The speed at which mobile unit detects hard brake events.
Hard Braking Deceleration Rate	The rate of deceleration that triggers a hard brake event (Default = 9 MPH/SEC).
Stability Control (VDC) Enabled/Disabled	Stability control is enabled/disabled.
Minimum Speed	Minimum speed at which mobile unit detects events.
On/Off Threshold	Number of notifications that must be seen in a row before an event is considered to be in progress.
VDC/LDW Bits Tracked	Setting that determines which bits the mobile unit tracks to monitor stability control events: Brake bits only, Engine bits only, Brake or Engine bits (Default), Brake and Engine bits
Lane Departure Enabled	Lane Departure Warning is enabled.
Bus	J1587 or J1939
VDC/LDW Data	Available or not seen
LDW Events Count	Number of LDW events that occur within the LDW Time Threshold before CER sends a notification.
LDW Events Time (mins)	Number of minutes that pass before LDW events are detected and CER sends a notification.
Trigger Enabled	The CER Anti-Lock Braking System (ABS) detection has been enabled. When the truck ABS system becomes activated, a CER Hard Braking Alert will be created
Bus	Truck source ABS data is received from (J1587/J1708 or J1939)
ABS Data	Indicates whether or not ABS data is present
Min Speed	Vehicle must be traveling a minimum speed of 20 MPH. Events occurring below 20 MPH are not monitored. The minimum speed setting can be changed by Omnitrac.
Min Samples	Number of consecutive samples from the vehicle's data bus needed to trigger a CER/ABS event

Hard braking gets information from either J1708/1587 or J1939. One of these feeds must be active (green) for hard braking events to be recorded correctly. Some filtering is done to prevent erroneous CER events due to faulty truck speed sensors.

Send a Manual CER Event

1. From the **Home** screen, tap the **Critical Event Reporting** button. Tap **Yes** to initiate an event.

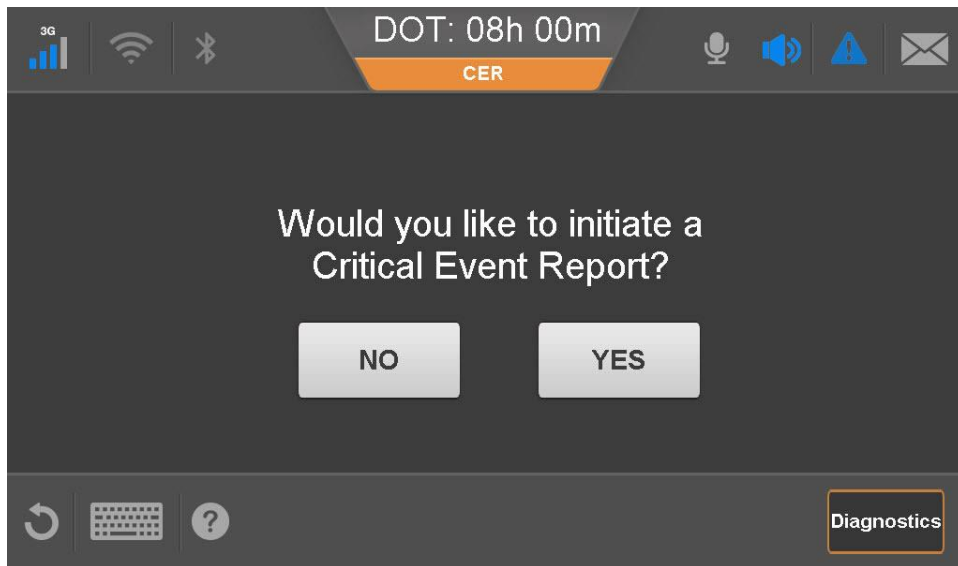

The CER message is sent to the Omnitrac network operations center.

2. Verify that the host receives the CER event message and that data is present.

Events Triggered in Error

For hard braking events triggered in error, verify configuration values, hard braking minimum speed and hard braking deceleration rate.

False hard braking events are typically caused by a faulty speed sensor.

For stability control events triggered in error, verify configuration values minimum speed and on/off threshold.

Roll stability events are sent from the power train or braking control units installed on the truck. The IVG system acts as a pass-through for these devices. If false events are recorded, those devices should be investigated. Configuration settings can be changed to filter and prevent erroneous events. Call Omnitrac Support for assistance.







23 Wi-Fi Troubleshooting

The IVG system is equipped with a Wi-Fi antenna. Wi-Fi is used for the Web Browsing application and used to transmit information including messages when the system is within range of a configured Wi-Fi access point.

At the top of every screen is an indicator of the Wi-Fi signal strength and Wi-Fi access.

If Wi-Fi is not configured to be used or the IVG is unable to communicate via Wi-Fi to the access point in the truck's current location, the indicator will show no signal strength.

If Wi-Fi is connected to an access point but it is unable to connect to the Omnitracs network, and exclamation point will be shown on the signal indicator.

Icon	Meaning
	No Wi-Fi connection
	Low signal strength
	
	
	High signal strength
	Connected to access point but not Omnitracs network

A Wiring Diagrams and Charts

9-Pin Power I/O Cable with Standard Black Flange Connector

SIGNAL	PIN	SIGNAL	PIN
BATT GROUND	A	J1708+	F
+12VDC	B	J1708-	G
CAN H	C	OEM CAN H	H*
CAN L	D	OEM CAN L	J*
OEM SPARE	E*		

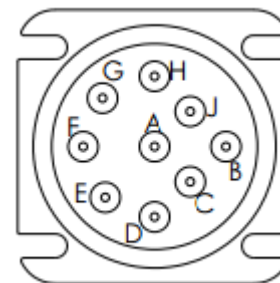

*No IVG Connection

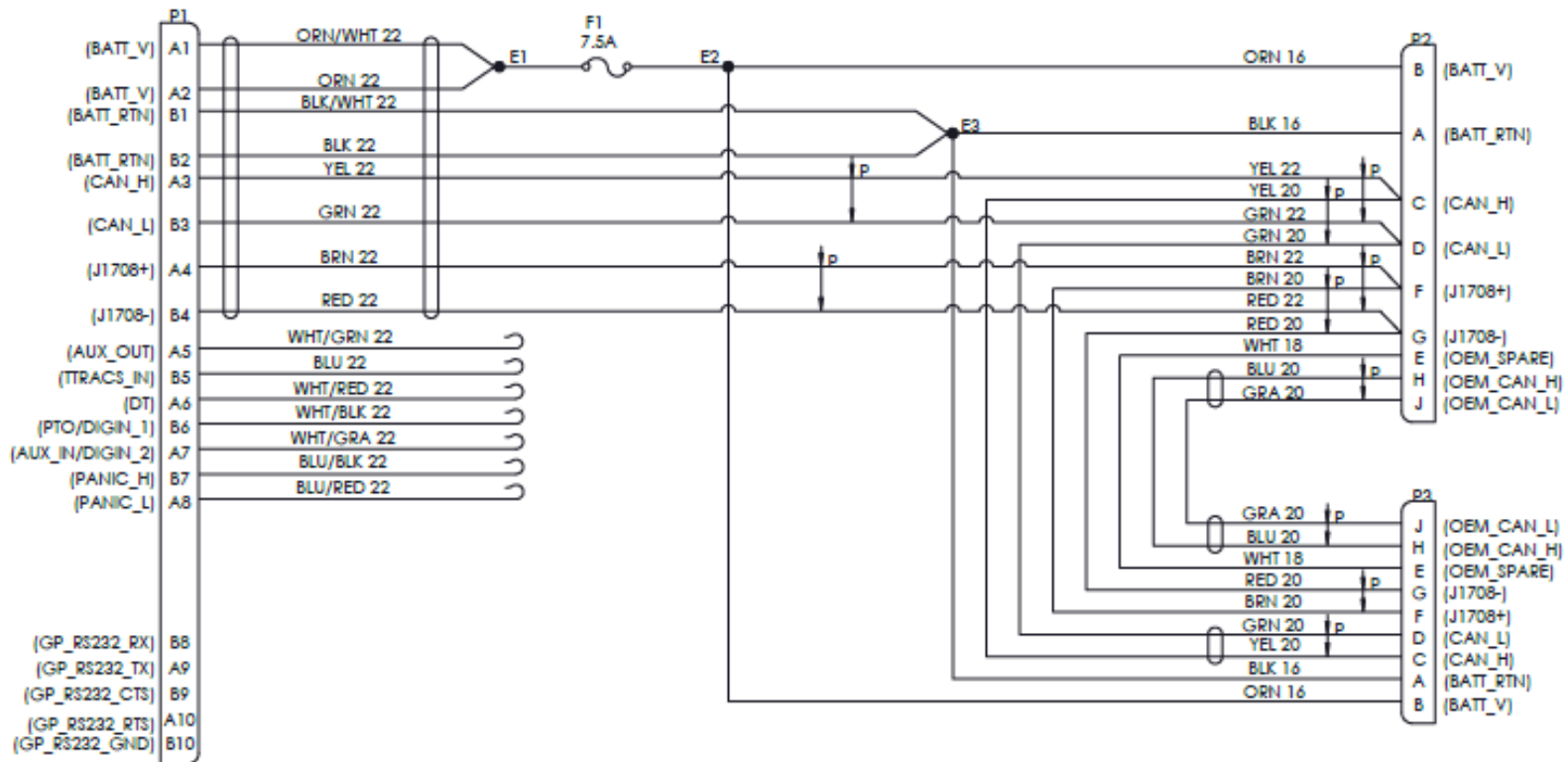

WIRING DIAGRAM

6-Pin Power I/O Cable with Standard Gray Flange Connector

SIGNAL	PIN
J1708/J1587 DATA LINK+	A
J1708/J1587 DATA LINK-	B
+12VDC	C
N/C	D*
BATTERY GROUND	E
N/C	F*

*No IVG Connection

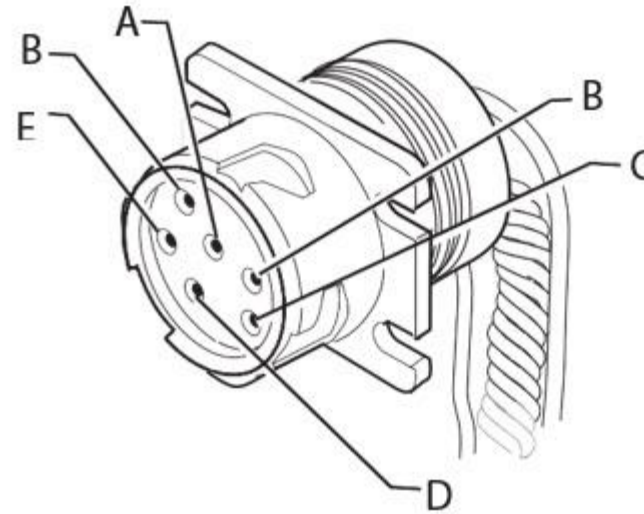

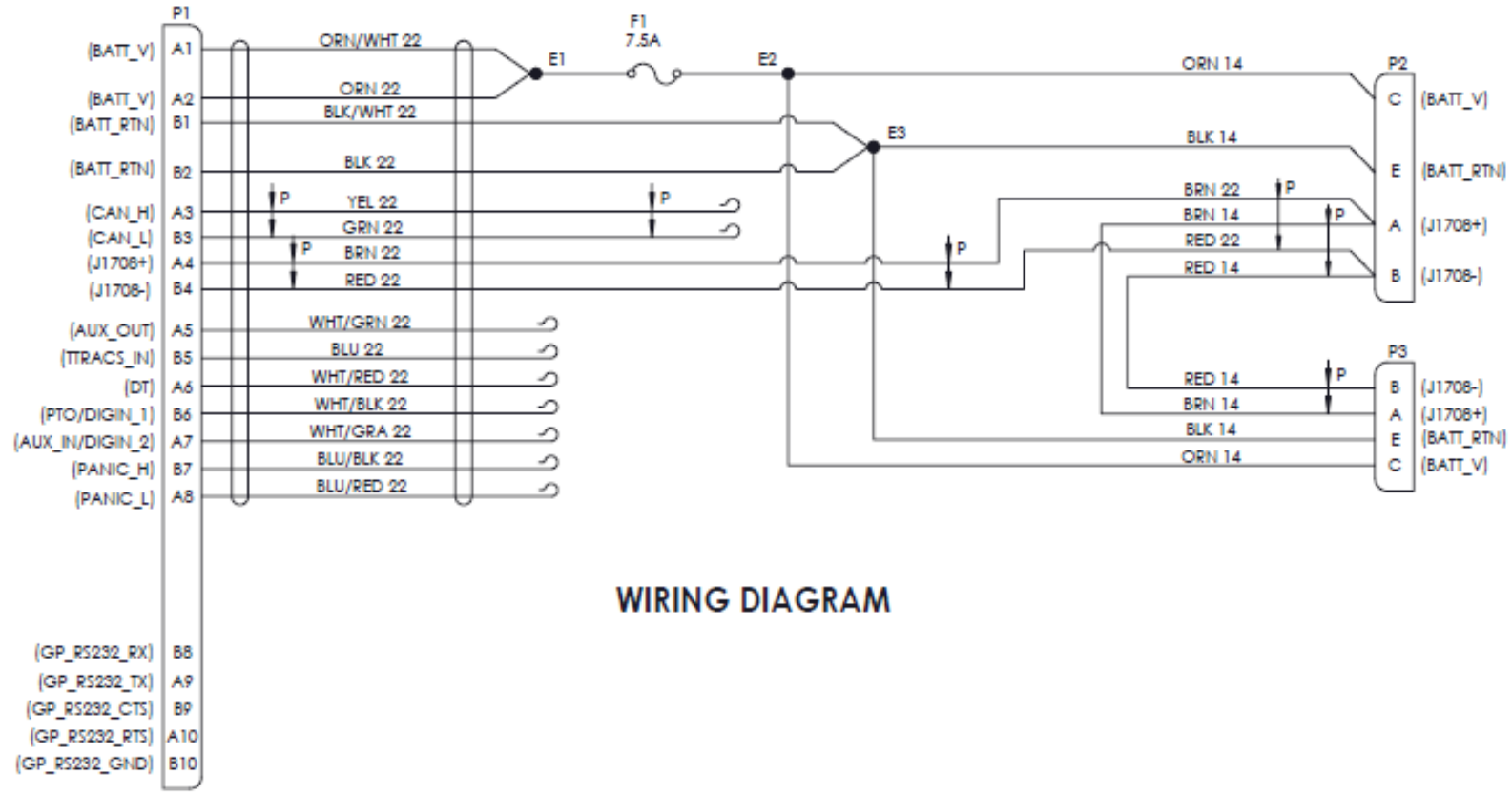

WIRING DIAGRAM

OBDII Power I/O Cable for Volvo/Mack 2014 and Newer

While this cable uses OBDII style connector, it is not compatible with standard OBDII cables found in most non-commercial cars, trucks, and vans.

SIGNAL	PIN	SIGNAL	PIN
Ignition	1*	J1708/J1587 Data Link +	12*
J1939 CAN (High)	3	J1708/J1587 Data Link -	13*
Chassis Ground	4	Battery Positive Voltage	16
Signal Ground	5*		
J1939 CAN (Low)	11		

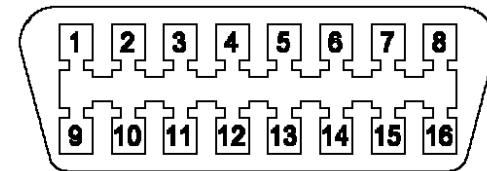

*No IVG Connection

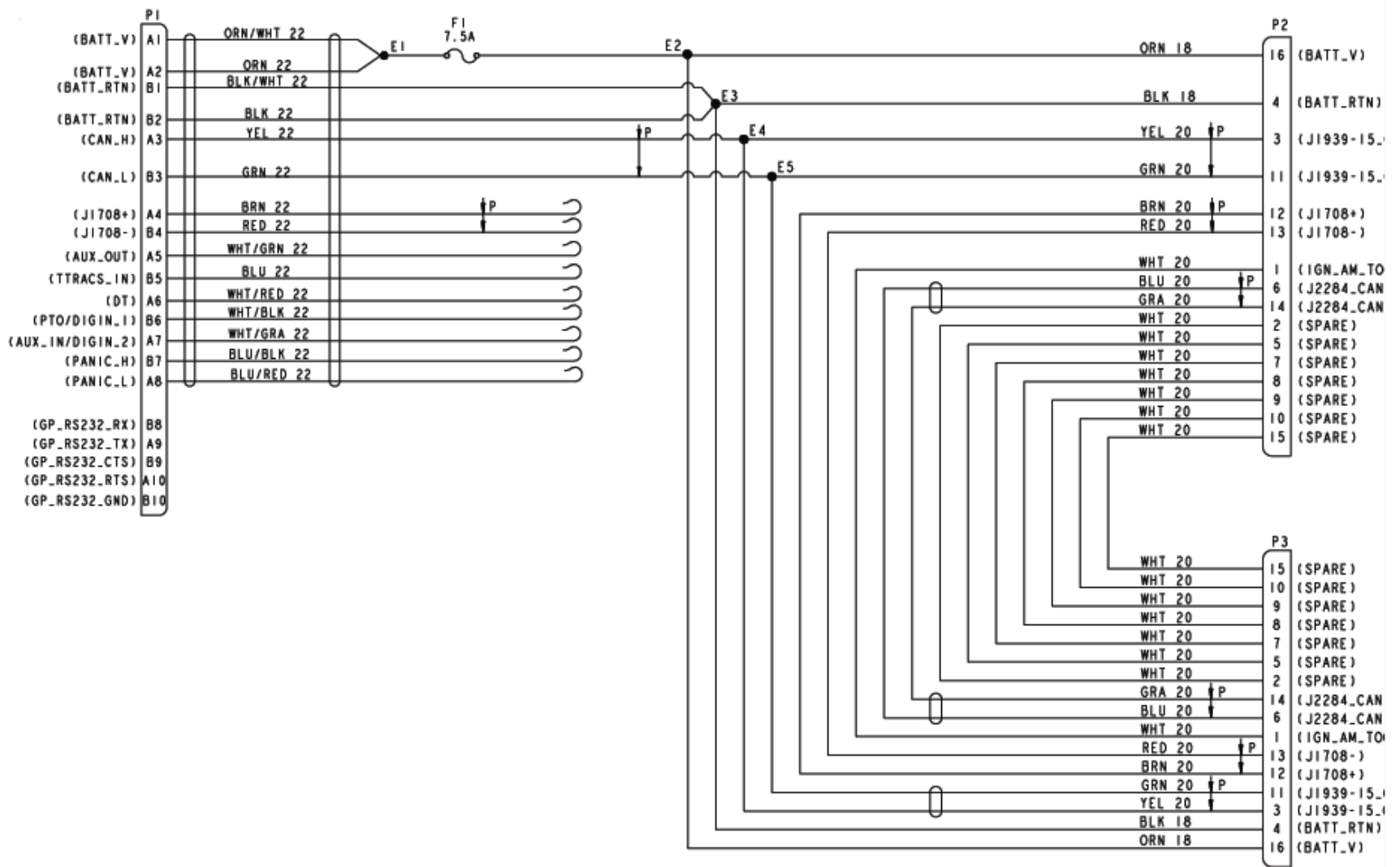

9-pin Power I/O Cable with Black Panel Mount Connector (PACCAR)

SIGNAL	PIN	SIGNAL	PIN
BATTERY GROUND	A	J1708/J1587 DATA LINK+	F
+12VDC	B	J1708/J1587 DATA LINK-	G
J1939 DATA LINK+	C	OEM_CAN_H	H*
J1939 DATA LINK-	D	OEM_CAN_L	J*

*No IVG Connection

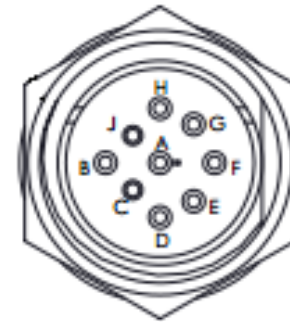

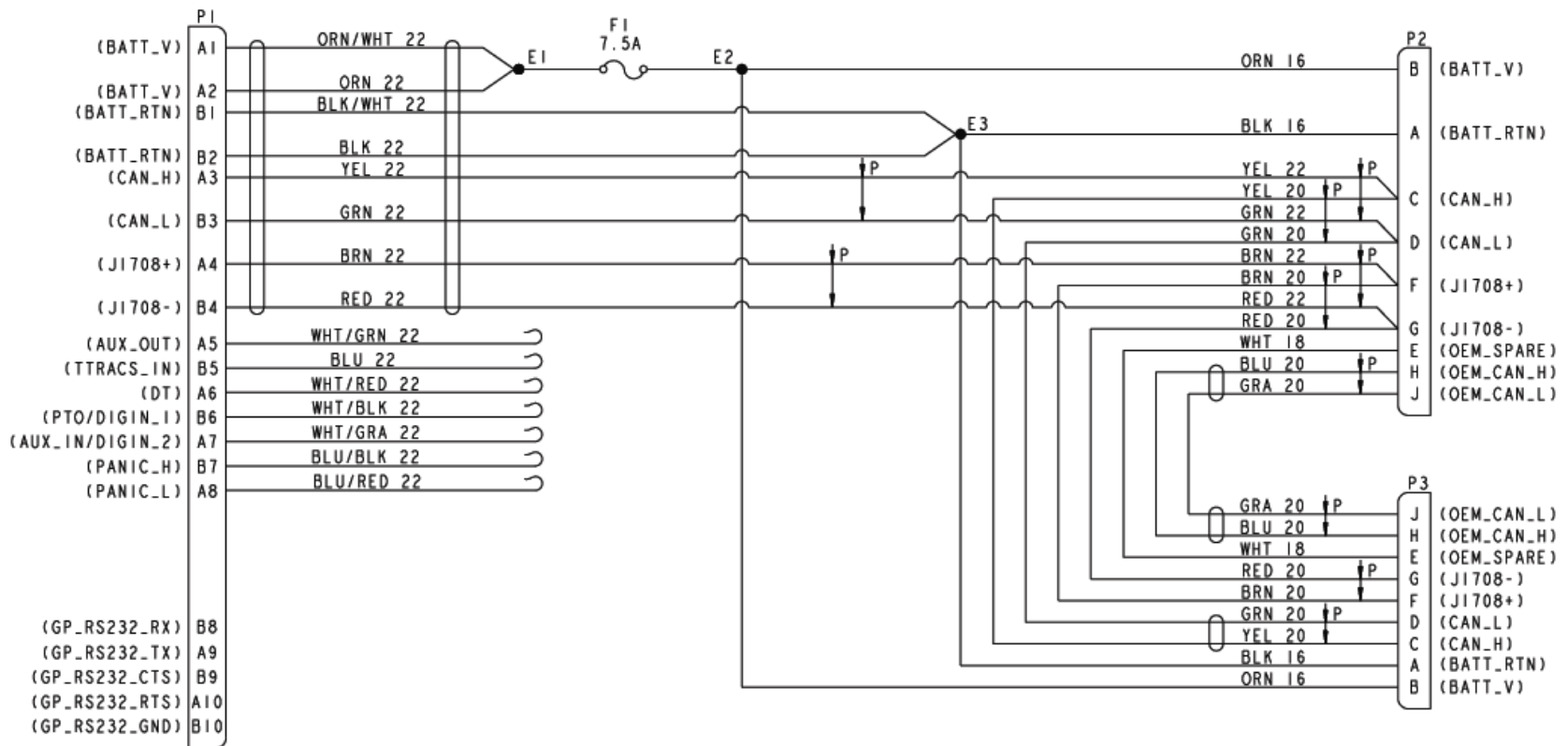

9-pin Power I/O Cable with Green Panel Mount (PACCAR)

SIGNAL	PIN	SIGNAL	PIN
BATTERY GROUND	A	J1939_V-CAN_H	F
+12VDC	B	J1939_V-CAN_L	G
J1939_O-CAN_H	C*	J1939_D-CAN_H	H*
J1939_O-CAN_L	D*	J1939_D-CAN_L	J*
OEM SPARE	E*		



*No IVG Connection

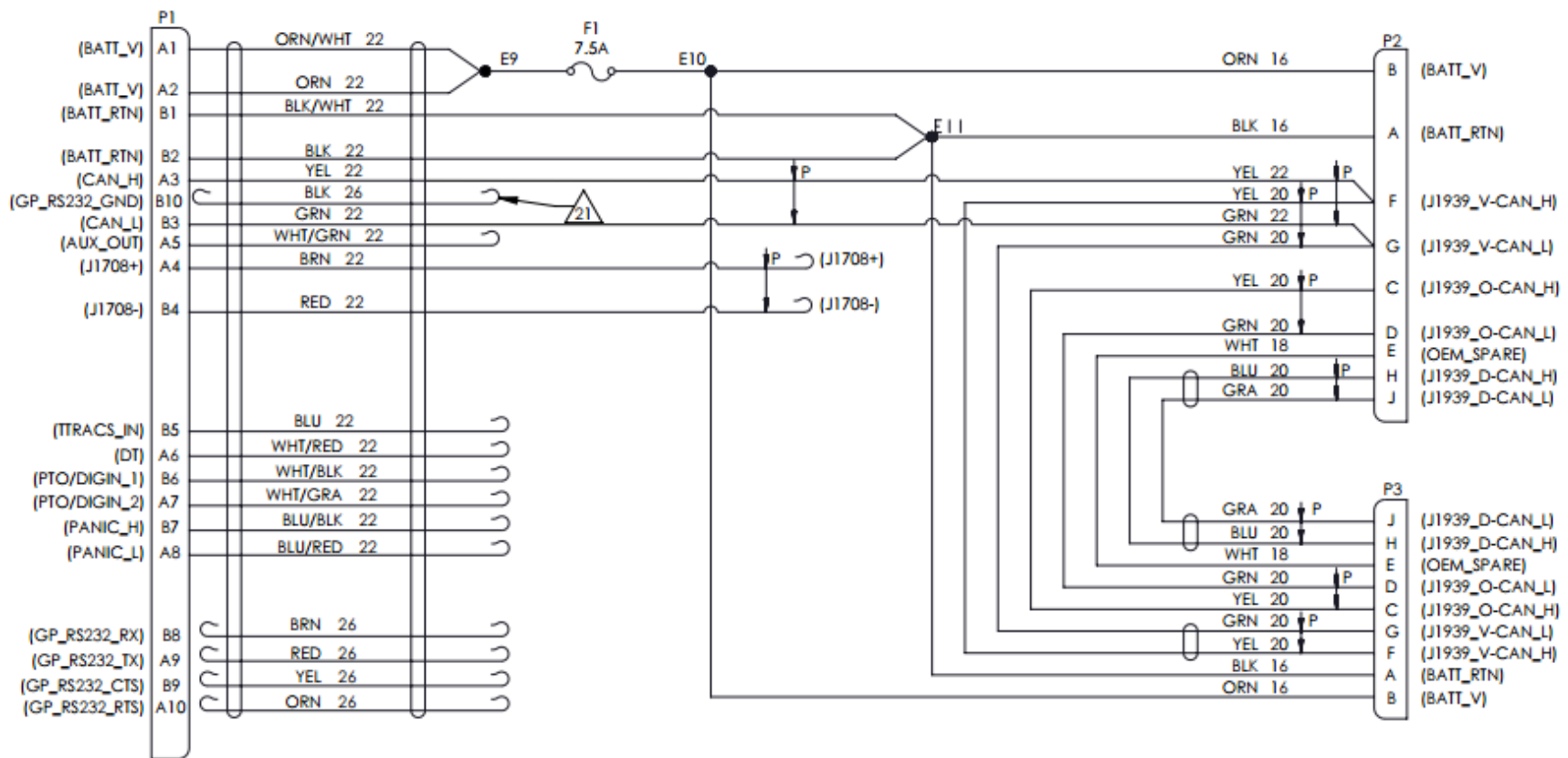

9-pin Power I/O Cable with Green Flange Connector

SIGNAL	PIN	SIGNAL	PIN
BATTERY GROUND	A	J1708 +	F*
+12VDC	B	J1708 -	G*
CAN H	C	OEM_CAN_H	H*
CAN L	D	OEM_CAN_L	J*
OEM SPARE	E*		

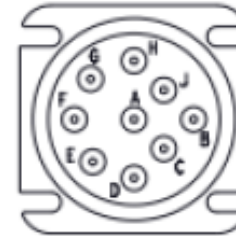

*No IVG Connection

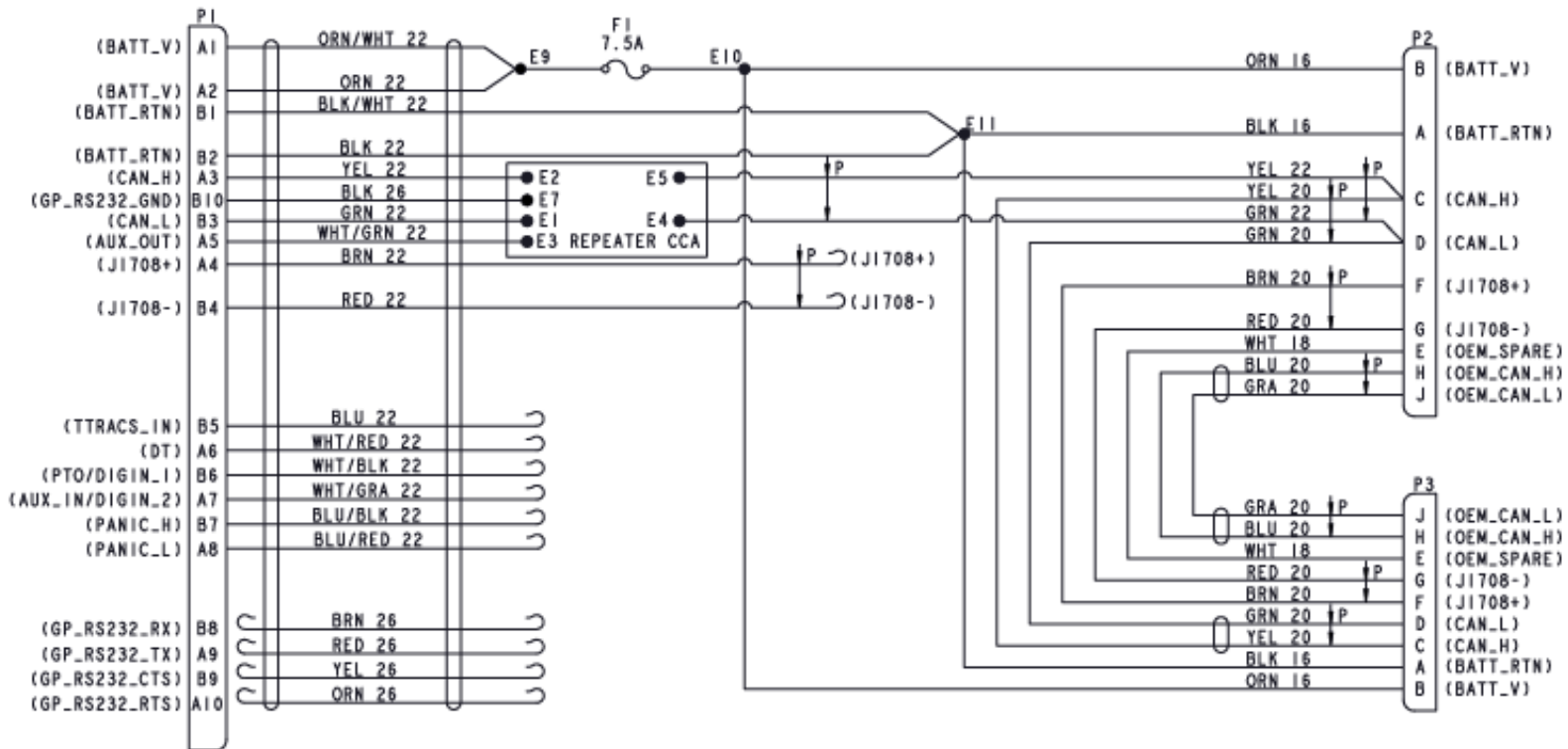

WIRING DIAGRAM

9-pin Power I/O Cable with Green Panel Mount (New Cascadia)

SIGNAL	PIN	SIGNAL	PIN
BATT_RTN	A	J1708+	F*
BATT_V	B	J1708 -	G*
CAN_H	C**	OEM_CAN_H	H*
CAN_L	D**	OEM_CAN_L	J*
OEM_SPARE	E*		

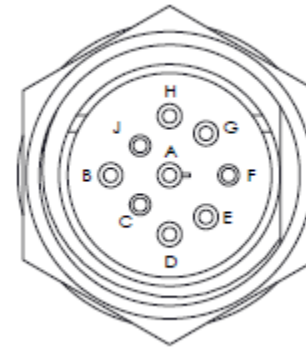

*No IVG Connection

**CAN_H (J1939+) & CAN_L (J1939-) connects vehicle splice pack

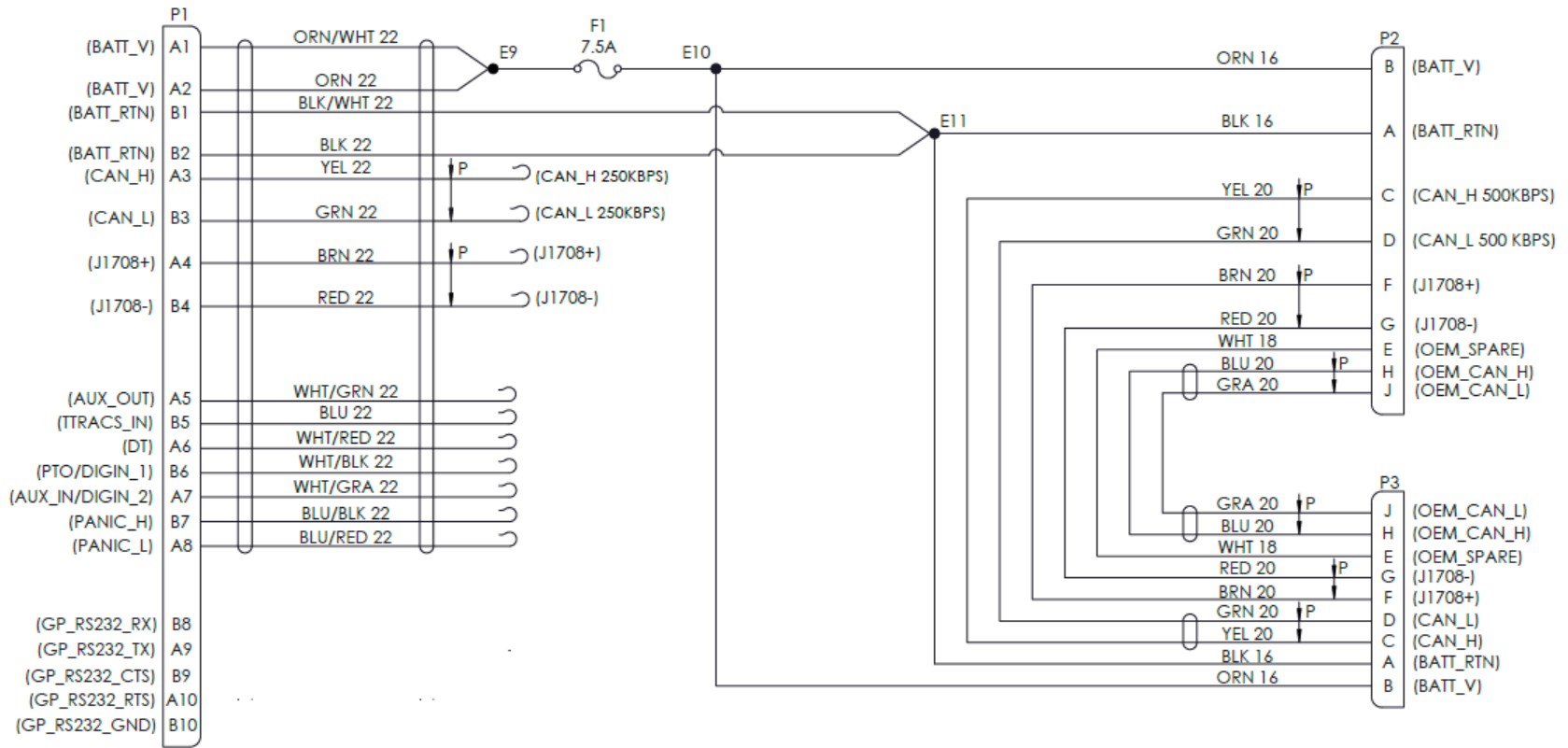

WIRING DIAGRAM

9-pin Power I/O Adapter Cable with Green Panel Mount (Western Star)**

SIGNAL	PIN	SIGNAL	PIN
BAT_RTN	A	J1708+	F*
BATT+	B	J1708-	G*
500KBPS_CAN_H	C	OEM_CAN_H	H*
500KBPS_CAN_L	D	OEM_CAN_L	J*
OEM_SPARE	E*		

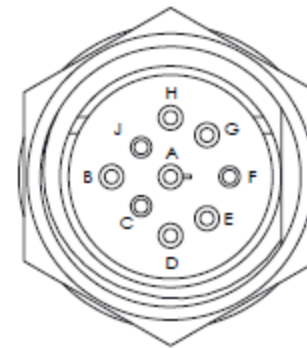

*No IVG Connection

**Use with 45-JE006-1A Cable

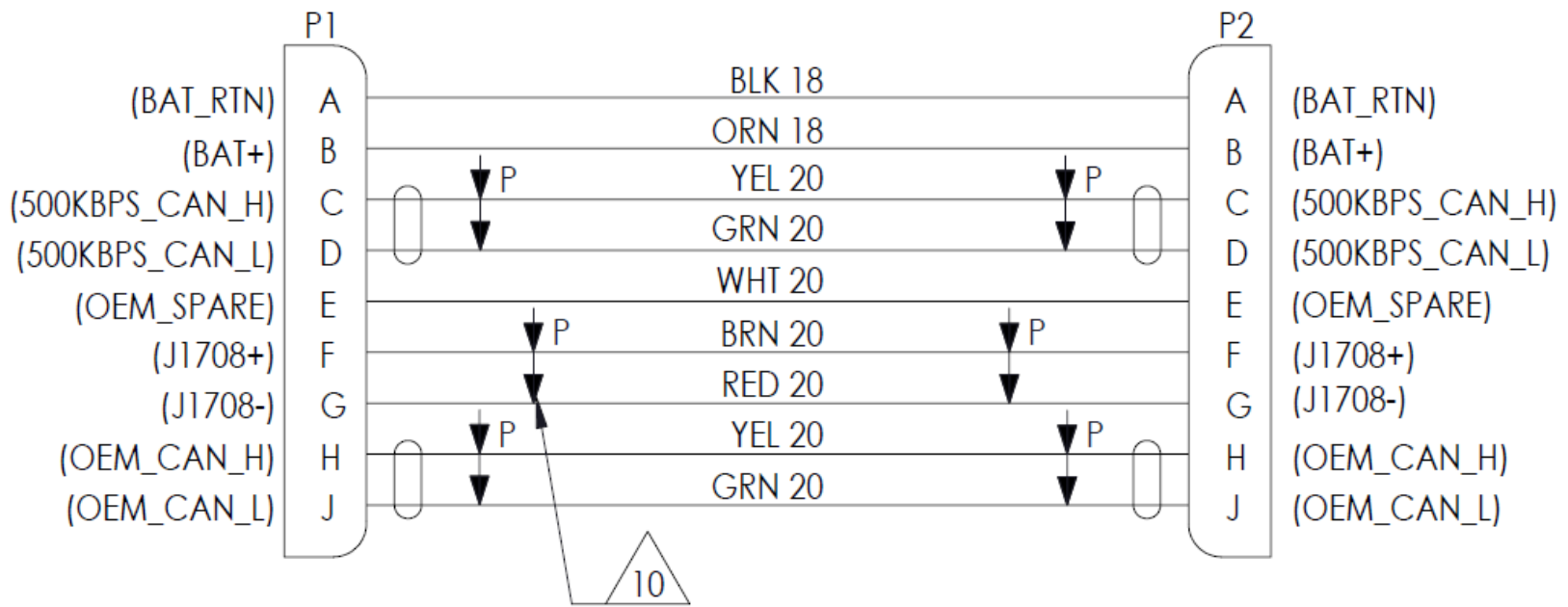

Telematics Connector I/O Cable for Hino with Blue and White Connectors

SIGNAL	P2 – Blue US-built vehicle	P3 – White Japanese-built vehicle
Battery	H	J
Chassis Ground (batt return)	A	B
CAN high	F	G
CAN low	C	D
Ignition	B*	C*

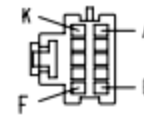

*No IVG Connection

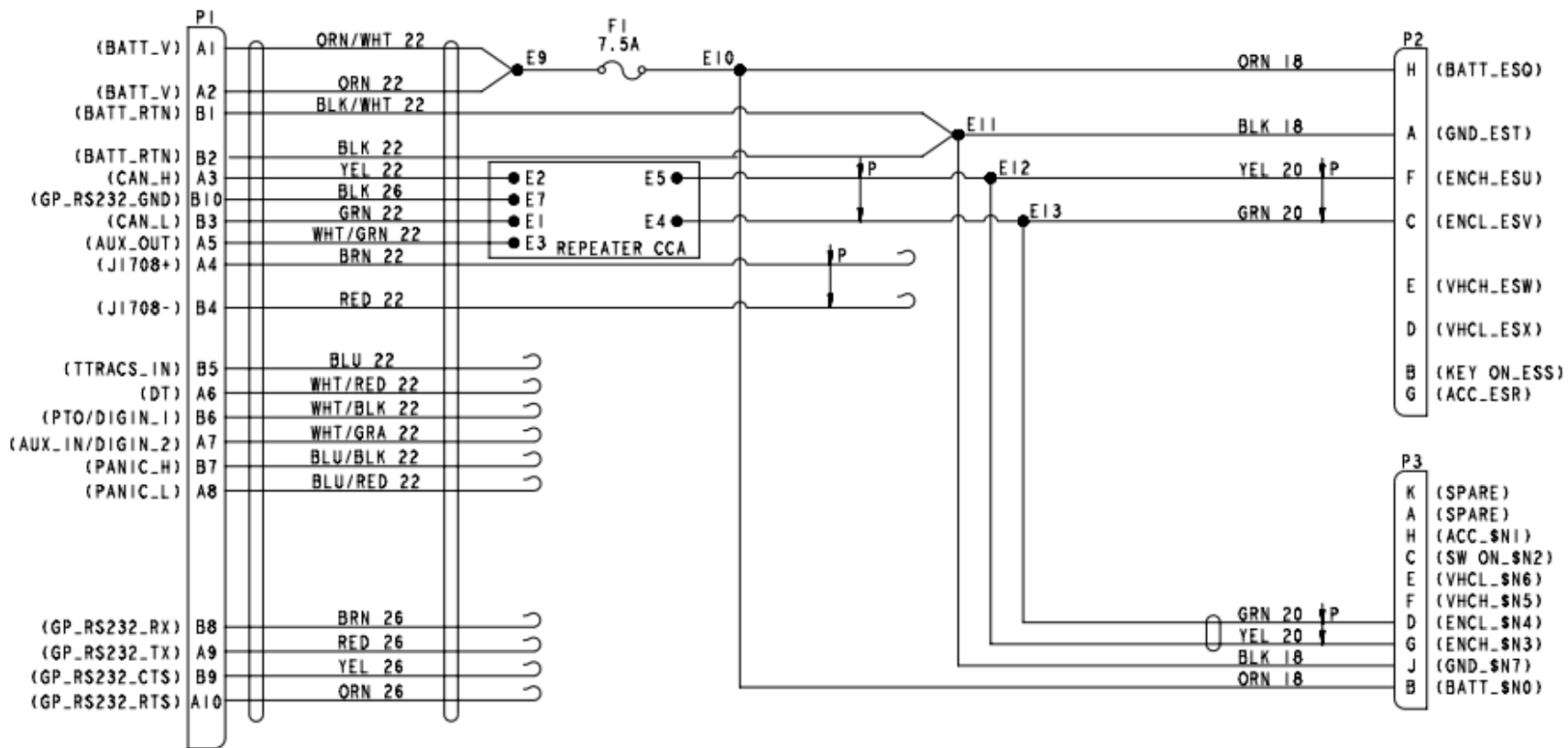

B Environmental and Power Requirements

Condition	Requirement
Operating Temperature	-30° C to 70° C (-35° F to 158° F)
Vibration/Shock	
Humidity: IVG Display	Not watertight. DO NOT get wet. Turn over immediately if liquids are spilled on it.
Power	+6 to +18 VDC
Operating at +12V (IVG display)	IVG draws a maximum of 1.5 amps Average current draw is less than 1 amp
Asleep	IVG draws 10 mA.
Frequency of modems	800 MHz 1x 1900 MHz EVDO (when supported)

The IVG system has no user-serviceable parts. The IVG display contains a permanent lithium coin cell to maintain the real-time clock.

C General Wiring and Installation Guidelines

Standard Installation Electrical Connections

For standard IVG installations, the only electrical connection needed to the truck will be the power I/O cable.

Light Duty or Pick-up Truck Installation (to include any vehicle less than class 7): Cut/Splice Power I/O Cable

Pick-up trucks or cars do not have 6 or 9 pin diagnostics connectors. Therefore, it may be necessary to make direct butt-splice connections. These types of vehicles require the use of the OBDII converter box with cables manufactured by B&B SmartWorx.

The B&B OBDII converter box will have a Y cable that needs to be plugged into the trucks OBDII harness and then into the OBDII converter box.

The Omnitrac's power I/O cable must be cut off and the leads spliced to a constant 12volt source for BATT_V and BATT_RTN and the AUX_IN/DIGIN_2 wire connected to the trucks crank ignition. Call hotline and ask that CDEF444 be disabled. The Power I/O cables J1587 BRN and RED wires need to be butt spliced to the BRN and RED wires on the B&B converter box.

Cable	Car or pick-up
BATT_V	12 VDC unswitched source
BATT_RTN	Chassis ground
J1708+	Positive J1587/J1708 to OBDII harness
J1708-	Negative J1587/J1708 to OBDII harness
AUX_IN/DIGIN_2 wire	Wired IGN to vehicles crank ignition source (CDEF444 set accordingly)



Approved Omnitrac Electrical Connectors

The wiring for the IVG system is expected to be inside the cab. The only Omnitrac-approved electrical connections other than standard connectors are insulated crimp butt-splices and insulated crimp ring terminals. Connections are typically made by mating the two connectors. Many of the following general guidelines apply to non-standard IVG connections where the power I/O cable must be cut because it does easily mount in the truck's dashboard.

CAUTION

Not following proper wiring guidelines and using improper crimps and butt-splices may cause intermittent connections and may result in unexpected truck down time or system failure.

Wire Stripping

CAUTION

Use care in stripping wires. Vibration can cause nicked wires to fail. Using wire cutters, knives, or other tools can damage the conductor wire and/or insulation.

Knowing and following proper wire stripping techniques is essential for performing successful and safe electrical connections of all system components.

1. Using a wire stripper, strip approximately 1/4" off the end of an insulated wire.

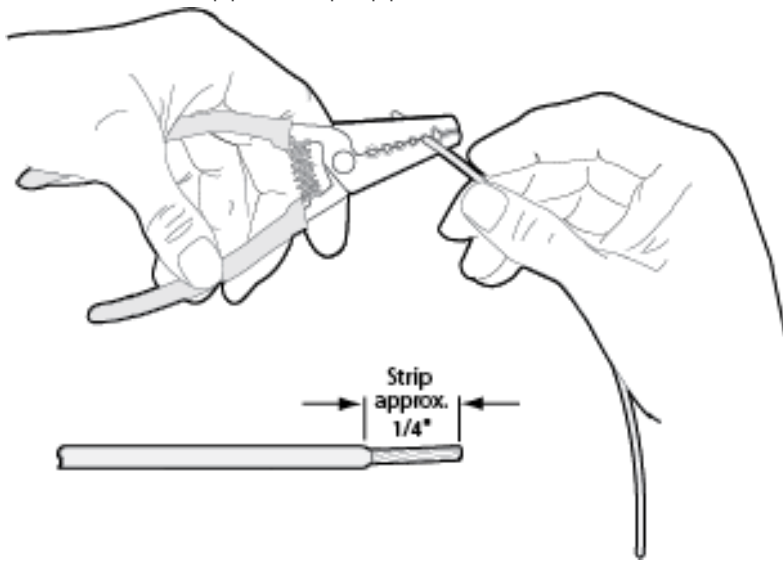

03AAA_270a

2. After stripping the wire, verify that the wire is not severed, nicked, or damaged by the stripping tool. If the wire has been properly stripped, it is ready to be butt-spliced. If the wire has been damaged, restrip the wire.

Butt-Splicing

- Omnitracs recommends Nylon insulated, seamless butt connectors with inspection windows.
- Heat-shrinkable butt connectors are preferred.

Make sure the size of the butt-splice is appropriate for the job. A good butt-splice has these characteristics:

- The ends of the bare wires are visible through an inspection window.
- The ends of the wires "butt" up against the stop.
- The wires are not exposed beyond splice shielding.
- Crimping does not sever or damage the wires or insulation.

Crimping

When crimping a butt-spliced wire or cable, be sure the insulated butt-splice is crimped using the insulated position on the crimp tool and not the crimping "tooth" of the tool.

Crimping butt-splices incorrectly can result in a severed wire and a failed wire connection.

CAUTION

DO NOT crimp on the crimp "tooth."

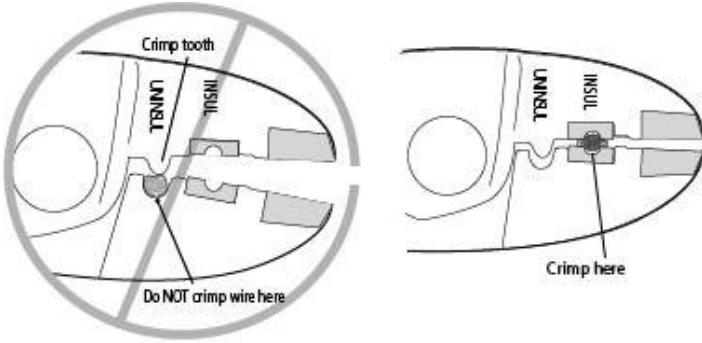

CSAA_516

1. Using a crimping tool, crimp the butt-splice one end at a time. **First**, crimp the inside crimp area where the wire has been stripped. Apply necessary pressure to this inside area.

The objective is to apply the necessary pressure to crimp the butt-splice closed and hold the wire connections together. Do not apply so much pressure as to crush the butt-splice and sever the wire or the insulation on the wire.



WRONG
Butt splice is visibly crushed, possibly damaging the wire and the wire connection.

Some wires are exposed.



CORRECT
Crimping is done properly, protecting the wire and the wire connection.

No exposed wires.

- After crimping the inside of both ends of the butt-splice on the “insulated” area of the crimping tool, next crimp the outside of both ends of the butt-splice.

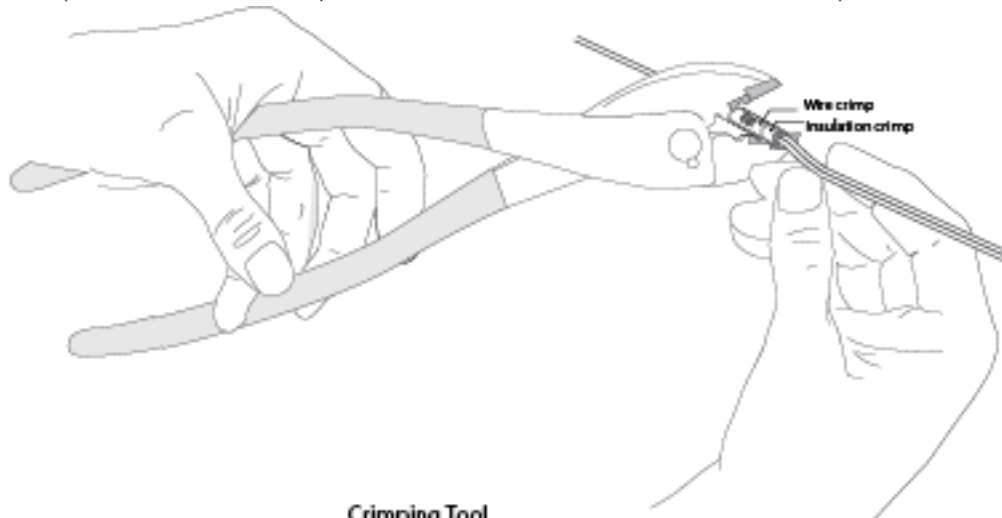

Crimping Tool

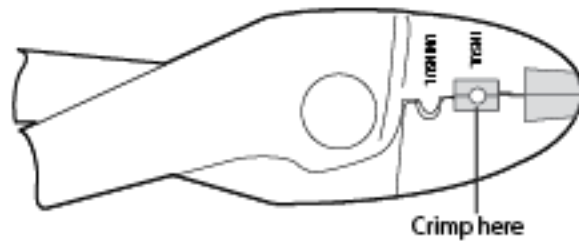

03AAA_271

Crimping locations

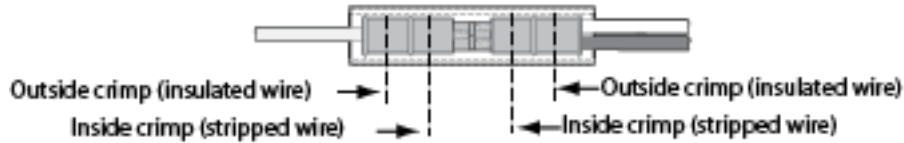

03AAA_273

- Verify that the crimps are good and the wires have not been damaged.

Do a pull test. Pull on both ends of the wires to ensure a solid butt-spliced connection exists. The crimped butt-splice securely grips the insulated wires.

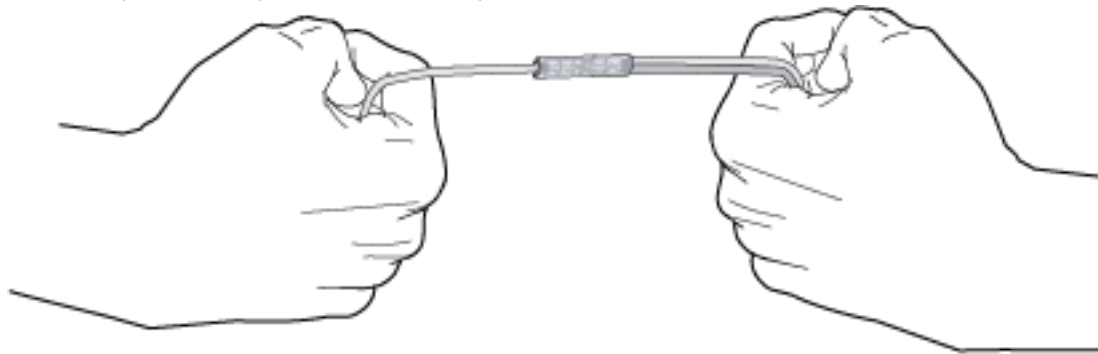

WARNING

If using heat shrinkable crimps, DO NOT use a heat gun or open flame near combustible materials. Use a heat gun only when it is safe and appropriate to do so. Protect surrounding wiring and other components when using a heat gun.

Ring Terminals

When making electrical connections, crimp ring terminals onto the ends of the wires to ensure good contacts. A properly crimped ring terminal has these characteristics:

- The barrel crimping indent is well-formed and properly positioned.
- The insulated wire's grip impression is well-formed and provides proper support without crushing the insulation.
- The wire does not move independently of the lug. Firmly tug on the ring terminal to ensure it does not pull loose.
- The end of the bare wire protrudes through the crimp barrel approximately 0.03 to 0.125" depending on the lug size and crimp tool.

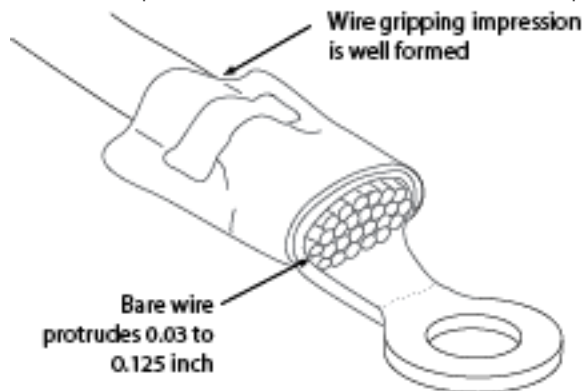

OM/E-0093-07

Install the ring terminal on the ground connection using one of the following options:

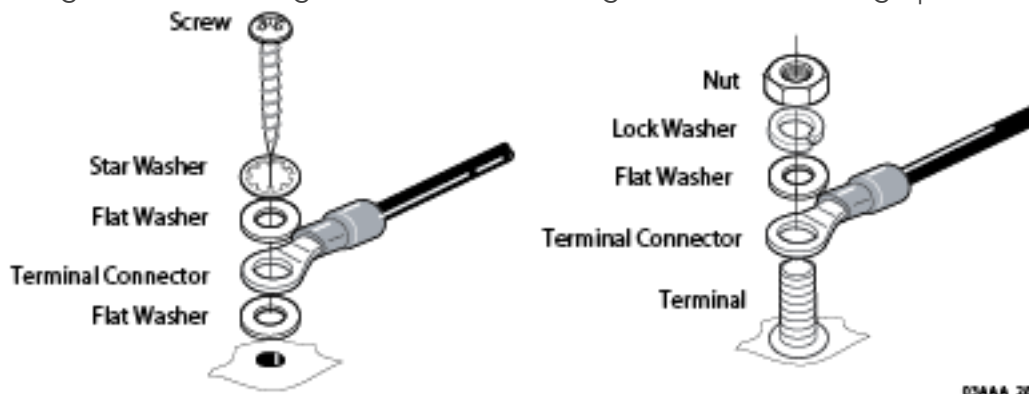

03AAA_205

Proper Grounding

When establishing a good chassis ground, avoid areas that may be potentially isolated from ground by a hinge or bad welds. It is extremely important that you create clean, secure, tight, metal-to-metal grounds. If grounding terminals are not available, remove the paint from the surface of the metal connected to the chassis to make the ground. Make sure the wires are not strained or vulnerable to damage.

WARNING

Not following proper grounding guidelines may cause intermittent connections and may result in unexpected truck downtime or system failure.

General Installation Guidelines

- Determine the most direct and protected route when routing cables to connect the components to each other and to the vehicle.
- Do not trim cable lengths to fit a specific vehicle.
- Use only wire strippers for stripping wires.
- Use only the appropriate insulated crimping tool for crimping insulated connectors.
- Use existing holes for cable routing whenever possible.
- Avoid running cable over or near heat sources.

Routing and Protecting Cables

- Provide strain relief for all cables
- Use tie wraps
- Debur any drilled holes

DO NOT route cables:

- Near audio system amplifiers
- Near exhaust pipes and other sources of heat
- Near the brake, clutch, or accelerator pedals, and linkage
- Near foot traffic areas
- Near the windshield wiper mechanism
- Near CB radio wires
- Over sharp edges
- Over moving parts

Special Interior Routing Guidelines

- Route cables under kick plates or carpets.
- Avoid high foot traffic areas.
- When reinstalling dash panels, be careful that screws do not penetrate cables.
- Route cables with any existing vehicle cables.

Storing Excess Cabling

- Secure excess cabling with tie wraps.
- Stow out of sight.

Stress Relief

Ensure cables have enough slack so connections are not being pulled.

D Standard RMA Procedure

For customers, to return failed equipment, go to Omnitrac's Customer Portal at <https://customer.omnitrac.com>

For service centers only, please return equipment to Omnitrac's at the following address. Make sure that the RMA number is marked clearly on the outside of the box.

Omnitrac's, LLC - RMA Receiving
c/o Baja Freight Forwarders, Inc.
8662 Siempre Viva Road
San Diego, CA 92154

RMA #: _____
(800) 541-7490

To prevent damage during shipment and handling, carefully package all equipment being returned. If the original shipping container and packing material are available, please use them to return the equipment.

E Upgrade the IVG Using USB Memory Sticks

Before You Begin

During an operating system or application upgrade, driver and vehicle information can be deleted. The list below will help minimize any inconvenience this causes.

- Confirm that the driver knows that all stored messages will be lost.
- Have the driver should write down any information from the inbox and outbox that may need later.
- If your company uses Media Manager, confirm that the driver listened to any unopened audio files. Deleted audio files will not be resent to the vehicle.
- Determine if any special services are enabled for this vehicle.

From the IVG Home screen, check to see if the following services are accessible:

- Driver Workflow
- Content Delivery
- Hours of Service
- Navigation
- Performance Monitoring

Requirements for Specific Services

Neither Hours of Service nor Navigation require any additional action before you can upgrade, but for other applications, there are required tasks that you or someone else must complete before the upgrade. If those tasks are not performed, important data may be lost.

Omnitracs Driver Workflow: The trip plan and any pre-plans are deleted during the upgrade.

- **Before:** The driver should write down the details of the next stop in the trip plan.
- **After the upgrade:** the driver should ask dispatch to resend the current trip plan and any pre-plans.

Hours of Service: Normally, no HOS data are lost.

- **Before:** No action needed. The driver's logs are sent to the company's HOS database when the driver logs off the unit.
- **After the upgrade:** the logs are automatically resent to the vehicle the next time the driver logs into HOS. Remind the driver that he needs to account for his time during the

upgrade and record the proper duty status. Recommend that the driver pay special attention to that day the next time he approves the logs.

Navigation: The current route is deleted during the upgrade.

- **Before:** No action needed.
- **After the upgrade:** The driver needs to ask dispatch to resend the list of stops for the current trip.

Performance Monitoring: Performance Monitoring data on the unit are deleted during an upgrade.

- **Before:** The company's System Administrator needs to take steps to ensure the data is not lost by manually extracting the performance data stored in the vehicle's IVG system. For the Omnitracs Services Portal, instructions are in *Performance Monitoring: Administration and Configuration Guide (80-JA316-6)*. For AS/400®, they can refer to the *SensorTRACS/400 User's Guide, Version 2.3 (80-30597-4)*. Remind Operations that your Omnitracs representative can also help the System Administrators with this task.
- **After the upgrade:** Contact Operations and have a System Administrator resend the vehicle's Performance Monitoring parameters.

Firmware Identification and Upgrade

Identify the Firmware and VIOP Versions

1. From the IVG Home screen, use the right arrow to get to the **System** button.

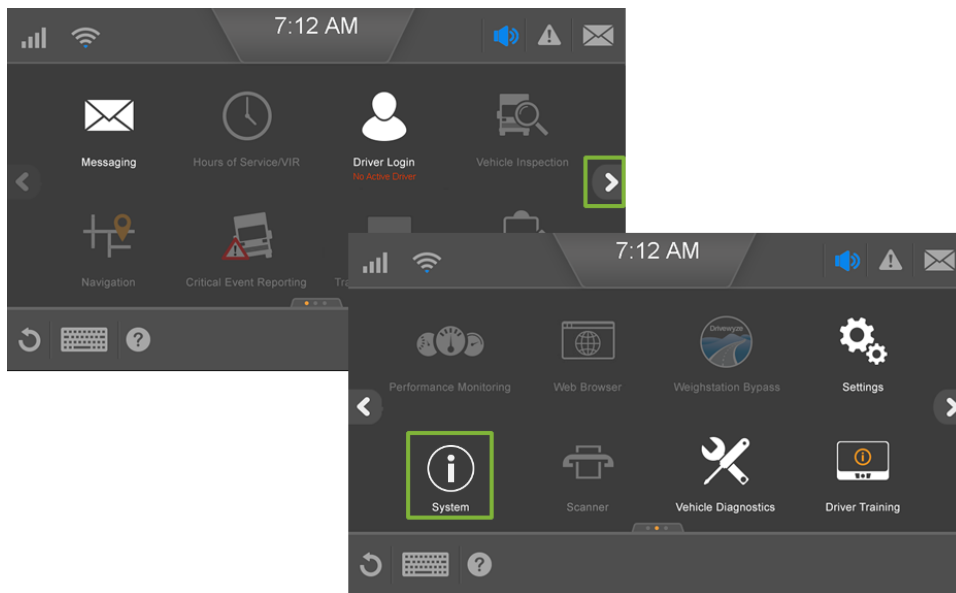

2. Tap the **System** tab to bring up the **System** Screen.

3. Tap the **Version** button at the bottom right to access system information about the IVG. IVG firmware and VIOP version numbers are listed here.

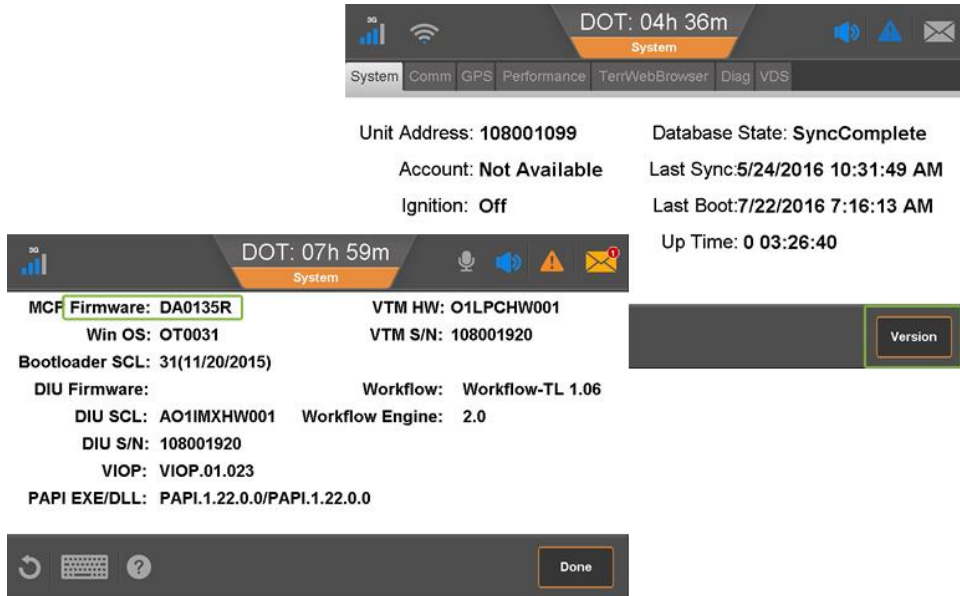

Upgrade the IVG Firmware

1. Make sure the IVG is on.
2. Insert IVG firmware memory stick into the USB port on the right side of the unit. The upgrade process takes approximately ten minutes. The screen will run through various images as it is upgrading. You may see a listing of components, various upgrade screens, a dark or fading screen, unit rebooting, acquiring network, network loading, and others. Be patient. It may appear that nothing is happening, but it the upgrade is going on in the background. After the upgrade finishes, the IVG screen will show the **Home** screen.

3. Start the engine to bring up the **Driver Warning** screen; then tap **OK**.

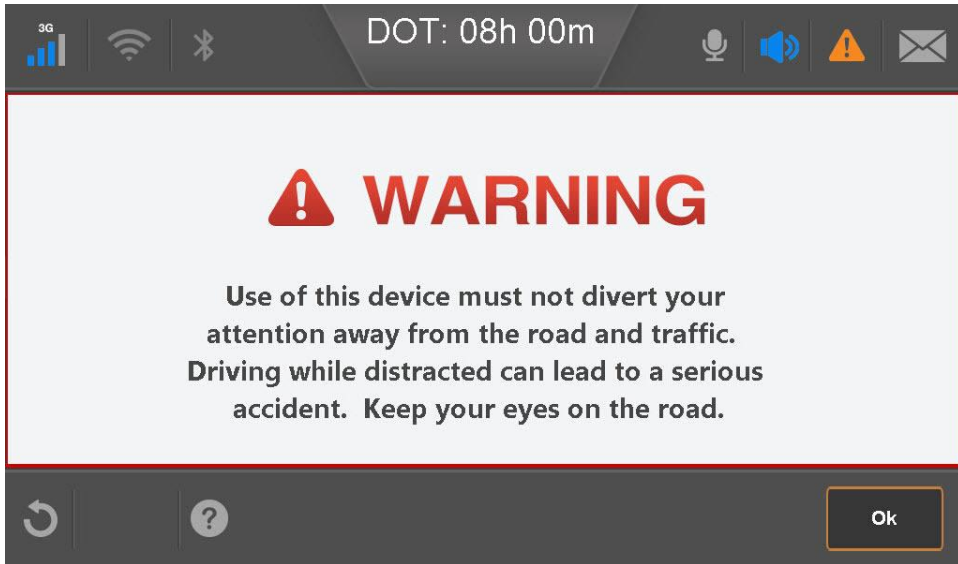

4. Remove the memory stick.
5. Confirm the upgrade is complete by checking that it shows **SyncComplete** on the **System** screen and the **IVG** firmware version on the **Version** screen. This usually occurs 6-10 minutes after the system has booted up.

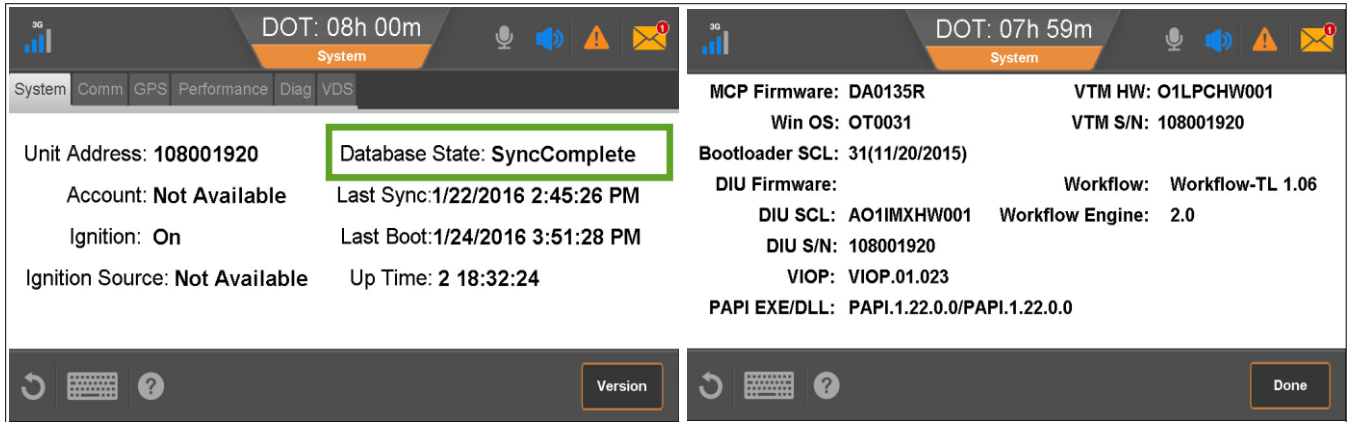

6. Perform system verification.

Upgrade the IVG Operating System

The IVG Operation System (OS) upgrade takes approximately five minutes.

1. Make sure the IVG display is powered ON
2. Insert the IVG OS upgrade stick in the USB port on the right side of the unit. Within a minute of inserting the USB stick, the screen should show 'Shutting Down...'

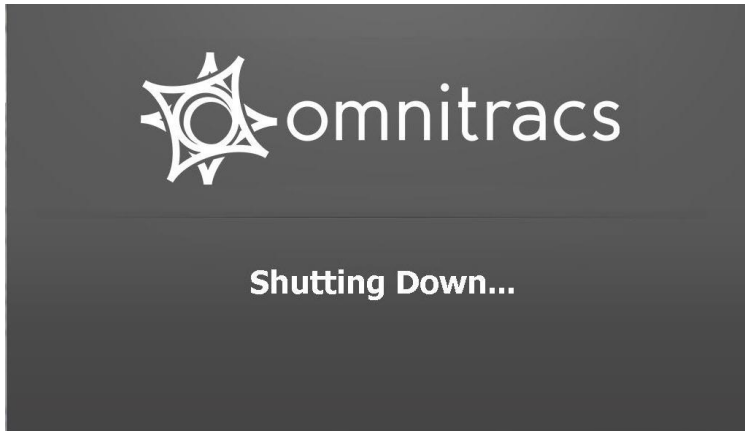

3. After the screen shows a **Select Image Package** window, tap **Open**.

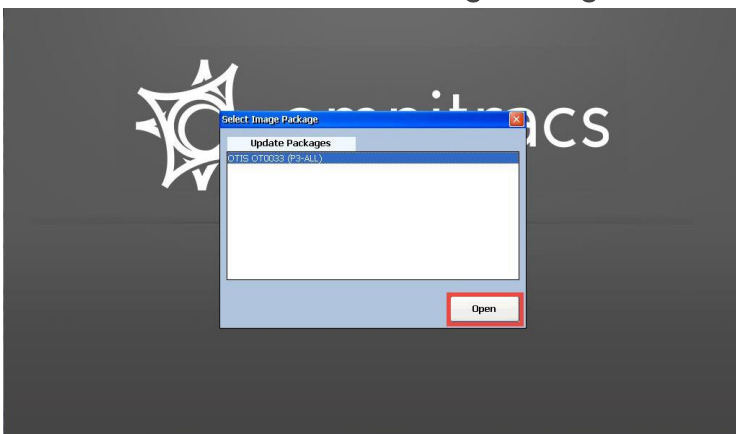

4. After the OS Update screen appears, tap the **Update** button.

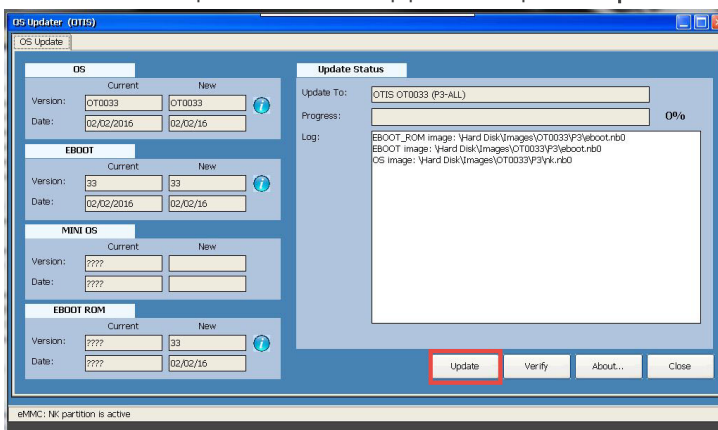

- After the OS upgrade is complete, tap **Reboot**. The system will reboot and return to the Home screen.

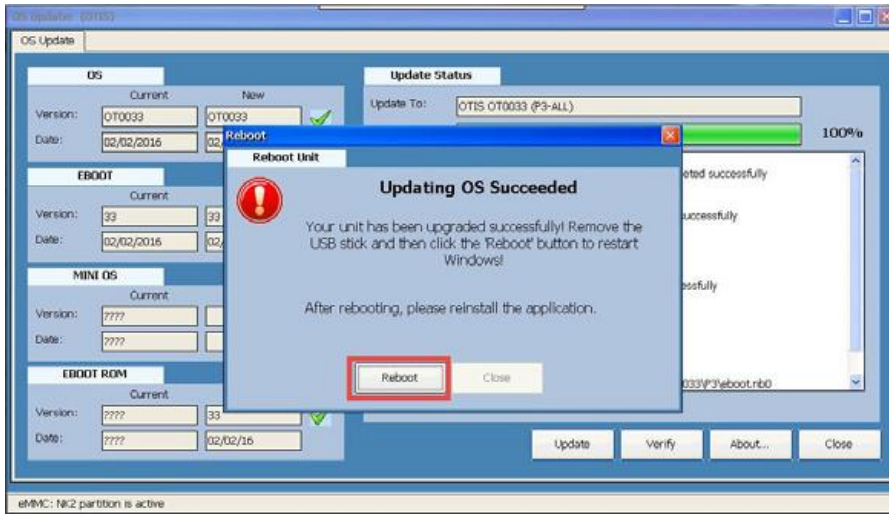

Upgrade the IVG Map Data

Because this step can take between 60 and 90 minutes to complete, ensure that your power down timer is set to 90 minutes or longer, or toggle the ignition every 30 minutes during the upgrade.

Insert the USB memory stick into the IVG unit. After a few seconds, the following message appears.

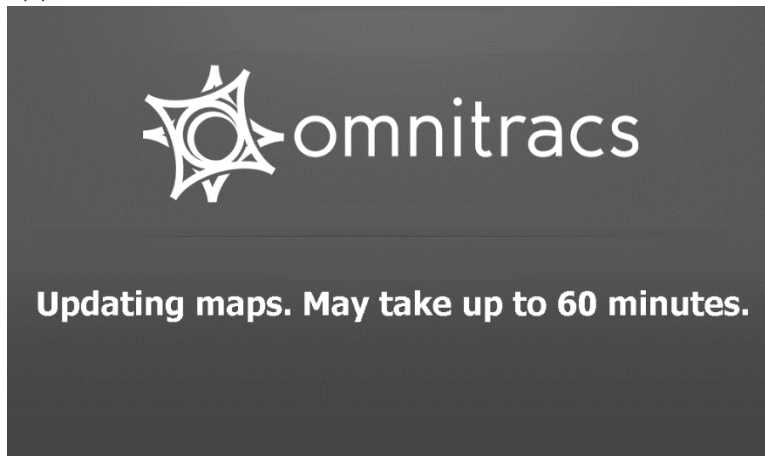

No other screen will be displayed.

When the update is complete, the IVG will return to the unit's home screen.

Verify the Installation

1. Tap **Navigation** from the IVG home screen.
2. Tap **Menu**.
3. Tap **Settings**.
4. Scroll down and tap **About**.
5. Just under the Omnitrac's logo on the About page, ensure the version you installed is displayed in the second line of text.

F Preventive Maintenance Inspection

How Often Should Inspections Be Performed?

Omnitracs recommends inspections be performed at least **once every 90 days** as part of normally scheduled vehicle preventive maintenance inspections.

Performing System Verification

To verify proper IVG operation, go to the **System** home screen, tap the **Diag** tab; then tap **Run All** button.

Verify that, at a minimum, the Cellular End To End, Cellular Signal Strength, CDD Database Sync, GPS Fix, and Core Data Items tests pass.

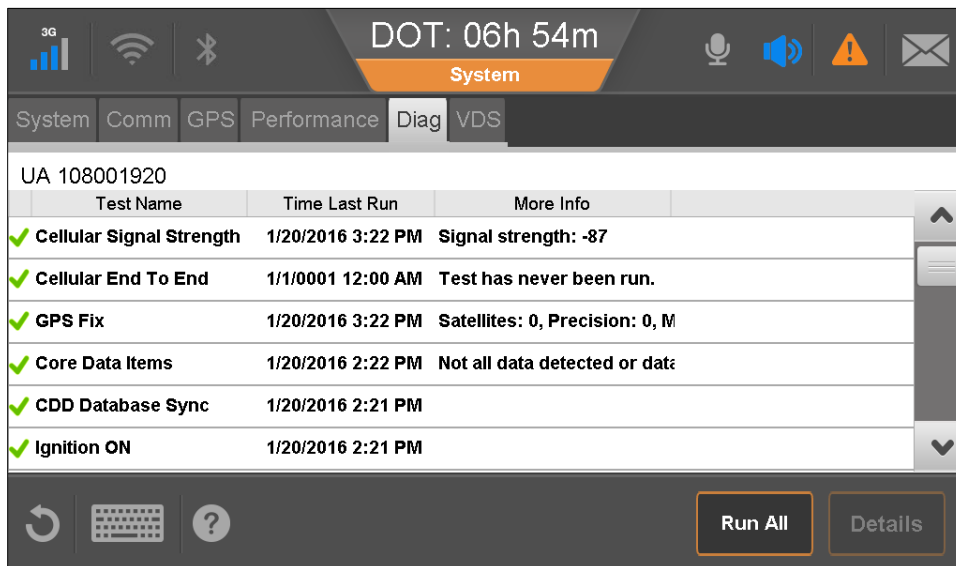

Inspect the IVG Unit

Verify the IVG screen is clean. Omnitrac recommends that you use a soft cloth and either plain water, glass cleaner, or mild soap to gently clean the surfaces of the IVG as well as the display screen.

CAUTION

The IVG is not watertight. Do not spray any liquid directly on the display screen.

Heavily soiled IVG units should be returned to Omnitrac using the RMA process for proper cleaning.



Styluses are available for purchase through the Customer Portal. Do not use pencils, pens, metal objects, or any other devices that could scratch the touchscreen.

- Ensure that the display cable is not a tripping hazard.
- Verify that the display screen is readable in any lighting condition.
- Ensure that the display cable has enough slack and is not being rubbed or cut by anything inside the cab.
- Remove the IVG from the holster and make sure the RAM mount and screws holding the holster in place are secure.

G Component Information

System Component	Illustration	MCN	Notes
IVG Display		CV90-JC339-101 or CV90-JE045-101	
Holster		CV90-JC339-710	
IVG Mounting Kit with Nut plate, RAM mount		65-JB313-1	
IVG Mounting Kit: bracket, RAM mount		50-J9978-1	Specifically for Freightliner Columbia or Century

System Component	Illustration	MCN	Notes
9-Pin Power I/O Cable with Standard Flange		45-JC364-1A	Most 2006 and newer trucks, transition late 2005-2006.
6-Pin Power I/O Cable with Standard Flange		45-JC365-1A	All trucks 2005 and older, transition late 2005-2006.
OBDII Style J1939 Power I/O Cable for Volvo/Mack 2014 and Newer Not for use with light duty OBDII vehicles that require the OBDII convertor and cables.		45-JC366-1A	2014 and newer Volvo and Mack trucks.
9-Pin Power I/O 250 kbps Cable for Paccar		45-JC373-1A	9-pin connector for use with certain Paccar trucks i.e. Kenworth and Peterbilt.

System Component	Illustration	MCN	Notes
9-Pin Power I/O 500 kbps with Green Connectors for Daimler/Navistar 2016 or Newer		45-JE006-1A	9-pin 500 kbps with repeater
9-Pin Power I/O 250 kbps with Green Connectors for Paccar 2016 or Newer		45-JE042-1A	9-pin 250 kbps without repeater – Pin F and Pin G for J1939 vehicle data.
Hino Power I/O Cable		45-JE022-1A	Early 2011 Hino trucks and late 2011 and newer Hino trucks may not have a telematics connector. Connections will need to be butt-spliced. Refer to the Hino Truck Specific Installation Suggestions.
9-Pin I/O Cable with Green Panel Mount (New Cascadia)		45-JE081-1A	2016 or newer. Panel Mount Connector.

System Component	Illustration	MCN	Notes
9-Pin Power I/O Adapter with Green Panel Mount (Western Star)		45-JC593-1	Adapter to be used with 45-JE006-1A cable for installation in Western Star vehicles.

H Installation Form



Installation Work Order Details Intelligent Vehicle Gateway (IVG)

Company Name: _____ Installation Date: _____
 Invoice #: _____ Purchase Order #: _____ VIN (optional) _____
 Driver Name: _____ Truck #: _____ Mo/Yr: _____ MFG/Model : _____
 Technician #1: _____ Technician #2: _____
 Unit Address (Display S/N): _____ Verification Code _____ Is this factory pre-wired? Yes ___ No ___
 IVG Display Mounting Location: _____
 Diagnostic connector: 6-PIN ___ 9-PIN Black ___ 9-PIN Green ___ Volvo/Mack ___ OBDII Box ___
 IVG Firmware: _____ Win OS: _____
 PTO Required: Yes ___ No ___ PTO Signal Active High ___ Active Low (relay required) ___ TTRACS ___ Panic ___
 Did you call the Hotline for troubleshooting assistance? Yes ___ No ___ Case ID and Name: _____

Metrics: DIAG tab: RUN ALL

Put ✓ or X	Test Name	More Info
	Cellular Signal Strength	Signal Strength: _____
	Cellular End to End	Pass or Fail
	CDD Database Sync	
	GPS (From GPS tab)	Mode: _____ Precision: _____ Satellites: _____ / _____
	J1587 Packet Detection	
	J1939 Packet Detection	
	Ignition ON	If green, toggle Ignition OFF and retest to verify you get red X
	Core Data Items (if not GRN, X items to the right using DETAILS Tab)	___Speed ___Distance LTD ___Fuel LTD ___RPM

Brightness and Text to Speech Verification:

Brightness responds to adjustments? Yes ___ No ___ TTS volume control works? Yes ___ No ___

Message Verification (send test message with truck number): Queued ___ Acknowledged ___

Parts Missing at Install:

Product ID	Description

Comments _____

I find the service rendered and materials installed in connection with the above mentioned work to have been completed in a satisfactory manner.

Driver/Customer Signature: _____ Date: _____

I RF Exposure Information (SAR)

This device meets the government's requirements for exposure to radio waves. This device is designed and manufactured to not exceed the emission limits for exposure to radio frequency (RF) energy set by the Federal Communications Commission (FCC) of the United States Government and Industry Canada (IC) of Canada. For optimal device performance and so that human exposure to RF energy does not exceed the FCC and IC guidelines, always follow these instructions and precautions: Orient the device in landscape mode with the cellular antenna (located at the top right corner of the device) away from your body or other objects.







The exposure standard employs a unit of measurement known as the Specific Absorption Rate, or SAR. The SAR limit set by the FCC is 1.6 watts per kilogram (W/kg) for body exposure and 4.0 W/kg for extremity exposure. Tests for SAR are conducted using standard operating positions accepted by the FCC/IC with the EUT transmitting at the specified power level in different channels. Although SAR is determined at the highest certified power level in each frequency band, the actual SAR level of the device while in operation can be well below the maximum value because device adjusts its cellular transmitting power based, in part, on proximity to the wireless network. In general, the closer you are to a cellular base station, the lower the cellular transmitting power level.







The device was tested according to measurement standards and procedures specified in FCC OET Bulletin 65, Supplement C (Edition 01-01) and Canada RSS 102. The FCC/IC has granted an Equipment Authorization for this device with all reported SAR levels evaluated as in compliance with the defined RF exposure guidelines. SAR information on this device is on file with the FCC and can be found under the Display Grant section of <https://www.fcc.gov/oet/ea/fccid> and searching on FCC ID: 2AE8ZIVG for CV90-JC339 or 2AE8ZIVG2 for CV90-JE045.

J Icon Definitions



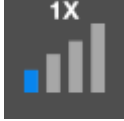
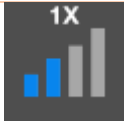





These icons appear within the header of the IVG display.

Each technology-specific, data transfer method will show the communication technology type above the signal strength bars. For example, if the mobile is communicating on a 3G network, you'll see 3G above the signal strength bars. If the mobile unable to communicate with the Omnitrac's network communication center, there will be an **X** or **?** in the upper right corner of the signal strength indicator.

Icon	Definition
	Bluetooth capable, but not enabled
	Bluetooth enabled
	No Wi-Fi connection
   	Low – high Wi-Fi signal strength
	Connected to access point but not Omnitrac's network

Icon	Definition
	No signal and unable to communicate with the Omnitrac network operations center, RSSI between -106 and -109 – example shows 1x communications
	No signal, RSSI between -106 and -109
	One bar, RSSI between -96 and -105
	Two bars, RSSI between -86 and -95
	Three bars, RSSI between -76 and -85
	Four bars, RSSI between -50 and -75
	Examples of 1x, 3G, Edge, GPRS, and UMTS network connections

Icon	Definition
	Low - high Critical Event Video signal strength
	Low priority message received and read
	Low priority unread message waiting. The number of unread messages of this priority display in the red circle.
	Important priority message received and read
	Important priority unread message waiting. The number of unread messages of this priority display in the red circle.
	Emergency priority message received and read
	Emergency priority unread message waiting. The number of unread messages of this priority display in the red circle.
	No mail

Icon	Definition
	Low priority alert
	Important priority alert
	Emergency priority alert
	No alerts
	Intelligent Voice Interface enabled, active and awaiting commands
	Intelligent Voice Interface capable, not awaiting commands
	Volume enabled
	Muted