



TEST REPORT

For

Applicant : Vertex Telecom,Inc.

Address : 980 Corporate Center Drive, Pomona CA 91768

Product Name : DamaiBox 3.0

Model Name : DB3026US, DB3026SA, HPH32

Brand Name : Damai

FCC ID : 2AE7M-DB3026

Report No. : MTE/DYY/S16071571

Date of Issue : Jul. 25, 2016

Issued by : Most Technology Service Co., Limited

**Address : No.5, 2nd Langshan Road, North District, Hi-tech Industrial
Park, Nanshan, Shenzhen, Guangdong, China**

Tel : 86-755-8602 6850

Fax : 86-755-2601 3350

The report consists 81 pages in total. It may be duplicated completely for legal use with the approval of the applicant. It should not be reproduced except in full, without the written approval of our laboratory. The client should not use it to claim product endorsement by MOST. The test results in the report only apply to the tested sample. The test report shall be invalid without all the signatures of testing engineers, reviewer and approver.

TABLE OF CONTENTS

1. VERIFICATION OF CONFORMITY	3
2. GENERAL INFORMATION	4
2.1 Product Information.....	4
2.2 Objective	4
2.3 Test Standards and Results.....	5
2.4 Environmental Conditions.....	5
3. TEST METHODOLOGY.....	6
3.1 TEST FACILITY	6
3.2 GENERAL TEST PROCEDURES	6
4. SETUP OF EQUIPMENT UNDER TEST	7
4.1 SETUP CONFIGURATION OF EUT.....	7
4.2 EUT configuration	7
4.3 TEST EQUIPMENT LIST	8
5.1 ANTENNA REQUIREMENT.....	9
5.1.1 Applicable Standard	9
5.2.1 Requirement	10
5.2.2 Block Diagram of Test Setup	10
5.2.3 Test procedure	10
5.2.4 Test Result	10
5.3 Radiated Emission	13
5.3.1 Requirement	13
5.3.2 Test Configuration	13
5.3.3 Test Procedure:	14
5.3.4 Test Result	15
5.4 Conducted Peak Output Power.....	28
5.4.1 Requirement	28
5.4.2 Block Diagram of Test Setup	28
5.4.3 Test Procedure	28
5.4.4 Test Result	28
5.5 6dB Emission Bandwidth	30
5.5.1 Test Requirement	30
5.5.2 Block Diagram of Test Setup	30
5.5.3 Test Procedure	30
5.5.4 Test Result	30
5.6 POWER SPECTRAL DENSITY.....	40
5.6.1 Applicable Standard	40
5.6.2 Block Diagram of Test Setup	40
5.6.3 Test Procedure	40
5.6.4 Test Result	40
5.7 Band Edge and Conducted Spurious Emissions	50
5.7.1 Test Requirement	50
5.7.2 Test Procedure	50
5.7.3 Test Result	50
5.8 Restricted Frequency Bands.....	57
5.8.1 Test Requirement	57
5.8.2 Test Configuration	57
5.8.3 Test Procedure:	57
5.8.4 Test Result	57

1. VERIFICATION OF CONFORMITY

Equipment Under Test:	DamaiBox 3.0
Brand Name:	Damai
Model Number:	DB3026US
FCC ID:	2AE7M-DB3026
Applicant:	Vertex Telecom, Inc. 980 Corporate Center Drive, Pomona CA 91768
Manufacturer:	Vertex Telecom, Inc. 980 Corporate Center Drive, Pomona CA 91768
Technical Standards:	47 CFR Part 15 Subpart C
File Number:	MTE/DYY/S16071571
Date of test:	Jun.27-Jul. 20, 2016
Deviation:	None
Condition of Test Sample:	Normal
Test Result:	PASS

The above equipment was tested by Most Technology Service Co., Ltd. for compliance with the requirements set forth in FCC rules and the Technical Standards mentioned above. This said equipment in the configuration described in this report shows the maximum emission levels emanating from equipment and the level of the immunity endurance of the equipment are within the compliance requirements.

The test results of this report relate only to the tested sample identified in this report.

Prepared by (+ signature):

Daisy

Daisy Yu

Jun.27-Jul. 20, 2016

Review by (+ signature):

Henry

Henry Chen



Jul. 25, 2016

Approved by (+ signature):

Yvette Zhou

Yvette Zhou (Manager)

Jul. 25, 2016

2. GENERAL INFORMATION

2.1 Product Information

Product	DamaiBox 3.0
Brand Name	Damai
Model Number	DB3026US
Series Model Name:	DB3026SA, HPH32
Series Model Difference description:	Only difference in the model name.
Power Supply	DC 12V by AC adapter 100-240V, 50/60Hz
Frequency Range	802.11b/g/n(20MHz): 2412-2462MHz 802.11n(40MHz): 2422-2452MHz
Modulation Type:	IEEE 802.11b mode: DSSS IEEE 802.11g mode: OFDM 802.11n Standard-20 MHz Channel mode: OFDM 802.11n Standard-40 MHz Channel mode: OFDM
Channel Number	802.11b/g/n(20MHz): 11 802.11n(40MHz): 7
Antenna Type	Antenna A: Internal PCB Antenna, 3.36dBi Antenna B: Internal PCB Antenna, 3.36dBi
Remark:	Antenna A and antenna B can not transmit at the same time
Temperature Range	0°C ~ +45°C

NOTE:

1. For a more detailed features description about the EUT, please refer to User's Manual.

2.2 Objective

The objective of the report is to perform tests according to FCC Part 15 Subpart C for the EUT FCC ID Certification:

No.	Identity	Document Title
1	47 CFR Part 15	Radio Frequency Devices
2	KDB 558074	Guidance for Performing Compliance Measurements on Digital Transmission Systems (DTS) Operating Under §15.247

2.3 Test Standards and Results

No.	Section	Test Items	Result	Date of Test
1	FCC 15.247 (i)	RF EXPOSURE	PASS	2016-07-14
2	FCC 15.203	Antenna Requirement	PASS	2016-07-14
3	FCC15.207 (a)	AC Power Line Conducted Emission	PASS	2016-06-29
4	FCC15.209, 15.247(d)	Radiated Emission	PASS	2016-07-08
5	FCC15.247(b)(3)	Conducted Peak Output Power	PASS	2016-07-10
6	FCC15.247(a)(2)	6dB Emission Bandwidth	PASS	2016-07-10
7	FCC15.247(e)	Power Spectral Density	PASS	2016-07-19
8	FCC15.247(d)	Band Edge and Conducted Spurious Emissions	PASS	2016-07-19
9	FCC15.247(d)	Restricted Frequency Bands	PASS	2016-07-18

Note: 1. The test result judgment is decided by the limit of measurement standard
 2. The information of measurement uncertainty is available upon the customer's request.

2.4 Environmental Conditions

During the measurement the environmental conditions were within the listed ranges:

- Temperature: 15-35°C
- Humidity: 30-60 %
- Atmospheric pressure: 86-106 kPa

3. TEST METHODOLOGY

3.1 TEST FACILITY

Test Site:	Most Technology Service Co., Limited
Location:	No.5, Langshan 2nd Rd., North Hi-Tech Industrial park, Nanshan, Shenzhen, Guangdong, China
Description:	There is one 3m semi-anechoic an area test sites and two line conducted labs for final test. The Open Area Test Sites and the Line Conducted labs are constructed and calibrated to meet the FCC requirements in documents ANSI C63.10:2013 and CISPR 16 requirements. The FCC Registration Number is 490827 . The IC Registration Number is 7103A-1 .
Site Filing:	The site description is on file with the Federal Communications Commission, 7435 Oakland Mills Road, Columbia, MD 21046.
Instrument	All measuring equipment is in accord with ANSI C63.10:2013 and CISPR 16
Tolerance:	requirements that meet industry regulatory agency and accreditation agency requirement.
Ground Plane:	Two conductive reference ground planes were used during the Line Conducted Emission, one in vertical and the other in horizontal. The dimensions of these ground planes are as below. The vertical ground plane was placed distancing 40 cm to the rear of the wooden test table on where the EUT and the support equipment were placed during test. The horizontal ground plane projected 50 cm beyond the footprint of the EUT system and distanced 80 cm to the wooden test table. For Radiated Emission Test, one horizontal conductive ground plane extended at least 1m beyond the periphery of the EUT and the largest measuring antenna, and covered the entire area between the EUT and the antenna.

3.2 GENERAL TEST PROCEDURES

Radiated Emissions

The EUT is placed on a turn table, 0.8 m above ground plane is for frequency below 1GHZ.1.5m above ground plane is for frequency above 1GHZ.The turntable shall rotate 360 degrees to determine the position of maximum emission level. EUT is set 3m away from the receiving antenna, which varied from 1m to 4m to find out the highest emission. And also, each emission was to be maximized by changing the polarization of receiving antenna both horizontal and vertical. In order to find out the maximum emissions, exploratory radiated emission measurements were made according to the requirements in Section 6.5 of ANSI C63.10:2013.

Conducted Emissions

The EUT is placed on the turntable, which is 0.8 m above ground plane. According to the requirements in Section 6.2 of ANSI C63.10:2013,Conducted emissions from the EUT measured in the frequency range between 0.15 MHz and 30MHz using CISPR Quasi-peak and average detector modes.

4. SETUP OF EQUIPMENT UNDER TEST

4.1 SETUP CONFIGURATION OF EUT

See test photographs attached in Appendix 1 for the actual connections between EUT and support equipment.

4.2 EUT configuration

Interface cables:

Interface cable	Length [m]	Type	Line		Line termination
			shielded	unshielded	
Power cord	1.5	three wires	<input type="checkbox"/>	<input checked="" type="checkbox"/>	Monitor
HDMI cable	1	Video& Audio type	<input type="checkbox"/>	<input checked="" type="checkbox"/>	Monitor& EUT

Peripheral devices:

List out all peripheral not included with EuT used during the test

Kind of equipment	Manufacturer	Model no.
Monitor	DELL	U2414Hb

Remark:

All the equipment/cables were placed in the worst-case configuration to maximize the emission during the test. Grounding was established in accordance with the manufacturer's requirements and conditions for the intended use.

4.3 TEST EQUIPMENT LIST

Instrumentation: The following list contains equipment used at Most for testing. The equipment conforms to the CISPR 16-1 / ANSI C63.2 Specifications for Electromagnetic Interference and Field Strength Instrumentation from 10 kHz to 1.0 GHz or above.

No.	Equipment	Manufacturer	Model No.	S/N	Calibration date	Calibration Interval
1	Test Receiver	Rohde & Schwarz	ESCI	100492	2016/03/10	1 Year
2	L.I.S.N.	Rohde & Schwarz	ENV216	100093	2016/03/10	1 Year
3	Coaxial Switch	Anritsu Corp	MP59B	6200283933	2016/03/07	1 Year
4	Terminator	Hubersuhner	50Ω	No.1	2016/03/07	1 Year
5	RF Cable	SchwarzBeck	N/A	No.1	2016/03/07	1 Year
6	Test Receiver	Rohde & Schwarz	ESPI	101202	2016/03/10	1 Year
7	Bilog Antenna	Sunol	JB3	A121206	2016/03/14	1 Year
8	Horn Antenna	SCHWARZBECK	BBHA9120D	756	2016/03/14	1 Year
9	Horn Antenna	Penn Engineering	9034	8376	2016/03/14	1 Year
10	Cable	Resenberger	N/A	NO.1	2016/03/07	1 Year
11	Cable	SchwarzBeck	N/A	NO.2	2016/03/07	1 Year
12	Cable	SchwarzBeck	N/A	NO.3	2016/03/07	1 Year
13	DC Power Filter	DuoJi	DL2×30B	N/A	2016/03/07	1 Year
14	Single Phase Power Line Filter	DuoJi	FNF 202B30	N/A	2016/03/07	1 Year
15	3 Phase Power Line Filter	DuoJi	FNF 402B30	N/A	2016/03/07	1 Year
16	Test Receiver	Rohde & Schwarz	ESCI	100492	2016/03/10	1 Year
17	Absorbing Clamp	Luthi	MDS21	3635	2016/03/12	1 Year
18	Coaxial Switch	Anritsu Corp	MP59B	6200283933	2016/03/07	1 Year
19	AC Power Source	Kikusui	AC40MA	LM003232	2016/03/10	1 Year
20	Test Analyzer	Kikusui	KHA1000	LM003720	2016/03/10	1 Year
21	Line Impedance Network	Kikusui	LIN40MA-PCR-L	LM002352	2016/03/10	1 Year
22	ESD Tester	Kikusui	KES4021	LM003537	2016/03/07	1 Year
23	EMC PRO System	EM Test	UCS-500-M4	V0648102026	2016/03/10	1 Year
24	Signal Generator	IFR	2032	203002/100	2016/03/10	1 Year
25	Amplifier	A&R	150W1000	301584	2016/03/14	1 Year
26	CDN	FCC	FCC-801-M2-25	47	2016/03/10	1 Year
27	CDN	FCC	FCC-801-M3-25	107	2016/03/10	1 Year
28	EM Injection Clamp	FCC	F-203I-23mm	403	2016/03/10	1 Year
29	RF Cable	MIYAZAKI	N/A	No.1/No.2	2016/03/10	1 Year
30	Universal Radio Communication Tester	ROHDE&SCHWARZ	CMU200	0304789	2016/03/10	1 Year
31	Telecommunication Antenna	European Antennas	PSA 75301R/170	0304213	2016/03/10	1 Year
32	Telecommunication Test Equipment	R&S	CMU200	N/A	2016/03/07	1 Year
33	8 Loop Antenna	ARA	PLA-1030/B	1029	2016/01/10	1 Year
34	Power Meter	Anritsu	ML2495A	1204008	2016/03/10	1 Year

NOTE: Equipments listed above have been calibrated and are in the period of validation.

5.1 ANTENNA REQUIREMENT

5.1.1 Applicable Standard

According to FCC § 15.203 , An intentional radiator shall be designed to ensure that no antenna other than that furnished by the responsible party shall be used with the device. The use of a permanently attached antenna or of an antenna that uses a unique coupling to the intentional radiator shall be considered sufficient to comply with the provisions of this section. The manufacturer may design the unit so that a broken antenna can be replaced by the user, but the use of a standard antenna jack or electrical connector is prohibited. This requirement does not apply to carrier current devices or to devices operated under the provisions of §15.211, §15.213, §15.217, §15.219, or §15.221. Further, this requirement does not apply to intentional radiators that must be professionally installed, such as perimeter protection systems and some field disturbance sensors, or to other intentional radiators which, in accordance with §15.31(d), must be measured at the installation site. However, the installer shall be responsible for ensuring that the proper antenna is employed so that the limits in this part are not exceeded.

5.1.2 Evaluation Criteria

(a) Antenna must be permanently attached to the unit.

(b) Antenna must use a unique type of connector to attach to the EUT.

Unit must be professionally installed, Installer shall be responsible for verifying that the correct antenna is employed with the unit.

5.1.3 Result: Compliance.

The EUT has one integral antenna arrangement, which was permanently attached and the antenna gain is 3.36 dBi, fulfill the requirement of this section.

5.2 AC Power Line Conducted Emission

5.2.1 Requirement

A radio apparatus that is designed to be connected to the public utility (AC) power line shall ensure that the radio frequency voltage, which is conducted back onto the AC power line on any frequency or frequencies within the and 150 kHz-30 MHz, shall not exceed the limits in the following table:

Frequency	Maximum RF Line Voltage	
	Q.P.(dBuV)	Average(dBuV)
150kHz-500kHz	66-56	56-46
500kHz-5MHz	56	46
5MHz-30MHz	60	50

****Note:** 1. the lower limit shall apply at the band edges.
2. The limit decreases linearly with the logarithm of the frequency in the range 0.15 MHz to 0.50 MHz

5.2.2 Block Diagram of Test Setup

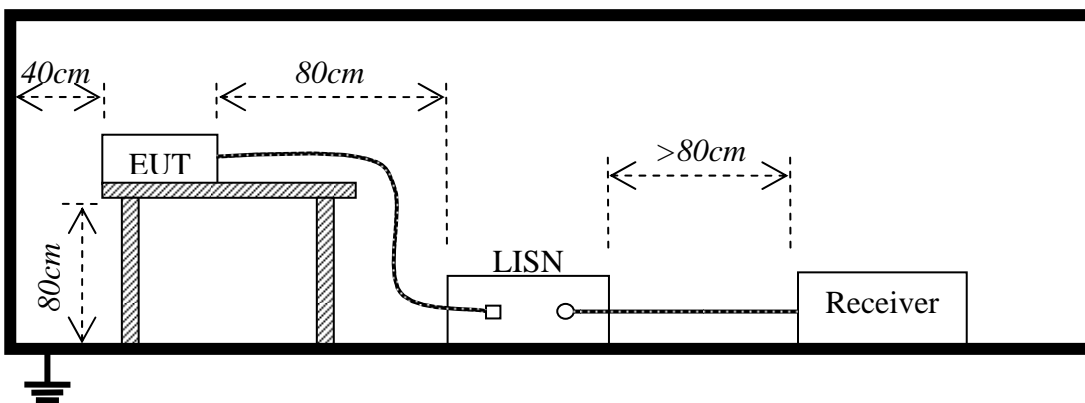

5.2.3 Test procedure

1. The E.U.T and simulators are connected to the main power through a line impedance stabilization network (L.I.S.N.). This provides a 50ohm/50uH coupling impedance for the measuring equipment.
2. Exploratory measurements were made to identify the frequency of the emission that has the highest amplitude relative to the limit;
3. The peripheral devices are also connected to the main power through a LISN that provides a 50ohm/50uH coupling impedance with 50ohm termination. (Please refer to the block diagram of the test setup and photographs).
4. Both sides of A.C. line are checked for maximum conducted interference. In order to find the maximum emission, the relative positions of equipment and all of the interface cables must be changed according to ANSI C63.10:2013 on conducted measurement.
5. The bandwidth of test receiver (ESCI) set at 9 KHz.
6. All data was recorded in the Quasi-peak and average detection mode.

5.2.4 Test Result

Pass

Note: All test modes are performed, only the worst case is recorded in this report.

Please refer the following pages.

EUT:	DamaiBox 3.0	M/N:	DB3026US
Mode:	802.11b-CH1	Phase:	L
Test by:	John	Power:	DC 12V by Adapter
Temperature: / Humidity	24.4°C / 50.8%	Test date:	2016-06-29

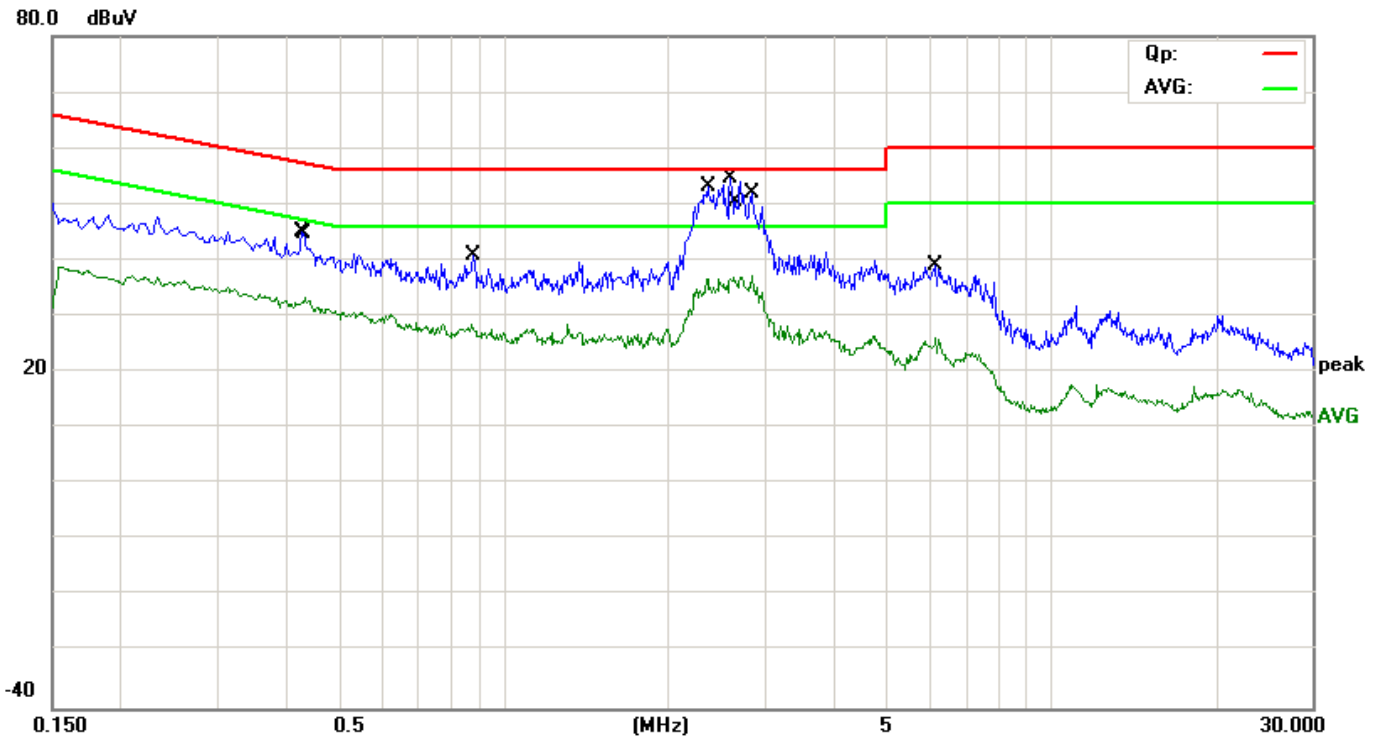

No.	Mk.	Freq. MHz	Reading Level dBuV	Correct Factor dB	Measure- ment dBuV	Limit dBuV	Over dB	Detector	Comment
1		0.4300	35.59	9.59	45.18	57.25	-12.07	QP	
2		0.4340	23.62	9.59	33.21	47.18	-13.97	AVG	
3		0.8780	18.86	9.60	28.46	46.00	-17.54	AVG	
4		0.8820	31.25	9.60	40.85	56.00	-15.15	QP	
5		2.3500	24.80	9.61	34.41	46.00	-11.59	AVG	
6		2.3620	36.30	9.61	45.91	56.00	-10.09	QP	
7		2.5980	38.20	9.61	47.81	56.00	-8.19	QP	
8		2.6380	26.70	9.61	36.31	46.00	-9.69	AVG	
9	*	2.8420	42.31	9.61	51.92	56.00	-4.08	QP	
10		2.8420	27.52	9.61	37.13	46.00	-8.87	AVG	
11		6.1460	29.44	9.64	39.08	60.00	-20.92	QP	
12		6.1860	16.45	9.64	26.09	50.00	-23.91	AVG	

*:Maximum data x:Over limit !:over margin

EUT:	DamaiBox 3.0	M/N:	DB3026US
Mode:	802.11b-CH1	Phase:	N
Test by:	John	Power:	DC 12V by Adapter
Temperature: / Humidity	24.4°C / 50.8%	Test date:	2016-06-29

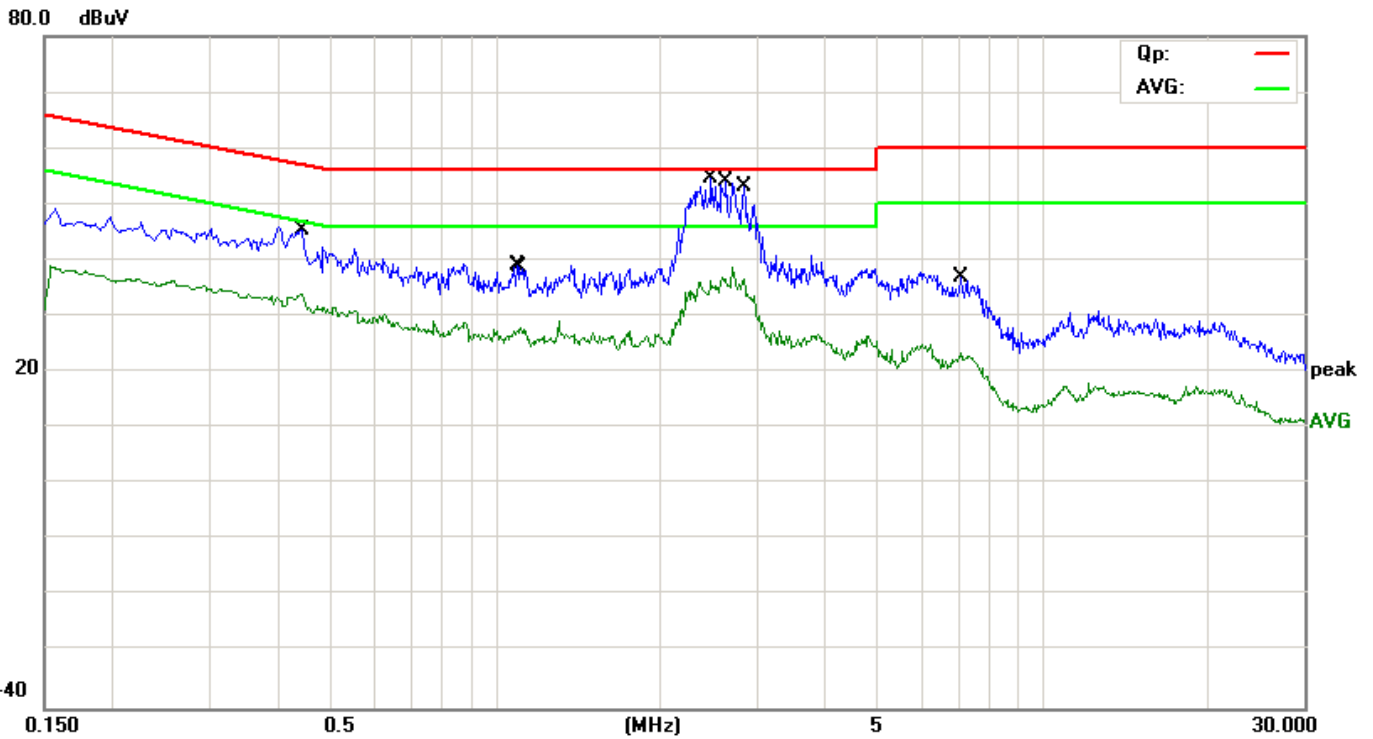

No.	Mk.	Freq. MHz	Reading Level dBuV	Correct Factor dB	Measure- ment dBuV	Limit dBuV	Over dB	Detector	Comment
1		0.4420	24.25	9.59	33.84	47.02	-13.18	AVG	
2		0.4460	35.85	9.59	45.44	56.95	-11.51	QP	
3		1.0980	29.39	9.60	38.99	56.00	-17.01	QP	
4		1.1140	18.42	9.60	28.02	46.00	-17.98	AVG	
5	*	2.4780	37.90	9.61	47.51	56.00	-8.49	QP	
6		2.4780	26.00	9.61	35.61	46.00	-10.39	AVG	
7		2.5980	26.90	9.61	36.51	46.00	-9.49	AVG	
8		2.6380	35.40	9.61	45.01	56.00	-10.99	QP	
9		2.8460	35.10	9.61	44.71	56.00	-11.29	QP	
10		2.8460	25.40	9.61	35.01	46.00	-10.99	AVG	
11		7.0980	27.32	9.65	36.97	60.00	-23.03	QP	
12		7.0980	13.70	9.65	23.35	50.00	-26.65	AVG	

*:Maximum data x:Over limit !:over margin

5.3 Radiated Emission

5.3.1 Requirement

According to FCC section 15.247(d), In addition, radiated emissions which fall in the restricted bands, as defined in §15.205(a), must also comply with the radiated emission limits specified in §15.209(a) (see §15.205(c)).

According to FCC section 15.209(a), Except as provided elsewhere in this subpart, the emissions from an intentional radiator shall not exceed the field strength levels specified in the following table:

Frequency (MHz)	Field Strength ($\mu\text{V}/\text{m}$ at 3-meter)	Test Distance (m)	Field Strength ($\text{dB}\mu\text{V}/\text{m}$ at 3-meter)
0.009 - 0.490	$2400/F(\text{kHz})$	300	
0.490 - 1.705	$24000/F(\text{kHz})$	30	
1.705-30	30	30	
30-88	100	3	40
88-216	150	3	43.5
216-960	200	3	46
Above 960	500	3	54

Note:

1. For Above 1000MHz, the emission limit in this paragraph is based on measurement instrumentation employing an average detector, measurement using instrumentation with a peak detector function, corresponding to 20dB above the maximum permitted average limit.

2. For above 1000MHz, limit field strength of harmonics: 54dBuV/m@3m (AV) and 74dBuV/m@3m (PK)

In addition, radiated emissions which fall in the restricted bands, as defined in §15.205(a), must also comply with the radiated emission limits specified in §15.209(a) (see §15.205(c)).

5.3.2 Test Configuration

Test Setup:

1) For radiated emissions from 9kHz to 30MHz

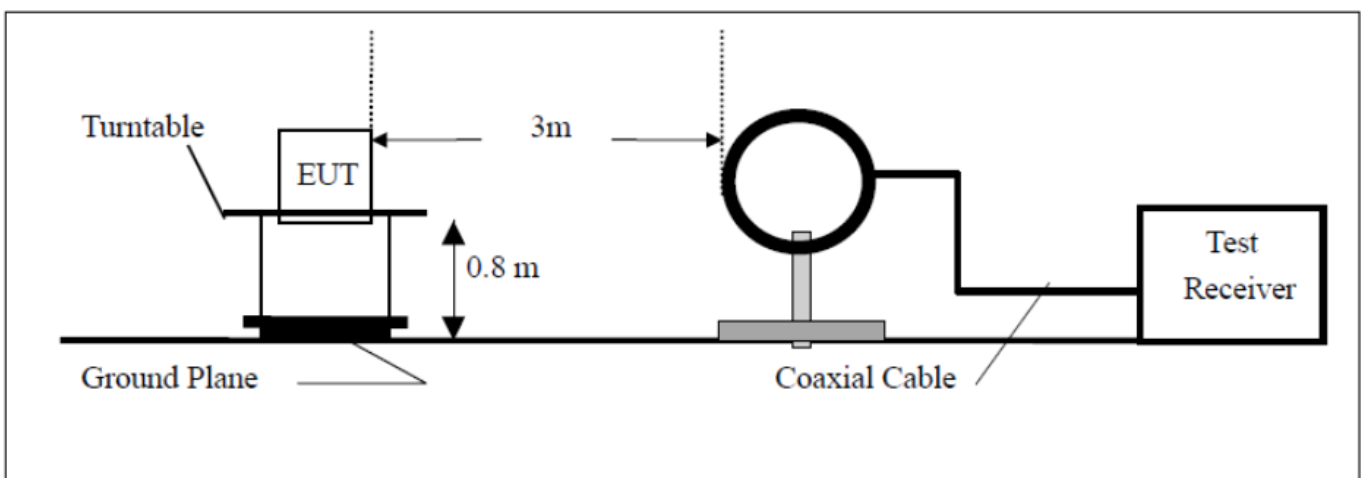

2) For radiated emissions from 30MHz to 1GHz

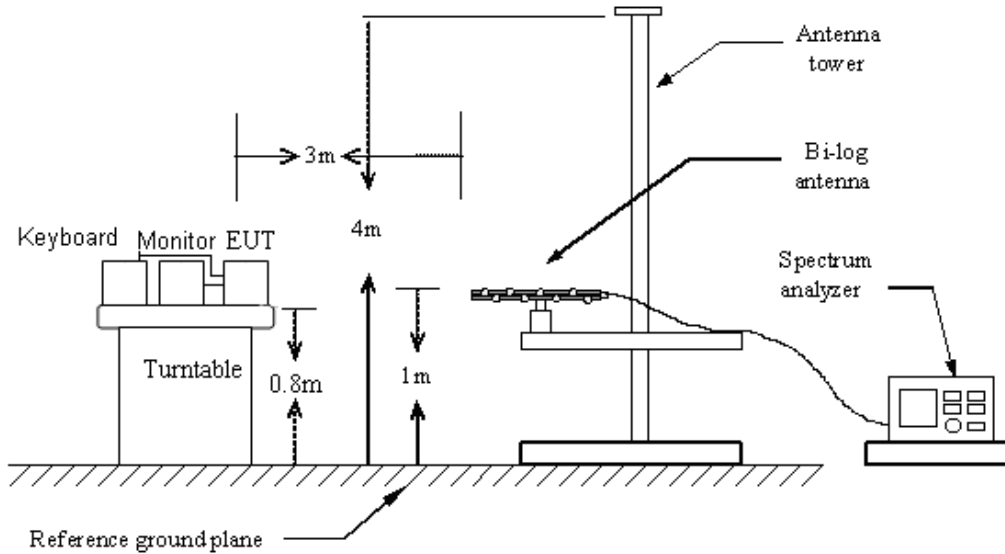

3) For radiated emissions above 1GHz

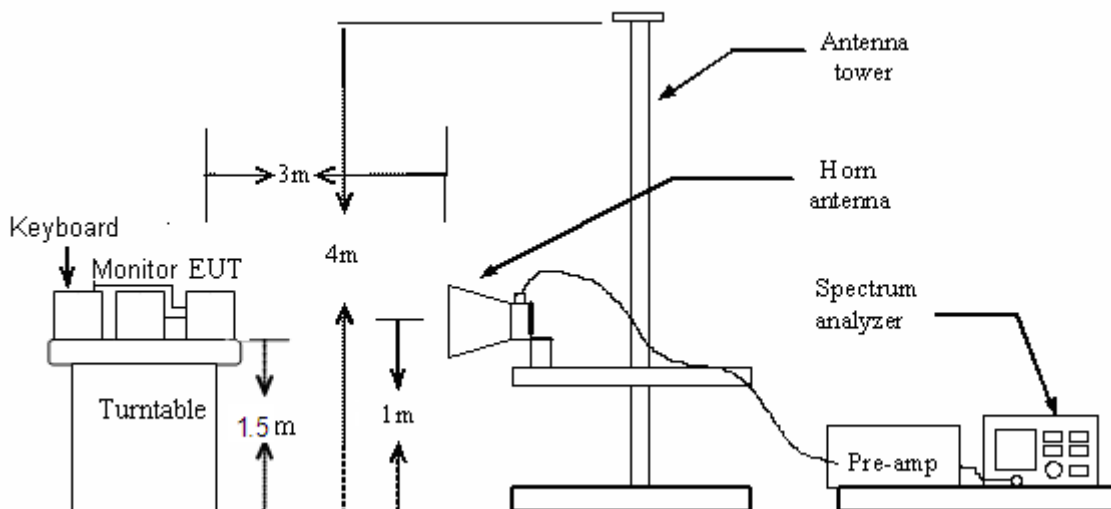
**5.3.3 Test Procedure:**

1. For frequencies above 1GHz, the frequencies of maximum emission was recorded by manually positioning the antenna close to the EUT and by moving the antenna over all sides of the EUT while observing a spectral display.
2. The EUT was placed on the top of a rotating table 1.5 meters above the ground at a 3 meter chamber. The table was rotated 360 degrees to determine the position of the highest radiation.
3. The EUT was set 3 meters away from the interference-receiving antenna, which was mounted on the top of a variable-height antenna tower.
4. The antenna height is varied from one meter to four meters above the ground to determine the maximum value of the field strength. Both horizontal and vertical polarizations of the antenna are set to make the measurement.
5. For each suspected emission, the EUT was arranged to its worst case and then the antenna was tuned to heights from 1 meter to 4 meters and the rote table was turned from 0 degrees to 360 degrees to find the maximum reading.

6. For frequencies above 1GHz, horn antenna mouth should face to the EUT all the time when rise or fall.
7. Set the spectrum analyzer in the following setting as:

Below 1GHz: PEAK: RBW=100 kHz / VBW=300 kHz / Sweep=AUTO QP: RBW=120 kHz / Sweep=AUTO

Above 1GHz: (a)PEAK: RBW=VBW=1MHz / Sweep=AUTO

(b)AVERAGE: RBW=1MHz / VBW=10Hz / Sweep=AUTO

The test-receiver system was set to Peak Detect Function and Specified Bandwidth with Maximum Hold Mode.

8. If the emission level of the EUT in peak mode was 10dB lower than the limit specified, then testing could be stopped and the peak values of the EUT would be reported. Otherwise the emissions that did not have 10dB margin would be re-tested one by one using peak, quasi-peak or average method as specified and then reported in a data sheet.

5.3.4 Test Result

Pass

Remark:

1. During the test, pre-scan the 802.11b, 802.11g, 802.11n(20M), 802.11n(40M) modulation, and found the 802.11b modulation Low channel is worse case in above 1GHz and below 1GHz.
2. Pre-scan all kind of the place mode (X-axis, Y-axis, Z-axis), and found the Y-axis which it is worse case.

Note: All test modes are performed, only the worst case is recorded in this report

Please refer the following pages.

**Below 1GHz
Antenna A:**

EUT:	DamaiBox 3.0	M/N:	DB3026US
Mode:	802.11b-CH1	Polarization:	Vertical
Test by:	John	Power:	DC 12V by Adapter
Temperature: / Humidity	23.9°C / 51.1%	Test date:	2016-07-08

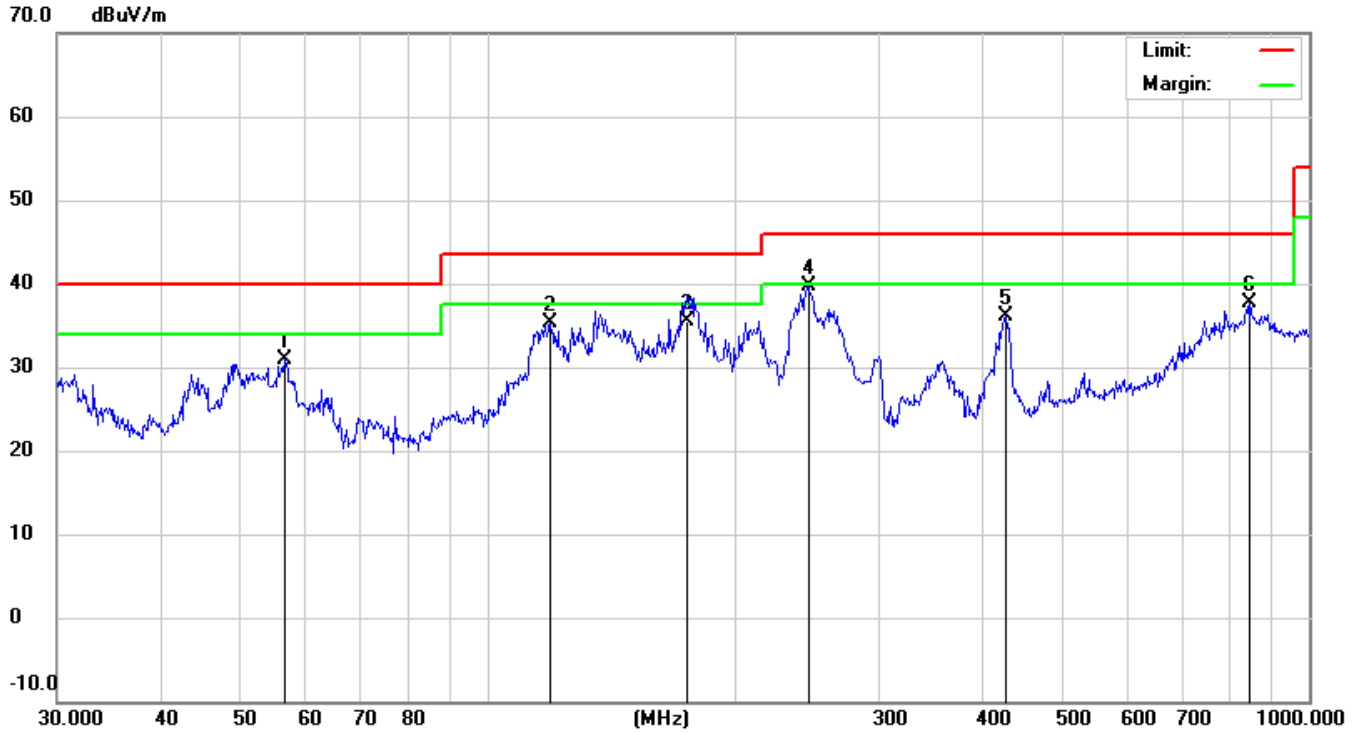

No.	Mk.	Freq. MHz	Reading Level dBuV	Correct Factor dB	Measure- ment dBuV/m	Limit dBuV/m	Over dB	Detector	Antenna Height cm	Table Degree degree	Comment
1		56.7917	20.24	10.64	30.88	40.00	-9.12	QP			
2		119.4360	17.80	17.42	35.22	43.50	-8.28	QP			
3		175.0365	18.60	16.95	35.55	43.50	-7.95	QP			
4	*	245.9509	22.42	17.32	39.74	46.00	-6.26	QP			
5		428.0192	15.81	20.24	36.05	46.00	-9.95	QP			
6		848.0563	10.59	27.10	37.69	46.00	-8.31	QP			

*:Maximum data x:Over limit !:over margin

EUT:	DamaiBox 3.0	M/N:	DB3026US
Mode:	802.11b-CH1	Polarization:	Horizontal
Test by:	John	Power:	DC 12V by Adapter
Temperature: / Humidity	23.9°C / 51.1%	Test date:	2016-07-08

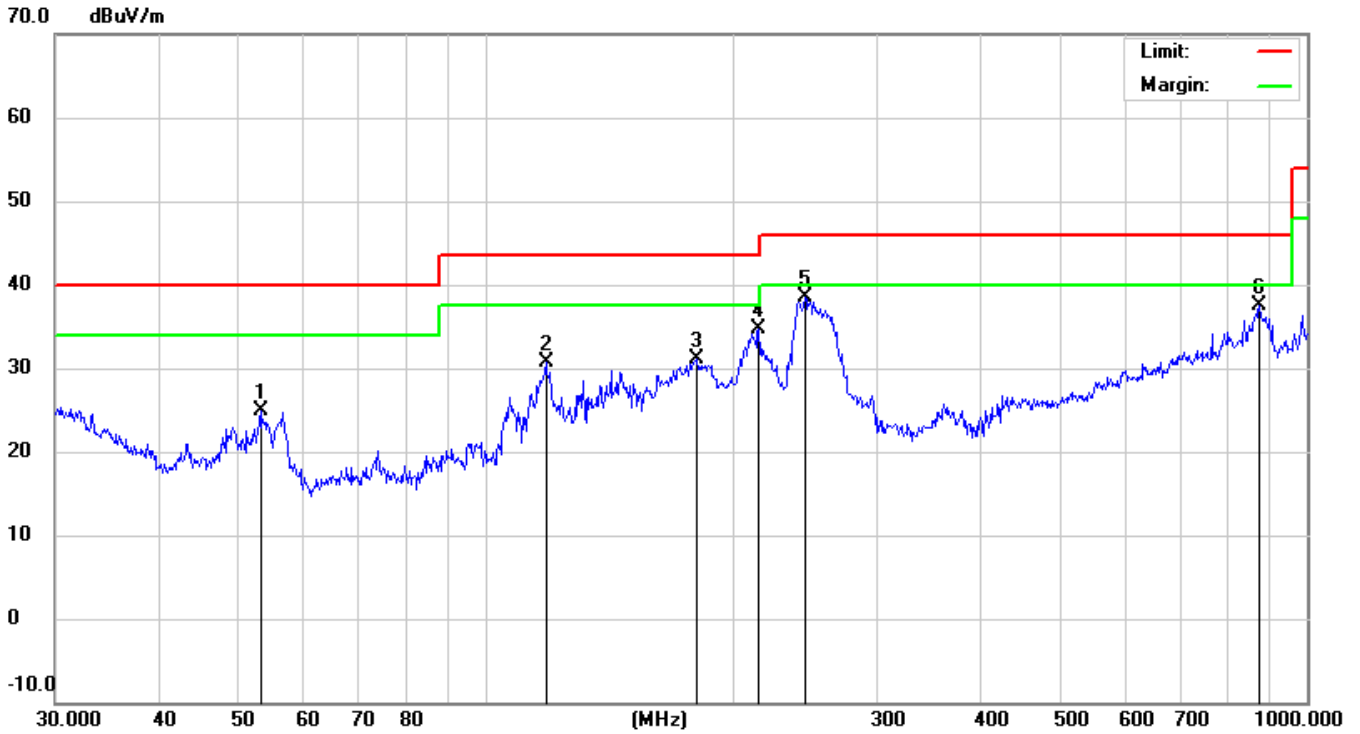

No.	Mk.	Freq. MHz	Reading Level dBuV	Correct Factor dB	Measure- ment dBuV/m	Limit dBuV/m	Over dB	Antenna Height cm	Table Degree	Detector	Comment
1		53.3179	14.47	10.46	24.93	40.00	-15.07			QP	
2		118.6013	13.37	17.30	30.67	43.50	-12.83			QP	
3		180.6488	14.39	16.69	31.08	43.50	-12.42			QP	
4		215.2678	18.51	16.12	34.63	43.50	-8.87			QP	
5	*	245.0900	21.17	17.30	38.47	46.00	-7.53			QP	
6		875.2469	10.40	27.05	37.45	46.00	-8.55			QP	

*:Maximum data x:Over limit !:over margin

Antenna B:

EUT:	DamaiBox 3.0	M/N:	DB3026US
Mode:	802.11b-CH1	Polarization:	Vertical
Test by:	John	Power:	DC 12V by Adapter
Temperature: / Humidity	23.9°C / 51.1%	Test date:	2016-07-08

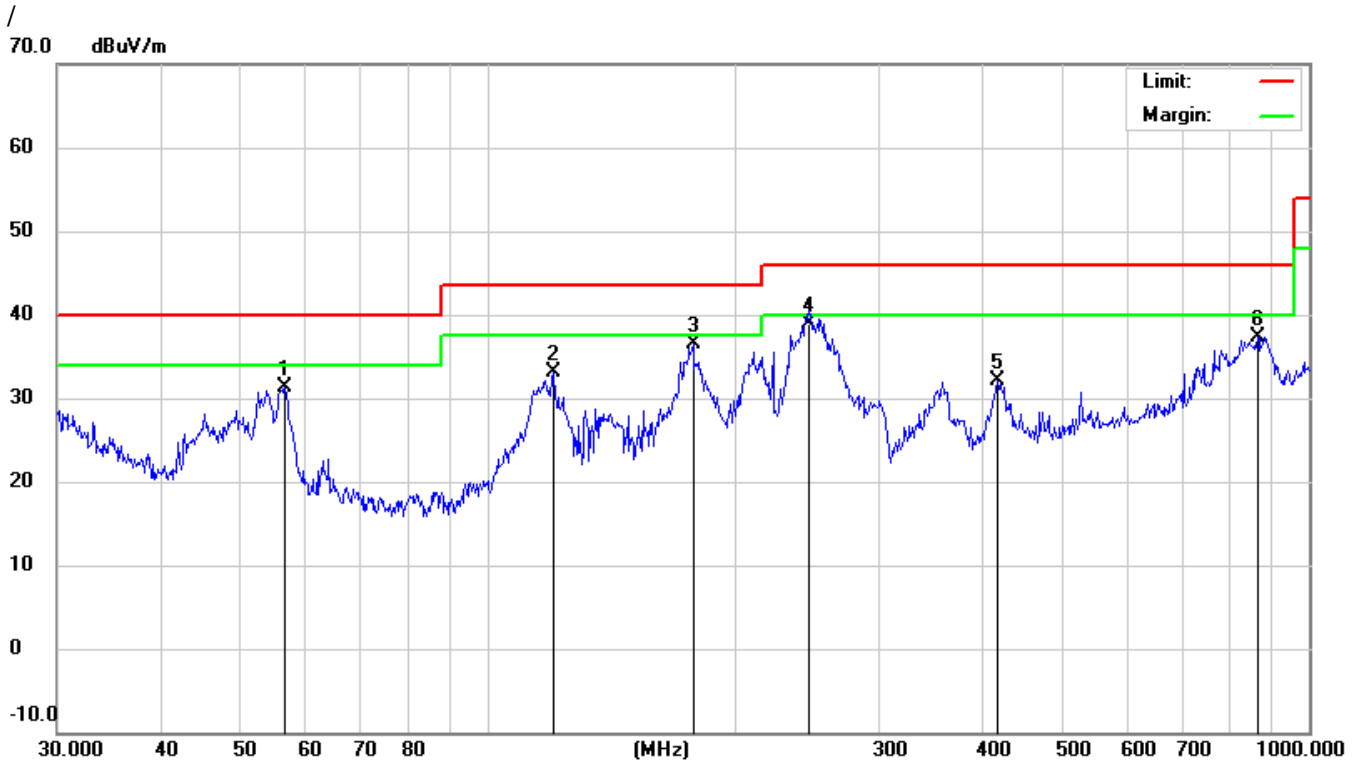

No.	Mk.	Freq. MHz	Reading Level dBuV	Correct Factor dB	Measure- ment dBuV/m	Limit dBuV/m	Over dB	Antenna Height cm	Table Degree	Detector	Comment
1		56.7917	20.67	10.64	31.31	40.00	-8.69			QP	
2		120.2766	15.62	17.51	33.13	43.50	-10.37			QP	
3	*	178.1325	19.73	16.79	36.52	43.50	-6.98			QP	
4		245.9509	21.50	17.32	38.82	46.00	-7.18			QP	
5		417.6409	12.23	19.79	32.02	46.00	-13.98			QP	
6		866.0878	10.32	27.00	37.32	46.00	-8.68			QP	

*:Maximum data x:Over limit !:over margin

EUT:	DamaiBox 3.0	M/N:	DB3026US
Mode:	802.11b-CH1	Polarization:	Horizontal
Test by:	John	Power:	DC 12V by Adapter
Temperature: / Humidity	23.9°C / 51.1%	Test date:	2016-07-08

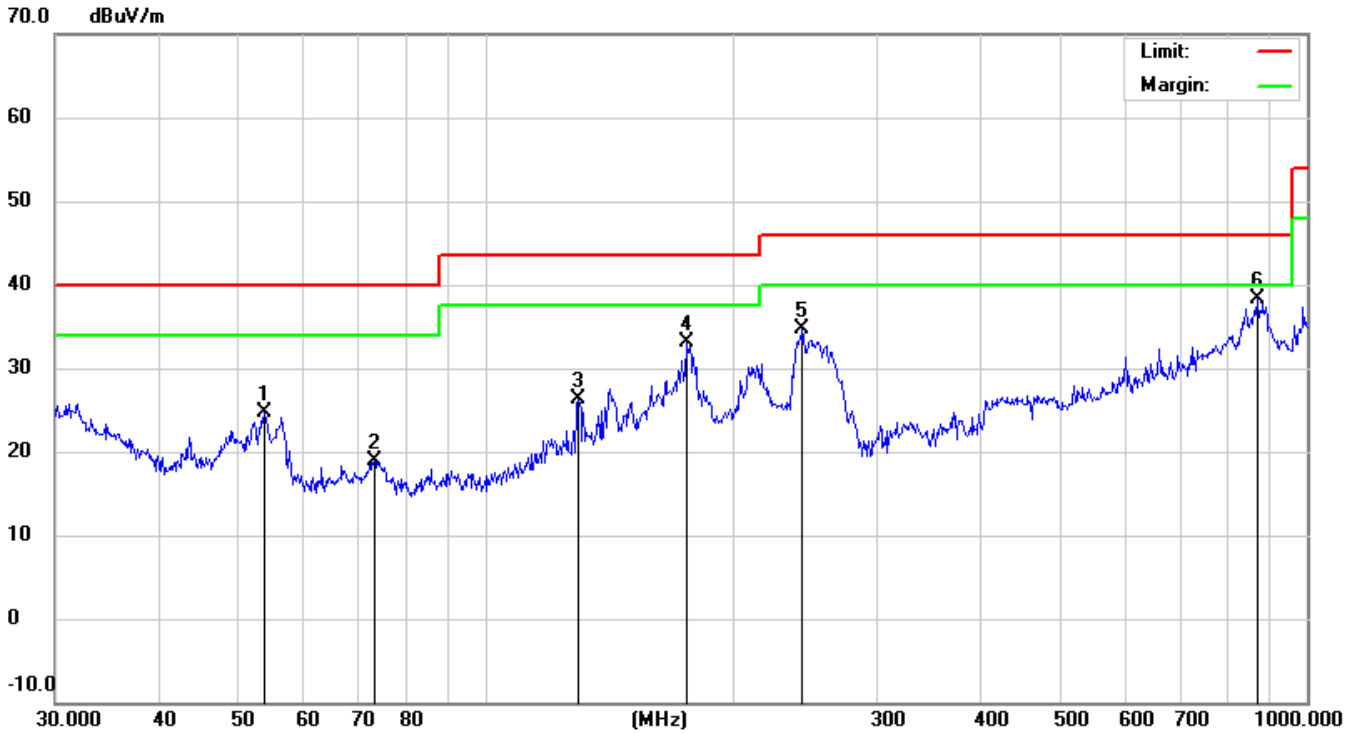

No.	Mk.	Freq. MHz	Reading Level dBuV	Correct Factor dB	Measure- ment dBuV/m	Limit dBuV/m	Over dB	Antenna Height cm	Table Degree	Comment
1		53.8817	14.22	10.50	24.72	40.00	-15.28	QP		
2		73.3593	7.31	11.60	18.91	40.00	-21.09	QP		
3		129.9225	8.65	17.70	26.35	43.50	-17.15	QP		
4		176.2686	16.14	16.89	33.03	43.50	-10.47	QP		
5		243.3771	17.36	17.27	34.63	46.00	-11.37	QP		
6	*	869.1302	11.27	27.00	38.27	46.00	-7.73	QP		

*:Maximum data x:Over limit !:over margin

**Above 1GHz
Antenna A:**

EUT:	DamaiBox 3.0	M/N:	DB3026US
Mode:	802.11b-CH1	Polarization:	Horizontal
Test by:	John	Power:	DC 12V by Adapter
Temperature: / Humidity	23.7°C / 51.6%	Test date:	2016-07-13

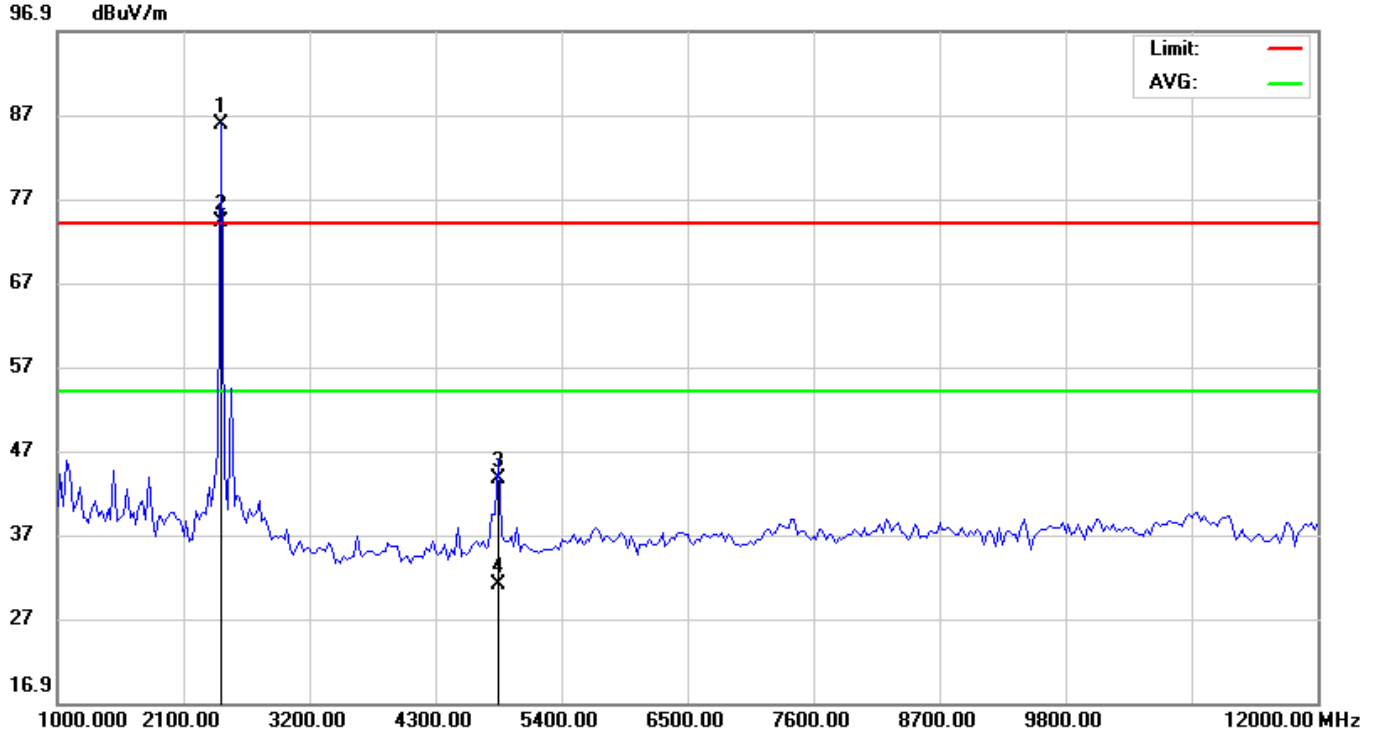

No.	Mk.	Freq. MHz	Reading Level dBuV	Correct Factor dB	Measure- ment dBuV/m	Limit dBuV/m	Over dB	Detector	Antenna Height cm	Table Degree degree	Comment
1	X	2412.000	94.30	-8.41	85.89	74.00	11.89	peak			
2	*	2412.000	82.70	-8.41	74.29	54.00	20.29	AVG			
3		4824.000	49.60	-5.91	43.69	74.00	-30.31	peak			
4		4824.000	36.90	-5.91	30.99	54.00	-23.01	AVG			

*:Maximum data x:Over limit !:over margin

EUT:	DamaiBox 3.0	M/N:	DB3026US
Mode:	802.11b-CH1	Polarization:	Horizontal
Test by:	John	Power:	DC 12V by Adapter
Temperature: / Humidity	23.7°C / 51.6%	Test date:	2016-07-13

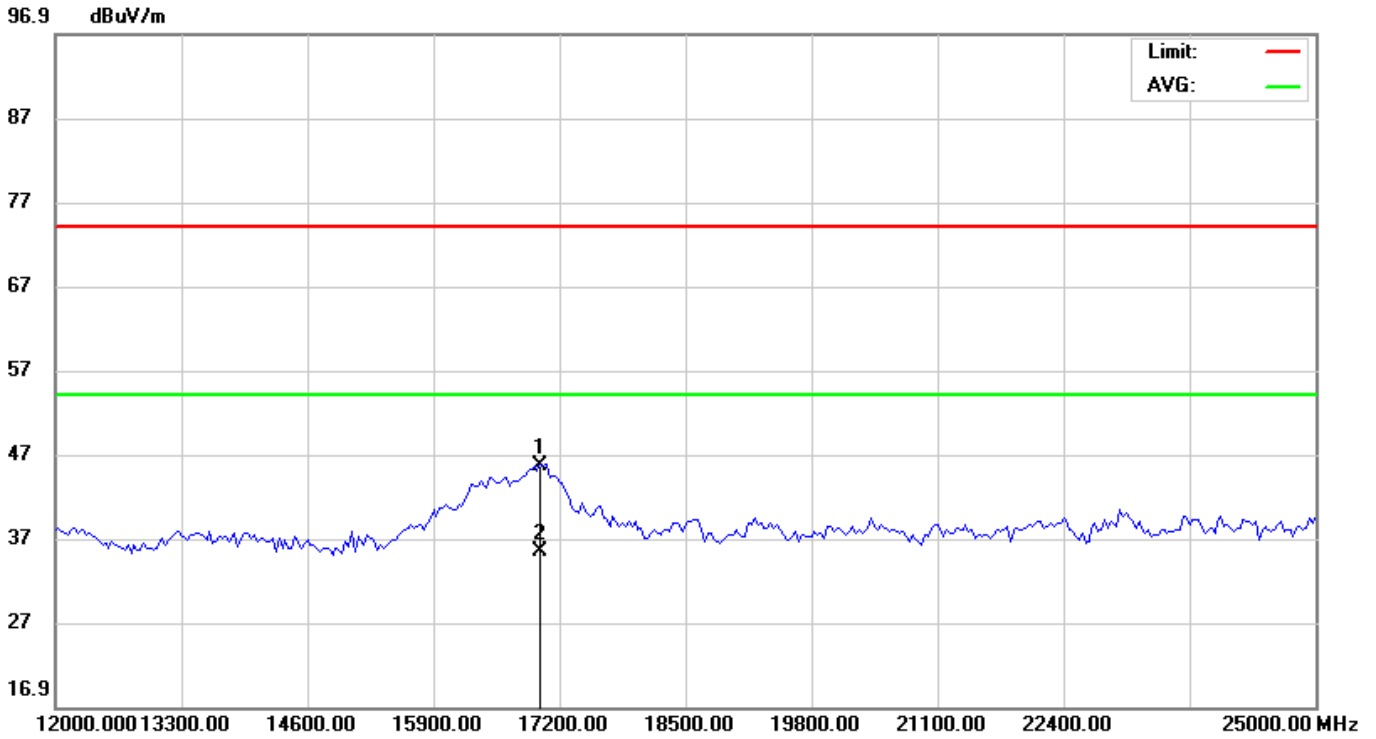

No.	Mk.	Freq. MHz	Reading Level dBuV	Correct Factor dB	Measure- ment dBuV/m	Limit dBuV/m	Over dB	Detector	Antenna Height cm	Table Degree degree	Comment
1		17005.00	38.70	6.90	45.60	74.00	-28.40	peak			
2	*	17005.00	28.60	6.90	35.50	54.00	-18.50	AVG			

*:Maximum data x:Over limit !:over margin

EUT:	DamaiBox 3.0	M/N:	DB3026US
Mode:	802.11b-CH1	Polarization:	Vertical
Test by:	John	Power:	DC 12V by Adapter
Temperature: / Humidity	23.7°C / 51.6%	Test date:	2016-07-13

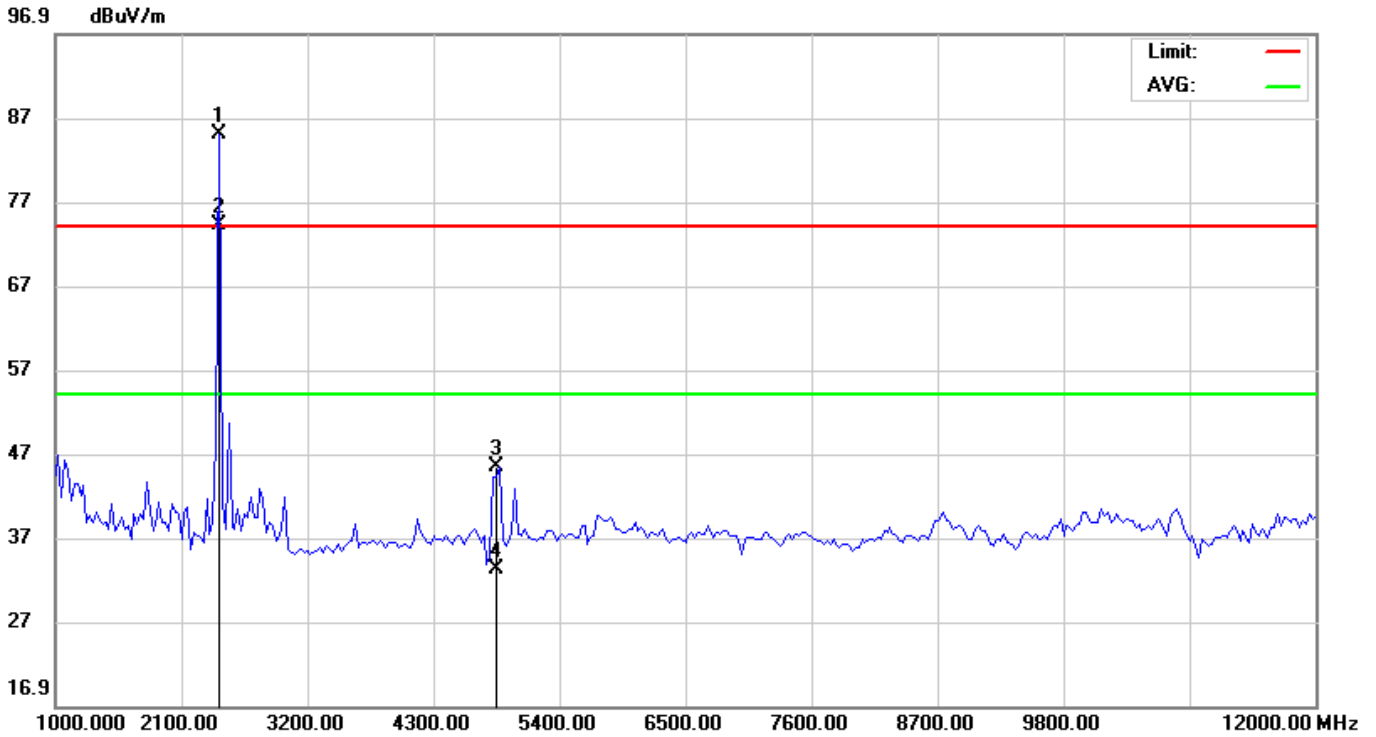

No.	Mk.	Freq. MHz	Reading Level dBuV	Correct Factor dB	Measure- ment dBuV/m	Limit dBuV/m	Over dB	Detector	Antenna Height cm	Table Degree degree	Comment
1	X	2412.100	93.40	-8.41	84.99	74.00	10.99	peak			
2	*	2412.100	82.70	-8.41	74.29	54.00	20.29	AVG			
3		4824.000	51.30	-5.91	45.39	74.00	-28.61	peak			
4		4824.000	39.20	-5.91	33.29	54.00	-20.71	AVG			

*:Maximum data x:Over limit !:over margin

EUT:	DamaiBox 3.0	M/N:	DB3026US
Mode:	802.11b-CH1	Polarization:	Vertical
Test by:	John	Power:	DC 12V by Adapter
Temperature: / Humidity	23.7°C / 51.6%	Test date:	2016-07-13

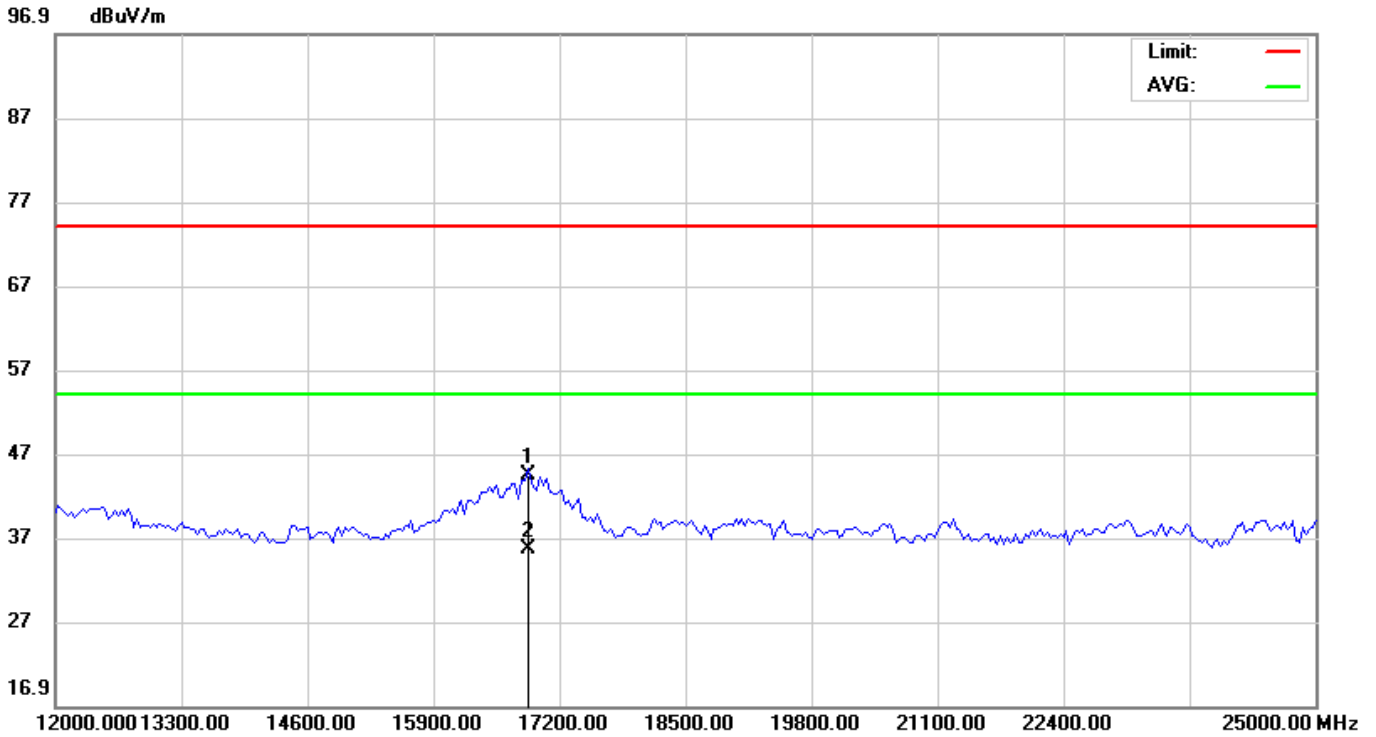

No.	Mk.	Freq.	Reading Level	Correct Factor	Measurement	Limit	Over	Antenna Height	Table Degree	
		MHz	dBuV	dB	dBuV/m	dBuV/m	dB	cm	degree	Comment
1		16875.00	37.90	6.51	44.41	74.00	-29.59			peak
2	*	16875.00	29.10	6.51	35.61	54.00	-18.39			AVG

*:Maximum data x:Over limit !:over margin

Antenna B:

EUT:	DamaiBox 3.0	M/N:	DB3026US
Mode:	802.11b-CH1	Polarization:	Horizontal
Test by:	John	Power:	DC 12V by Adapter
Temperature: / Humidity	23.7°C / 51.6%	Test date:	2016-07-14

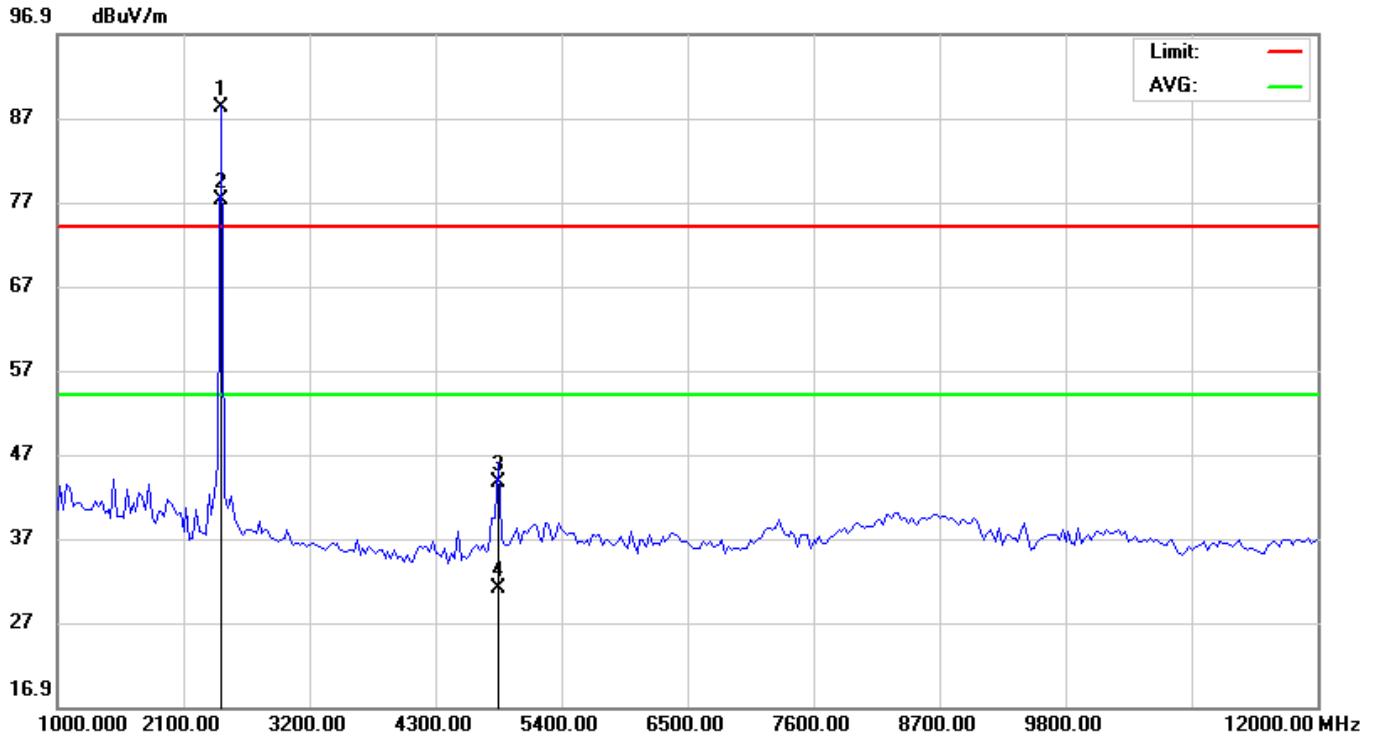

No.	Mk.	Freq. MHz	Reading Level dBuV	Correct Factor dB	Measure- ment dBuV/m	Limit dBuV/m	Over dB	Detector	Antenna Height cm	Table Degree degree	Comment
1	X	2412.000	96.70	-8.41	88.29	74.00	14.29	peak			
2	*	2412.000	85.60	-8.41	77.19	54.00	23.19	AVG			
3		4824.000	49.50	-5.91	43.59	74.00	-30.41	peak			
4		4824.000	36.90	-5.91	30.99	54.00	-23.01	AVG			

*:Maximum data x:Over limit !:over margin

EUT:	DamaiBox 3.0	M/N:	DB3026US
Mode:	802.11b-CH1	Polarization:	Horizontal
Test by:	John	Power:	DC 12V by Adapter
Temperature: / Humidity	23.7°C / 51.6%	Test date:	2016-07-14

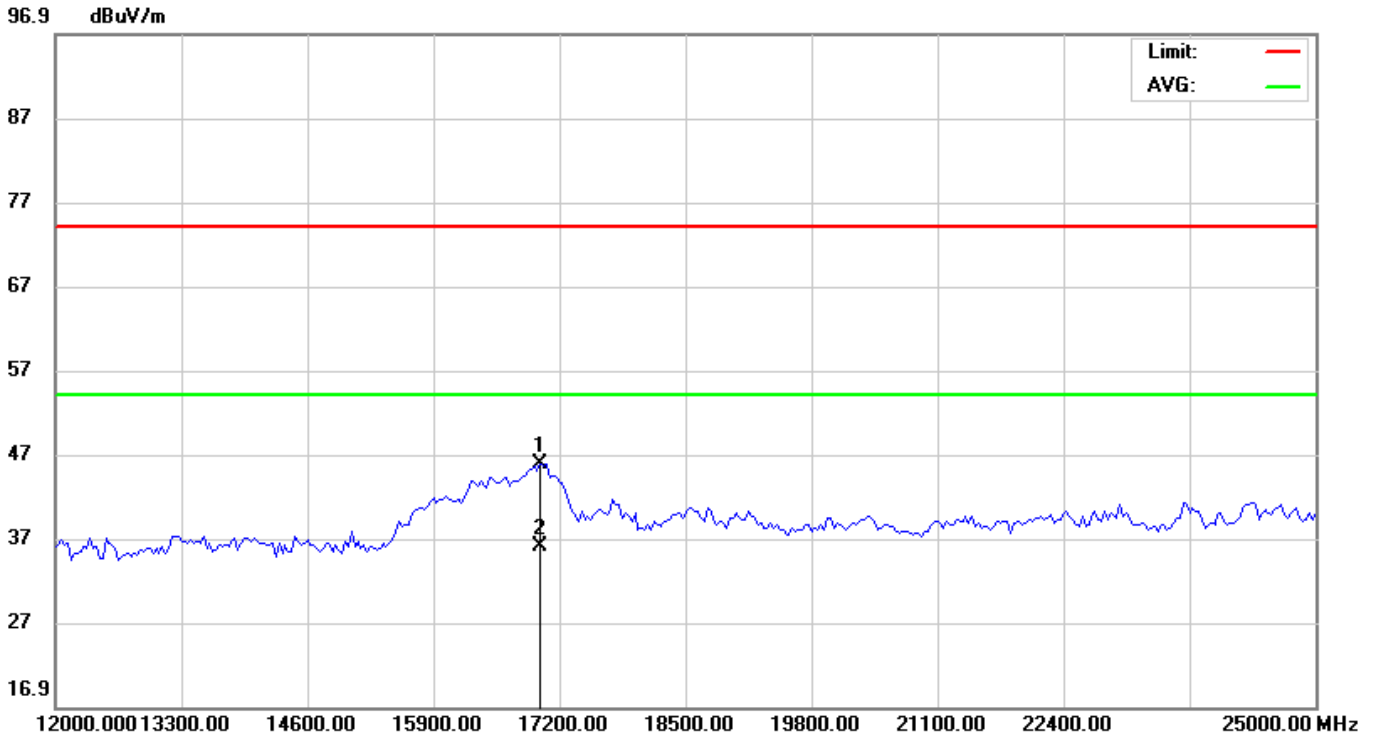

No.	Mk.	Freq.	Reading Level	Correct Factor	Measurement	Limit	Over	Antenna Height	Table Degree	
		MHz	dBuV	dB	dBuV/m	dBuV/m	dB	cm	degree	Comment
1		17005.00	38.90	6.90	45.80	74.00	-28.20			peak
2	*	17005.00	29.20	6.90	36.10	54.00	-17.90			AVG

*:Maximum data x:Over limit !:over margin

EUT:	DamaiBox 3.0	M/N:	DB3026US
Mode:	802.11b-CH1	Polarization:	Vertical
Test by:	John	Power:	DC 12V by Adapter
Temperature: / Humidity	23.7°C / 51.6%	Test date:	2016-07-14

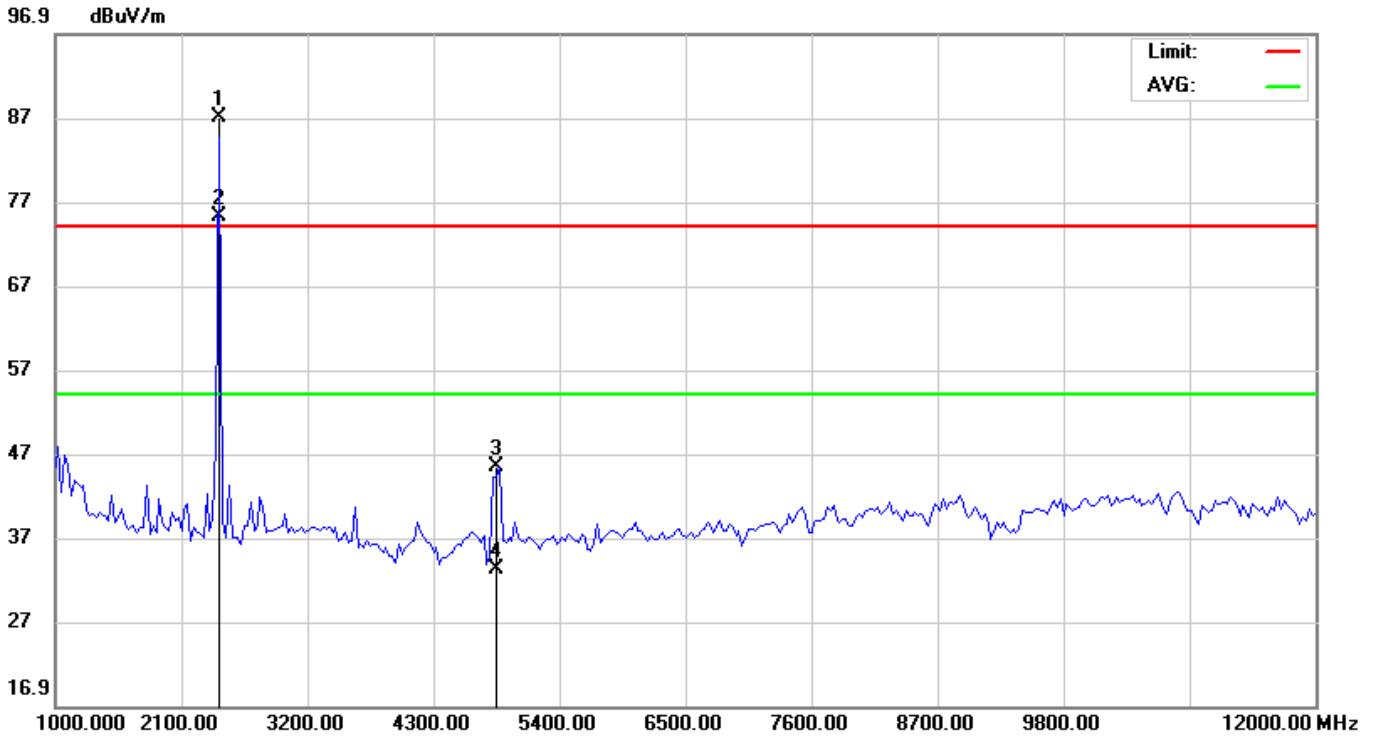

No.	Mk.	Freq. MHz	Reading Level dBuV	Correct Factor dB	Measure- ment dBuV/m	Limit dBuV/m	Over dB	Detector	Antenna Height cm	Table Degree degree	Comment
1	X	2412.100	95.40	-8.41	86.99	74.00	12.99	peak			
2	*	2412.100	83.60	-8.41	75.19	54.00	21.19	AVG			
3		4824.000	51.30	-5.91	45.39	74.00	-28.61	peak			
4		4824.000	39.20	-5.91	33.29	54.00	-20.71	AVG			

*:Maximum data x:Over limit !:over margin

EUT:	DamaiBox 3.0	M/N:	DB3026US
Mode:	802.11b-CH1	Polarization:	Vertical
Test by:	John	Power:	DC 12V by Adapter
Temperature: / Humidity	23.7°C / 51.6%	Test date:	2016-07-14

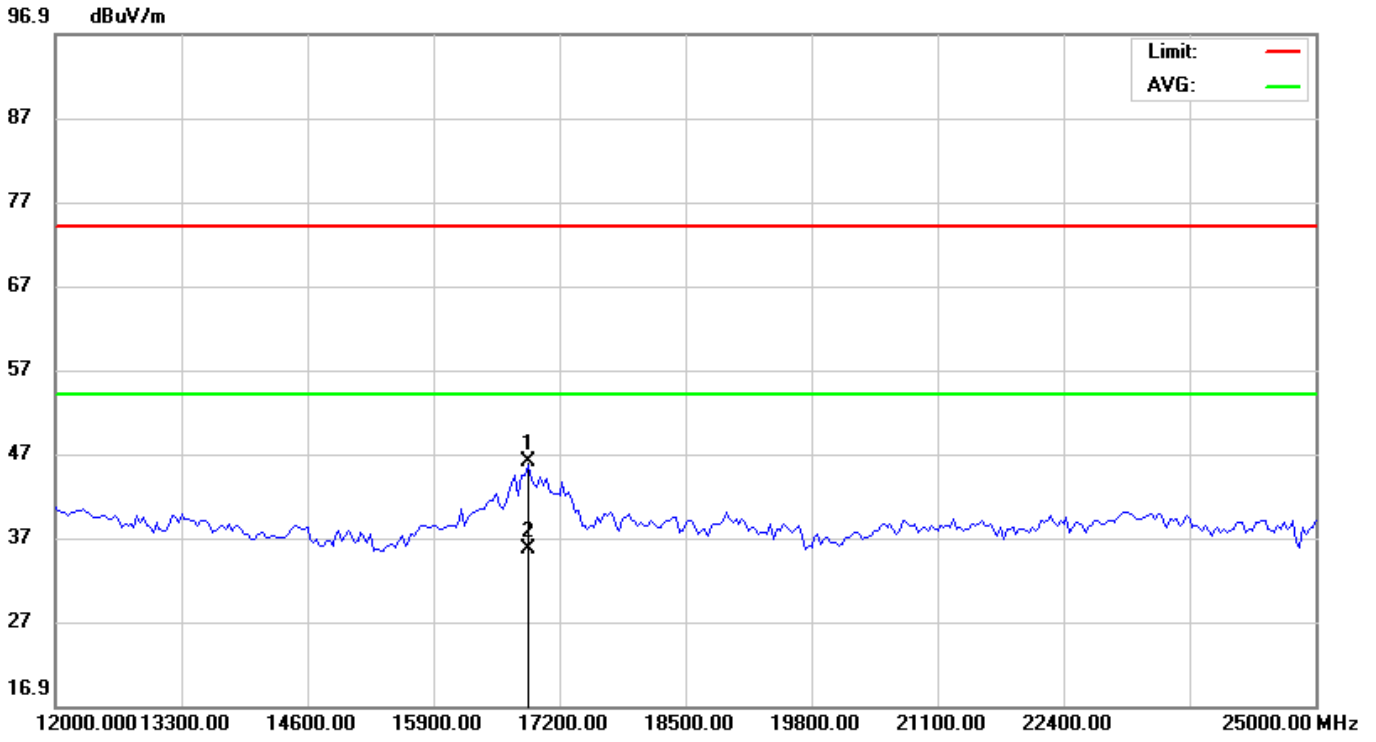

No.	Mk.	Freq.	Reading Level	Correct Factor	Measurement	Limit	Over	Antenna Height	Table Degree	
		MHz	dBuV	dB	dBuV/m	dBuV/m	dB	cm	degree	Comment
1		16875.00	39.50	6.51	46.01	74.00	-27.99			peak
2	*	16875.00	29.10	6.51	35.61	54.00	-18.39			AVG

*:Maximum data x:Over limit !:over margin

5.4 Conducted Peak Output Power

5.4.1 Requirement

According to FCC section 15.247(b)(3), for systems using digital modulation in the 902-928 MHz, 2400-2483.5 MHz, and 5725-5850 MHz bands: 1 Watt. As an alternative to a peak power measurement, compliance with the one Watt limit can be based on a measurement of the maximum conducted output power. Maximum Conducted Output Power is defined as the total transmit power delivered to all antennas and antenna elements averaged across all symbols in the signaling alphabet when the transmitter is operating at its maximum power control level. Power must be summed across all antennas and antenna elements. The average must not include any time intervals during which the transmitter is off or is transmitting at a reduced power level. If multiple modes of operation are possible (e.g., alternative modulation methods), the maximum conducted output power is the highest total transmit power occurring in any mode.

5.4.2 Block Diagram of Test Setup

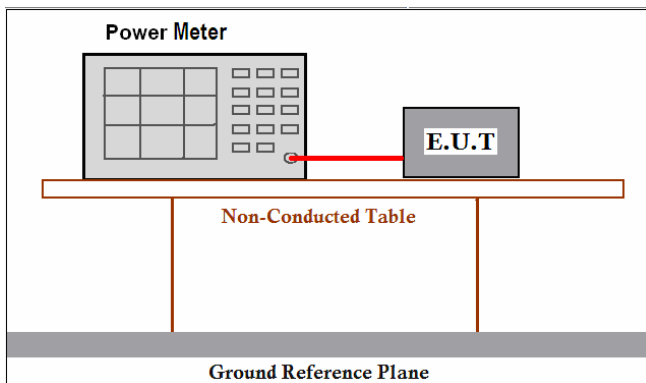

5.4.3 Test Procedure

1. Remove the antenna from the EUT and then connect a low attention attenuation RF cable (Cable loss =0.5dB) from the antenna port to the power meter.
2. Measurement using an RF peak power meter.
3. Report the worse case.

5.4.4 Test Result

Test Item:	Peak Output Power	Temperature :	20°C
Test Engineer:	John	Relative Humidity :	55%

Antenna A:

Mode	Channel	Frequency (MHz)	Peak Output Power(dBm)	Limit		Pass/Fail
				(mW)	(dBm)	
802.11b	Low	2412	10.59	1000	30	Pass
	Middle	2437	11.04	1000	30	Pass
	High	2462	11.32	1000	30	Pass
802.11g	Low	2412	9.56	1000	30	Pass
	Middle	2437	9.14	1000	30	Pass
	High	2462	8.87	1000	30	Pass
802.11n (20MHz)	Low	2412	8.88	1000	30	Pass
	Middle	2437	8.76	1000	30	Pass
	High	2462	8.39	1000	30	Pass
802.11n (40MHz)	Low	2422	10.35	1000	30	Pass
	Middle	2437	10.34	1000	30	Pass
	High	2452	10.29	1000	30	Pass

Antenna B:

Mode	Channel	Frequency (MHz)	Peak Output Power(dBm)	Limit		Pass/Fail
				(mW)	(dBm)	
802.11b	Low	2412	10.52	1000	30	Pass
	Middle	2437	11.29	1000	30	Pass
	High	2462	11.74	1000	30	Pass
802.11g	Low	2412	9.09	1000	30	Pass
	Middle	2437	9.67	1000	30	Pass
	High	2462	9.85	1000	30	Pass
802.11n (20MHz)	Low	2412	9.82	1000	30	Pass
	Middle	2437	9.15	1000	30	Pass
	High	2462	9.38	1000	30	Pass
802.11n (40MHz)	Low	2422	10.83	1000	30	Pass
	Middle	2437	10.87	1000	30	Pass
	High	2452	11.59	1000	30	Pass

5.5 6dB Emission Bandwidth

5.5.1 Test Requirement

Systems using digital modulation techniques may operate in the 902–928 MHz, 2400–2483.5 MHz, and 5725–5850 MHz bands. The minimum 6 dB bandwidth shall be at least 500 kHz.

5.5.2 Block Diagram of Test Setup



5.5.3 Test Procedure

According to KDB 558074 D01 DTS Meas Guidance v03r02 clause8.1 Option 1:

- a) Set RBW = 100 kHz.
- b) Set the video bandwidth (VBW) $\geq 3 \times \text{RBW}$.
- c) Detector = Peak.
- d) Trace mode = max hold.
- e) Sweep = auto couple.
- f) Allow the trace to stabilize.
- g) Measure the maximum width of the emission that is constrained by the frequencies associated with the two outermost amplitude points (upper and lower frequencies) that are attenuated by 6 dB relative to the maximum level measured in the fundamental emission.

5.5.4 Test Result

Pass

Test Item:	6dB Emission Bandwidth	Temperature :	23°C
Test Engineer:	John	Relative Humidity :	55%

Antenna A:

Mode	Channel	Frequency (MHz)	6dB Bandwidth(MHz)	Limit(KHz)
802.11b	Low	2412	9.077	≥500
	Middle	2437	9.061	≥500
	High	2462	9.052	≥500
802.11g	Low	2412	16.398	≥500
	Middle	2437	16.404	≥500
	High	2462	16.361	≥500
802.11n (20MHz)	Low	2412	17.588	≥500
	Middle	2437	17.630	≥500
	High	2462	17.597	≥500
802.11n (40MHz)	Low	2422	36.048	≥500
	Middle	2437	35.862	≥500
	High	2452	35.994	≥500

Antenna B:

Mode	Channel	Frequency (MHz)	6dB Bandwidth(MHz)	Limit(KHz)
802.11b	Low	2412	9.110	≥500
	Middle	2437	9.076	≥500
	High	2462	9.090	≥500
802.11g	Low	2412	16.374	≥500
	Middle	2437	16.414	≥500
	High	2462	16.371	≥500
802.11n (20MHz)	Low	2412	17.609	≥500
	Middle	2437	17.666	≥500
	High	2462	17.604	≥500
802.11n (40MHz)	Low	2422	35.751	≥500
	Middle	2437	35.623	≥500
	High	2452	35.763	≥500

Antenna A:

802.11 b Mode

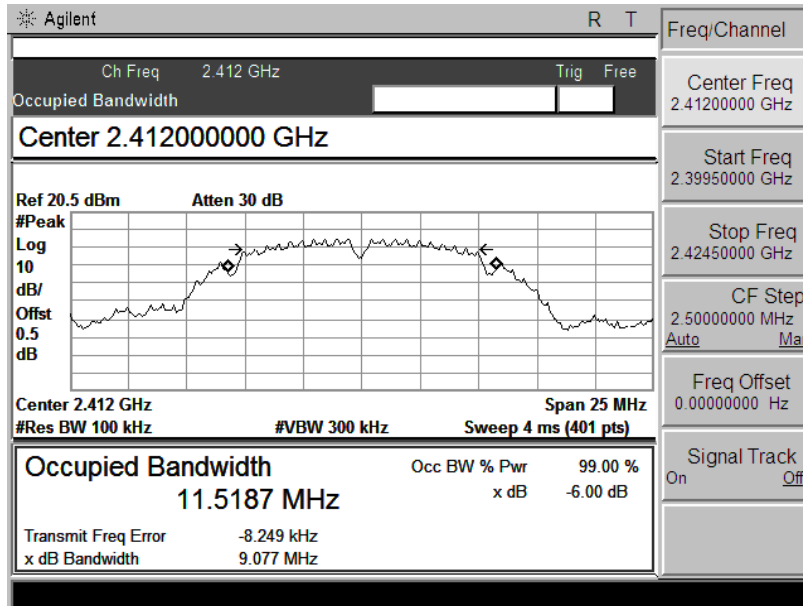

Ch 1

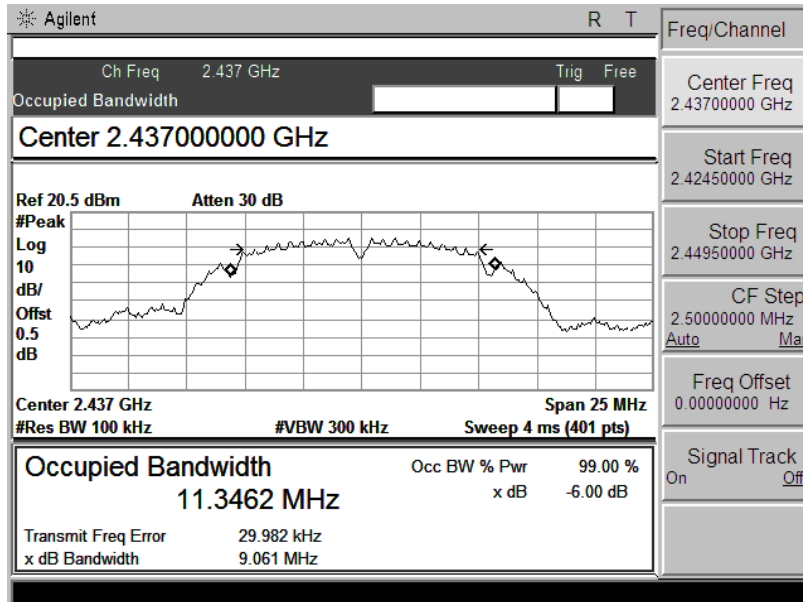

Ch 6

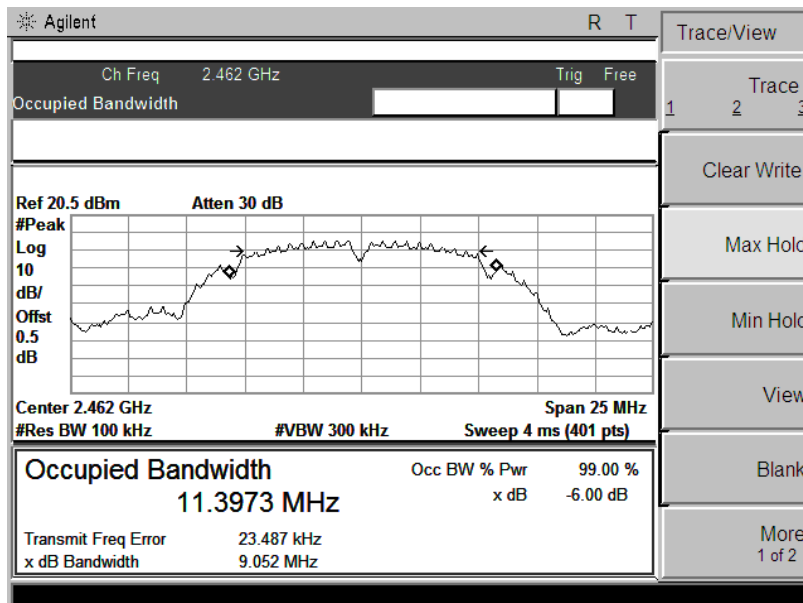

Ch 11

802.11 g Mode

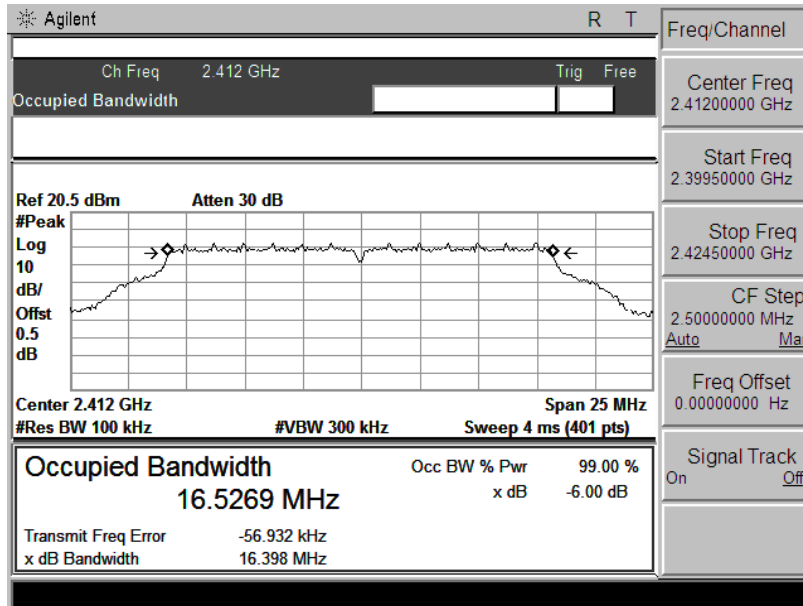

Ch 1

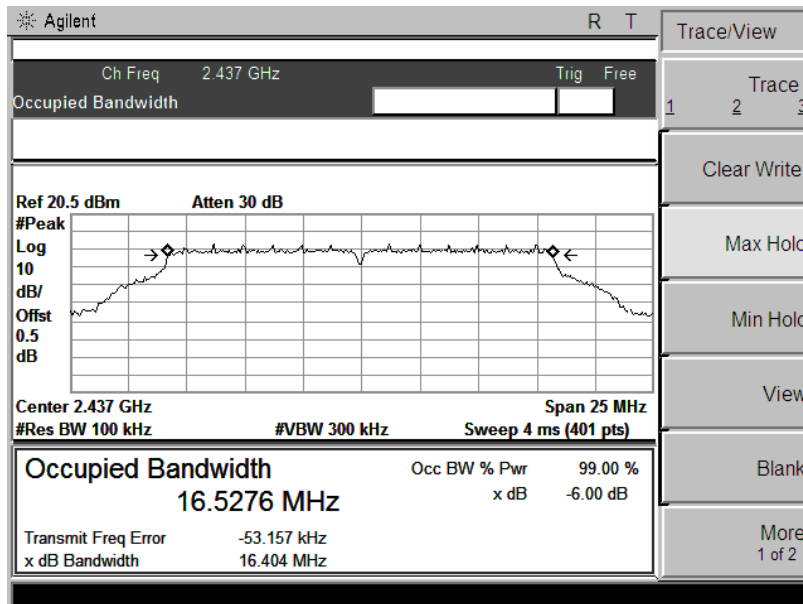

Ch 6

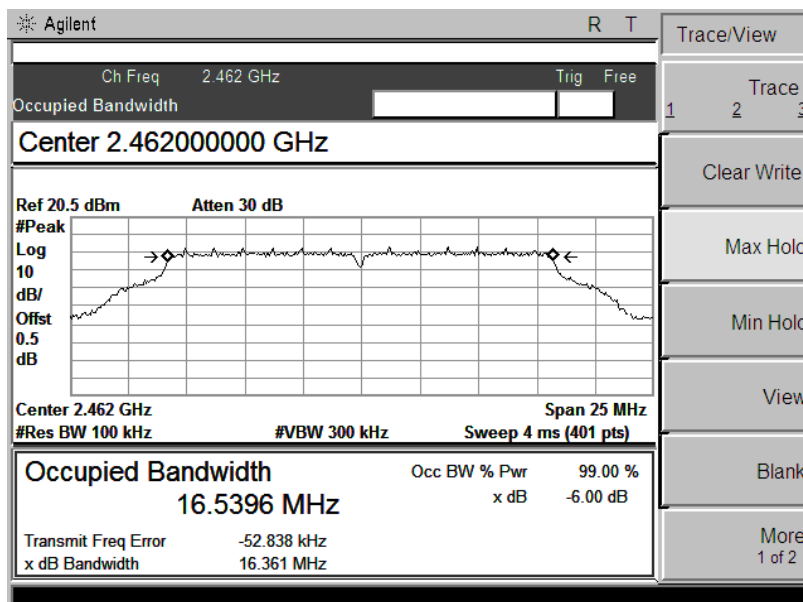

Ch 11

802.11 n(20M) Mode

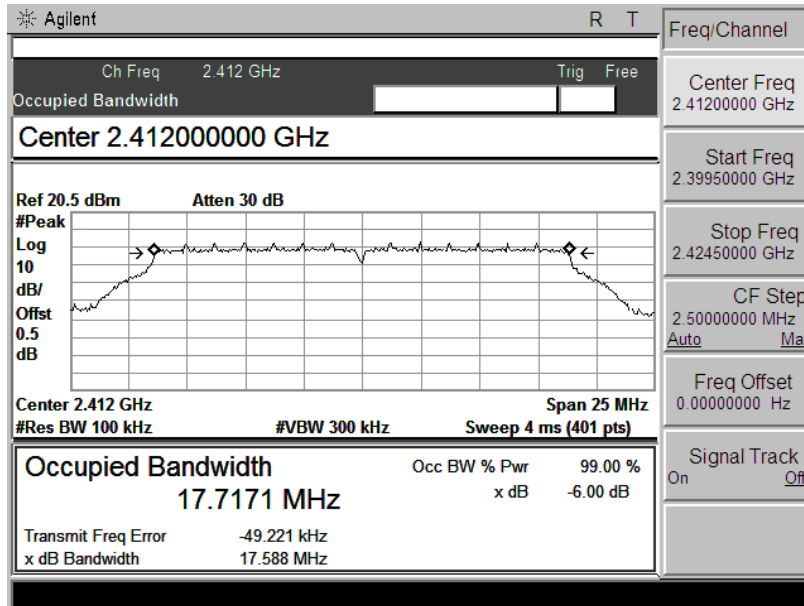

Ch 1

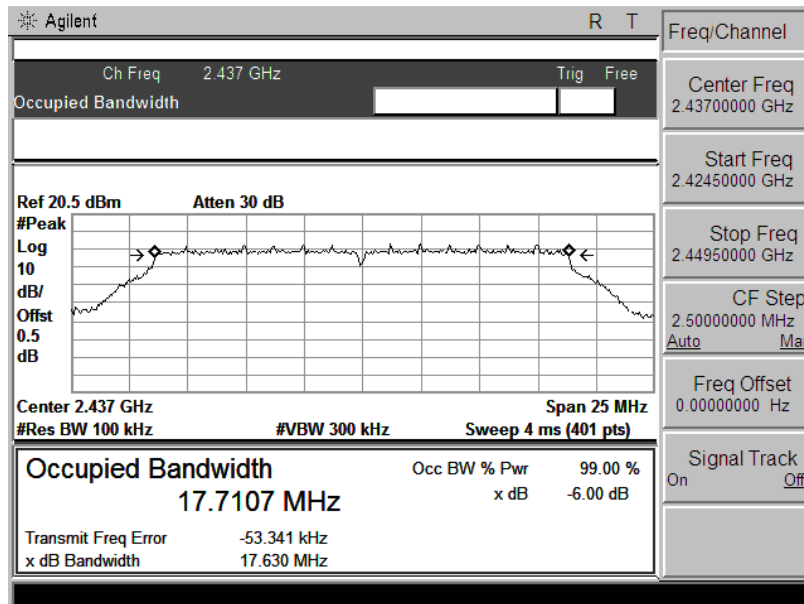

Ch 6

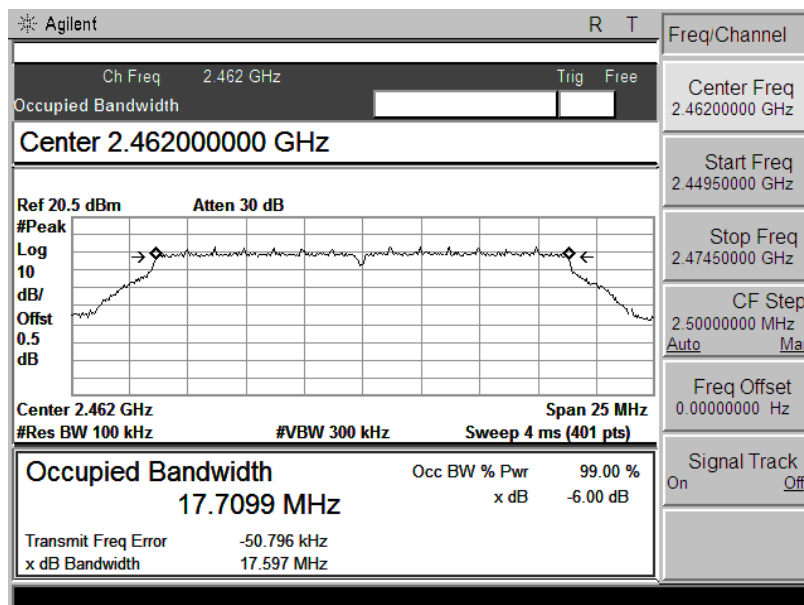

Ch 11

802.11 n(40M) Mode

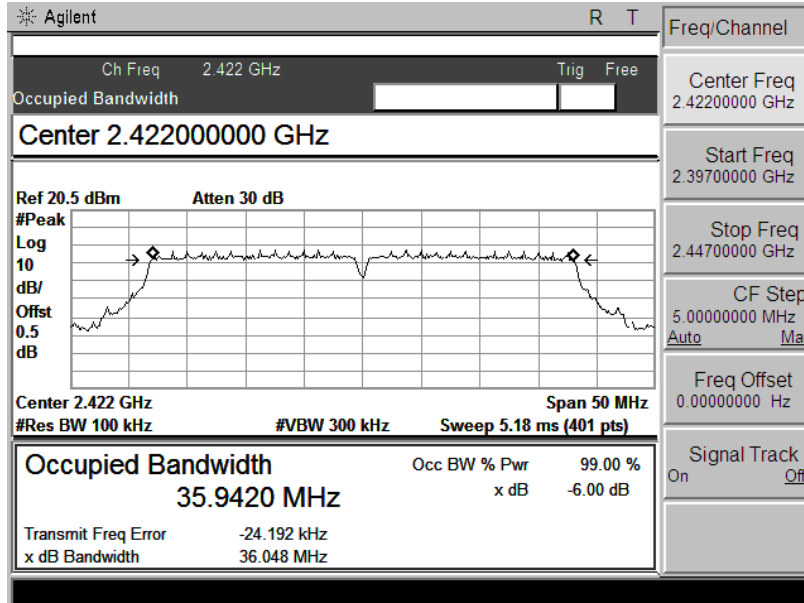

Ch 3

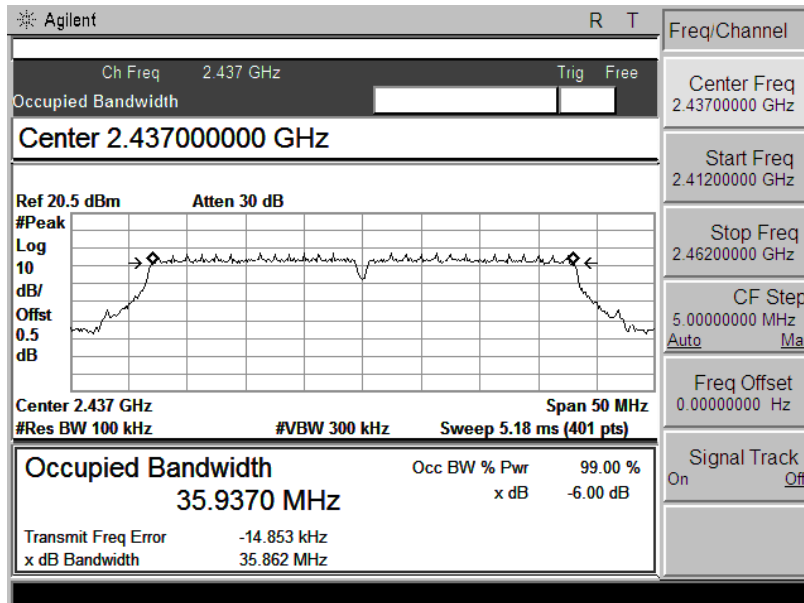

Ch 6

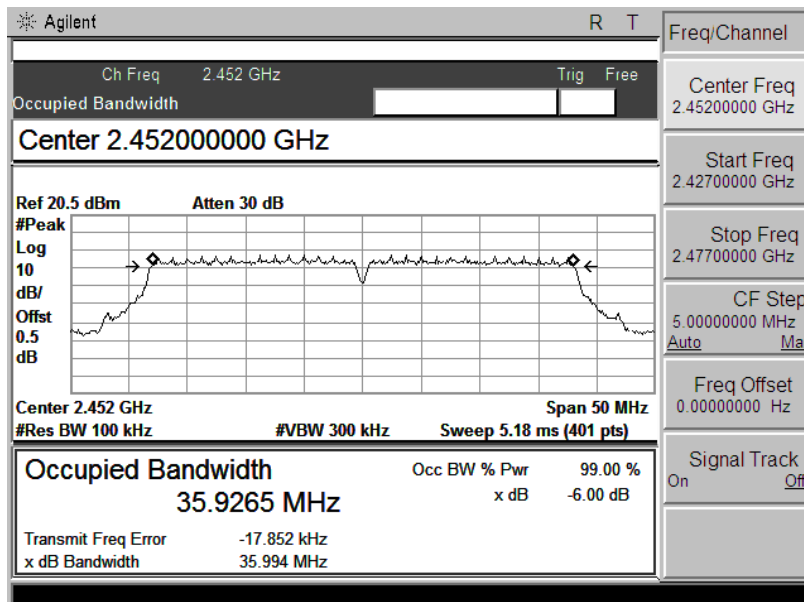

Ch 9

Antenna B:

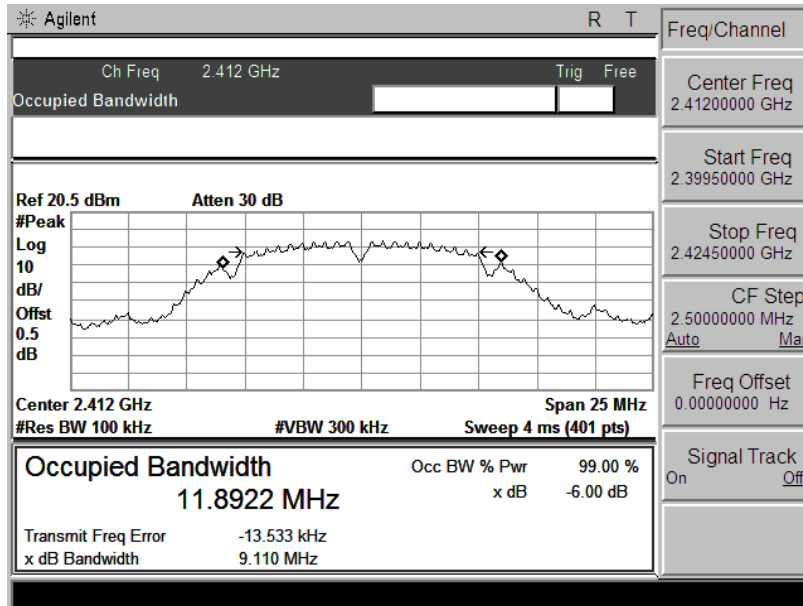

Ch 1

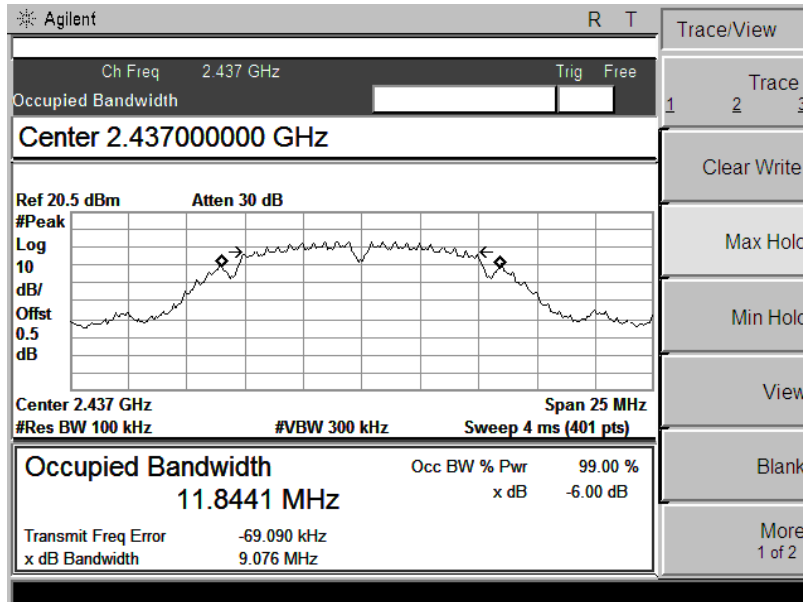

Ch 6

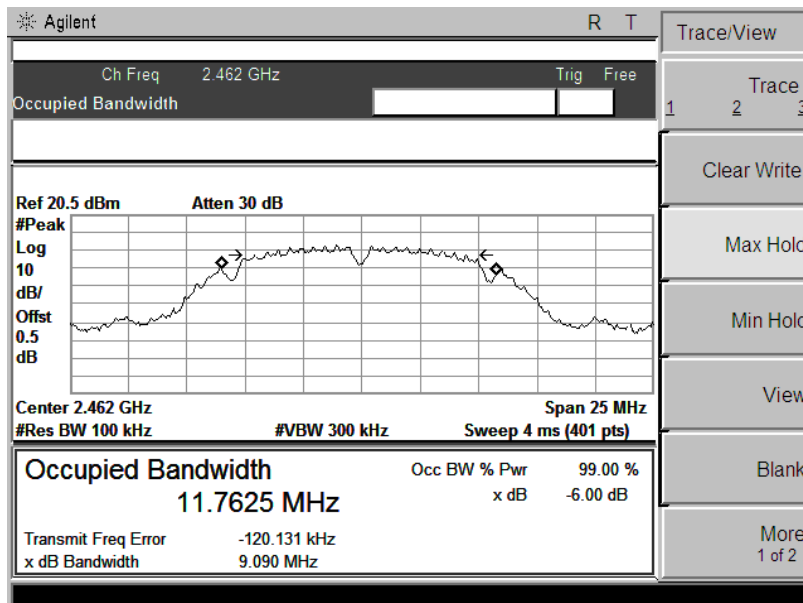

Ch 11

802.11 g Mode

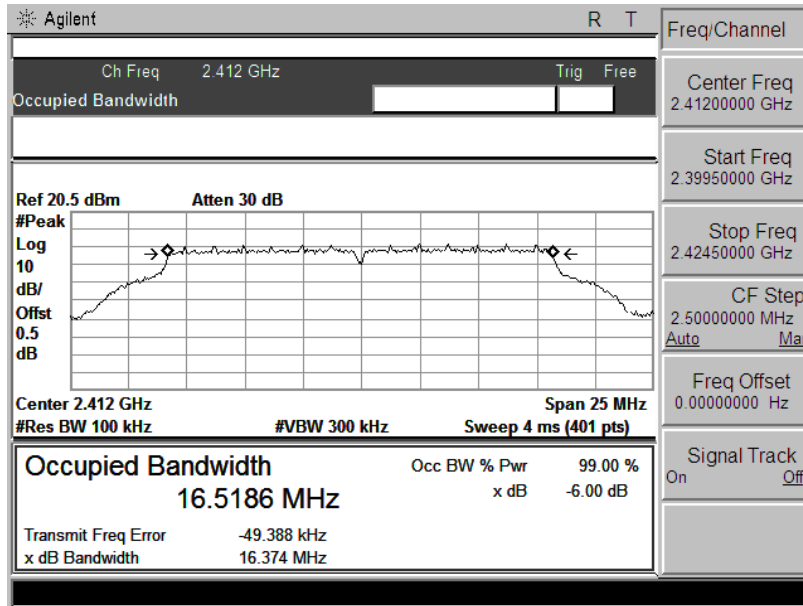

Ch 1

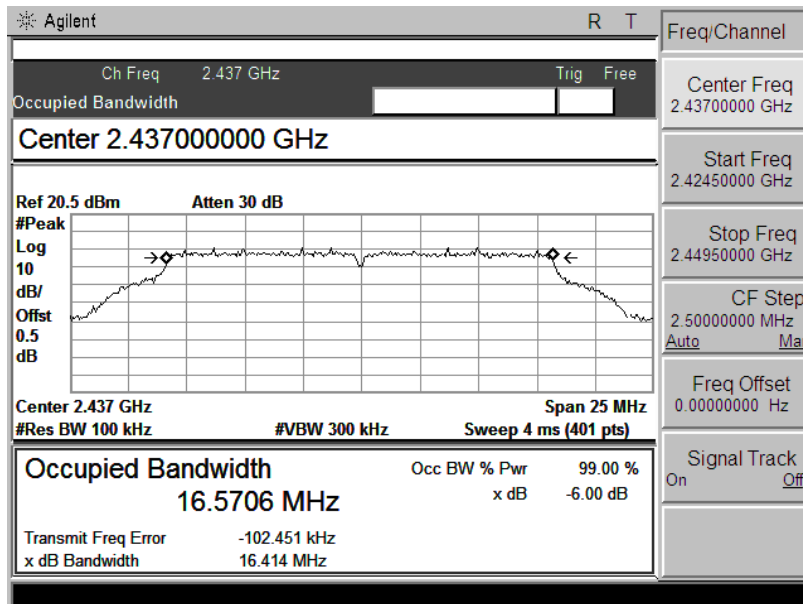

Ch 6

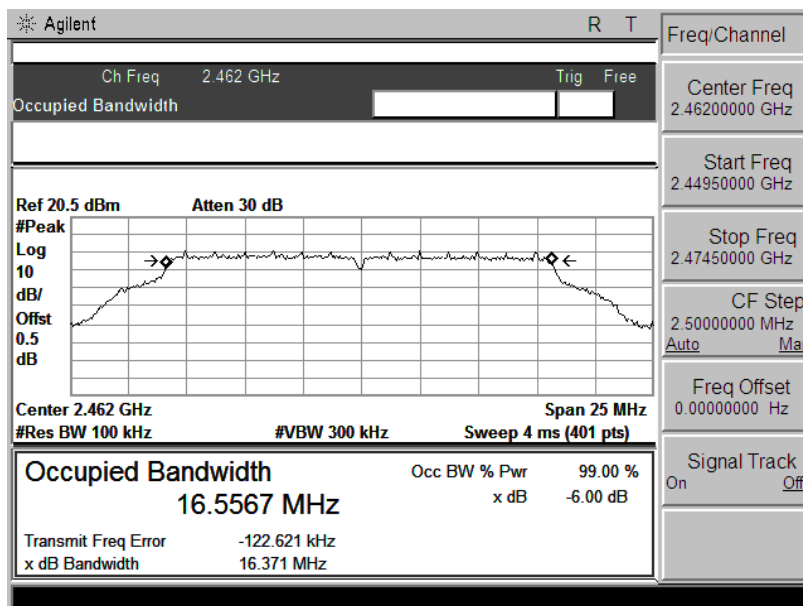

Ch 11
802.11 n(20M) Mode

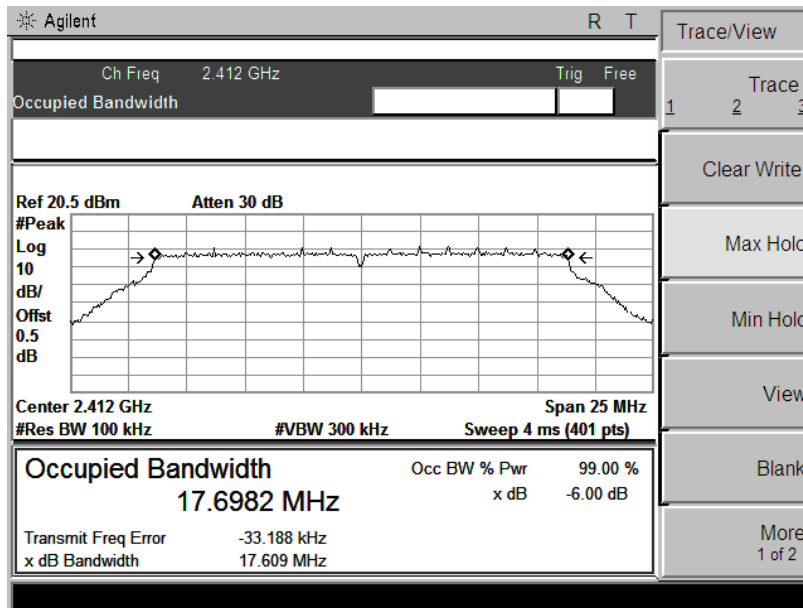

Ch 1

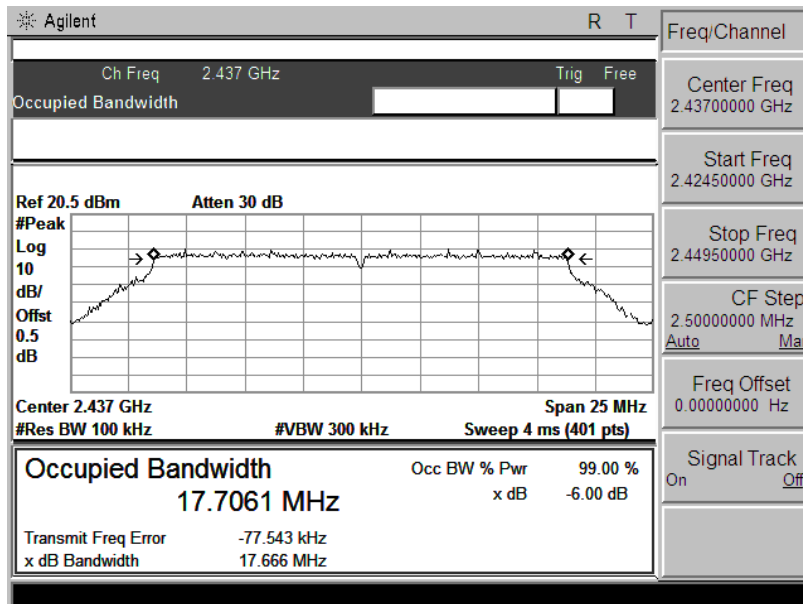

Ch 6

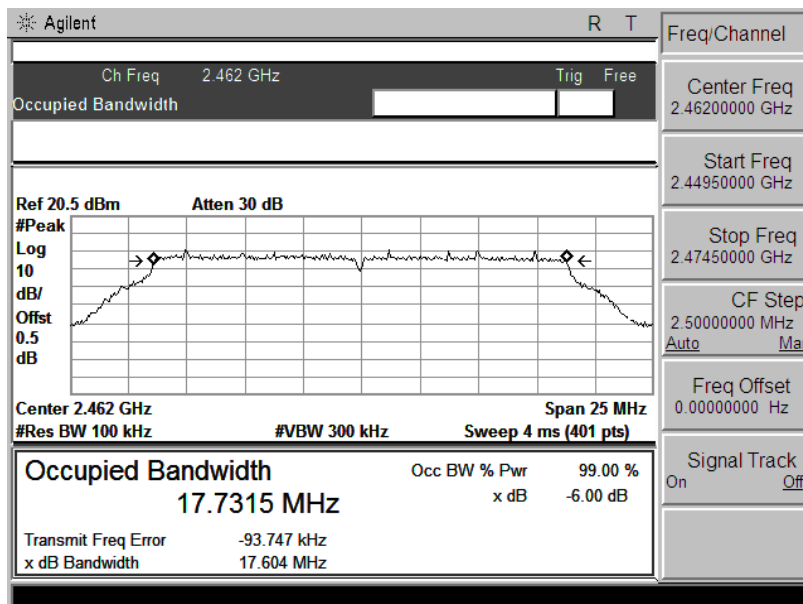

Ch 11

802.11 n(40M) Mode

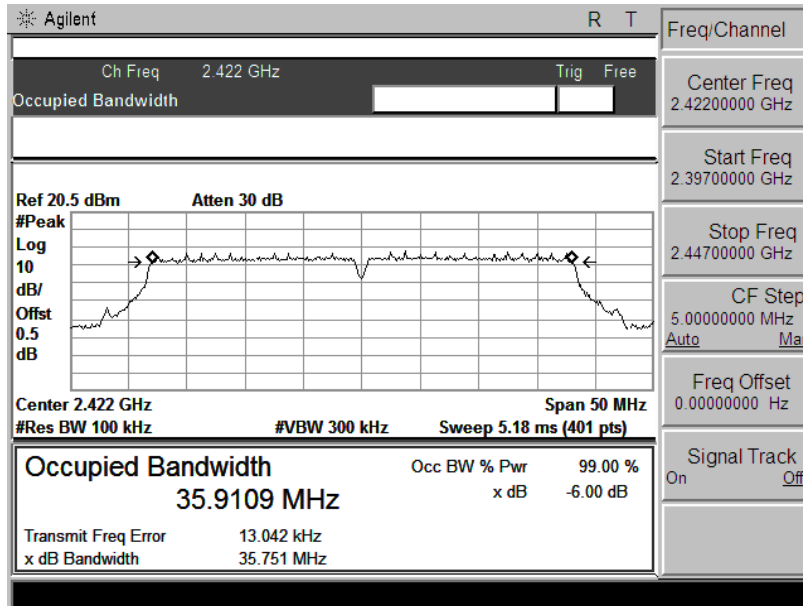

Ch 3

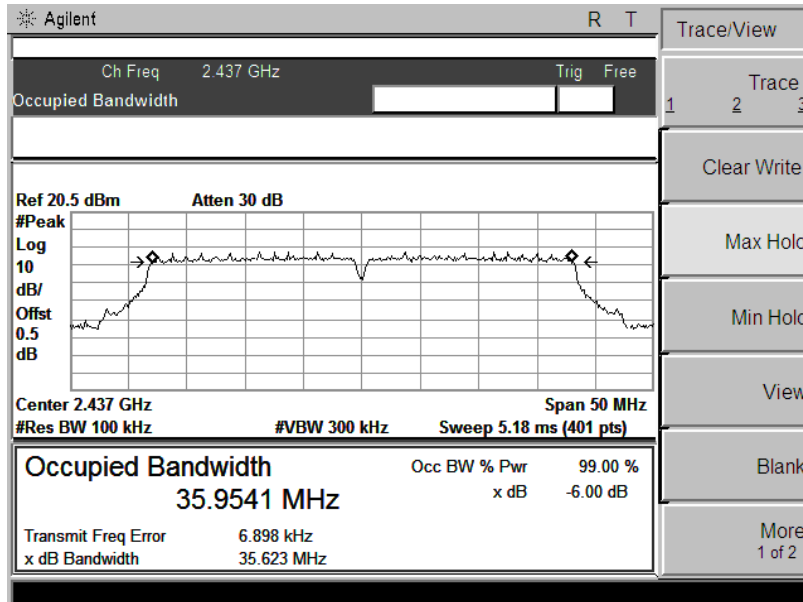

Ch 6

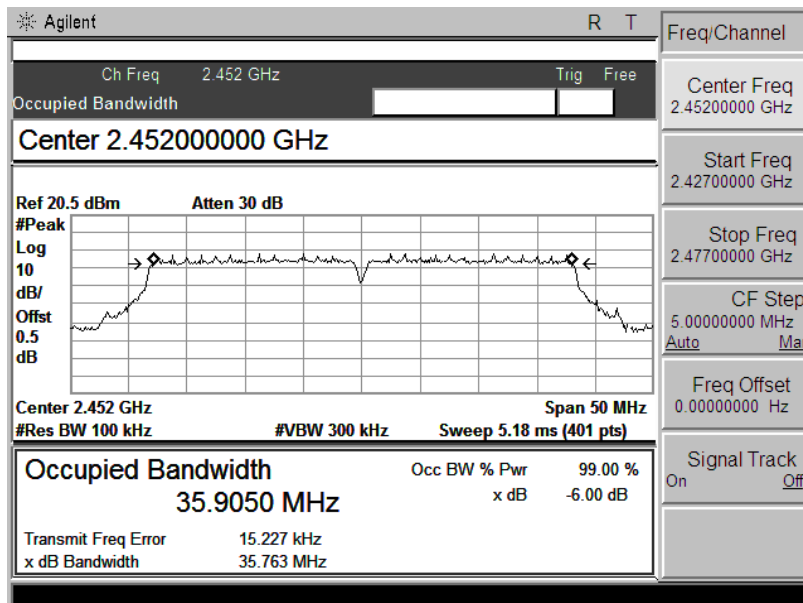

Ch 9

5.6 POWER SPECTRAL DENSITY

5.6.1 Applicable Standard

For digitally modulated systems, the power spectral density conducted from the intentional radiator to the antenna shall not be greater than 8 dBm in any 3 kHz band during any time interval of continuous transmission. This power spectral density shall be determined in accordance with the provisions of paragraph (b) of this section. The same method of determining the conducted output power shall be used to determine the power spectral density.

5.6.2 Block Diagram of Test Setup



5.6.3 Test Procedure

According to KDB 558074 D01 DTS Meas Guidance v03r01clause10.2:

- a) Set analyzer center frequency to DTS channel center frequency.
- b) Set the span to 1.5 times the DTS bandwidth.
- c) Set the RBW to: $3 \text{ kHz} \leq \text{RBW} \leq 100 \text{ kHz}$.
- d) Set the VBW $\geq 3 \times \text{RBW}$.
- e) Detector = peak.
- f) Sweep time = auto couple.
- g) Trace mode = max hold.
- h) Allow trace to fully stabilize.
- i) Use the peak marker function to determine the maximum amplitude level within the RBW.
- j) If measured value exceeds limit, reduce RBW (no less than 3 kHz) and repeat.

5.6.4 Test Result

Test Item:	POWER SPECTRAL DENSITY	Temperature :	20°C
Test Engineer:	John	Relative Humidity :	55%

Antenna A:

Mode	Channel	Frequency (MHz)	PSD (dBm/3kHz)	Limit (dBm/3kHz)	Result
802.11b	Low	2412	-6.50	≤8	Pass
	Middle	2437	-6.41	≤8	Pass
	High	2462	-6.23	≤8	Pass
802.11g	Low	2412	-10.27	≤8	Pass
	Middle	2437	-9.85	≤8	Pass
	High	2462	-10.13	≤8	Pass
802.11n (20MHz)	Low	2412	-10.06	≤8	Pass
	Middle	2437	-8.83	≤8	Pass
	High	2462	-8.53	≤8	Pass
802.11n (20MHz)	Low	2422	-16.62	≤8	Pass
	Middle	2437	-16.27	≤8	Pass
	High	2452	-15.33	≤8	Pass

Antenna B:

Mode	Channel	Frequency (MHz)	PSD (dBm/100kHz)	Limit (dBm/100kHz)	Result
802.11b	Low	2412	-8.797	≤8	Pass
	Middle	2437	-7.455	≤8	Pass
	High	2462	-7.671	≤8	Pass
802.11g	Low	2412	-10.65	≤8	Pass
	Middle	2437	-11.33	≤8	Pass
	High	2462	-9.867	≤8	Pass
802.11n (20MHz)	Low	2412	-10.09	≤8	Pass
	Middle	2437	-10.72	≤8	Pass
	High	2462	-10.07	≤8	Pass
802.11n (20MHz)	Low	2422	-15.74	≤8	Pass
	Middle	2437	-17.16	≤8	Pass
	High	2452	-14.62	≤8	Pass

Antenna A:

802.11 b Mode

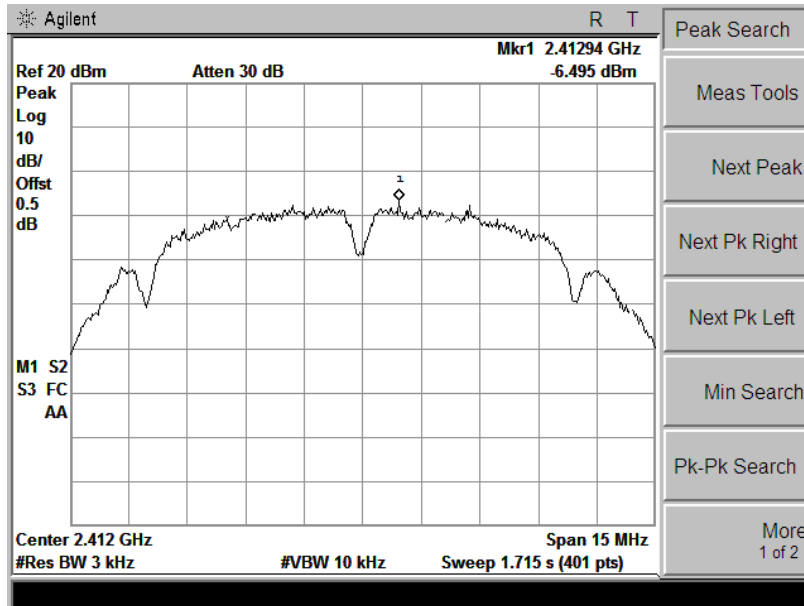

Ch 1

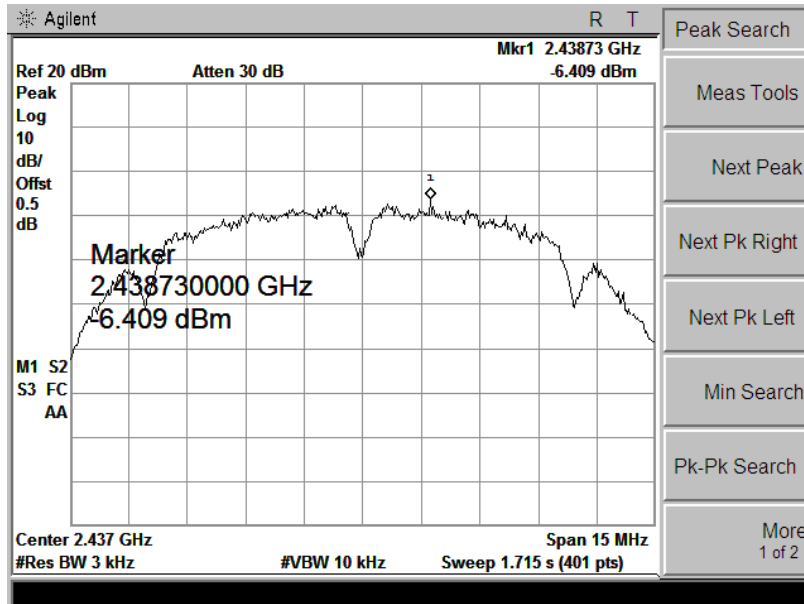

Ch 6

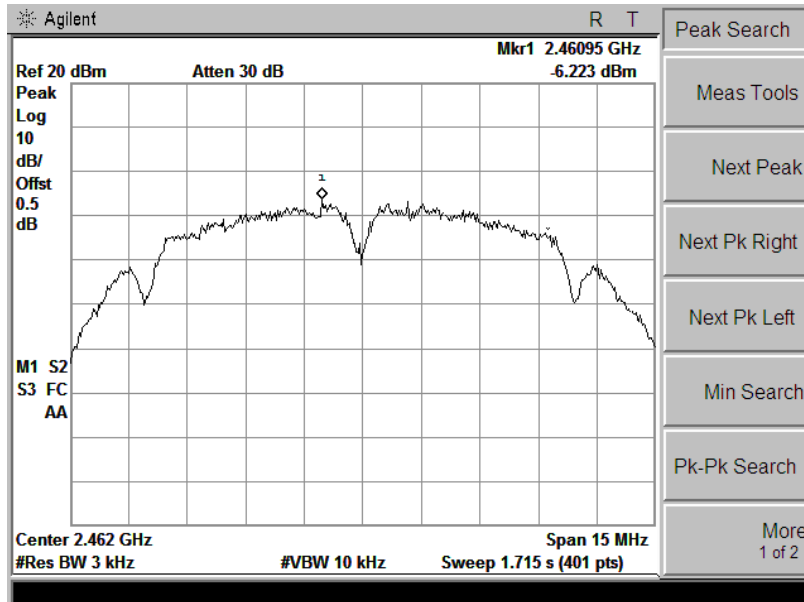

Ch 11

802.11 g Mode

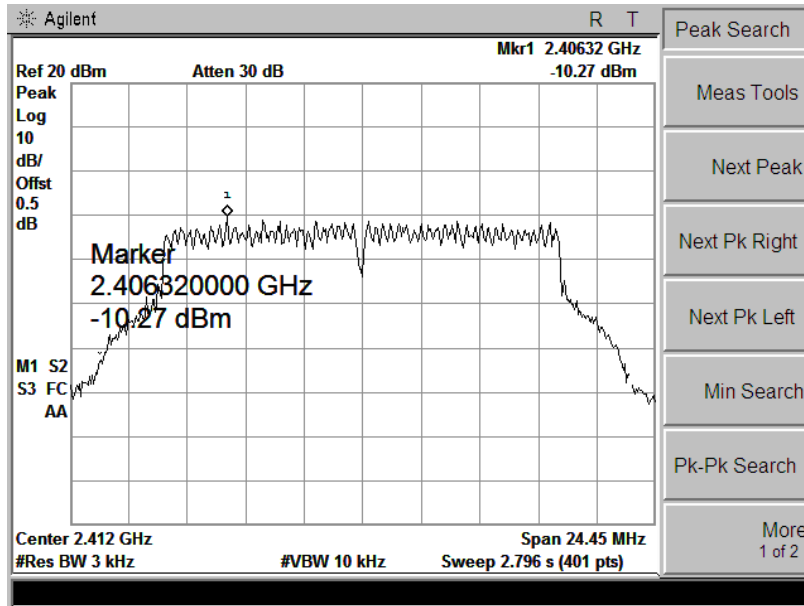

Ch 1

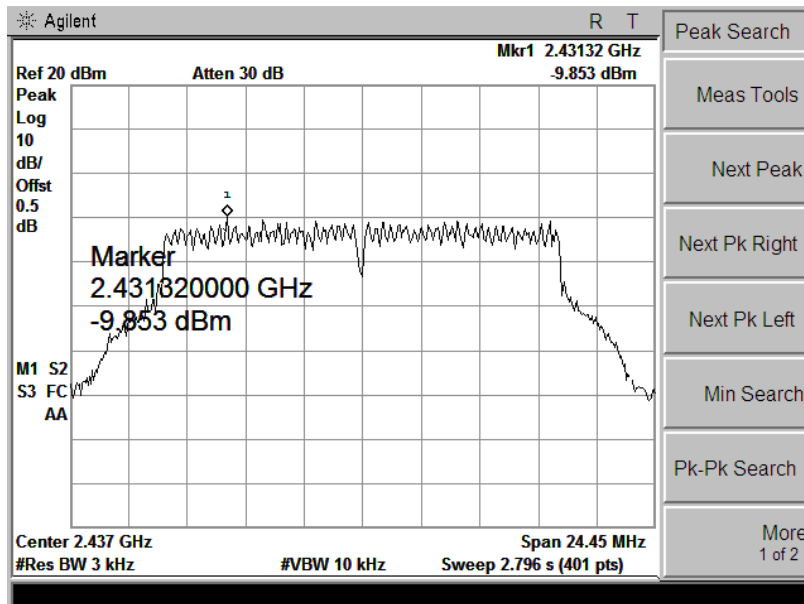

Ch 6

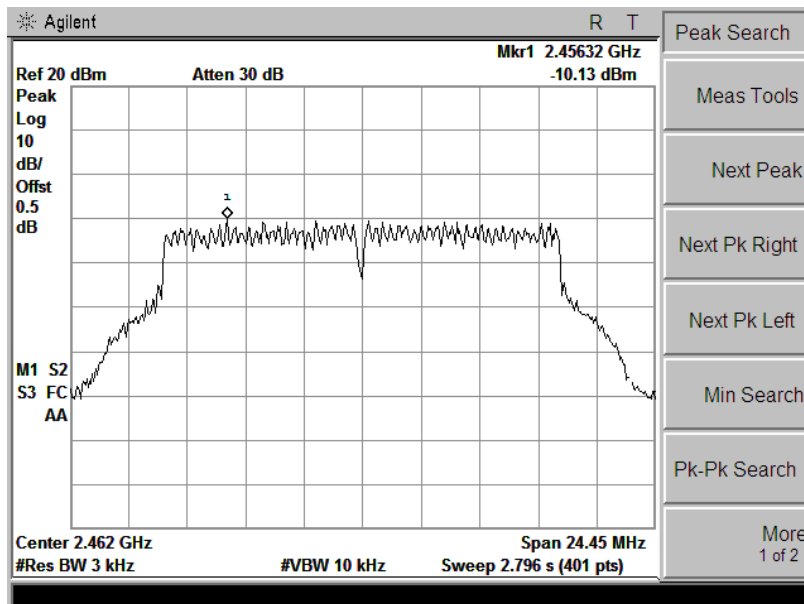

Ch 11

802.11 n(20M) Mode

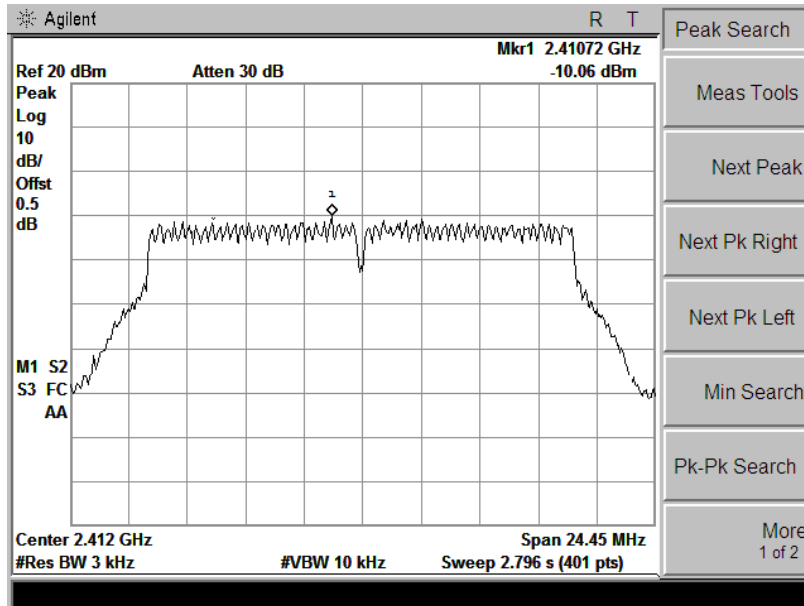

Ch 1

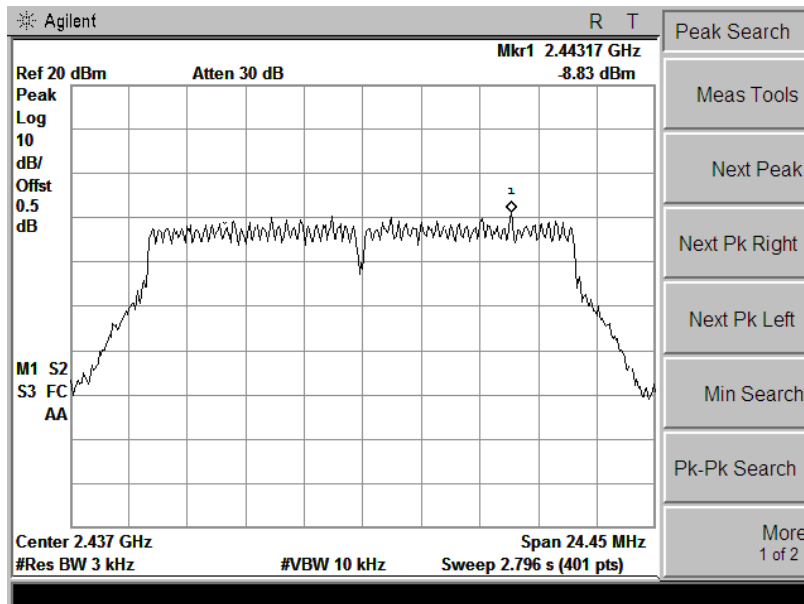

Ch 6

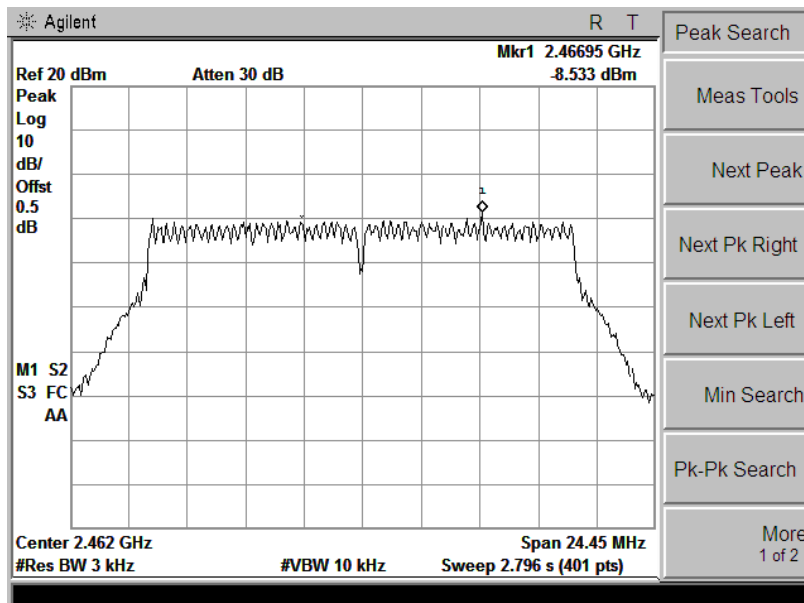

Ch 11

802.11 n(40M) Mode

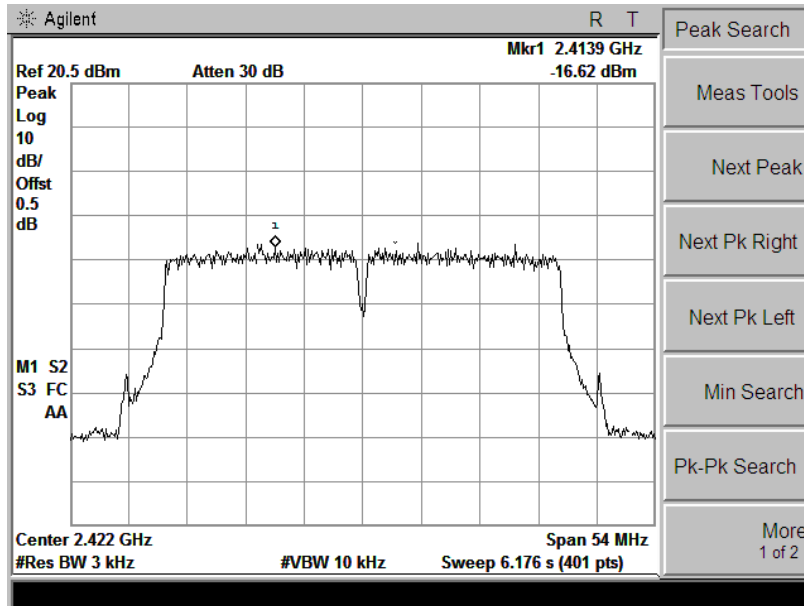

Ch 1

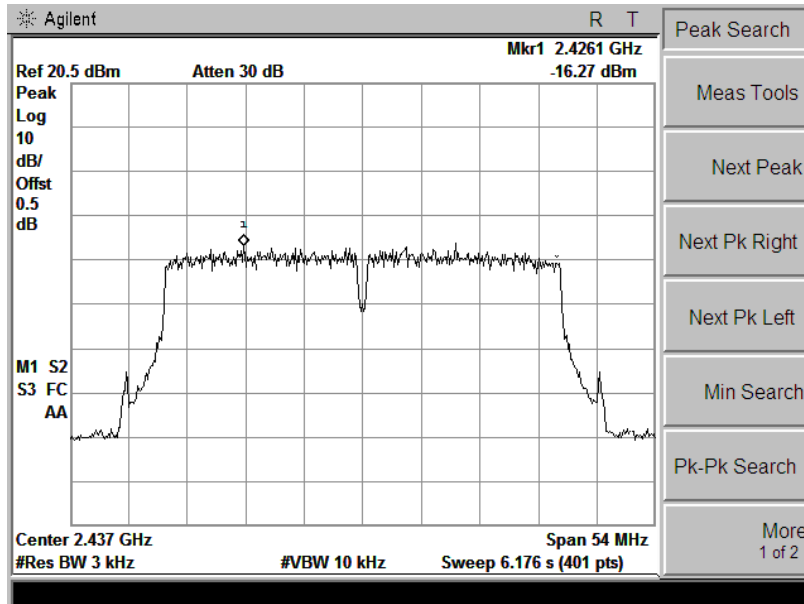

Ch 6

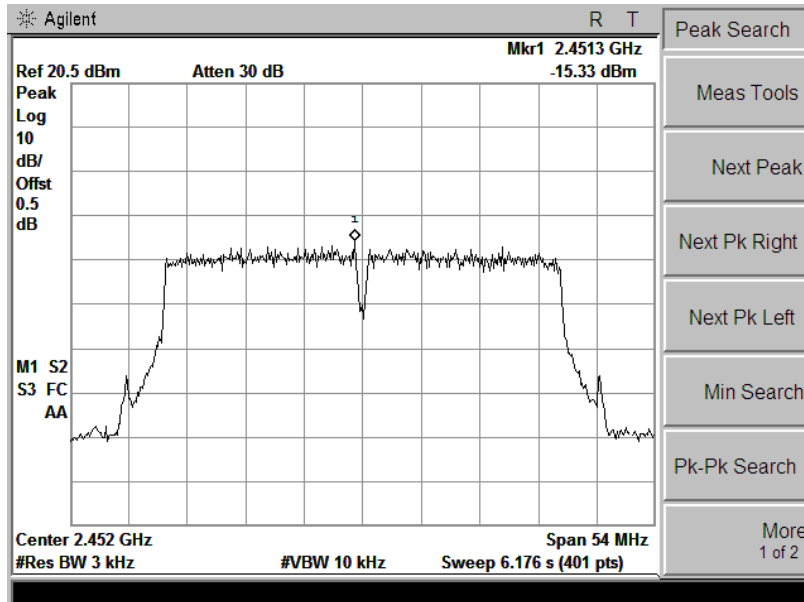

Ch 9

Antenna B:

802.11 b Mode

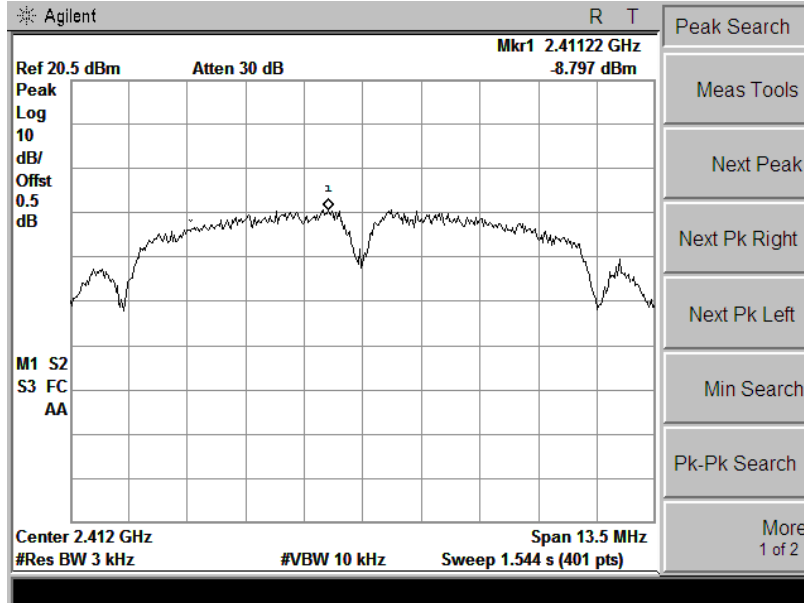

Ch 1

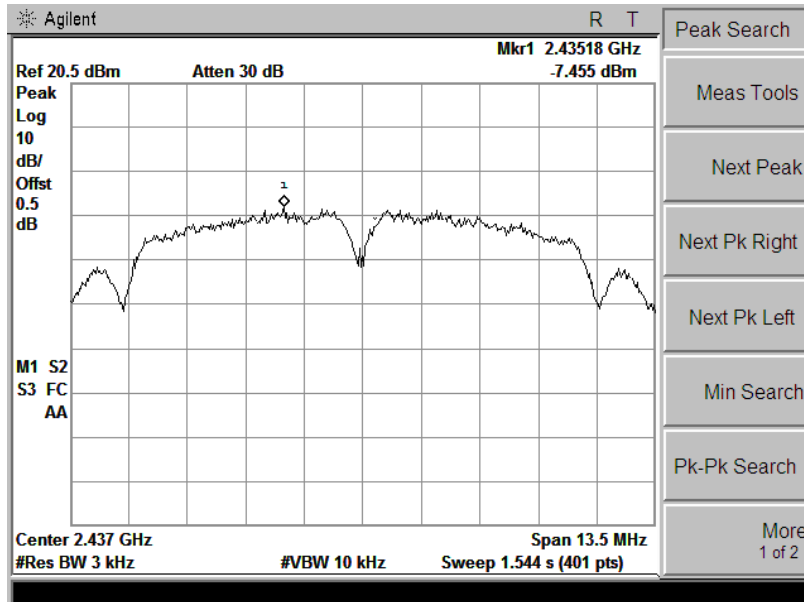

Ch 6

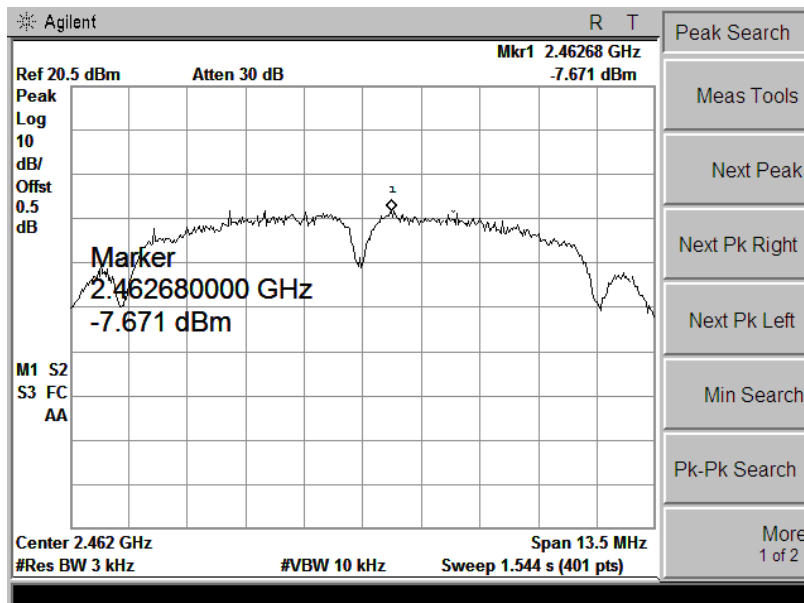

Ch 11

802.11 g Mode

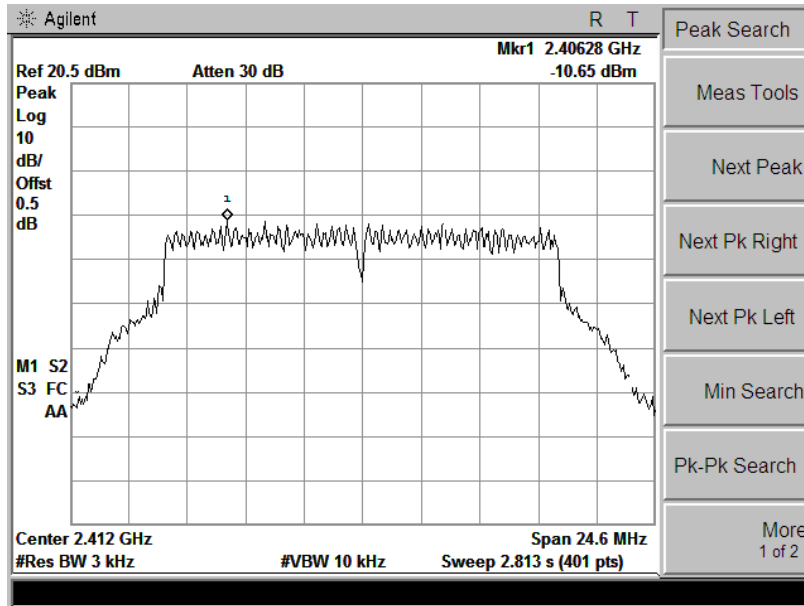

Ch 1

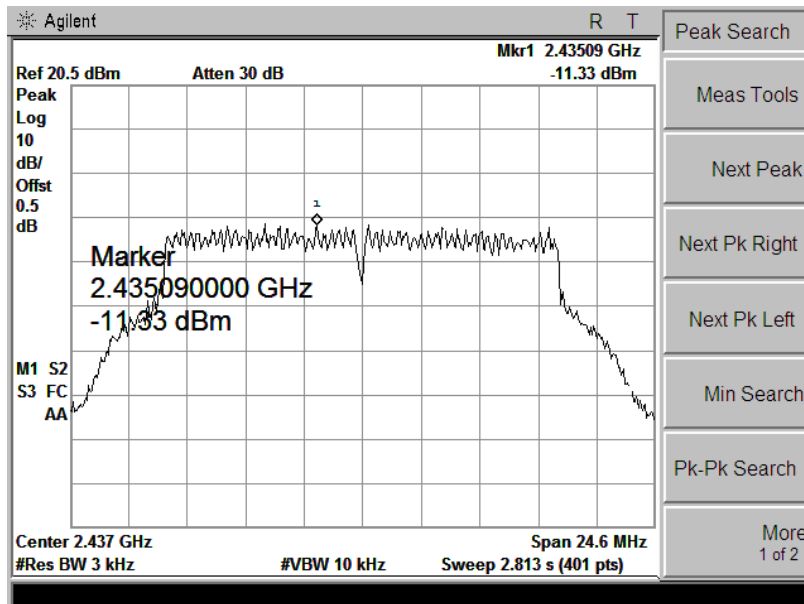

Ch 6

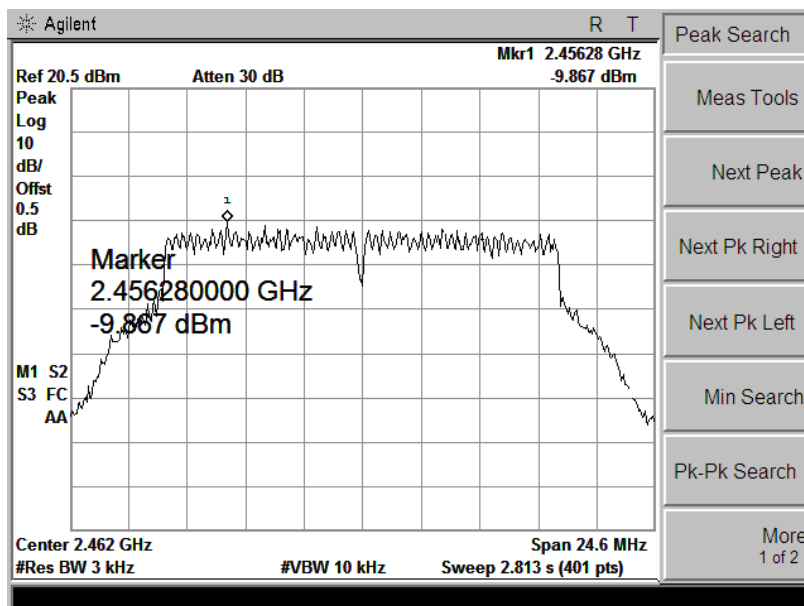

Ch 11

802.11 n(20M) Mode

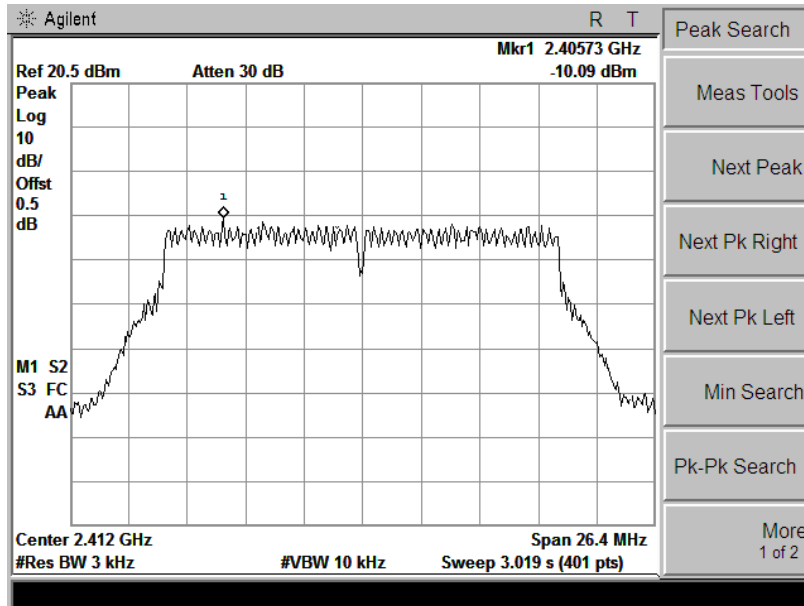

Ch 1

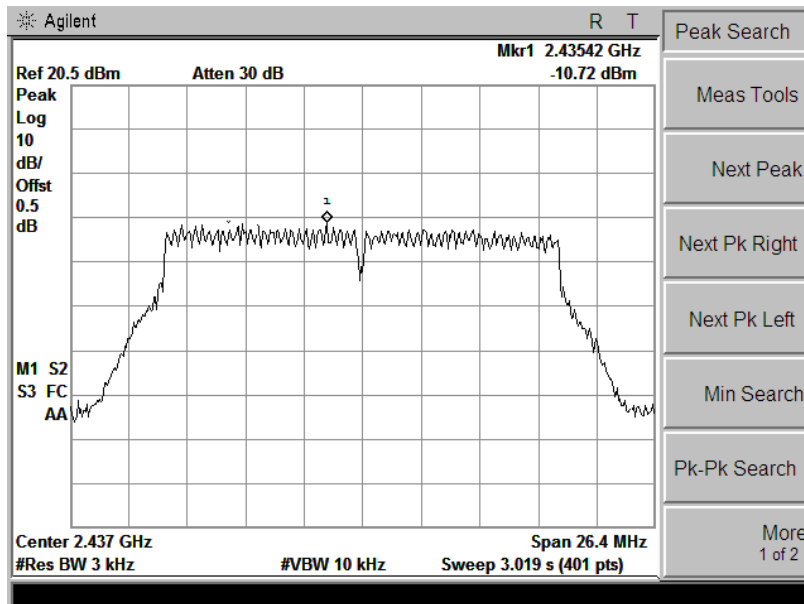

Ch 6

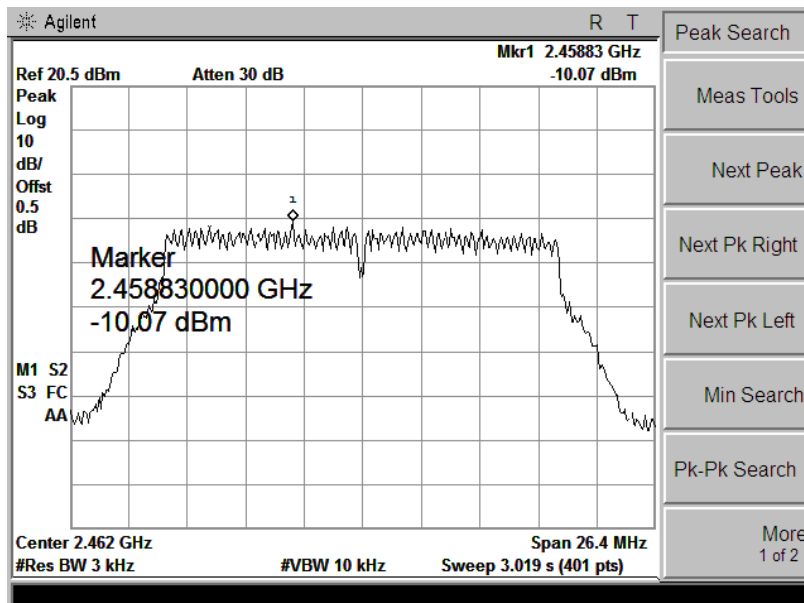

Ch 11

802.11 n(40M) Mode

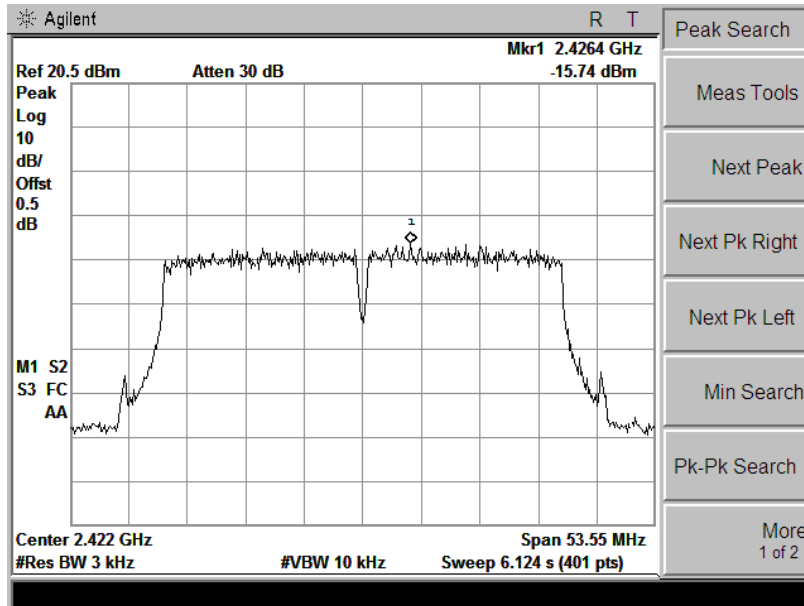

Ch 1

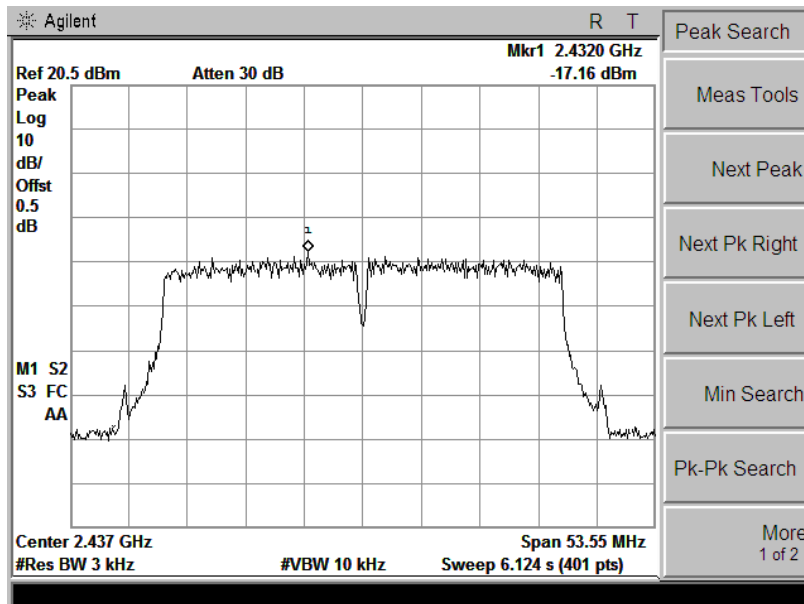

Ch 6

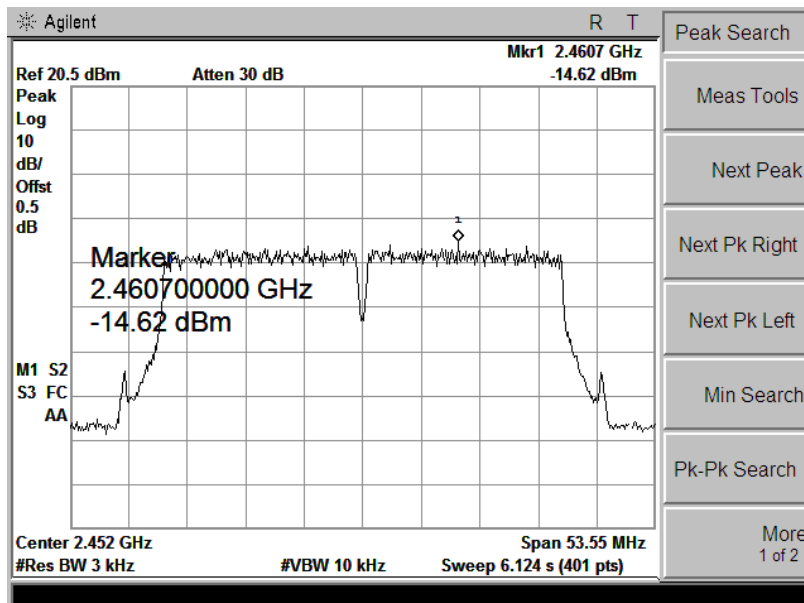

Ch 9

5.7 Band Edge and Conducted Spurious Emissions

5.7.1 Test Requirement

In any 100 kHz bandwidth outside the frequency band in which the spread spectrum or digitally modulated intentional radiator is operating, the radio frequency power that is produced by the intentional radiator shall be at least 20 dB below that in the 100 kHz bandwidth within the band that contains the highest level of the desired power, based on either an RF conducted or a radiated measurement, provided the transmitter demonstrates compliance with the peak conducted power limits. If the transmitter complies with the conducted power limits based on the use of RMS averaging over a time interval, as permitted under paragraph (b)(3) of this section, the attenuation required under this paragraph shall be 30 dB instead of 20 dB. Attenuation below the general limits specified in §15.209(a) is not required.

5.7.2 Test Procedure

1. Check the calibration of the measuring instrument using either an internal calibrator or a known signal from an external generator.
2. Remove the antenna from the EUT and then connect to a low loss RF cable from the antenna port to a EMI test receiver, then turn on the EUT and make it operate in transmitting mode. Then set it to Low Channel and High Channel within its operating range, and make sure the instrument is operated in its linear range.
3. Set both RBW and VBW of spectrum analyzer to 100 kHz with a convenient frequency span including 100 kHz bandwidth from band edge.
4. Measure the highest amplitude appearing on spectral display and set it as a reference level. Plot the graph with marking the highest point and edge frequency.
5. Repeat above procedures until all measured frequencies were complete.

5.7.3 Test Result

Pass

Remark:

During the Conducted Spurious Emissions test, pre-scan the 802.11b, 802.11g, 802.11n(20/40)modulation, and found the 802.11b modulation which it is worse case.

Test Item:	Band Edge	Temperature :	23°C
Test Engineer:	John	Relative Humidity :	65%

Antenna A:

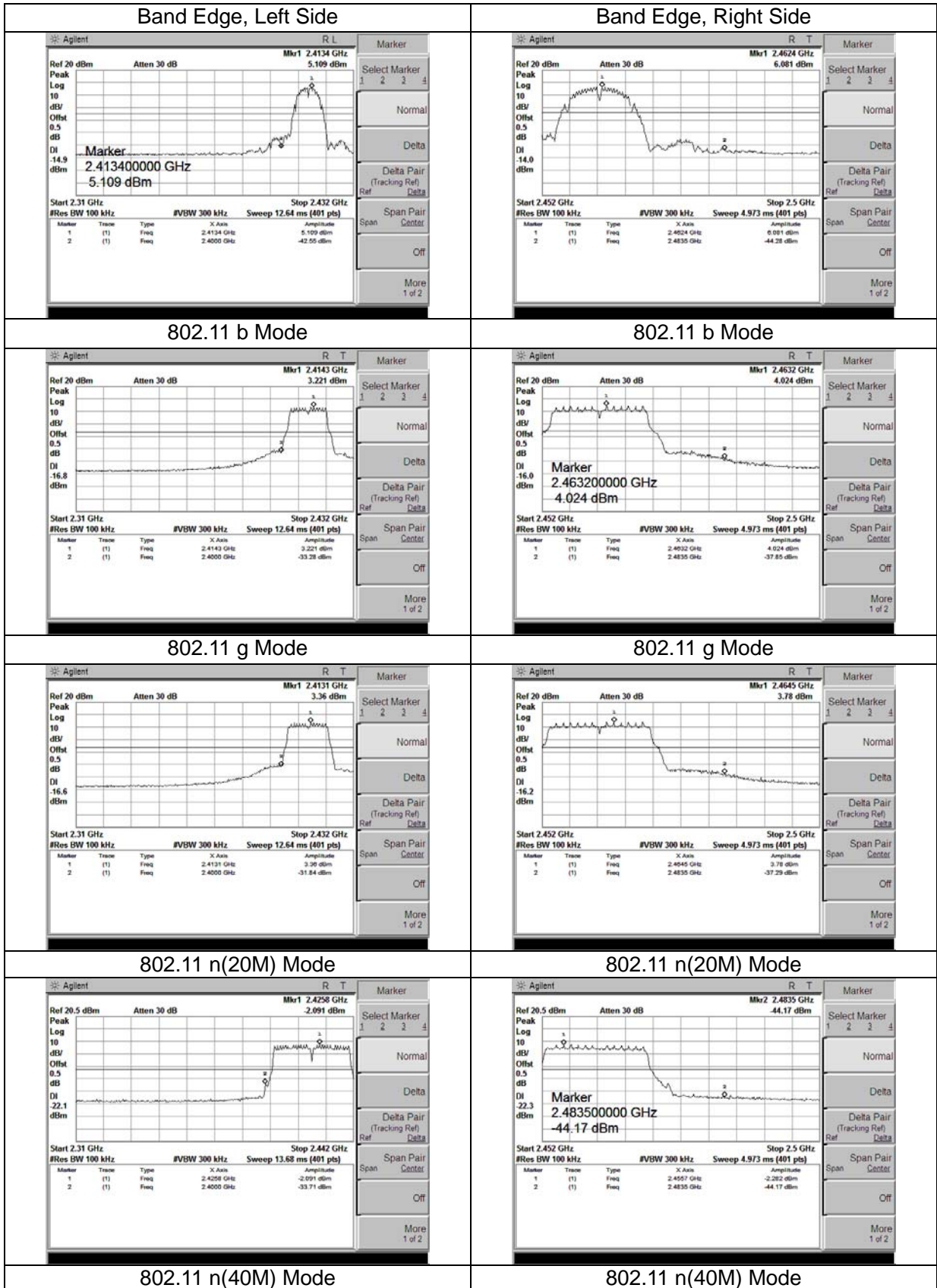

Antenna B:

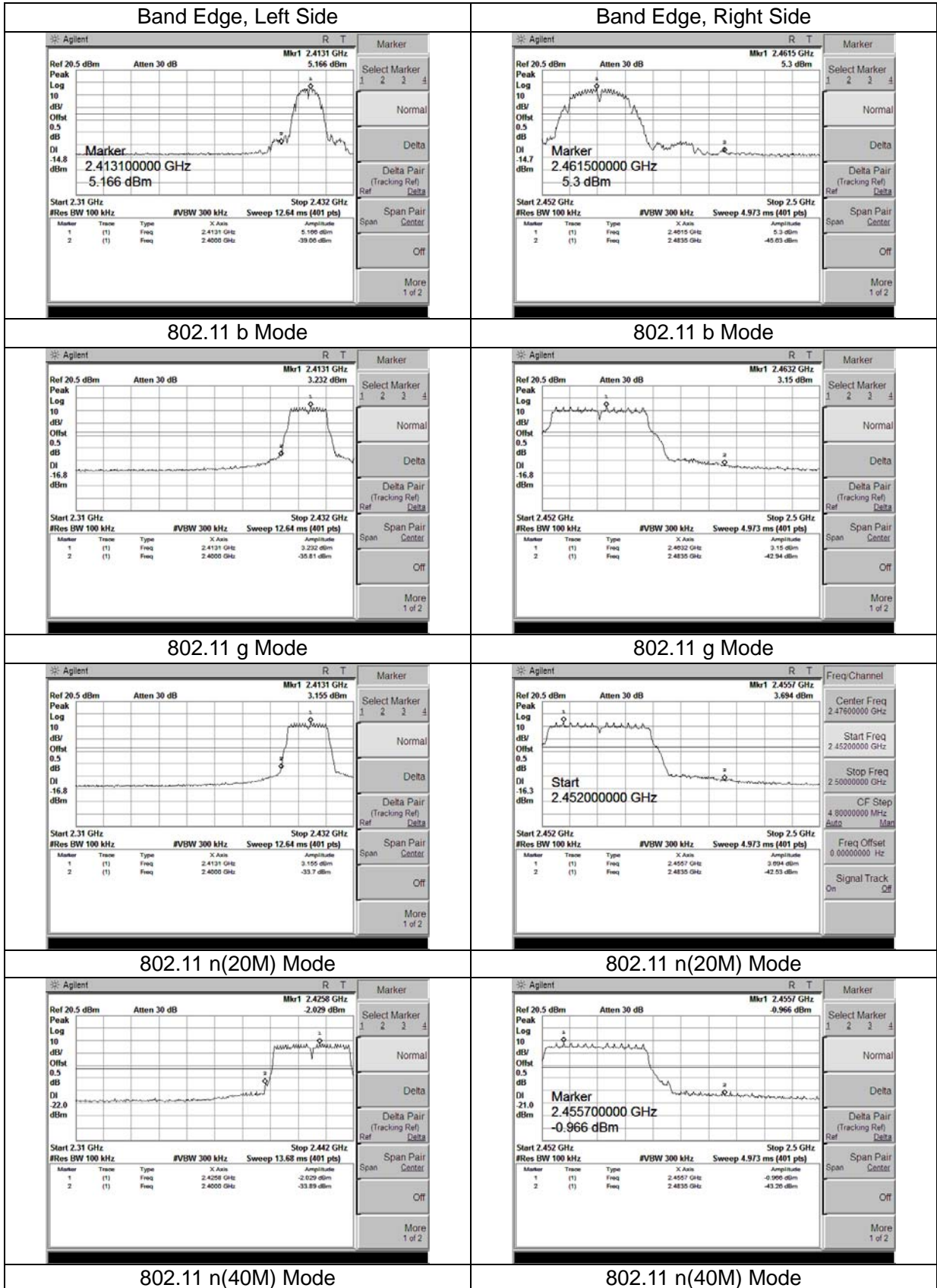

Antenna A:

Conducted Spurious Emissions

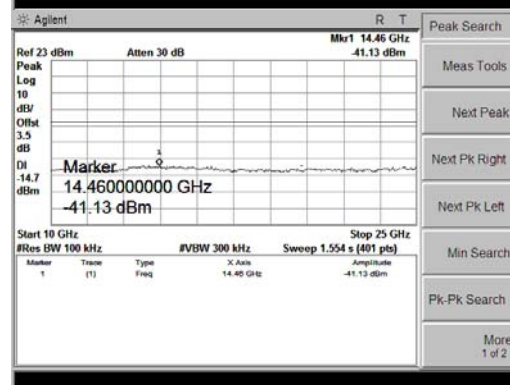
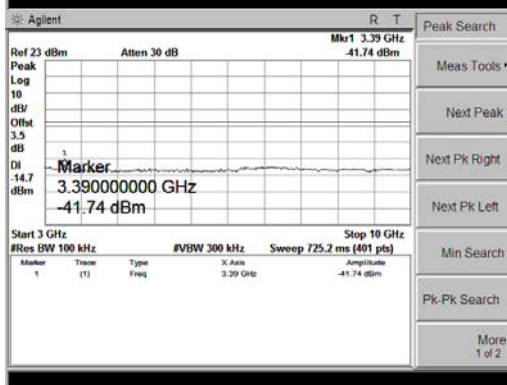
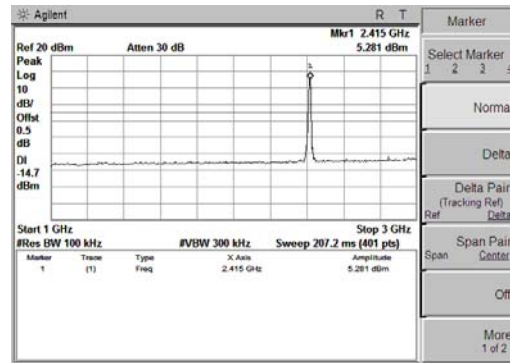
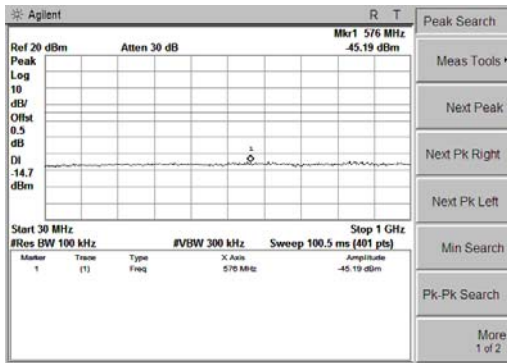

802.11b Mode, Ch1

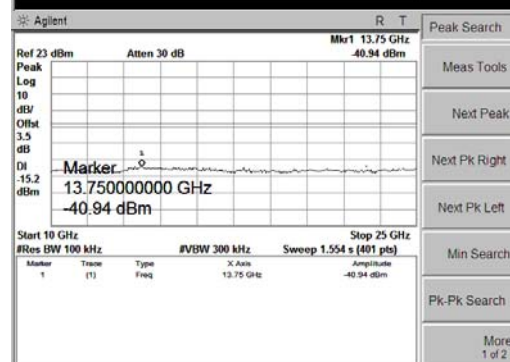
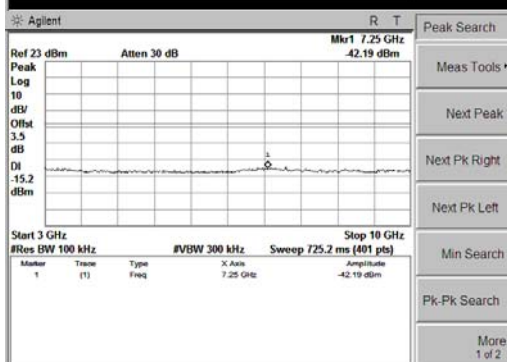
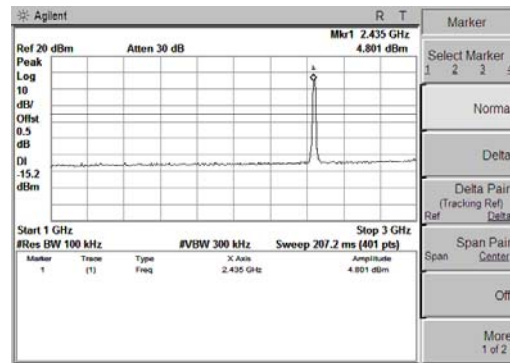
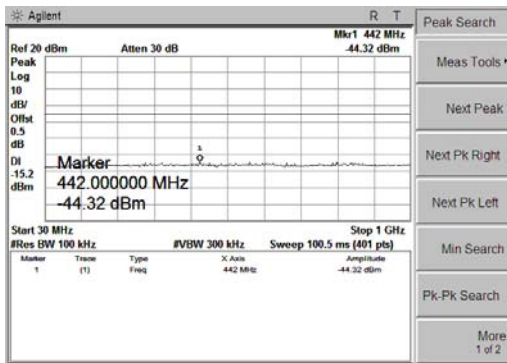

802.11b Mode, Ch6

Conducted Spurious Emissions

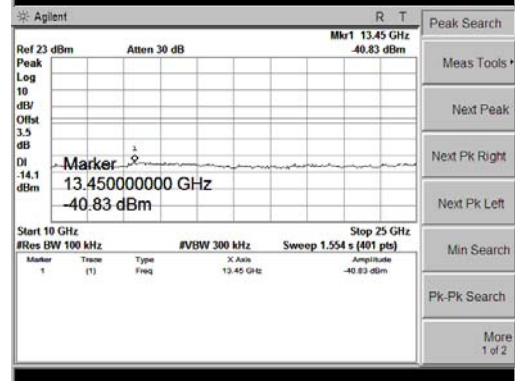
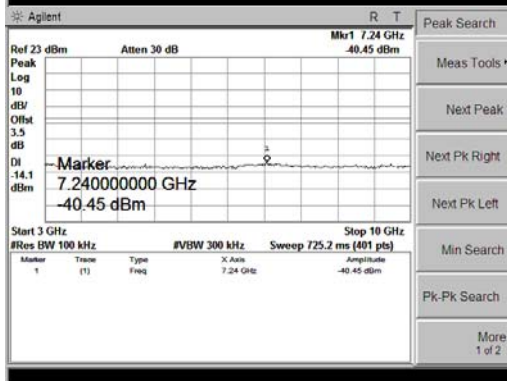
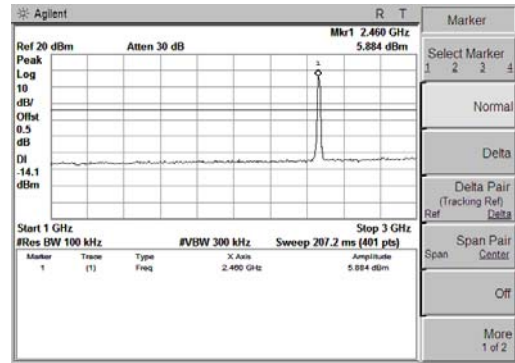
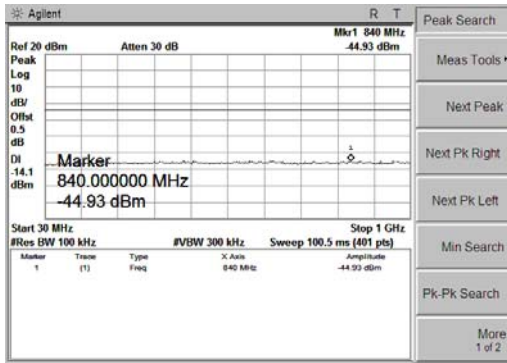

802.11b Mode, Ch11

Antenna B:

Conducted Spurious Emissions

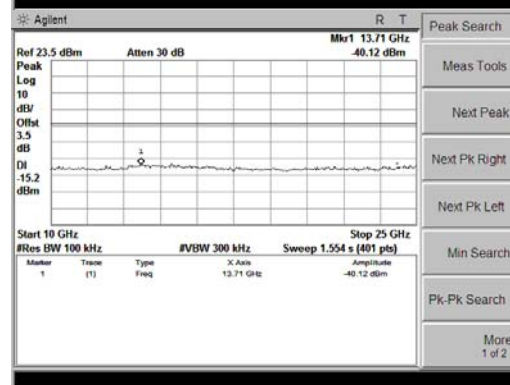
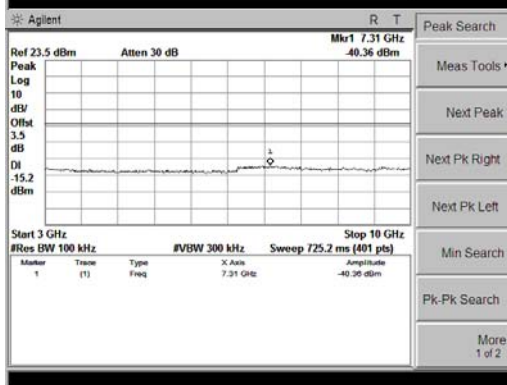
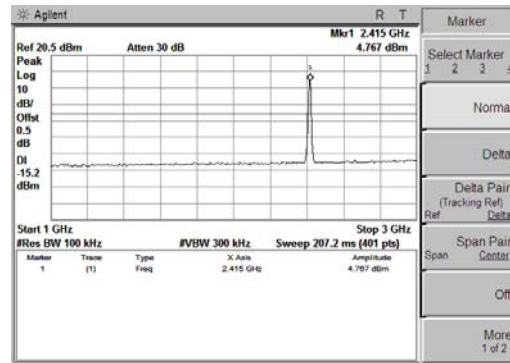
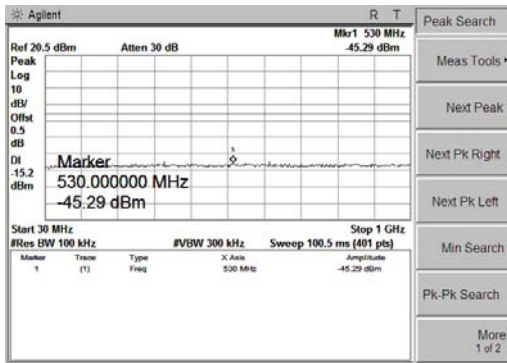

802.11b Mode, Ch1

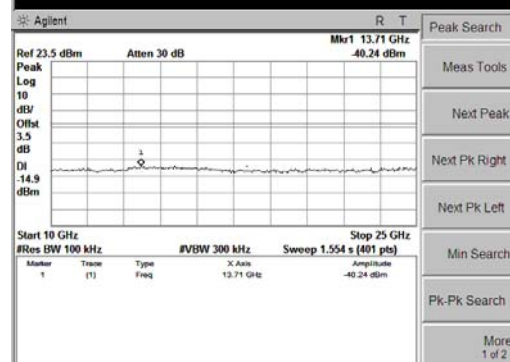
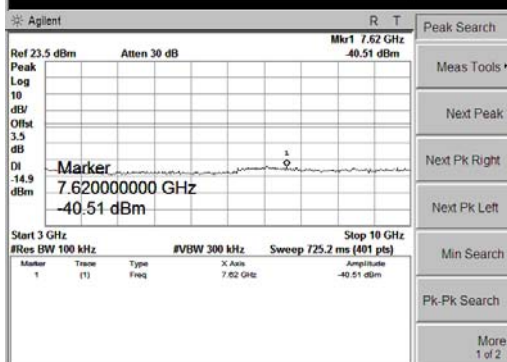
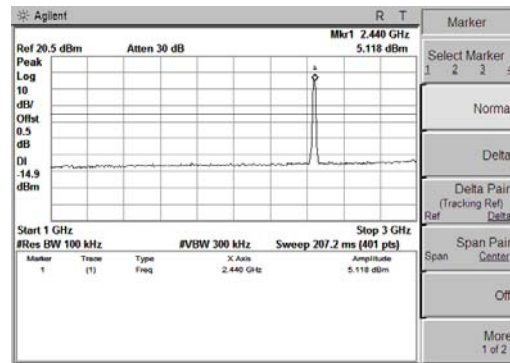
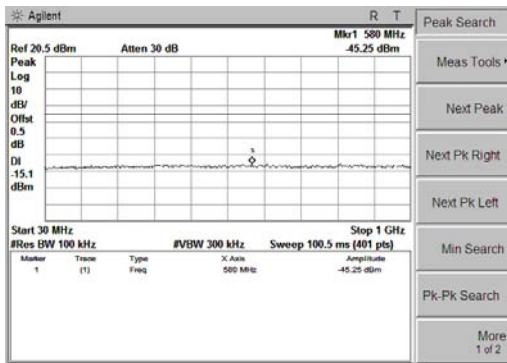

802.11b Mode, Ch6

Conducted Spurious Emissions

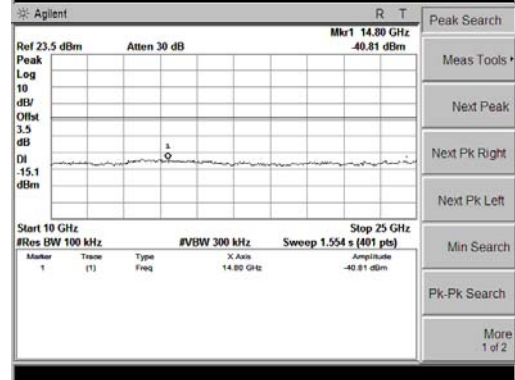
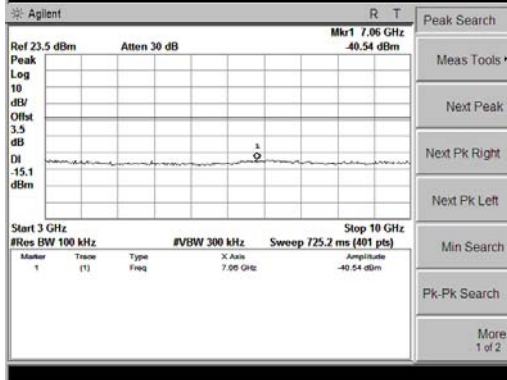
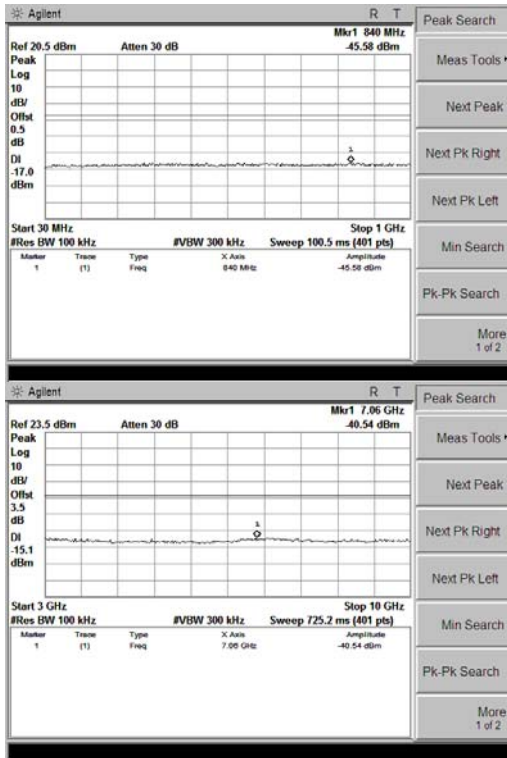

802.11b Mode, Ch11

5.8 Restricted Frequency Bands

5.8.1 Test Requirement

In any 100 kHz bandwidth outside the frequency band in which the spread spectrum or digitally modulated intentional radiator is operating, the radio frequency power that is produced by the intentional radiator shall be at least 20 dB below that in the 100 kHz bandwidth within the band that contains the highest level of the desired power. In addition, radiated emissions which fall in the restricted bands, as defined in §15.205(a), must also comply with the radiated emission limits specified in §15.209(a) (see §15.205(c)).

5.8.2 Test Configuration

Test Setup:

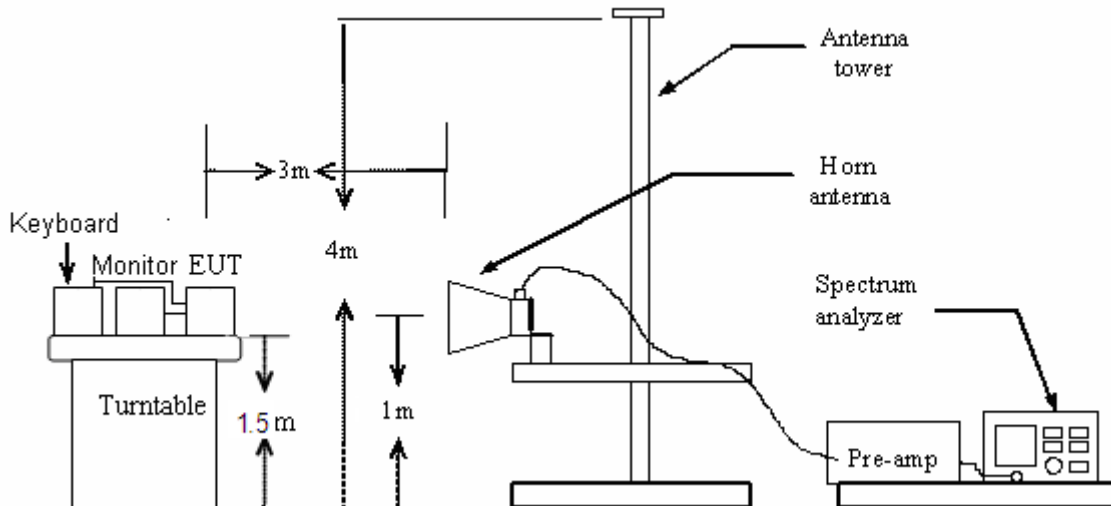

5.8.3 Test Procedure:

1. The EUT was placed on the top of a rotating table 1.5 meters above the ground at a 3 meter chamber. The table was rotated 360 degrees to determine the position of the highest radiation.
2. The EUT was set 3 meters away from the interference-receiving antenna, which was mounted on the top of a variable-height antenna tower.
3. The antenna height is varied from one meter to four meters above the ground to determine the maximum value of the field strength. Both horizontal and vertical polarizations of the antenna are set to make the measurement.
4. For each suspected emission, the EUT was arranged to its worst case and then the antenna was tuned to heights from 1 meter to 4 meters and the table was turned from 0 degrees to 360 degrees to find the maximum reading.

5.8.4 Test Result

Pass

Note: All test modes are performed, only the worst case is recorded in this report.

Please refer the following plots.

Antenna A:

EUT:	DamaiBox 3.0	M/N:	DB3026US
Mode:	802.11b-CH1	Phase:	Vertical
Test by:	John	Power:	DC 12V by Adapter
Temperature: / Humidity	23.7°C / 51.6%	Test date:	2016-07-18

106.0 dBuV/m

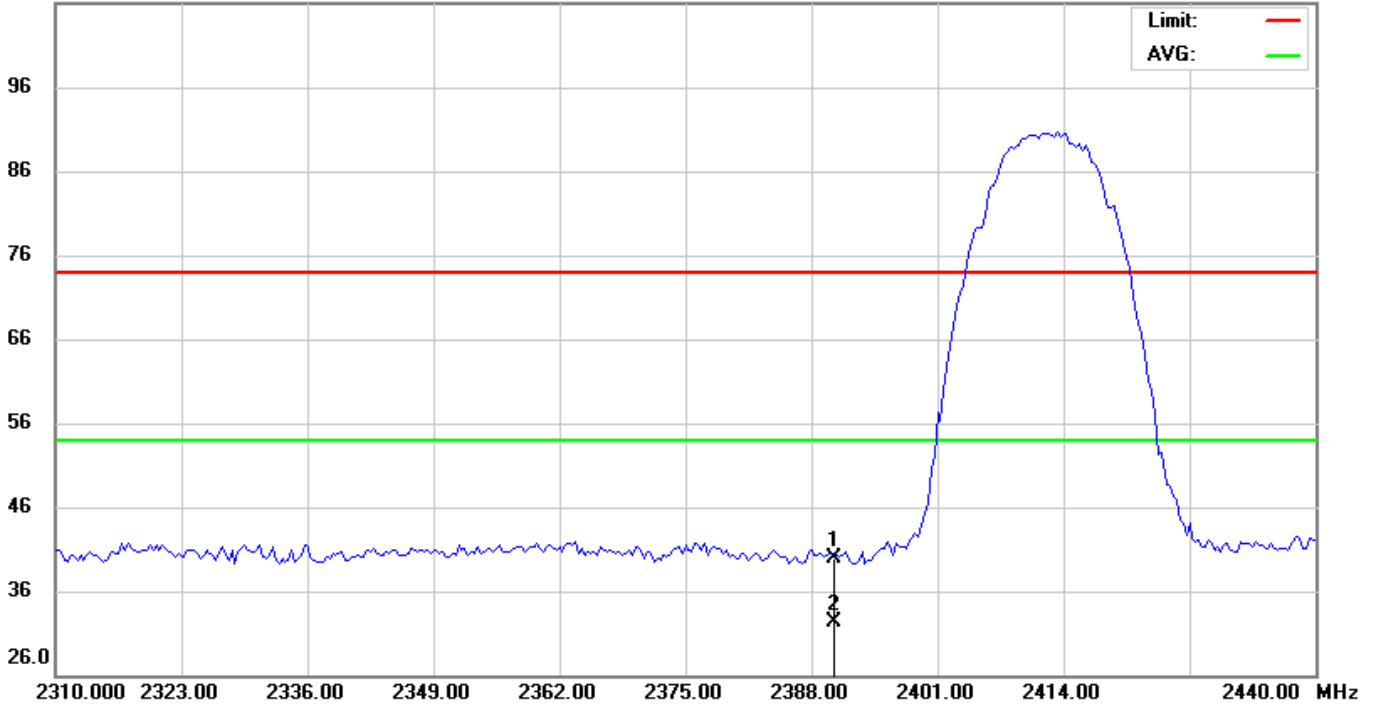

No.	Mk.	Freq.	Reading Level	Correct Factor	Measurement	Limit	Over	Antenna Height	Table Degree	
		MHz	dBuV	dB	dBuV/m	dBuV/m	dB	cm	degree	Comment
1		2390.000	48.40	-8.43	39.97	74.00	-34.03			peak
2	*	2390.000	40.70	-8.43	32.27	54.00	-21.73			AVG

*:Maximum data x:Over limit !:over margin

EUT:	DamaiBox 3.0	M/N:	DB3026US
Mode:	802.11b-CH1	Phase:	Horizontal
Test by:	John	Power:	DC 12V by Adapter
Temperature: / Humidity	23.7°C / 51.6%	Test date:	2016-07-18

106.0 dBuV/m

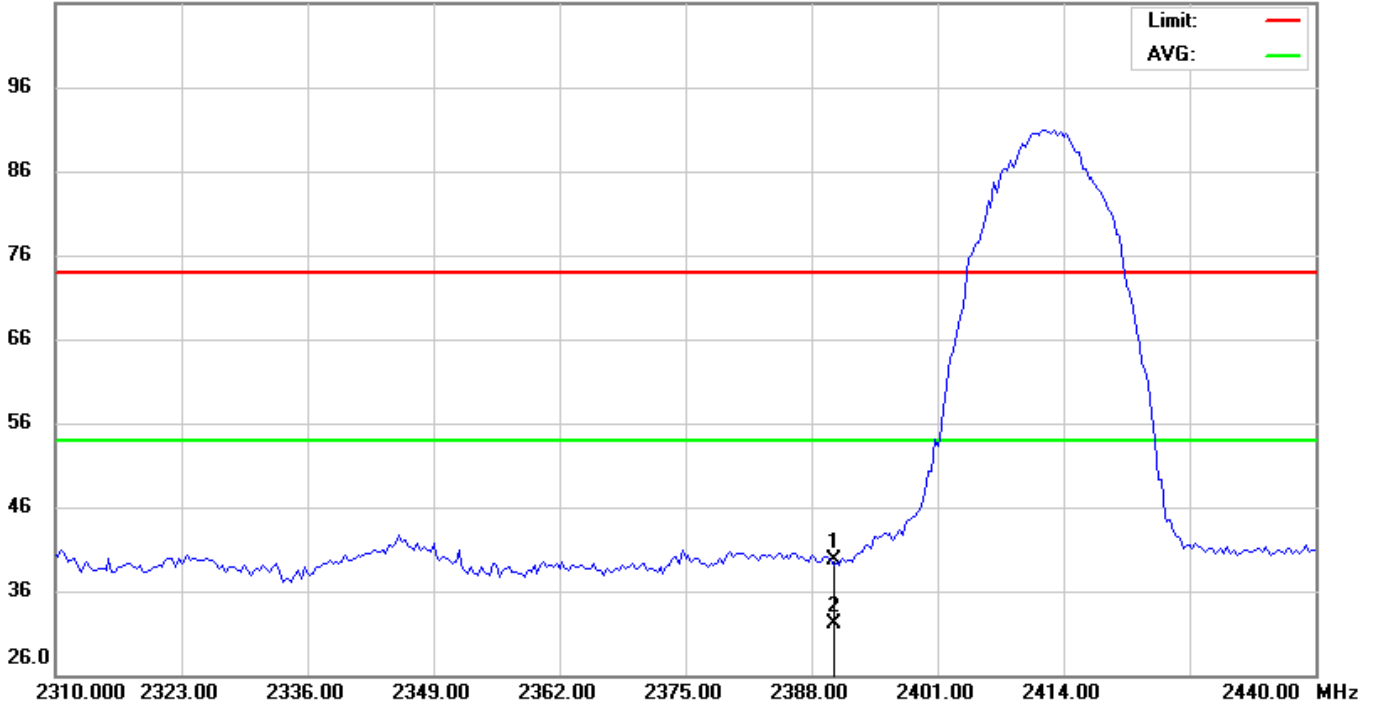

No.	Mk.	Freq. MHz	Reading Level dBuV	Correct Factor dB	Measure- ment dBuV/m	Limit dBuV/m	Over dB	Detector	Antenna Height cm	Table Degree degree	Comment
1		2390.000	48.20	-8.43	39.77	74.00	-34.23	peak			
2	*	2390.000	40.60	-8.43	32.17	54.00	-21.83	AVG			

*:Maximum data x:Over limit !:over margin

EUT:	DamaiBox 3.0	M/N:	DB3026US
Mode:	802.11b-CH11	Phase:	Vertical
Test by:	John	Power:	DC 12V by Adapter
Temperature: / Humidity	23.7°C / 51.6%	Test date:	2016-07-18

111.0 dBuV/m

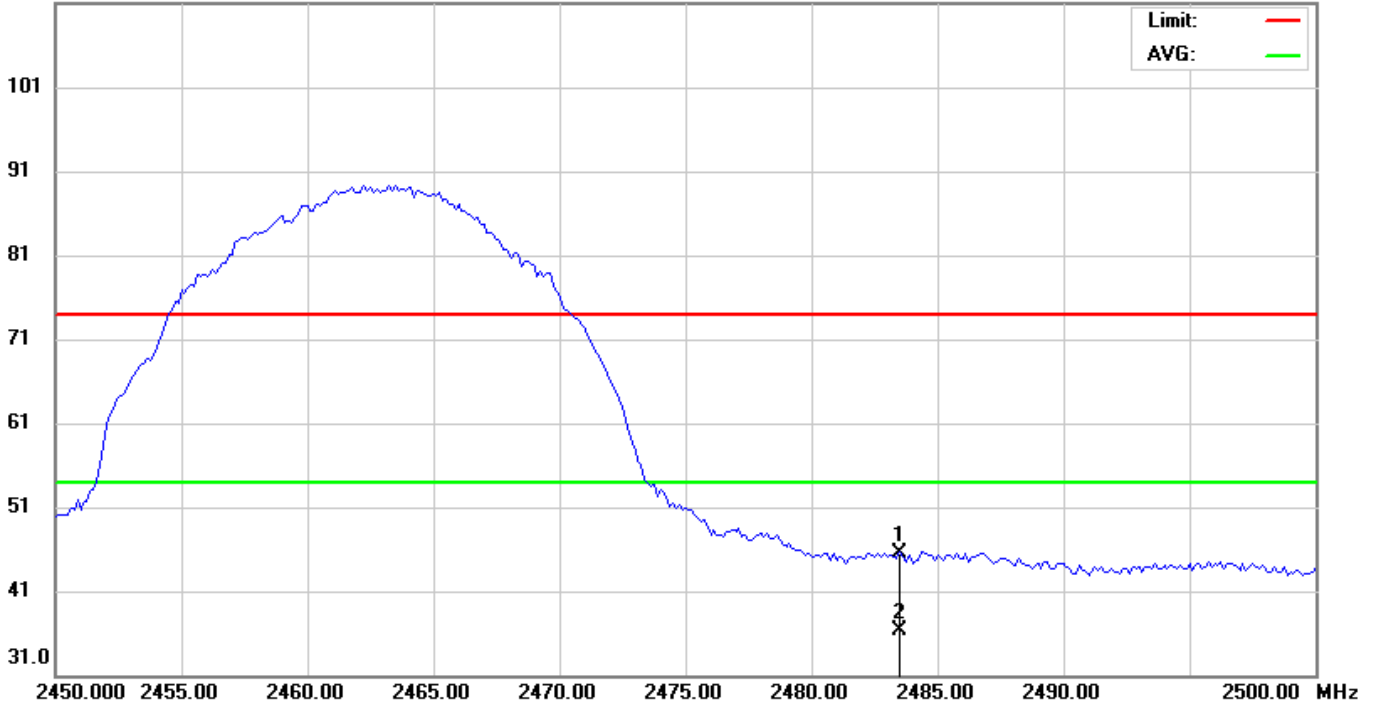

No.	Mk.	Freq. MHz	Reading Level dBuV	Correct Factor dB	Measure- ment dBuV/m	Limit dBuV/m	Over dB	Detector	Antenna Height cm	Table Degree	Comment
1		2483.500	53.70	-8.29	45.41	74.00	-28.59	peak			
2	*	2483.500	44.60	-8.29	36.31	54.00	-17.69	AVG			

*:Maximum data x:Over limit !:over margin

EUT:	DamaiBox 3.0	M/N:	DB3026US
Mode:	802.11b-CH11	Phase:	Horizontal
Test by:	John	Power:	DC 12V by Adapter
Temperature: / Humidity	23.7°C / 51.6%	Test date:	2016-07-18

111.0 dBuV/m

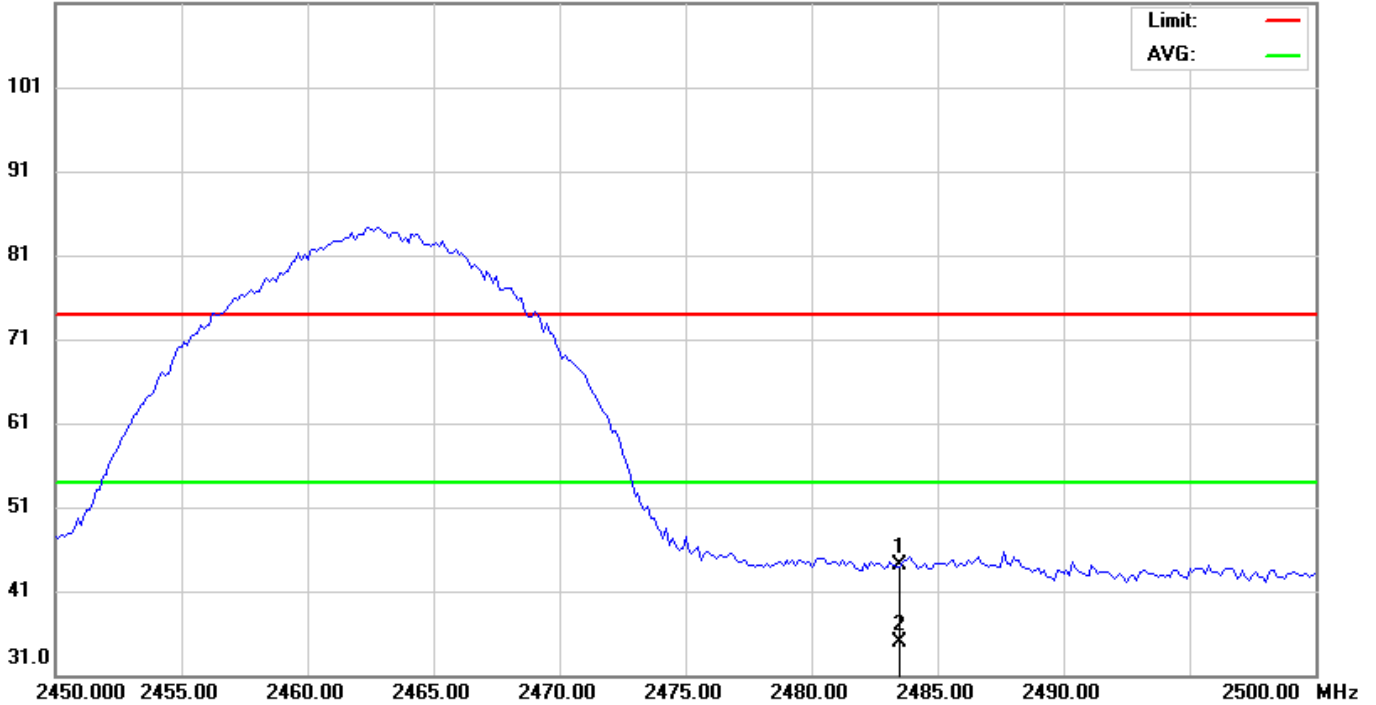

No.	Mk.	Freq. MHz	Reading Level dBuV	Correct Factor dB	Measure- ment dBuV/m	Limit dBuV/m	Over dB	Detector	Antenna Height cm	Table Degree	Comment
1		2483.500	52.30	-8.29	44.01	74.00	-29.99	peak			
2	*	2483.500	43.20	-8.29	34.91	54.00	-19.09	AVG			

*:Maximum data x:Over limit !:over margin

EUT:	DamaiBox 3.0	M/N:	DB3026US
Mode:	802.11g-CH1	Phase:	Vertical
Test by:	John	Power:	DC 12V by Adapter
Temperature: / Humidity	23.7°C / 51.6%	Test date:	2016-07-18

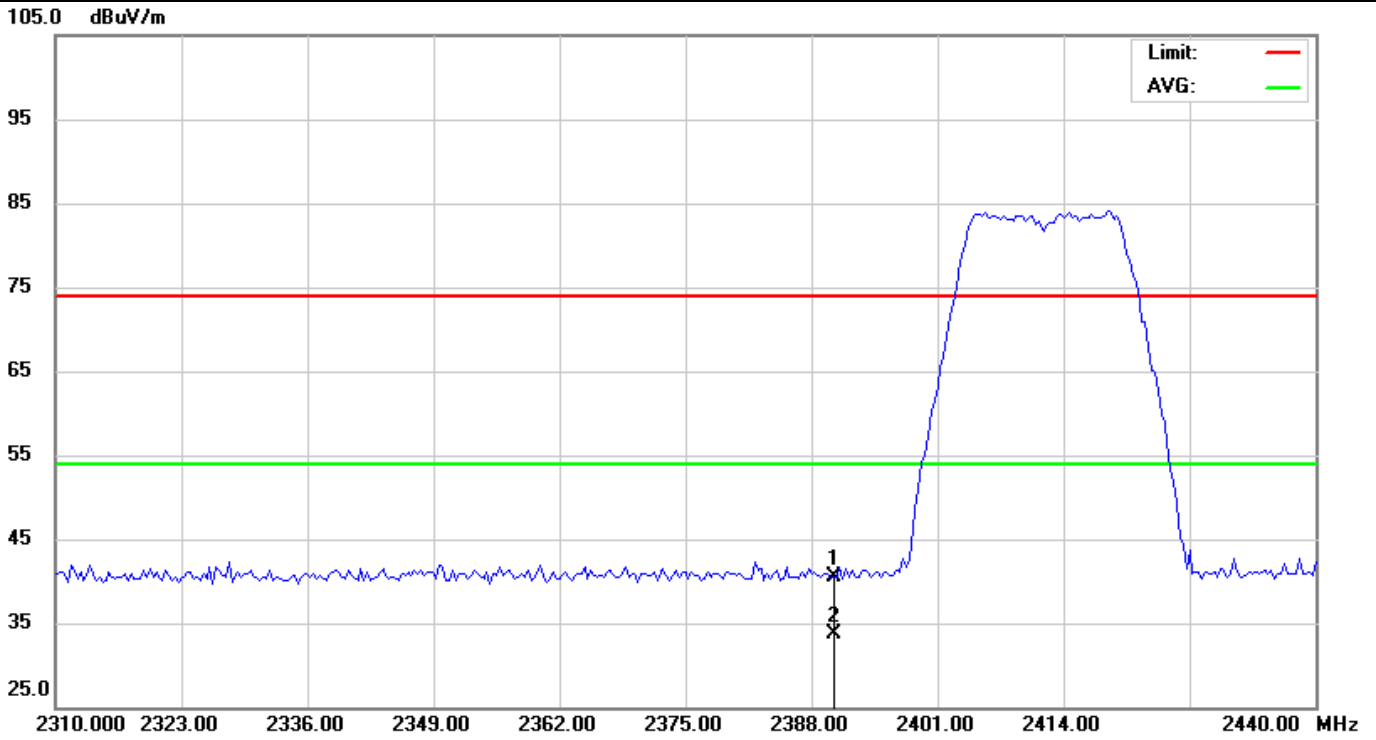

No.	Mk.	Freq.	Reading Level	Correct Factor	Measurement	Limit	Over	Antenna Height	Table Degree	
		MHz	dBuV	dB	dBuV/m	dBuV/m	dB	cm	degree	Comment
1		2390.000	48.93	-8.43	40.50	74.00	-33.50			peak
2	*	2390.000	42.15	-8.43	33.72	54.00	-20.28			AVG

*:Maximum data x:Over limit !:over margin

EUT:	DamaiBox 3.0	M/N:	DB3026US
Mode:	802.11g-CH1	Phase:	Horizontal
Test by:	John	Power:	DC 12V by Adapter
Temperature: / Humidity	23.7°C / 51.6%	Test date:	2016-07-18

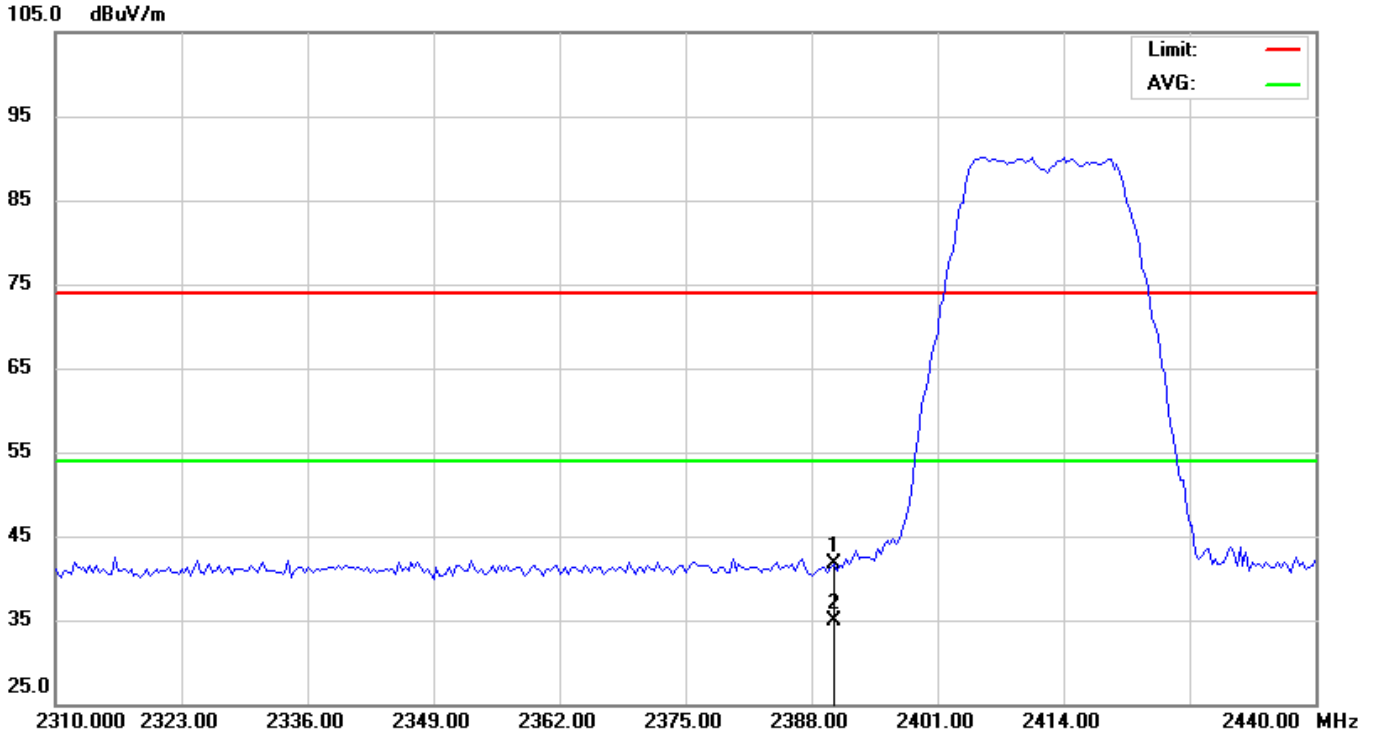

No.	Mk.	Freq. MHz	Reading Level dBuV	Correct Factor dB	Measure- ment dBuV/m	Limit dBuV/m	Over dB	Antenna Height cm	Table Degree degree	Comment
1		2390.000	50.05	-8.43	41.62	74.00	-32.38			peak
2	*	2390.000	43.26	-8.43	34.83	54.00	-19.17			AVG

*:Maximum data x:Over limit !:over margin

EUT:	DamaiBox 3.0	M/N:	DB3026US
Mode:	802.11g-CH11	Phase:	Vertical
Test by:	John	Power:	DC 12V by Adapter
Temperature: / Humidity	23.7°C / 51.6%	Test date:	2016-07-18

105.0 dBuV/m

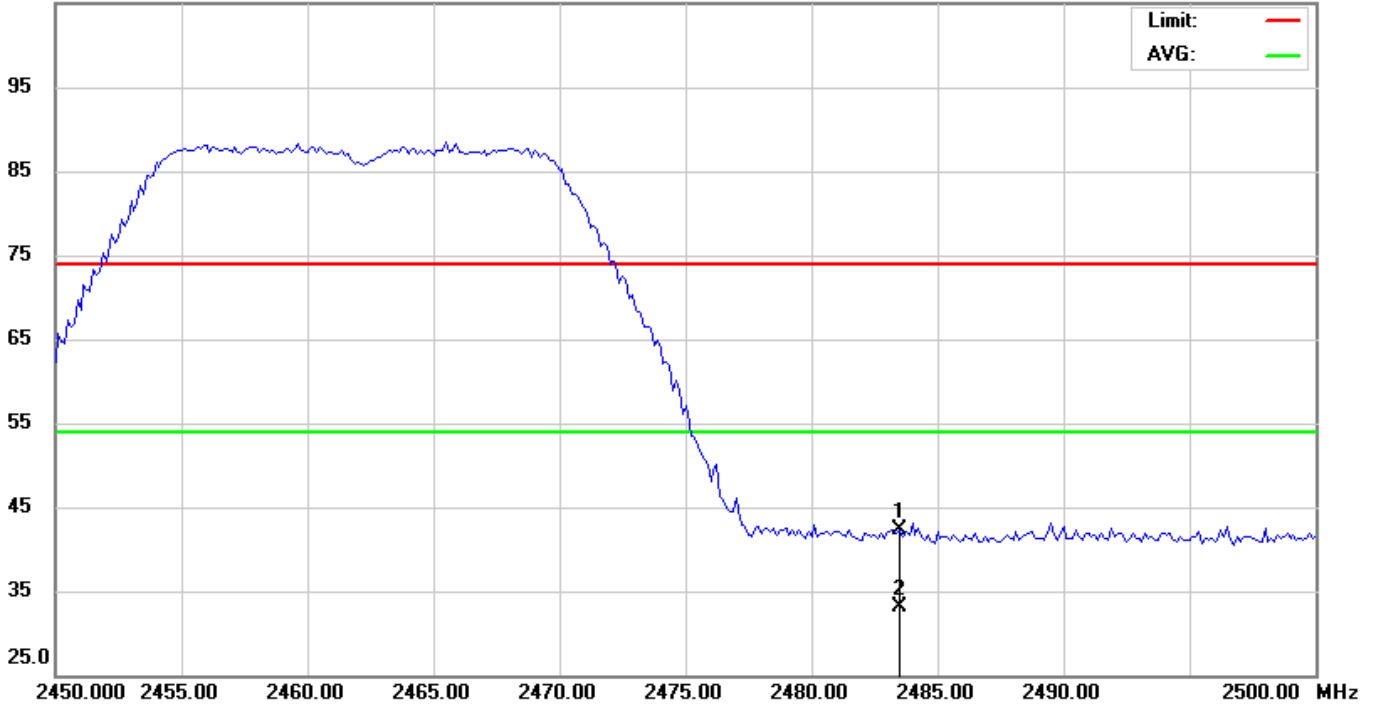

No.	Mk.	Freq. MHz	Reading Level dBuV	Correct Factor dB	Measure- ment dBuV/m	Limit dBuV/m	Over dB	Detector	Antenna Height cm	Table Degree degree	Comment
1		2483.500	50.64	-8.29	42.35	74.00	-31.65	peak			
2	*	2483.500	41.32	-8.29	33.03	54.00	-20.97	AVG			

*:Maximum data x:Over limit !:over margin

EUT:	DamaiBox 3.0	M/N:	DB3026US
Mode:	802.11g-CH11	Phase:	Horizontal
Test by:	John	Power:	DC 12V by Adapter
Temperature: / Humidity	23.7°C / 51.6%	Test date:	2016-07-18

105.0 dBuV/m

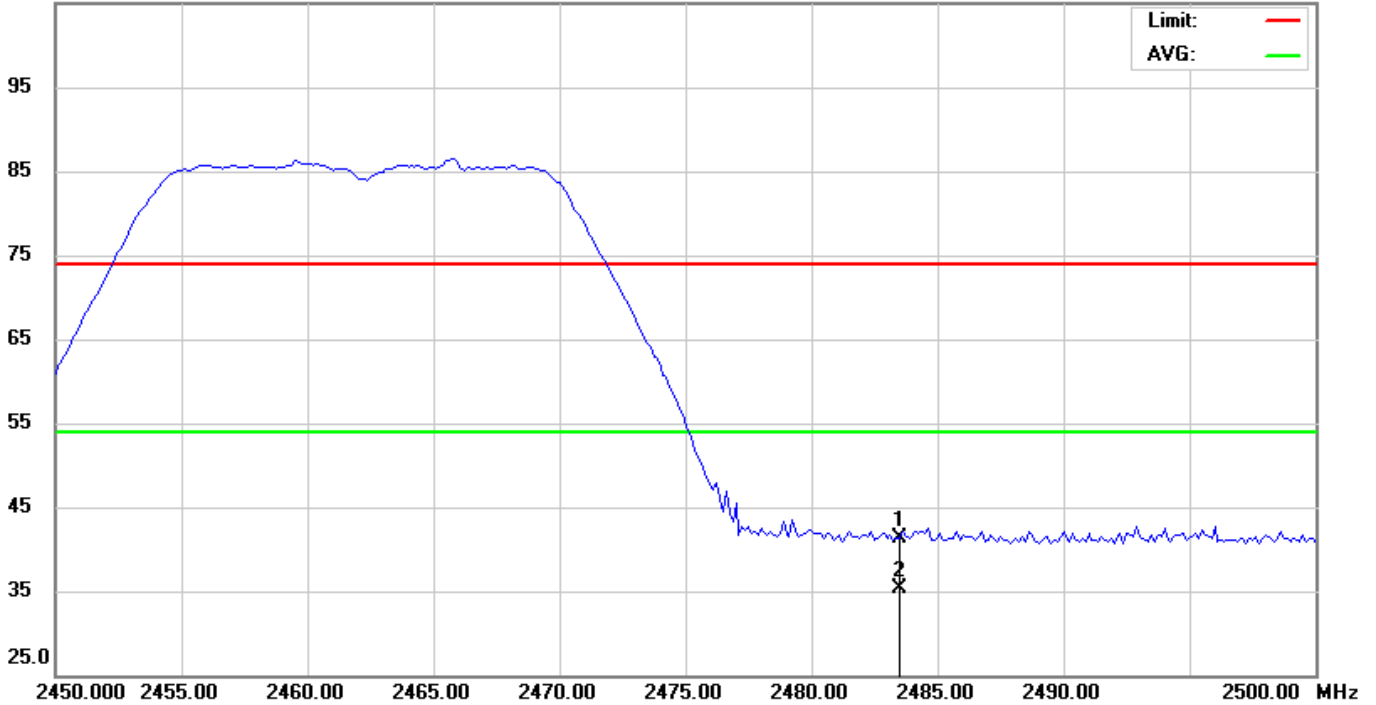

No.	Mk.	Freq.	Reading Level	Correct Factor	Measurement	Limit	Over	Antenna Height	Table Degree
		MHz	dBuV	dB	dBuV/m	dBuV/m	dB	cm	degree
1		2483.500	49.66	-8.29	41.37	74.00	-32.63		
2	*	2483.500	43.60	-8.29	35.31	54.00	-18.69		

*:Maximum data x:Over limit !:over margin

EUT:	DamaiBox 3.0	M/N:	DB3026US
Mode:	802.11n-CH1	Phase:	Vertical
Test by:	John	Power:	DC 12V by Adapter
Temperature: / Humidity	23.7°C / 51.6%	Test date:	2016-07-18

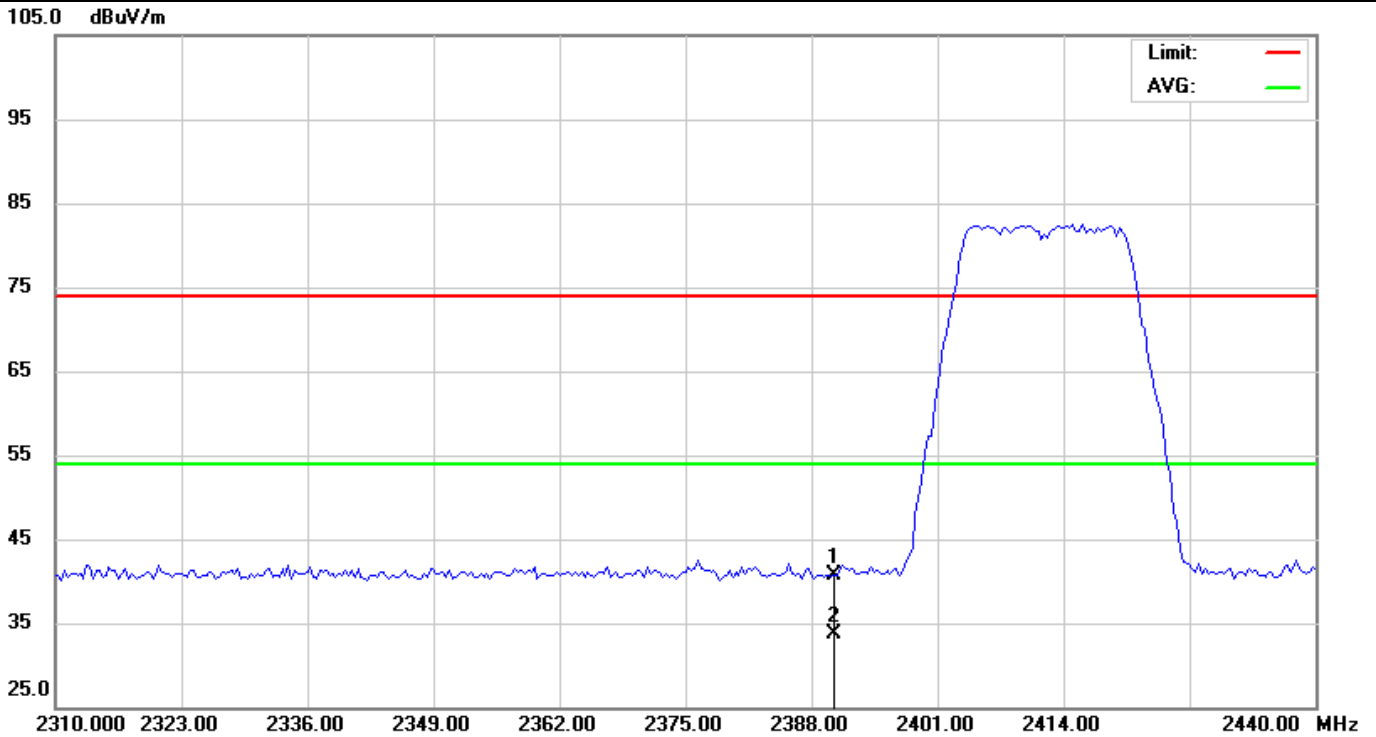

No.	Mk.	Freq.	Reading Level	Correct Factor	Measurement	Limit	Over	Antenna Height	Table Degree	
		MHz	dBuV	dB	dBuV/m	dBuV/m	dB	cm	degree	Comment
1		2390.000	49.09	-8.43	40.66	74.00	-33.34			peak
2	*	2390.000	42.06	-8.43	33.63	54.00	-20.37			AVG

*:Maximum data x:Over limit !:over margin

EUT:	DamaiBox 3.0	M/N:	DB3026US
Mode:	802.11n-CH1	Phase:	Horizontal
Test by:	John	Power:	DC 12V by Adapter
Temperature: / Humidity	23.7°C / 51.6%	Test date:	2016-07-18

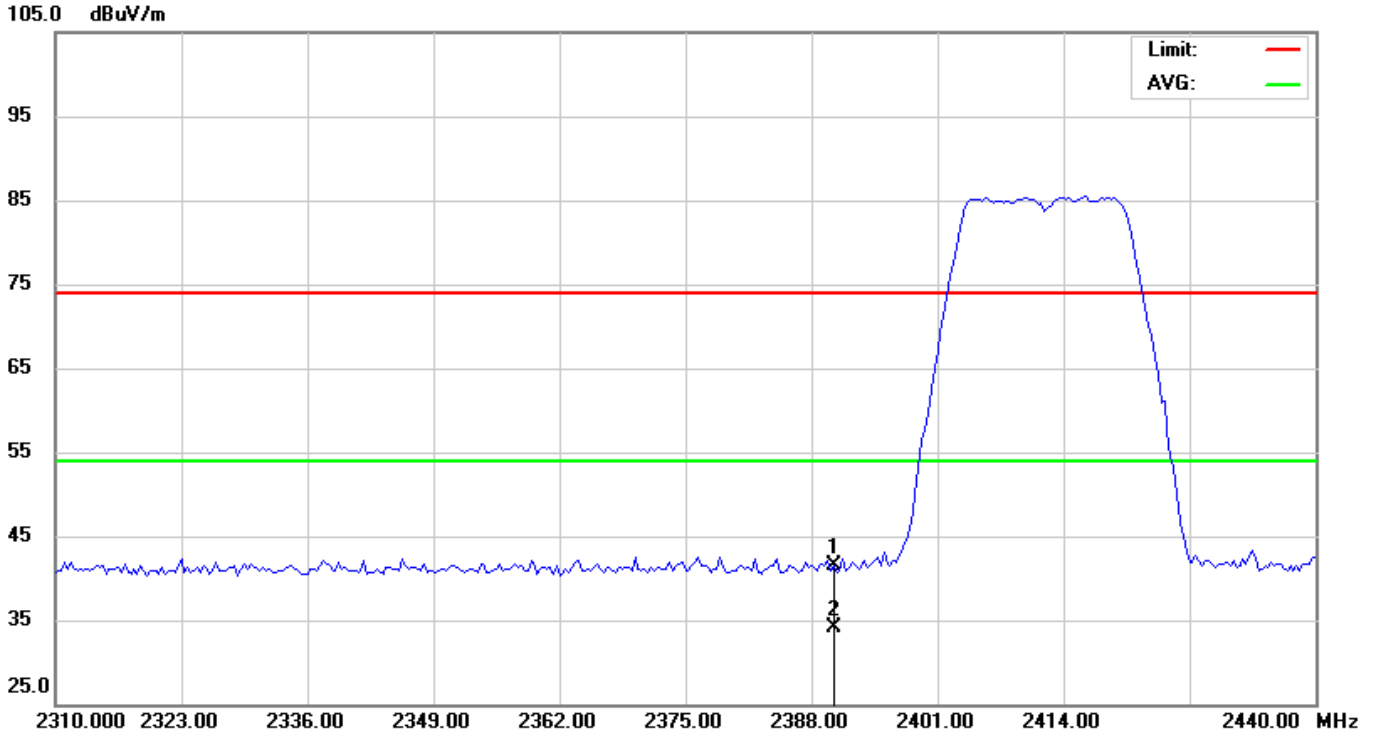

No.	Mk.	Freq.	Reading Level	Correct Factor	Measurement	Limit	Over	Antenna Height	Table Degree	
		MHz	dBuV	dB	dBuV/m	dBuV/m	dB	cm	degree	Comment
1		2390.000	49.89	-8.43	41.46	74.00	-32.54			peak
2	*	2390.000	42.56	-8.43	34.13	54.00	-19.87			AVG

*:Maximum data x:Over limit !:over margin

EUT:	DamaiBox 3.0	M/N:	DB3026US
Mode:	802.11n-CH11	Phase:	Vertical
Test by:	John	Power:	DC 12V by Adapter
Temperature: / Humidity	23.7°C / 51.6%	Test date:	2016-07-18

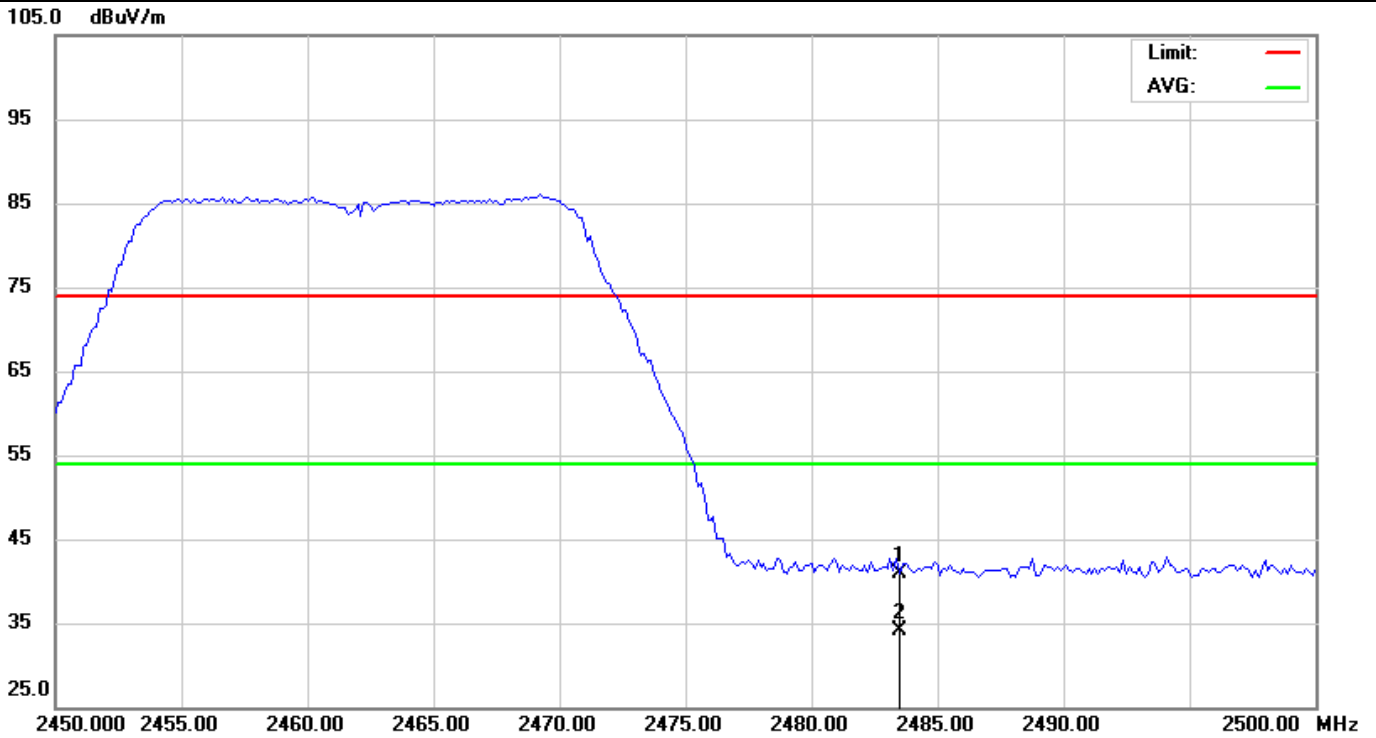

No.	Mk.	Freq.	Reading Level	Correct Factor	Measurement	Limit	Over	Antenna Height	Table Degree	
		MHz	dBuV	dB	dBuV/m	dBuV/m	dB	cm	degree	Comment
1		2483.500	49.29	-8.29	41.00	74.00	-33.00			peak
2	*	2483.500	42.39	-8.29	34.10	54.00	-19.90			AVG

*:Maximum data x:Over limit !:over margin

EUT:	DamaiBox 3.0	M/N:	DB3026US
Mode:	802.11n-CH11	Phase:	Horizontal
Test by:	John	Power:	DC 12V by Adapter
Temperature: / Humidity	23.7°C / 51.6%	Test date:	2016-07-18

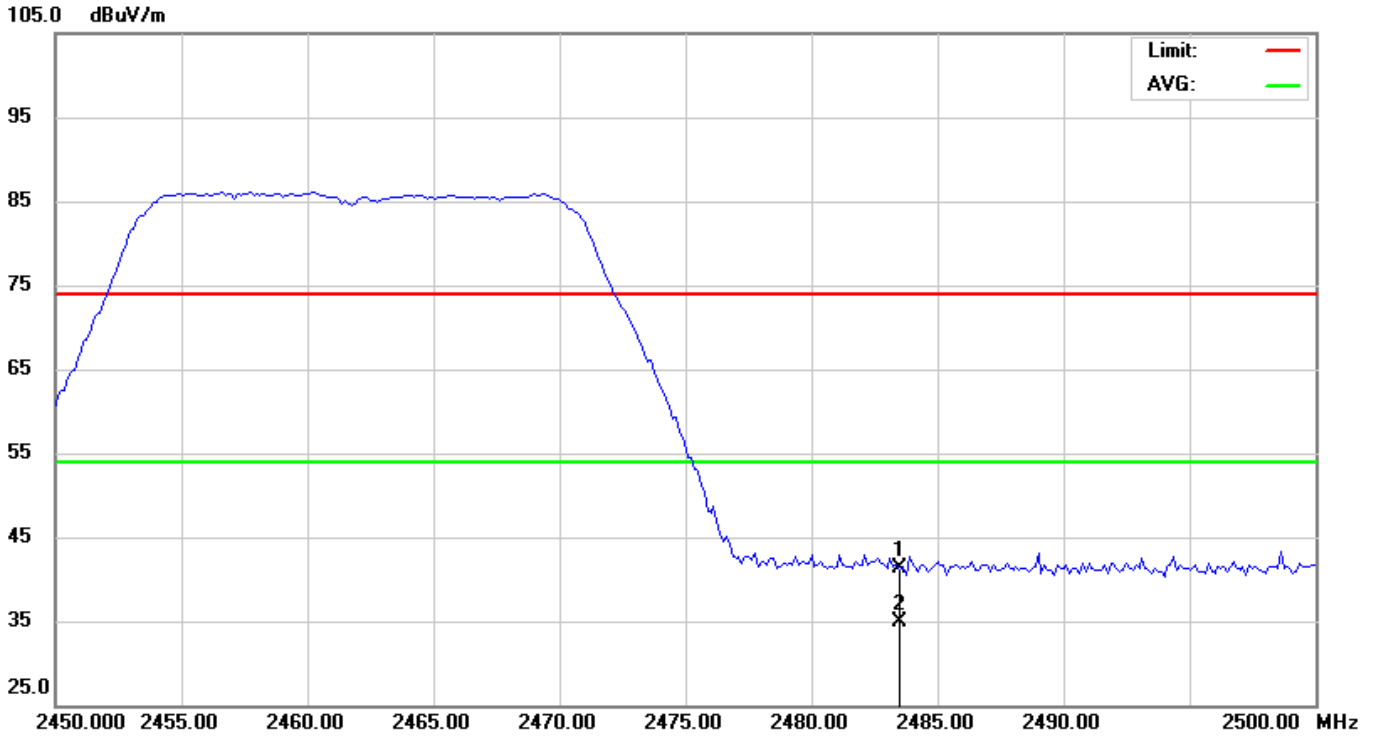

No.	Mk.	Freq. MHz	Reading Level dBuV	Correct Factor dB	Measure- ment dBuV/m	Limit dBuV/m	Over dB	Detector	Antenna Height cm	Table Degree degree	Comment
1		2483.500	49.49	-8.29	41.20	74.00	-32.80	peak			
2	*	2483.500	43.16	-8.29	34.87	54.00	-19.13	AVG			

*:Maximum data x:Over limit !:over margin

Antenna B:

EUT:	DamaiBox 3.0	M/N:	DB3026US
Mode:	802.11b-CH1	Phase:	Vertical
Test by:	John	Power:	DC 12V by Adapter
Temperature: / Humidity	23.7°C / 51.6%	Test date:	2016-07-18

106.0 dBuV/m

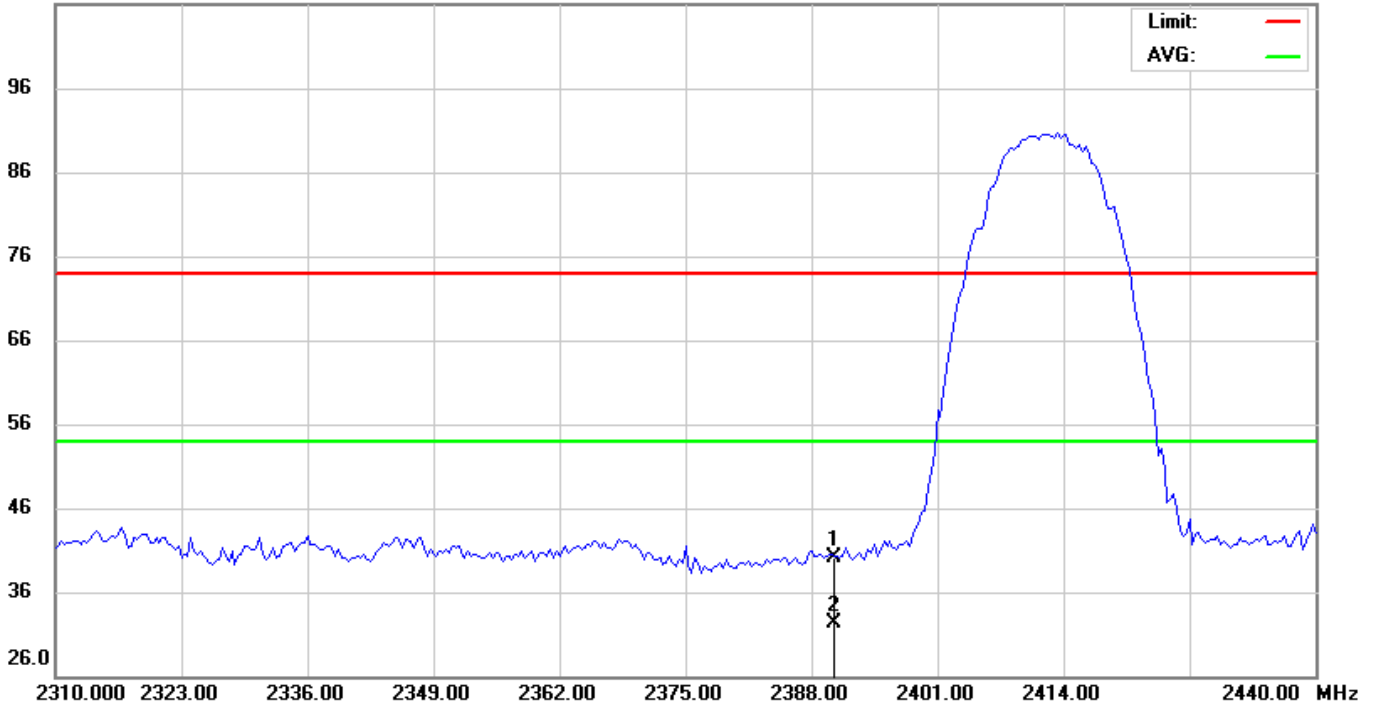

No.	Mk.	Freq.	Reading Level	Correct Factor	Measurement	Limit	Over	Antenna Height	Table Degree	
		MHz	dBuV	dB	dBuV/m	dBuV/m	dB	cm	degree	Comment
1		2390.000	48.50	-8.43	40.07	74.00	-33.93			peak
2	*	2390.000	40.70	-8.43	32.27	54.00	-21.73			AVG

*:Maximum data x:Over limit !:over margin

EUT:	DamaiBox 3.0	M/N:	DB3026US
Mode:	802.11b-CH1	Phase:	Horizontal
Test by:	John	Power:	DC 12V by Adapter
Temperature: / Humidity	23.7°C / 51.6%	Test date:	2016-07-18

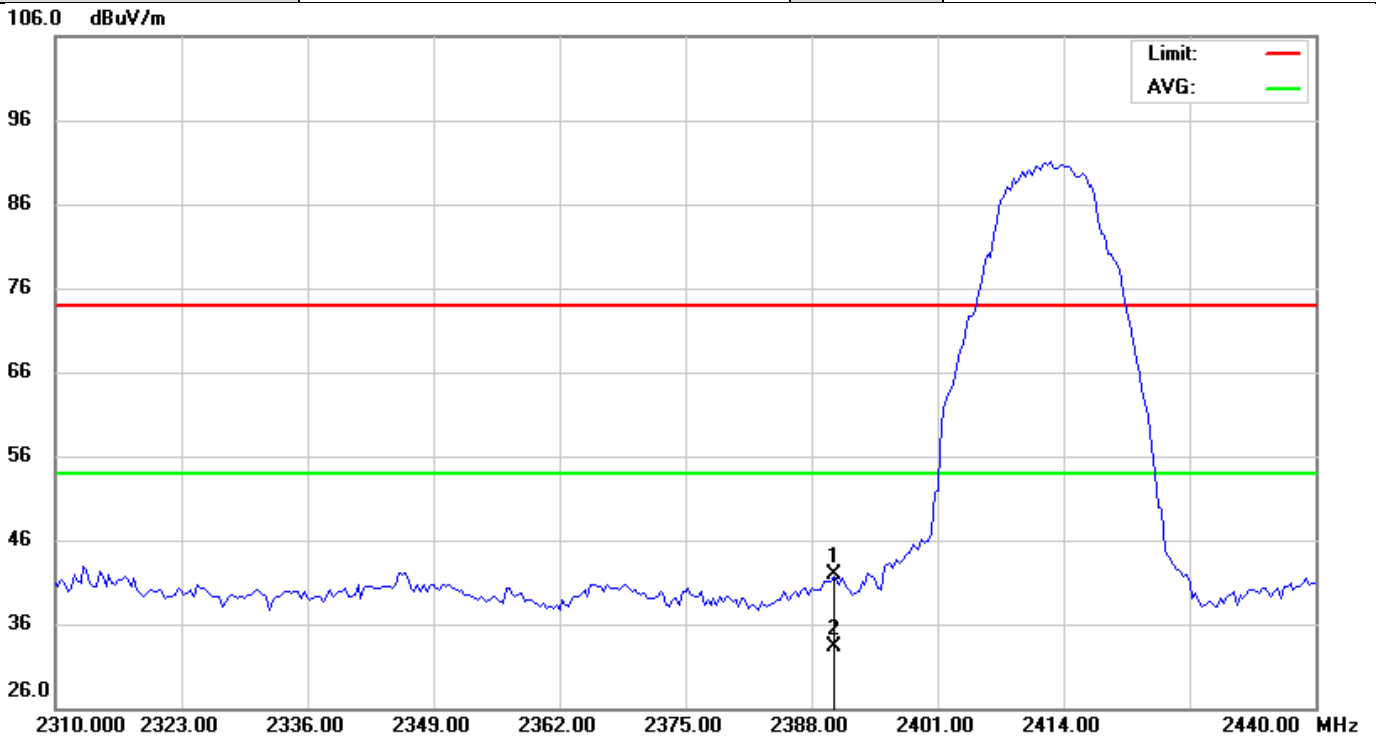

No.	Mk.	Freq. MHz	Reading Level dBuV	Correct Factor dB	Measure- ment dBuV/m	Limit dBuV/m	Over dB	Detector	Antenna Height cm	Table Degree degree	Comment
1		2390.000	50.30	-8.43	41.87	74.00	-32.13	peak			
2	*	2390.000	41.80	-8.43	33.37	54.00	-20.63	AVG			

*:Maximum data x:Over limit !:over margin

EUT:	DamaiBox 3.0	M/N:	DB3026US
Mode:	802.11b-CH11	Phase:	Vertical
Test by:	John	Power:	DC 12V by Adapter
Temperature: / Humidity	23.7°C / 51.6%	Test date:	2016-07-18

111.0 dBuV/m

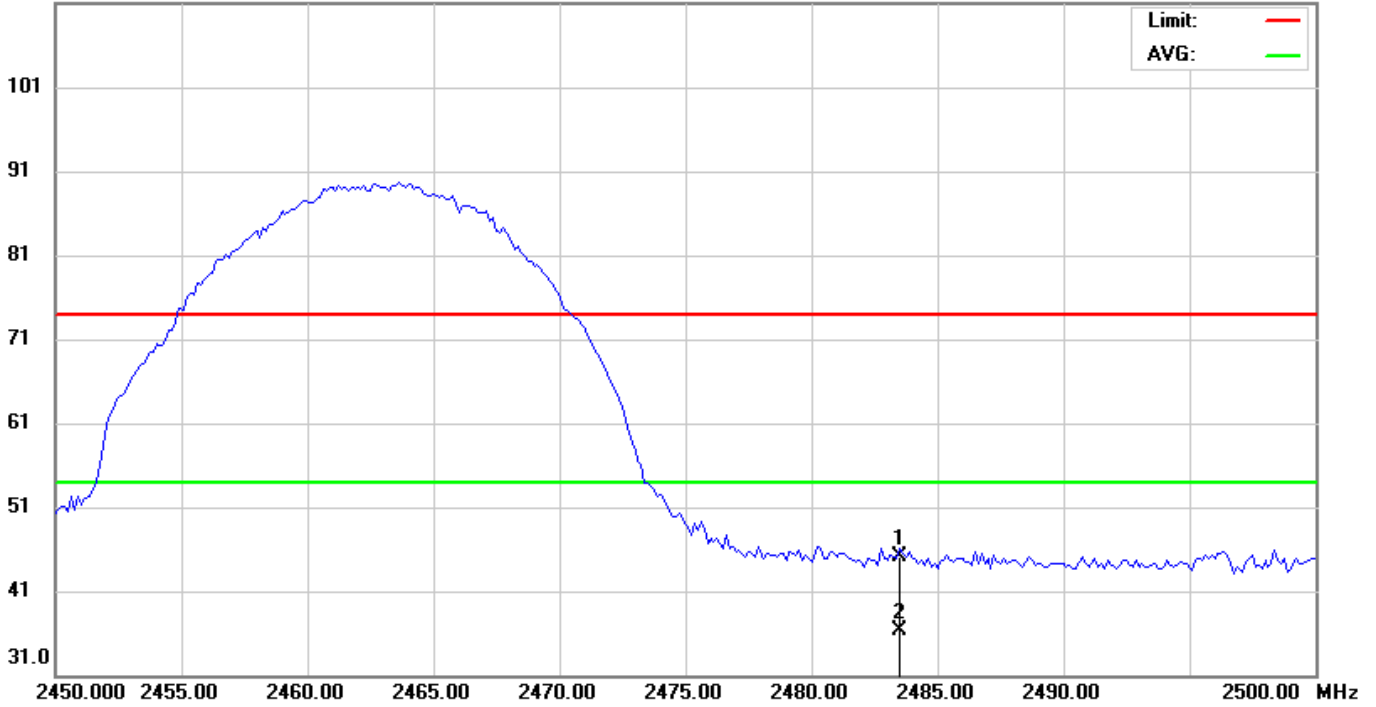

No.	Mk.	Freq.	Reading Level	Correct Factor	Measurement	Limit	Over	Antenna Height	Table Degree	
		MHz	dBuV	dB	dBuV/m	dBuV/m	dB	cm	degree	Comment
1		2483.500	53.40	-8.29	45.11	74.00	-28.89			peak
2	*	2483.500	44.60	-8.29	36.31	54.00	-17.69			AVG

*:Maximum data x:Over limit !:over margin

EUT:	DamaiBox 3.0	M/N:	DB3026US
Mode:	802.11b-CH11	Phase:	Horizontal
Test by:	John	Power:	DC 12V by Adapter
Temperature: / Humidity	23.7°C / 51.6%	Test date:	2016-07-18

111.0 dBuV/m

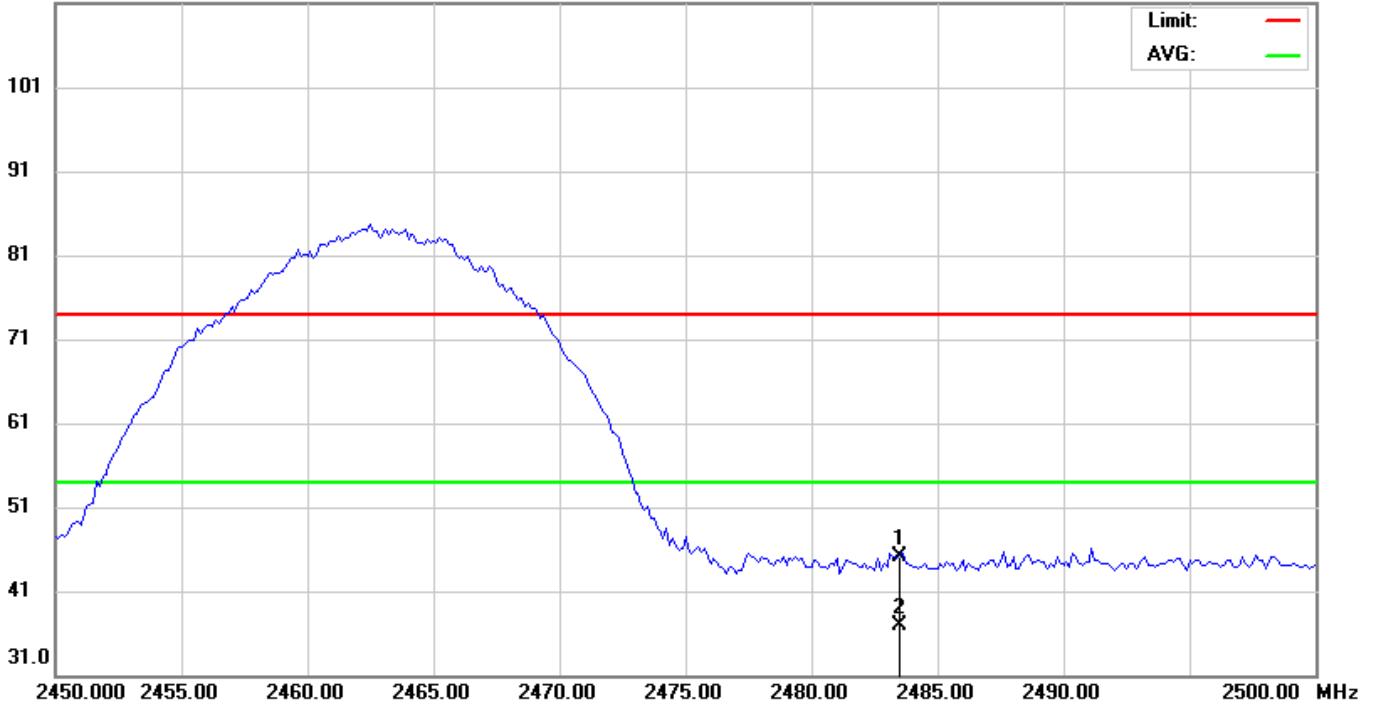

No.	Mk.	Freq. MHz	Reading Level dBuV	Correct Factor dB	Measure- ment dBuV/m	Limit dBuV/m	Over dB	Detector	Antenna Height cm	Table Degree degree	Comment
1		2483.500	53.30	-8.29	45.01	74.00	-28.99	peak			
2	*	2483.500	45.20	-8.29	36.91	54.00	-17.09	AVG			

*:Maximum data x:Over limit !:over margin

EUT:	DamaiBox 3.0	M/N:	DB3026US
Mode:	802.11g-CH1	Phase:	Vertical
Test by:	John	Power:	DC 12V by Adapter
Temperature: / Humidity	23.7°C / 51.6%	Test date:	2016-07-18

105.0 dBuV/m

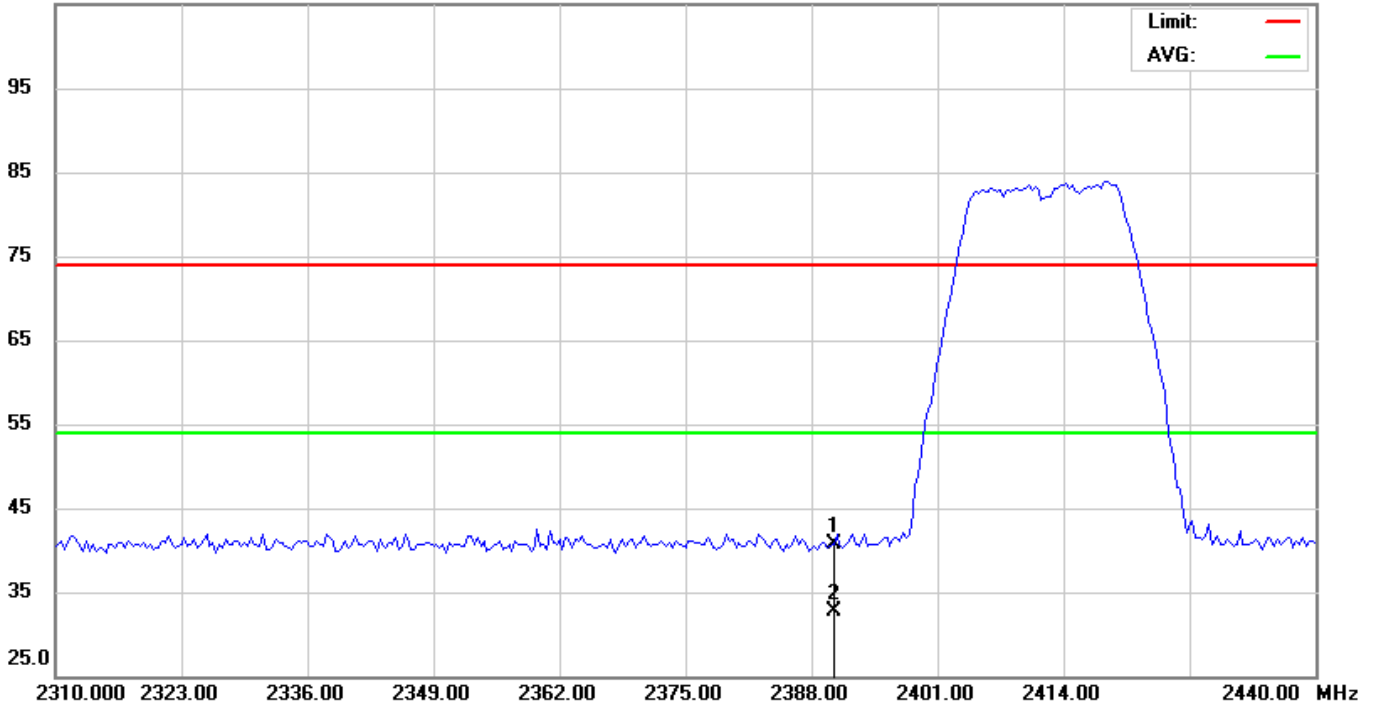

No.	Mk.	Freq.	Reading Level	Correct Factor	Measurement	Limit	Over	Antenna Height	Table Degree	
		MHz	dBuV	dB	dBuV/m	dBuV/m	dB	cm	degree	Comment
1		2390.000	49.22	-8.43	40.79	74.00	-33.21			peak
2	*	2390.000	41.10	-8.43	32.67	54.00	-21.33			AVG

*:Maximum data x:Over limit !:over margin

EUT:	DamaiBox 3.0	M/N:	DB3026US
Mode:	802.11g-CH1	Phase:	Horizontal
Test by:	John	Power:	DC 12V by Adapter
Temperature: / Humidity	23.7°C / 51.6%	Test date:	2016-07-18

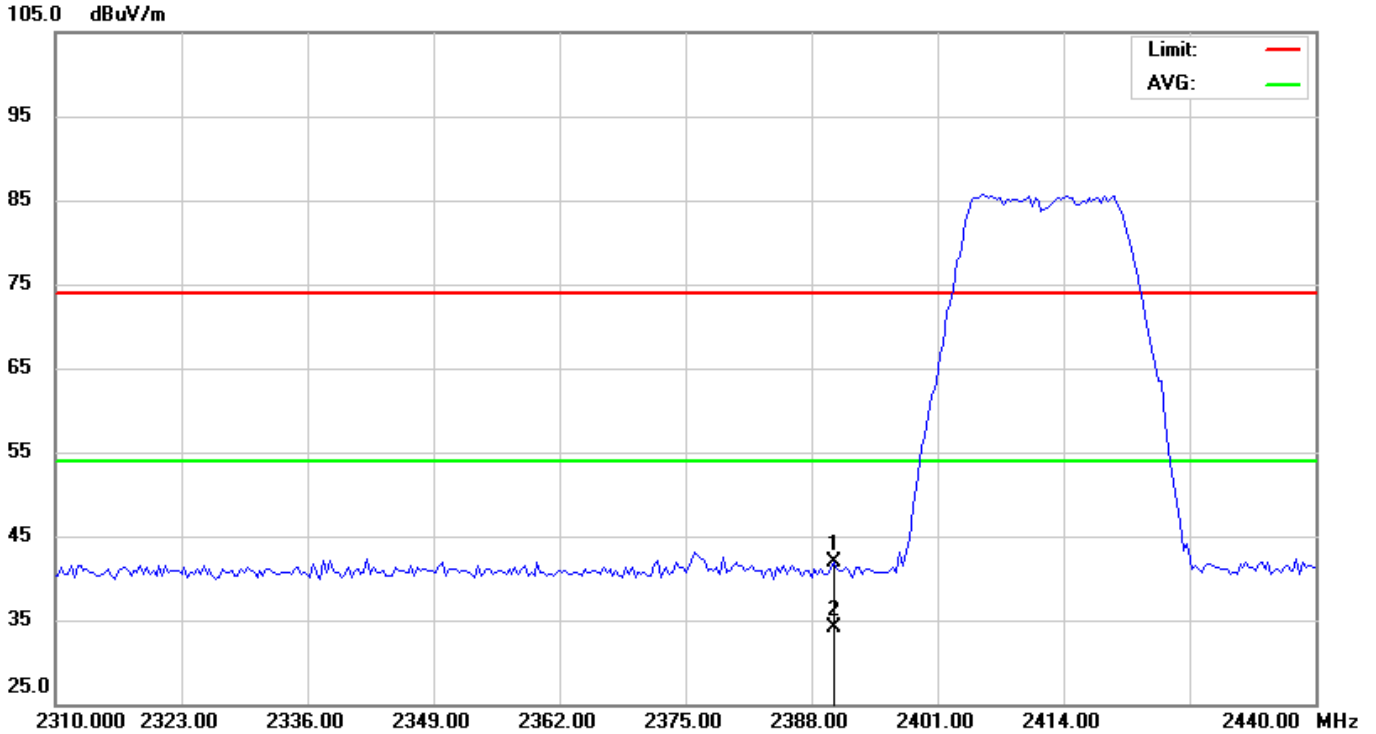

No.	Mk.	Freq. MHz	Reading Level dBuV	Correct Factor dB	Measure- ment dBuV/m	Limit dBuV/m	Over dB	Antenna Height cm	Table Degree degree	Comment
1		2390.000	50.27	-8.43	41.84	74.00	-32.16			peak
2	*	2390.000	42.50	-8.43	34.07	54.00	-19.93			AVG

*:Maximum data x:Over limit !:over margin

EUT:	DamaiBox 3.0	M/N:	DB3026US
Mode:	802.11g-CH11	Phase:	Vertical
Test by:	John	Power:	DC 12V by Adapter
Temperature: / Humidity	23.7°C / 51.6%	Test date:	2016-07-18

105.0 dBuV/m

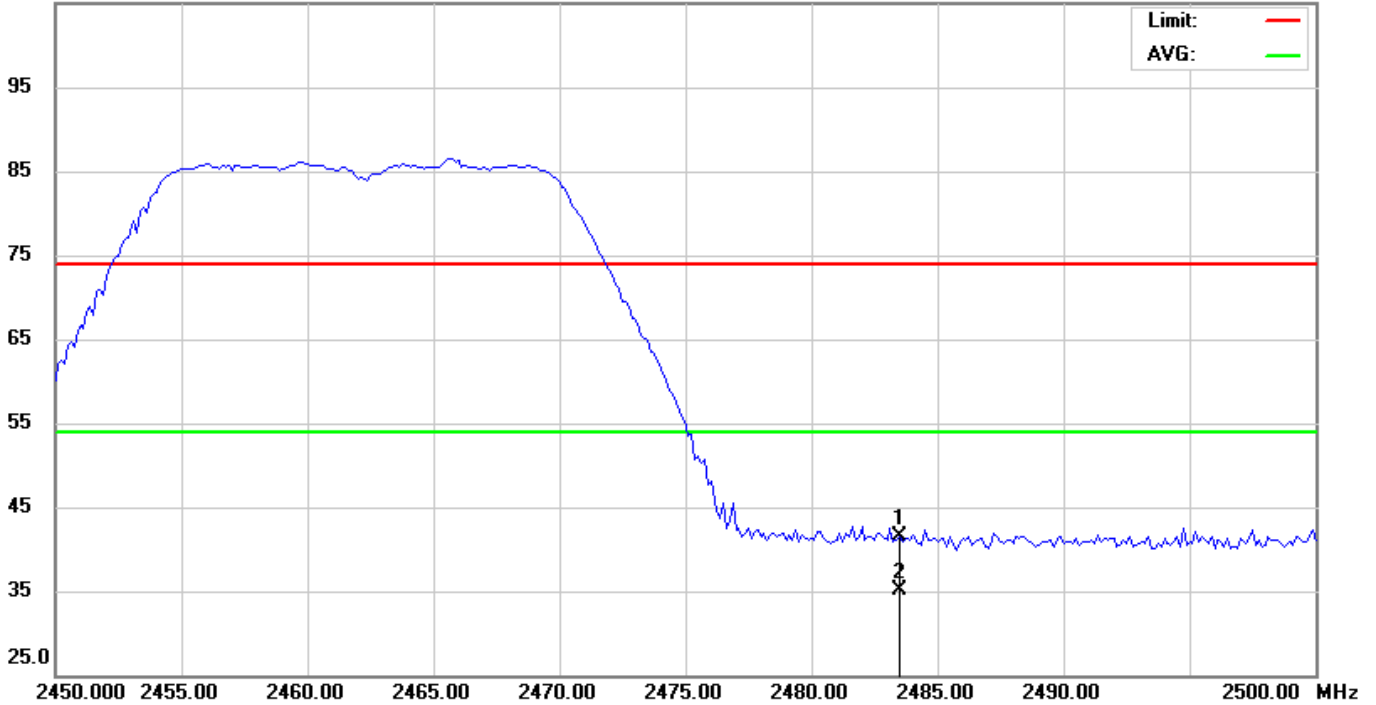

No.	Mk.	Freq. MHz	Reading Level dBuV	Correct Factor dB	Measure- ment dBuV/m	Limit dBuV/m	Over dB	Detector	Antenna Height cm	Table Degree degree	Comment
1		2483.500	49.77	-8.29	41.48	74.00	-32.52	peak			
2	*	2483.500	43.31	-8.29	35.02	54.00	-18.98	AVG			

*:Maximum data x:Over limit !:over margin

EUT:	DamaiBox 3.0	M/N:	DB3026US
Mode:	802.11g-CH11	Phase:	Horizontal
Test by:	John	Power:	DC 12V by Adapter
Temperature: / Humidity	23.7°C / 51.6%	Test date:	2016-07-18

105.0 dBuV/m

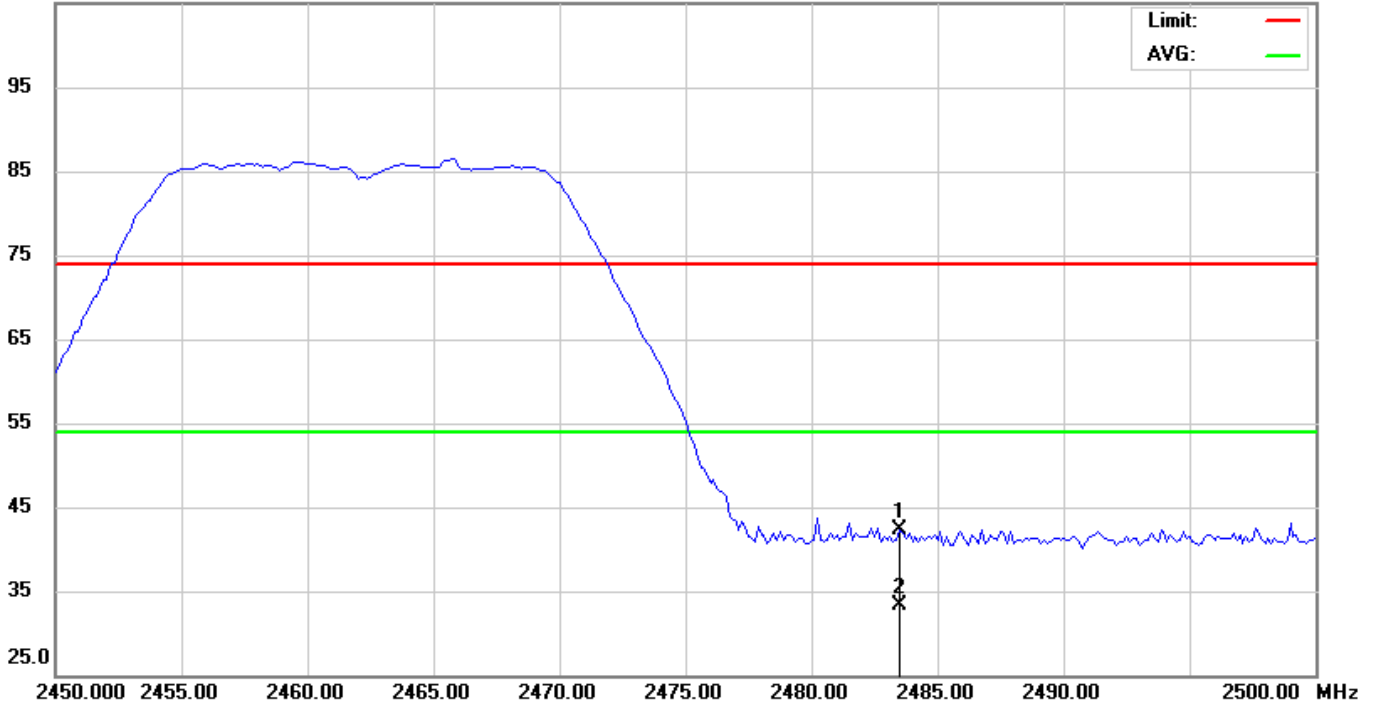

No.	Mk.	Freq. MHz	Reading Level dBuV	Correct Factor dB	Measure- ment dBuV/m	Limit dBuV/m	Over dB	Detector	Antenna Height cm	Table Degree degree	Comment
1		2483.500	50.49	-8.29	42.20	74.00	-31.80	peak			
2	*	2483.500	41.58	-8.29	33.29	54.00	-20.71	AVG			

*:Maximum data x:Over limit !:over margin

EUT:	DamaiBox 3.0	M/N:	DB3026US
Mode:	802.11n-CH1	Phase:	Vertical
Test by:	John	Power:	DC 12V by Adapter
Temperature: / Humidity	23.7°C / 51.6%	Test date:	2016-07-18

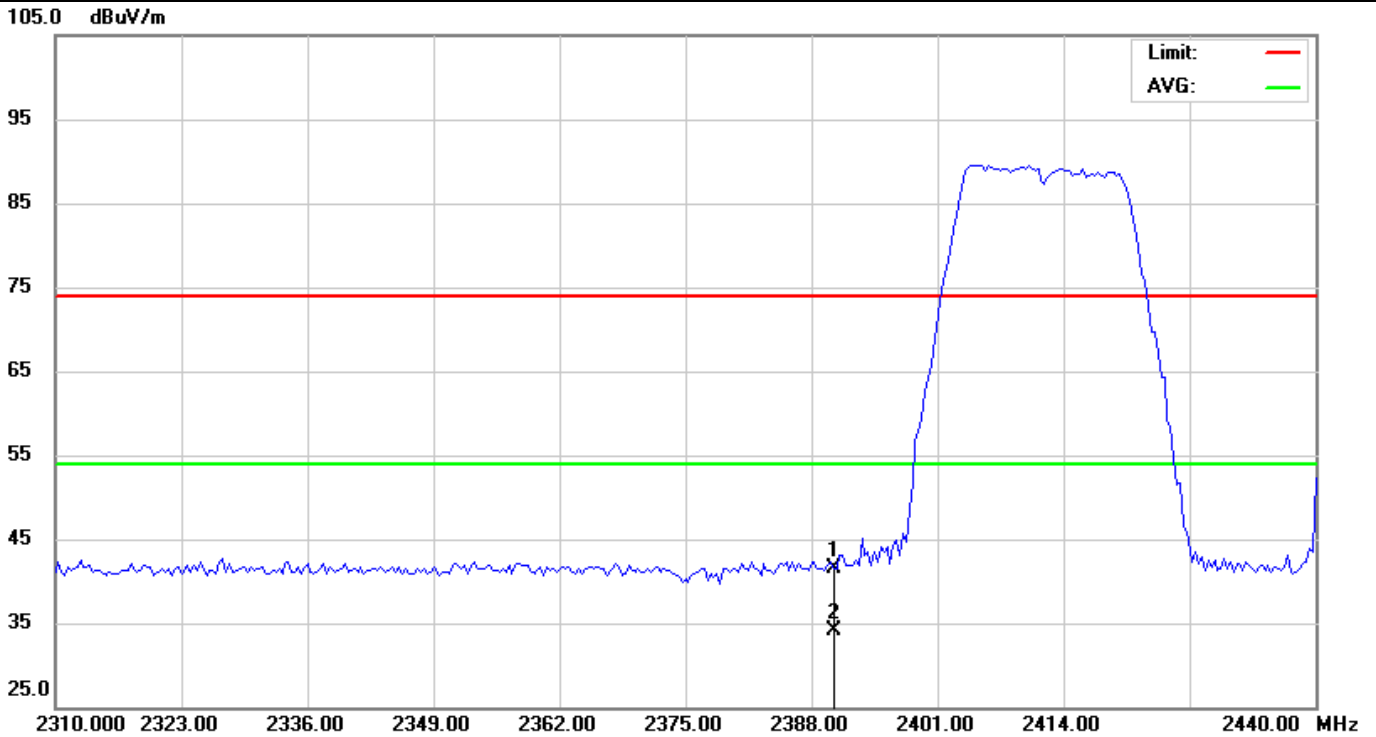

No.	Mk.	Freq.	Reading Level	Correct Factor	Measurement	Limit	Over	Antenna Height	Table Degree	
		MHz	dBuV	dB	dBuV/m	dBuV/m	dB	cm	degree	Comment
1		2390.000	49.95	-8.43	41.52	74.00	-32.48			peak
2	*	2390.000	42.56	-8.43	34.13	54.00	-19.87			AVG

*:Maximum data x:Over limit !:over margin

EUT:	DamaiBox 3.0	M/N:	DB3026US
Mode:	802.11n-CH1	Phase:	Horizontal
Test by:	John	Power:	DC 12V by Adapter
Temperature: / Humidity	23.7°C / 51.6%	Test date:	2016-07-18

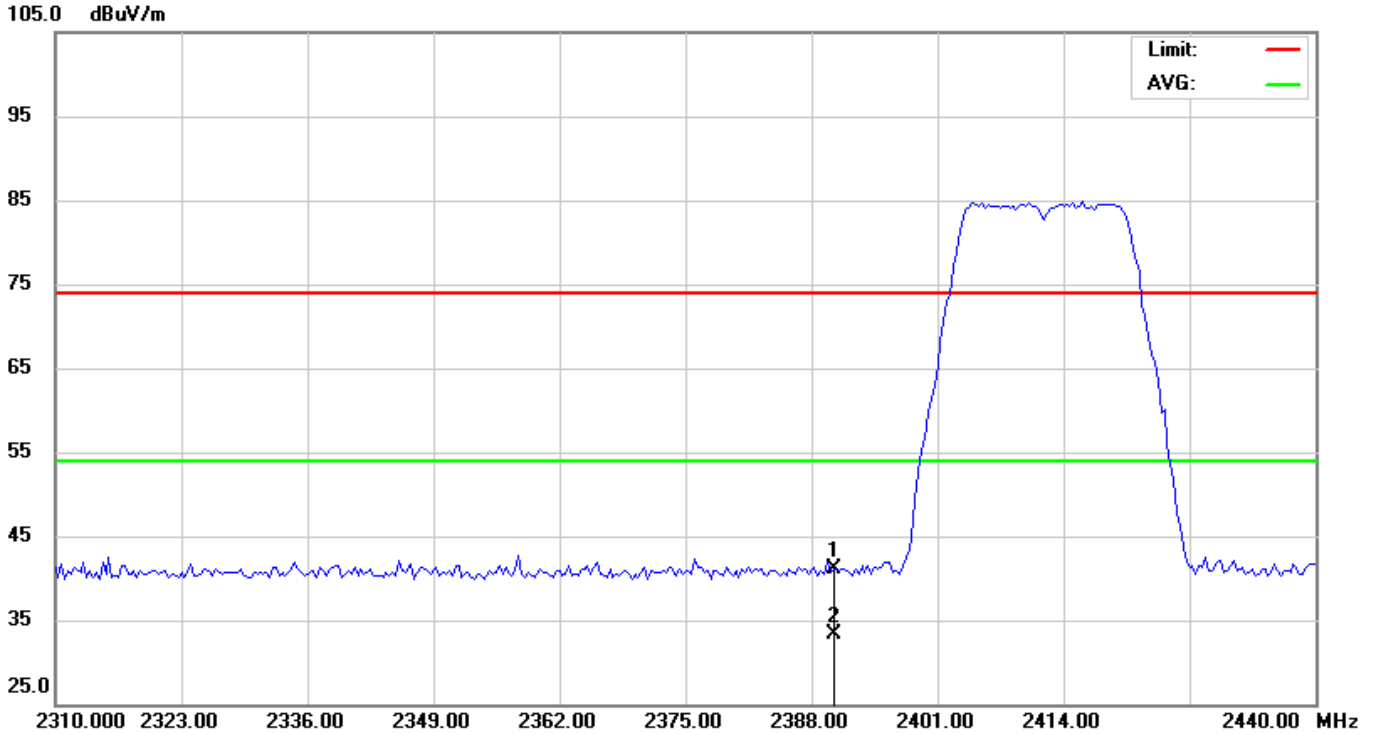

No.	Mk.	Freq. MHz	Reading Level dBuV	Correct Factor dB	Measure- ment dBuV/m	Limit dBuV/m	Over dB	Detector	Antenna Height cm	Table Degree degree	Comment
1		2390.000	49.46	-8.43	41.03	74.00	-32.97	peak			
2	*	2390.000	41.65	-8.43	33.22	54.00	-20.78	AVG			

*:Maximum data x:Over limit !:over margin

EUT:	DamaiBox 3.0	M/N:	DB3026US
Mode:	802.11n-CH11	Phase:	Vertical
Test by:	John	Power:	DC 12V by Adapter
Temperature: / Humidity	23.7°C / 51.6%	Test date:	2016-07-18

105.0 dBuV/m

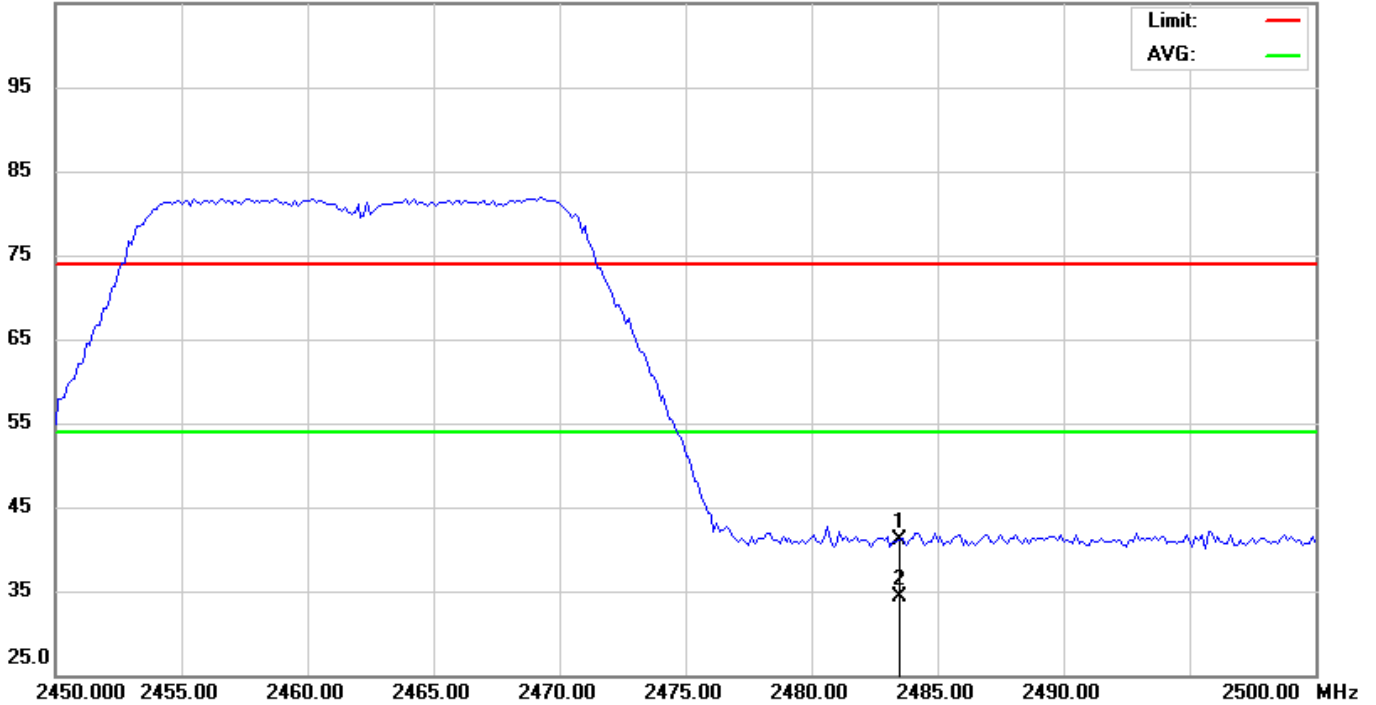

No.	Mk.	Freq.	Reading Level	Correct Factor	Measurement	Limit	Over	Antenna Height	Table Degree
		MHz	dBuV	dB	dBuV/m	dBuV/m	dB	cm	degree
1		2483.500	49.39	-8.29	41.10	74.00	-32.90		
2	*	2483.500	42.64	-8.29	34.35	54.00	-19.65		

*:Maximum data x:Over limit !:over margin

EUT:	DamaiBox 3.0	M/N:	DB3026US
Mode:	802.11n-CH11	Phase:	Horizontal
Test by:	John	Power:	DC 12V by Adapter
Temperature: / Humidity	23.7°C / 51.6%	Test date:	2016-07-18

105.0 dBuV/m

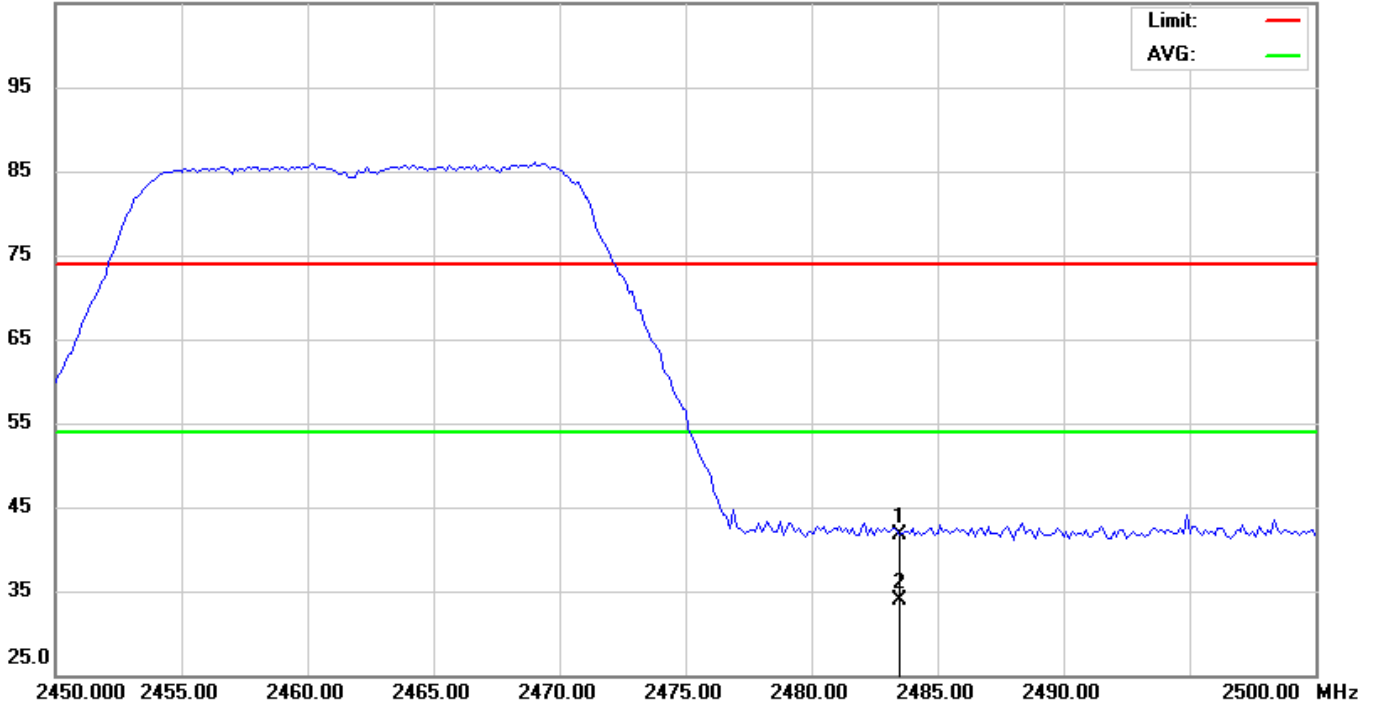

No.	Mk.	Freq.	Reading Level	Correct Factor	Measurement	Limit	Over	Antenna Height	Table Degree	
		MHz	dBuV	dB	dBuV/m	dBuV/m	dB	cm	degree	Comment
1		2483.500	49.96	-8.29	41.67	74.00	-32.33			peak
2	*	2483.500	42.16	-8.29	33.87	54.00	-20.13			AVG

*:Maximum data x:Over limit !:over margin

End of Report