



**CENTRE OF TESTING SERVICE
INTERNATIONAL**

OPERATE ACCORDING TO ISO/IEC 17025

FCC ID TEST REPORT

TEST REPORT NUMBER : CGZ3150525-00596-EF



CENTRE OF TESTING SERVICE CO., LTD.

A101, No.65, Zhuji Highway, Tianhe District, Guangzhou, China



**TEST REPORT For FCC ID
47 CFR PART 15 OCT, 2014**

Report Reference No. CGZ3150525-00596-EF
Date of issue 10 July 2015

Testing Laboratory Name **CENTRE OF TESTING SERVICE CO., LTD.**
Address..... A101, No.65, Zhuji Highway,Tianhe District, Guangzhou, China
Testing location/ procedure Full application of Harmonised standards
 Partial application of Harmonised standards
 Other standard testing method

Applicant's name Mofi Network Inc.
Address..... 119 Wanda St Bradford, ON, L3Z-2A6, Canada

Test specification
Standard **47 CFR PART 15 OCT, 2014**

Test Report Form No. CTSEMC-1.0
TRF Originator CENTRE OF TESTING SERVICE CO., LTD.
Master TRF Dated 2009-01

CENTRE OF TESTING SERVICE CO., LTD. All rights reserved.
 This publication may be reproduced in whole or in part for non-commercial purposes as long as the CENTRE OF TESTING SERVICE CO., LTD. is acknowledged as copyright owner and source of the material. CENTRE OF TESTING SERVICE CO., LTD takes no responsibility for and will not assume liability for damages resulting from the reader's interpretation of the reproduced material due to its placement and context.

Test item description..... : Wireless Router
Trade Mark..... Mofi
Manufacturer..... /
Model/Type reference..... MOFI4500-4GXeLTE
Ratings..... DC 12V by Adapter;
 Adapter Input: AC 100-240V, 47/63Hz; Output:DC 12V
Operating Frequency 802.11b/g/n(20M):2412.0 MHz~2462.0 MHz
 802.11n(40MHz):2422.0 MHz ~2452.0 MHz
Result **Positive**

Compiled by:

 Kate zhang / Fileadministrators

Supervised by:

 Duke yang / Technique principal

Approved by:

 Vincent yao / Manager

Copyright of this report is owned by Centre of Testing Service and may not be reproduced other than in full except with the written approval of the issuing Company.



FCC ID -- TEST REPORT

Test Report No. : CGZ3150525-00596-EF	10 July 2015 Date of issue
--	-------------------------------

Type / Model.....	MOFI4500-4GXeLTE
EUT.....	Wireless Router
Applicant	Mofi Network Inc.
Address.....	119 Wanda St Bradford, ON, L3Z-2A6, Canada
Telephone.....	+1-800-586-0345
Fax.....	/
Contact.....	Ravin Ramkissoon
Manufacturer	/
Address.....	/
Telephone.....	/
Fax.....	/
Contact.....	/
Factory	/
Address.....	/
Telephone.....	/
Fax.....	/
Contact.....	/

Test Result according to the standards on page 1: PASSED
--

The test report merely corresponds to the test sample.
It is not permitted to copy extracts of these test result without the written permission of the test laboratory.

Copyright of this report is owned by Centre of Testing Service and may not be reproduced other than in full except with the written approval of the issuing Company.

CENTRE OF TESTING SERVICE CO., LTD.

A101, No.65, Zhuji Highway, Tianhe District, Guangzhou, China
 Tel: +86-20-85543113 (32 lines) Fax: +86-20-38780406
 Complaint line: +86-20-85533471 E-mail: cts@cts-lab.com.cn

See Reverse For Terms And Conditions of Service



TABLE OF CONTENTS

<u>Description</u>	<u>Page</u>
1.0 TEST STANDARDS	5
2.0 SUMMARY	5
2.1 GENERAL REMARKS	5
2.2 FINAL ASSESSMENT	5
3.0 EQUIPMENT UNDER TEST	5
3.1 POWER SUPPLY SYSTEM UTILISED	5
3.2 SHORT DESCRIPTION OF THE EQUIPMENT UNDER TEST (EUT)	5
3.3 EUT OPERATION MODE	5
3.4 EUT CONFIGURATION	6
4.0 TEST ENVIRONMENT	7
4.1 ADDRESS OF THE TEST LABORATORY	7
4.2 TEST FACILITY	7
4.3 ENVIRONMENTAL CONDITIONS	7
4.4 DEFINITIONS OF SYMBOLS USED IN THIS TEST REPORT	7
4.5 STATEMENT OF THE MEASUREMENT UNCERTAINTY	7
4.6 MEASUREMENT UNCERTAINTY	8
5.0 SUMMARY OF STANDARDS AND RESULTS	8
5.1.DESCRPTION OF STANDARDS AND RESULTS	8
6.0 POWER LINE CONDUCTED EMISSION TEST	9
6.1.TEST EQUIPMENT	9
6.2. BLOCK DIAGRAM OF TEST SETUP	9
6.3. POWER LINE CONDUCTED EMISSION TEST LIMITS	9
6.4.TEST PROCEDURE	9
6.5. POWER LINE CONDUCTED EMISSION TEST RESULTS	9
7.0 6DB BANDWIDTH MEASUREMENT	12
7.1 LIMITS	12
7.2 MEASUREMENT EQUIPMENT USED	12
7.3 TEST CONFIGURATION	12
7.4 TEST PROCEDURE	12
7.5 TEST RESULTS	12
8.0 PEAK POWER	26
8.1 LIMIT	26
8.2 MEASUREMENT EQUIPMENT USED	26
8.3 TEST CONDIGURATION	26

Copyright of this report is owned by Centre of Testing Service and may not be reproduced other than in full except with the written approval of the issuing Company.

CENTRE OF TESTING SERVICE CO., LTD.

A101, No.65, Zhuji Highway, Tianhe District, Guangzhou, China

Tel: +86-20-85543113 (32 lines)

Fax: +86-20-38780406

Complaint line: +86-20-85533471

E-mail: cts@cts-lab.com.cn

See Reverse For Terms And Conditions of Service



8.4 TEST PROCEDURE27

8.5 TEST RESULTS27

9.0 PEAK POWER SPECTRAL DENSITY40

 9.1 LIMIT.....40

 9.2 MEASUREMENT EQUIPMENT USED.....40

 9.3 TEST CONFIGURATION40

 9.4 TEST PROCEDURE.....40

 9.5 TEST RESULTS40

10.0 BAND EDGES MEASUREMENT54

 10.1 LIMIT.....54

 10.2 MEASUREMENT EQUIPMENT USED54

 10.3 TEST CONFIGURATION54

 10.4 TEST PROCEDURE.....55

 10.5 TEST RESULTS55

11.0 SPURIOUS EMISSIONS.....88

 11.1 LIMIT.....88

 11.2 TEST EQUIPMENT.....88

 11.3 TEST CONFIGURATION89

 11.4 TEST PROCEDURE.....90

 11.5 TEST RESULTS90

12.0 ANTENNA REQUIREMENTS104

 12.1 STANDARD APPLICABLE104

 12.2 ANTENNA CONSTRUCTION AND DIRECTIONAL GAIN.....104

13.0 DEVIATION TO TEST SPECIFICATIONS104

Copyright of this report is owned by Centre of Testing Service and may not be reproduced other than in full except with the written approval of the issuing Company.

CENTRE OF TESTING SERVICE CO., LTD.

A101, No.65, Zhuji Highway, Tianhe District, Guangzhou, China

Tel: +86-20-85543113 (32 lines)

Fax: +86-20-38780406

Complaint line: +86-20-85533471

E-mail: cts@cts-lab.com.cn

See Reverse For Terms And Conditions of Service

1.0 TEST STANDARDS

The tests were performed according to following standards:

- 47 CFR PART 15 OCT, 2014
- ANSI C63.4-2009

2.0 SUMMARY

2.1 GENERAL REMARKS

Date of receipt of test sample	25 May 2015
Testing commenced on	25 May~10 July 2015
Testing concluded on	10 July 2015

2.2 FINAL ASSESSMENT

The FCC requirements pertaining to the technical standards and tested operation modes are

- - fulfilled.
- **not** fulfilled.

The equipment under test

- - fulfils the FCC requirements cited on page 1.
- **does not** fulfil the FCC requirements cited on page 1.

3.0 EQUIPMENT UNDER TEST

3.1 Power supply system utilised

Power supply voltage : DC 12V by adapter,
Adapter power supply by AC 120V/60Hz

3.2 Short description of the Equipment under Test (EUT)

Number of tested samples: 1
Serial number: Prototype

3.3 EUT operation mode

The equipment under test was operated during the measurement under the following conditions:

- Standby
- TX- Y position
- TX- Z position
- TX- X position

802.11b/g/n(20M):TX-X Position Low (2412.0 MHz) , TX-X Position Middle (2437.0 MHz) ,
TX-X Position High (2462.0 MHz)

802.11n(40M): TX-X Position Low (2422.0 MHz) , TX-X Position Middle (2437.0 MHz) ,
TX-X Position High (2452.0 MHz)

Note:Operation mode TX -X position of EUT is the radiated test worst case. So only these test results be recorded in the test report.

3.4 EUT configuration

3.4.1. Description of configuration (EUT)

Description	:	Wireless Router
Model Number	:	MOFI4500-4GXeLTE
Operation frequency	:	802.11b/g/n(20M):2412.0 MHz~2462.0 MHz 802.11n(40MHz):2422.0 MHz ~2452.0 MHz
WiFi	:	802.11:b/g/n
Modulation Technology	:	DBPSK, DQPSK, CCK, OFDM, 16-QAM, 64QAM
Date Rate	:	802.11b: 11, 5.5, 2, 1 Mbps 802.11g: 54, 48, 36, 24, 18, 12, 9, 6 Mbps 802.11n: 300Mbps
Antenna	:	External antenna, met requirement of FCC 15.203

3.4.2. Tested Supporting System Details

3.4.2.1. Notebook

M/N	:	F83VF
S/N	:	AEN0AS64740305D
Manufacturer	:	ASUS
Power Cord	:	Unshielded, Detachable, 1.5m , 3Pin
FCC ID	:	By DoC

Copyright of this report is owned by Centre of Testing Service and may not be reproduced other than in full except with the written approval of the issuing Company.

CENTRE OF TESTING SERVICE CO., LTD.

A101, No.65, Zhuji Highway, Tianhe District, Guangzhou, China

Tel: +86-20-85543113 (32 lines)

Fax: +86-20-38780406

Complaint line: +86-20-85533471

E-mail: cts@cts-lab.com.cn

See Reverse For Terms And Conditions of Service

4.0 TEST ENVIRONMENT

4.1 Address of the test laboratory

A101, No.65, Zhuji Highway, Tianhe District, Guangzhou, China

Tel: +86-20-85543113 (32 lines) Fax: +86-20-38780406

4.2 Test facility

The test facility is recognized, certified, or accredited by the following organizations:

CNAS-Lab Code: L3394

CENTRE OF TESTING SERVICE CO., LTD has been assessed and proved to be in compliance with CNAS-CL01: 2006 Accreditation Criteria for Testing and Calibration Laboratories (identical to ISO/IEC 17025: 2005 General Requirements) for the Competence of Testing and Calibration Laboratories.

IC-Registration No.: 8374A

The 3m Alternate Test Site of CENTRE OF TESTING SERVICE CO., LTD has been registered by Certification and Engineering Bureau of Industry Canada for the performance of radiated measurements with Registration No. 8374A on May 22, 2014.

FCC-Registration No.: 971995

CENTRE OF TESTING SERVICE CO., LTD, EMC Laboratory has been registered and fully described in a report filed with the FCC (Federal Communications Commission). The acceptance letter from the FCC is maintained in our files. Registration No.791995, July 13,2012.

4.3 Environmental conditions

During the measurement the environmental conditions were within the listed ranges:

Temperature:	15~35 ° C
Humidity:	25~75 %
Atmospheric pressure:	86~106 kPa

4.4 Definitions of symbols used in this test report

- - The black square indicates that the listed condition, standard or equipment is applicable for this report.
- - The empty square indicates that the listed condition, standard or equipment is **not** applicable for this report.

4.5 Statement of the measurement uncertainty

The data and results referenced in this document are true and accurate. The reader is cautioned that there may be errors within the calibration limits of the equipment and facilities. The measurement uncertainty was calculated for all measurements listed in this test report acc. to CISPR 16 - 4 "Specification for radio disturbance and immunity measuring apparatus and methods – Part 4: Uncertainty in EMC Measurements" and is documented in the CTS quality system acc. to DIN EN ISO/IEC 17025. Furthermore, component and process variability of devices similar to that tested may result in additional deviation. The manufacturer has the sole responsibility of continued compliance of the device.

4.6 Measurement Uncertainty

Test Item	Frequency Range	Uncertainty	Note
Conduction disturbance	150kHz~30MHz	±1.22dB	(1)
Power disturbance	30MHz~300MHz	±1.38dB	(1)
Radiation emission (3m)	30MHz~300MHz	±3.14dB	(1)
	300MHz~1000MHz	±3.18dB	(1)
	1GHz~26.5GHz	±3.54dB	(1)

(1). This uncertainty represents an expanded uncertainty expressed at approximately the 95% confidence level using a coverage factor of k=2.

5.0 Summary of standards and results

5.1. Description of Standards and Results

The EUT have been tested according to the applicable standards as referenced below.

EMISSION		
Description of Test Item	Standard	Results
Conducted Emission Test	FCC Part 15 : 15.207 ANSI C63.4-2009	PASSED
6dB Bandwidth Measurement	FCC Part 15.247(a)(2) ANSI C63.4-2009	PASSED
Peak Power	FCC Part 15.247(b)(3)(4) ANSI C63.4-2009	PASSED
Peak Power Spectral Density	15.247(e) Power Density ANSI C63.4-2009	PASSED
Band edges measurement	FCC Part 15.247(d) ANSI C63.4-2009	PASSED
Spurious Emissions	FCC Part 15: 15.209 ANSI C63.4-2009	PASSED
Antenna Requirements	FCC Part 15: 15.203 ANSI C63.4-2009	PASSED
N/A is an abbreviation for Not Applicable.		

Copyright of this report is owned by Centre of Testing Service and may not be reproduced other than in full except with the written approval of the issuing Company.

CENTRE OF TESTING SERVICE CO., LTD.

A101, No.65, Zhuji Highway, Tianhe District, Guangzhou, China

Tel: +86-20-85543113 (32 lines)

Fax: +86-20-38780406

Complaint line: +86-20-85533471

E-mail: cts@cts-lab.com.cn

See Reverse For Terms And Conditions of Service

6.0 Power Line Conducted Emission Test

6.1. Test Equipment

Conducted Disturbance					
Item	Test Equipment	Manufacturer	Model No.	Serial No.	Last Cal.
1	EMI Test Receiver	ROHDE & SCHWARZ	ESHS10	842884/012	2014/11
2	Artificial Mains	ROHDE & SCHWARZ	ESH3-Z5	832479/025	2014/11
3	Artificial Mains	ROHDE & SCHWARZ	ESH3-Z5	832479/026	2014/11
4	Pulse Limiter	ROHDE & SCHWARZ	ESHSZ2	100301	2014/11
5	EMI Test Software	EZ-EMC	Farad	N/A	N/A

6.2. Block Diagram of Test Setup

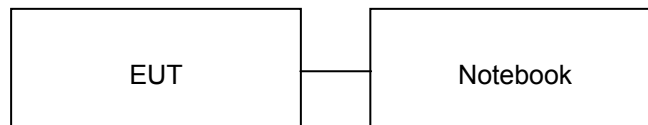

(EUT: Wireless Router)

6.3. Power Line Conducted Emission Test Limits

Standard: FCC Part 15 : 15.207, ANSI C63.4-2009

Frequency	Maximum RF Line Voltage	
	Quasi-Peak Level dB(μV)	Average Level dB(μV)
150kHz ~ 500kHz	66 ~ 56*	56 ~ 46*
500kHz ~ 5MHz	56	46
5MHz ~ 30MHz	60	50

Notes: 1. * Decreasing linearly with logarithm of frequency.
2. The lower limit shall apply at the transition frequencies.

6.4. Test Procedure

The XBOX Power connected to the power mains through a line impedance stabilization network (L.I.S.N.#2). This provides a 50 ohm coupling impedance for the EUT. Please refer the block diagram of the test setup and photographs. The other peripheral devices power cord connected to the power mains through a line impedance stabilization network (L.I.S.N.#1). Power on the PC and let it work normally, we use a keyboard test soft ware, let EUT working in test mode, then test it. Both sides of AC line are checked to find out the maximum conducted emission. In order to find the maximum emission levels, the relative positions of equipment and all of the interface cables shall be changed according to FCC Part 15C on Conducted Emission Test.

6.5. Power Line Conducted Emission Test Results

PASSED.

The frequency range from 150KHz~30MHz is investigated. Please see the following pages.

Test point:	L	Result:	<input checked="" type="checkbox"/> - passed
Frequency range:	0.15MHz~30MHz		<input type="checkbox"/> - not passed

EUT	Wireless Router
Operating Condition	TX
Test Condition	Ambient Temperature: 25°C Humidity: 56%
Test Date:	25 May~24 June 2015
Operator	Duke
MODEL NO	MOFI4500-4GXeLTE

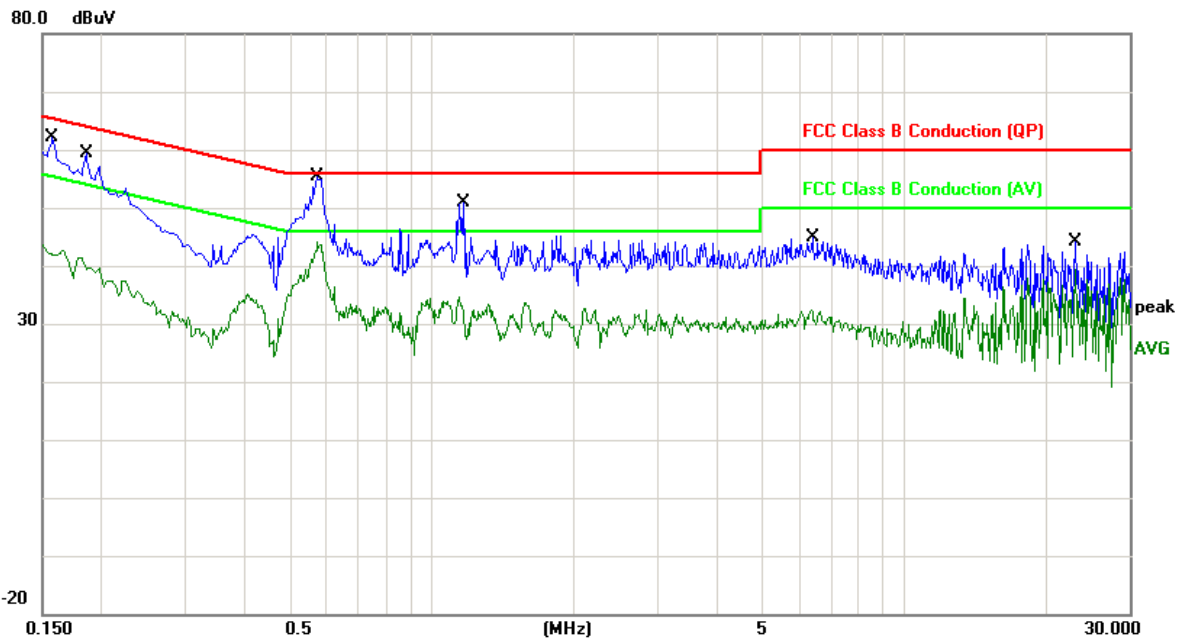

No.	Frequency (MHz)	Factor (dB)	Reading (dBuV)	Level (dBuV/m)	Limit (dBuV/m)	Margin (dB)	Det.
1	0.1580	10.82	44.04	54.86	65.56	-10.70	QP
2	0.1580	10.82	28.71	39.53	55.56	-16.03	AVG
3	0.1860	10.83	41.72	52.55	64.21	-11.66	QP
4	0.1860	10.83	27.19	38.02	54.21	-16.19	AVG
5	0.5740	10.91	41.59	52.50	56.00	-3.50	QP
6	0.5740	10.91	32.53	43.44	46.00	-2.56	AVG
7	1.1700	10.91	28.02	38.93	56.00	-17.07	QP
8	1.1700	10.91	16.64	27.55	46.00	-18.45	AVG
9	6.3980	11.13	27.41	38.54	60.00	-21.46	QP
10	6.3980	11.13	18.04	29.17	50.00	-20.83	AVG
11	23.1299	11.11	32.47	43.58	60.00	-16.42	QP
12	23.1299	11.11	28.81	39.92	50.00	-10.08	AVG

Remark: Other frequency mini margin all >6 dB of Limit

Copyright of this report is owned by Centre of Testing Service and may not be reproduced other than in full except with the written approval of the issuing Company.

CENTRE OF TESTING SERVICE CO., LTD.

A101, No.65, Zhuji Highway, Tianhe District, Guangzhou, China
 Tel: +86-20-85543113 (32 lines) Fax: +86-20-38780406
 Complaint line: +86-20-85533471 E-mail: cts@cts-lab.com.cn

See Reverse For Terms And Conditions of Service

Test point:	N	Result:	■ - passed
Frequency range:	0.15MHz~30MHz		□ - not passed

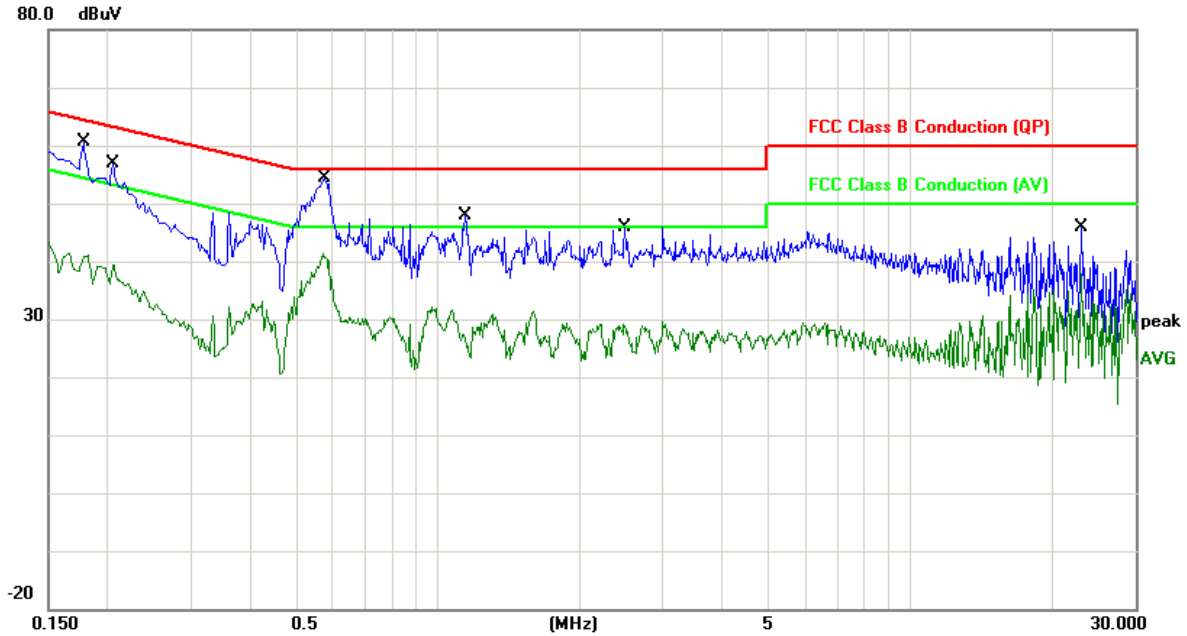

No.	Frequency (MHz)	Factor (dB)	Reading (dBuV)	Level (dBuV/m)	Limit (dBuV/m)	Margin (dB)	Det.
1	0.1780	10.81	43.34	54.15	64.58	-10.43	QP
2	0.1780	10.81	28.15	38.96	54.58	-15.62	AVG
3	0.2060	10.82	39.86	50.68	63.37	-12.69	QP
4	0.2060	10.82	24.79	35.61	53.37	-17.76	AVG
5	0.5780	10.90	41.13	52.03	56.00	-3.97	QP
6	0.5780	10.90	29.22	40.12	46.00	-5.88	AVG
7	1.1460	10.90	30.95	41.85	56.00	-14.15	QP
8	1.1460	10.90	14.65	25.55	46.00	-20.45	AVG
9	2.4980	10.95	28.88	39.83	56.00	-16.17	QP
10	2.4980	10.95	17.23	28.18	46.00	-17.82	AVG
11	23.1300	11.06	32.94	44.00	60.00	-16.00	QP
12	23.1300	11.06	25.64	36.70	50.00	-13.30	AVG

Remark: Other frequency mini margin all >6 dB of Limit

Note: Level=Reading+Factor. Margin= Level-Limit

7.0 6 dB BANDWIDTH MEASUREMENT

7.1 LIMITS

According to §15.247(a)(2), systems using digital modulation techniques may operate in the 902 - 928 MHz, 2400 - 2483.5 MHz, and 5725 - 5850 MHz bands. The minimum 6 dB bandwidth shall be at least 500 kHz.

7.2 MEASUREMENT EQUIPMENT USED

20dB Bandwidth					
Item	Test Equipment	Manufacturer	Model No.	Serial No.	Last Cal.
1	Signal analyzer	ROHDE & SCHWARZ	FSIQ26	100311	2015/03

7.3 TEST CONFIGURATION

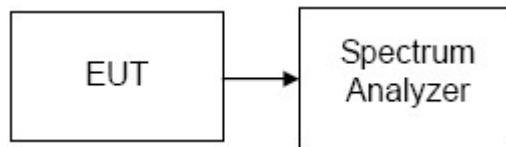

7.4 TEST PROCEDURE

1. Place the EUT on the table and set it in the transmitting mode.
2. Remove the antenna from the EUT and then connect a low loss RF cable from the antenna port to the spectrum analyzer.
3. Set the spectrum analyzer as RBW = 100kHz, VBW = 300kHz, Span = 1.5 times of bandwidth, Sweep = auto.
4. Mark the peak frequency and -6dB (upper and lower) frequency.
5. Repeat until all the rest channels are investigated

7.5 TEST RESULTS

Copyright of this report is owned by Centre of Testing Service and may not be reproduced other than in full except with the written approval of the issuing Company.

CENTRE OF TESTING SERVICE CO., LTD.

A101, No.65, Zhuji Highway, Tianhe District, Guangzhou, China

Tel: +86-20-85543113 (32 lines)

Fax: +86-20-38780406

Complaint line: +86-20-85533471

E-mail: cts@cts-lab.com.cn

See Reverse For Terms And Conditions of Service



Chain:a

Modulation Standard	Channel	Frequency (MHz)	Bandwidth (MHz)	Limit (KHz)	Result
802.11b	Low	2412	9.68	>500	PASSED
	Middle	2437	9.64		PASSED
	High	2462	9.68		PASSED
802.11g	Low	2412	16.60	>500	PASSED
	Middle	2437	16.60		PASSED
	High	2462	16.60		PASSED
802.11n(20)	Low	2412	17.80	>500	PASSED
	Middle	2437	17.75		PASSED
	High	2462	17.75		PASSED
802.11n(40)	Low	2422	36.50	>500	PASSED
	Middle	2437	36.60		PASSED
	High	2452	36.60		PASSED

Remark: The Bandwidth is Delta 2 of following the graph. And the Delta 2 is Marker 2 subtract Marker 1.

Chain:b

Modulation Standard	Channel	Frequency (MHz)	Bandwidth (MHz)	Limit (KHz)	Result
802.11b	Low	2412	9.68	>500	PASSED
	Middle	2437	9.64		PASSED
	High	2462	9.68		PASSED
802.11g	Low	2412	16.65	>500	PASSED
	Middle	2437	16.60		PASSED
	High	2462	16.60		PASSED
802.11n(20)	Low	2412	17.75	>500	PASSED
	Middle	2437	17.65		PASSED
	High	2462	17.75		PASSED
802.11n(40)	Low	2422	36.60	>500	PASSED
	Middle	2437	36.60		PASSED
	High	2452	36.60		PASSED

Remark: The Bandwidth is Delta 2 of following the graph. And the Delta 2 is Marker 2 subtract Marker 1.

Copyright of this report is owned by Centre of Testing Service and may not be reproduced other than in full except with the written approval of the issuing Company.

CENTRE OF TESTING SERVICE CO., LTD.

A101, No.65, Zhuji Highway, Tianhe District, Guangzhou, China
 Tel: +86-20-85543113 (32 lines) Fax: +86-20-38780406
 Complaint line: +86-20-85533471 E-mail: cts@cts-lab.com.cn

See Reverse For Terms And Conditions of Service



Test Plot
Chain:a

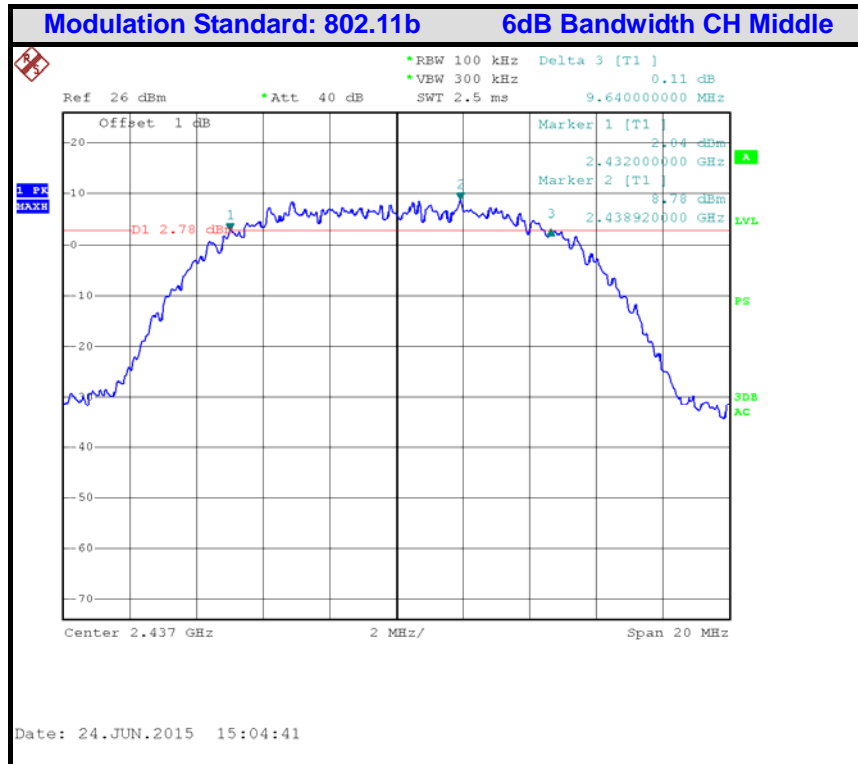
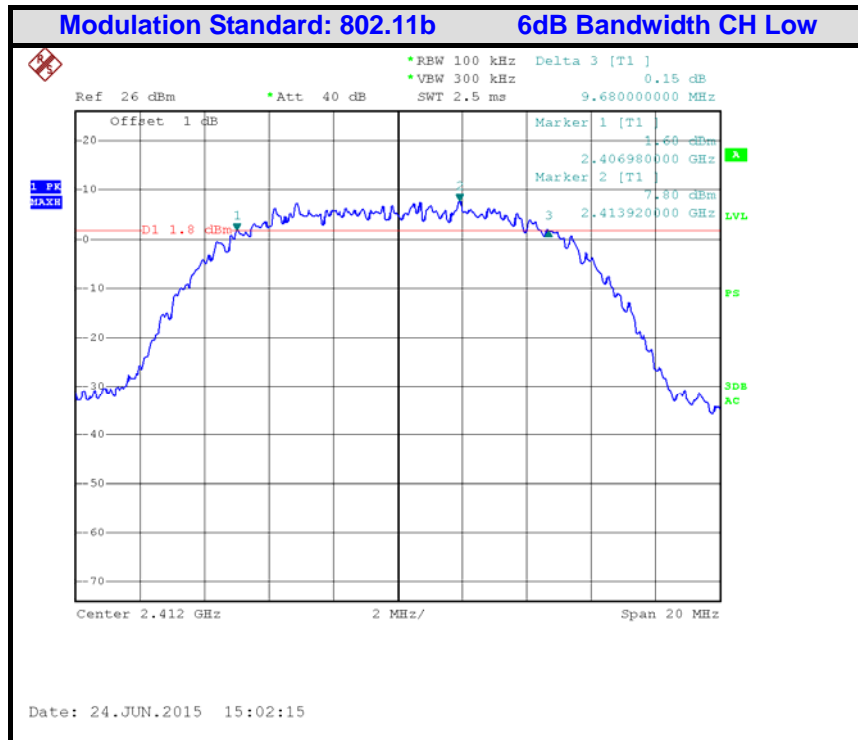

Copyright of this report is owned by Centre of Testing Service and may not be reproduced other than in full except with the written approval of the issuing Company.

CENTRE OF TESTING SERVICE CO., LTD.

A101, No.65, Zhuji Highway, Tianhe District, Guangzhou, China

Tel: +86-20-85543113 (32 lines)

Fax: +86-20-38780406

Complaint line: +86-20-85533471

E-mail: cts@cts-lab.com.cn

See Reverse For Terms And Conditions of Service

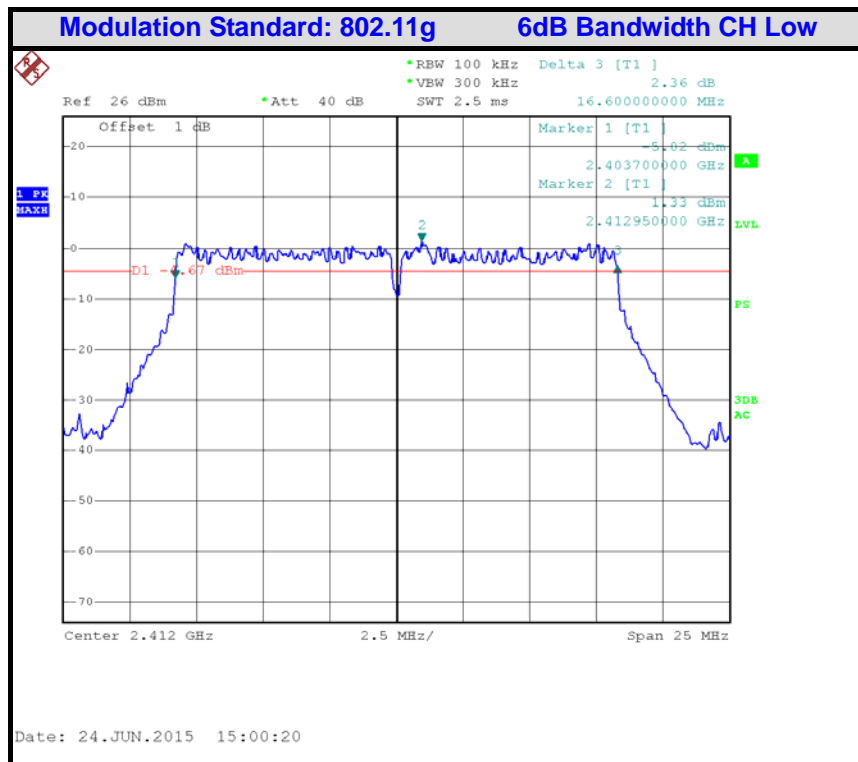
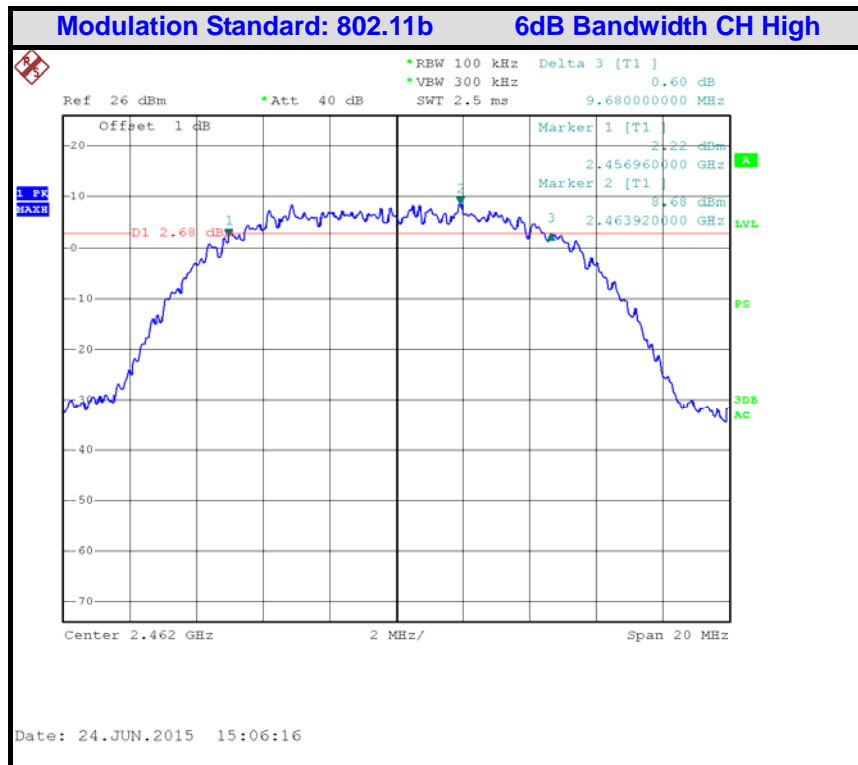

Copyright of this report is owned by Centre of Testing Service and may not be reproduced other than in full except with the written approval of the issuing Company.

CENTRE OF TESTING SERVICE CO., LTD.

A101, No.65, Zhuji Highway, Tianhe District, Guangzhou, China

Tel: +86-20-85543113 (32 lines)

Fax: +86-20-38780406

Complaint line: +86-20-85533471

E-mail: cts@cts-lab.com.cn

See Reverse For Terms And Conditions of Service

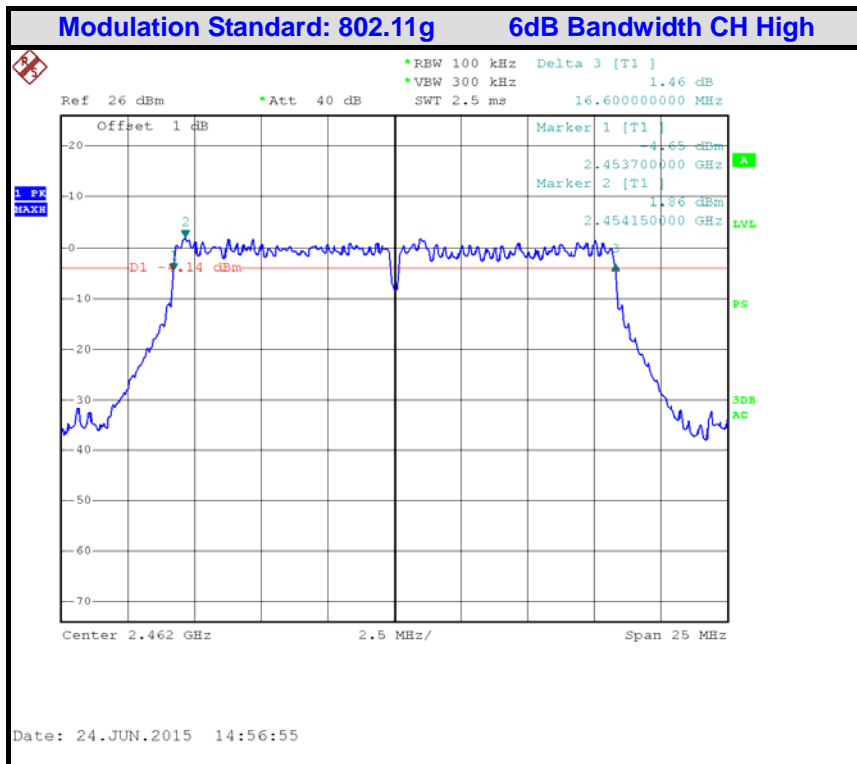
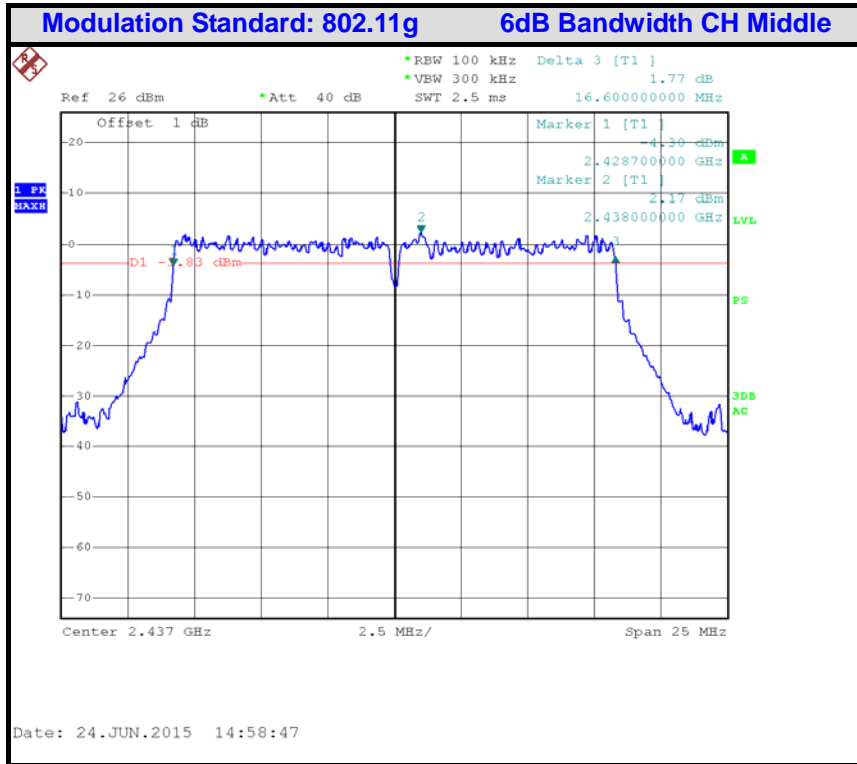

Copyright of this report is owned by Centre of Testing Service and may not be reproduced other than in full except with the written approval of the issuing Company.

CENTRE OF TESTING SERVICE CO., LTD.

A101, No.65, Zhuji Highway, Tianhe District, Guangzhou, China

Tel: +86-20-85543113 (32 lines)

Fax: +86-20-38780406

Complaint line: +86-20-85533471

E-mail: cts@cts-lab.com.cn

See Reverse For Terms And Conditions of Service

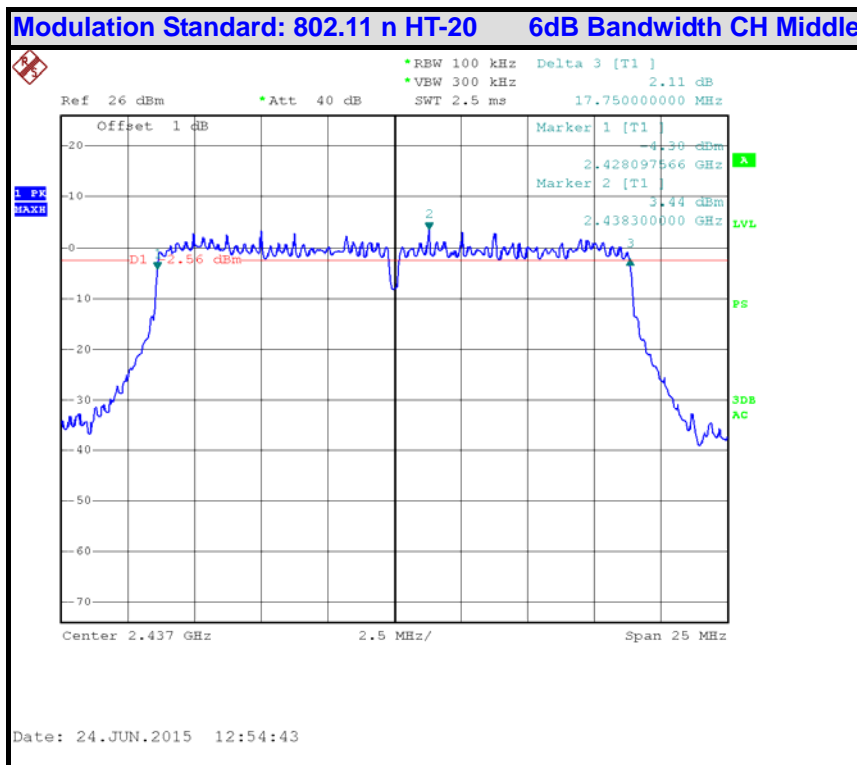
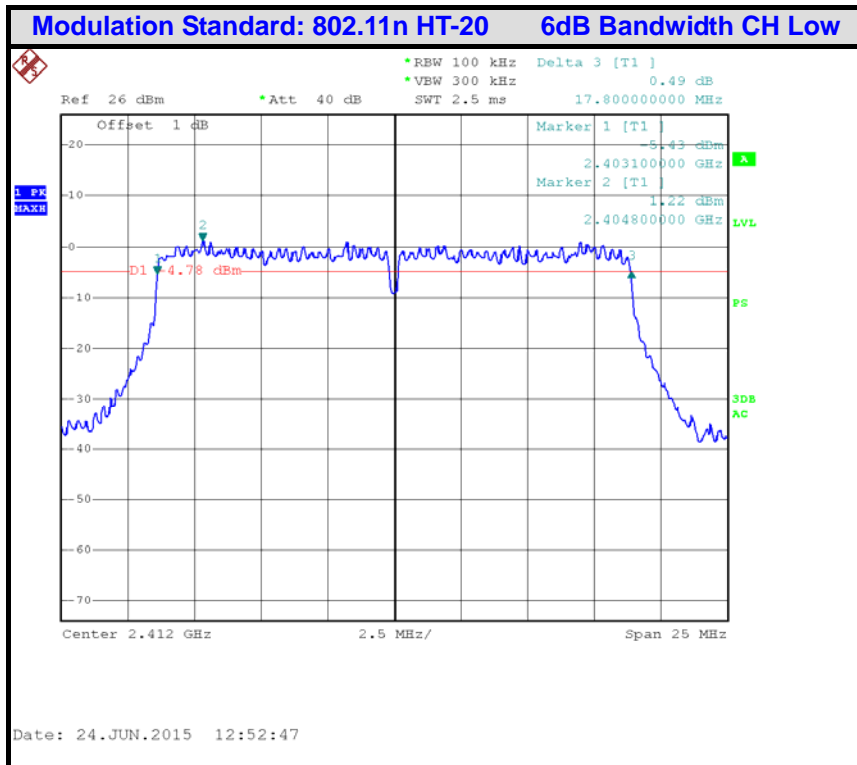

Copyright of this report is owned by Centre of Testing Service and may not be reproduced other than in full except with the written approval of the issuing Company.

CENTRE OF TESTING SERVICE CO., LTD.

A101, No.65, Zhuji Highway, Tianhe District, Guangzhou, China
 Tel: +86-20-85543113 (32 lines) Fax: +86-20-38780406
 Complaint line: +86-20-85533471 E-mail: cts@cts-lab.com.cn

See Reverse For Terms And Conditions of Service

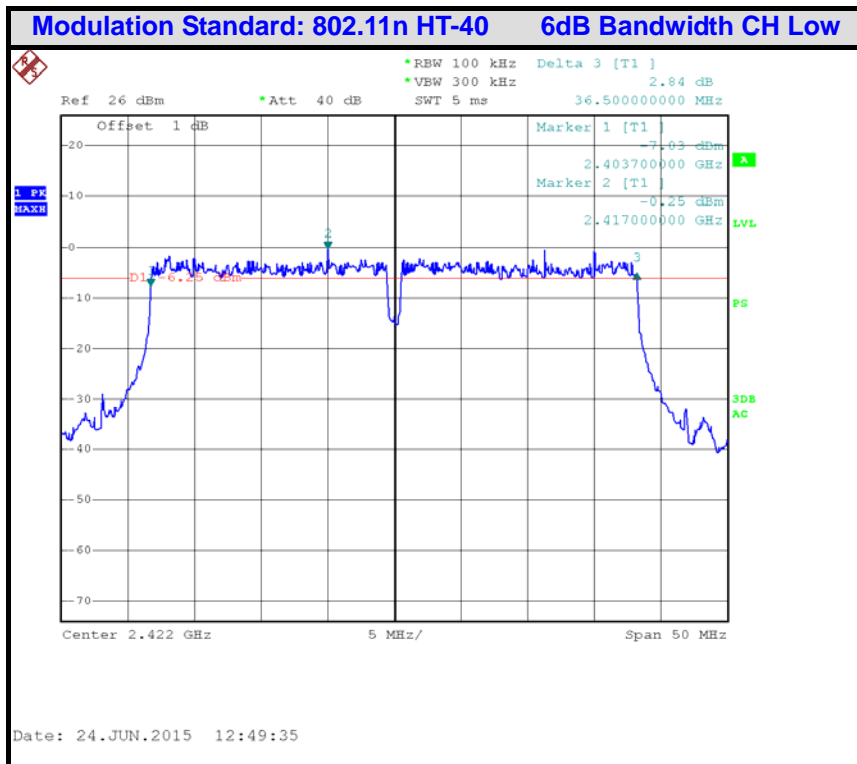
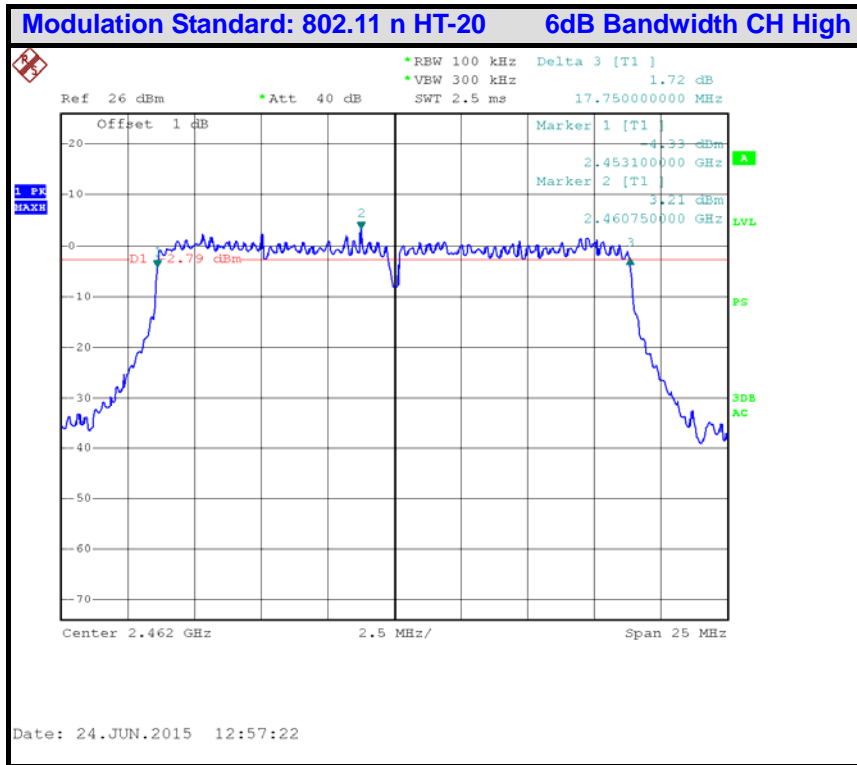

Copyright of this report is owned by Centre of Testing Service and may not be reproduced other than in full except with the written approval of the issuing Company.

CENTRE OF TESTING SERVICE CO., LTD.

A101, No.65, Zhuji Highway, Tianhe District, Guangzhou, China

Tel: +86-20-85543113 (32 lines)

Fax: +86-20-38780406

Complaint line: +86-20-85533471

E-mail: cts@cts-lab.com.cn

See Reverse For Terms And Conditions of Service

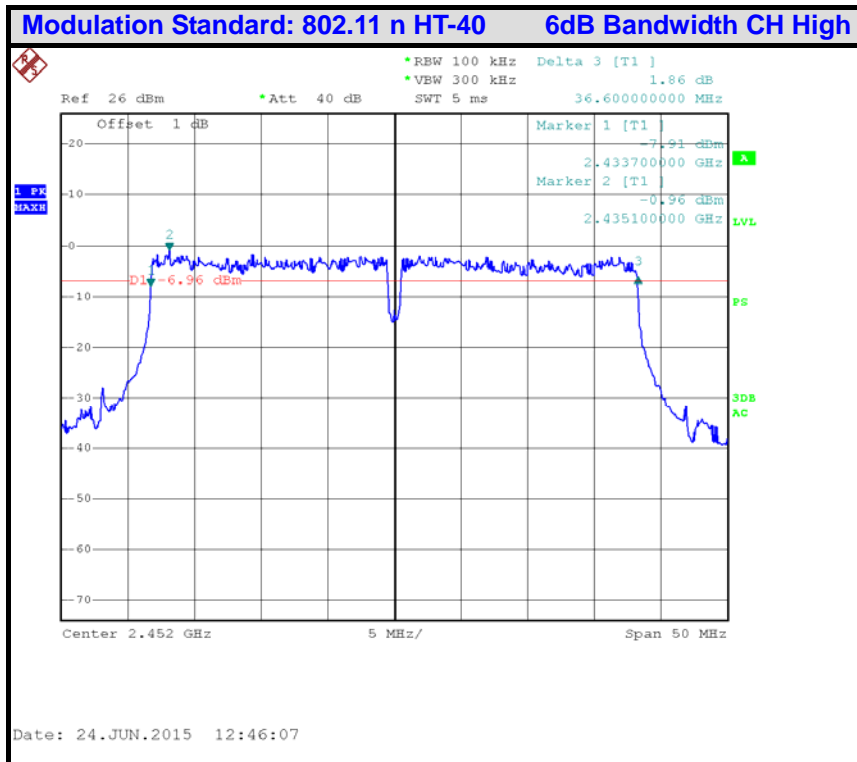
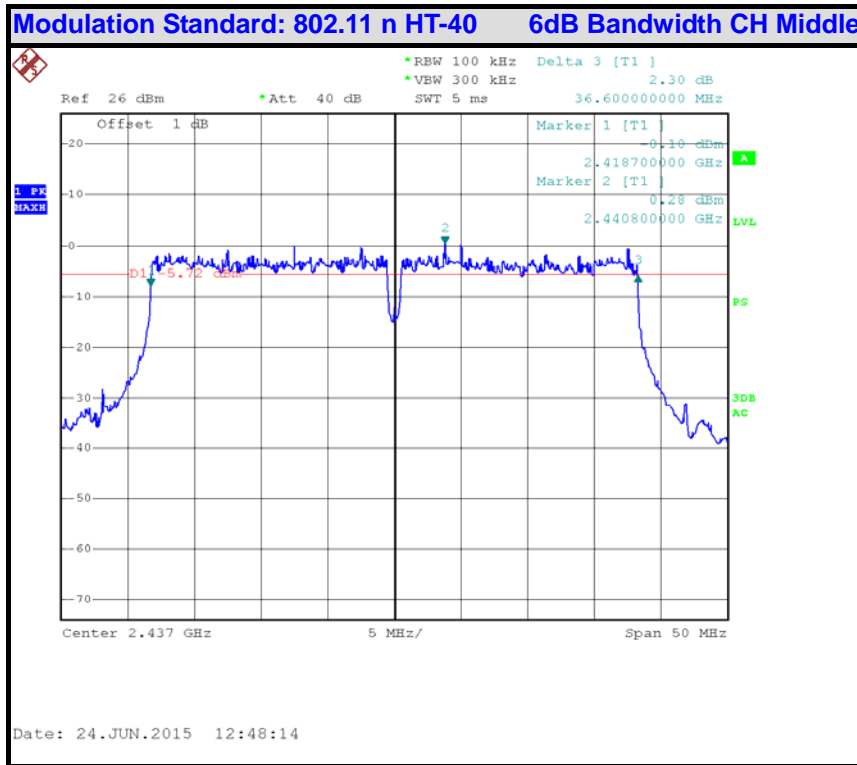

Copyright of this report is owned by Centre of Testing Service and may not be reproduced other than in full except with the written approval of the issuing Company.

CENTRE OF TESTING SERVICE CO., LTD.

A101, No.65, Zhuji Highway, Tianhe District, Guangzhou, China

Tel: +86-20-85543113 (32 lines)

Fax: +86-20-38780406

Complaint line: +86-20-85533471

E-mail: cts@cts-lab.com.cn

See Reverse For Terms And Conditions of Service



Chain:b

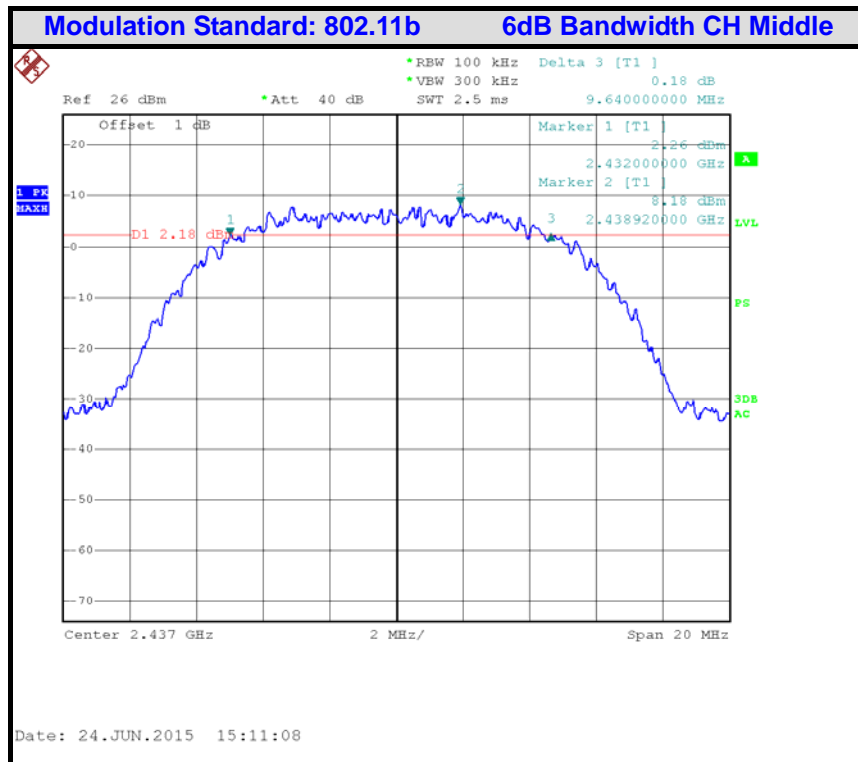
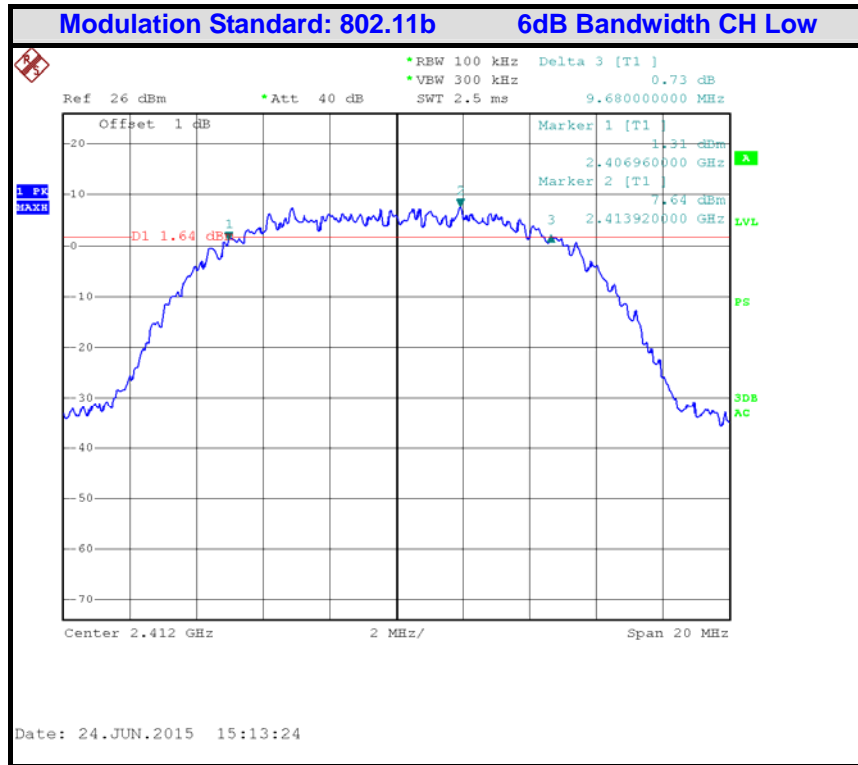

Copyright of this report is owned by Centre of Testing Service and may not be reproduced other than in full except with the written approval of the issuing Company.

CENTRE OF TESTING SERVICE CO., LTD.

A101, No.65, Zhuji Highway, Tianhe District, Guangzhou, China

Tel: +86-20-85543113 (32 lines)

Fax: +86-20-38780406

Complaint line: +86-20-85533471

E-mail: cts@cts-lab.com.cn

See Reverse For Terms And Conditions of Service

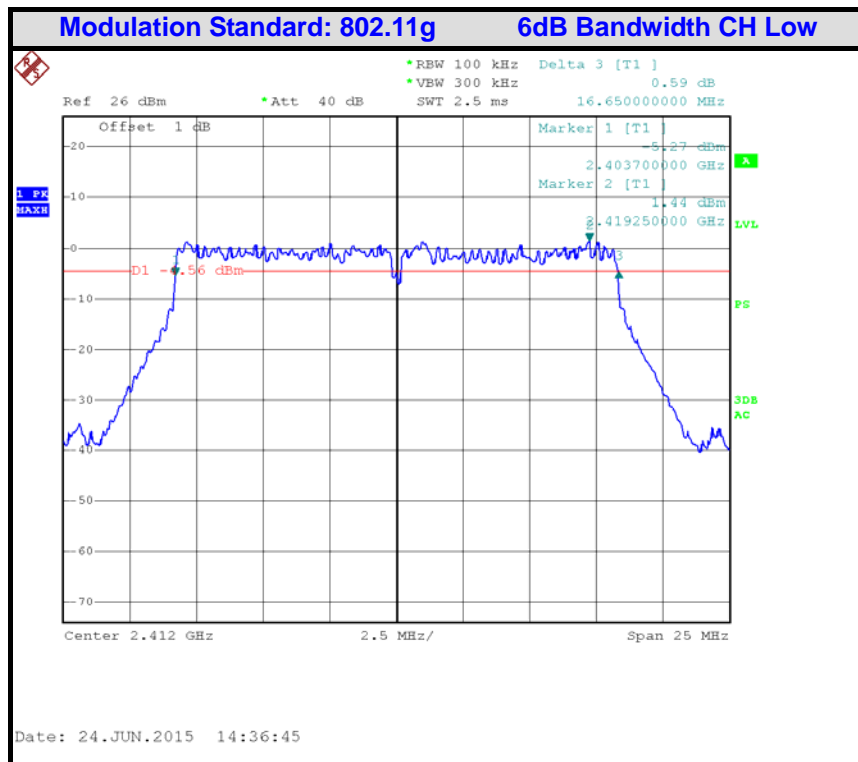
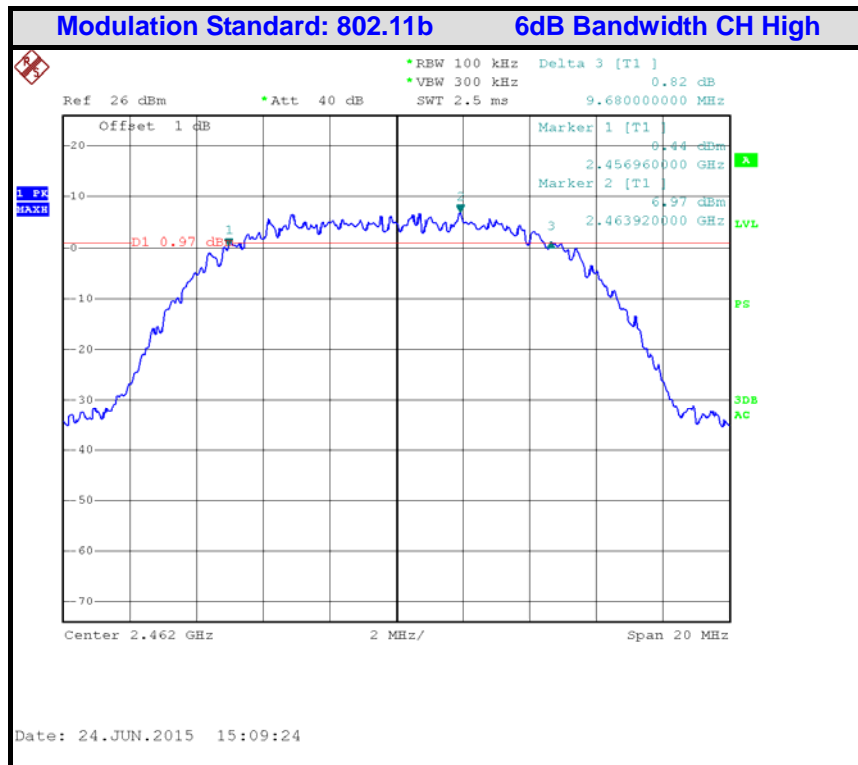

Copyright of this report is owned by Centre of Testing Service and may not be reproduced other than in full except with the written approval of the issuing Company.

CENTRE OF TESTING SERVICE CO., LTD.

A101, No.65, Zhuji Highway, Tianhe District, Guangzhou, China

Tel: +86-20-85543113 (32 lines)

Fax: +86-20-38780406

Complaint line: +86-20-85533471

E-mail: cts@cts-lab.com.cn

See Reverse For Terms And Conditions of Service

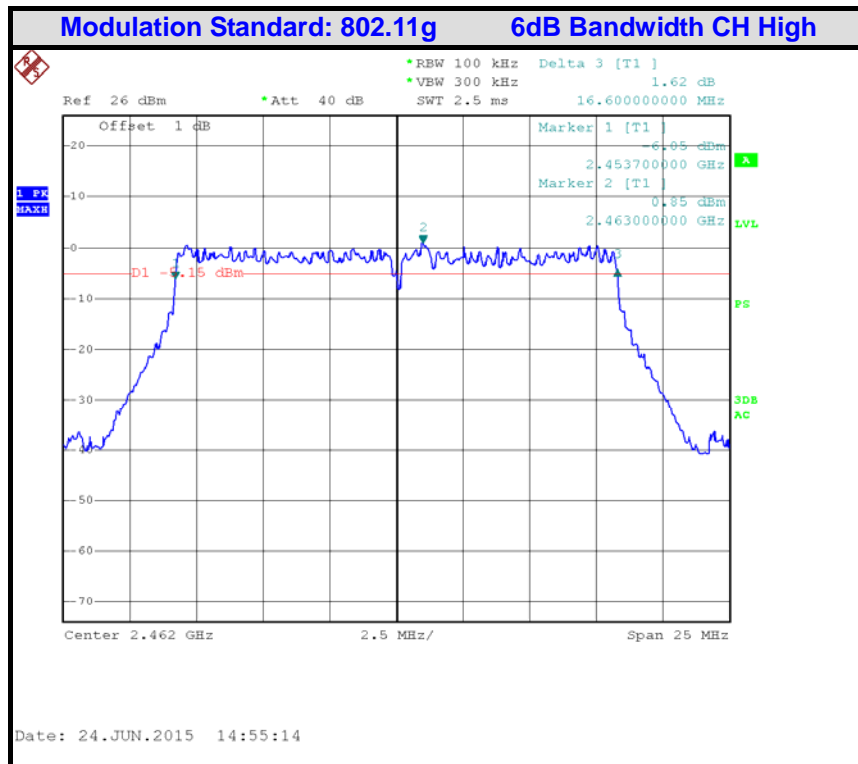
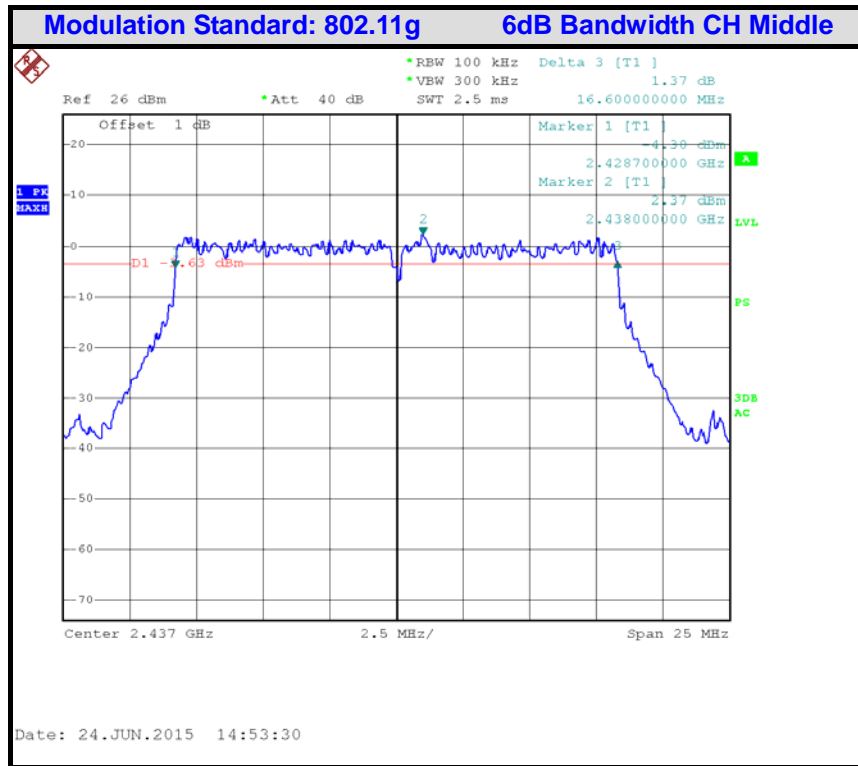

Copyright of this report is owned by Centre of Testing Service and may not be reproduced other than in full except with the written approval of the issuing Company.

CENTRE OF TESTING SERVICE CO., LTD.

A101, No.65, Zhuji Highway, Tianhe District, Guangzhou, China
 Tel: +86-20-85543113 (32 lines) Fax: +86-20-38780406
 Complaint line: +86-20-85533471 E-mail: cts@cts-lab.com.cn

See Reverse For Terms And Conditions of Service

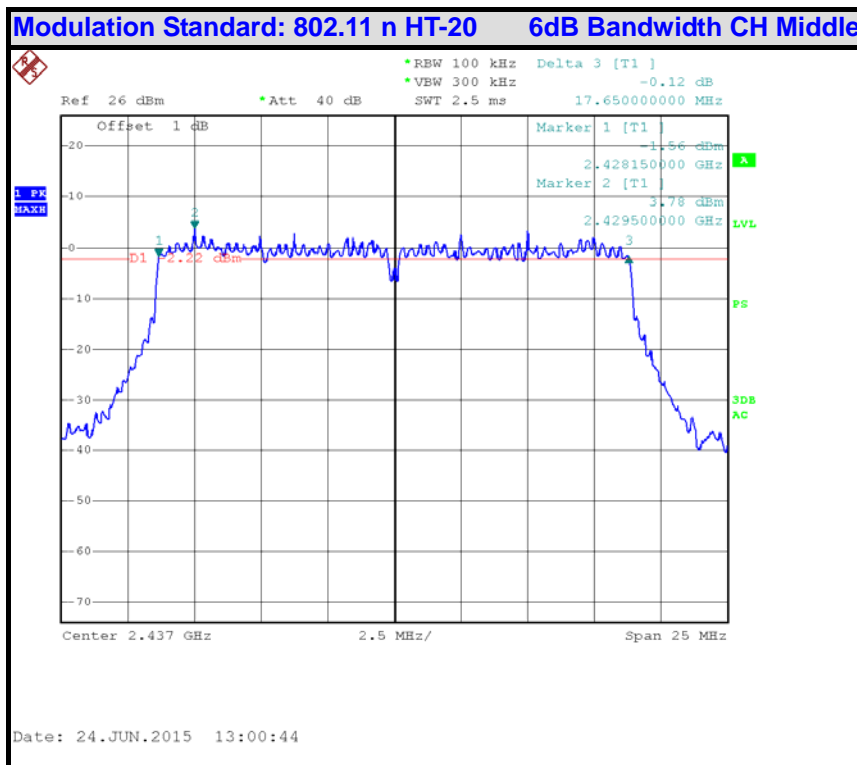
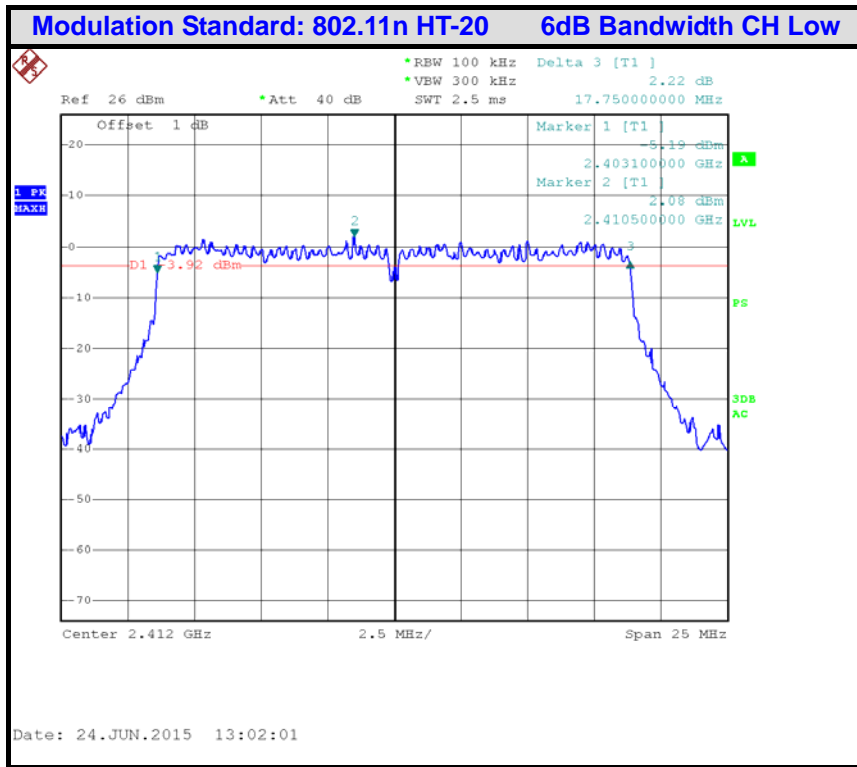

Copyright of this report is owned by Centre of Testing Service and may not be reproduced other than in full except with the written approval of the issuing Company.

CENTRE OF TESTING SERVICE CO., LTD.

A101, No.65, Zhuji Highway, Tianhe District, Guangzhou, China
Tel: +86-20-85543113 (32 lines) Fax: +86-20-38780406
Complaint line: +86-20-85533471 E-mail: cts@cts-lab.com.cn

See Reverse For Terms And Conditions of Service

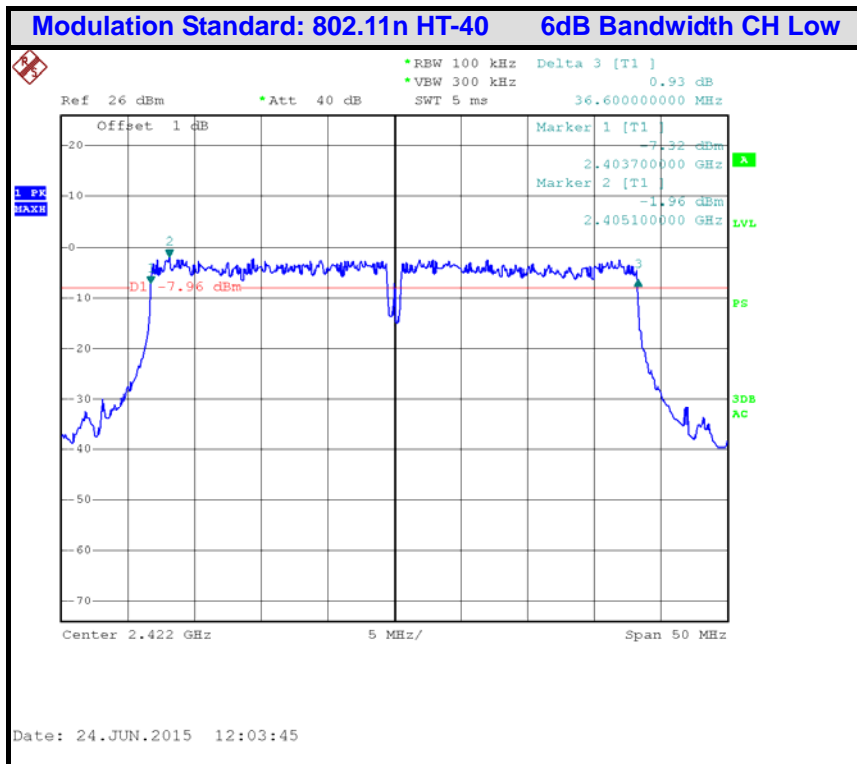
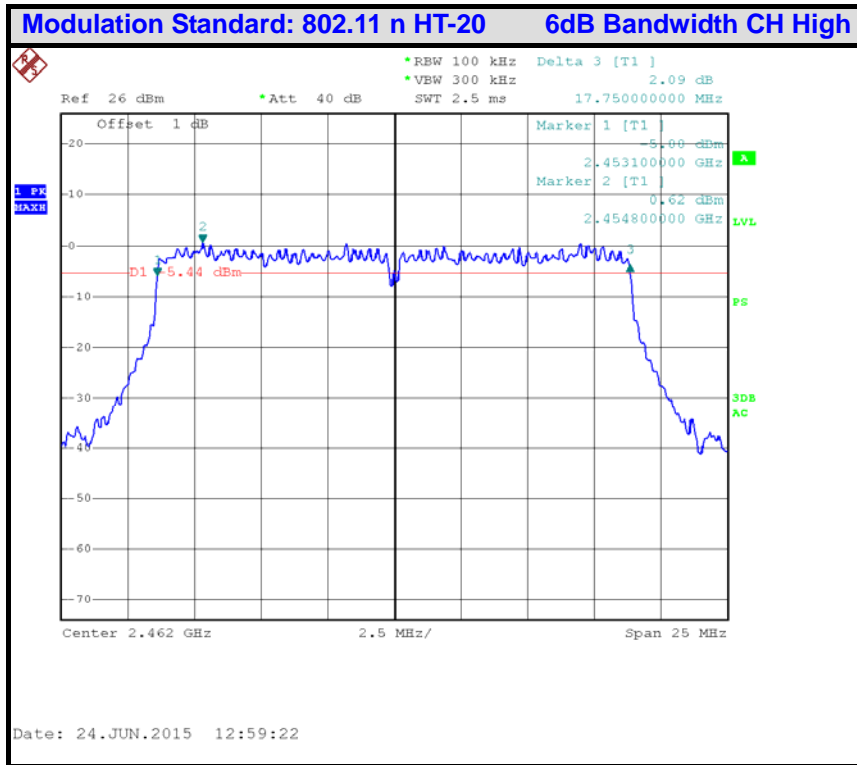

Copyright of this report is owned by Centre of Testing Service and may not be reproduced other than in full except with the written approval of the issuing Company.

CENTRE OF TESTING SERVICE CO., LTD.

A101, No.65, Zhuji Highway, Tianhe District, Guangzhou, China

Tel: +86-20-85543113 (32 lines)

Fax: +86-20-38780406

Complaint line: +86-20-85533471

E-mail: cts@cts-lab.com.cn

See Reverse For Terms And Conditions of Service

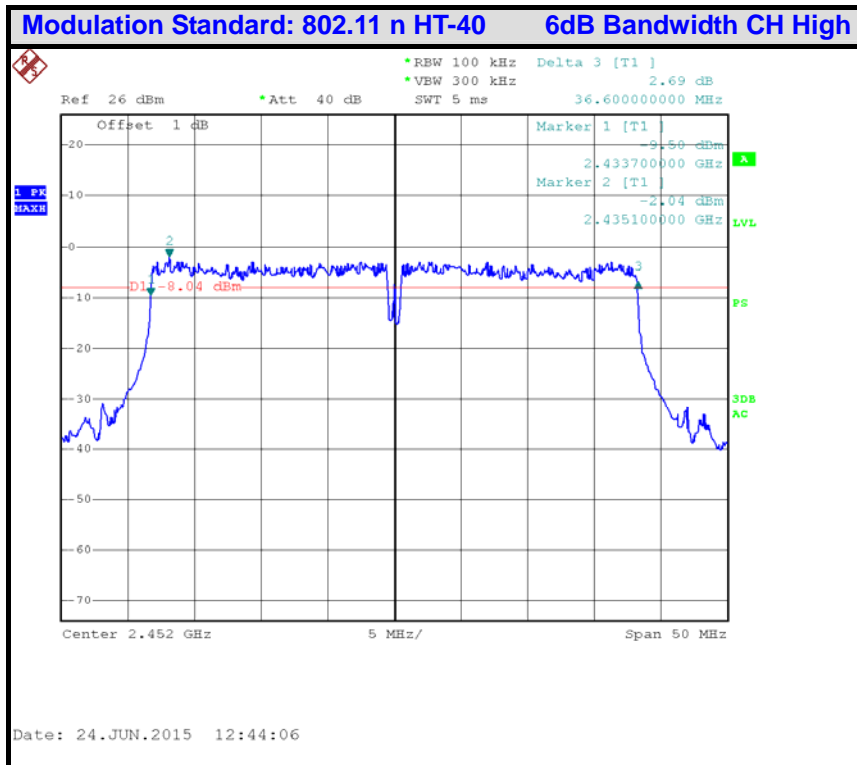
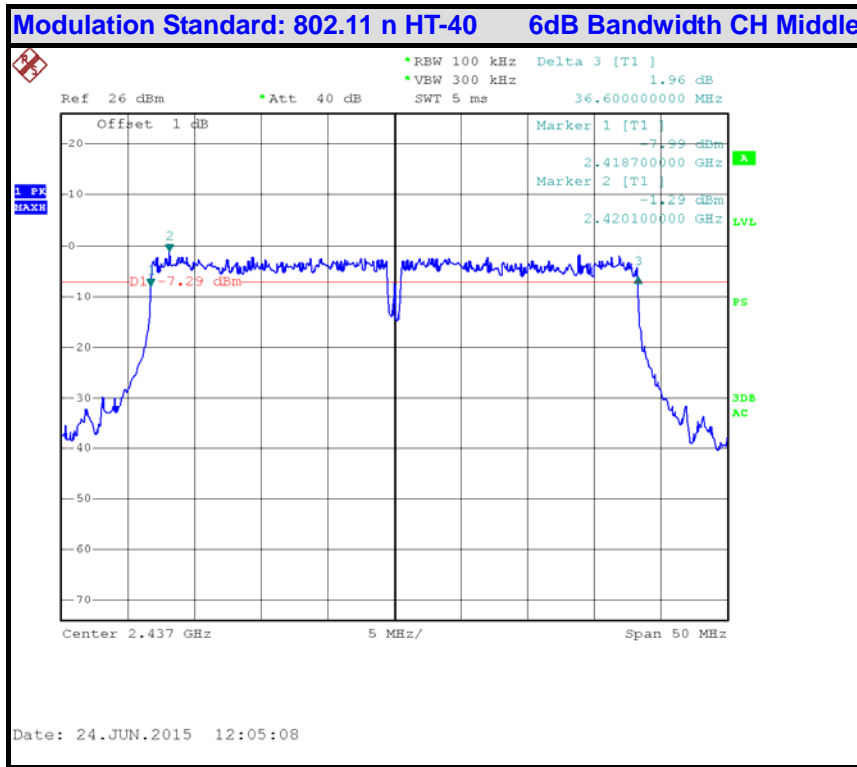

Copyright of this report is owned by Centre of Testing Service and may not be reproduced other than in full except with the written approval of the issuing Company.

CENTRE OF TESTING SERVICE CO., LTD.

A101, No.65, Zhuji Highway, Tianhe District, Guangzhou, China

Tel: +86-20-85543113 (32 lines)

Fax: +86-20-38780406

Complaint line: +86-20-85533471

E-mail: cts@cts-lab.com.cn

See Reverse For Terms And Conditions of Service

8.0 PEAK POWER

8.1 LIMIT

The maximum peak output power of the intentional radiator shall not exceed the following:

1. According to §15.247(b)(3), for systems using digital modulation in the bands of 902-928 MHz, 2400-2483.5 MHz, and 5725-5850 MHz: 1 Watt.
2. According to §15.247(b)(4), the conducted output power limit specified in paragraph (b) of this section is based on the use of antennas with directional gains that do not exceed 6 dBi. Except as shown in paragraph (c) of this section, if transmitting antennas of directional gain greater than 6 dBi are used, the conducted output power from the intentional radiator shall be reduced below the stated values in paragraphs (b)(1), (b)(2), and (b)(3) of this section, as appropriate, by the amount in dB that the directional gain of the antenna exceeds 6 dBi.

8.2 MEASUREMENT EQUIPMENT USED

Peak Power					
Item	Test Equipment	Manufacturer	Model No.	Serial No.	Last Cal.
1	Signal analyzer	ROHDE & SCHWARZ	FSIQ26	100311	2015/03
2	Power meter	ROHDE & SCHWARZ	NRVS	842856/049	2015/03

8.3 TEST CONDIGURATION

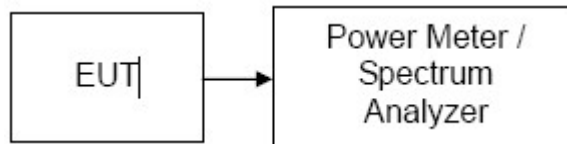

Copyright of this report is owned by Centre of Testing Service and may not be reproduced other than in full except with the written approval of the issuing Company.

CENTRE OF TESTING SERVICE CO., LTD.

A101, No.65, Zhuji Highway, Tianhe District, Guangzhou, China

Tel: +86-20-85543113 (32 lines)

Fax: +86-20-38780406

Complaint line: +86-20-85533471

E-mail: cts@cts-lab.com.cn

See Reverse For Terms And Conditions of Service

8.4 TEST PROCEDURE

1. Set span to encompass the entire emission bandwidth (EBW) of the signal.
2. Set RBW = 1 MHz.
3. Set VBW \geq 3 MHz.
4. Use sample detector mode if bin width (i.e., span/number of points in spectrum display) $<$ 0.5 RBW. Otherwise use peak detector mode.
5. Use a video trigger with the trigger level set to enable triggering only on full power pulses. Transmitter must operate at full control power for entire sweep of every sweep. If the device transmits continuously, with no off intervals or reduced power intervals, the trigger may be set to "free run".
6. Trace average 100 traces in power averaging mode.
7. Compute power by integrating the spectrum across the 26 dB EBW of the signal. The integration can be performed using the spectrum analyzer's band power measurement function with band limits set equal to the EBW band edges or by summing power levels in each 1 MHz band in linear power terms. The 1 MHz band power levels to be summed can be obtained by averaging, in linear power terms, power levels in each frequency bin across the 1 MHz.

8.5 TEST RESULTS

Passed Test Data

Modulation Standard	Channel	Frequency (MHz)	Output Power (dBm)			Limit (dBm)	Result
			Chain a	Chain b	Mix		
802.11b: 5.5Mbps (Worst Case)	Low	2412	23.26	23.24	26.27	30dBm	PASSED
	Middle	2437	23.03	23.31	26.19		PASSED
	High	2462	23.03	23.05	26.06		PASSED
802.11g: 54Mbps (Worst Case)	Low	2412	22.83	23.27	26.08	30dBm	PASSED
	Middle	2437	23.78	23.79	26.80		PASSED
	High	2462	23.56	22.42	26.05		PASSED
802.11n(20): 300Mbps (Worst Case)	Low	2412	22.65	23.06	25.88	30dBm	PASSED
	Middle	2437	23.57	23.59	26.60		PASSED
	High	2462	23.47	22.20	25.90		PASSED
802.11n(40): 300Mbps (Worst Case)	Low	2422	22.49	23.28	25.92	30dBm	PASSED
	Middle	2437	22.30	22.57	25.46		PASSED
	High	2452	22.03	22.32	25.20		PASSED

Copyright of this report is owned by Centre of Testing Service and may not be reproduced other than in full except with the written approval of the issuing Company.

CENTRE OF TESTING SERVICE CO., LTD.

A101, No.65, Zhuji Highway, Tianhe District, Guangzhou, China

Tel: +86-20-85543113 (32 lines)

Fax: +86-20-38780406

Complaint line: +86-20-85533471

E-mail: cts@cts-lab.com.cn

See Reverse For Terms And Conditions of Service



Test Plot
Chain:a

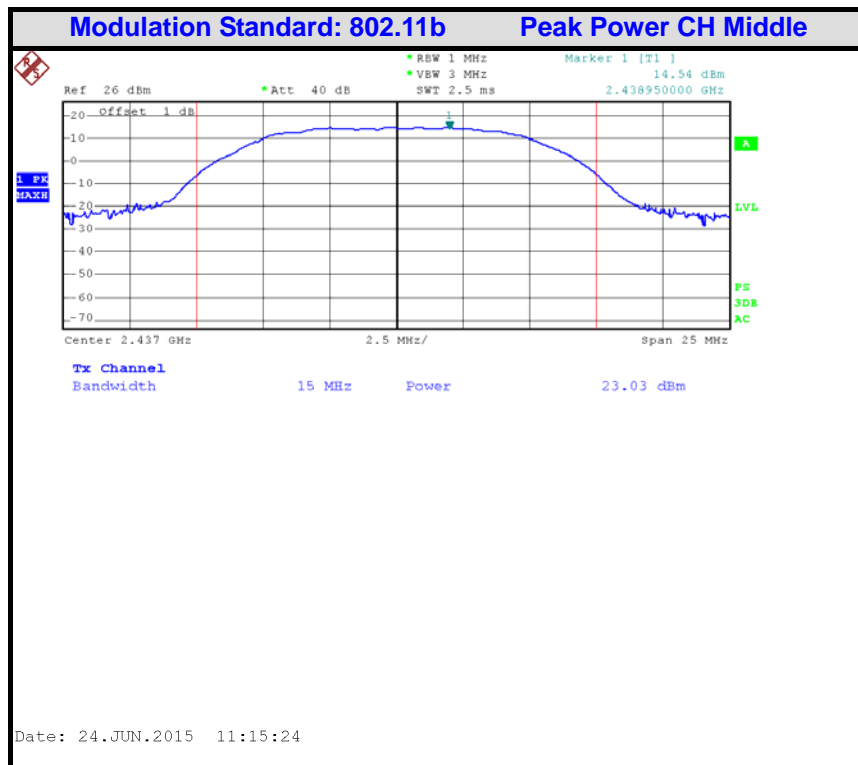
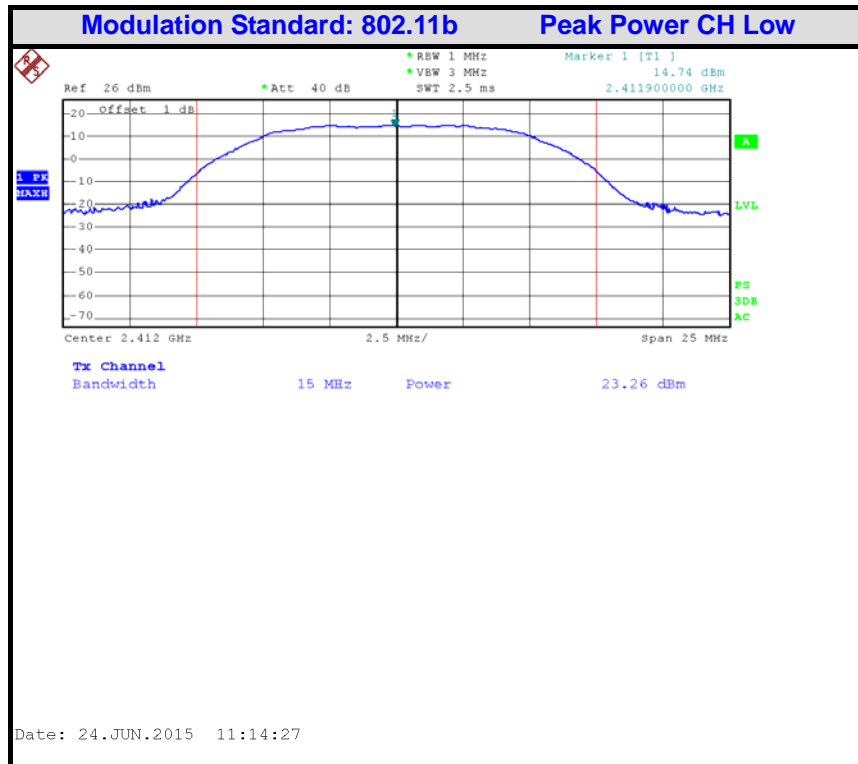

Copyright of this report is owned by Centre of Testing Service and may not be reproduced other than in full except with the written approval of the issuing Company.

CENTRE OF TESTING SERVICE CO., LTD.

A101, No.65, Zhuji Highway, Tianhe District, Guangzhou, China

Tel: +86-20-85543113 (32 lines)

Fax: +86-20-38780406

Complaint line: +86-20-85533471

E-mail: cts@cts-lab.com.cn

See Reverse For Terms And Conditions of Service

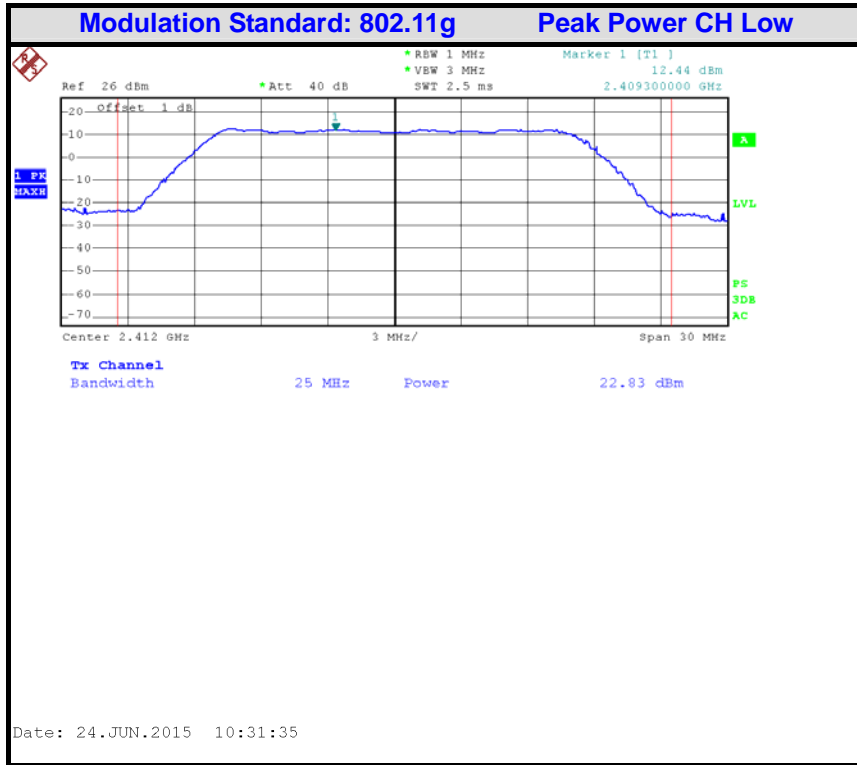
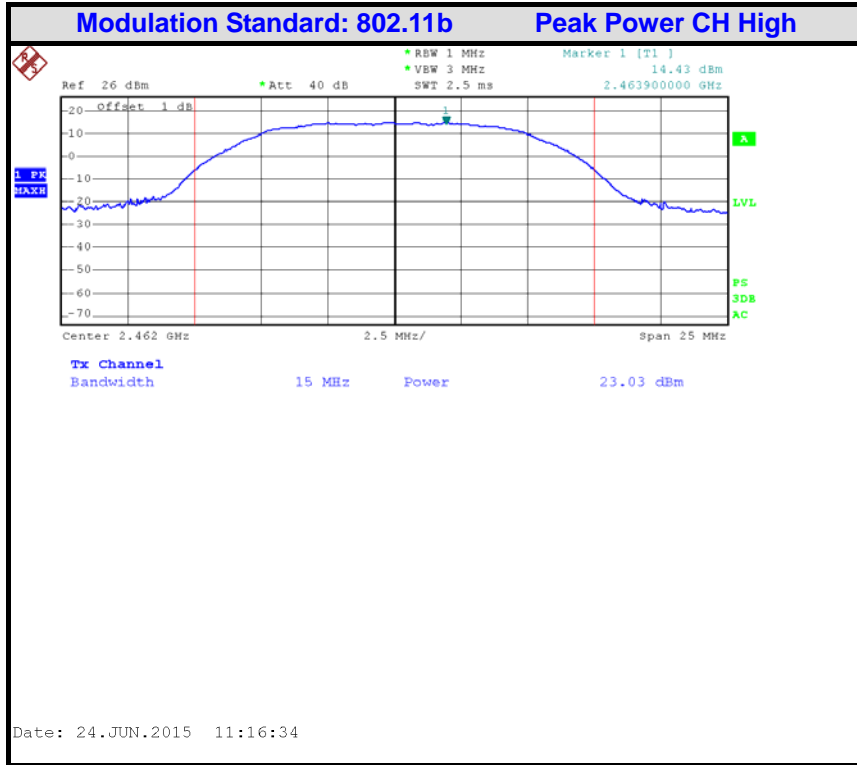

Copyright of this report is owned by Centre of Testing Service and may not be reproduced other than in full except with the written approval of the issuing Company.

CENTRE OF TESTING SERVICE CO., LTD.

A101, No.65, Zhuji Highway, Tianhe District, Guangzhou, China

Tel: +86-20-85543113 (32 lines)

Fax: +86-20-38780406

Complaint line: +86-20-85533471

E-mail: cts@cts-lab.com.cn

See Reverse For Terms And Conditions of Service

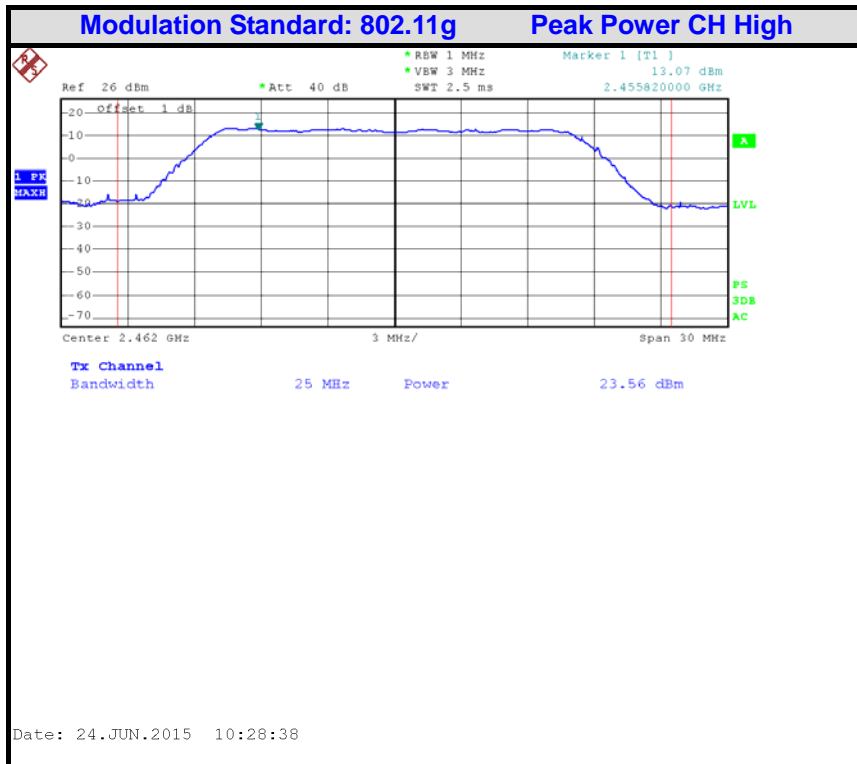
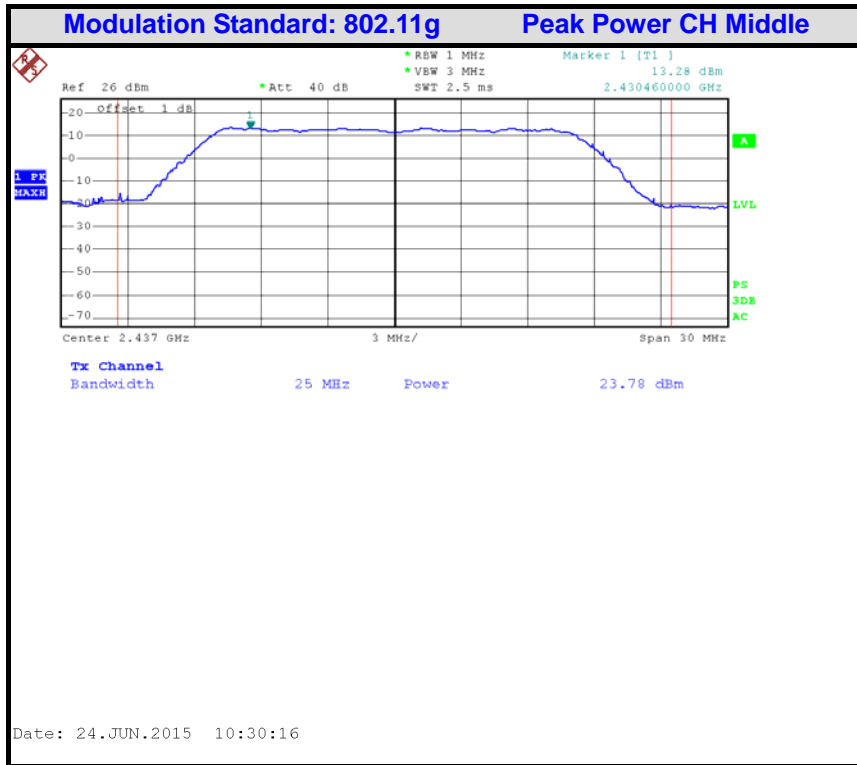

Copyright of this report is owned by Centre of Testing Service and may not be reproduced other than in full except with the written approval of the issuing Company.

CENTRE OF TESTING SERVICE CO., LTD.

A101, No.65, Zhuji Highway, Tianhe District, Guangzhou, China

Tel: +86-20-85543113 (32 lines)

Fax: +86-20-38780406

Complaint line: +86-20-85533471

E-mail: cts@cts-lab.com.cn

See Reverse For Terms And Conditions of Service

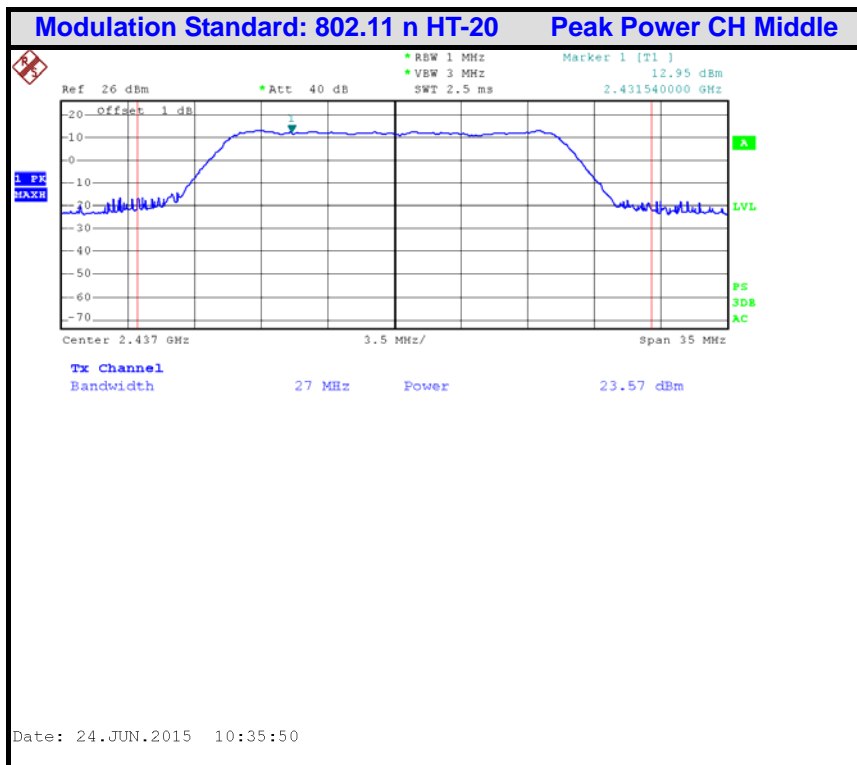
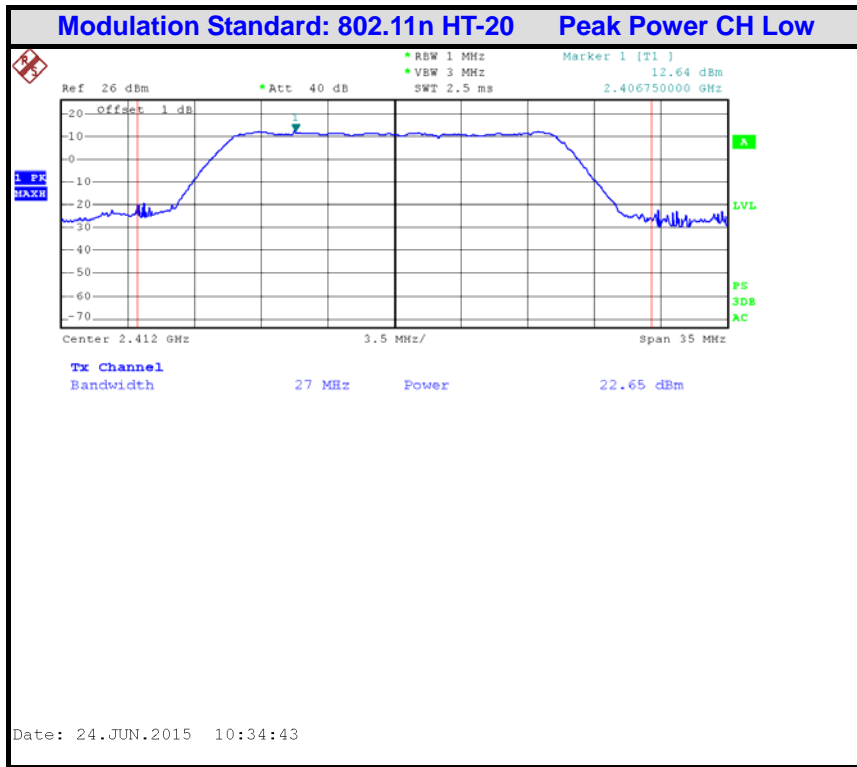

Copyright of this report is owned by Centre of Testing Service and may not be reproduced other than in full except with the written approval of the issuing Company.

CENTRE OF TESTING SERVICE CO., LTD.

A101, No.65, Zhuji Highway, Tianhe District, Guangzhou, China

Tel: +86-20-85543113 (32 lines)

Fax: +86-20-38780406

Complaint line: +86-20-85533471

E-mail: cts@cts-lab.com.cn

See Reverse For Terms And Conditions of Service

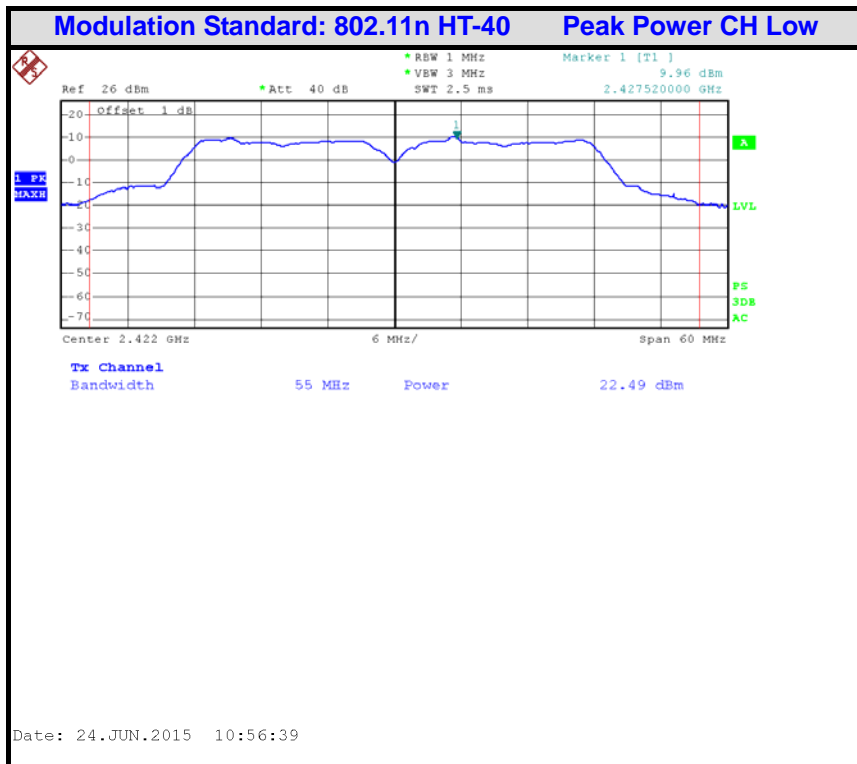
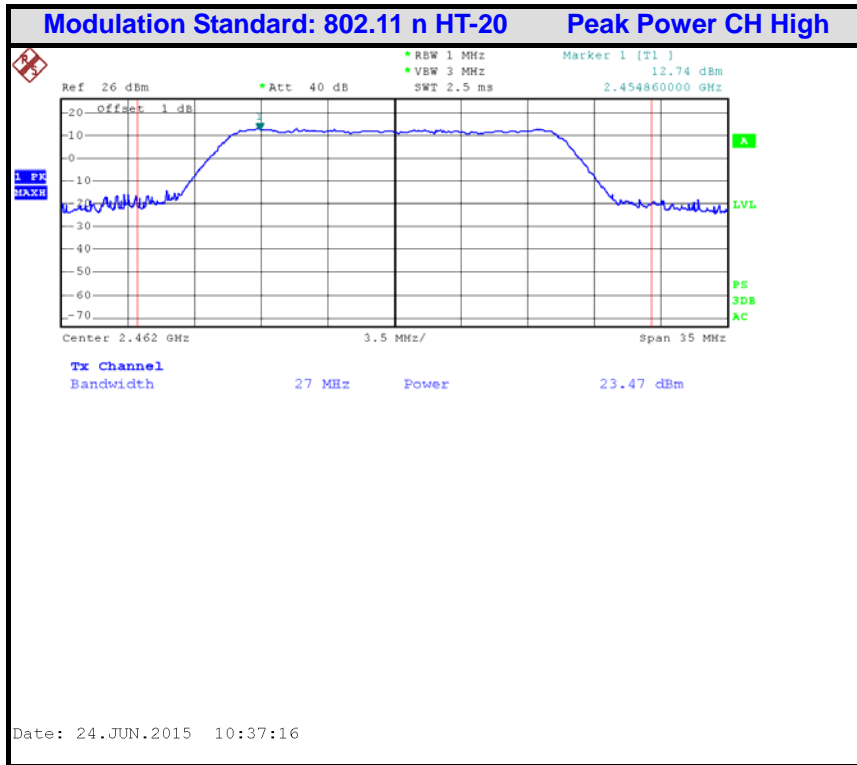

Copyright of this report is owned by Centre of Testing Service and may not be reproduced other than in full except with the written approval of the issuing Company.

CENTRE OF TESTING SERVICE CO., LTD.

A101, No.65, Zhuji Highway, Tianhe District, Guangzhou, China

Tel: +86-20-85543113 (32 lines)

Fax: +86-20-38780406

Complaint line: +86-20-85533471

E-mail: cts@cts-lab.com.cn

See Reverse For Terms And Conditions of Service

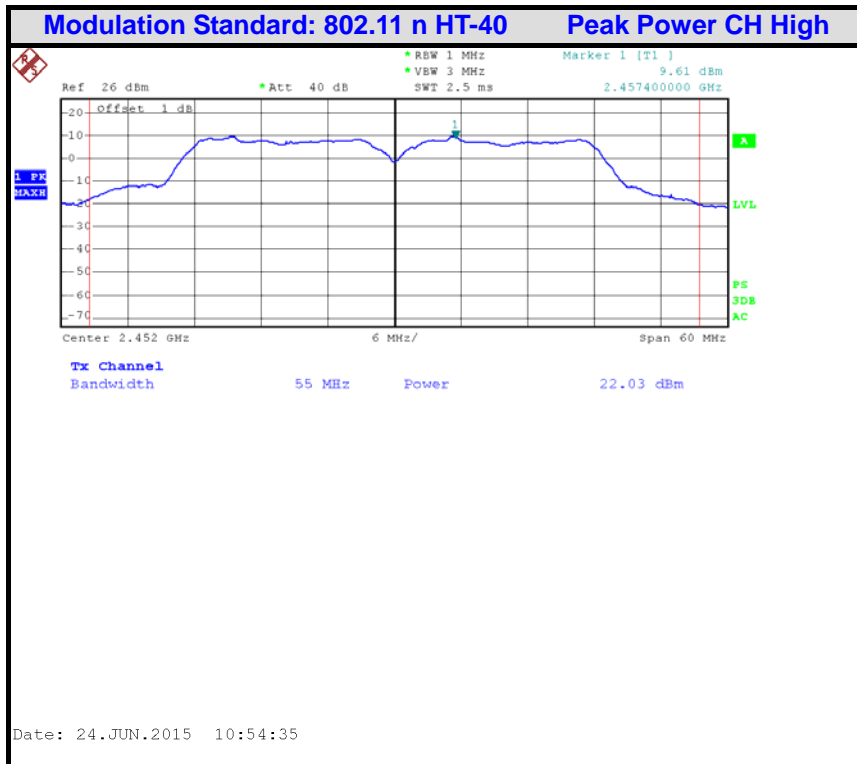
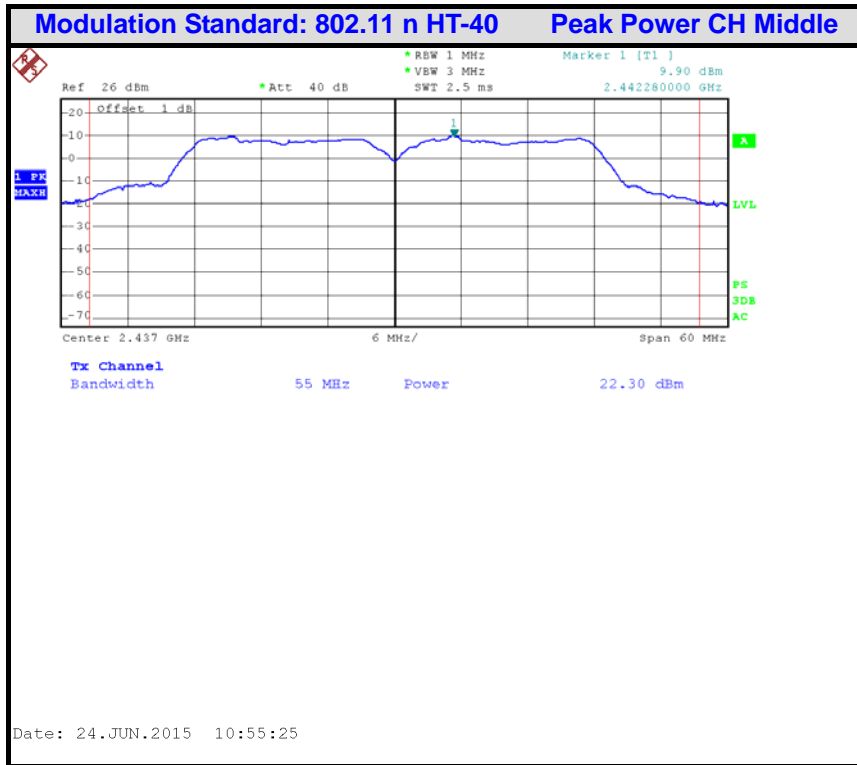

Copyright of this report is owned by Centre of Testing Service and may not be reproduced other than in full except with the written approval of the issuing Company.

CENTRE OF TESTING SERVICE CO., LTD.

A101, No.65, Zhuji Highway, Tianhe District, Guangzhou, China

Tel: +86-20-85543113 (32 lines)

Fax: +86-20-38780406

Complaint line: +86-20-85533471

E-mail: cts@cts-lab.com.cn

See Reverse For Terms And Conditions of Service



Chain:b

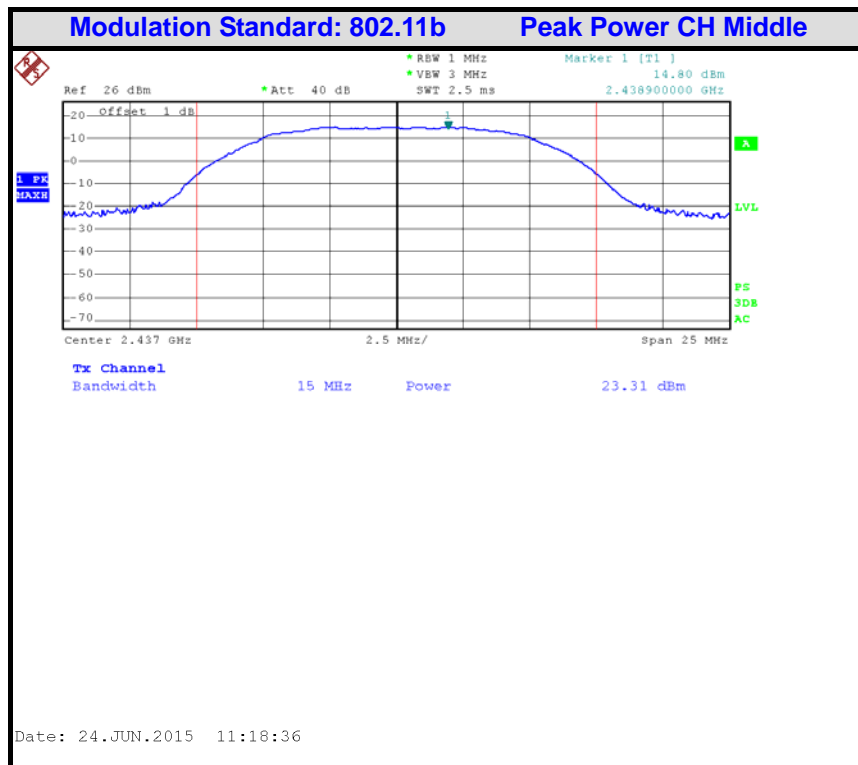
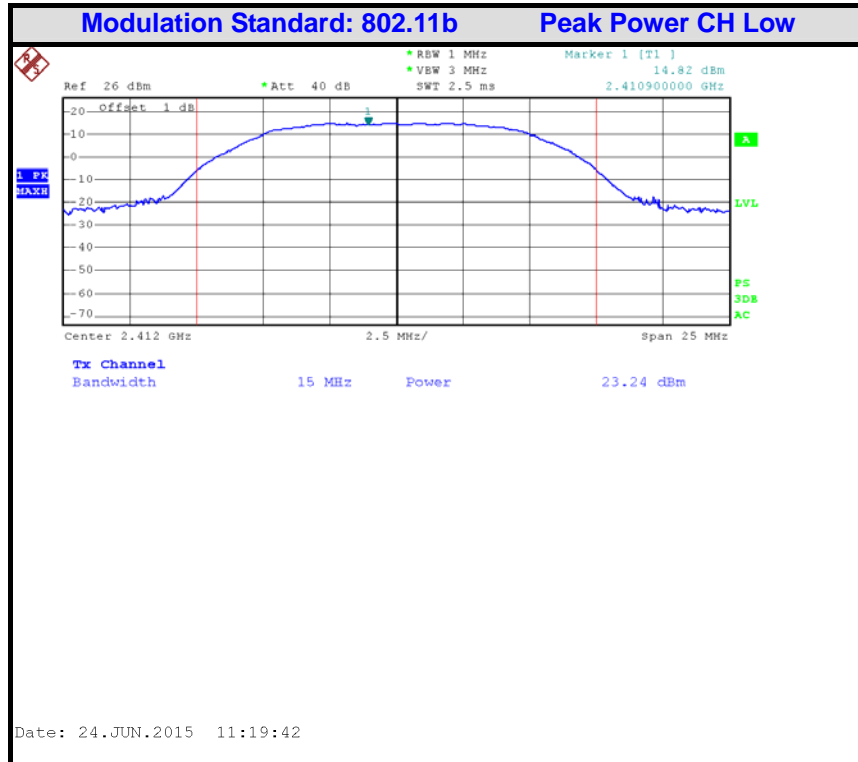

Copyright of this report is owned by Centre of Testing Service and may not be reproduced other than in full except with the written approval of the issuing Company.

CENTRE OF TESTING SERVICE CO., LTD.

A101, No.65, Zhuji Highway, Tianhe District, Guangzhou, China

Tel: +86-20-85543113 (32 lines)

Fax: +86-20-38780406

Complaint line: +86-20-85533471

E-mail: cts@cts-lab.com.cn

See Reverse For Terms And Conditions of Service

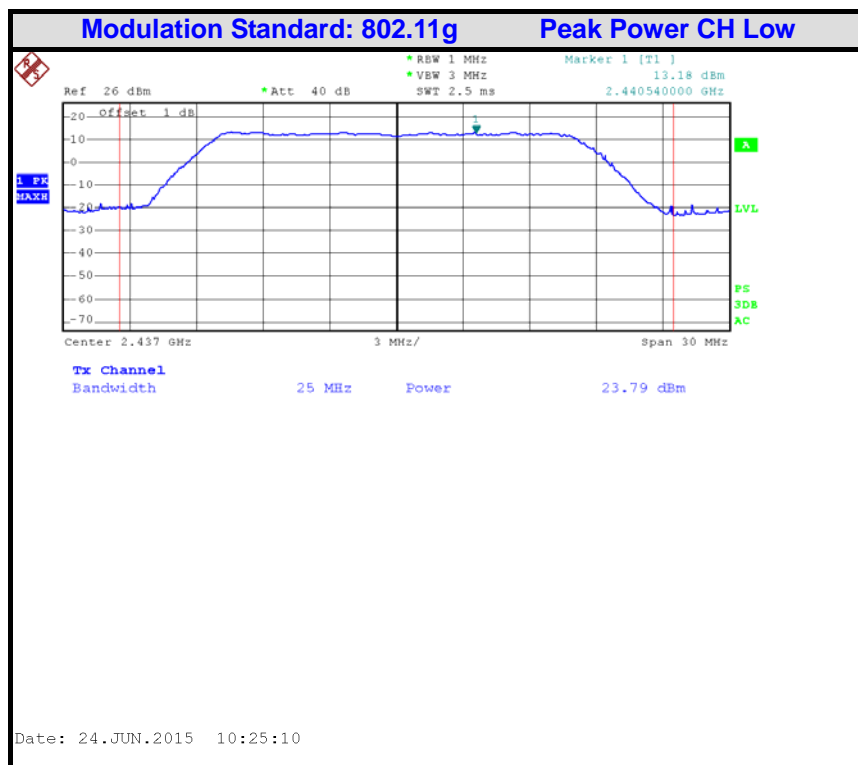
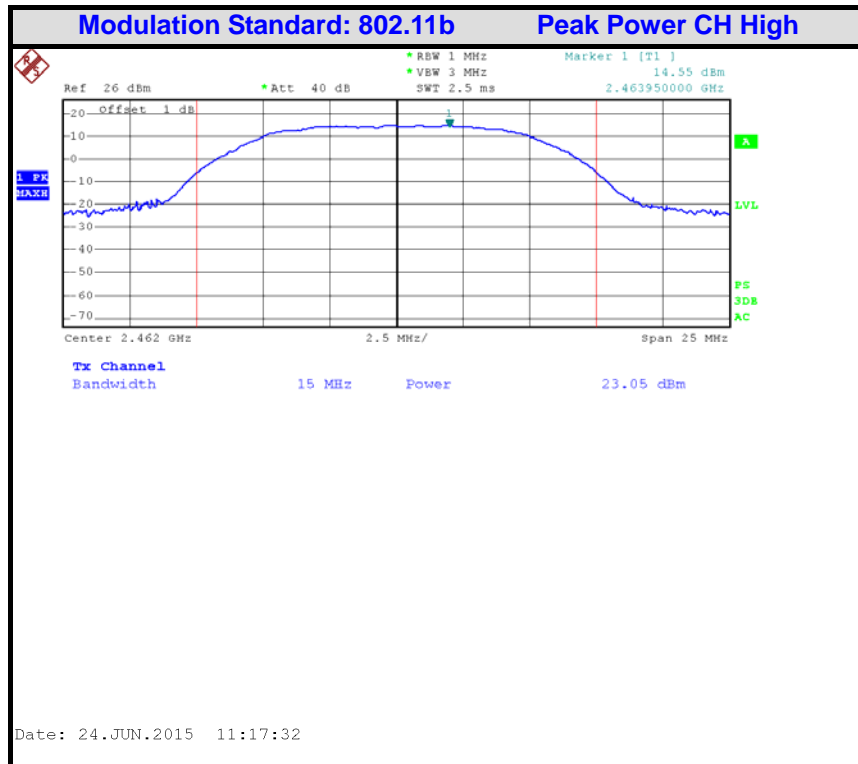

Copyright of this report is owned by Centre of Testing Service and may not be reproduced other than in full except with the written approval of the issuing Company.

CENTRE OF TESTING SERVICE CO., LTD.

A101, No.65, Zhuji Highway, Tianhe District, Guangzhou, China

Tel: +86-20-85543113 (32 lines)

Fax: +86-20-38780406

Complaint line: +86-20-85533471

E-mail: cts@cts-lab.com.cn

See Reverse For Terms And Conditions of Service

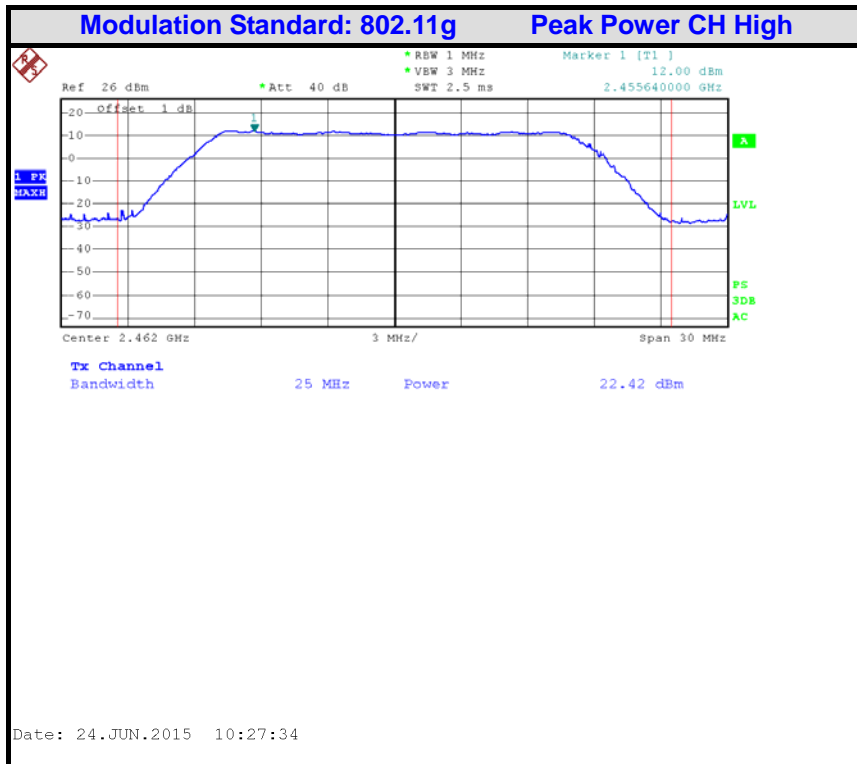
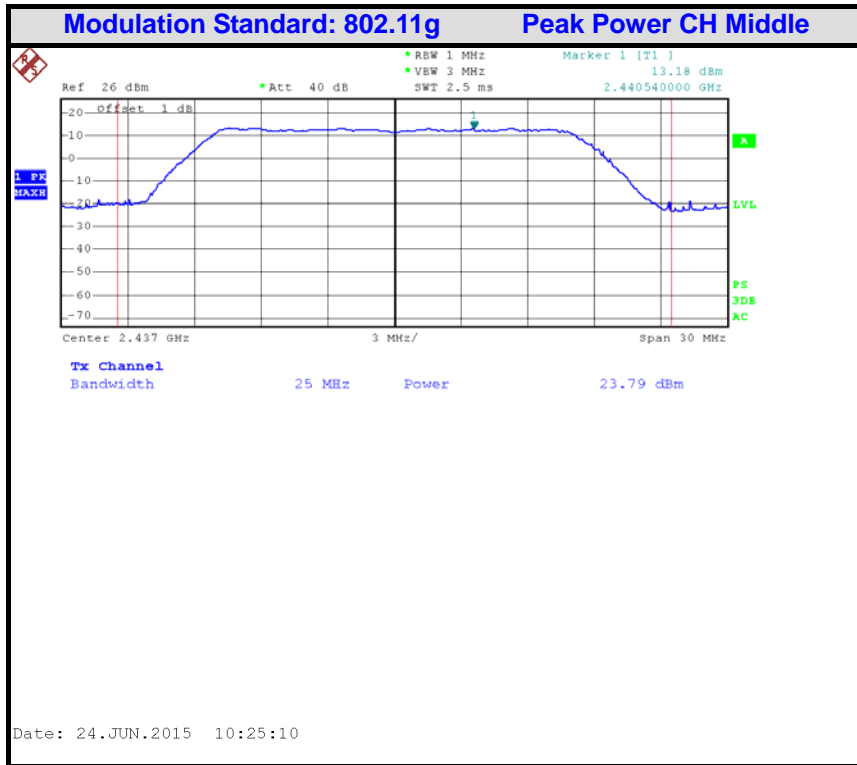

Copyright of this report is owned by Centre of Testing Service and may not be reproduced other than in full except with the written approval of the issuing Company.

CENTRE OF TESTING SERVICE CO., LTD.

A101, No.65, Zhuji Highway, Tianhe District, Guangzhou, China
Tel: +86-20-85543113 (32 lines) Fax: +86-20-38780406
Complaint line: +86-20-85533471 E-mail: cts@cts-lab.com.cn

See Reverse For Terms And Conditions of Service

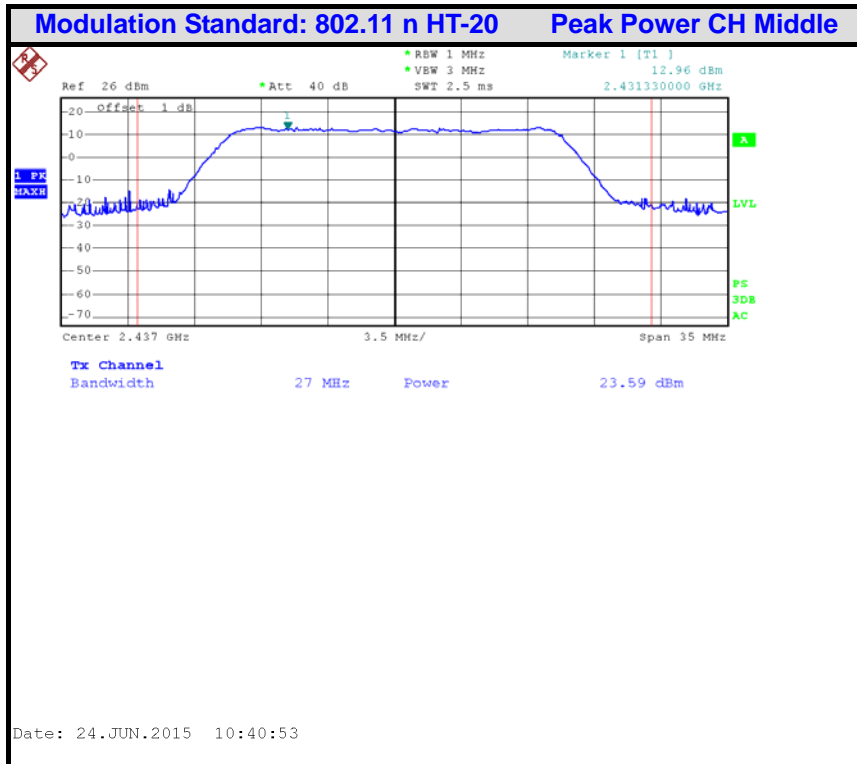
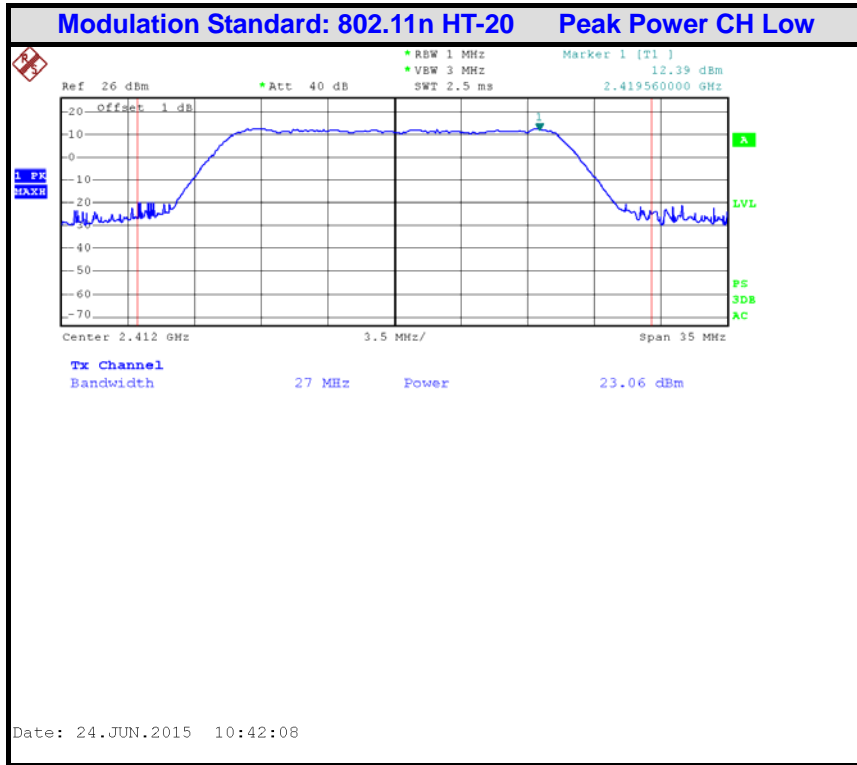

Copyright of this report is owned by Centre of Testing Service and may not be reproduced other than in full except with the written approval of the issuing Company.

CENTRE OF TESTING SERVICE CO., LTD.

A101, No.65, Zhuji Highway, Tianhe District, Guangzhou, China

Tel: +86-20-85543113 (32 lines)

Fax: +86-20-38780406

Complaint line: +86-20-85533471

E-mail: cts@cts-lab.com.cn

See Reverse For Terms And Conditions of Service

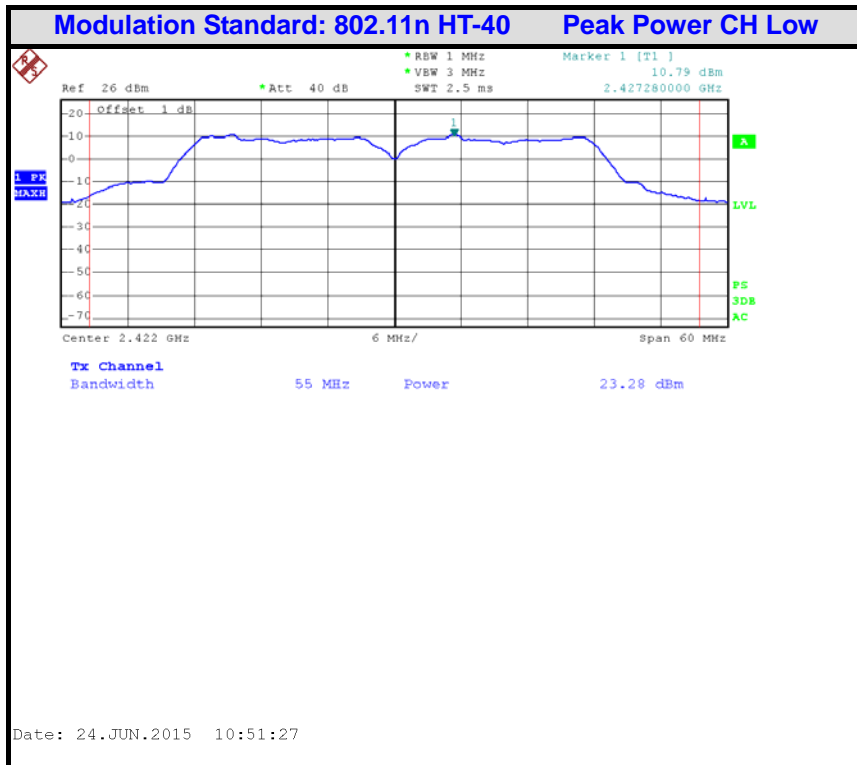
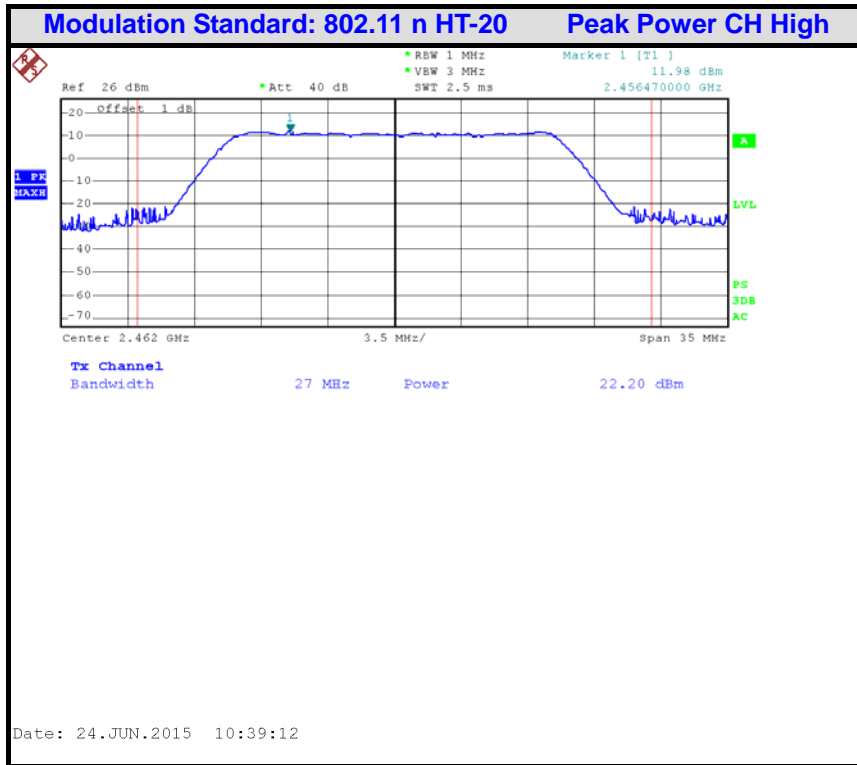

Copyright of this report is owned by Centre of Testing Service and may not be reproduced other than in full except with the written approval of the issuing Company.

CENTRE OF TESTING SERVICE CO., LTD.

A101, No.65, Zhuji Highway, Tianhe District, Guangzhou, China

Tel: +86-20-85543113 (32 lines)

Fax: +86-20-38780406

Complaint line: +86-20-85533471

E-mail: cts@cts-lab.com.cn

See Reverse For Terms And Conditions of Service

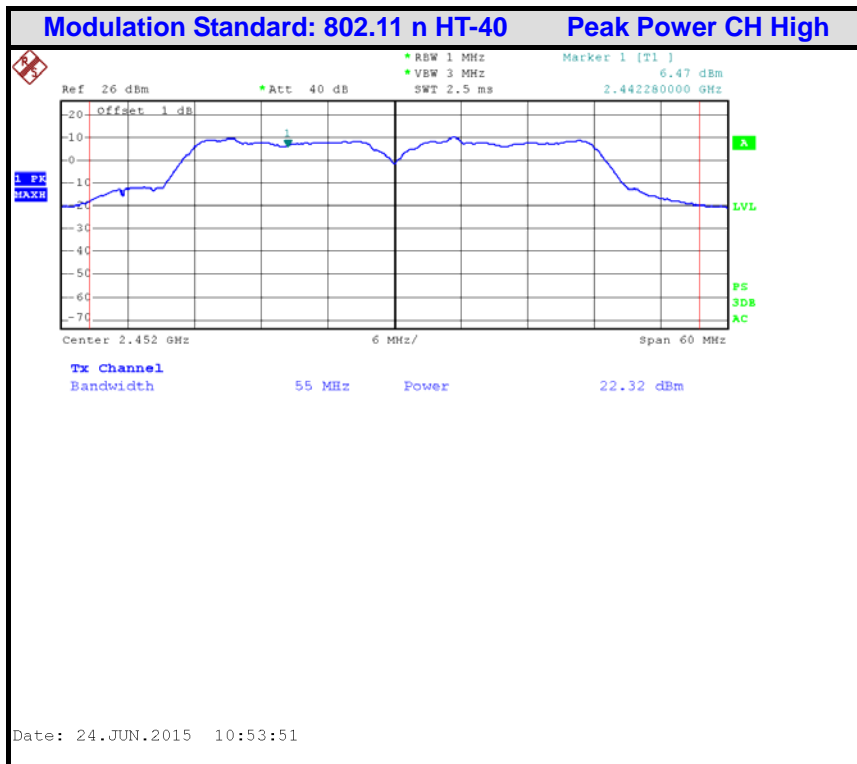
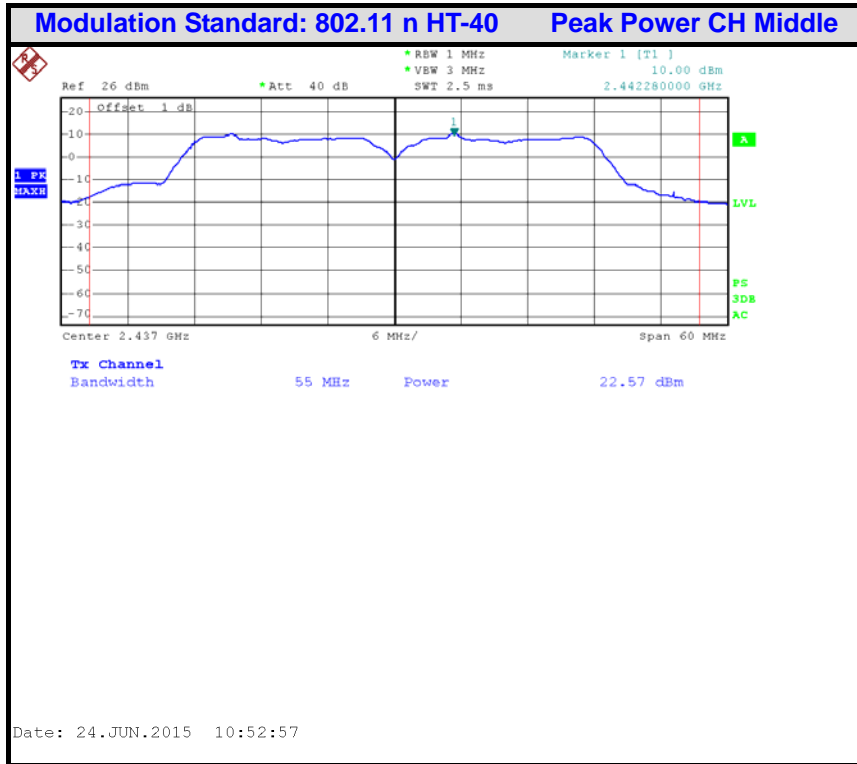

Copyright of this report is owned by Centre of Testing Service and may not be reproduced other than in full except with the written approval of the issuing Company.

CENTRE OF TESTING SERVICE CO., LTD.

A101, No.65, Zhuji Highway, Tianhe District, Guangzhou, China

Tel: +86-20-85543113 (32 lines)

Fax: +86-20-38780406

Complaint line: +86-20-85533471

E-mail: cts@cts-lab.com.cn

See Reverse For Terms And Conditions of Service

9.0 PEAK POWER SPECTRAL DENSITY

9.1 LIMIT

1. For direct sequence systems, the peak power spectral density conducted from the intentional radiator to the antenna shall not be greater than 8dBm in any 3kHz band during any time interval of continuous transmission.
2. The direct sequence operating of the hybrid system, with the frequency hopping operation turned off, shall comply with the power density requirements of paragraph (d) of this section

9.2 MEASUREMENT EQUIPMENT USED

Peak Power Spectral Density					
Item	Test Equipment	Manufacturer	Model No.	Serial No.	Last Cal.
1	Signal analyzer	ROHDE & SCHWARZ	FSIQ26	100311	2015/03

9.3 TEST CONFIGURATION

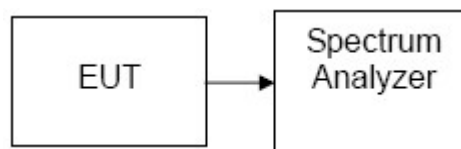

9.4 TEST PROCEDURE

1. Place the EUT on the table and set it in transmitting mode.
2. Remove the antenna from the EUT and then connect a low loss RF cable from the antenna port to the spectrum analyzer.
3. Set the spectrum analyzer as RBW = 10kHz, VBW = 30kHz, Span = 1.5 times the bandwidth, Sweep=Auto couple
4. Record the max. reading.
5. Repeat the above procedure until the measurements for all frequencies are completed.

9.5 TEST RESULTS

PASSED

Test Data

Modulation Standard	Channel	Frequency (MHz)	PPSD (dBm)			Limit (dBm)	Result
			Chain a	Chain b	Mix		
802.11b: 5.5Mbps (Worst Case)	Low	2412	-0.57	-2.31	1.66	8	PASSED
	Middle	2437	-0.48	-1.26	2.16		PASSED
	High	2462	-0.77	-2.46	1.48		PASSED
802.11g: 54Mbps (Worst Case)	Low	2412	-8.72	-7.76	-5.20	8	PASSED
	Middle	2437	-7.57	-7.55	-4.55		PASSED
	High	2462	-7.64	-8.29	-4.94		PASSED
802.11n(20): 300Mbps (Worst Case)	Low	2412	-7.26	-6.91	-4.07	8	PASSED
	Middle	2437	-6.01	-5.83	-2.91		PASSED
	High	2462	-6.43	-7.74	-4.03		PASSED
802.11n(40): 300Mbps (Worst Case)	Low	2422	-10.03	-9.32	-6.65	8	PASSED
	Middle	2437	-9.24	-9.61	-6.41		PASSED
	High	2452	-9.16	-10.59	-6.81		PASSED

Copyright of this report is owned by Centre of Testing Service and may not be reproduced other than in full except with the written approval of the issuing Company.

CENTRE OF TESTING SERVICE CO., LTD.

A101, No.65, Zhuji Highway, Tianhe District, Guangzhou, China

Tel: +86-20-85543113 (32 lines)

Fax: +86-20-38780406

Complaint line: +86-20-85533471

E-mail: cts@cts-lab.com.cn

See Reverse For Terms And Conditions of Service



Test Plot
Chain:a

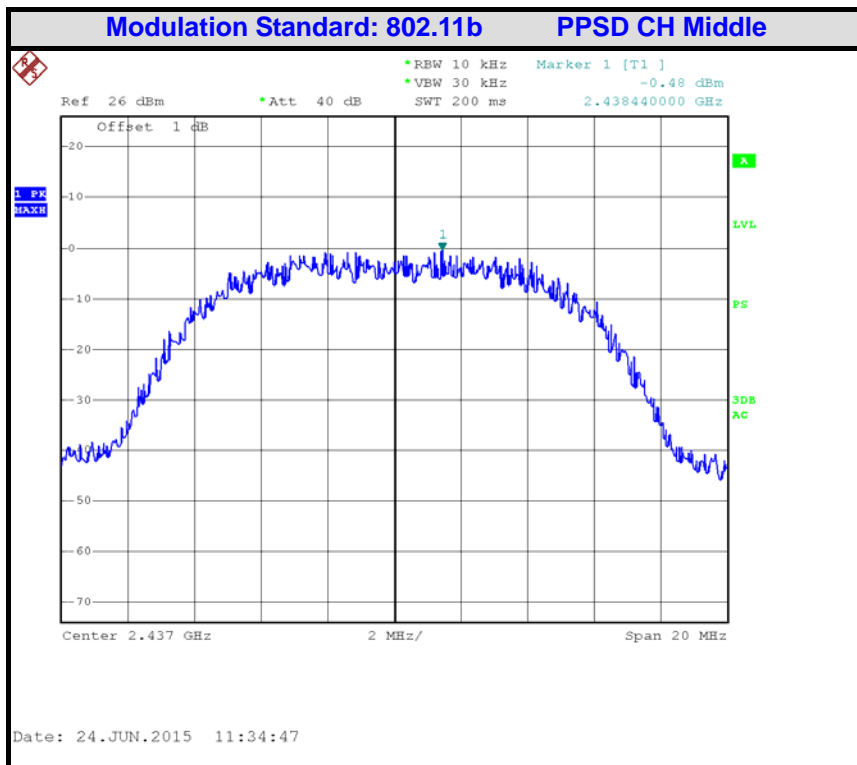
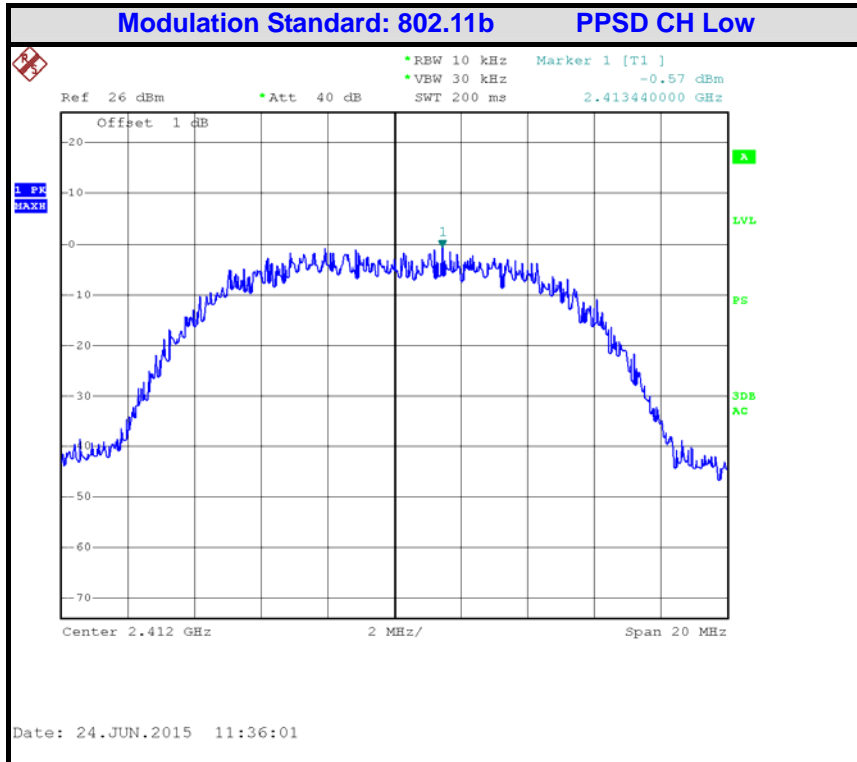

Copyright of this report is owned by Centre of Testing Service and may not be reproduced other than in full except with the written approval of the issuing Company.

CENTRE OF TESTING SERVICE CO., LTD.

A101, No.65, Zhuji Highway, Tianhe District, Guangzhou, China

Tel: +86-20-85543113 (32 lines)

Fax: +86-20-38780406

Complaint line: +86-20-85533471

E-mail: cts@cts-lab.com.cn

See Reverse For Terms And Conditions of Service

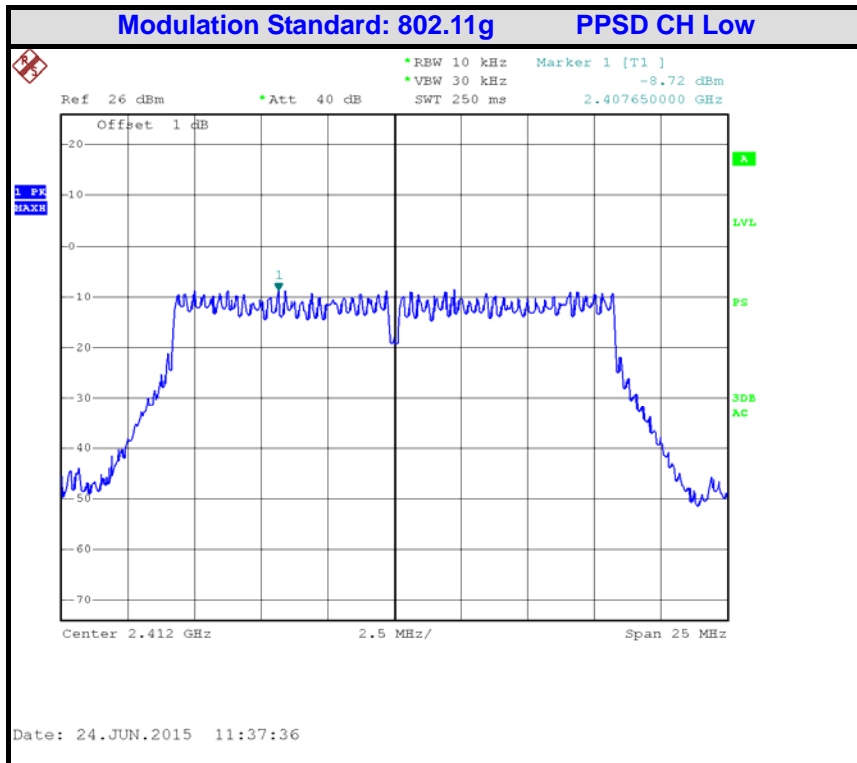
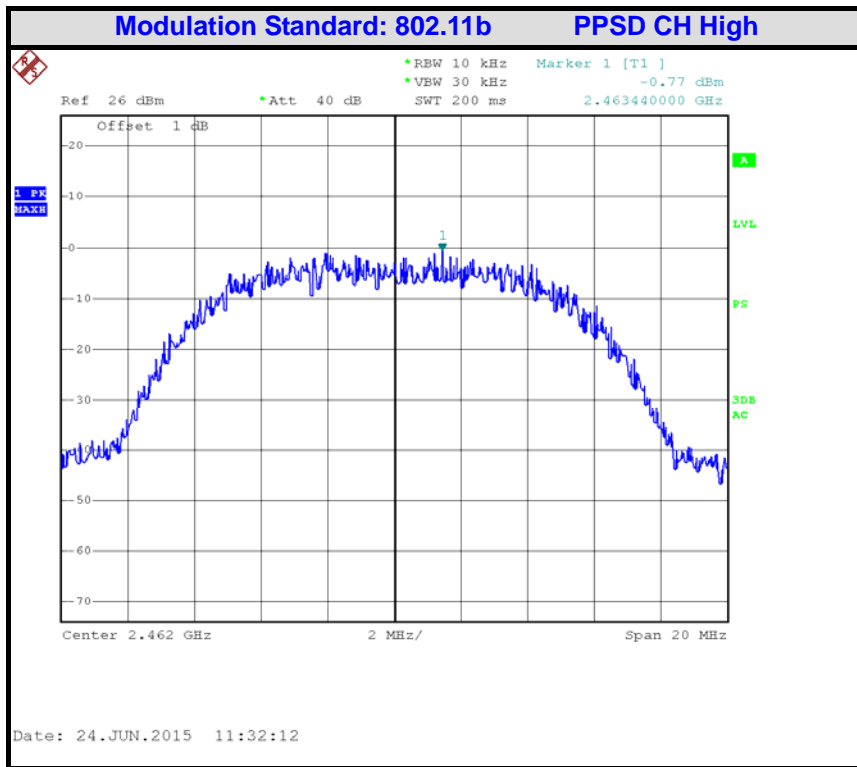

Copyright of this report is owned by Centre of Testing Service and may not be reproduced other than in full except with the written approval of the issuing Company.

CENTRE OF TESTING SERVICE CO., LTD.

A101, No.65, Zhuji Highway, Tianhe District, Guangzhou, China

Tel: +86-20-85543113 (32 lines)

Fax: +86-20-38780406

Complaint line: +86-20-85533471

E-mail: cts@cts-lab.com.cn

See Reverse For Terms And Conditions of Service

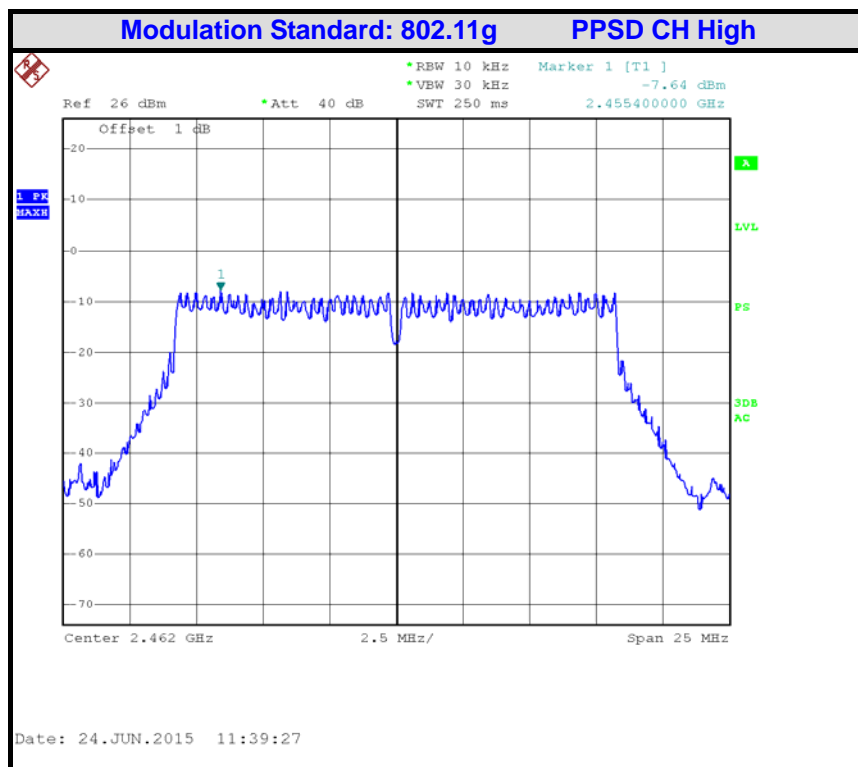
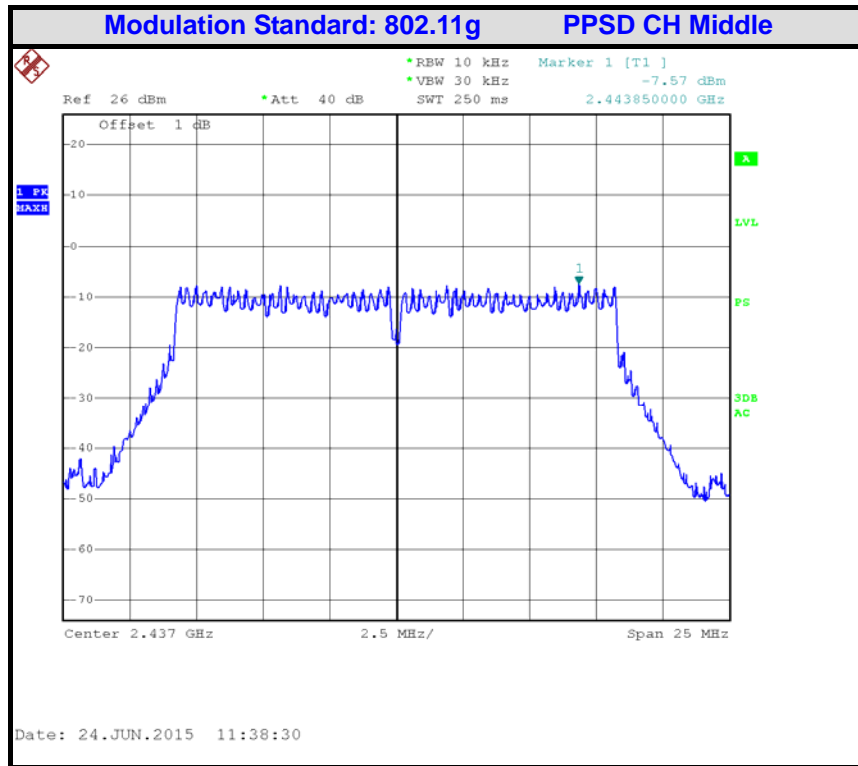

Copyright of this report is owned by Centre of Testing Service and may not be reproduced other than in full except with the written approval of the issuing Company.

CENTRE OF TESTING SERVICE CO., LTD.

A101, No.65, Zhuji Highway, Tianhe District, Guangzhou, China

Tel: +86-20-85543113 (32 lines)

Fax: +86-20-38780406

Complaint line: +86-20-85533471

E-mail: cts@cts-lab.com.cn

See Reverse For Terms And Conditions of Service

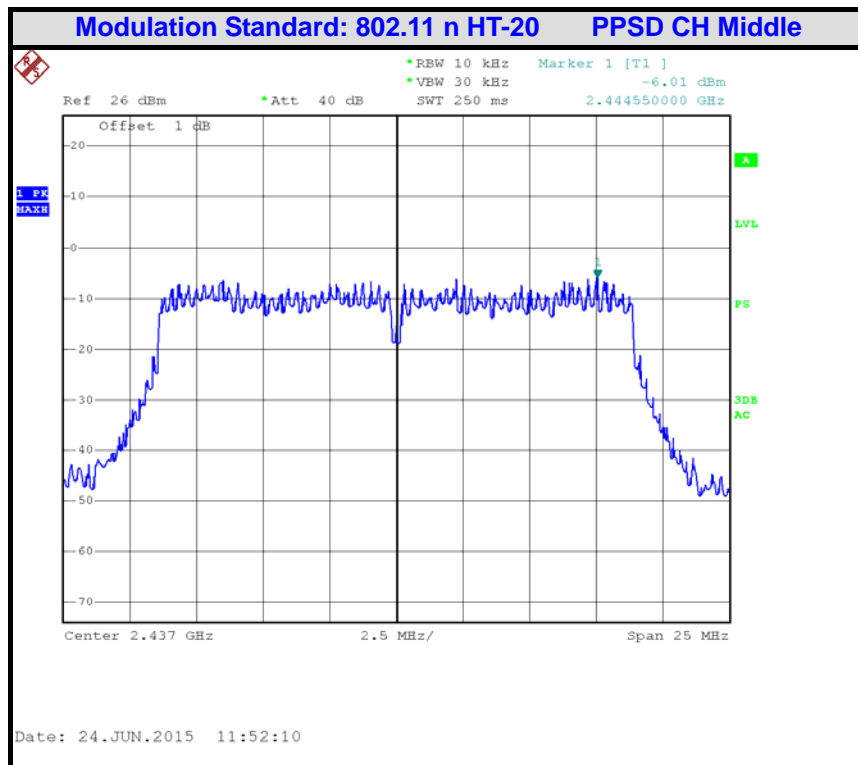
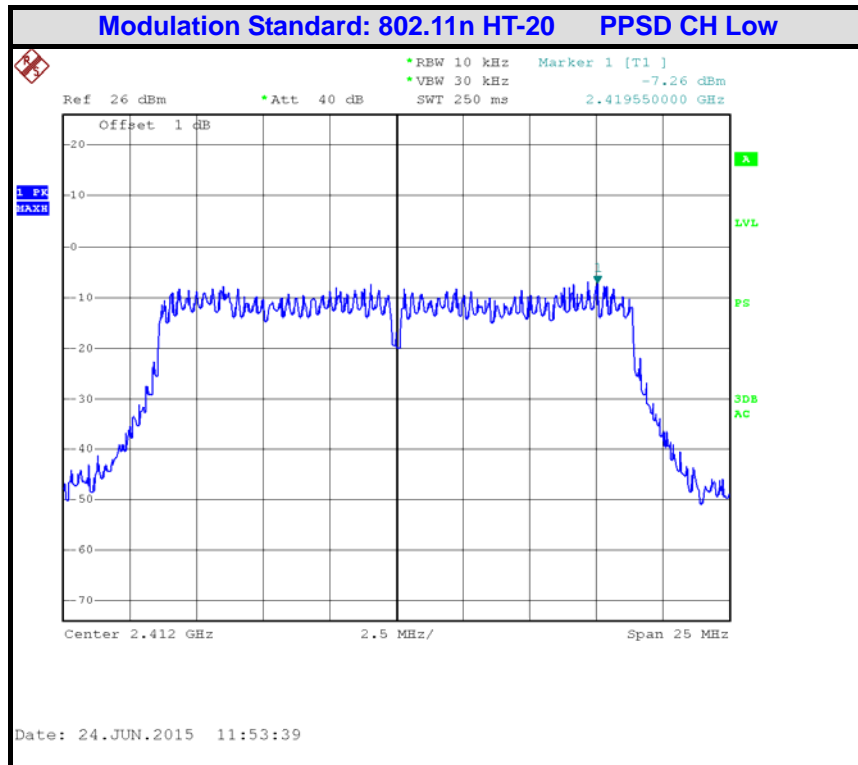

Copyright of this report is owned by Centre of Testing Service and may not be reproduced other than in full except with the written approval of the issuing Company.

CENTRE OF TESTING SERVICE CO., LTD.

A101, No.65, Zhuji Highway, Tianhe District, Guangzhou, China

Tel: +86-20-85543113 (32 lines)

Fax: +86-20-38780406

Complaint line: +86-20-85533471

E-mail: cts@cts-lab.com.cn

See Reverse For Terms And Conditions of Service

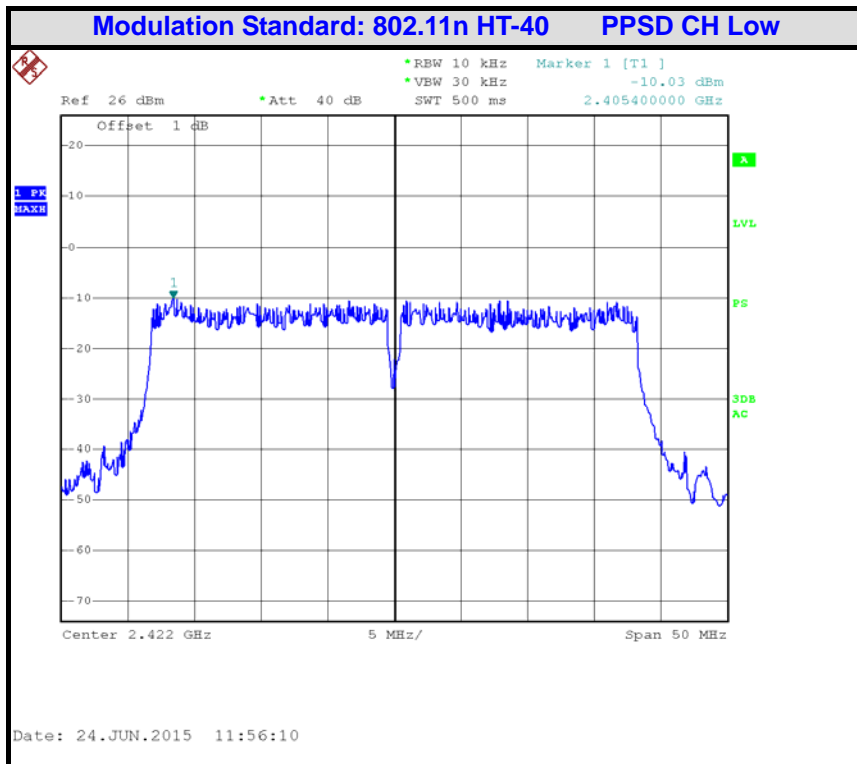
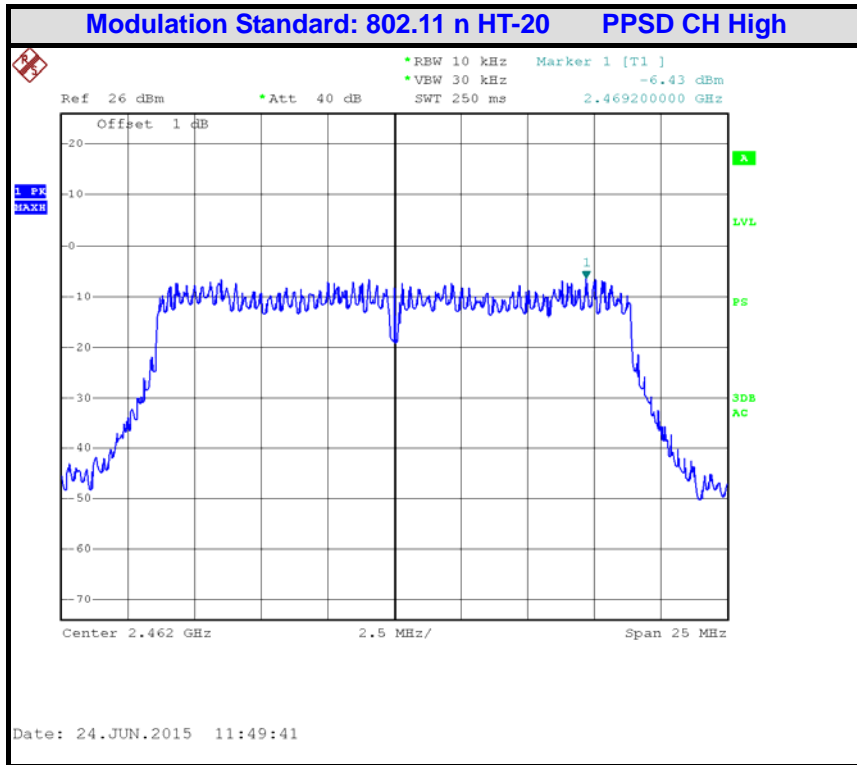

Copyright of this report is owned by Centre of Testing Service and may not be reproduced other than in full except with the written approval of the issuing Company.

CENTRE OF TESTING SERVICE CO., LTD.

A101, No.65, Zhuji Highway, Tianhe District, Guangzhou, China

Tel: +86-20-85543113 (32 lines)

Fax: +86-20-38780406

Complaint line: +86-20-85533471

E-mail: cts@cts-lab.com.cn

See Reverse For Terms And Conditions of Service

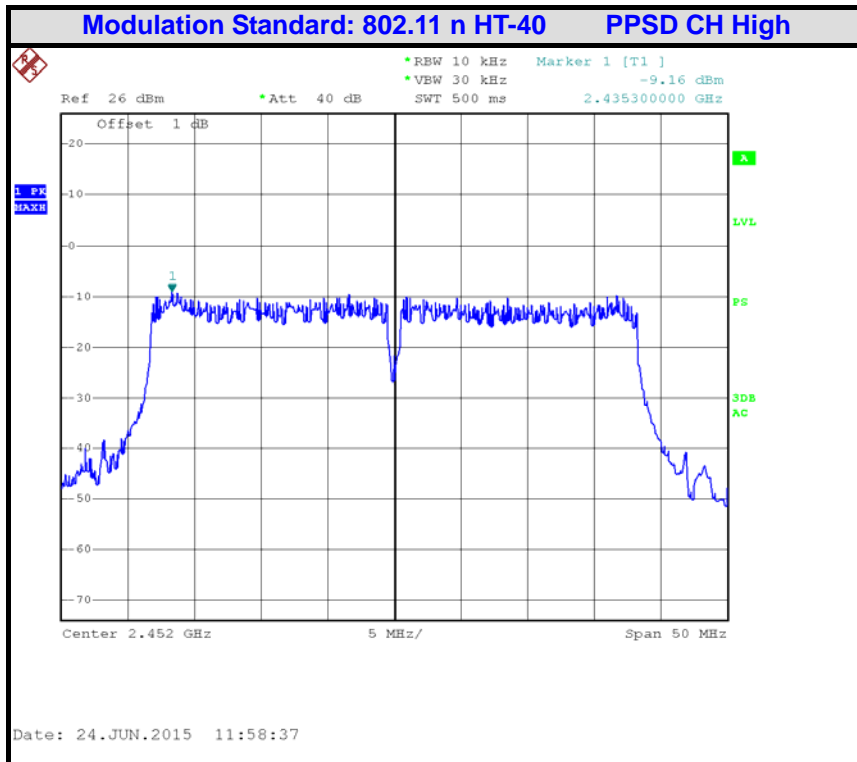
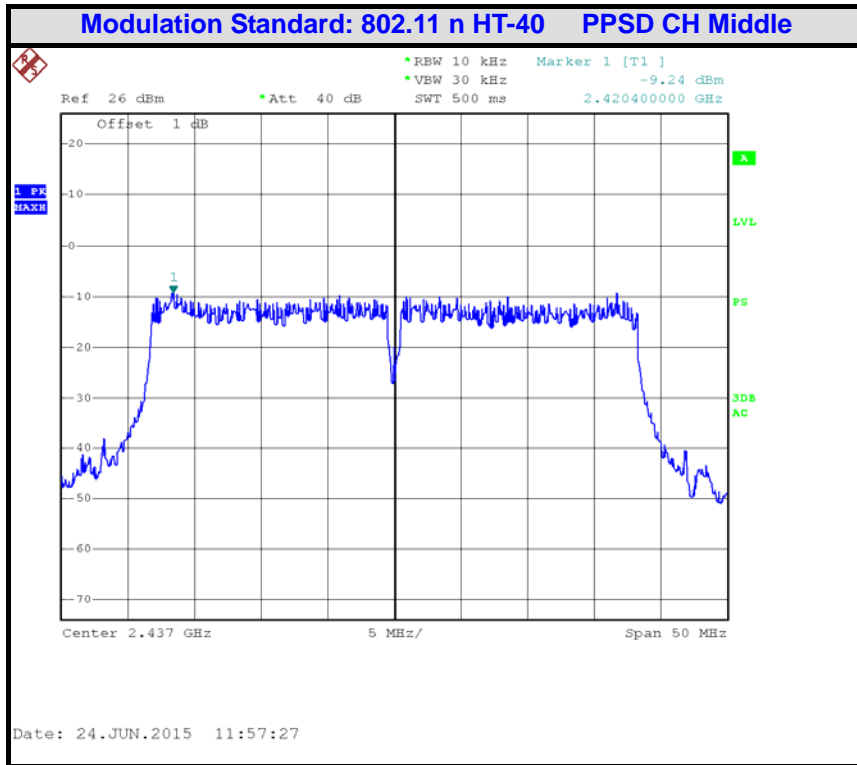

Copyright of this report is owned by Centre of Testing Service and may not be reproduced other than in full except with the written approval of the issuing Company.

CENTRE OF TESTING SERVICE CO., LTD.

A101, No.65, Zhuji Highway, Tianhe District, Guangzhou, China

Tel: +86-20-85543113 (32 lines)

Fax: +86-20-38780406

Complaint line: +86-20-85533471

E-mail: cts@cts-lab.com.cn

See Reverse For Terms And Conditions of Service



Chain:b

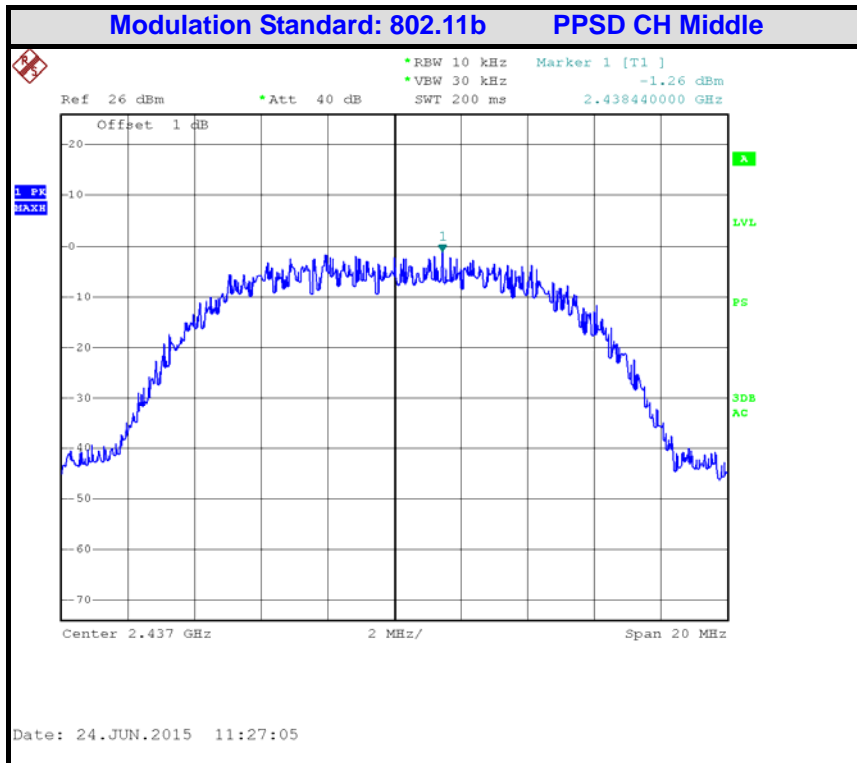
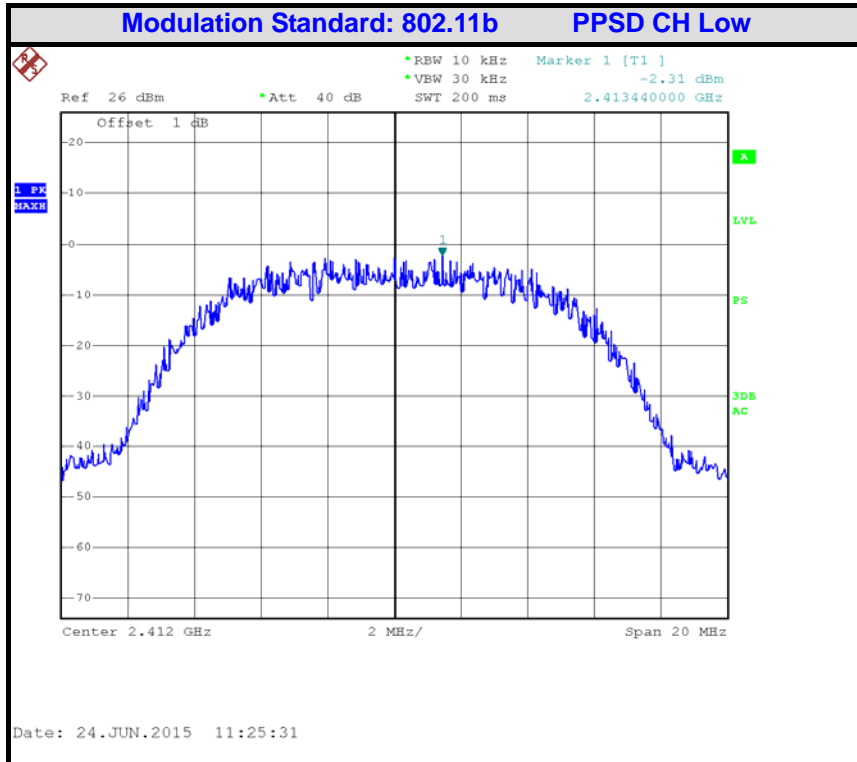

Copyright of this report is owned by Centre of Testing Service and may not be reproduced other than in full except with the written approval of the issuing Company.

CENTRE OF TESTING SERVICE CO., LTD.

A101, No.65, Zhuji Highway, Tianhe District, Guangzhou, China

Tel: +86-20-85543113 (32 lines)

Fax: +86-20-38780406

Complaint line: +86-20-85533471

E-mail: cts@cts-lab.com.cn

See Reverse For Terms And Conditions of Service

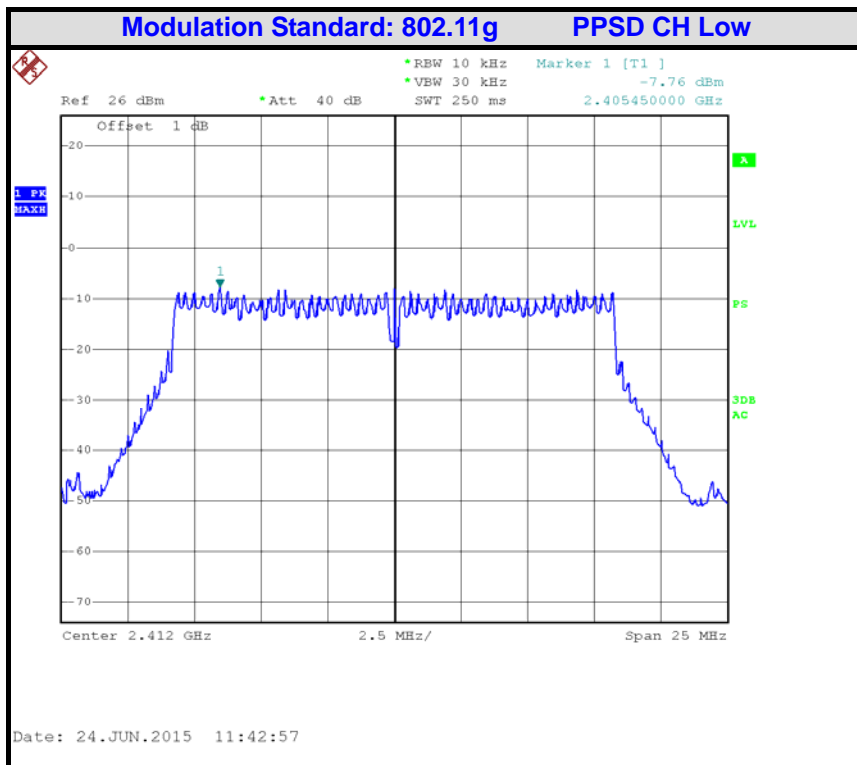
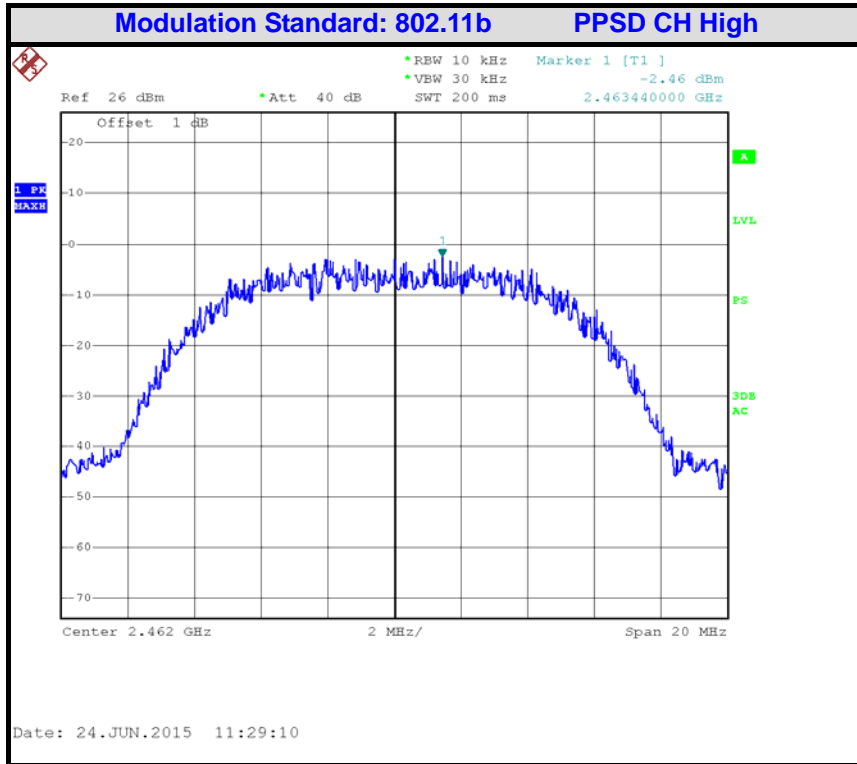

Copyright of this report is owned by Centre of Testing Service and may not be reproduced other than in full except with the written approval of the issuing Company.

CENTRE OF TESTING SERVICE CO., LTD.

A101, No.65, Zhuji Highway, Tianhe District, Guangzhou, China

Tel: +86-20-85543113 (32 lines)

Fax: +86-20-38780406

Complaint line: +86-20-85533471

E-mail: cts@cts-lab.com.cn

See Reverse For Terms And Conditions of Service

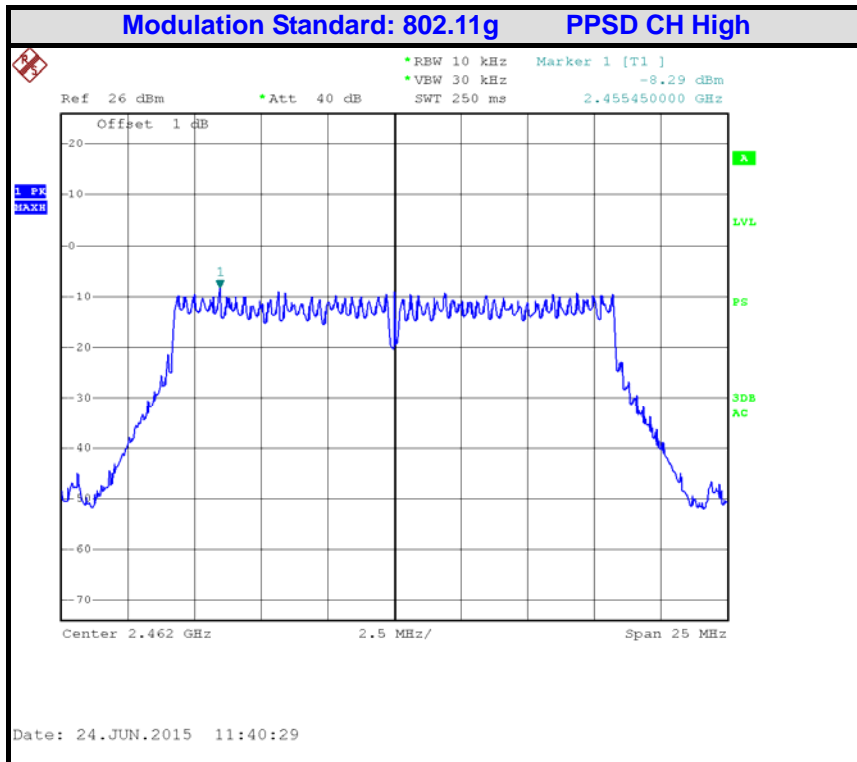
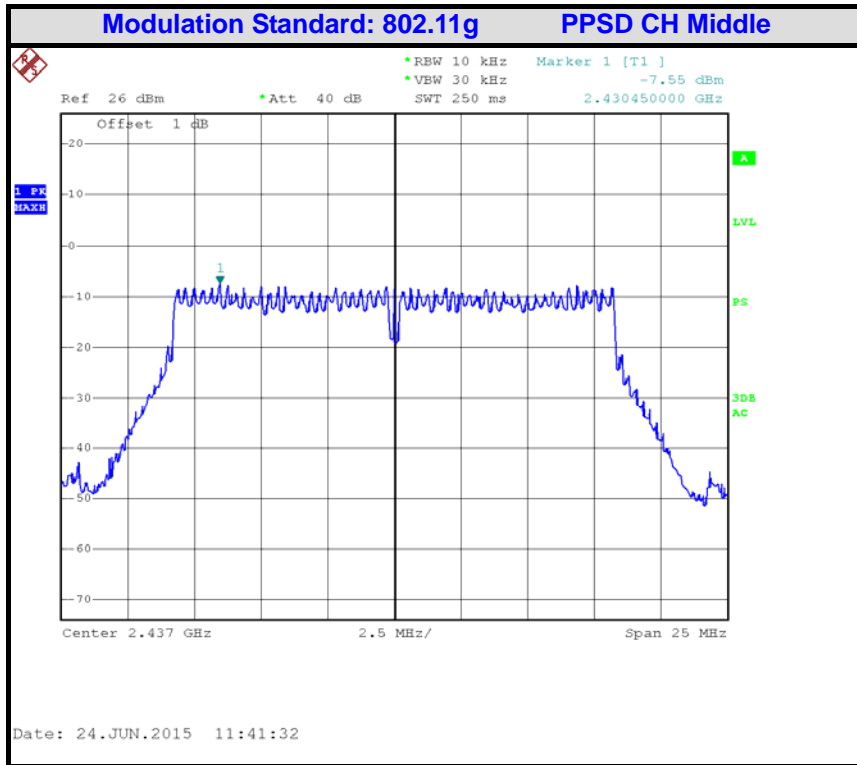

Copyright of this report is owned by Centre of Testing Service and may not be reproduced other than in full except with the written approval of the issuing Company.

CENTRE OF TESTING SERVICE CO., LTD.

A101, No.65, Zhuji Highway, Tianhe District, Guangzhou, China

Tel: +86-20-85543113 (32 lines)

Fax: +86-20-38780406

Complaint line: +86-20-85533471

E-mail: cts@cts-lab.com.cn

See Reverse For Terms And Conditions of Service

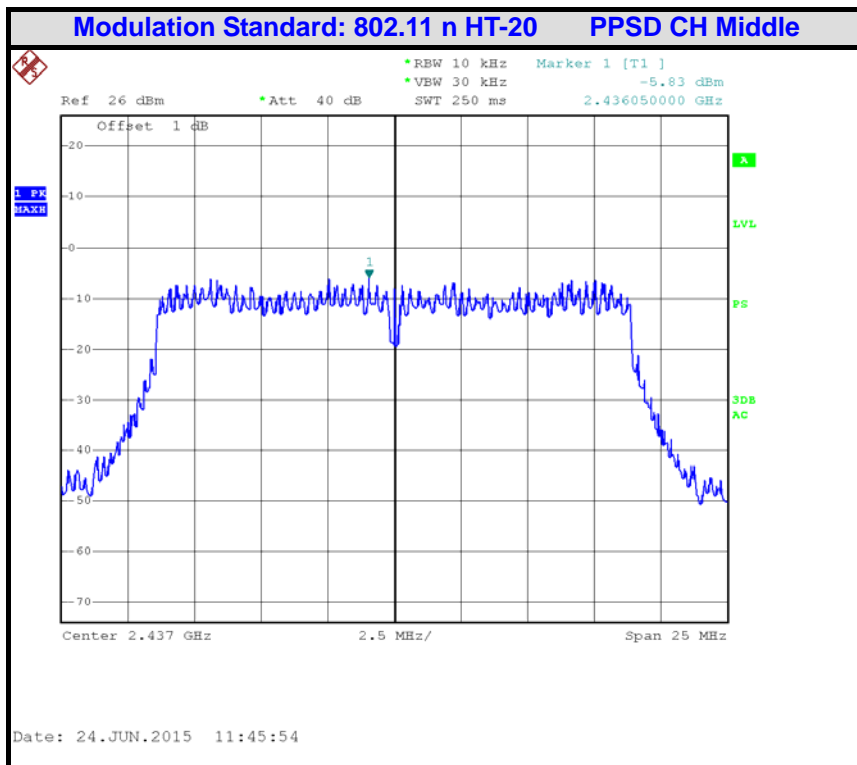
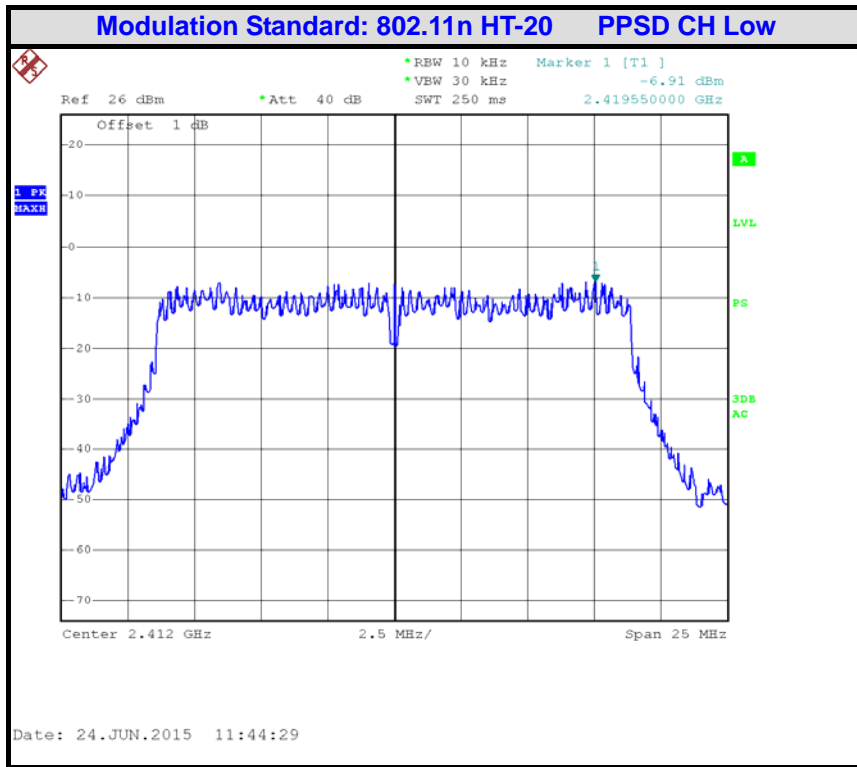

Copyright of this report is owned by Centre of Testing Service and may not be reproduced other than in full except with the written approval of the issuing Company.

CENTRE OF TESTING SERVICE CO., LTD.

A101, No.65, Zhuji Highway, Tianhe District, Guangzhou, China

Tel: +86-20-85543113 (32 lines)

Fax: +86-20-38780406

Complaint line: +86-20-85533471

E-mail: cts@cts-lab.com.cn

See Reverse For Terms And Conditions of Service

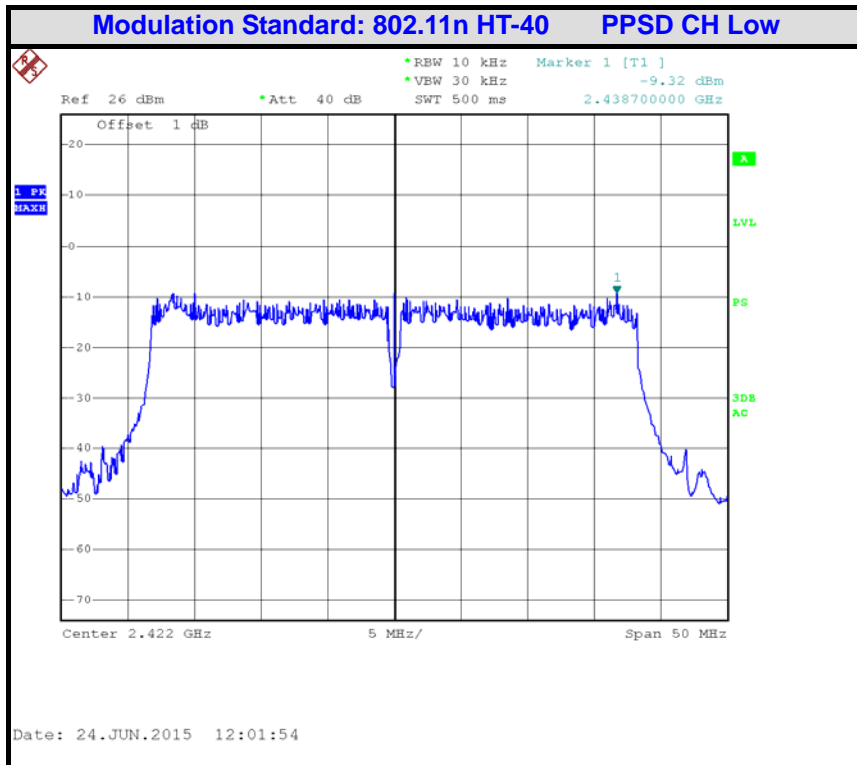
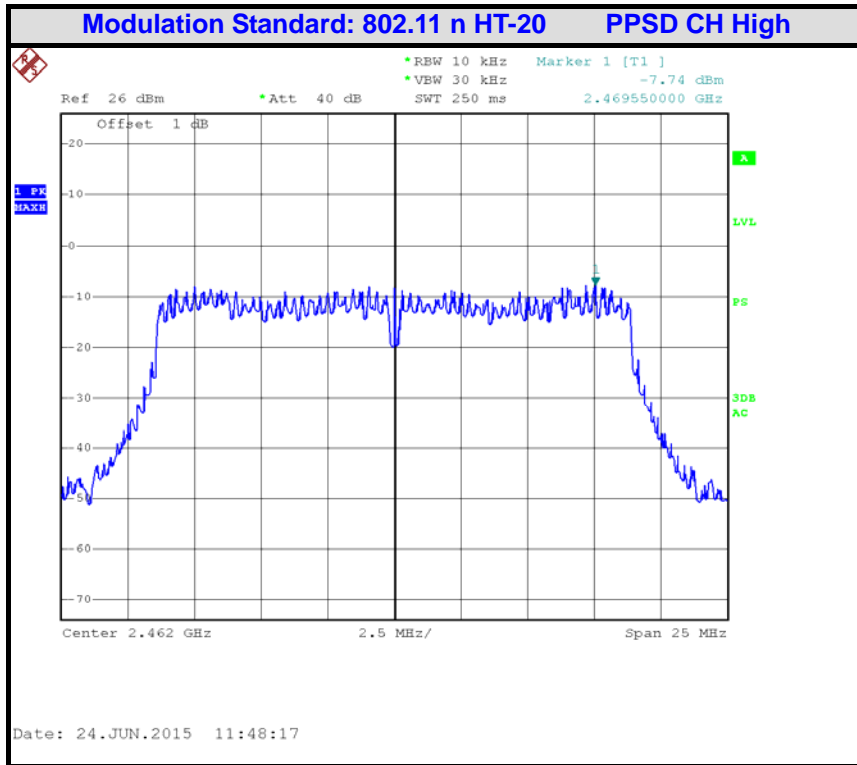

Copyright of this report is owned by Centre of Testing Service and may not be reproduced other than in full except with the written approval of the issuing Company.

CENTRE OF TESTING SERVICE CO., LTD.

A101, No.65, Zhuji Highway, Tianhe District, Guangzhou, China

Tel: +86-20-85543113 (32 lines)

Fax: +86-20-38780406

Complaint line: +86-20-85533471

E-mail: cts@cts-lab.com.cn

See Reverse For Terms And Conditions of Service

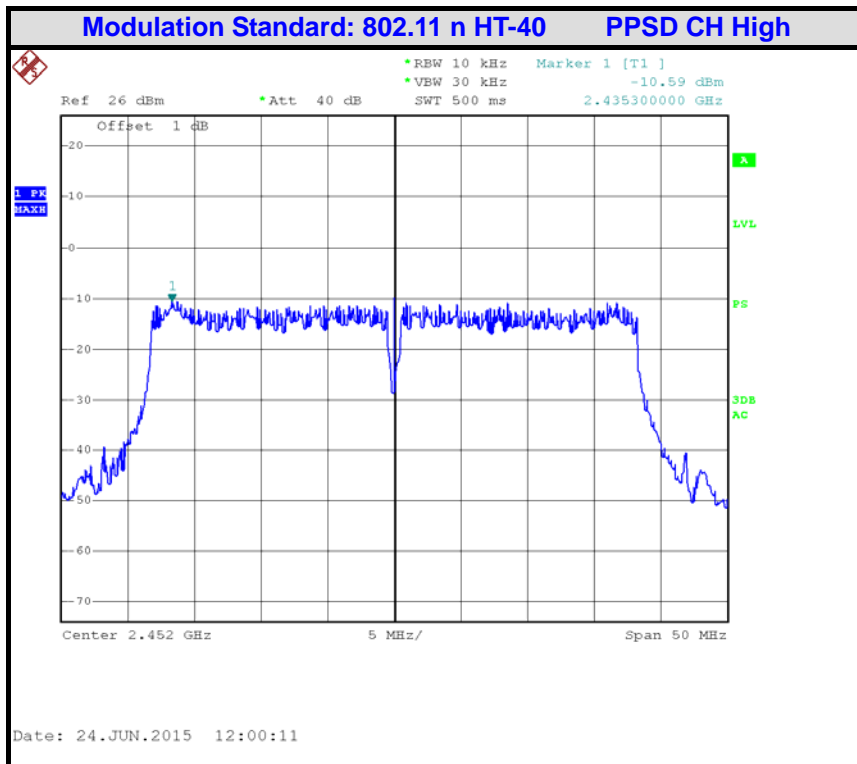
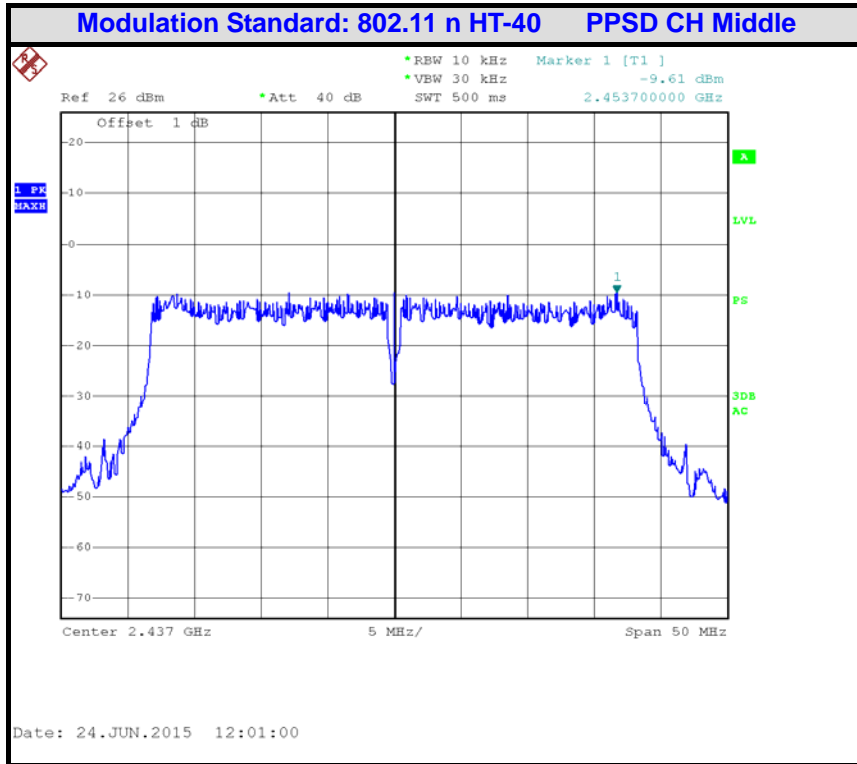

Copyright of this report is owned by Centre of Testing Service and may not be reproduced other than in full except with the written approval of the issuing Company.

CENTRE OF TESTING SERVICE CO., LTD.

A101, No.65, Zhuji Highway, Tianhe District, Guangzhou, China

Tel: +86-20-85543113 (32 lines)

Fax: +86-20-38780406

Complaint line: +86-20-85533471

E-mail: cts@cts-lab.com.cn

See Reverse For Terms And Conditions of Service

10.0 BAND EDGES MEASUREMENT

10.1 LIMIT

According to §15.247(d), in any 100 kHz bandwidth outside the frequency bands in which the spread spectrum intentional radiator is operating, the radio frequency power that is produced by the intentional radiator shall be at least 20 dB below that in the 100 kHz bandwidth within the band that contains the highest level of the desired power, based on either an RF conducted or a radiated measurement, provided the transmitter demonstrates compliance with the peak conducted power limits. In addition, radiated emissions which fall in the restricted bands, as defined in §15.205(a), must also comply with the radiated emission limits specified in 15.209(a) (see Section 15.205(c)).

10.2 MEASUREMENT EQUIPMENT USED

Radiated disturbance (electric field)					
Item	Test Equipment	Manufacturer	Model No.	Serial No.	Last Cal.
1	EMI Test Receiver	ROHDE & SCHWARZ	ESCI	100868	2014/11
2	Biconical Antenna	ROHDE & SCHWARZ	HK116	100221	2015/03
3	Log per Antenna	ROHDE & SCHWARZ	HL223	100226	2015/03
4	Log per Antenna	ROHDE & SCHWARZ	HL050	100186	2015/03
5	Signal analyzer	ROHDE & SCHWARZ	FSIQ26	100311	2015/03
6	Loop Antenna	A.R.A	PLA-1030/B	1030	2014/11
7	EMI Test Software	EZ-EMC	Farad	N/A	N/A

10.3 Test Configuration

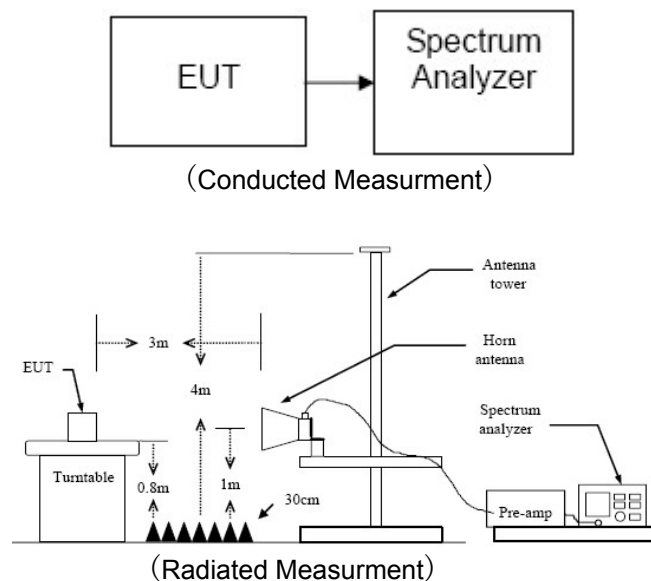

Copyright of this report is owned by Centre of Testing Service and may not be reproduced other than in full except with the written approval of the issuing Company.

CENTRE OF TESTING SERVICE CO., LTD.

A101, No.65, Zhuji Highway, Tianhe District, Guangzhou, China

Tel: +86-20-85543113 (32 lines)

Fax: +86-20-38780406

Complaint line: +86-20-85533471

E-mail: cts@cts-lab.com.cn

See Reverse For Terms And Conditions of Service

10.4 TEST PROCEDURE

Conducted Measurement:

1. Place the EUT on the table and set it in transmitting mode.
2. Remove the antenna from the EUT and then connect a low loss RF cable from the antenna port to the spectrum analyzer.
3. Set the spectrum analyzer as RBW = 100kHz, VBW = 300kHz, Sweep=Auto couple
4. Record the max. reading.
5. Repeat the above procedure until the measurements for all frequencies are

Radiated Measurement:

1. The EUT is placed on a turntable, which is 0.8m above the ground plane.
2. The turntable shall be rotated for 360 degrees to determine the position of maximum emission level.
3. EUT is set 3m away from the receiving antenna, which is varied from 1m to 4m to find out the highest emission.
4. Set the spectrum analyzer in the following setting in order to capture the lower and upper band-edges of the emission:
 - (a) PEAK: RBW=VBW=1MHz / Sweep=AUTO
 - (b) AVERAGE: RBW=1MHz / VBW=10Hz / Sweep=AUTO
5. Repeat the procedures until all the PEAK and AVERAGE versus POLARIZATION are measured.

10.5 TEST RESULTS

Refer to attach spectrum analyzer data chart.



Conducted Measurement:
Chain a:
Test Polt:

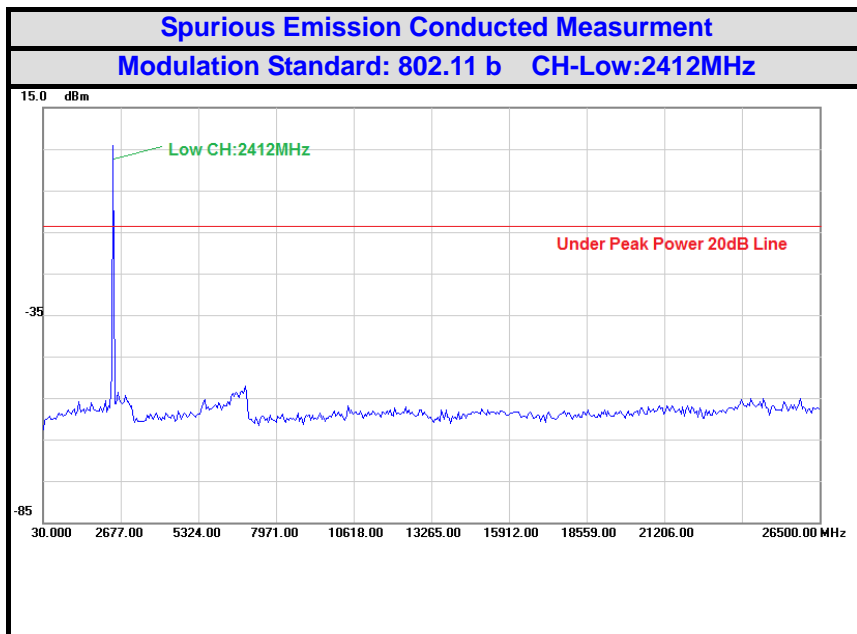
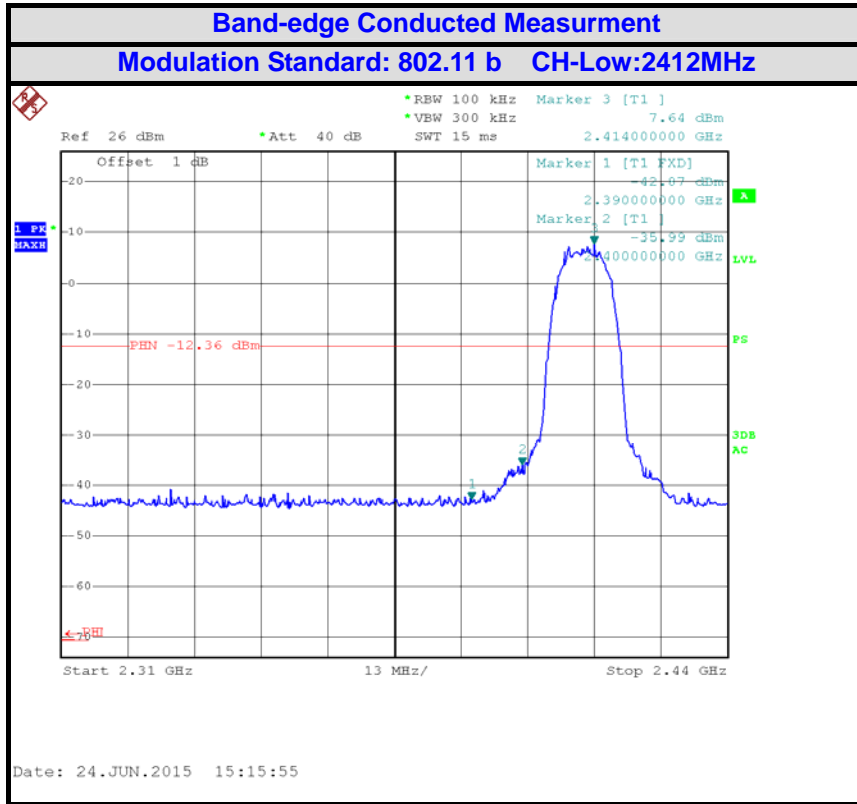

Copyright of this report is owned by Centre of Testing Service and may not be reproduced other than in full except with the written approval of the issuing Company.

CENTRE OF TESTING SERVICE CO., LTD.

A101, No.65, Zhuji Highway, Tianhe District, Guangzhou, China
Tel: +86-20-85543113 (32 lines) Fax: +86-20-38780406
Complaint line: +86-20-85533471 E-mail: cts@cts-lab.com.cn

See Reverse For Terms And Conditions of Service

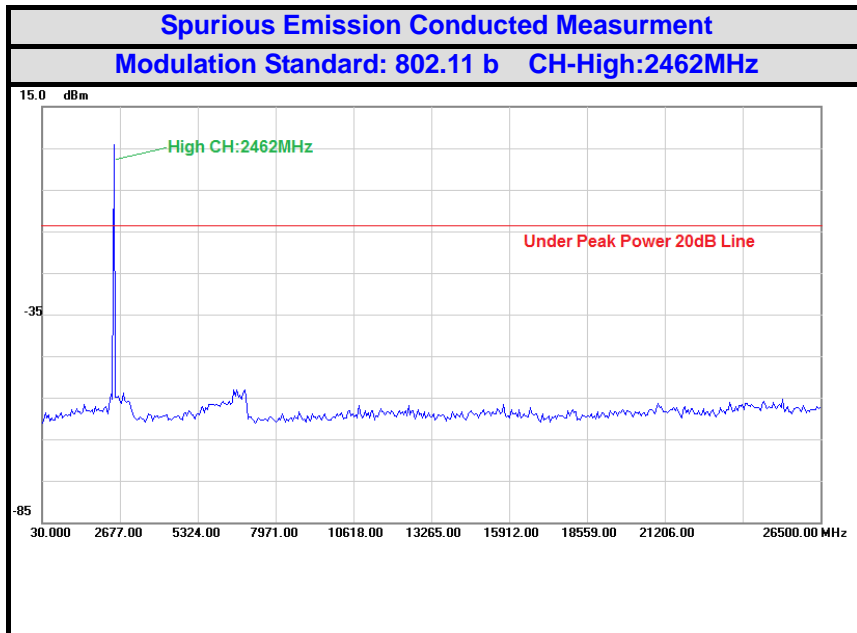
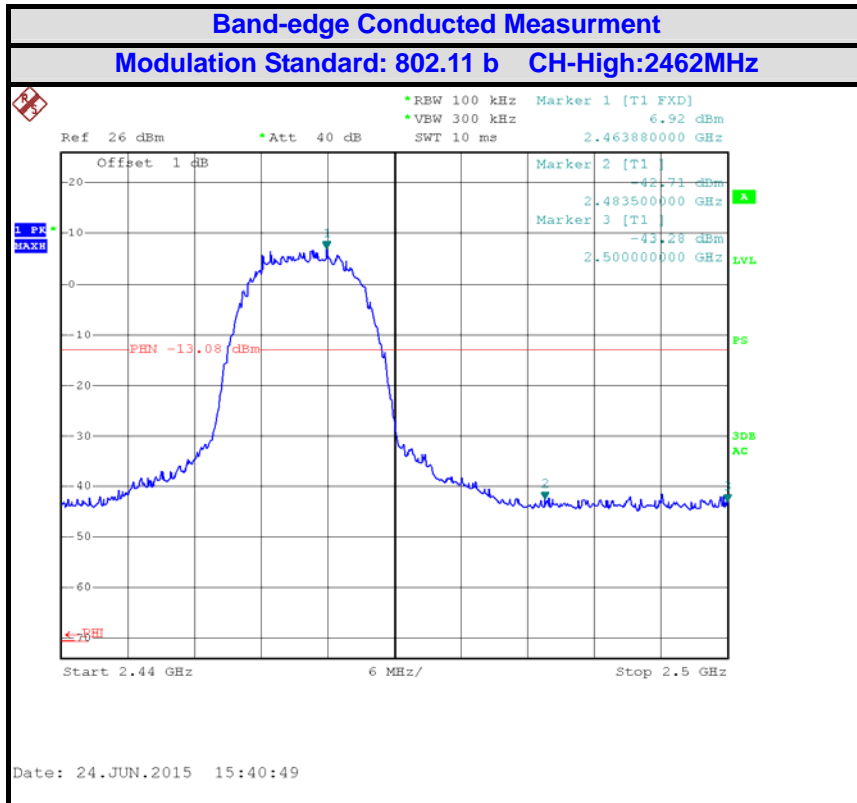

Copyright of this report is owned by Centre of Testing Service and may not be reproduced other than in full except with the written approval of the issuing Company.

CENTRE OF TESTING SERVICE CO., LTD.

A101, No.65, Zhuji Highway, Tianhe District, Guangzhou, China
Tel: +86-20-85543113 (32 lines) Fax: +86-20-38780406
Complaint line: +86-20-85533471 E-mail: cts@cts-lab.com.cn

See Reverse For Terms And Conditions of Service

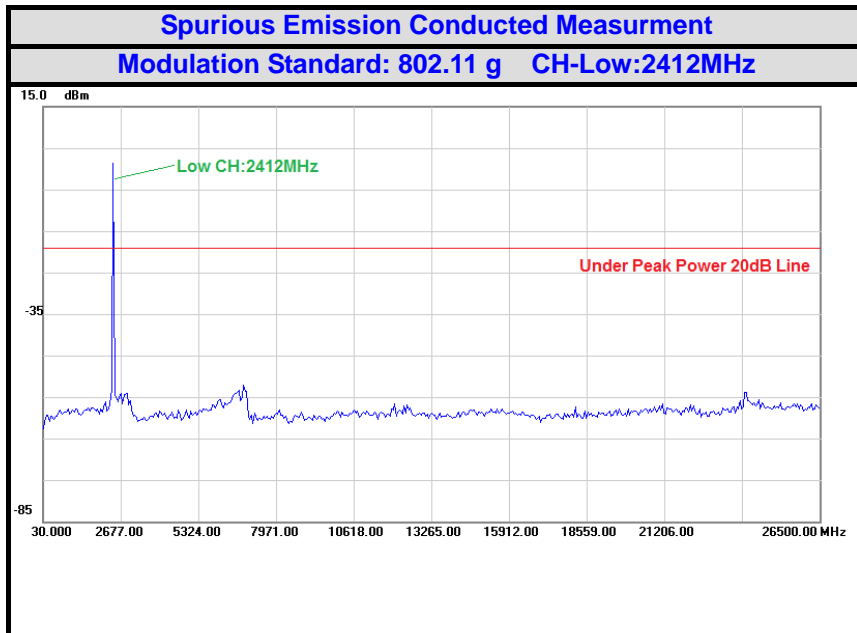
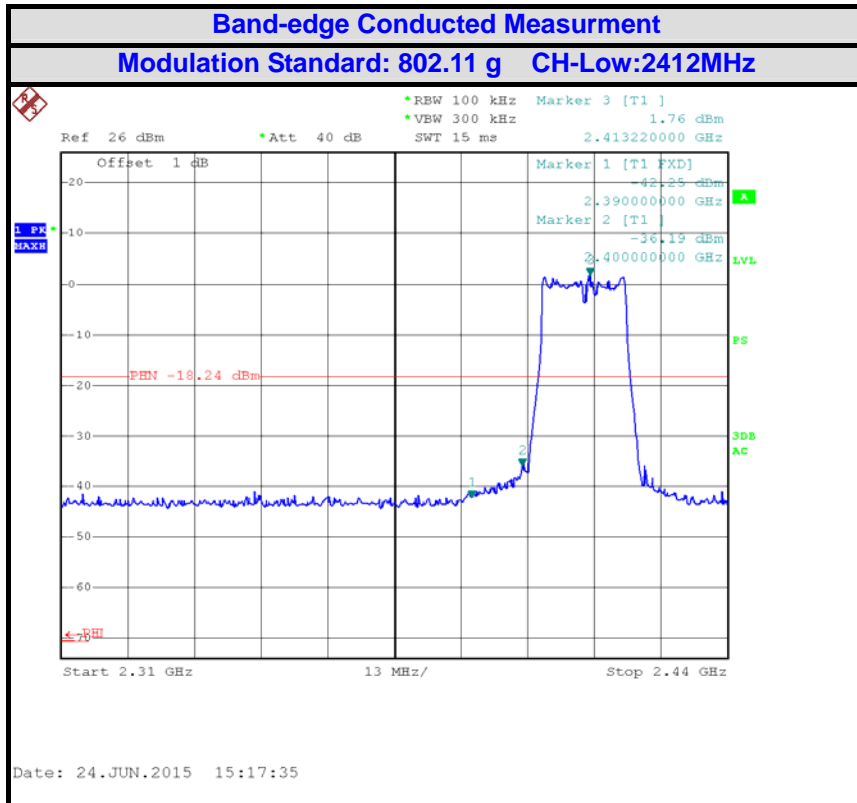

Copyright of this report is owned by Centre of Testing Service and may not be reproduced other than in full except with the written approval of the issuing Company.

CENTRE OF TESTING SERVICE CO., LTD.

A101, No.65, Zhuji Highway, Tianhe District, Guangzhou, China

Tel: +86-20-85543113 (32 lines)

Fax: +86-20-38780406

Complaint line: +86-20-85533471

E-mail: cts@cts-lab.com.cn

See Reverse For Terms And Conditions of Service

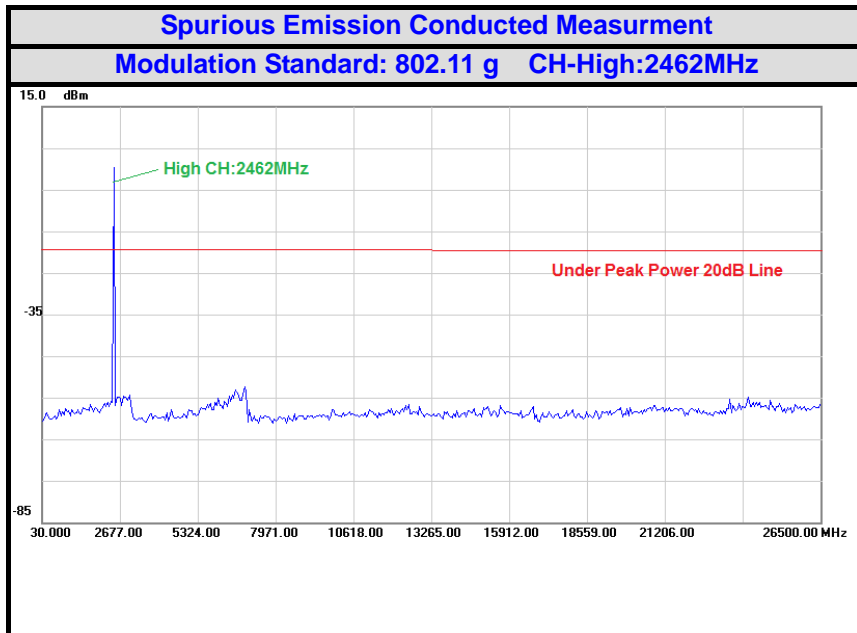
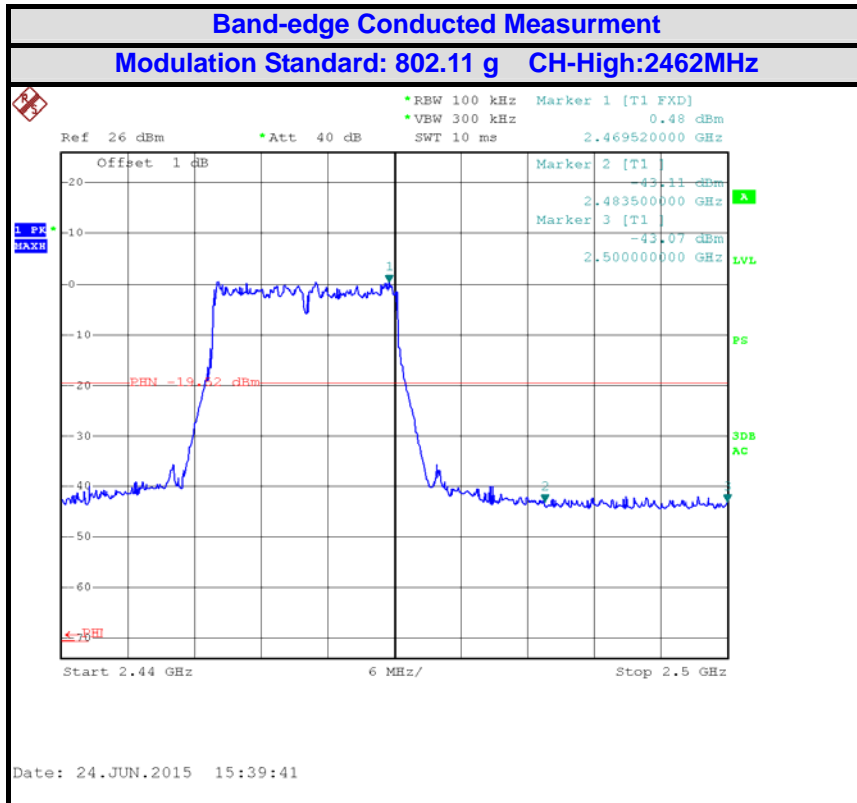

Copyright of this report is owned by Centre of Testing Service and may not be reproduced other than in full except with the written approval of the issuing Company.

CENTRE OF TESTING SERVICE CO., LTD.

A101, No.65, Zhuji Highway, Tianhe District, Guangzhou, China

Tel: +86-20-85543113 (32 lines)

Fax: +86-20-38780406

Complaint line: +86-20-85533471

E-mail: cts@cts-lab.com.cn

See Reverse For Terms And Conditions of Service

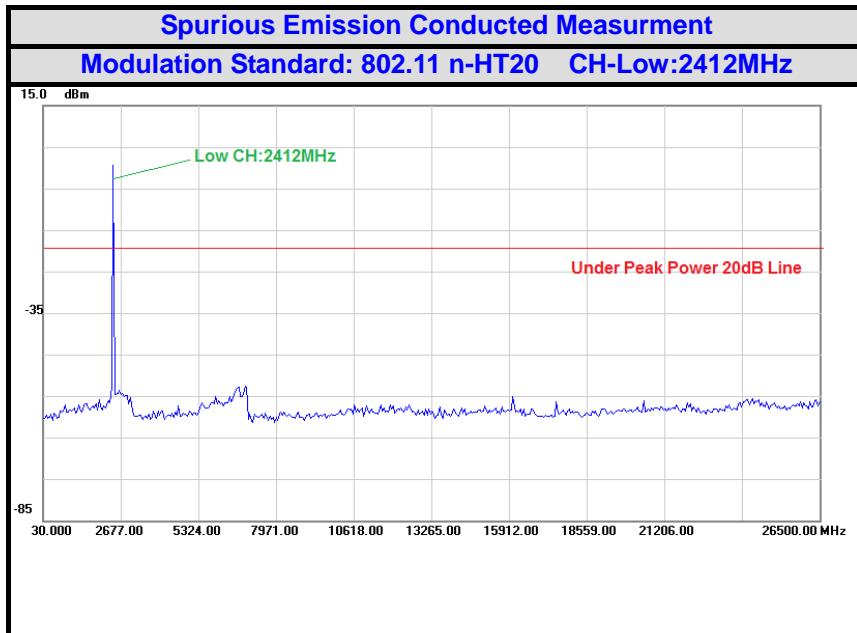
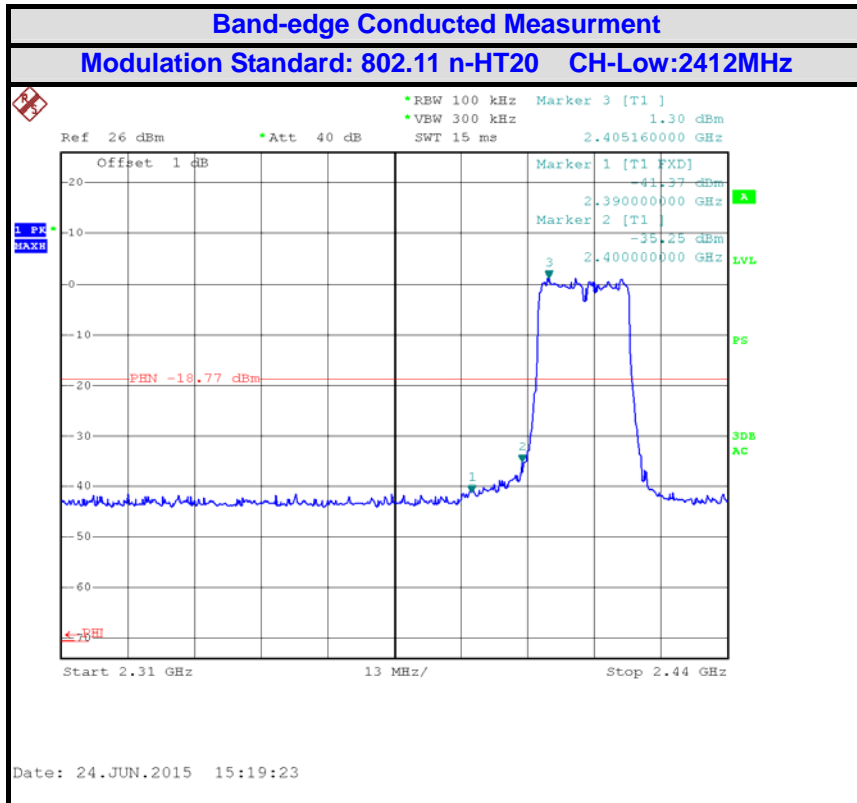

Copyright of this report is owned by Centre of Testing Service and may not be reproduced other than in full except with the written approval of the issuing Company.

CENTRE OF TESTING SERVICE CO., LTD.

A101, No.65, Zhuji Highway, Tianhe District, Guangzhou, China

Tel: +86-20-85543113 (32 lines)

Fax: +86-20-38780406

Complaint line: +86-20-85533471

E-mail: cts@cts-lab.com.cn

See Reverse For Terms And Conditions of Service

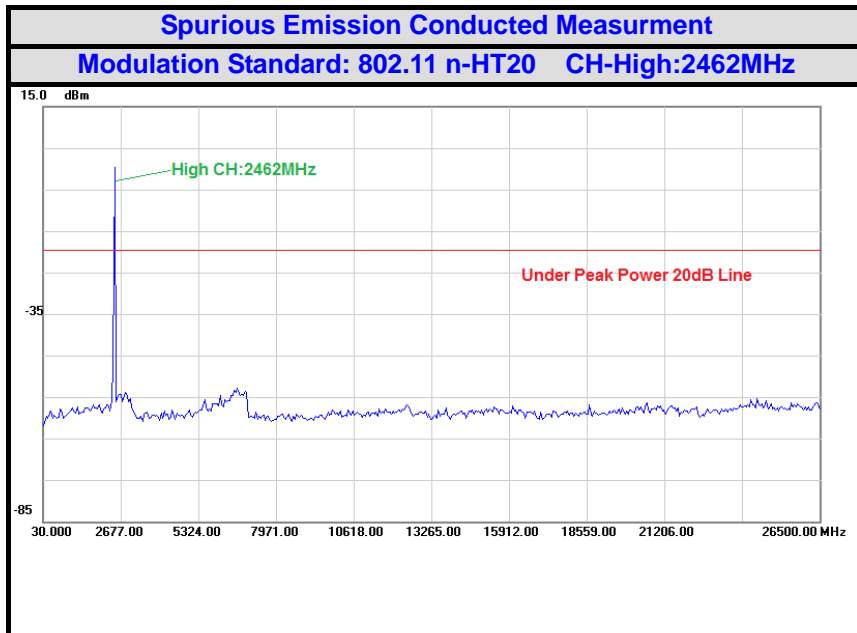
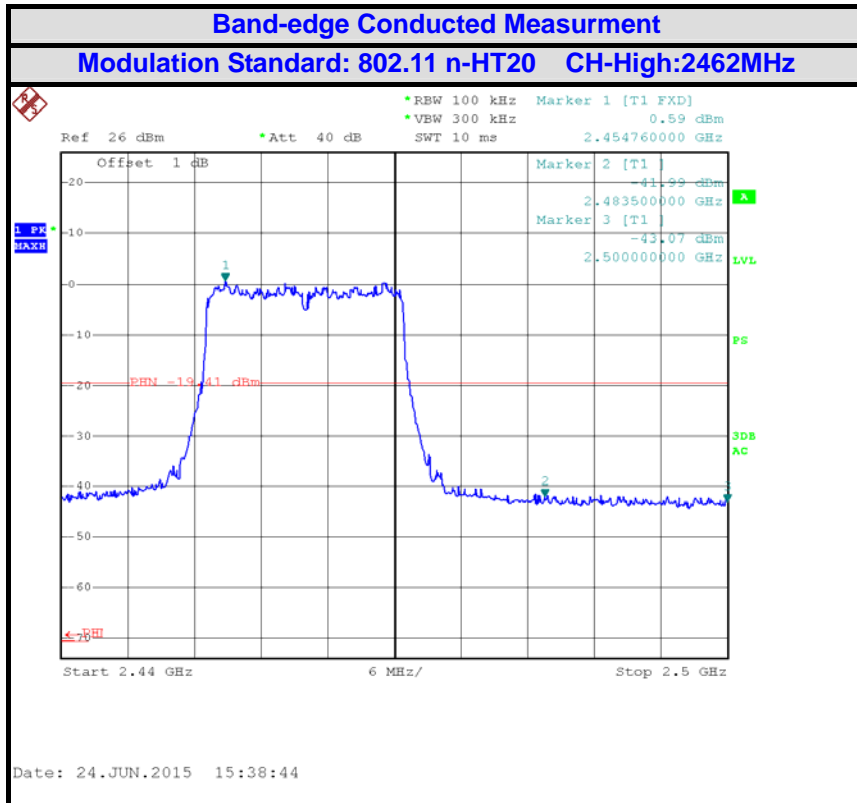

Copyright of this report is owned by Centre of Testing Service and may not be reproduced other than in full except with the written approval of the issuing Company.

CENTRE OF TESTING SERVICE CO., LTD.

A101, No.65, Zhuji Highway, Tianhe District, Guangzhou, China

Tel: +86-20-85543113 (32 lines)

Fax: +86-20-38780406

Complaint line: +86-20-85533471

E-mail: cts@cts-lab.com.cn

See Reverse For Terms And Conditions of Service

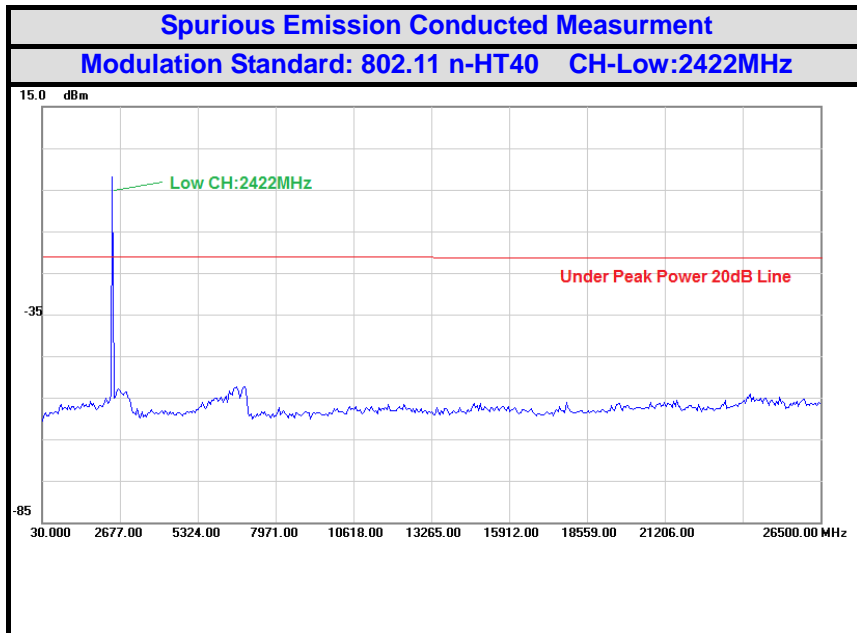
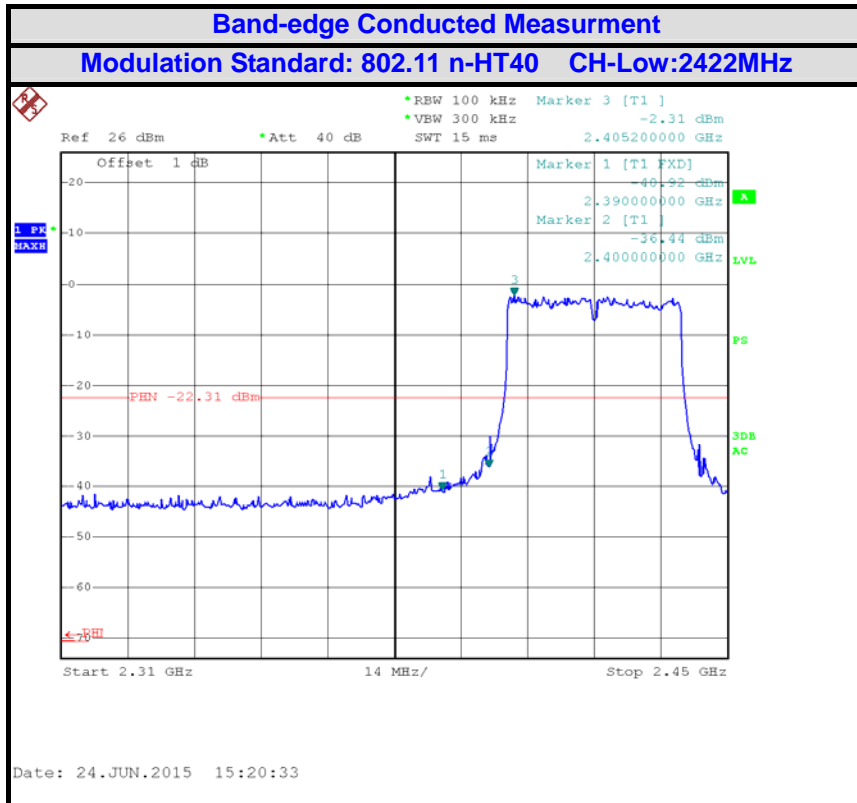

Copyright of this report is owned by Centre of Testing Service and may not be reproduced other than in full except with the written approval of the issuing Company.

CENTRE OF TESTING SERVICE CO., LTD.

A101, No.65, Zhuji Highway, Tianhe District, Guangzhou, China

Tel: +86-20-85543113 (32 lines)

Fax: +86-20-38780406

Complaint line: +86-20-85533471

E-mail: cts@cts-lab.com.cn

See Reverse For Terms And Conditions of Service

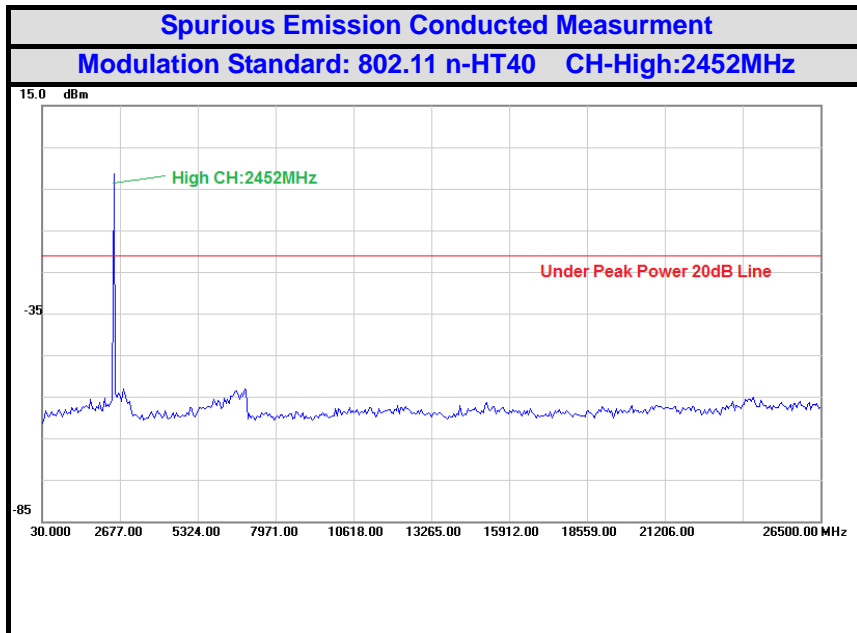
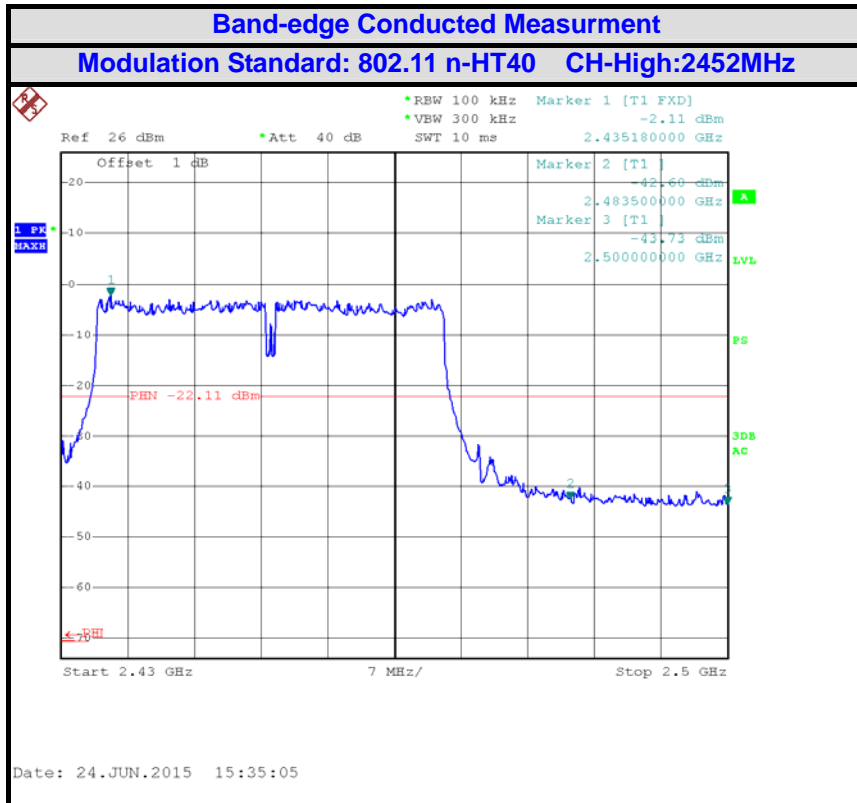

Copyright of this report is owned by Centre of Testing Service and may not be reproduced other than in full except with the written approval of the issuing Company.

CENTRE OF TESTING SERVICE CO., LTD.

A101, No.65, Zhuji Highway, Tianhe District, Guangzhou, China

Tel: +86-20-85543113 (32 lines)

Fax: +86-20-38780406

Complaint line: +86-20-85533471

E-mail: cts@cts-lab.com.cn

See Reverse For Terms And Conditions of Service



Chain:b
Test Polt:

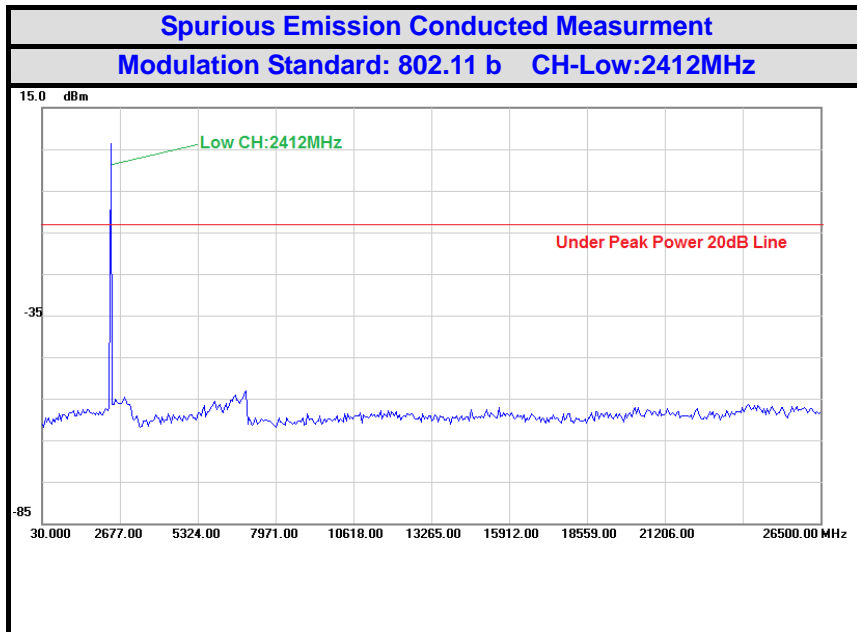
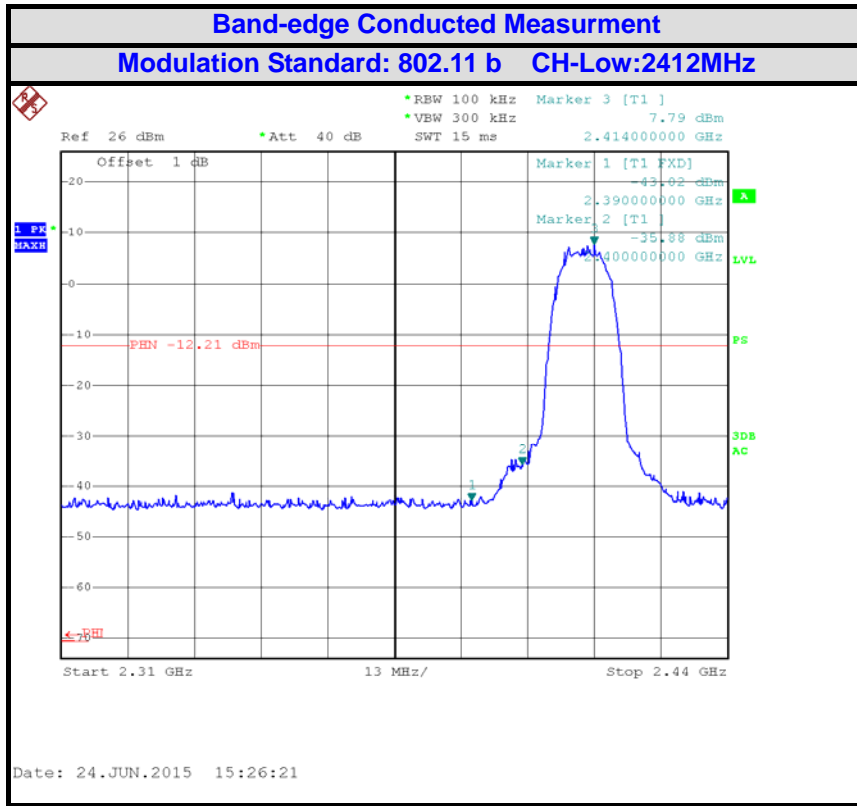

Copyright of this report is owned by Centre of Testing Service and may not be reproduced other than in full except with the written approval of the issuing Company.

CENTRE OF TESTING SERVICE CO., LTD.

A101, No.65, Zhuji Highway, Tianhe District, Guangzhou, China

Tel: +86-20-85543113 (32 lines)

Fax: +86-20-38780406

Complaint line: +86-20-85533471

E-mail: cts@cts-lab.com.cn

See Reverse For Terms And Conditions of Service

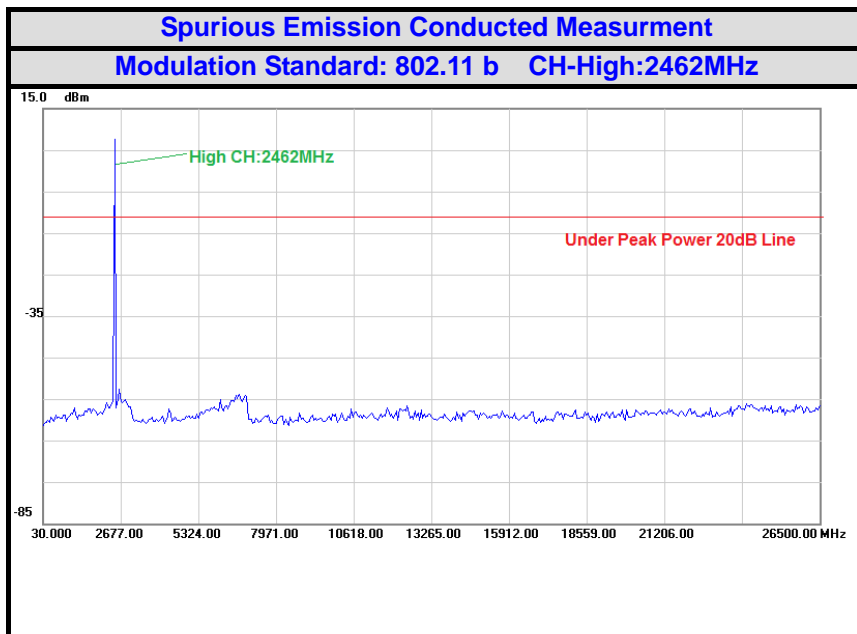
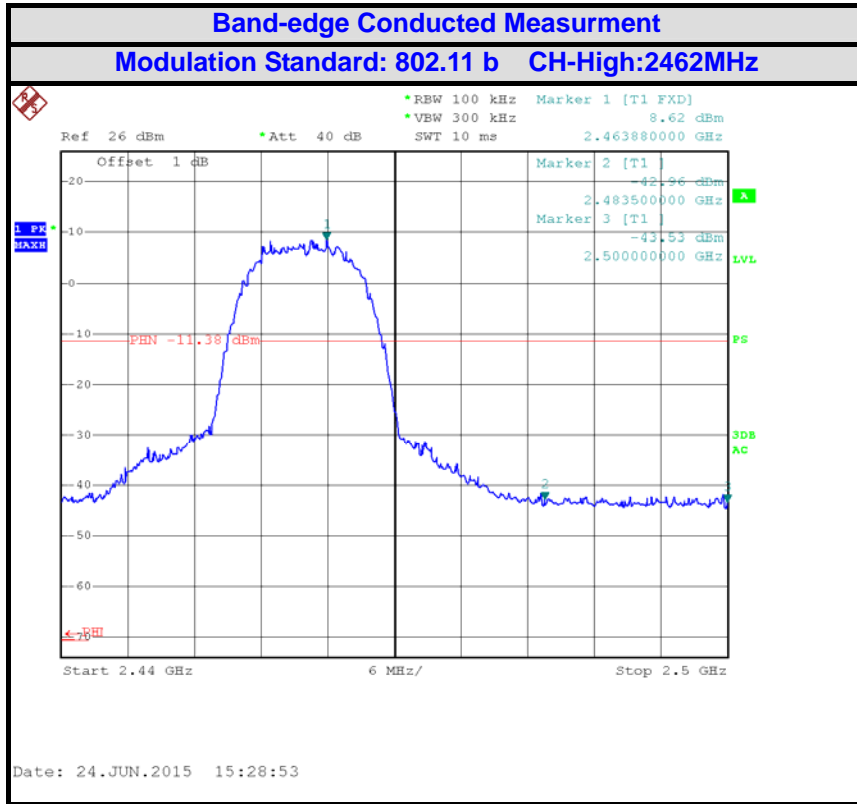

Copyright of this report is owned by Centre of Testing Service and may not be reproduced other than in full except with the written approval of the issuing Company.

CENTRE OF TESTING SERVICE CO., LTD.

A101, No.65, Zhuji Highway, Tianhe District, Guangzhou, China

Tel: +86-20-85543113 (32 lines)

Fax: +86-20-38780406

Complaint line: +86-20-85533471

E-mail: cts@cts-lab.com.cn

See Reverse For Terms And Conditions of Service

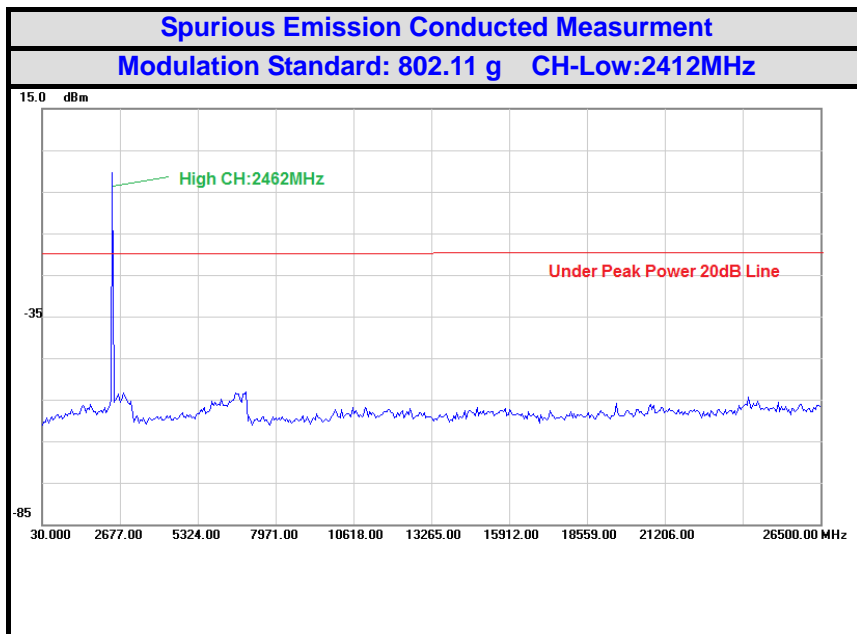
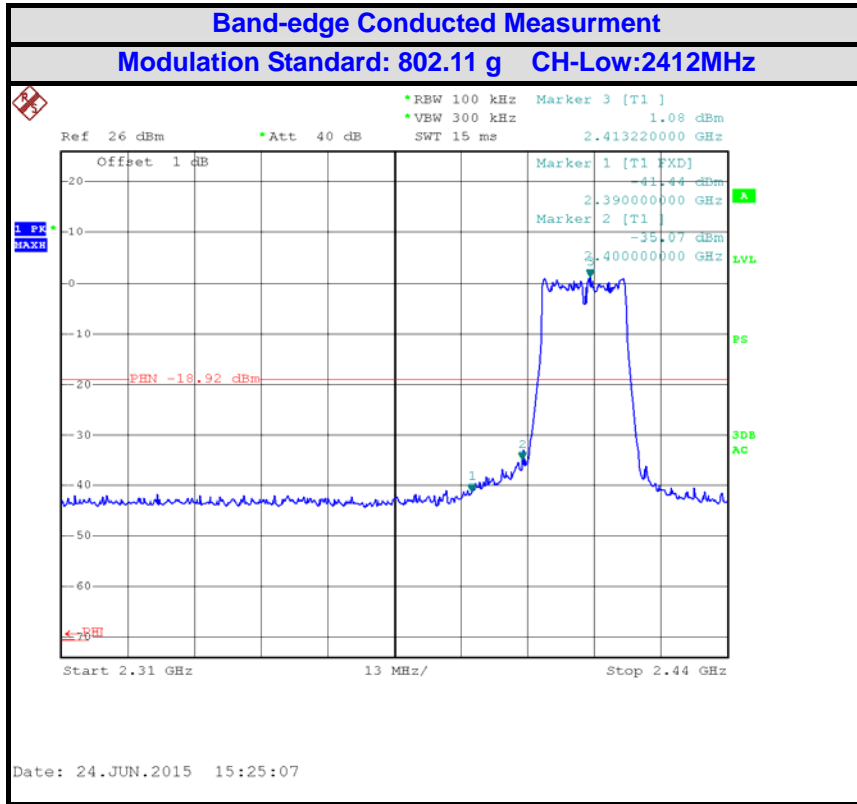

Copyright of this report is owned by Centre of Testing Service and may not be reproduced other than in full except with the written approval of the issuing Company.

CENTRE OF TESTING SERVICE CO., LTD.

A101, No.65, Zhuji Highway, Tianhe District, Guangzhou, China

Tel: +86-20-85543113 (32 lines)

Fax: +86-20-38780406

Complaint line: +86-20-85533471

E-mail: cts@cts-lab.com.cn

See Reverse For Terms And Conditions of Service

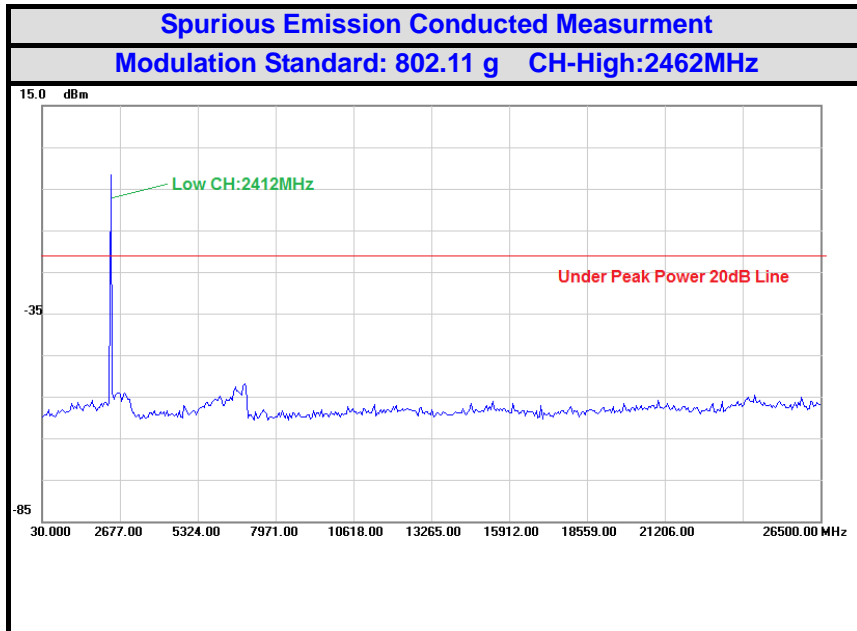
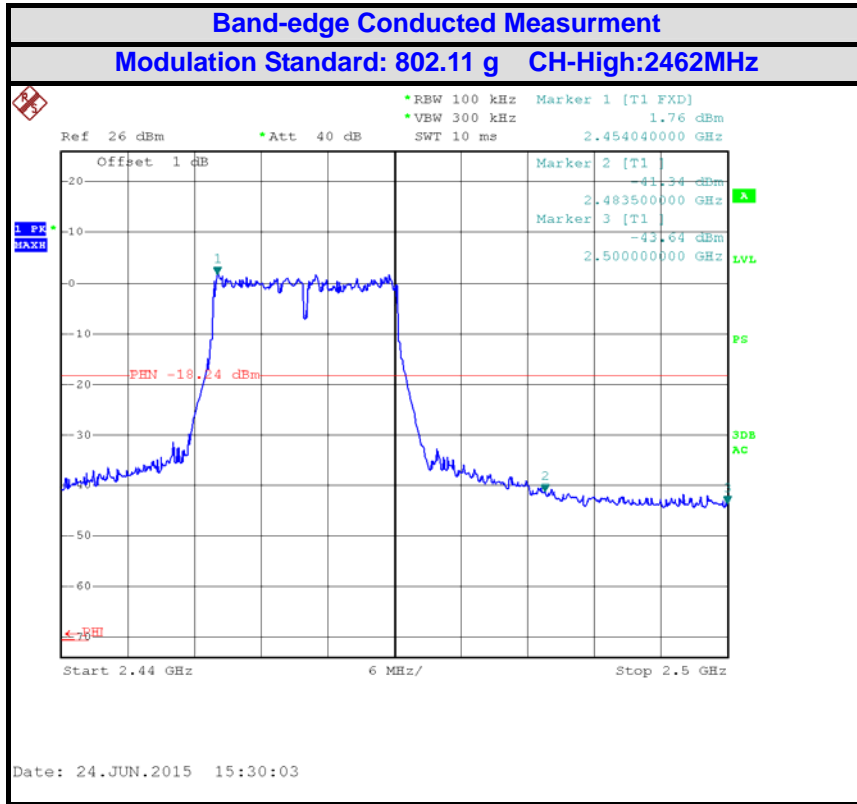

Copyright of this report is owned by Centre of Testing Service and may not be reproduced other than in full except with the written approval of the issuing Company.

CENTRE OF TESTING SERVICE CO., LTD.

A101, No.65, Zhuji Highway, Tianhe District, Guangzhou, China

Tel: +86-20-85543113 (32 lines)

Fax: +86-20-38780406

Complaint line: +86-20-85533471

E-mail: cts@cts-lab.com.cn

See Reverse For Terms And Conditions of Service

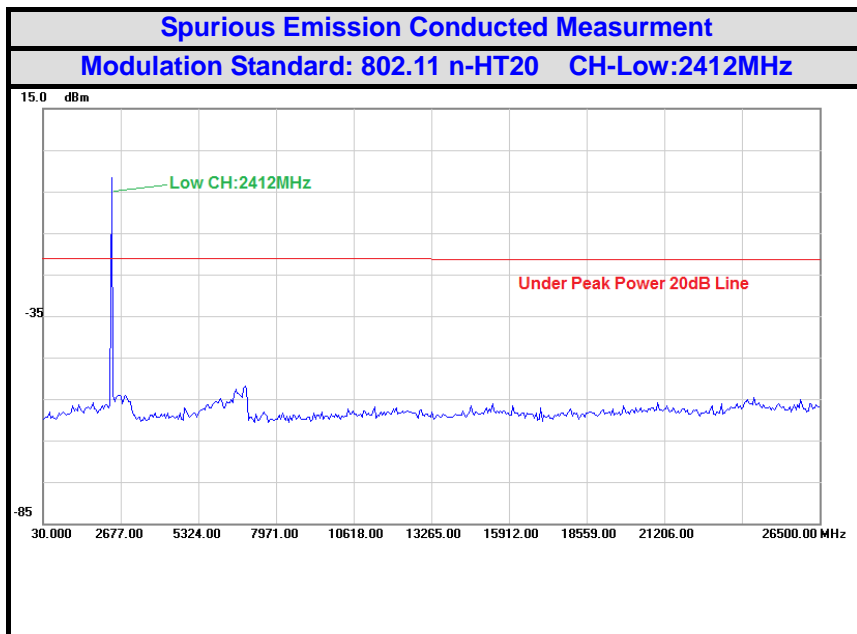
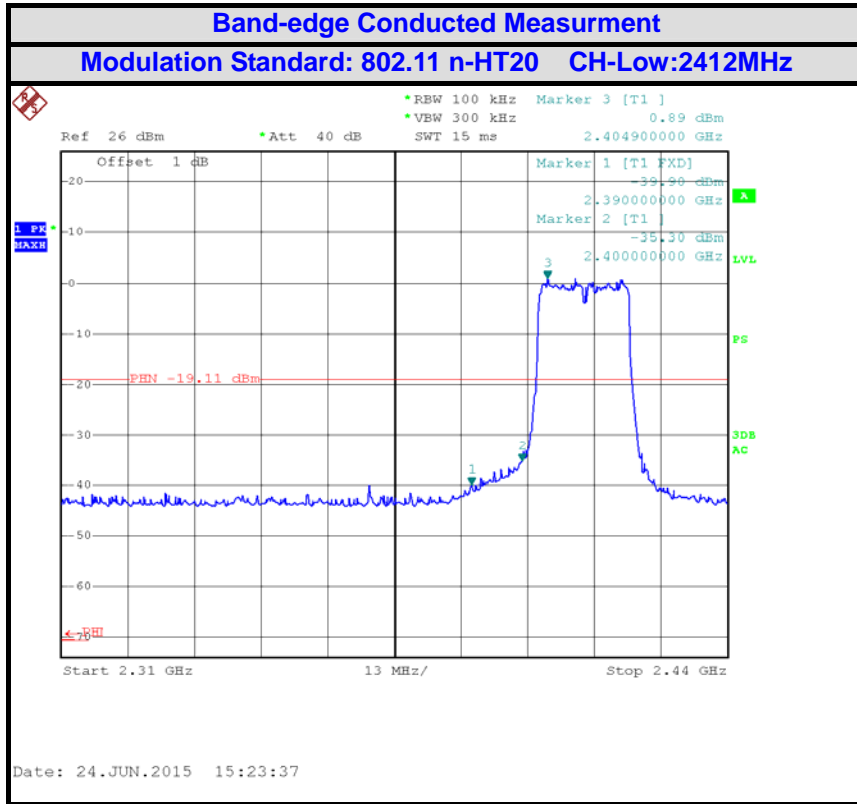

Copyright of this report is owned by Centre of Testing Service and may not be reproduced other than in full except with the written approval of the issuing Company.

CENTRE OF TESTING SERVICE CO., LTD.

A101, No.65, Zhuji Highway, Tianhe District, Guangzhou, China

Tel: +86-20-85543113 (32 lines)

Fax: +86-20-38780406

Complaint line: +86-20-85533471

E-mail: cts@cts-lab.com.cn

See Reverse For Terms And Conditions of Service

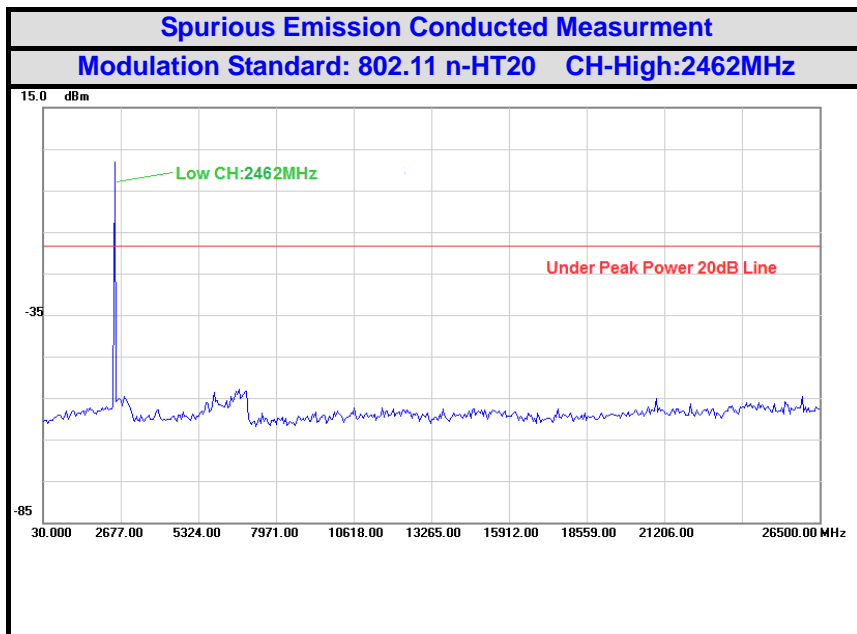
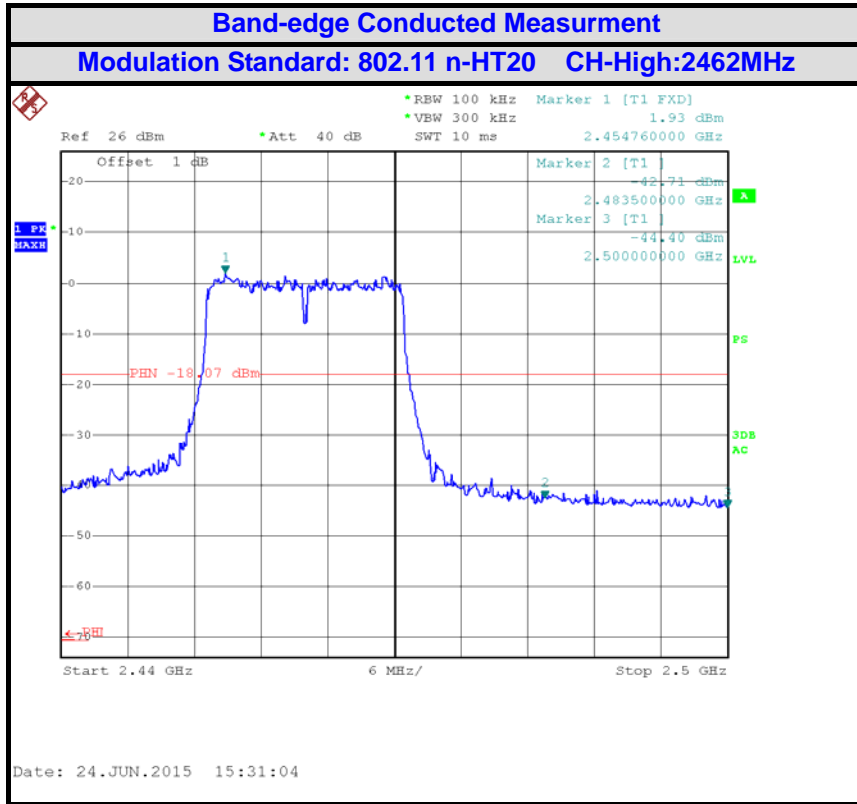

Copyright of this report is owned by Centre of Testing Service and may not be reproduced other than in full except with the written approval of the issuing Company.

CENTRE OF TESTING SERVICE CO., LTD.

A101, No.65, Zhuji Highway, Tianhe District, Guangzhou, China
Tel: +86-20-85543113 (32 lines) Fax: +86-20-38780406
Complaint line: +86-20-85533471 E-mail: cts@cts-lab.com.cn

See Reverse For Terms And Conditions of Service

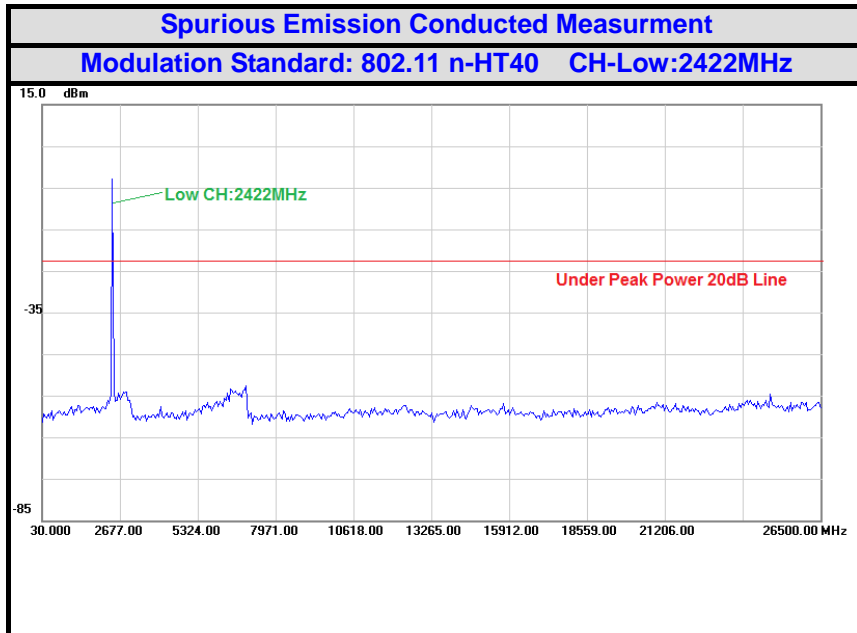
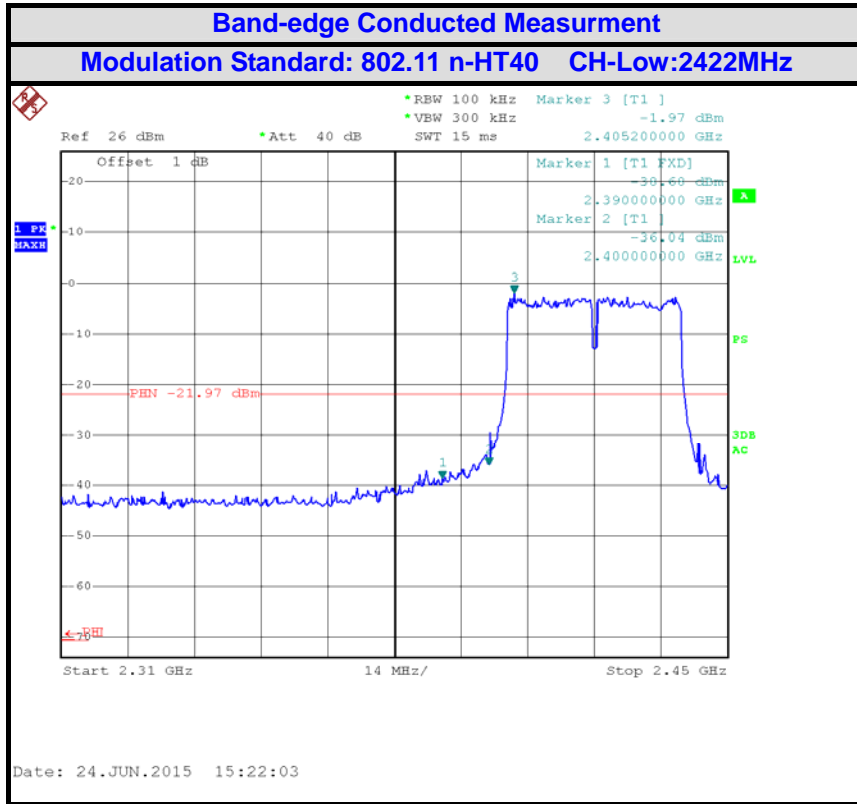

Copyright of this report is owned by Centre of Testing Service and may not be reproduced other than in full except with the written approval of the issuing Company.

CENTRE OF TESTING SERVICE CO., LTD.

A101, No.65, Zhuji Highway, Tianhe District, Guangzhou, China

Tel: +86-20-85543113 (32 lines)

Fax: +86-20-38780406

Complaint line: +86-20-85533471

E-mail: cts@cts-lab.com.cn

See Reverse For Terms And Conditions of Service

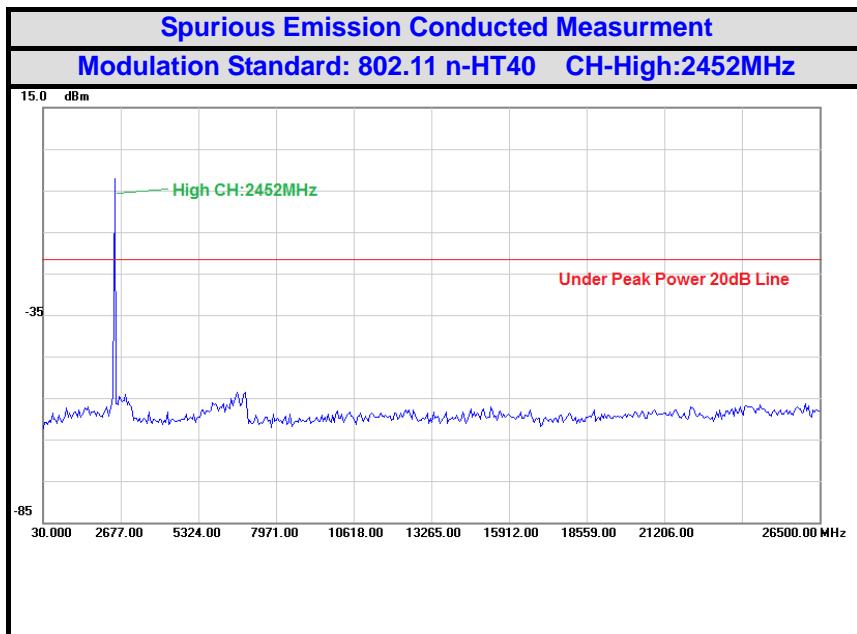
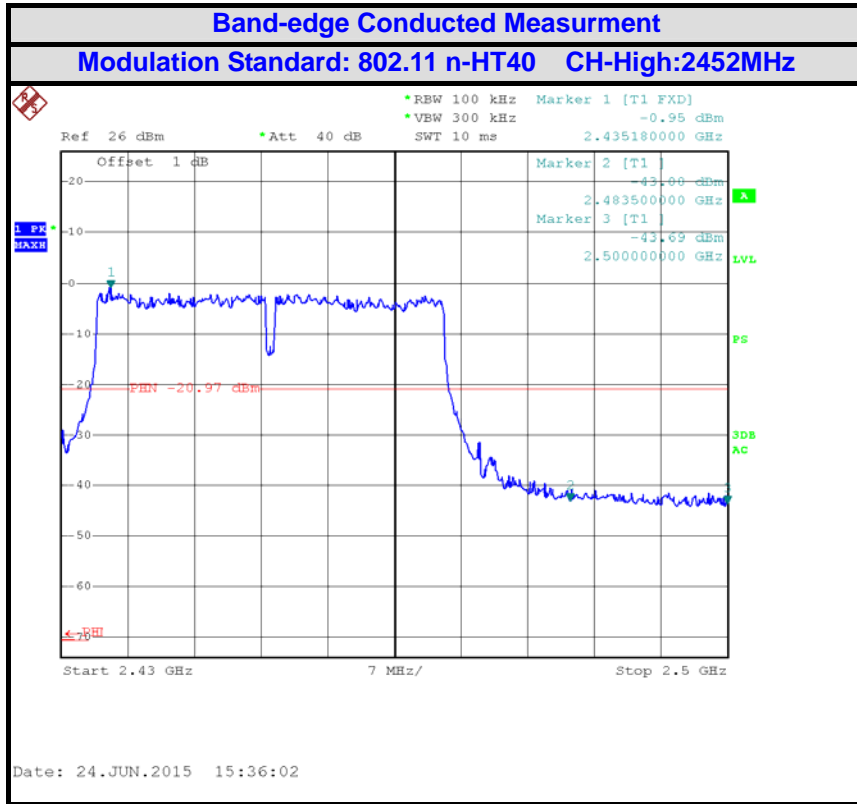

Copyright of this report is owned by Centre of Testing Service and may not be reproduced other than in full except with the written approval of the issuing Company.

CENTRE OF TESTING SERVICE CO., LTD.

A101, No.65, Zhuji Highway, Tianhe District, Guangzhou, China

Tel: +86-20-85543113 (32 lines)

Fax: +86-20-38780406

Complaint line: +86-20-85533471

E-mail: cts@cts-lab.com.cn

See Reverse For Terms And Conditions of Service



Radiated Measurement:

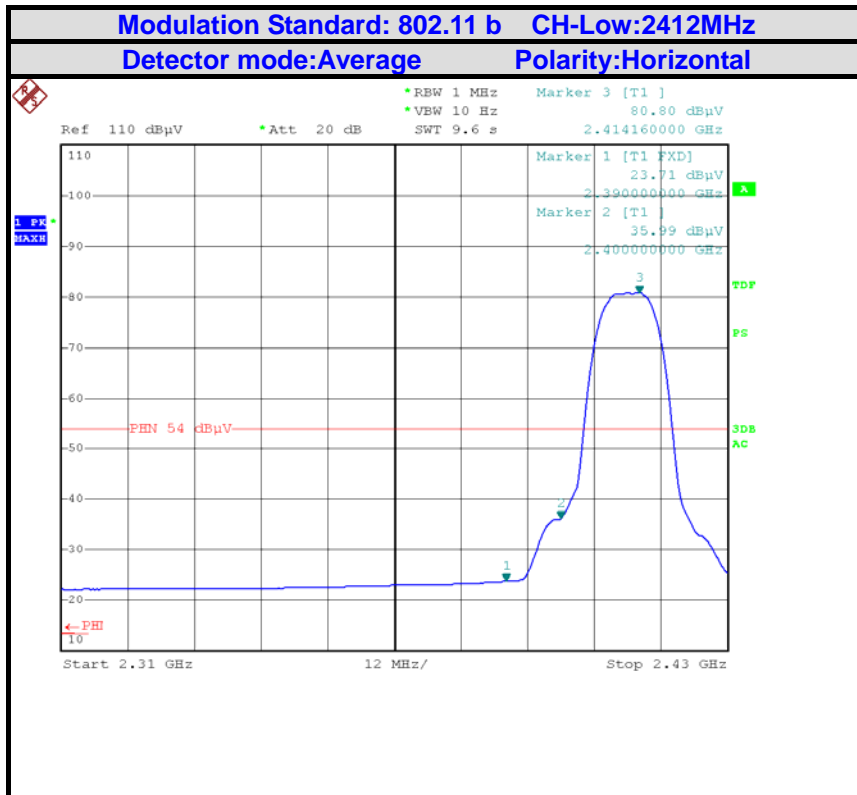
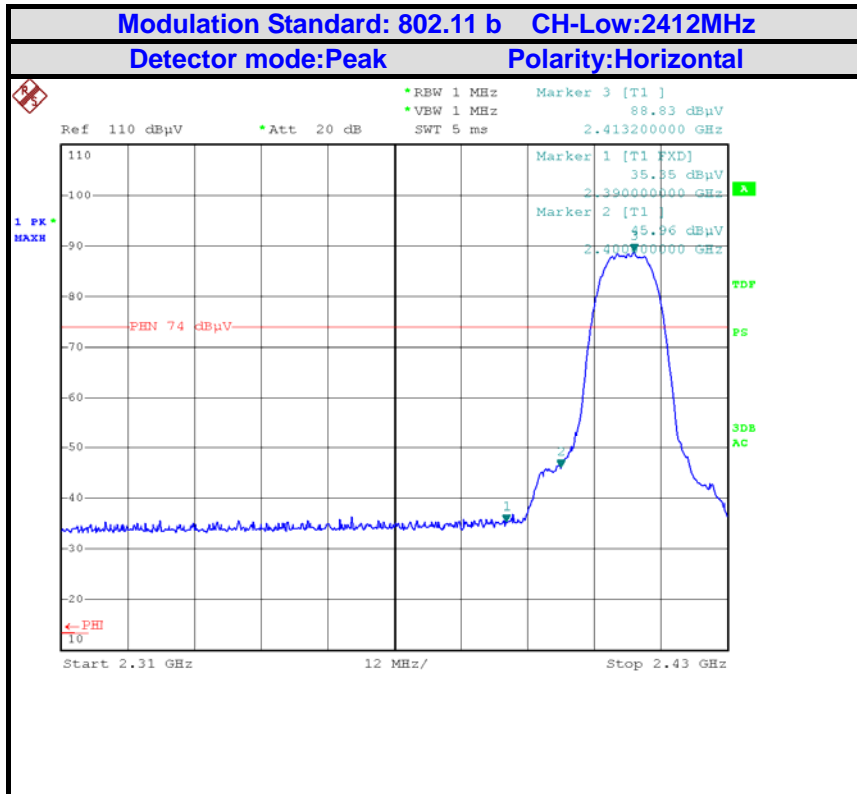

Copyright of this report is owned by Centre of Testing Service and may not be reproduced other than in full except with the written approval of the issuing Company.

CENTRE OF TESTING SERVICE CO., LTD.

A101, No.65, Zhuji Highway, Tianhe District, Guangzhou, China

Tel: +86-20-85543113 (32 lines)

Fax: +86-20-38780406

Complaint line: +86-20-85533471

E-mail: cts@cts-lab.com.cn

See Reverse For Terms And Conditions of Service

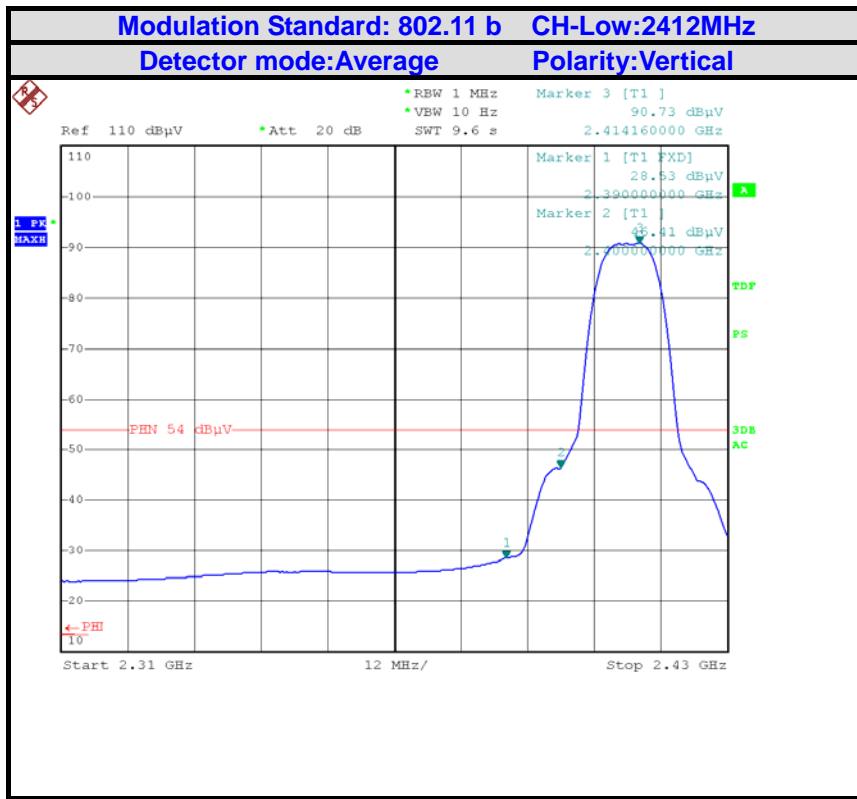
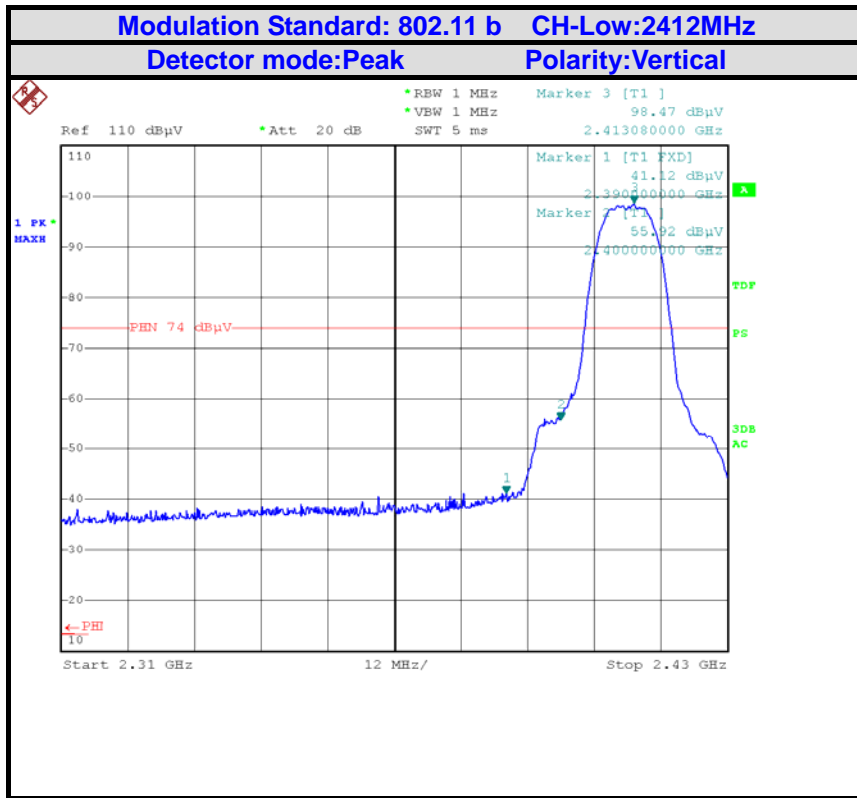

Copyright of this report is owned by Centre of Testing Service and may not be reproduced other than in full except with the written approval of the issuing Company.

CENTRE OF TESTING SERVICE CO., LTD.

A101, No.65, Zhuji Highway, Tianhe District, Guangzhou, China

Tel: +86-20-85543113 (32 lines)

Fax: +86-20-38780406

Complaint line: +86-20-85533471

E-mail: cts@cts-lab.com.cn

See Reverse For Terms And Conditions of Service

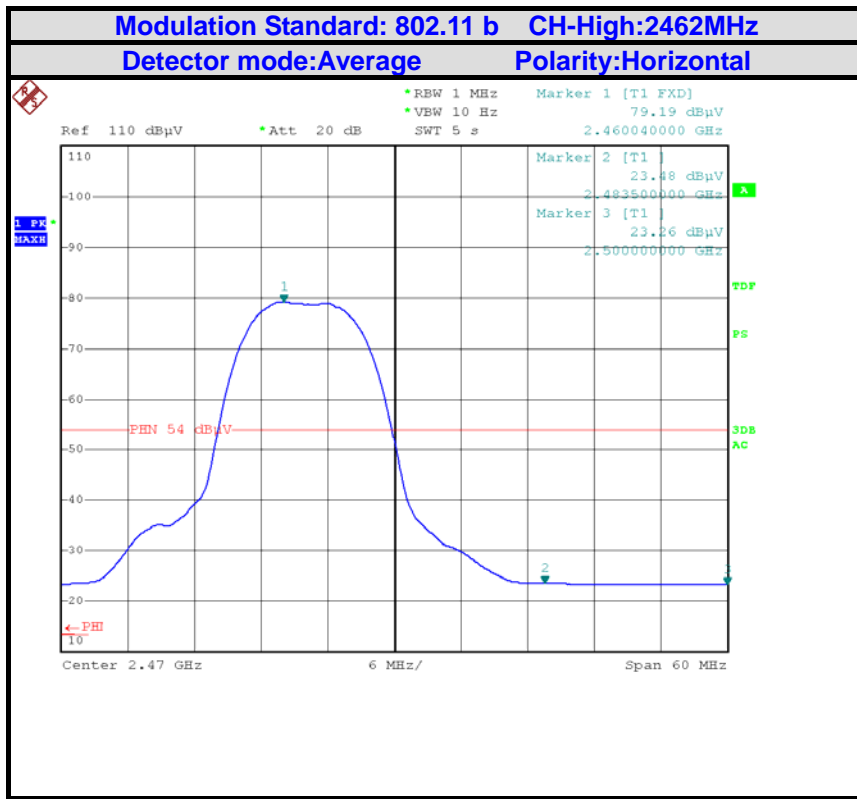
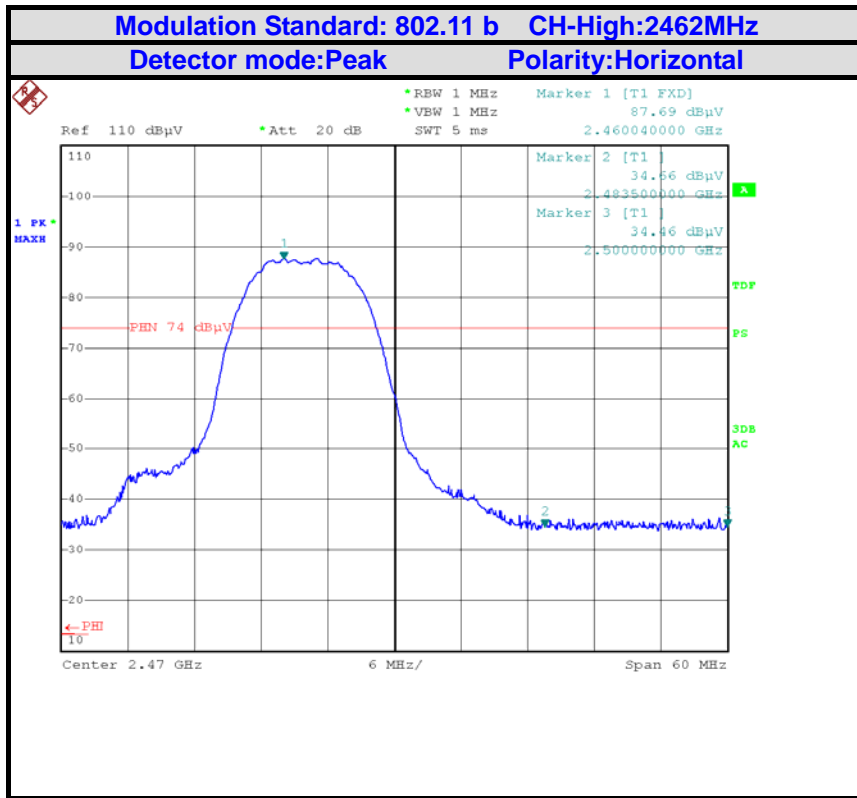

Copyright of this report is owned by Centre of Testing Service and may not be reproduced other than in full except with the written approval of the issuing Company.

CENTRE OF TESTING SERVICE CO., LTD.

A101, No.65, Zhuji Highway, Tianhe District, Guangzhou, China

Tel: +86-20-85543113 (32 lines)

Fax: +86-20-38780406

Complaint line: +86-20-85533471

E-mail: cts@cts-lab.com.cn

See Reverse For Terms And Conditions of Service

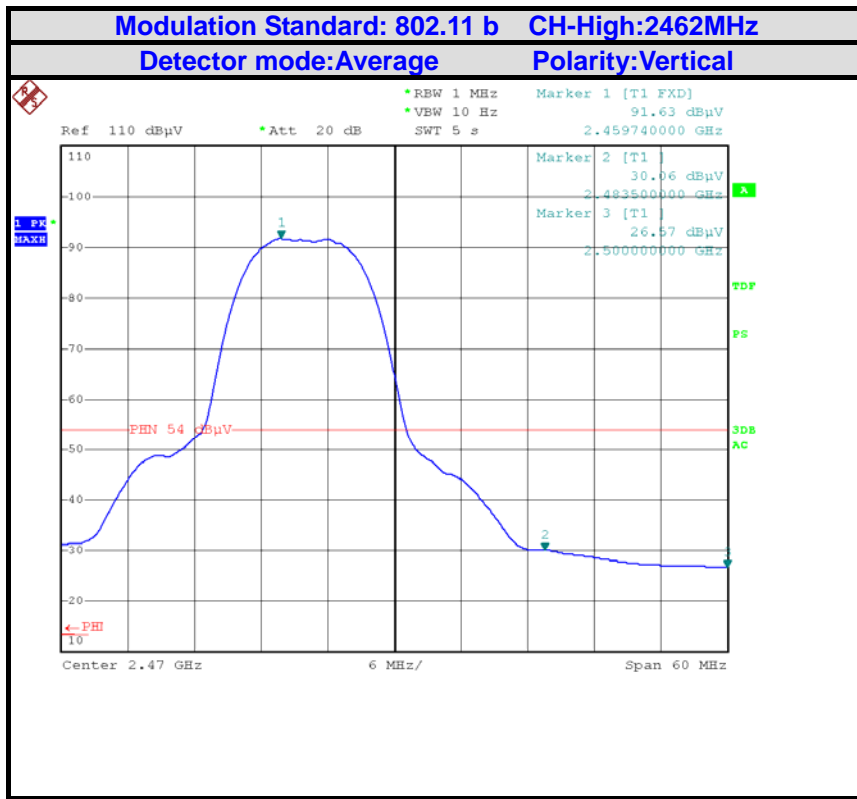
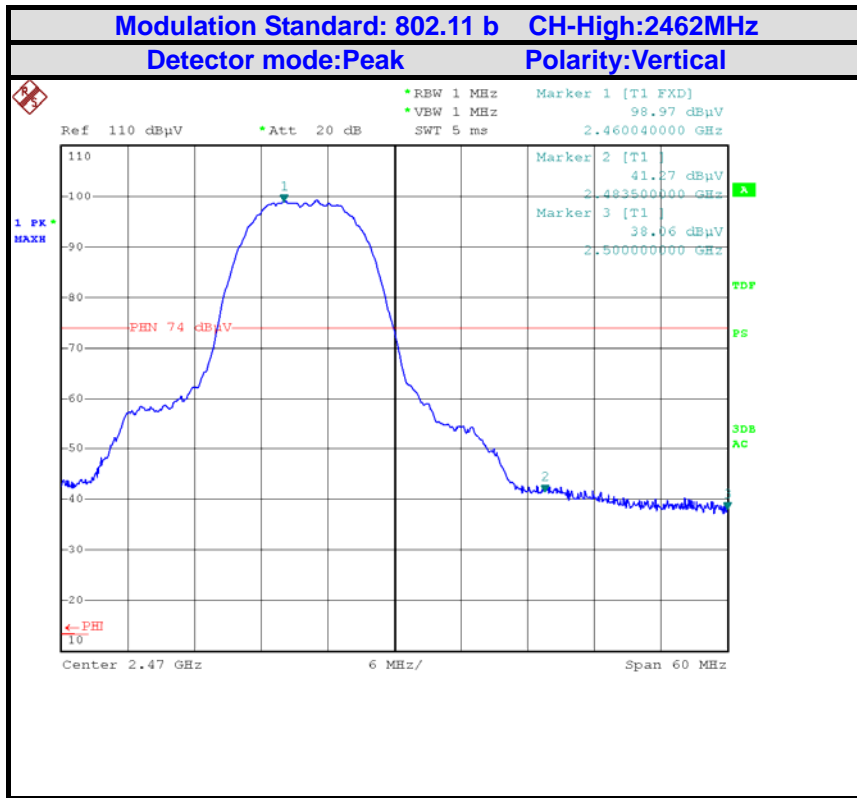

Copyright of this report is owned by Centre of Testing Service and may not be reproduced other than in full except with the written approval of the issuing Company.

CENTRE OF TESTING SERVICE CO., LTD.

A101, No.65, Zhuji Highway, Tianhe District, Guangzhou, China
 Tel: +86-20-85543113 (32 lines) Fax: +86-20-38780406
 Complaint line: +86-20-85533471 E-mail: cts@cts-lab.com.cn

See Reverse For Terms And Conditions of Service

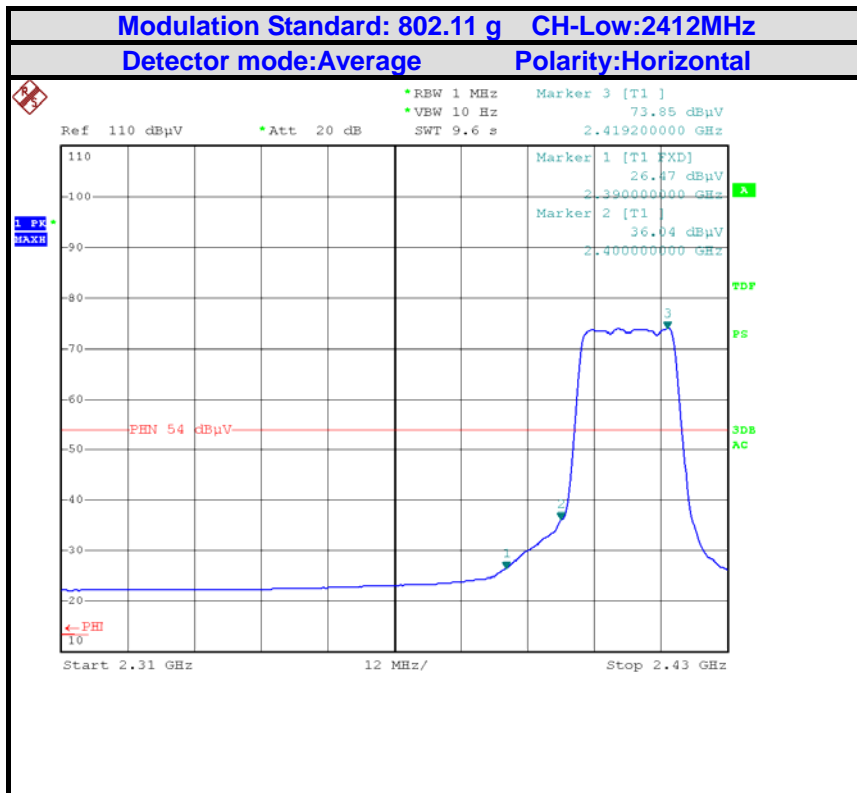
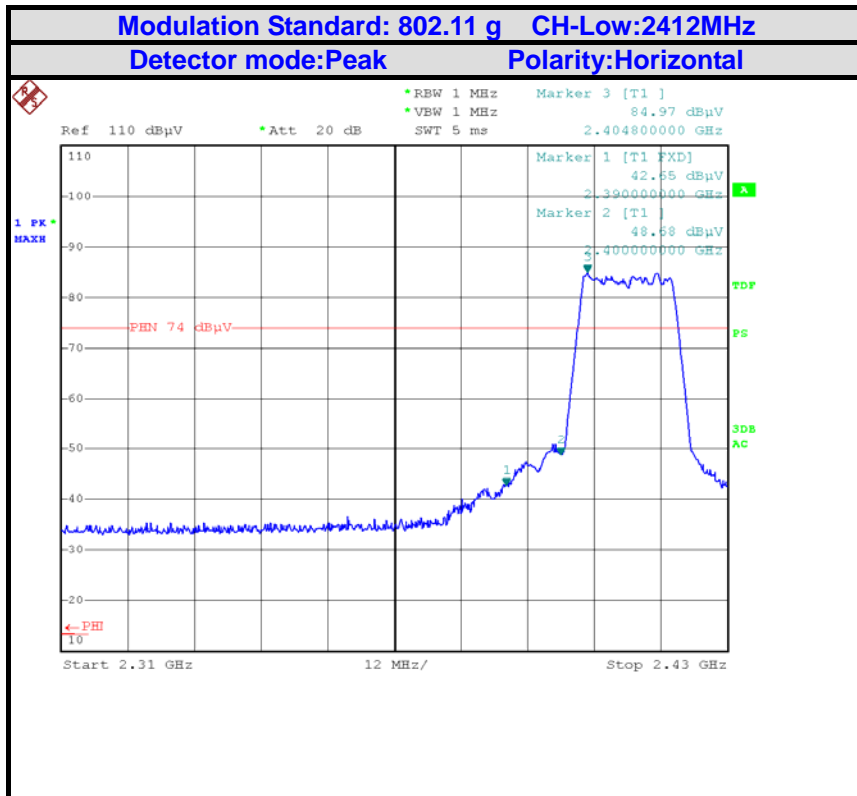

Copyright of this report is owned by Centre of Testing Service and may not be reproduced other than in full except with the written approval of the issuing Company.

CENTRE OF TESTING SERVICE CO., LTD.

A101, No.65, Zhuji Highway, Tianhe District, Guangzhou, China

Tel: +86-20-85543113 (32 lines)

Fax: +86-20-38780406

Complaint line: +86-20-85533471

E-mail: cts@cts-lab.com.cn

See Reverse For Terms And Conditions of Service

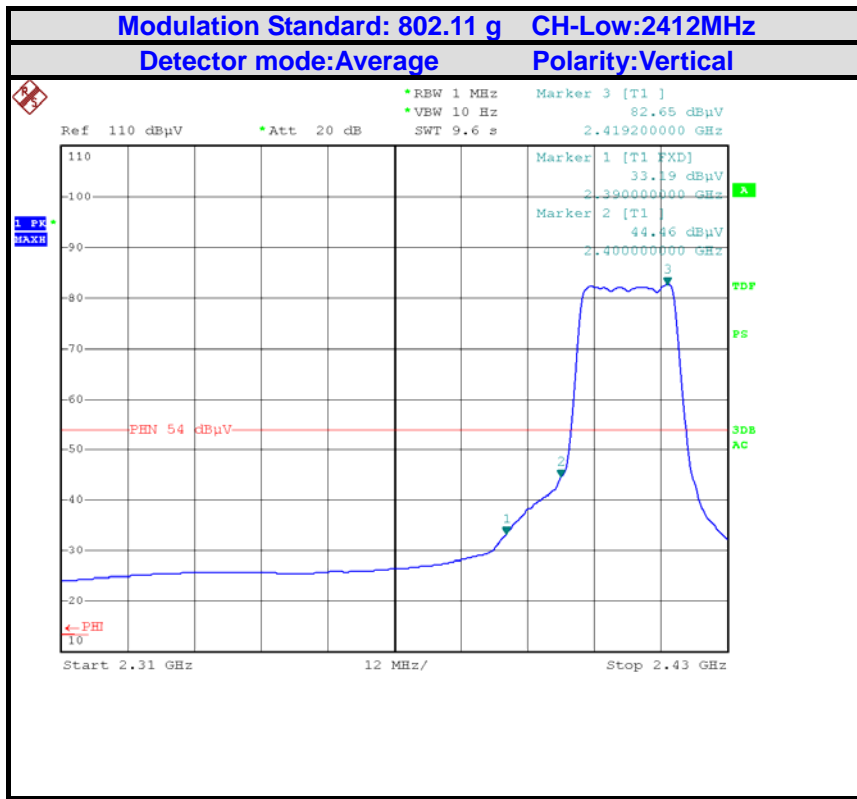
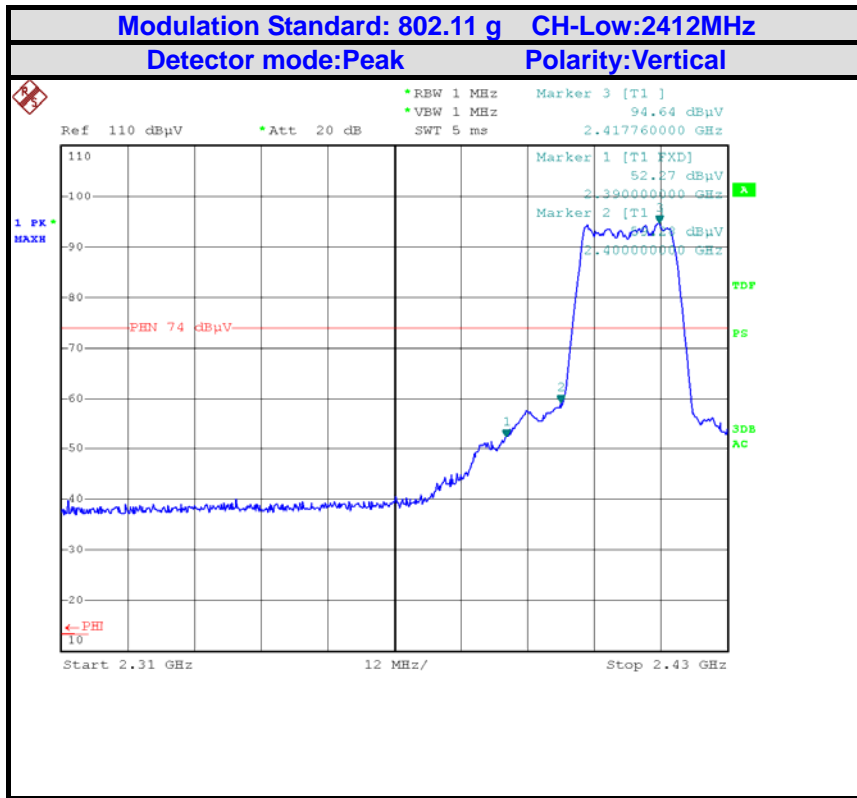

Copyright of this report is owned by Centre of Testing Service and may not be reproduced other than in full except with the written approval of the issuing Company.

CENTRE OF TESTING SERVICE CO., LTD.

A101, No.65, Zhuji Highway, Tianhe District, Guangzhou, China
 Tel: +86-20-85543113 (32 lines) Fax: +86-20-38780406
 Complaint line: +86-20-85533471 E-mail: cts@cts-lab.com.cn

See Reverse For Terms And Conditions of Service

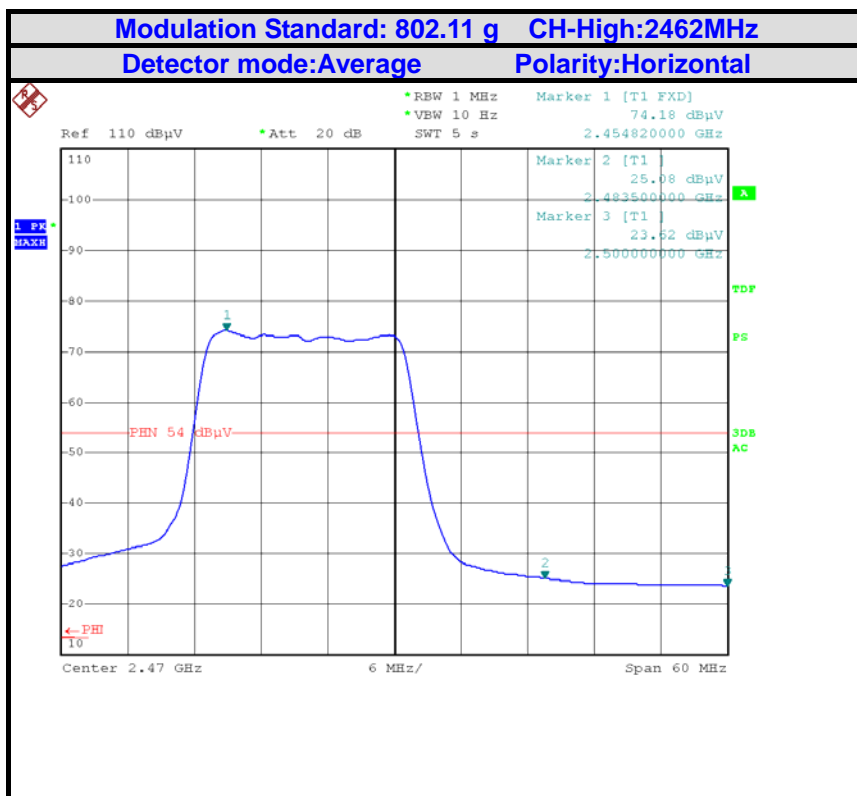
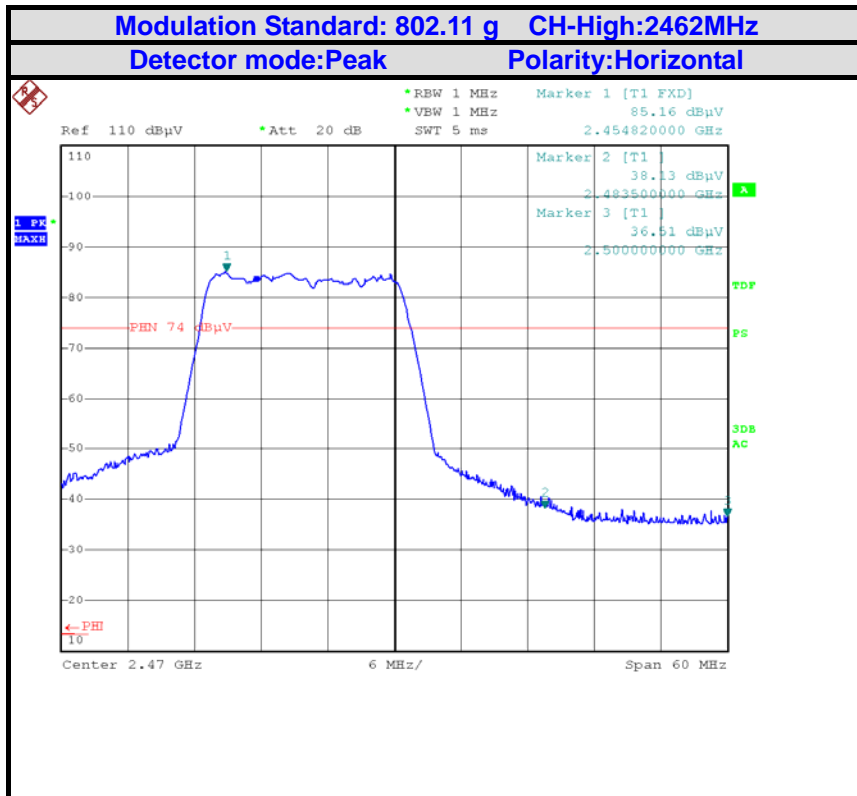

Copyright of this report is owned by Centre of Testing Service and may not be reproduced other than in full except with the written approval of the issuing Company.

CENTRE OF TESTING SERVICE CO., LTD.

A101, No.65, Zhuji Highway, Tianhe District, Guangzhou, China

Tel: +86-20-85543113 (32 lines)

Fax: +86-20-38780406

Complaint line: +86-20-85533471

E-mail: cts@cts-lab.com.cn

See Reverse For Terms And Conditions of Service

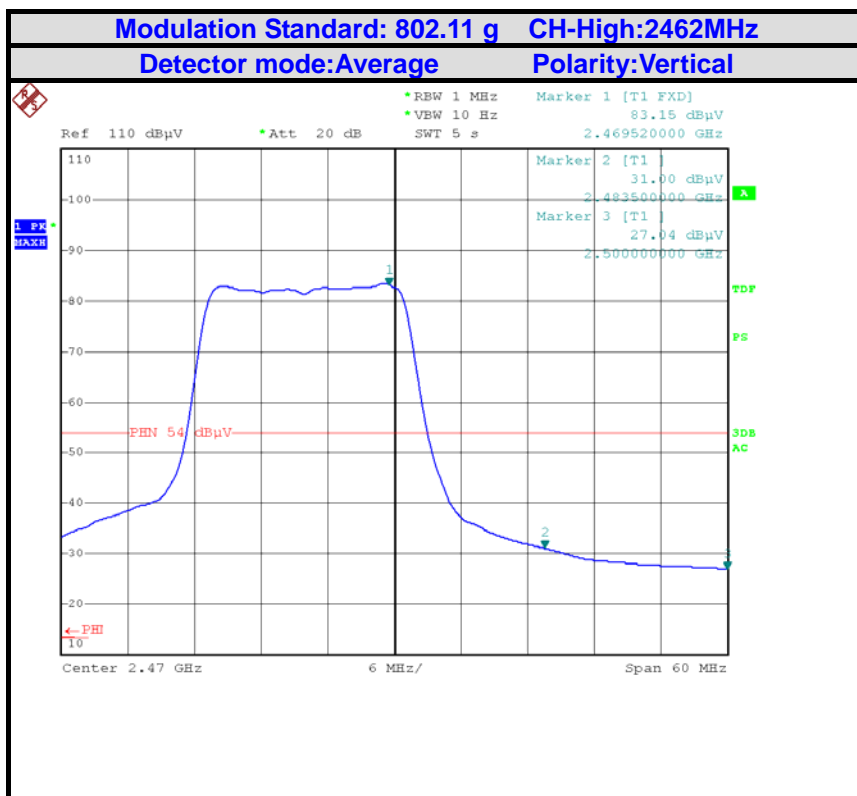
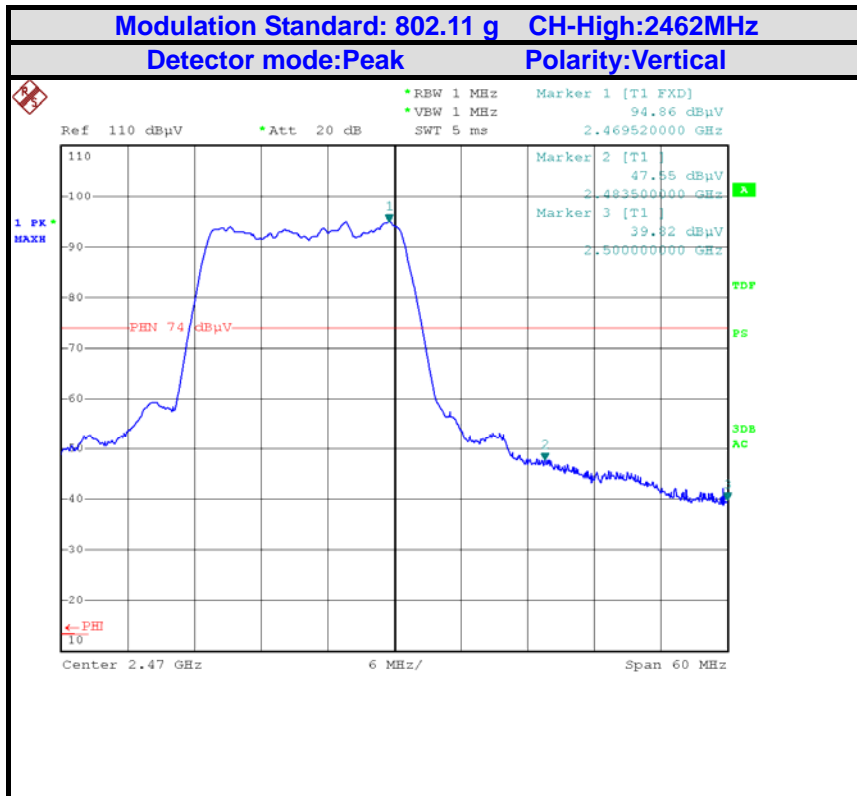

Copyright of this report is owned by Centre of Testing Service and may not be reproduced other than in full except with the written approval of the issuing Company.

CENTRE OF TESTING SERVICE CO., LTD.

A101, No.65, Zhuji Highway, Tianhe District, Guangzhou, China

Tel: +86-20-85543113 (32 lines)

Fax: +86-20-38780406

Complaint line: +86-20-85533471

E-mail: cts@cts-lab.com.cn

See Reverse For Terms And Conditions of Service

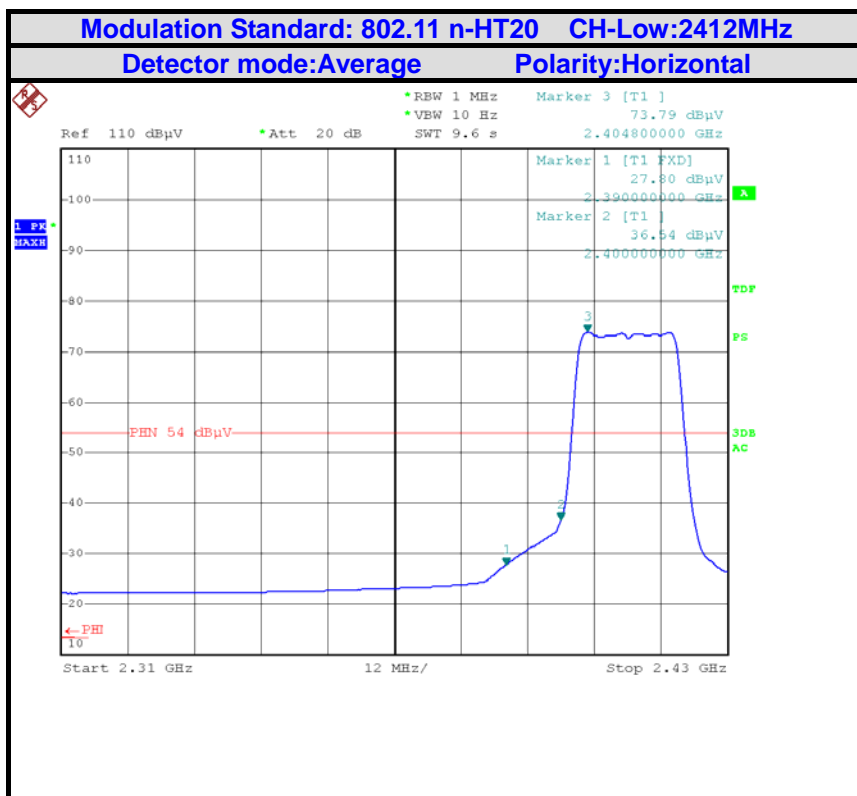
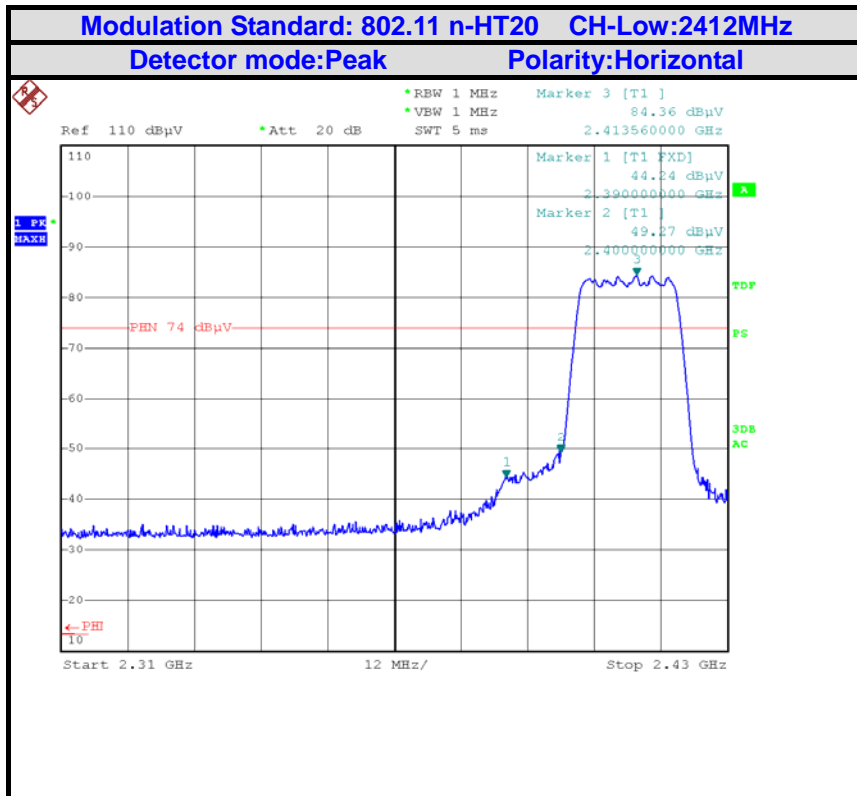

Copyright of this report is owned by Centre of Testing Service and may not be reproduced other than in full except with the written approval of the issuing Company.

CENTRE OF TESTING SERVICE CO., LTD.

A101, No.65, Zhuji Highway, Tianhe District, Guangzhou, China

Tel: +86-20-85543113 (32 lines)

Fax: +86-20-38780406

Complaint line: +86-20-85533471

E-mail: cts@cts-lab.com.cn

See Reverse For Terms And Conditions of Service

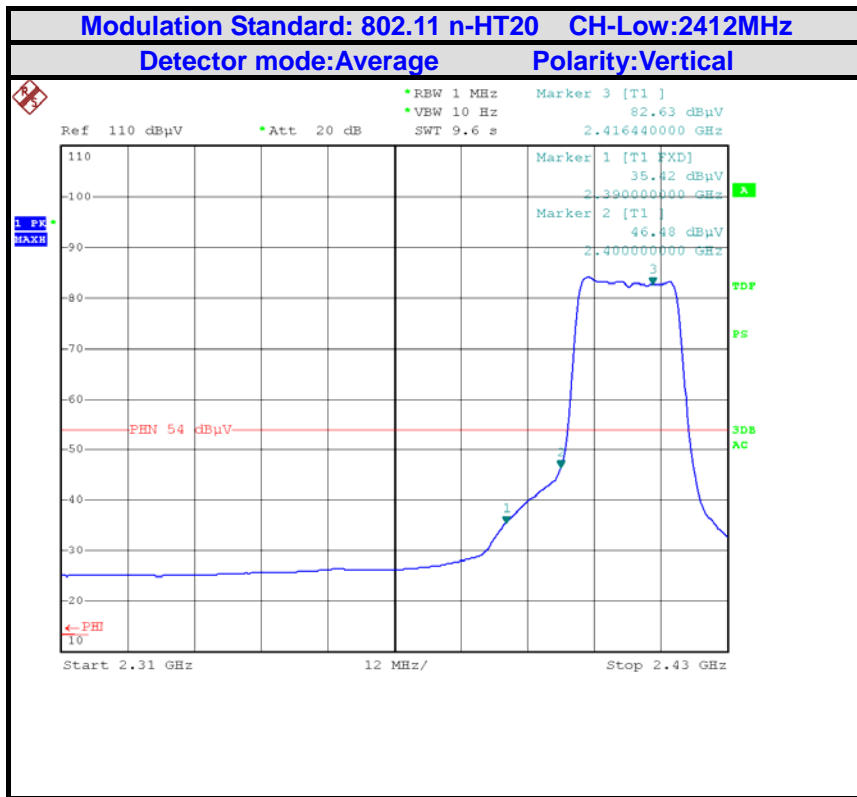
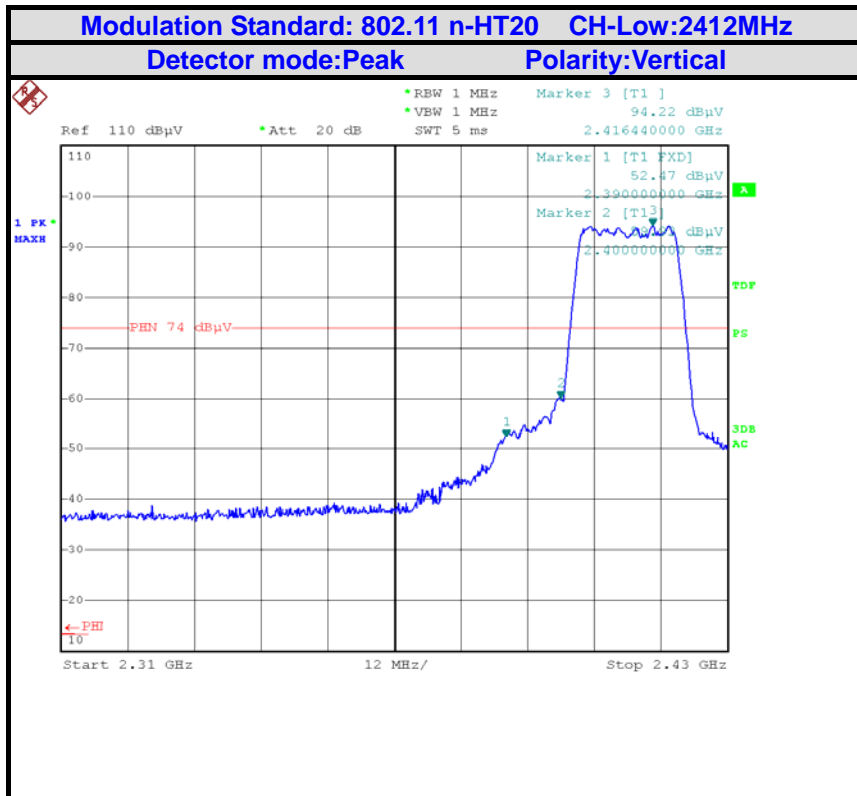

Copyright of this report is owned by Centre of Testing Service and may not be reproduced other than in full except with the written approval of the issuing Company.

CENTRE OF TESTING SERVICE CO., LTD.

A101, No.65, Zhuji Highway, Tianhe District, Guangzhou, China

Tel: +86-20-85543113 (32 lines)

Fax: +86-20-38780406

Complaint line: +86-20-85533471

E-mail: cts@cts-lab.com.cn

See Reverse For Terms And Conditions of Service

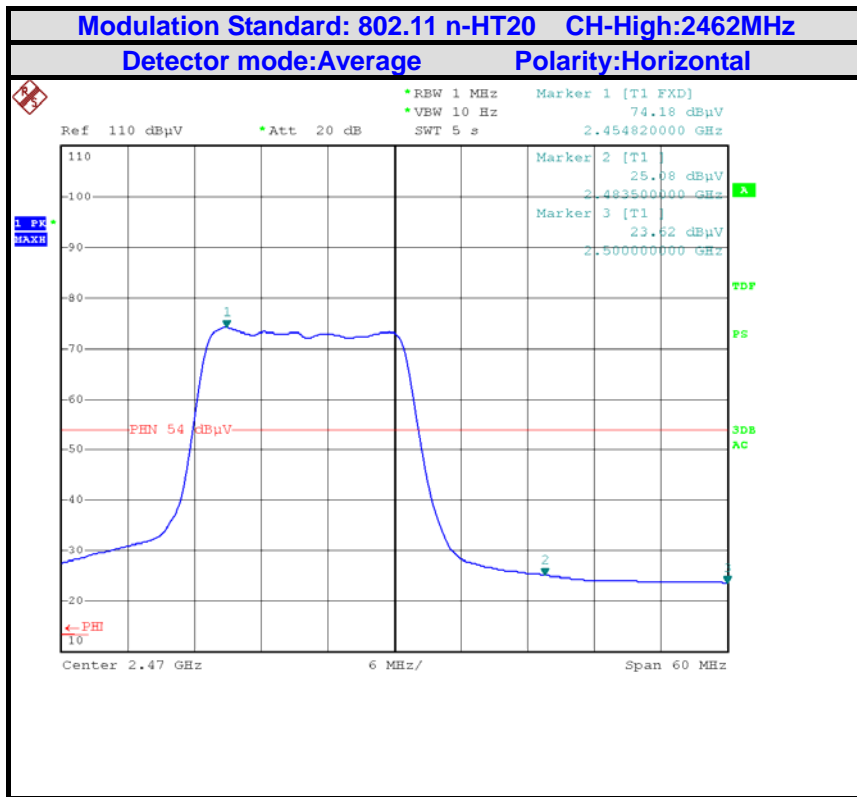
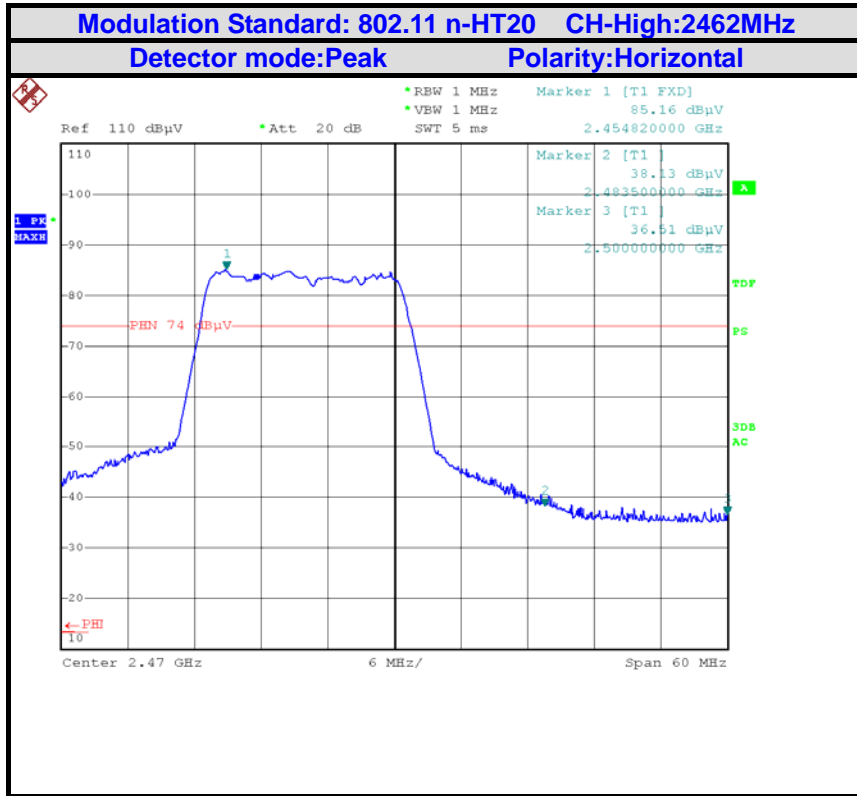

Copyright of this report is owned by Centre of Testing Service and may not be reproduced other than in full except with the written approval of the issuing Company.

CENTRE OF TESTING SERVICE CO., LTD.

A101, No.65, Zhuji Highway, Tianhe District, Guangzhou, China

Tel: +86-20-85543113 (32 lines)

Fax: +86-20-38780406

Complaint line: +86-20-85533471

E-mail: cts@cts-lab.com.cn

See Reverse For Terms And Conditions of Service

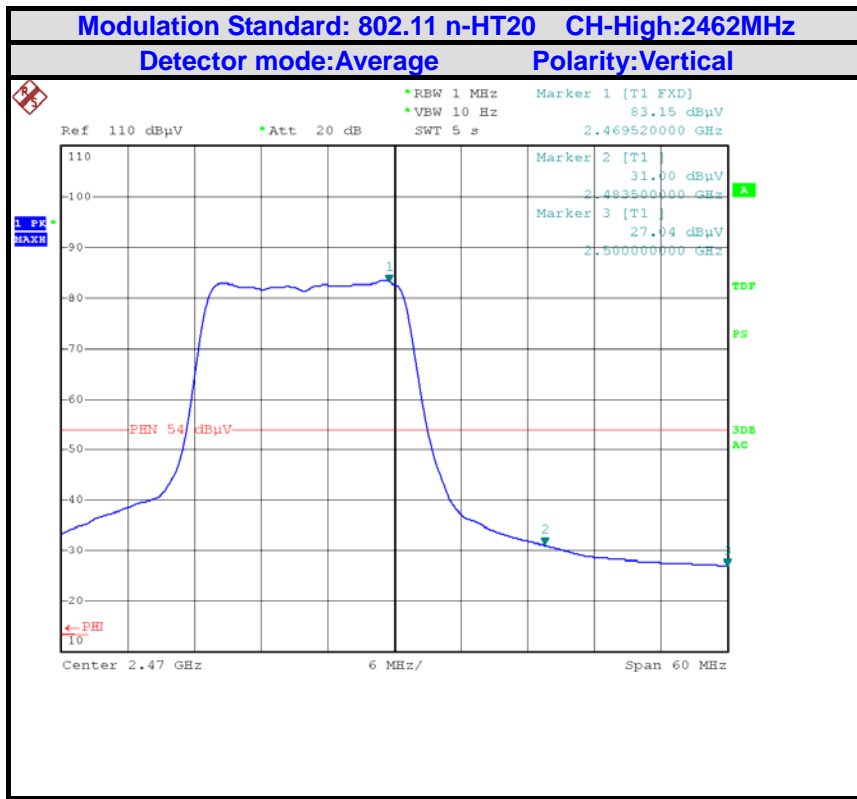
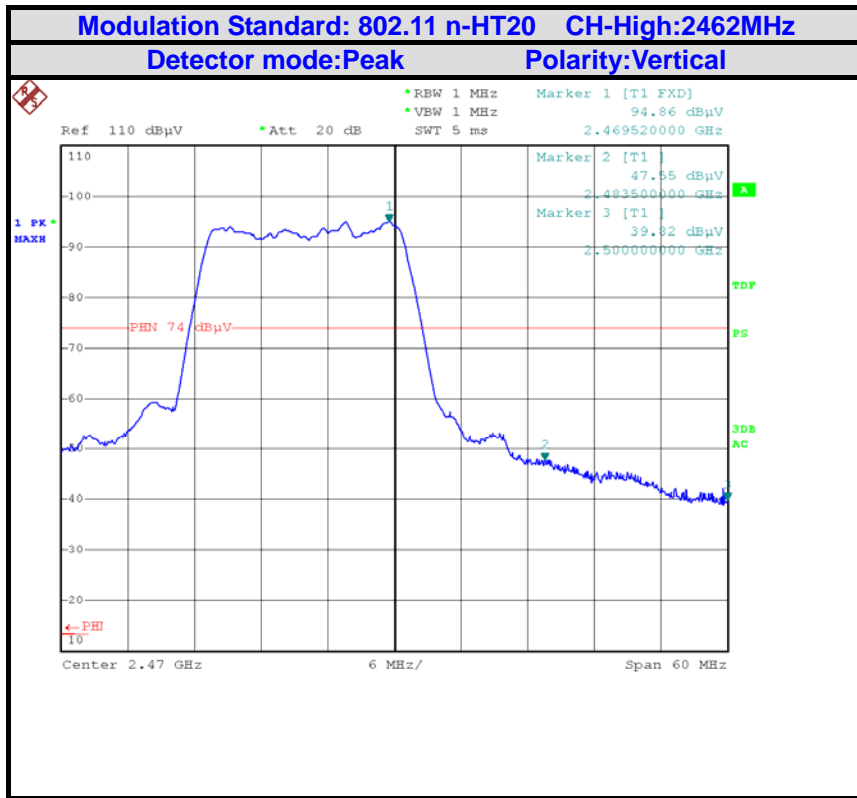

Copyright of this report is owned by Centre of Testing Service and may not be reproduced other than in full except with the written approval of the issuing Company.

CENTRE OF TESTING SERVICE CO., LTD.

A101, No.65, Zhuji Highway, Tianhe District, Guangzhou, China
Tel: +86-20-85543113 (32 lines) Fax: +86-20-38780406
Complaint line: +86-20-85533471 E-mail: cts@cts-lab.com.cn

See Reverse For Terms And Conditions of Service

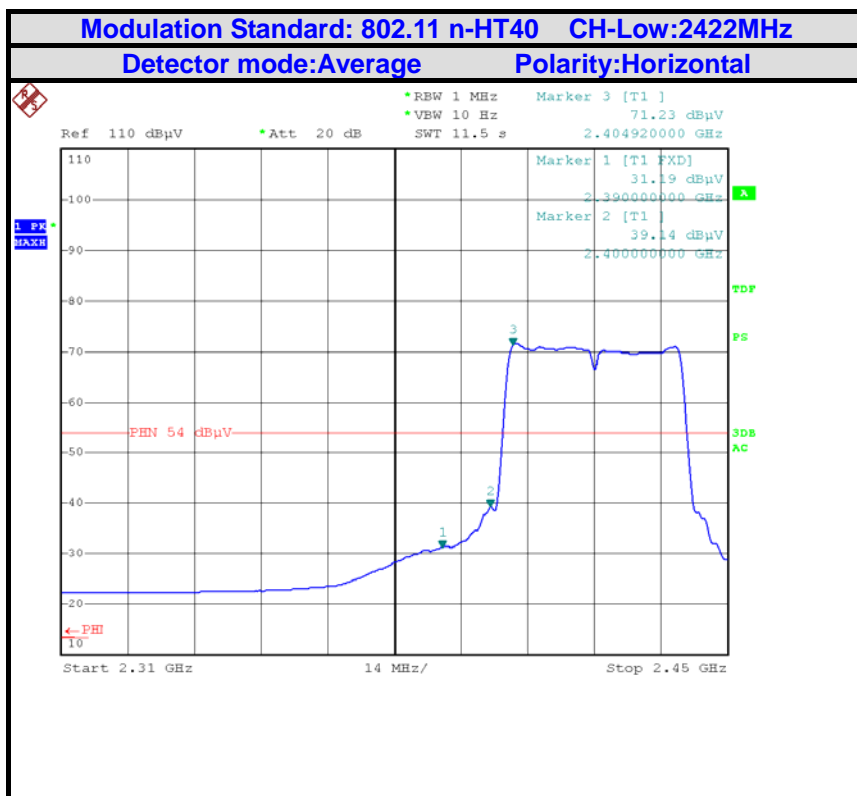
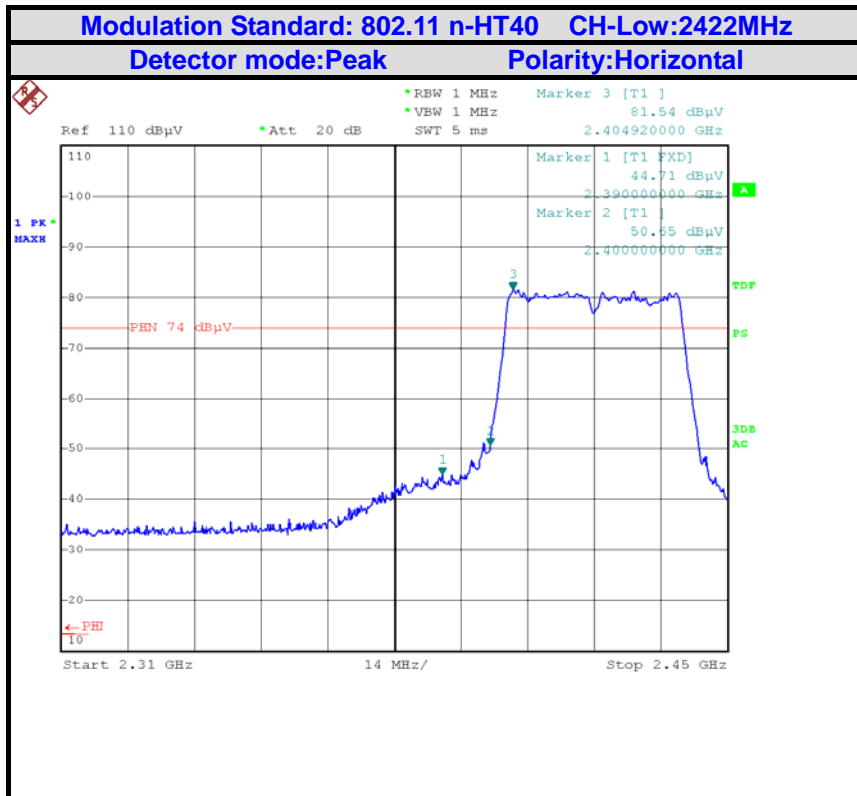

Copyright of this report is owned by Centre of Testing Service and may not be reproduced other than in full except with the written approval of the issuing Company.

CENTRE OF TESTING SERVICE CO., LTD.

A101, No.65, Zhuji Highway, Tianhe District, Guangzhou, China

Tel: +86-20-85543113 (32 lines)

Fax: +86-20-38780406

Complaint line: +86-20-85533471

E-mail: cts@cts-lab.com.cn

See Reverse For Terms And Conditions of Service

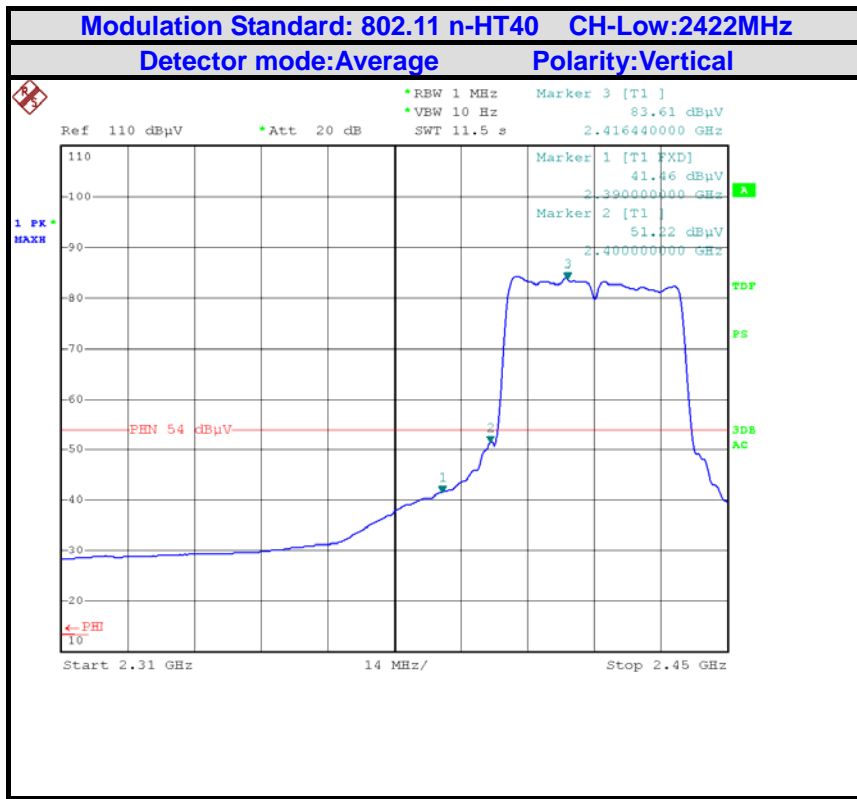
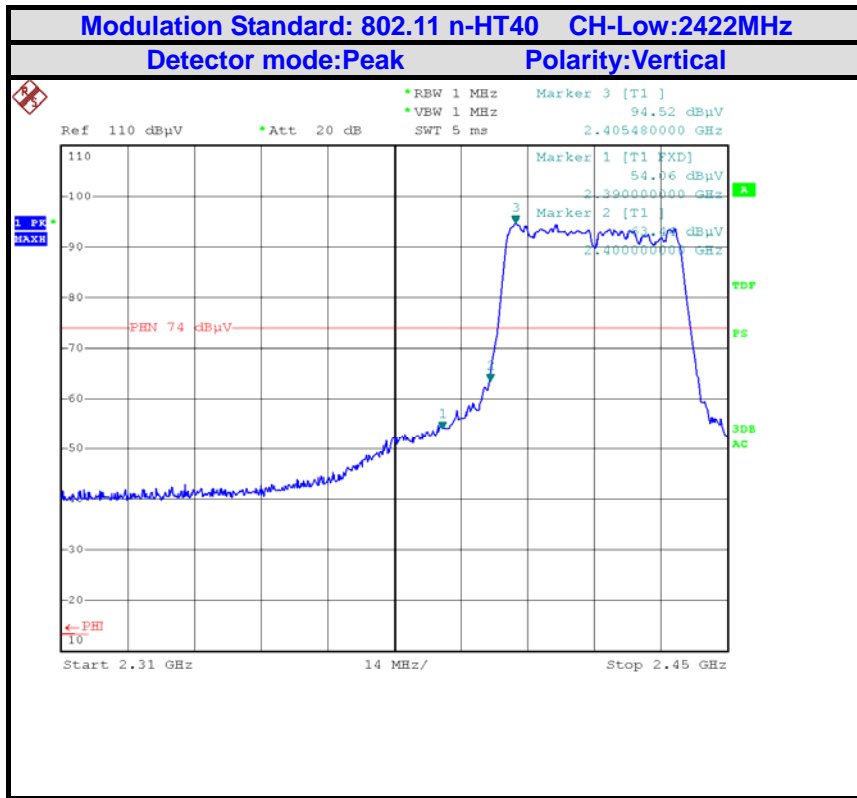

Copyright of this report is owned by Centre of Testing Service and may not be reproduced other than in full except with the written approval of the issuing Company.

CENTRE OF TESTING SERVICE CO., LTD.

A101, No.65, Zhuji Highway, Tianhe District, Guangzhou, China

Tel: +86-20-85543113 (32 lines)

Fax: +86-20-38780406

Complaint line: +86-20-85533471

E-mail: cts@cts-lab.com.cn

See Reverse For Terms And Conditions of Service

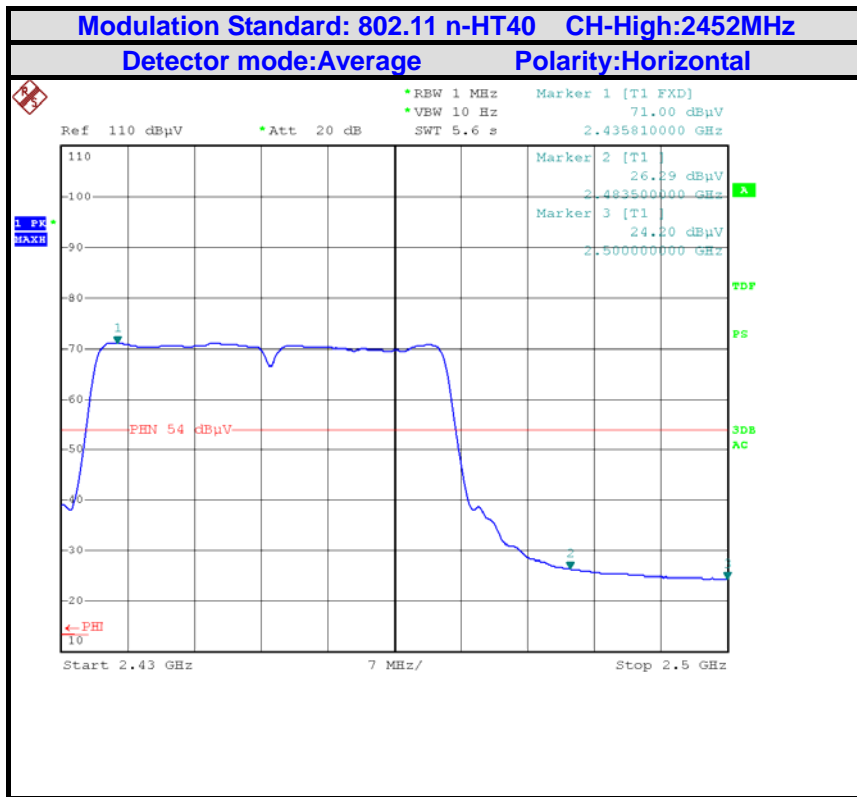
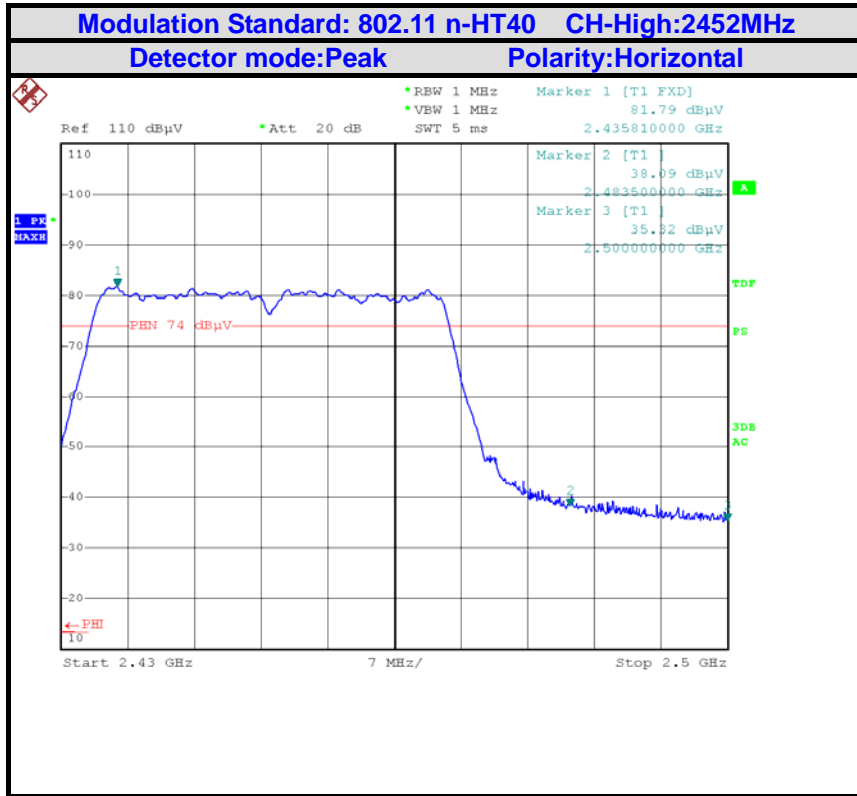

Copyright of this report is owned by Centre of Testing Service and may not be reproduced other than in full except with the written approval of the issuing Company.

CENTRE OF TESTING SERVICE CO., LTD.

A101, No.65, Zhuji Highway, Tianhe District, Guangzhou, China

Tel: +86-20-85543113 (32 lines)

Fax: +86-20-38780406

Complaint line: +86-20-85533471

E-mail: cts@cts-lab.com.cn

See Reverse For Terms And Conditions of Service

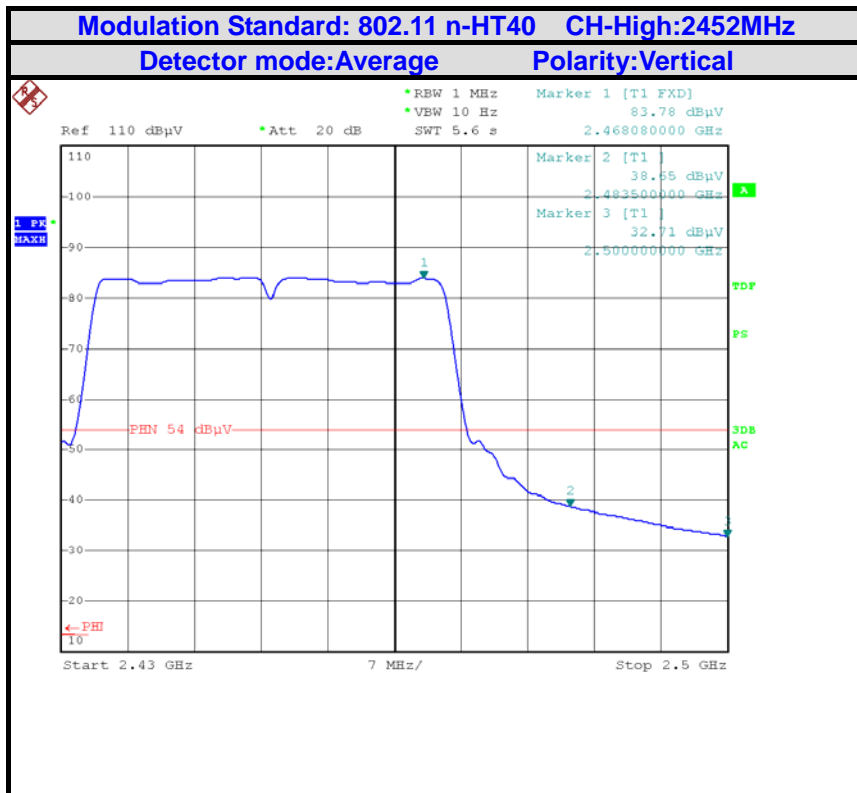
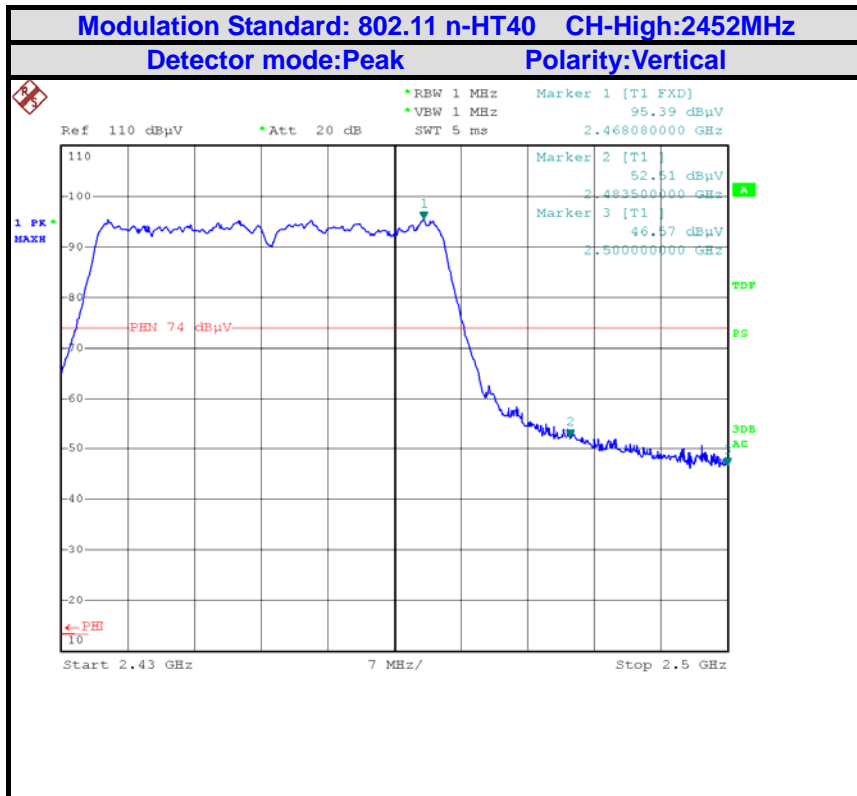

Copyright of this report is owned by Centre of Testing Service and may not be reproduced other than in full except with the written approval of the issuing Company.

CENTRE OF TESTING SERVICE CO., LTD.

A101, No.65, Zhuji Highway, Tianhe District, Guangzhou, China

Tel: +86-20-85543113 (32 lines)

Fax: +86-20-38780406

Complaint line: +86-20-85533471

E-mail: cts@cts-lab.com.cn

See Reverse For Terms And Conditions of Service

11.0 SPURIOUS EMISSIONS

11.1 LIMIT

Except as provided elsewhere in this Subpart, the emissions from an intentional radiator shall not exceed the field strength levels specified in the following table:

FREQUENCY MHz	DISTANCE Meters	FIELD STRENGTHS LIMIT	
		$\mu\text{V}/\text{m}$	$\text{dB}(\mu\text{V})/\text{m}$
0.009 ~ 0.490	300	2400/F(kHz)	---
0.490 ~ 1.705	30	24000/F(kHz)	---
1.705 ~ 30	30	30	---
30 ~ 88	3	100	40.0
88 ~ 216	3	150	43.5
216 ~ 960	3	200	46.0
960 ~ 1000	3	500	54.0
Above 1000	3	Other:74.0 dB(μV)/m (Peak) 54.0 dB(μV)/m (Average)	

Note: Except as provided in paragraph (g), fundamental emissions from intentional radiators operating under this Section shall not be located in the frequency bands 54-72 MHz, 76-88 MHz, 174-216 MHz or 470-806 MHz. However, operation within these frequency bands is permitted under other sections of this Part, e.g., Sections 15.231 and 15.241.

11.2 Test Equipment

Radiated disturbance (electric field)					
Item	Test Equipment	Manufacturer	Model No.	Serial No.	Last Cal.
1	EMI Test Receiver	ROHDE & SCHWARZ	ESCI	100868	2014/11
2	Biconical Antenna	ROHDE & SCHWARZ	HK116	100221	2015/03
3	Log per Antenna	ROHDE & SCHWARZ	HL223	100226	2015/03
4	Log per Antenna	ROHDE & SCHWARZ	HL050	100186	2015/03
5	Signal analyzer	ROHDE & SCHWARZ	FSIQ26	100311	2015/03
6	Loop Antenna	A.R.A	PLA-1030/B	1030	2014/11
7	EMI Test Software	EZ-EMC	Farad	N/A	N/A

Copyright of this report is owned by Centre of Testing Service and may not be reproduced other than in full except with the written approval of the issuing Company.

CENTRE OF TESTING SERVICE CO., LTD.

A101, No.65, Zhuji Highway, Tianhe District, Guangzhou, China

Tel: +86-20-85543113 (32 lines)

Fax: +86-20-38780406

Complaint line: +86-20-85533471

E-mail: cts@cts-lab.com.cn

See Reverse For Terms And Conditions of Service

11.3 TEST CONFIGURATION

Below 30MHz

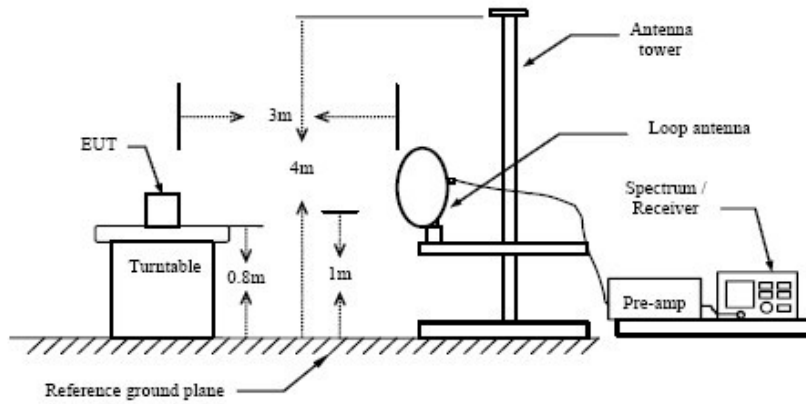

Below 1 GHz

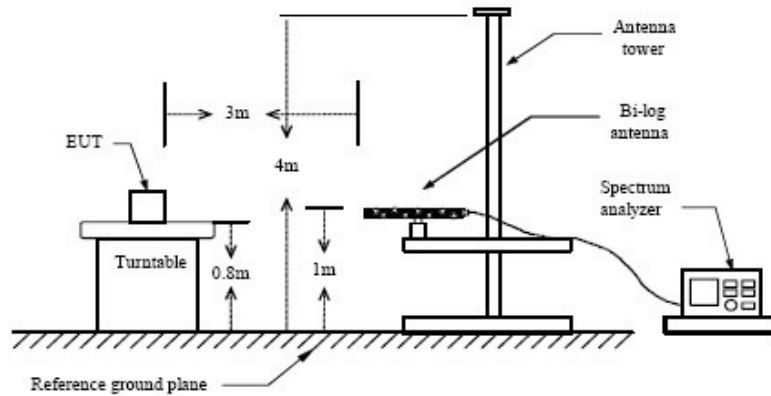

Above 1 GHz

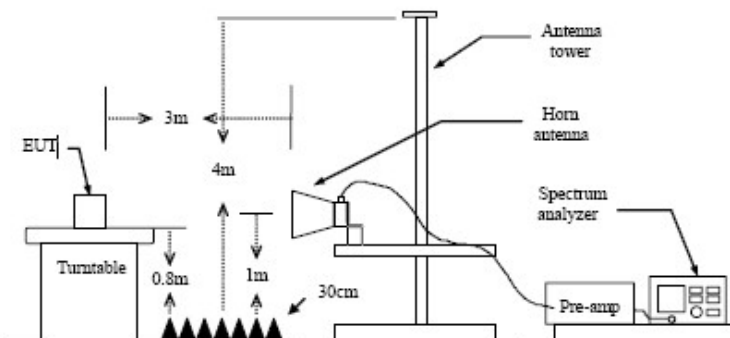

Copyright of this report is owned by Centre of Testing Service and may not be reproduced other than in full except with the written approval of the issuing Company.

CENTRE OF TESTING SERVICE CO., LTD.

A101, No.65, Zhuji Highway, Tianhe District, Guangzhou, China

Tel: +86-20-85543113 (32 lines)

Fax: +86-20-38780406

Complaint line: +86-20-85533471

E-mail: cts@cts-lab.com.cn

See Reverse For Terms And Conditions of Service

11.4 TEST PROCEDURE

1. The EUT is placed on a turntable, which is 0.8m above ground plane.
2. The turntable shall be rotated for 360 degrees to determine the position of maximum emission level.
3. EUT is set 3m away from the receiving antenna, which is varied from 1m to 4m to find out the highest emissions.
4. Maximum procedure was performed on the six highest emissions to ensure EUT compliance.
5. And also, each emission was to be maximized by changing the polarization of receiving antenna both horizontal and vertical.
6. Repeat above procedures until the measurements for all frequencies are complete.

11.5 TEST RESULTS

The frequency range from 9KHz~30MHz, 30MHz to 230MHz, 230MHz to 1000MHz and above 1GHz. is investigated. Please see the following pages.



Test Mode:	TX -X Position Mode	Result:	<input checked="" type="checkbox"/> - passed
Frequency range:	9KHz~30MHz		<input type="checkbox"/> - not passed

No.	Frequency (MHz)	Factor (dB)	Reading (dBuV)	Level (dBuV/m)	Limit (dBuV/m)	Margin (dB)	Det.
Remark: The test result reading value is to low, margin all > 10dB of the limit.							

Copyright of this report is owned by Centre of Testing Service and may not be reproduced other than in full except with the written approval of the issuing Company.

CENTRE OF TESTING SERVICE CO., LTD.

A101, No.65, Zhuji Highway, Tianhe District, Guangzhou, China

Tel: +86-20-85543113 (32 lines)

Fax: +86-20-38780406

Complaint line: +86-20-85533471

E-mail: cts@cts-lab.com.cn

See Reverse For Terms And Conditions of Service

EUT	Wireless Router
Operating Condition	DC 5V by adapter
Test Condition	Ambient Temperature: 25°C Humidity: 56%
Test distance	3 Meter
Test Date:	25 May~24 June 2015
Operator	Duke
MODEL NO	MOFI4500-4GXeLTE

Channel:	TX -X Position	Result:	<input checked="" type="checkbox"/> - passed
Test point:	Horizontal		<input type="checkbox"/> - not passed
Frequency range:	30MHz-1GHz		

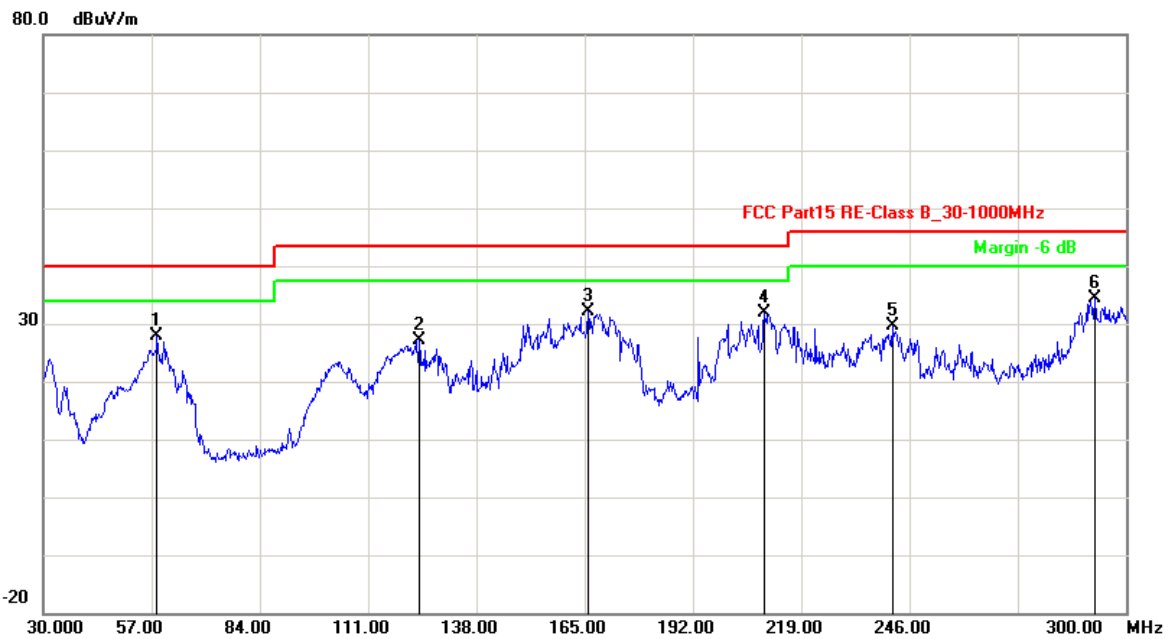

No.	Frequency (MHz)	Factor (dB)	Reading (dBuV)	Level (dBuV/m)	Limit (dBuV/m)	Margin (dB)	Det.
1	58.3500	-19.51	47.47	27.96	40.00	-12.04	QP
2	123.6900	-16.51	43.71	27.20	43.50	-16.30	QP
3	165.8100	-15.98	48.05	32.07	43.50	-11.43	QP
4	209.8200	-10.23	42.22	31.99	43.50	-11.51	QP
5	241.6800	-11.54	41.08	29.54	46.00	-16.46	QP
6	292.1700	-3.49	37.80	34.31	46.00	-11.69	QP

Remark: Other frequency mini margin all >6 dB of Limit

Copyright of this report is owned by Centre of Testing Service and may not be reproduced other than in full except with the written approval of the issuing Company.

CENTRE OF TESTING SERVICE CO., LTD.

A101, No.65, Zhuji Highway, Tianhe District, Guangzhou, China
 Tel: +86-20-85543113 (32 lines) Fax: +86-20-38780406
 Complaint line: +86-20-85533471 E-mail: cts@cts-lab.com.cn

See Reverse For Terms And Conditions of Service

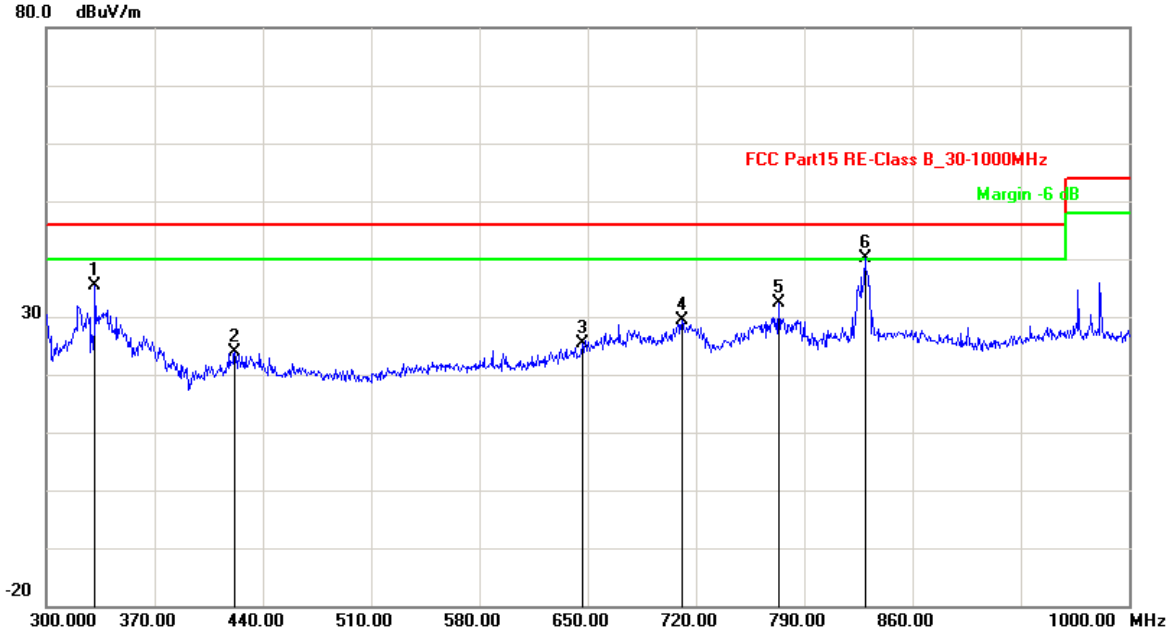

No.	Frequency (MHz)	Factor (dB)	Reading (dBuV)	Level (dBuV/m)	Limit (dBuV/m)	Margin (dB)	Det.
1	331.5000	-12.19	47.62	35.43	46.00	-10.57	QP
2	421.8000	-9.62	33.46	23.84	46.00	-22.16	QP
3	646.5000	-3.39	28.86	25.47	46.00	-20.53	QP
4	710.9000	-3.25	32.61	29.36	46.00	-16.64	QP
5	773.2000	-2.37	34.82	32.45	46.00	-13.55	QP
6	829.2000	-1.53	41.63	40.10	46.00	-5.90	QP

Remark: Other frequency mini margin all >6 dB of Limit

Copyright of this report is owned by Centre of Testing Service and may not be reproduced other than in full except with the written approval of the issuing Company.

CENTRE OF TESTING SERVICE CO., LTD.

A101, No.65, Zhuji Highway, Tianhe District, Guangzhou, China

Tel: +86-20-85543113 (32 lines)

Fax: +86-20-38780406

Complaint line: +86-20-85533471

E-mail: cts@cts-lab.com.cn

See Reverse For Terms And Conditions of Service

Modulation Standard: 802.11 b	Result: <input checked="" type="checkbox"/> - passed
Channel: Low Channel	<input type="checkbox"/> - not passed
Test point: Horizontal	
Frequency range: 1GHz-26.5GHz	

No.	Frequency (MHz)	Factor (dB)	Reading (dBuV)	Level (dBuV/m)	Limit (dBuV/m)	Margin (dB)	Det.
1	3446.894	-1.82	36.64	34.82	74.00	-39.18	peak
2	3446.894	-1.82	21.98	20.16	54.00	-33.84	AVG
3	5783.567	5.80	38.84	44.64	74.00	-29.36	peak
4	5783.567	5.80	24.48	30.28	54.00	-23.72	AVG

Remark: Other frequency mini margin all >6 dB of Limit

Modulation Standard: 802.11 b	Result: <input checked="" type="checkbox"/> - passed
Channel: Middle Channel	<input type="checkbox"/> - not passed
Test point: Horizontal	
Frequency range: 1GHz-26.5GHz	

No.	Frequency (MHz)	Factor (dB)	Reading (dBuV)	Level (dBuV/m)	Limit (dBuV/m)	Margin (dB)	Det.
1	3513.026	-1.57	37.14	35.57	74.00	-38.43	peak
2	3513.026	-1.57	22.86	21.29	54.00	-32.71	AVG
3	6070.140	6.74	40.66	47.40	74.00	-26.60	peak
4	6070.140	6.74	25.94	32.68	54.00	-21.32	AVG

Remark: Other frequency mini margin all >6 dB of Limit

Modulation Standard: 802.11 b	Result: <input checked="" type="checkbox"/> - passed
Channel: High Channel	<input type="checkbox"/> - not passed
Test point: Horizontal	
Frequency range: 1GHz-26.5GHz	

No.	Frequency (MHz)	Factor (dB)	Reading (dBuV)	Level (dBuV/m)	Limit (dBuV/m)	Margin (dB)	Det.
1	3997.996	-0.23	36.88	36.65	74.00	-37.35	peak
2	3997.996	-0.23	22.54	22.31	54.00	-31.69	AVG
3	6929.860	8.30	43.39	51.69	74.00	-22.31	peak
4	6929.860	8.30	28.24	36.54	54.00	-17.46	AVG

Remark: Other frequency mini margin all >6 dB of Limit

Copyright of this report is owned by Centre of Testing Service and may not be reproduced other than in full except with the written approval of the issuing Company.

CENTRE OF TESTING SERVICE CO., LTD.

A101, No.65, Zhuji Highway, Tianhe District, Guangzhou, China

Tel: +86-20-85543113 (32 lines)

Fax: +86-20-38780406

Complaint line: +86-20-85533471

E-mail: cts@cts-lab.com.cn

See Reverse For Terms And Conditions of Service



Modulation Standard: 802.11 g	Result: <input checked="" type="checkbox"/> - passed
Channel: Low Channel	<input type="checkbox"/> - not passed
Test point: Horizontal	
Frequency range: 1GHz-26.5GHz	

No.	Frequency (MHz)	Factor (dB)	Reading (dBuV)	Level (dBuV/m)	Limit (dBuV/m)	Margin (dB)	Det.
1	3513.026	-1.57	36.50	34.93	74.00	-39.07	peak
2	3513.026	-1.57	21.70	20.13	54.00	-33.87	AVG
3	5717.435	5.55	39.49	45.04	74.00	-28.96	peak
4	5717.435	5.55	25.30	30.85	54.00	-23.15	AVG

Remark: Other frequency mini margin all >6 dB of Limit

Modulation Standard: 802.11 g	Result: <input checked="" type="checkbox"/> - passed
Channel: Middle Channel	<input type="checkbox"/> - not passed
Test point: Horizontal	
Frequency range: 1GHz-26.5GHz	

No.	Frequency (MHz)	Factor (dB)	Reading (dBuV)	Level (dBuV/m)	Limit (dBuV/m)	Margin (dB)	Det.
1	3513.026	-1.57	36.11	34.54	74.00	-39.46	peak
2	3513.026	-1.57	21.71	20.14	54.00	-33.86	AVG
3	5893.788	6.21	39.70	45.91	74.00	-28.09	peak
4	5893.788	6.21	24.07	30.28	54.00	-23.72	AVG

Remark: Other frequency mini margin all >6 dB of Limit

Modulation Standard: 802.11 g	Result: <input checked="" type="checkbox"/> - passed
Channel: High Channel	<input type="checkbox"/> - not passed
Test point: Horizontal	
Frequency range: 1GHz-26.5GHz	

No.	Frequency (MHz)	Factor (dB)	Reading (dBuV)	Level (dBuV/m)	Limit (dBuV/m)	Margin (dB)	Det.
1	3513.026	-1.57	36.26	34.69	74.00	-39.31	peak
2	3513.026	-1.57	21.72	20.15	54.00	-33.85	AVG
3	6268.537	7.12	39.34	46.46	74.00	-27.54	peak
4	6268.537	7.12	25.46	32.58	54.00	-21.42	AVG

Remark: Other frequency mini margin all >6 dB of Limit

Copyright of this report is owned by Centre of Testing Service and may not be reproduced other than in full except with the written approval of the issuing Company.

CENTRE OF TESTING SERVICE CO., LTD.

A101, No.65, Zhuji Highway, Tianhe District, Guangzhou, China
 Tel: +86-20-85543113 (32 lines) Fax: +86-20-38780406
 Complaint line: +86-20-85533471 E-mail: cts@cts-lab.com.cn

See Reverse For Terms And Conditions of Service



Modulation Standard: 802.11n-HT20 Channel: Low Channel Test point: Horizontal Frequency range: 1GHz-26.5GHz	Result: <input checked="" type="checkbox"/> - passed <input type="checkbox"/> - not passed
--	---

No.	Frequency (MHz)	Factor (dB)	Reading (dBuV)	Level (dBuV/m)	Limit (dBuV/m)	Margin (dB)	Det.
1	3028.056	-3.44	38.72	35.28	74.00	-38.72	peak
2	3028.056	-3.44	23.60	20.16	54.00	-33.84	AVG
3	5276.553	4.09	37.19	41.28	74.00	-32.72	peak
4	5276.553	4.09	22.76	26.85	54.00	-27.15	AVG

Remark: Other frequency mini margin all >6 dB of Limit

Modulation Standard: 802.11n-HT20 Channel: Middle Channel Test point: Horizontal Frequency range: 1GHz-26.5GHz	Result: <input checked="" type="checkbox"/> - passed <input type="checkbox"/> - not passed
---	---

No.	Frequency (MHz)	Factor (dB)	Reading (dBuV)	Level (dBuV/m)	Limit (dBuV/m)	Margin (dB)	Det.
1	3248.497	-2.59	36.05	33.46	74.00	-40.54	peak
2	3248.497	-2.59	22.62	20.03	54.00	-33.97	AVG
3	5783.567	5.80	38.53	44.33	74.00	-29.67	peak
4	5783.567	5.80	24.48	30.28	54.00	-23.72	AVG

Remark: Other frequency mini margin all >6 dB of Limit

Modulation Standard: 802.11n-HT20 Channel: High Channel Test point: Horizontal Frequency range: 1GHz-26.5GHz	Result: <input checked="" type="checkbox"/> - passed <input type="checkbox"/> - not passed
---	---

No.	Frequency (MHz)	Factor (dB)	Reading (dBuV)	Level (dBuV/m)	Limit (dBuV/m)	Margin (dB)	Det.
1	3292.585	-2.41	37.02	34.61	74.00	-39.39	peak
2	3292.585	-2.41	22.57	20.16	54.00	-33.84	AVG
3	5783.567	5.80	38.65	44.45	74.00	-29.55	peak
4	5783.567	5.80	24.72	30.52	54.00	-23.48	AVG

Remark: Other frequency mini margin all >6 dB of Limit

Copyright of this report is owned by Centre of Testing Service and may not be reproduced other than in full except with the written approval of the issuing Company.

CENTRE OF TESTING SERVICE CO., LTD.

A101, No.65, Zhuji Highway, Tianhe District, Guangzhou, China
 Tel: +86-20-85543113 (32 lines) Fax: +86-20-38780406
 Complaint line: +86-20-85533471 E-mail: cts@cts-lab.com.cn

See Reverse For Terms And Conditions of Service



Modulation Standard: 802.11n-HT40 Channel: Low Channel Test point: Horizontal Frequency range: 1GHz-26.5GHz	Result: <input checked="" type="checkbox"/> - passed <input type="checkbox"/> - not passed
--	---

No.	Frequency (MHz)	Factor (dB)	Reading (dBuV)	Level (dBuV/m)	Limit (dBuV/m)	Margin (dB)	Det.
1	3733.467	-0.96	36.37	35.41	74.00	-38.59	peak
2	3733.467	-0.96	21.12	20.16	54.00	-33.84	AVG
3	6268.537	7.12	40.97	48.09	74.00	-25.91	peak
4	6268.537	7.12	26.16	33.28	54.00	-20.72	AVG

Remark: Other frequency mini margin all >6 dB of Limit

Modulation Standard: 802.11n-HT40 Channel: Middle Channel Test point: Horizontal Frequency range: 1GHz-26.5GHz	Result: <input checked="" type="checkbox"/> - passed <input type="checkbox"/> - not passed
---	---

No.	Frequency (MHz)	Factor (dB)	Reading (dBuV)	Level (dBuV/m)	Limit (dBuV/m)	Margin (dB)	Det.
1	3667.335	-1.14	36.51	35.37	74.00	-38.63	peak
2	3667.335	-1.14	21.29	20.15	54.00	-33.85	AVG
3	6466.934	7.50	40.63	48.13	74.00	-25.87	peak
4	6466.934	7.50	26.79	34.29	54.00	-19.71	AVG

Remark: Other frequency mini margin all >6 dB of Limit

Modulation Standard: 802.11n-HT40 Channel: High Channel Test point: Horizontal Frequency range: 1GHz-26.5GHz	Result: <input checked="" type="checkbox"/> - passed <input type="checkbox"/> - not passed
---	---

No.	Frequency (MHz)	Factor (dB)	Reading (dBuV)	Level (dBuV/m)	Limit (dBuV/m)	Margin (dB)	Det.
1	3380.762	-2.07	35.98	33.91	74.00	-40.09	peak
2	3380.762	-2.07	22.08	20.01	54.00	-33.99	AVG
3	5474.950	4.67	39.96	44.63	74.00	-29.37	peak
4	5474.950	4.67	25.59	30.26	54.00	-23.74	AVG

Remark: Other frequency mini margin all >6 dB of Limit

Copyright of this report is owned by Centre of Testing Service and may not be reproduced other than in full except with the written approval of the issuing Company.

CENTRE OF TESTING SERVICE CO., LTD.

A101, No.65, Zhuji Highway, Tianhe District, Guangzhou, China
 Tel: +86-20-85543113 (32 lines) Fax: +86-20-38780406
 Complaint line: +86-20-85533471 E-mail: cts@cts-lab.com.cn

See Reverse For Terms And Conditions of Service

Channel:	TX -X Position	Result:	■ - passed
Test point:	Vertical		□ - not passed
Frequency range:	30MHz-1GHz		

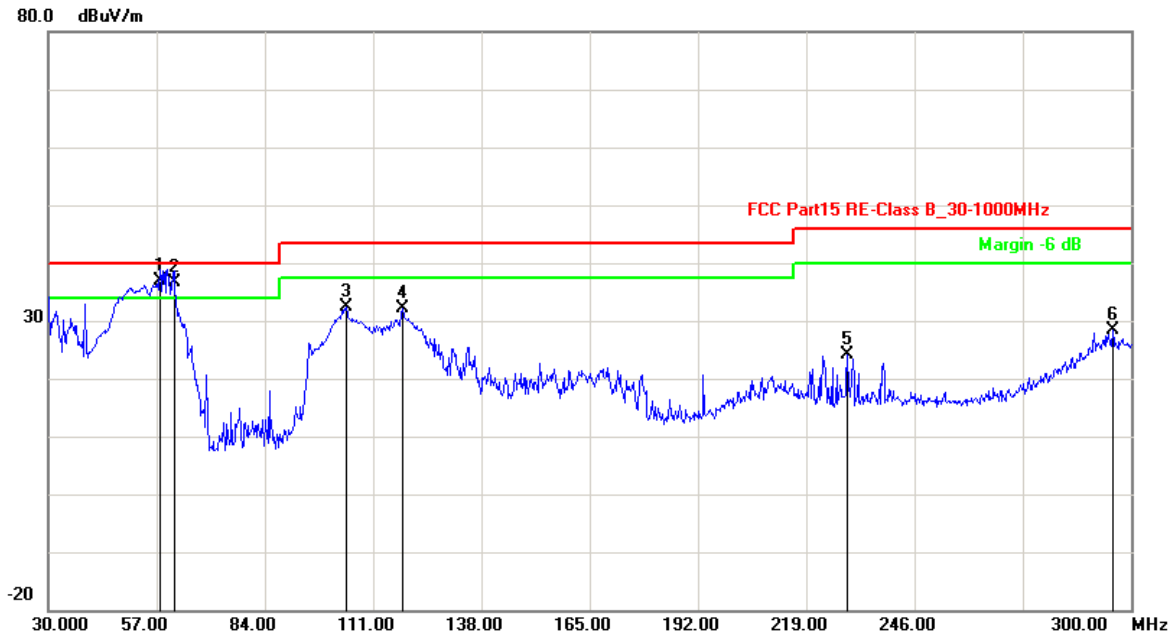

No.	Frequency (MHz)	Factor (dB)	Reading (dBuV)	Level (dBuV/m)	Limit (dBuV/m)	Margin (dB)	Det.
1	57.8100	-19.46	56.39	36.93	40.00	-3.07	QP
2	61.3200	-19.83	56.36	36.53	40.00	-3.47	QP
3	104.2500	-17.83	50.22	32.39	43.50	-11.11	QP
4	118.2900	-16.82	49.01	32.19	43.50	-11.31	QP
5	229.2600	-11.60	35.79	24.19	46.00	-21.81	QP
6	295.4100	-2.64	30.95	28.31	46.00	-17.69	QP

Remark: Other frequency mini margin all >6 dB of Limit

Copyright of this report is owned by Centre of Testing Service and may not be reproduced other than in full except with the written approval of the issuing Company.

CENTRE OF TESTING SERVICE CO., LTD.

A101, No.65, Zhuji Highway, Tianhe District, Guangzhou, China

Tel: +86-20-85543113 (32 lines)

Fax: +86-20-38780406

Complaint line: +86-20-85533471

E-mail: cts@cts-lab.com.cn

See Reverse For Terms And Conditions of Service

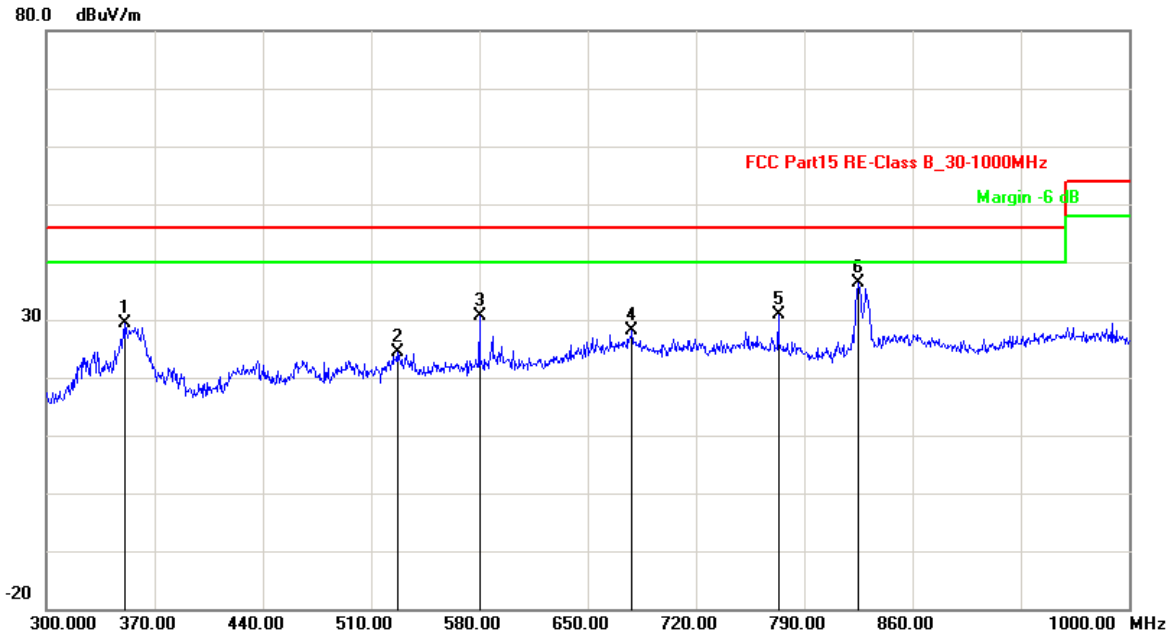

No.	Frequency (MHz)	Factor (dB)	Reading (dBuV)	Level (dBuV/m)	Limit (dBuV/m)	Margin (dB)	Det.
1	351.1000	-11.33	40.76	29.43	46.00	-16.57	QP
2	526.8000	-6.81	31.10	24.29	46.00	-21.71	QP
3	580.0000	-5.60	36.17	30.57	46.00	-15.43	QP
4	678.7000	-3.51	31.56	28.05	46.00	-17.95	QP
5	773.2000	-2.37	33.27	30.90	46.00	-15.10	QP
6	825.0000	-1.78	38.16	36.38	46.00	-9.62	QP

Remark: Other frequency mini margin all >6 dB of Limit

Copyright of this report is owned by Centre of Testing Service and may not be reproduced other than in full except with the written approval of the issuing Company.

CENTRE OF TESTING SERVICE CO., LTD.

A101, No.65, Zhuji Highway, Tianhe District, Guangzhou, China

Tel: +86-20-85543113 (32 lines)

Fax: +86-20-38780406

Complaint line: +86-20-85533471

E-mail: cts@cts-lab.com.cn

See Reverse For Terms And Conditions of Service



Modulation Standard: 802.11 b Channel: Low Channel Test point: Vertical Frequency range: 1GHz-26.5GHz	Result: <input checked="" type="checkbox"/> - passed <input type="checkbox"/> - not passed
--	---

No.	Frequency (MHz)	Factor (dB)	Reading (dBuV)	Level (dBuV/m)	Limit (dBuV/m)	Margin (dB)	Det.
1	2961.924	-3.76	38.42	34.66	74.00	-39.34	peak
2	2961.924	-3.76	23.92	20.16	54.00	-33.84	AVG
3	5474.950	4.67	39.58	44.25	74.00	-29.75	peak
4	5474.950	4.67	26.18	30.85	54.00	-23.15	AVG
Remark: Other frequency mini margin all >6 dB of Limit							

Modulation Standard: 802.11 b Channel: Middle Channel Test point: Vertical Frequency range: 1GHz-26.5GHz	Result: <input checked="" type="checkbox"/> - passed <input type="checkbox"/> - not passed
---	---

No.	Frequency (MHz)	Factor (dB)	Reading (dBuV)	Level (dBuV/m)	Limit (dBuV/m)	Margin (dB)	Det.
1	3248.497	-2.59	36.39	33.80	74.00	-40.20	peak
2	3248.497	-2.59	22.72	20.13	54.00	-33.87	AVG
3	5915.832	6.30	40.52	46.82	74.00	-27.18	peak
4	5915.832	6.30	25.55	31.85	54.00	-22.15	AVG
Remark: Other frequency mini margin all >6 dB of Limit							

Modulation Standard: 802.11 b Channel: High Channel Test point: Vertical Frequency range: 1GHz-26.5GHz	Result: <input checked="" type="checkbox"/> - passed <input type="checkbox"/> - not passed
---	---

No.	Frequency (MHz)	Factor (dB)	Reading (dBuV)	Level (dBuV/m)	Limit (dBuV/m)	Margin (dB)	Det.
1	4086.172	0.10	36.74	36.84	74.00	-37.16	peak
2	4086.172	0.10	21.26	21.36	54.00	-32.64	AVG
3	6048.096	6.70	40.84	47.54	74.00	-26.46	peak
4	6048.096	6.70	26.88	33.58	54.00	-20.42	AVG
Remark: Other frequency mini margin all >6 dB of Limit							

Copyright of this report is owned by Centre of Testing Service and may not be reproduced other than in full except with the written approval of the issuing Company.

CENTRE OF TESTING SERVICE CO., LTD.

A101, No.65, Zhuji Highway, Tianhe District, Guangzhou, China
 Tel: +86-20-85543113 (32 lines) Fax: +86-20-38780406
 Complaint line: +86-20-85533471 E-mail: cts@cts-lab.com.cn

See Reverse For Terms And Conditions of Service



Modulation Standard: 802.11 g	Result: <input checked="" type="checkbox"/> - passed
Channel: Low Channel	<input type="checkbox"/> - not passed
Test point: Vertical	
Frequency range: 1GHz-26.5GHz	

No.	Frequency (MHz)	Factor (dB)	Reading (dBuV)	Level (dBuV/m)	Limit (dBuV/m)	Margin (dB)	Det.
1	3755.511	-0.90	38.36	37.46	74.00	-36.54	peak
2	3755.511	-0.90	23.21	22.31	54.00	-31.69	AVG
3	6599.198	7.73	42.43	50.16	74.00	-23.84	peak
4	6599.198	7.73	28.75	36.48	54.00	-17.52	AVG

Remark: Other frequency mini margin all >6 dB of Limit

Modulation Standard: 802.11 g	Result: <input checked="" type="checkbox"/> - passed
Channel: Middle Channel	<input type="checkbox"/> - not passed
Test point: Vertical	
Frequency range: 1GHz-26.5GHz	

No.	Frequency (MHz)	Factor (dB)	Reading (dBuV)	Level (dBuV/m)	Limit (dBuV/m)	Margin (dB)	Det.
1	3821.643	-0.72	36.92	36.20	74.00	-37.80	peak
2	3821.643	-0.72	21.98	21.26	54.00	-32.74	AVG
3	6004.008	6.62	40.29	46.91	74.00	-27.09	peak
4	6004.008	6.62	25.95	32.57	54.00	-21.43	AVG

Remark: Other frequency mini margin all >6 dB of Limit

Modulation Standard: 802.11 g	Result: <input checked="" type="checkbox"/> - passed
Channel: High Channel	<input type="checkbox"/> - not passed
Test point: Vertical	
Frequency range: 1GHz-26.5GHz	

No.	Frequency (MHz)	Factor (dB)	Reading (dBuV)	Level (dBuV/m)	Limit (dBuV/m)	Margin (dB)	Det.
1	3358.717	-2.16	37.07	34.91	74.00	-39.09	peak
2	3358.717	-2.16	22.30	20.14	54.00	-33.86	AVG
3	5496.994	4.73	38.12	42.85	74.00	-31.15	peak
4	5496.994	4.73	22.85	27.58	54.00	-26.42	AVG

Remark: Other frequency mini margin all >6 dB of Limit

Copyright of this report is owned by Centre of Testing Service and may not be reproduced other than in full except with the written approval of the issuing Company.

CENTRE OF TESTING SERVICE CO., LTD.

A101, No.65, Zhuji Highway, Tianhe District, Guangzhou, China

Tel: +86-20-85543113 (32 lines)

Fax: +86-20-38780406

Complaint line: +86-20-85533471

E-mail: cts@cts-lab.com.cn

See Reverse For Terms And Conditions of Service



Modulation Standard: 802.11n-HT20	Result: <input checked="" type="checkbox"/> - passed
Channel: Low Channel	<input type="checkbox"/> - not passed
Test point: Vertical	
Frequency range: 1GHz-26.5GHz	

No.	Frequency (MHz)	Factor (dB)	Reading (dBuV)	Level (dBuV/m)	Limit (dBuV/m)	Margin (dB)	Det.
1	3270.541	-2.50	36.25	33.75	74.00	-40.25	peak
2	3270.541	-2.50	22.51	20.01	54.00	-33.99	AVG
3	5496.994	4.73	39.51	44.24	74.00	-29.76	peak
4	5496.994	4.73	25.53	30.26	54.00	-23.74	AVG

Remark: Other frequency mini margin all >6 dB of Limit

Modulation Standard: 802.11n-HT20	Result: <input checked="" type="checkbox"/> - passed
Channel: Middle Channel	<input type="checkbox"/> - not passed
Test point: Vertical	
Frequency range: 1GHz-26.5GHz	

No.	Frequency (MHz)	Factor (dB)	Reading (dBuV)	Level (dBuV/m)	Limit (dBuV/m)	Margin (dB)	Det.
1	3777.555	-0.84	36.94	36.10	74.00	-37.90	peak
2	3777.555	-0.84	22.43	21.59	54.00	-32.41	AVG
3	5893.788	6.21	40.47	46.68	74.00	-27.32	peak
4	5893.788	6.21	26.37	32.58	54.00	-21.42	AVG

Remark: Other frequency mini margin all >6 dB of Limit

Modulation Standard: 802.11n-HT20	Result: <input checked="" type="checkbox"/> - passed
Channel: High Channel	<input type="checkbox"/> - not passed
Test point: Vertical	
Frequency range: 1GHz-26.5GHz	

No.	Frequency (MHz)	Factor (dB)	Reading (dBuV)	Level (dBuV/m)	Limit (dBuV/m)	Margin (dB)	Det.
1	4108.216	0.18	36.45	36.63	74.00	-37.37	peak
2	4108.216	0.18	21.97	22.15	54.00	-31.85	AVG
3	6422.846	7.41	41.31	48.72	74.00	-25.28	peak
4	6422.846	7.41	27.21	34.62	54.00	-19.38	AVG

Remark: Other frequency mini margin all >6 dB of Limit

Copyright of this report is owned by Centre of Testing Service and may not be reproduced other than in full except with the written approval of the issuing Company.

CENTRE OF TESTING SERVICE CO., LTD.

A101, No.65, Zhuji Highway, Tianhe District, Guangzhou, China
 Tel: +86-20-85543113 (32 lines) Fax: +86-20-38780406
 Complaint line: +86-20-85533471 E-mail: cts@cts-lab.com.cn

See Reverse For Terms And Conditions of Service



Modulation Standard: 802.11n-HT40 Channel: Low Channel Test point: Vertical Frequency range: 1GHz-26.5GHz	Result: <input checked="" type="checkbox"/> - passed <input type="checkbox"/> - not passed
--	---

No.	Frequency (MHz)	Factor (dB)	Reading (dBuV)	Level (dBuV/m)	Limit (dBuV/m)	Margin (dB)	Det.
1	3535.070	-1.51	35.40	33.89	74.00	-40.11	peak
2	3535.070	-1.51	21.65	20.14	54.00	-33.86	AVG
3	5673.347	5.39	39.06	44.45	74.00	-29.55	peak
4	5673.347	5.39	24.83	30.22	54.00	-23.78	AVG
Remark: Other frequency mini margin all >6 dB of Limit							

Modulation Standard: 802.11n-HT40 Channel: Middle Channel Test point: Vertical Frequency range: 1GHz-26.5GHz	Result: <input checked="" type="checkbox"/> - passed <input type="checkbox"/> - not passed
---	---

No.	Frequency (MHz)	Factor (dB)	Reading (dBuV)	Level (dBuV/m)	Limit (dBuV/m)	Margin (dB)	Det.
1	3468.938	-1.73	35.73	34.00	74.00	-40.00	peak
2	3468.938	-1.73	21.99	20.26	54.00	-33.74	AVG
3	5563.126	4.98	38.33	43.31	74.00	-30.69	peak
4	5563.126	4.98	23.71	28.69	54.00	-25.31	AVG
Remark: Other frequency mini margin all >6 dB of Limit							

Modulation Standard: 802.11n-HT40 Channel: High Channel Test point: Vertical Frequency range: 1GHz-26.5GHz	Result: <input checked="" type="checkbox"/> - passed <input type="checkbox"/> - not passed
---	---

No.	Frequency (MHz)	Factor (dB)	Reading (dBuV)	Level (dBuV/m)	Limit (dBuV/m)	Margin (dB)	Det.
1	3733.467	-0.96	36.26	35.30	74.00	-38.70	peak
2	3733.467	-0.96	21.32	20.36	54.00	-33.64	AVG
3	5871.743	6.13	40.13	46.26	74.00	-27.74	peak
4	5871.743	6.13	26.12	32.25	54.00	-21.75	AVG
Remark: Other frequency mini margin all >6 dB of Limit							

Copyright of this report is owned by Centre of Testing Service and may not be reproduced other than in full except with the written approval of the issuing Company.

CENTRE OF TESTING SERVICE CO., LTD.

A101, No.65, Zhuji Highway, Tianhe District, Guangzhou, China
 Tel: +86-20-85543113 (32 lines) Fax: +86-20-38780406
 Complaint line: +86-20-85533471 E-mail: cts@cts-lab.com.cn

See Reverse For Terms And Conditions of Service

12.0 Antenna Requirements

12.1 Standard Applicable

For intentional device, according to FCC 47 CFR Section 15.203, an intentional radiator shall be designed to ensure that no antenna other than that furnished by the responsible party shall be used with the device.

And according to FCC 47 CFR Section 15.247 (b), if transmitting antennas of directional gain greater than 6dBi are used, the power shall be reduced by the amount in dB that the directional gain of the antenna exceeds 6dBi.

12.2 Antenna Construction and Directional Gain

Antenna type: External antenna

Antenna Gain: 5 dBi

13.0 Deviation to test specifications

The following identical model(s):

N/A

Belong to the tested device:

Product description: **Wireless Router**

Model name: **MOFI4500-4GXeLTE**