



TEST REPORT



DT&C Co., Ltd.

42, Yurim-ro, 154Beon-gil, Cheoin-gu, Yongin-si, Gyeonggi-do, Korea, 17042
Tel : 031-321-2664, Fax : 031-321-1664

1. Report No : DRTFCC1905-0185
2. Customer
 - Name : Amotech Corp.
 - Address : 5BL-1LOT, 380, Namdongseo-ro, Namdong-gu, Incheon, South Korea
3. Use of Report : FCC Original Grant
4. Product Name / Model Name : ACCESS & CONNECTED CAR MODULE / ACCM200-US4G-1A
FCC ID : 2AE6H-ACCM
5. Test Method Used : KDB971168 D01v03r01, ANSI/TIA-603-E-2016, ANSI C63.26-2015
Test Specification : §2, §24(E), §27
6. Date of Test : 2019.02.26 ~ 2019.03.29
7. Testing Environment : Refer to appended test report.
8. Test Result : Refer to the attached test result.

Affirmation	Tested by		Reviewed by	
	Name : InHee Bae		Name : Geunki Son	

The test results presented in this test report are limited only to the sample supplied by applicant and the use of this test report is inhibited other than its purpose. This test report shall not be reproduced except in full, without the written approval of DT&C Co., Ltd.

2019 . 05 . 17 .

DT&C Co., Ltd.

If this report is required to confirmation of authenticity, please contact to report@dtnc.net

Test Report Version

Test Report No.	Date	Description
DRTFCC1905-0185	May. 17, 2019	Initial issue

Table of Contents

1. GENERAL INFORMATION	5
2. INTRODUCTION	6
2.1 EUT DESCRIPTION	6
2.2. EUT CAPABILITIES	6
2.3. TESTING ENVIRONMENT	6
2.4 MEASURING INSTRUMENT CALIBRATION.....	6
2.5. MEASUREMENT UNCERTAINTY	6
2.6. TEST FACILITY.....	6
3. DESCRIPTION OF TESTS.....	7
3.1 ERP & EIRP (Effective Radiated Power & Equivalent Isotropic Radiated Power)	7
3.2 PEAK TO AVERAGE RATIO	9
3.3 OCCUPIED BANDWIDTH.....	10
3.4 BAND EDGE EMISSIONS AT ANTENNA TERMINAL	11
3.5 SPURIOUS AND HARMONIC EMISSIONS AT ANTENNA TERMINAL	12
3.6 UNDESIRABLE EMISSIONS	13
3.7 FREQUENCY STABILITY	14
4. LIST OF TEST EQUIPMENT	15
5. SUMMARY OF TEST RESULTS	16
6. SAMPLE CALCULATION	17
7. TEST DATA.....	19
7.1 CONDUCTED OUTPUT POWER	19
7.2 OCCUPIED BANDWIDTH.....	22
7.3 PEAK TO AVERAGE RATIO	22
7.4 BAND EDEG EMISSIONS (Conducted).....	22
7.5 SPURIOUS AND HARMONICS EMISSIONS (Conducted)	22
7.6 ERP & EIRP	23
7.6.1 LTE Band 12.....	23
7.6.2 LTE Band 4.....	24
7.6.3 LTE Band 2.....	25
7.7 UNDESIRABLE EMISSIONS (Radiated).....	26
7.7.1 LTE Band 12.....	26
7.7.2 LTE Band 4.....	28
7.7.3 LTE Band 2.....	30
7.8 FREQUENCY STABILITY	32
7.8.1 LTE Band 12.....	32
7.8.2 LTE Band 4.....	33
7.8.3 LTE Band 2.....	34
8. TEST PLOTS	35
8.1 OCCUPIED BANDWIDTH.....	35

8.1.1 LTE Band 12.....	35
8.1.2 LTE Band 4.....	39
8.1.3 LTE Band 2.....	45
8.2 PEAK TO AVERAGE RATIO.....	51
8.2.1 LTE Band 12.....	51
8.2.2 LTE Band 4.....	55
8.2.3 LTE Band 2.....	61
8.3 BAND EDGE EMISSIONS(Conducted).....	67
8.3.1 LTE Band 12.....	67
8.3.2 LTE Band 4.....	75
8.3.3 LTE Band 2.....	87
8.4 SPURIOUS AND HARMONICS EMISSIONS(Conducted)	99
8.4.1 LTE Band 12.....	99
8.4.2 LTE Band 4.....	105
8.4.3 LTE Band 2.....	123

1. GENERAL INFORMATION

Applicant Name : Amotech Corp.
Address : 5BL-1LOT, 380, Namdongseo-ro, Namdong-gu, Incheon, South Korea
FCC ID : 2AE6H-ACCM
FCC Classification : PCS Licensed Transmitter (PCB)
EUT Type : ACCESS & CONNECTED CAR MODULE
Model Name : ACCM200-US4G-1A
Add Model Name : ACCM100-US4G-00, ACCM200-US4G-1B
Supplying power : DC 12 V
Antenna Information : Internal Antenna

Mode	TX Frequency (MHz)	Emission Designator	Modulation	ERP		EIRP	
				Max power (dBm)	Max power (W)	Max power (dBm)	Max power (W)
LTE Band 12	704 ~ 711	9M02G7D	QPSK	20.08	0.102	-	-
LTE Band 12	704 ~ 711	9M01W7D	16QAM	19.17	0.083	-	-
LTE Band 12	701.5 ~ 713.5	4M50G7D	QPSK	20.35	0.108	-	-
LTE Band 12	701.5 ~ 713.5	4M49W7D	16QAM	19.59	0.091	-	-
LTE Band 12	700.5 ~ 714.5	2M70G7D	QPSK	20.49	0.112	-	-
LTE Band 12	700.5 ~ 714.5	2M71W7D	16QAM	19.84	0.096	-	-
LTE Band 12	699.7 ~ 715.3	1M09G7D	QPSK	20.76	0.119	-	-
LTE Band 12	699.7 ~ 715.3	1M09W7D	16QAM	19.99	0.100	-	-
LTE Band 4	1720 ~ 1745	17M9G7D	QPSK	-	-	25.21	0.332
LTE Band 4	1720 ~ 1745	17M9W7D	16QAM	-	-	24.47	0.280
LTE Band 4	1717.5 ~ 1747.5	13M5G7D	QPSK	-	-	25.07	0.321
LTE Band 4	1717.5 ~ 1747.5	13M4W7D	16QAM	-	-	24.34	0.272
LTE Band 4	1715 ~ 1750	8M94G7D	QPSK	-	-	24.77	0.300
LTE Band 4	1715 ~ 1750	8M95W7D	16QAM	-	-	24.10	0.257
LTE Band 4	1712.5 ~ 1752.5	4M49G7D	QPSK	-	-	24.31	0.270
LTE Band 4	1712.5 ~ 1752.5	4M48W7D	16QAM	-	-	23.40	0.219
LTE Band 4	1711.5 ~ 1753.5	2M71G7D	QPSK	-	-	23.75	0.237
LTE Band 4	1711.5 ~ 1753.5	2M74W7D	16QAM	-	-	23.23	0.210
LTE Band 4	1710.7 ~ 1754.3	1M09G7D	QPSK	-	-	23.83	0.242
LTE Band 4	1710.7 ~ 1754.3	1M09W7D	16QAM	-	-	23.32	0.215
LTE Band 2	1860 ~ 1900	17M9G7D	QPSK	-	-	23.99	0.251
LTE Band 2	1860 ~ 1900	18M0W7D	16QAM	-	-	23.27	0.212
LTE Band 2	1857.5 ~ 1902.5	13M4G7D	QPSK	-	-	23.17	0.207
LTE Band 2	1857.5 ~ 1902.5	13M4W7D	16QAM	-	-	22.59	0.182
LTE Band 2	1855 ~ 1905	8M96G7D	QPSK	-	-	22.80	0.191
LTE Band 2	1855 ~ 1905	8M96W7D	16QAM	-	-	21.96	0.157
LTE Band 2	1852.5 ~ 1907.5	4M49G7D	QPSK	-	-	22.01	0.159
LTE Band 2	1852.5 ~ 1907.5	4M49W7D	16QAM	-	-	21.24	0.133
LTE Band 2	1851.5 ~ 1908.5	2M70G7D	QPSK	-	-	21.96	0.157
LTE Band 2	1851.5 ~ 1908.5	2M70W7D	16QAM	-	-	21.30	0.135
LTE Band 2	1850.7 ~ 1909.3	1M09G7D	QPSK	-	-	21.95	0.157
LTE Band 2	1850.7 ~ 1909.3	1M09W7D	16QAM	-	-	21.07	0.128

2. INTRODUCTION

2.1 EUT DESCRIPTION

The Equipment Under Test (EUT) supports LTE Phone with Bluetooth, Remote control Transmitter.

2.2. EUT CAPABILITIES

This EUT contains the following capabilities:

Multi-band LTE, Bluetooth(LE), Remote control Transmitter.

2.3. TESTING ENVIRONMENT

Ambient Condition	
• Temperature	+21 °C ~ +25 °C
• Relative Humidity	41 % ~ 45 %

2.4 MEASURING INSTRUMENT CALIBRATION

The measuring equipment, which was utilized in performing the tests documented herein, has been calibrated in accordance with the manufacturer's recommendations for utilizing calibration equipment, which is traceable to recognized national standards.

2.5. MEASUREMENT UNCERTAINTY

The measurement uncertainties shown below were calculated in accordance with requirements of ANSI C 63.4-2014. All measurement uncertainty values are shown with a coverage factor of $k = 2$ to indicate a 95 % level of confidence.

Parameter	Measurement uncertainty
Radiated Disturbance (Below 1 GHz)	5.1 dB (The confidence level is about 95 %, $k = 2$)
Radiated Disturbance (1 GHz ~ 18 GHz)	5.4 dB (The confidence level is about 95 %, $k = 2$)
Radiated Disturbance (Above 18 GHz)	5.3 dB (The confidence level is about 95 %, $k = 2$)

2.6. TEST FACILITY

DT&C Co., Ltd.		
The 3 m test site and conducted measurement facility used to collect the radiated data are located at the 42, Yurim-ro, 154beon-gil, Cheoin-gu, Yongin-si, Gyeonggi-do, Korea 17042.		
The test site complies with the requirements of § 2.948 according to ANSI 63.4-2014.		
- FCC MRA Accredited Test Firm No. : KR0034		
www.dtnc.net		
Telephone	:	+ 82-31-321-2664
FAX	:	+ 82-31-321-1664

3. DESCRIPTION OF TESTS

3.1 ERP & EIRP (Effective Radiated Power & Equivalent Isotropic Radiated Power)

Test Set-up

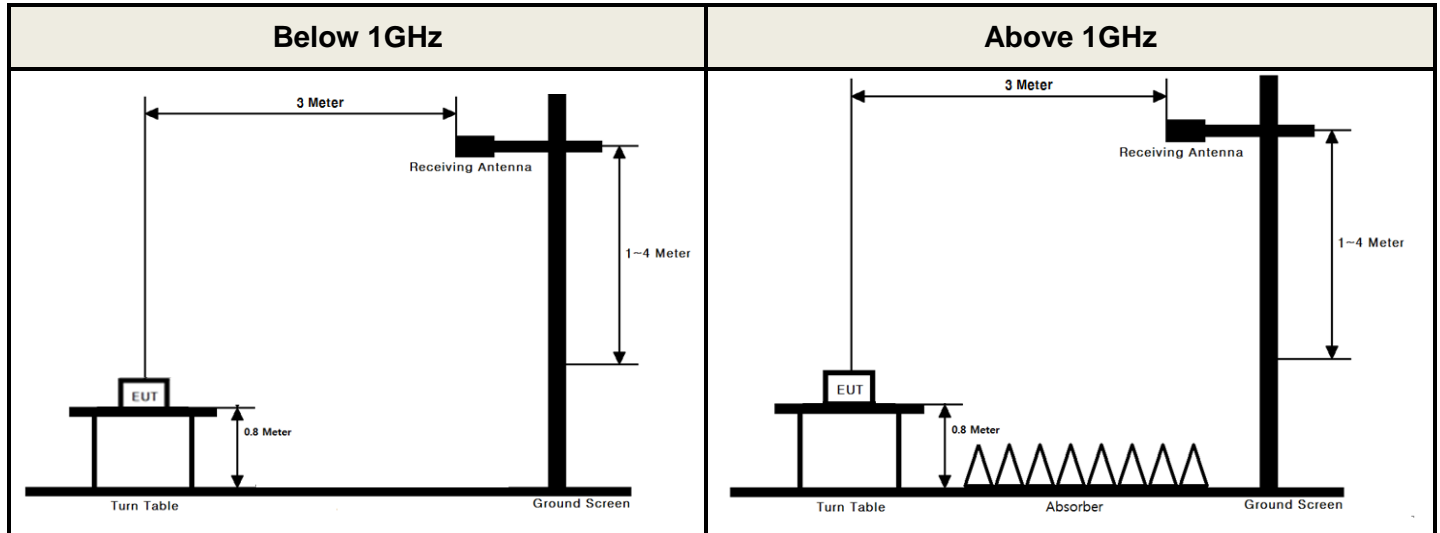

These measurements were performed at 3 m test site. The equipment under test is placed on a non-conductive table 0.8-meters above a turntable which is flush with the ground plane and 3 meters from the receive antenna. For measurements above 1GHz absorbers are placed on the floor between the turn table and the antenna mast in such a way so as to maximize the reduction of reflections. For measurements below 1 GHz, the absorbers are removed.

Test Procedure

- ANSI/TIA-603-E-2016 - Section 2.2.17
- KDB971168 D01v03r01 - Section 5.2.2
- ANSI C63.26-2015 – Section 5.2.4.4.1

Test setting

1. Set span to 2 x to 3 x the OBW.
2. Set RBW = 1% to 5% of the OBW.
3. Set VBW \geq 3 x RBW.
4. Set number of points in sweep \geq 2 x span / RBW.
5. Sweep time:
 - 1) Set = auto-couple, or
 - 2) Set \geq [10 \times (number of points in sweep) \times (transmission period)] for single sweep (automation-compatible) measurement. Transmission period is the on and off time of the transmitter.
6. Detector = power averaging (rms).
7. If the EUT can be configured to transmit continuously, then set the trigger to free run.
8. If the EUT cannot be configured to transmit continuously, then use a sweep trigger with the level set to enable triggering only on full power bursts and configure the EUT to transmit at full power for the entire duration of each sweep. Verify that the sweep time is less than or equal to the transmission burst duration. Time gating can also be used under similar constraints (i.e., configured such that measurement data is collected only during active full-power transmissions).
9. Trace average at least 100 traces in power averaging (rms) mode if sweep is set to auto-couple. To accurately determine the average power over multiple symbols, it can be necessary to increase the number of traces to be averaged above 100 or, if using a manually configured sweep time, increase the sweep time.

10. Compute the power by integrating the spectrum across the OBW of the signal using the instrument's band or channel power measurement function, with the band/channel limits set equal to the OBW band edges. If the instrument does not have a band or channel power function, then sum the spectrum levels (in linear power units) at intervals equal to the RBW extending across the entire OBW of the spectrum.

The receiver antenna height and turntable rotations were adjusted for the highest reading on the receive spectrum analyzer.

A half-wave dipole was substituted in place of the EUT. This dipole antenna was driven by a signal generator and the level of the signal generator was adjusted to obtain the same receive spectrum analyzer reading. The conducted power at the terminal of the substitute antenna is measured.

The ERP/EIRP is calculated using the following formula:

ERP/EIRP = The conducted power at the substitute antenna's terminal [dBm] + Substitute Antenna gain [dBd for ERP , dBi for EIRP]

For readings above 1 GHz, the above procedure is repeated using horn antennas and the difference between the gain of the horn antenna and an isotropic antenna are taken into consideration.

3.2 PEAK TO AVERAGE RATIO

Test set-up

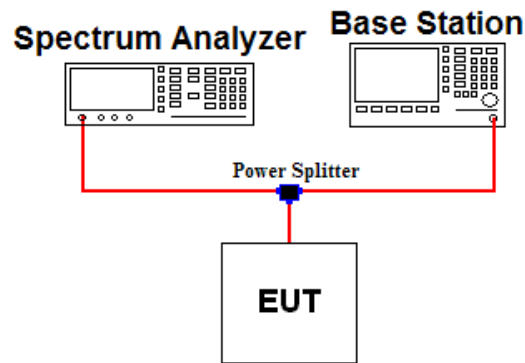

Test Procedure

- KDB971168 D01v03r01 - Section 5.7.2
- ANSI C63.26-2015 – Section 5.2.3.4

A peak to average ratio measurement is performed at the conducted port of the EUT.

The spectrum analyzers Complementary Cumulative Distribution Function (CCDF) measurement profile is used to determine the largest deviation between the average and the peak power of the EUT in a given bandwidth. The CCDF curve shows how much time the peak waveform spends at or above a given average power level. The present of time the signal spends at or above the level defines the probability for that particular power level.

Test setting

The spectrum Analyzer's CCDF measurement function is enabled.

1. Set resolution/measurement bandwidth \geq OBW or specified reference bandwidth.
2. Set the number of counts to a value that stabilizes the measured CCDF curve.
3. Set the measurement interval as follows:
 - 1) For continuous transmissions, set to the greater of $[10 \times (\text{number of points in sweep}) \times (\text{transmission symbol period})]$ or 1 ms.
 - 2) For burst transmissions, employ an external trigger that is synchronized with the EUT burst timing sequence, or use the internal burst trigger with a trigger level that allows the burst to stabilize. Set the measurement interval to a time that is less than or equal to the burst duration.
 - 3) If there are several carriers in a single antenna port, the peak power shall be determined for each individual carrier (by disabling the other carriers while measuring the required carrier) and the total peak power calculated from the sum of the individual carrier peak powers.
4. Record the maximum PAPR level associated with a probability of 0.1%.
5. The peak power level is calculated from the sum of the PAPR value from step d) to the measured average power.

3.3 OCCUPIED BANDWIDTH.

Test set-up

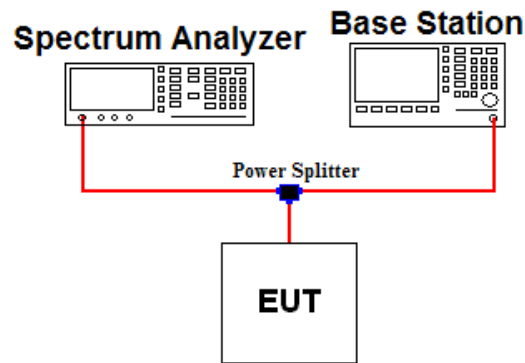

Test Procedure

- KDB971168 D01v03r01 - Section 4.3
- ANSI C63.26-2015 – Section 5.4.4

The occupied bandwidth, that is the frequency bandwidth such that, below its lower and above its upper frequency limits, the mean powers radiated are each equal to 0.5 percent of the total mean power of a given emission.

Test setting

1. The signal analyzer's automatic bandwidth measurement capability was used to perform the 99 % occupied bandwidth and the 26 dB bandwidth. The bandwidth measurement was not influenced by any intermediate power nulls in the fundamental emission.
2. $RBW = 1 \sim 5 \%$ of the expected OBW & $VBW \geq 3 \times RBW$
3. Detector = Peak
4. Trance mode = Max hold
5. Sweep = Auto couple
6. The trace was allowed to stabilize
7. If necessary, step 2 ~ 6 were repeated after changing the RBW such that it would be within 1 ~ 5 % of the 99 % occupied bandwidth observed in step 6.

3.4 BAND EDGE EMISSIONS AT ANTENNA TERMINAL

Test set-up

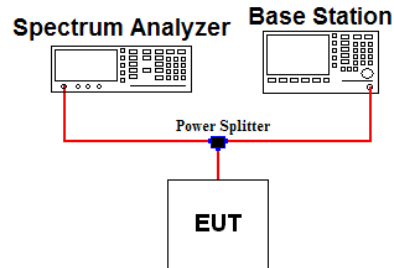

Test Procedure

- KDB971168 D01v03r01 - Section 6
- ANSI C63.26-2015 – Section 5.7

All out of band emissions are measured by means of a calibrated spectrum analyzer. The EUT was setup to maximum output power at its lowest and highest channel with all bandwidths, modulations and RB configurations.

The power of any spurious emission shall be attenuated below the transmitter power (P) by at least $43 + 10 \log(P)$ dB.

Test setting

1. Start and stop frequency were set such that the band edge would be placed in the center of the plot
2. Span was set large enough so as to capture all out of band emissions near the band edge
3. RBW $\geq 1\%$ of the emission bandwidth
4. VBW $\geq 3 \times$ RBW
5. Detector = RMS & Trace mode = Max hold
6. Sweep time = Auto couple or 1 s for band edge
7. Number of sweep point $\geq 2 \times$ span / RBW
8. The trace was allowed to stabilize

Note 1: Per Part 24.238(b) / 27.53(h) in the 1 MHz bands immediately outside and adjacent to the frequency block a resolution bandwidth of at least one percent of the emission bandwidth of the fundamental emission of the transmitter may be employed to demonstrate compliance with the out-of-band emissions limit.

The emission bandwidth is defined as the width of the signal between two points, one below the carrier center frequency and one above the carrier center frequency, outside of which all emission are attenuated at least 26 dB below the transmitter power.

Note 2: Per Part 53(g) for operations in the 600 MHz band and the 698-746 MHz band, compliance with this provision is based on the use of measurement instrumentation employing a resolution bandwidth of 100 kilohertz or greater. However, in the 100 kilohertz bands immediately outside and adjacent to a licensee's frequency block, a resolution bandwidth of at least 30 kHz may be employed.

3.5 SPURIOUS AND HARMONIC EMISSIONS AT ANTENNA TERMINAL

Test set-up

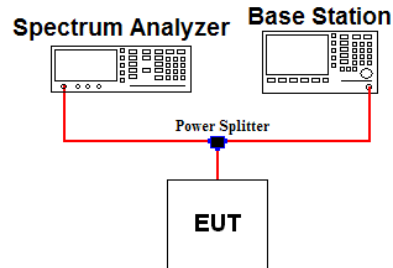

Test Procedure

- KDB971168 D01v03r01 - Section 6
- ANSI C63.26-2015 – Section 5.7

The level of the carrier and the various conducted spurious and harmonic frequencies is measured by means of a calibrated spectrum analyzer. The EUT was setup to maximum output power at its low, middle, high channel with all bandwidths, modulations and RB configurations. The spectrum is scanned from 9 kHz up to a frequency including its 10th harmonic.

The power of any spurious emission shall be attenuated below the transmitter power (P) by at least $43 + 10 \log(P)$ dB.

Test setting

1. RBW = 100 kHz(Below 1 GHz) or 1 MHz(Above 1 GHz) & VBW $\geq 3 \times$ RBW (Refer to Note 1)
2. Detector = RMS & Trace mode = Max hold
3. Sweep time = Auto couple
4. Number of sweep point $\geq 2 \times$ span / RBW
5. The trace was allowed to stabilize

Note 1: Compliance with these provisions is based on the use of measurement instrumentation employing a resolution bandwidth of 100 kHz or greater for frequencies less than 1GHz and 1MHz or greater for frequencies greater than 1GHz.

3.6 UNDESIRABLE EMISSIONS

Test Set-up

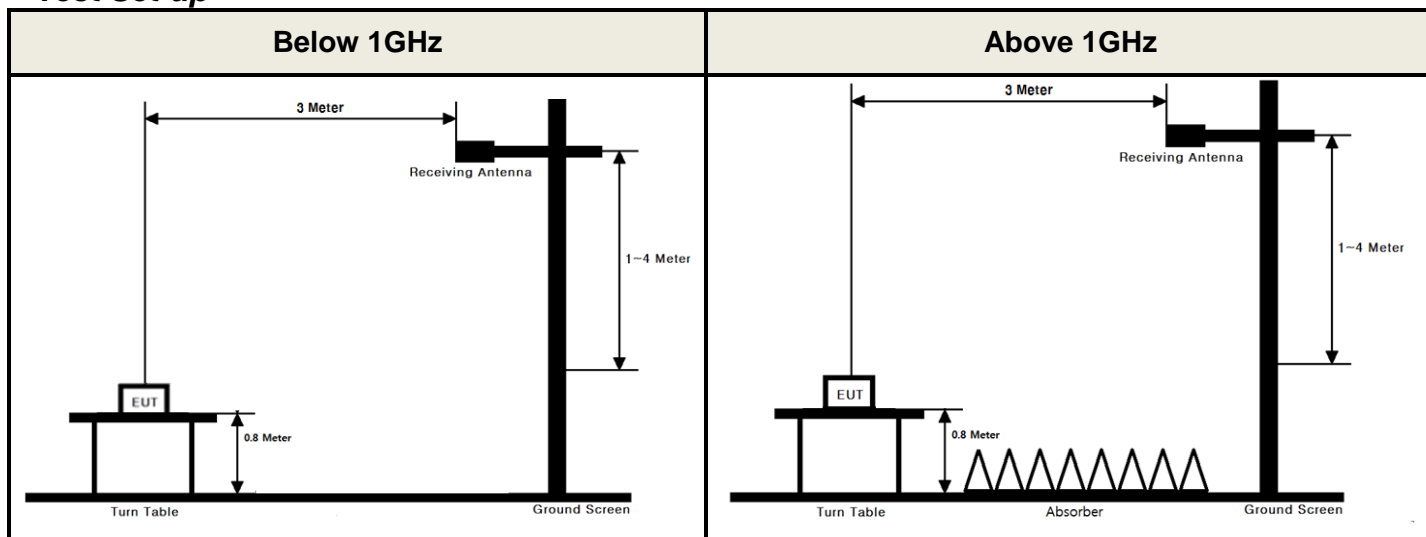

These measurements were performed at 3 test site. The equipment under test is placed on a non-conductive table 0.8-meters above a turntable which is flush with the ground plane and 3 meters from the receive antenna. For measurements above 1 GHz absorbers are placed on the floor between the turn table and the antenna mast in such a way so as to maximize the reduction of reflections. For measurements below 1 GHz, the absorbers are removed.

Test Procedure

- ANSI/TIA-603-E-2016 - Section 2.2.12
- KDB971168 D01v03r01 - Section 5.8
- ANSI C63.26-2015 – Section 5.5

Test setting

1. RBW = 100 kHz for below 1 GHz and 1 MHz for above 1 GHz / VBW \geq 3 X RBW
2. Detector = RMS & Trace mode = Max hold
3. Sweep time = Auto couple
4. Number of sweep point \geq 2 X span / RBW
5. The trace was allowed to stabilize

The receive antenna height and turntable rotations were adjusted for the highest reading on the receive spectrum analyzer.

For radiated power measurements below 1 GHz, a half-wave dipole was substituted in place of the EUT. This dipole antenna was driven by a signal generator and the level of the signal generator was adjusted to obtain the same spectrum analyzer reading.

For radiated power measurements above 1 GHz, a Horn antenna was substituted in place of the EUT. This Horn antenna was driven by a signal generator and the level of the signal generator was adjusted to obtain the same spectrum analyzer reading. The difference between the gain of the horn and an isotropic antenna are taken into consideration.

This measurement was performed with the EUT oriented in 3 orthogonal axis.

4. LIST OF TEST EQUIPMENT

Type	Manufacturer	Model	Cal.Date (yy/mm/dd)	Next.Cal. Date (yy/mm/dd)	S/N
Spectrum Analyzer	Agilent Technologies	N9020A	18/07/09	19/07/09	MY46471251
Spectrum Analyzer	Agilent Technologies	N9020A	18/12/19	19/12/19	MY49060056
DC Power Supply	SMtechno	SDP30-5D	18/07/03	19/07/03	305DNF079
DC power supply	Agilent Technologies	66332A	18/07/02	19/07/02	MY43000440
Multimeter	FLUKE	17B	18/12/18	19/12/18	26030065WS
Power Splitter	Anritsu	K241B	18/12/19	19/12/19	016681
Temp & Humi	SJ Science	SJ-TH-S50	18/07/06	19/07/06	U5542113
Radio Communication Analyzer	Anritsu	MT8820C	18/07/03	19/07/03	6200978101
Thermohygrometer	BODYCOM	BJ5478	18/12/27	19/12/27	120612-2
Thermohygrometer	BODYCOM	BJ5478	18/12/27	19/12/27	120612-1
Signal Generator	Rohde Schwarz	SMBV100A	18/12/19	19/12/19	255571
Signal Generator	ANRITSU	SMF100A	18/06/07	19/06/07	102341
Loop Antenna	Schwarzbeck	FMZB1513	18/01/30	20/01/30	1513-128
Bilog Antenna	Schwarzbeck	VULB 9160	18/07/13	20/07/13	3359
Dipole Antenna	Schwarzbeck	VHA9103	18/04/13	20/04/13	2117
Dipole Antenna	Schwarzbeck	UHA9105	18/04/13	20/04/13	2262
HORN ANT	ETS	3117	18/05/10	20/05/10	00140394
HORN ANT	A.H.Systems	SAS-574	17/07/31	19/07/31	155
PreAmplifier	H.P	8447D	18/12/18	19/12/18	2944A07774
PreAmplifier	Agilent Technologies	8449B	18/07/05	19/07/05	3008A02108
High-pass filter	Wainwright	WHKX12-935-1000-15000-40SS	18/07/05	19/07/05	7
High-pass filter	Wainwright	WHKX12-2580-3000-18000-80SS	18/07/05	19/07/05	3
High-pass filter	Wainwright	WHNX8.5/26.5G-6SS	18/07/03	19/07/03	1
Cable	DTNC	Cable	18/07/06	19/07/06	M-01
Cable	DTNC	Cable	18/07/06	19/07/06	M-02
Cable	Junkosha	MWX315	18/11/19	19/11/19	M-05
Cable	Junkosha	MWX221	18/11/19	19/11/19	M-06
Cable	DTNC	Cable	18/07/05	19/07/05	RF-73
Cable	DTNC	Cable	18/07/05	19/07/05	RF-84

Note1: The measurement antennas were calibrated in accordance to the requirements of ANSI C63.5-2017.

Note2: The cable is not a regular calibration item, so it has been calibrated by DT & C itself.

5. SUMMARY OF TEST RESULTS

FCC Part Section(s)	Test Description	Test Limit	Test Condition	Status Note 1
2.1046	Conducted Output Power	N/A	Conducted	C
2.1049	Occupied Bandwidth	N/A		C
24.232(d) 27.50(d.5)	Peak to Average Ratio	< 13 dB		C
2.1051 24.238(a) 27.53(g) 27.53(h)	Band Edge / Conducted Spurious Emissions	> 43 + 10log ₁₀ (P) dB at Band edge and for all out-of-band emissions		C
2.1055 24.235 27.54	Frequency Stability	Fundamental emissions must stay within Authorized frequency block (Part 24, 27)		C
27.50(c.10)	Radiated Output Power (B12)	< 3 Watts max. ERP	Radiated	C
27.50(d.4)	Radiated Output Power (B4)	< 1 Watts max. EIRP		C
24.232(c)	Radiated Output Power(B2)	< 2 Watts max. EIRP		C
2.1053 24.238(a) 27.53(g) 27.53(h)	Undesirable Emissions	> 43 + 10log ₁₀ (P) dB for all out-of-band emissions		C
Note 1: C =Comply NC =Not Comply NT =Not Tested NA =Not Applicable Note 2: This test item was performed in each axis and the worst case data was reported.				

6. SAMPLE CALCULATION

A. Emission Designator

LTE Band 12 (QPSK)

Emission Designator = **9M02G7D**

LTE OBW = 9.023 MHz

G = Phase Modulation

7 = Quantized/Digital Info

D = Data Transmission

LTE Band 4(QPSK)

Emission Designator = **17M9G7D**

LTE OBW = 17.881 MHz

G = Phase Modulation

7 = Quantized/Digital Info

D = Data Transmission

LTE Band 2(QPSK)

Emission Designator = **17M9G7D**

LTE OBW = 17.931 MHz

G = Phase Modulation

7 = Quantized/Digital Info

D = Data Transmission

LTE Band 12 (16QAM)

Emission Designator = **9M01W7D**

LTE OBW = 9.013 MHz

W = Amplitude/Angle Modulated

7 = Quantized/Digital Info

D = Data Transmission

LTE Band 4(16QAM)

Emission Designator = **17M9W7D**

LTE OBW = 17.877 MHz

W = Amplitude/Angle Modulated

7 = Quantized/Digital Info

D = Data Transmission

LTE Band 2(16QAM)

Emission Designator = **18M0W7D**

LTE OBW = 17.970 MHz

W = Amplitude/Angle Modulated

7 = Quantized/Digital Info

D = Data Transmission

B. For substitution method

ERP for Band 4

Channel Bandwidth (MHz)	Test Frequency (MHz)	Test Mode	RB Size/ Offset	Spectrum Reading Value(dBm)	EUT Axis	Ant Pol (H/V)	Level(dBm) @ Ant Terminal	TX Ant Gain (dBi)	EIRP (dBm)	EIRP (W)
20	1720	QPSK	1/0	-20.73	Z	H	19.26	5.95	25.21	0.332

ERP or EIRP = Level @ Ant Terminal LEVEL(dBm) + Tx Ant. Gain

- 1) The EUT mounted on a non-conductive turntable is 0.8 meter above test site ground level.
- 2) During the test, the turn table is rotated until the maximum signal is found.
- 3) Record the field strength meter's level.
- 4) Replace the EUT with dipole/Horn antenna that is connected to a calibrated signal generator.
- 5) Increase the signal generator output till the field strength meter's level is equal to the item (3).
- 6) The signal generator output level with substituted antenna gain is the rating of ERP, EIRP or Radiated spurious emission.

7. TEST DATA

7.1 CONDUCTED OUTPUT POWER

A base station simulator was used to establish communication with the EUT. The base station simulator parameters were set to produce the maximum power from the EUT. This device was tested under all configurations and the highest power is reported. Conducted Output Powers of EUT are reported below.

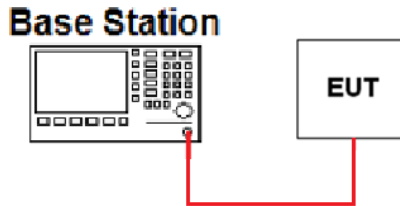

Note 1: The conducted output power was measured using the Anritsu MT8820C.

▪ Band 12

Conducted Power [dBm]									
RB Alloc			1 RB			MID RB			FULL RB
B.W(MHz)	Freq.(MHz)	Modulation	LOW	MID	HIGH	LOW	MID	HIGH	
10	704	QPSK	18.15	18.20	18.27	17.23	17.15	17.21	17.18
		16QAM	17.43	17.50	17.72	16.24	16.12	16.28	16.20
	711	QPSK	18.20	18.08	18.42	17.28	17.30	17.30	17.31
		16QAM	17.58	17.44	17.79	16.42	16.39	16.31	16.37
5	701.5	QPSK	18.07	18.12	18.05	17.15	17.07	17.05	17.19
		16QAM	17.45	17.40	17.40	16.18	16.15	16.12	16.21
	707.5	QPSK	18.12	18.25	18.24	17.31	17.38	17.39	17.27
		16QAM	17.48	17.59	17.59	16.38	16.39	16.49	16.30
	713.5	QPSK	18.03	18.26	18.46	17.14	17.31	17.45	17.38
		16QAM	17.38	17.53	17.84	16.17	16.32	16.48	16.34
3	700.5	QPSK	18.13	18.07	18.12	17.15	17.11	17.11	17.13
		16QAM	17.39	17.36	17.31	16.22	16.14	16.20	16.24
	707.5	QPSK	18.27	18.23	18.24	17.32	17.29	17.30	17.32
		16QAM	17.52	17.59	17.58	16.43	16.37	16.39	16.49
	714.5	QPSK	18.18	18.45	18.45	17.32	17.45	17.48	17.35
		16QAM	17.37	17.70	17.81	16.44	16.52	16.60	16.46
1.4	699.7	QPSK	18.20	18.16	18.17	18.21	18.19	18.18	17.18
		16QAM	17.47	17.52	17.45	17.31	17.25	17.24	16.32
	707.5	QPSK	18.33	18.33	18.25	18.32	18.29	18.32	17.28
		16QAM	17.68	17.67	17.64	17.39	17.46	17.37	16.41
	715.3	QPSK	18.49	18.51	18.49	18.45	18.47	18.49	17.50
		16QAM	17.81	17.86	18.01	17.57	17.62	17.63	16.61

• Band 4

Conducted Power [dBm]									
RB Alloc			1 RB			MID RB			FULL RB
B.W(MHz)	Freq.(MHz)	Modulation	LOW	MID	HIGH	LOW	MID	HIGH	
20	1720	QPSK	21.25	20.58	20.70	20.05	19.70	19.76	19.98
		16QAM	20.57	19.88	20.05	19.08	18.76	18.78	18.90
	1732.5	QPSK	21.27	20.67	20.60	20.10	19.77	19.73	19.97
		16QAM	20.65	20.06	20.27	19.19	18.85	18.80	19.02
	1745	QPSK	21.31	20.60	20.64	20.09	19.76	19.65	19.92
		16QAM	20.65	20.01	19.81	19.10	18.82	18.72	18.93
15	1717.5	QPSK	21.19	20.70	20.81	19.94	19.86	19.83	19.98
		16QAM	20.56	20.06	20.14	18.99	18.84	18.80	18.97
	1732.5	QPSK	21.34	20.74	20.81	20.21	19.86	19.83	20.02
		16QAM	20.74	20.14	20.21	19.19	18.86	18.83	19.01
	1747.5	QPSK	21.37	20.74	20.81	20.05	19.78	19.74	19.95
		16QAM	20.69	20.33	20.03	19.03	18.86	18.93	18.94
10	1715	QPSK	20.96	20.58	20.72	19.80	19.66	19.78	19.72
		16QAM	20.35	20.03	20.09	18.84	18.69	18.82	18.75
	1732.5	QPSK	21.14	20.70	20.74	20.02	19.81	19.73	19.88
		16QAM	20.51	20.07	20.12	19.04	18.82	18.74	18.92
	1750	QPSK	21.04	20.66	20.62	20.06	19.82	20.03	19.78
		16QAM	20.45	20.14	19.95	19.02	18.92	18.85	18.98
5	1712.5	QPSK	20.69	20.53	20.48	19.76	19.62	19.59	19.64
		16QAM	20.07	19.94	19.94	18.86	18.72	18.68	18.69
	1732.5	QPSK	20.85	20.67	20.54	19.88	19.82	19.86	19.88
		16QAM	20.30	20.08	19.97	18.91	18.82	18.75	18.84
	1752.5	QPSK	20.61	20.50	20.42	19.70	19.61	19.56	19.60
		16QAM	20.01	19.89	19.83	18.77	18.65	18.58	18.70
3	1711.5	QPSK	20.67	20.57	20.50	19.70	19.65	19.66	19.69
		16QAM	19.98	19.94	19.89	18.78	18.73	18.75	18.80
	1732.5	QPSK	20.71	20.65	20.52	19.70	19.38	19.27	19.70
		16QAM	20.09	20.09	19.93	18.90	18.87	19.21	19.08
	1753.5	QPSK	20.58	20.54	20.48	19.62	19.61	19.61	19.62
		16QAM	19.93	19.91	19.81	18.72	18.62	18.67	18.71
1.4	1710.7	QPSK	20.70	20.63	20.64	20.70	20.68	20.66	19.73
		16QAM	20.02	20.07	20.03	19.81	19.78	19.77	18.78
	1732.5	QPSK	20.22	20.01	20.02	20.08	20.07	19.55	19.02
		16QAM	19.93	19.88	19.39	19.70	19.74	19.13	18.59
	1754.3	QPSK	20.58	20.58	20.58	20.58	20.58	20.56	19.63
		16QAM	19.98	20.06	19.99	19.77	19.70	19.69	18.71

Band 2

Conducted Power [dBm]									
RB Alloc			1 RB			MID RB			FULL RB
B.W(MHz)	Freq.(MHz)	Modulation	LOW	MID	HIGH	LOW	MID	HIGH	
20	1860	QPSK	20.58	19.70	19.89	19.29	18.88	18.98	19.10
		16QAM	19.95	19.11	19.22	18.42	18.00	18.10	18.18
	1880	QPSK	20.64	19.65	19.69	19.25	18.83	18.82	19.09
		16QAM	19.94	19.00	18.96	18.41	17.96	17.92	18.16
	1900	QPSK	20.31	19.24	19.20	18.90	18.37	18.32	18.64
		16QAM	19.56	18.57	18.48	17.98	17.51	17.46	17.66
15	1857.5	QPSK	20.42	19.88	19.90	19.34	18.97	19.03	19.19
		16QAM	19.86	19.23	19.32	18.37	17.99	18.00	18.16
	1880	QPSK	20.57	19.80	19.80	19.21	18.85	18.83	19.03
		16QAM	19.89	19.12	19.20	18.32	17.99	17.94	18.12
	1902.5	QPSK	20.18	19.35	19.38	18.77	18.45	18.42	18.62
		16QAM	19.54	18.63	18.69	17.86	17.58	17.52	17.71
10	1855	QPSK	20.49	20.04	20.02	19.22	19.28	18.99	19.11
		16QAM	19.61	19.21	19.26	18.22	18.01	17.94	18.14
	1880	QPSK	20.33	19.83	19.83	19.06	18.85	18.87	18.93
		16QAM	19.54	19.17	19.16	18.17	17.95	17.94	18.02
	1905	QPSK	19.77	19.34	19.27	18.60	18.49	18.01	18.32
		16QAM	19.08	18.62	18.56	17.65	17.39	17.35	17.53
5	1852.5	QPSK	20.16	20.06	19.93	19.12	19.07	19.02	19.08
		16QAM	19.32	19.27	19.14	18.11	18.04	18.04	18.07
	1880	QPSK	20.07	19.86	19.85	19.23	19.03	19.00	19.01
		16QAM	19.29	19.11	19.06	18.07	17.91	17.90	17.96
	1907.5	QPSK	19.59	19.42	19.33	18.75	18.60	18.57	18.59
		16QAM	18.70	18.53	18.42	17.47	17.37	17.33	17.36
3	1851.5	QPSK	20.24	20.13	20.11	19.18	19.10	19.10	19.23
		16QAM	19.19	19.17	19.13	18.08	18.01	17.99	18.04
	1880	QPSK	20.21	20.02	19.98	19.09	19.19	19.06	19.05
		16QAM	19.17	19.07	19.04	18.03	17.90	17.91	17.93
	1908.5	QPSK	19.59	19.46	19.36	18.47	18.43	18.40	18.47
		16QAM	18.59	18.50	18.40	17.35	17.31	17.31	17.34
1.4	1850.7	QPSK	20.19	20.13	20.09	20.16	20.12	20.06	19.09
		16QAM	19.27	19.22	19.29	19.02	19.04	19.01	18.04
	1880	QPSK	19.97	19.99	19.91	20.20	20.15	20.11	19.09
		16QAM	19.14	19.17	19.08	18.91	18.87	18.87	17.96
	1909.3	QPSK	19.54	19.47	19.41	19.47	19.44	19.40	18.42
		16QAM	18.56	18.56	18.48	18.30	18.27	18.25	17.35

7.2 OCCUPIED BANDWIDTH

- Plots of the EUT's Occupied Bandwidth are shown in Clause 8.1

7.3 PEAK TO AVERAGE RATIO

- Plots of the EUT's Peak- to- Average Ratio are shown in Clause 8.2

7.4 BAND EDGE EMISSIONS (Conducted)

- Plots of the EUT's Band Edge Emissions are shown in Clause 8.3

7.5 SPURIOUS AND HARMONICS EMISSIONS (Conducted)

- Plots of the EUT's Spurious Emissions are shown in Clause 8.4

7.6 ERP & EIRP

7.6.1 LTE Band 12

Channel Bandwidth (MHz)	Test Frequency (MHz)	Test Mode	RB Size/ Offset	Ant Pol (H/V)	Level(dBm) @ Ant Terminal	TX Ant Gain (dBd)	ERP (dBm)	ERP (W)
10	704	QPSK	1/49	V	18.80	1.28	20.08	0.102
		16QAM	1/49	V	17.89	1.28	19.17	0.083
	711	QPSK	1/49	V	17.92	1.28	19.20	0.083
		16QAM	1/49	V	16.96	1.28	18.24	0.067
5	701.5	QPSK	1/24	V	19.07	1.28	20.35	0.108
		16QAM	1/24	V	18.31	1.28	19.59	0.091
	707.5	QPSK	1/24	V	18.60	1.28	19.88	0.097
		16QAM	1/24	V	17.89	1.28	19.17	0.083
	713.5	QPSK	1/24	V	17.80	1.28	19.08	0.081
		16QAM	1/24	V	17.09	1.28	18.37	0.069
3	700.5	QPSK	1/14	V	19.21	1.28	20.49	0.112
		16QAM	1/14	V	18.56	1.28	19.84	0.096
	707.5	QPSK	1/14	V	18.51	1.28	19.79	0.095
		16QAM	1/14	V	17.80	1.28	19.08	0.081
	714.5	QPSK	1/14	V	17.75	1.28	19.03	0.080
		16QAM	1/14	V	16.79	1.28	18.07	0.064
1.4	699.7	QPSK	1/2	V	19.48	1.28	20.76	0.119
		16QAM	1/2	V	18.71	1.28	19.99	0.100
	707.5	QPSK	1/2	V	18.62	1.28	19.90	0.098
		16QAM	1/2	V	17.96	1.28	19.24	0.084
	715.3	QPSK	1/2	V	17.70	1.28	18.98	0.079
		16QAM	1/2	V	16.92	1.28	18.20	0.066

Note: This device was tested under all bandwidths, modulations and RB configurations and the worst case data are reported in the table above.

7.6.2 LTE Band 4

Channel Bandwidth (MHz)	Test Frequency (MHz)	Test Mode	RB Size/ Offset	Ant Pol (H/V)	Level(dBm) @ Ant Terminal	TX Ant Gain (dBi)	EIRP (dBm)	EIRP (W)
20	1720	QPSK	1/0	H	19.26	5.95	25.21	0.332
		16QAM	1/0	H	18.52	5.95	24.47	0.280
	1732.5	QPSK	1/0	H	18.52	5.84	24.36	0.273
		16QAM	1/0	H	18.04	5.84	23.88	0.244
	1745	QPSK	1/0	H	17.36	5.73	23.09	0.204
		16QAM	1/0	H	16.86	5.73	22.59	0.182
15	1717.5	QPSK	1/0	H	19.10	5.97	25.07	0.321
		16QAM	1/0	H	18.37	5.97	24.34	0.272
	1732.5	QPSK	1/0	H	18.70	5.84	24.54	0.284
		16QAM	1/0	H	18.14	5.84	23.98	0.250
	1747.5	QPSK	1/0	H	17.54	5.70	23.24	0.211
		16QAM	1/0	H	16.71	5.70	22.41	0.174
10	1715	QPSK	1/0	H	18.77	6.00	24.77	0.300
		16QAM	1/0	H	18.10	6.00	24.10	0.257
	1732.5	QPSK	1/0	H	18.59	5.84	24.43	0.277
		16QAM	1/0	H	17.95	5.84	23.79	0.239
	1750	QPSK	1/0	H	17.58	5.68	23.26	0.212
		16QAM	1/0	H	16.77	5.68	22.45	0.176
5	1712.5	QPSK	1/0	H	18.29	6.02	24.31	0.270
		16QAM	1/0	H	17.38	6.02	23.40	0.219
	1732.5	QPSK	1/0	H	18.02	5.84	23.86	0.243
		16QAM	1/0	H	17.27	5.84	23.11	0.205
	1752.5	QPSK	1/0	H	17.38	5.65	23.03	0.201
		16QAM	1/0	H	16.89	5.65	22.54	0.179
3	1711.5	QPSK	1/0	H	17.37	6.03	23.40	0.219
		16QAM	1/0	H	16.73	6.03	22.76	0.189
	1732.5	QPSK	1/0	H	17.91	5.84	23.75	0.237
		16QAM	1/0	H	17.39	5.84	23.23	0.210
	1753.5	QPSK	1/0	H	16.69	5.63	22.32	0.171
		16QAM	1/0	H	16.03	5.63	21.66	0.147
1.4	1710.7	QPSK	1/0	H	17.42	6.03	23.45	0.221
		16QAM	1/0	H	16.66	6.03	22.69	0.186
	1732.5	QPSK	1/0	H	17.99	5.84	23.83	0.242
		16QAM	1/0	H	17.48	5.84	23.32	0.215
	1754.3	QPSK	1/0	H	17.13	5.62	22.75	0.188
		16QAM	1/0	H	16.63	5.62	22.25	0.168

Note: This device was tested under all bandwidths, modulations and RB configurations and the worst case data are reported in the table above.

7.6.3 LTE Band 2

Channel Bandwidth (MHz)	Test Frequency (MHz)	Test Mode	RB Size/Offset	Ant Pol (H/V)	Level(dBm) @ Ant Terminal	TX Ant Gain (dBi)	EIRP (dBm)	EIRP (W)
20	1860	QPSK	1/0	H	17.25	4.91	22.16	0.164
		16QAM	1/0	H	16.34	4.91	21.25	0.133
	1880	QPSK	1/0	H	18.04	4.80	22.84	0.192
		16QAM	1/0	H	17.20	4.80	22.00	0.158
	1900	QPSK	1/0	H	19.30	4.69	23.99	0.251
		16QAM	1/0	H	18.58	4.69	23.27	0.212
15	1857.5	QPSK	1/74	H	17.75	4.92	22.67	0.185
		16QAM	1/74	H	17.04	4.92	21.96	0.157
	1880	QPSK	1/74	H	18.37	4.80	23.17	0.207
		16QAM	1/74	H	17.79	4.80	22.59	0.182
	1902.5	QPSK	1/74	H	16.67	4.68	21.35	0.136
		16QAM	1/74	H	15.88	4.68	20.56	0.114
10	1855	QPSK	1/49	H	17.86	4.94	22.80	0.191
		16QAM	1/49	H	16.89	4.94	21.83	0.152
	1880	QPSK	1/49	H	17.69	4.80	22.49	0.177
		16QAM	1/49	H	17.16	4.80	21.96	0.157
	1905	QPSK	1/49	H	16.44	4.67	21.11	0.129
		16QAM	1/49	H	15.88	4.67	20.55	0.114
5	1852.5	QPSK	1/12	H	16.94	4.95	21.89	0.155
		16QAM	1/12	H	16.19	4.95	21.14	0.130
	1880	QPSK	1/12	H	16.62	4.80	21.42	0.139
		16QAM	1/12	H	15.81	4.80	20.61	0.115
	1907.5	QPSK	1/12	H	17.36	4.65	22.01	0.159
		16QAM	1/12	H	16.59	4.65	21.24	0.133
3	1851.5	QPSK	1/14	H	17.01	4.95	21.96	0.157
		16QAM	1/14	H	16.35	4.95	21.30	0.135
	1880	QPSK	1/14	H	17.01	4.80	21.81	0.152
		16QAM	1/14	H	16.37	4.80	21.17	0.131
	1908.5	QPSK	1/14	H	16.42	4.65	21.07	0.128
		16QAM	1/14	H	15.78	4.65	20.43	0.110
1.4	1850.7	QPSK	1/5	H	16.99	4.96	21.95	0.157
		16QAM	1/5	H	16.11	4.96	21.07	0.128
	1880	QPSK	1/5	H	16.84	4.80	21.64	0.146
		16QAM	1/5	H	16.19	4.80	20.99	0.126
	1909.3	QPSK	1/5	H	16.57	4.64	21.21	0.132
		16QAM	1/5	H	15.70	4.64	20.34	0.108

Note: This device was tested under all bandwidths, modulations and RB configurations and the worst case data are reported in the table above.

7.7 UNDESIRABLE EMISSIONS (Radiated)

7.7.1 LTE Band 12

B.W (MHz)	Test Freq. (MHz)	RB Size/ Offset	Test Mode	Freq.(MHz)	Ant Pol (H/V)	Level(dBm) @ Ant Terminal	TX Ant Gain(dBd)	Result		Limit (dBc)
								(dBm)	(dBc)	
10	704	1/49	QPSK	1416.90	V	-46.89	2.86	-44.03	64.11	33.08
				2125.49	H	-53.30	3.12	-50.18	70.26	
			16QAM	1416.84	V	-46.94	2.86	-44.08	63.25	32.17
				2125.19	H	-53.59	3.12	-50.47	69.64	
	711	1/49	QPSK	1430.97	V	-46.02	3.01	-43.01	62.21	32.20
				2146.44	H	-52.50	3.21	-49.29	68.49	
			16QAM	1430.58	V	-46.68	3.00	-43.68	61.92	31.24
				2146.52	H	-52.59	3.21	-49.38	67.62	
5	701.5	1/24	QPSK	1407.25	V	-52.61	2.76	-49.85	70.20	33.35
				2111.17	H	-55.06	3.06	-52.00	72.35	
			16QAM	1407.21	V	-53.11	2.76	-50.35	69.94	32.59
				2110.93	H	-55.19	3.06	-52.13	71.72	
	707.5	1/24	QPSK	1419.32	V	-49.53	2.89	-46.64	66.52	32.88
				2129.07	H	-54.34	3.13	-51.21	71.09	
			16QAM	1419.13	V	-50.49	2.89	-47.60	66.77	32.17
				2128.55	H	-54.99	3.13	-51.86	71.03	
	713.5	1/24	QPSK	1431.22	V	-47.74	3.01	-44.73	63.81	32.08
				2147.04	H	-54.59	3.21	-51.38	70.46	
			16QAM	1431.50	V	-47.93	3.01	-44.92	63.29	31.37
				2146.18	H	-54.75	3.20	-51.55	69.92	

Note 1: Limit Calculation = $43 + 10\log_{10}(P[\text{Watts}])$

Note 2: This device was tested under all bandwidths, modulations and RB configurations and the worst case data are reported in the table above.

Note 3: The frequency spectrum is examined from 9 kHz to the 10th harmonic of the fundamental frequency of the transmitter. No other spurious and harmonic emissions were reported greater than listed emissions above table.

B.W (MHz)	Test Freq. (MHz)	RB Size/ Offset	Test Mode	Freq.(MHz)	Ant Pol (H/V)	Level(dBm) @ Ant Terminal	TX Ant Gain(dBd)	Result		Limit (dBc)
								(dBm)	(dBc)	
3	700.5	1/14	QPSK	1403.22	V	-53.10	2.72	-50.38	70.87	33.49
				2105.00	H	-53.73	3.03	-50.70	71.19	
			16QAM	1403.56	V	-53.32	2.73	-50.59	70.43	32.84
				2105.38	H	-54.91	3.03	-51.88	71.72	
	707.5	1/14	QPSK	1417.36	V	-48.03	2.87	-45.16	64.95	32.79
				2126.18	H	-53.60	3.12	-50.48	70.27	
			16QAM	1417.68	V	-48.36	2.87	-45.49	64.57	32.08
				2126.18	H	-54.22	3.12	-51.10	70.18	
	714.5	1/14	QPSK	1431.47	V	-47.02	3.01	-44.01	63.04	32.03
				2147.53	H	-54.05	3.21	-50.84	69.87	
			16QAM	1431.39	V	-47.62	3.01	-44.61	62.68	31.07
				2147.41	H	-54.37	3.21	-51.16	69.23	
1.4	699.7	1/2	QPSK	1399.52	V	-50.58	2.69	-47.89	68.65	33.76
				2098.97	H	-54.58	3.01	-51.57	72.33	
			16QAM	1399.19	V	-52.43	2.69	-49.74	69.73	32.99
				2098.20	H	-55.72	3.00	-52.72	72.71	
	707.5	1/2	QPSK	1414.86	V	-46.98	2.84	-44.14	64.04	32.90
				2122.45	H	-53.49	3.10	-50.39	70.29	
			16QAM	1415.10	V	-47.04	2.84	-44.20	63.44	32.24
				2122.11	H	-54.13	3.10	-51.03	70.27	
	715.3	1/2	QPSK	1430.40	V	-47.68	3.00	-44.68	63.66	31.98
				2145.69	H	-53.43	3.20	-50.23	69.21	
			16QAM	1430.44	V	-48.75	3.00	-45.75	63.95	31.20
				2145.33	H	-53.78	3.20	-50.58	68.78	

Note 1: Limit Calculation = $43 + 10\log_{10}(P[\text{Watts}])$

Note 2: This device was tested under all bandwidths, modulations and RB configurations and the worst case data are reported in the table above.

Note 3: The frequency spectrum is examined from 9 kHz to the 10th harmonic of the fundamental frequency of the transmitter. No other spurious and harmonic emissions were reported greater than listed emissions above table.

7.7.2 LTE Band 4

B.W (MHz)	Test Freq. (MHz)	RB Size/ Offset	Test Mode	Freq.(MHz)	Ant Pol (H/V)	Level(dBm) @ Ant Terminal	TX Ant Gain(dBi)	Result		Limit (dBc)
								(dBm)	(dBc)	
20	1720	1/0	QPSK	3422.44	H	-53.36	8.01	-45.35	70.56	38.21
				5133.39	H	-48.31	10.26	-38.05	63.26	
			16QAM	3421.91	H	-53.64	8.01	-45.63	70.10	37.47
				5133.20	H	-48.59	10.26	-38.33	62.80	
	1732.5	1/0	QPSK	3447.07	H	-50.91	8.07	-42.84	67.20	37.36
				5170.79	H	-47.13	10.29	-36.84	61.20	
			16QAM	3447.34	H	-51.34	8.07	-43.27	67.15	36.88
				5170.73	H	-47.27	10.29	-36.98	60.86	
	1745	1/0	QPSK	3472.21	H	-54.74	8.13	-46.61	69.70	36.09
				5208.38	H	-49.95	10.34	-39.61	62.70	
			16QAM	3472.40	H	-54.85	8.13	-46.72	69.31	35.59
				5208.36	H	-50.11	10.34	-39.77	62.36	
15	1717.5	1/0	QPSK	3421.67	H	-53.85	8.01	-45.84	70.91	38.07
				5132.61	H	-47.96	10.26	-37.70	62.77	
			16QAM	3421.53	H	-54.01	8.01	-46.00	70.34	37.34
				5132.48	H	-47.69	10.26	-37.43	61.77	
	1732.5	1/0	QPSK	3452.08	H	-54.78	8.08	-46.70	71.24	37.54
				5177.25	H	-48.11	10.30	-37.81	62.35	
			16QAM	3451.67	H	-55.66	8.08	-47.58	71.56	36.98
				5177.71	H	-48.31	10.30	-38.01	61.99	
	1747.5	1/0	QPSK	3481.73	H	-53.86	8.16	-45.70	68.94	36.24
				5222.77	H	-48.75	10.33	-38.42	61.66	
			16QAM	3481.98	H	-54.46	8.16	-46.30	68.71	35.41
				5222.67	H	-49.01	10.33	-38.68	61.09	
10	1715	1/0	QPSK	3420.99	H	-53.39	8.00	-45.39	70.16	37.77
				5132.02	H	-46.49	10.26	-36.23	61.00	
			16QAM	3421.51	H	-53.58	8.01	-45.57	69.67	37.10
				5132.01	H	-46.68	10.26	-36.42	60.52	
	1732.5	1/0	QPSK	3456.05	H	-54.07	8.09	-45.98	70.41	37.43
				5184.41	H	-49.01	10.32	-38.69	63.12	
			16QAM	3455.57	H	-54.57	8.09	-46.48	70.27	36.79
				5184.22	H	-49.07	10.31	-38.76	62.55	
	1750	1/0	QPSK	3491.23	H	-54.38	8.18	-46.20	69.46	36.26
				5237.21	H	-48.27	10.33	-37.94	61.20	
			16QAM	3491.15	H	-54.95	8.18	-46.77	69.22	35.45
				5236.85	H	-48.28	10.33	-37.95	60.40	

Note 1: Limit Calculation = $43 + 10\log_{10}(P[\text{Watts}])$

Note 2: This device was tested under all bandwidths, modulations and RB configurations and the worst case data are reported in the table above.

Note 3: The frequency spectrum is examined from 9 kHz to the 10th harmonic of the fundamental frequency of the transmitter. No other spurious and harmonic emissions were reported greater than listed emissions above table.

B.W (MHz)	Test Freq. (MHz)	RB Size/ Offset	Test Mode	Freq.(MHz)	Ant Pol (H/V)	Level(dBm) @ Ant Terminal	TX Ant Gain(dBi)	Result		Limit (dBc)
								(dBm)	(dBc)	
5	1712.5	1/0	QPSK	3420.72	H	-53.55	8.00	-45.55	69.86	37.31
				5130.92	H	-46.13	10.26	-35.87	60.18	
			16QAM	3420.67	H	-53.79	8.00	-45.79	69.19	36.40
				5131.08	H	-46.88	10.26	-36.62	60.02	
	1732.5	1/0	QPSK	3460.63	H	-53.51	8.11	-45.40	69.26	36.86
				5191.00	H	-49.63	10.33	-39.30	63.16	
			16QAM	3460.59	H	-54.20	8.11	-46.09	69.20	36.11
				5190.88	H	-49.74	10.33	-39.41	62.52	
	1752.5	1/0	QPSK	3500.73	H	-54.54	8.20	-46.34	69.37	36.03
				5250.78	H	-48.32	10.32	-38.00	61.03	
			16QAM	3500.68	H	-54.72	8.20	-46.52	69.06	35.54
				5251.16	H	-48.47	10.32	-38.15	60.69	
3	1711.5	1/0	QPSK	3420.46	H	-53.05	8.00	-45.05	68.45	36.40
				5130.58	H	-47.09	10.26	-36.83	60.23	
			16QAM	3420.25	H	-54.32	8.00	-46.32	69.08	35.76
				5130.61	H	-47.46	10.26	-37.20	59.96	
	1732.5	1/0	QPSK	3462.49	H	-53.38	8.11	-45.27	69.02	36.75
				5193.57	H	-50.16	10.33	-39.83	63.58	
			16QAM	3462.53	H	-54.15	8.11	-46.04	69.27	36.23
				5193.97	H	-50.59	10.33	-40.26	63.49	
	1753.5	1/0	QPSK	3504.54	H	-53.69	8.21	-45.48	67.80	35.32
				5256.76	H	-49.00	10.32	-38.68	61.00	
			16QAM	3504.06	H	-54.92	8.21	-46.71	68.37	34.66
				5256.87	H	-49.71	10.32	-39.39	61.05	
1.4	1710.7	1/0	QPSK	3420.20	H	-53.02	8.00	-45.02	68.47	36.45
				5131.06	H	-47.08	10.26	-36.82	60.27	
			16QAM	3420.32	H	-53.60	8.00	-45.60	68.29	35.69
				5130.82	H	-46.52	10.26	-36.26	58.95	
	1732.5	1/0	QPSK	3464.04	H	-54.62	8.11	-46.51	70.34	36.83
				5196.13	H	-49.55	10.33	-39.22	63.05	
			16QAM	3464.33	H	-55.07	8.11	-46.96	70.28	36.32
				5195.90	H	-49.62	10.33	-39.29	62.61	
	1754.3	1/0	QPSK	3507.51	H	-54.58	8.22	-46.36	69.11	35.75
				5261.62	H	-49.17	10.32	-38.85	61.60	
			16QAM	3507.86	H	-55.03	8.22	-46.81	69.06	35.25
				5261.60	H	-49.51	10.32	-39.19	61.44	

Note 1: Limit Calculation = $43 + 10\log_{10}(P[\text{Watts}])$

Note 2: This device was tested under all bandwidths, modulations and RB configurations and the worst case data are reported in the table above.

Note 3: The frequency spectrum is examined from 9 kHz to the 10th harmonic of the fundamental frequency of the transmitter. No other spurious and harmonic emissions were reported greater than listed emissions above table.

7.7.3 LTE Band 2

B.W (MHz)	Test Freq. (MHz)	RB Size/Offset	Test Mode	Freq.(MHz)	Ant Pol (H/V)	Level(dBm) @ Ant Terminal	TX Ant Gain(dBi)	Result		Limit (dBc)
								(dBm)	(dBc)	
20	1860	1/0	QPSK	3701.99	H	-51.34	8.38	-42.96	65.12	35.16
				5553.57	H	-51.11	10.42	-40.69	62.85	
			16QAM	3701.85	H	-52.32	8.38	-43.94	65.19	34.25
				5553.31	H	-51.35	10.42	-40.93	62.18	
	1880	1/0	QPSK	3742.21	H	-43.51	8.40	-35.11	57.95	35.84
				5613.22	H	-46.93	10.60	-36.33	59.17	
			16QAM	3742.37	H	-43.69	8.40	-35.29	57.29	35.00
				5613.07	H	-46.98	10.60	-36.38	58.38	
	1900	1/0	QPSK	3782.19	H	-47.90	8.28	-39.62	63.61	36.99
				5673.19	H	-49.37	10.70	-38.67	62.66	
			16QAM	3782.13	H	-48.80	8.28	-40.52	63.79	36.27
				5673.47	H	-49.97	10.70	-39.27	62.54	
15	1857.5	1/74	QPSK	3728.25	H	-52.00	8.39	-43.61	66.28	35.67
				5592.30	H	-48.19	10.55	-37.64	60.31	
			16QAM	3728.19	H	-52.67	8.39	-44.28	66.24	34.96
				5592.59	H	-48.51	10.55	-37.96	59.92	
	1880	1/74	QPSK	3773.17	H	-49.51	8.32	-41.19	64.36	36.17
				5659.98	H	-50.48	10.68	-39.80	62.97	
			16QAM	3773.32	H	-49.85	8.32	-41.53	64.12	35.59
				5659.93	H	-51.16	10.68	-40.48	63.07	
	1902.5	1/74	QPSK	3818.34	H	-48.34	8.22	-40.12	61.47	34.35
				5727.50	H	-48.90	10.72	-38.18	59.53	
			16QAM	3818.21	H	-48.79	8.22	-40.57	61.13	33.56
				5727.35	H	-49.23	10.72	-38.51	59.07	
10	1855	1/49	QPSK	3718.59	H	-52.16	8.39	-43.77	66.57	35.80
				5578.38	H	-49.03	10.51	-38.52	61.32	
			16QAM	3719.02	H	-52.69	8.39	-44.30	66.13	34.83
				5578.11	H	-49.50	10.51	-38.99	60.82	
	1880	1/49	QPSK	3768.80	H	-51.68	8.33	-43.35	65.84	35.49
				5653.06	H	-49.61	10.66	-38.95	61.44	
			16QAM	3768.83	H	-51.95	8.33	-43.62	65.58	34.96
				5653.24	H	-51.09	10.67	-40.42	62.38	
	1905	1/49	QPSK	3818.89	H	-52.29	8.22	-44.07	65.18	34.11
				5728.12	H	-48.55	10.72	-37.83	58.94	
			16QAM	3818.67	H	-52.86	8.22	-44.64	65.19	33.55
				5728.21	H	-49.10	10.72	-38.38	58.93	

Note 1: Limit Calculation = $43 + 10\log_{10}(P[\text{Watts}])$

Note 2: This device was tested under all bandwidths, modulations and RB configurations and the worst case data are reported in the table above.

Note 3: The frequency spectrum is examined from 9 kHz to the 10th harmonic of the fundamental frequency of the transmitter. No other spurious and harmonic emissions were reported greater than listed emissions above table.

B.W (MHz)	Test Freq. (MHz)	RB Size/ Offset	Test Mode	Freq.(MHz)	Ant Pol (H/V)	Level(dBm) @ Ant Terminal	TX Ant Gain(dBi)	Result		Limit (dBc)
								(dBm)	(dBc)	
5	1852.5	1/12	QPSK	3705.02	H	-52.73	8.38	-44.35	66.24	34.89
				5557.41	H	-51.13	10.44	-40.69	62.58	
			16QAM	3704.89	H	-53.23	8.38	-44.85	65.99	34.14
				5557.34	H	-51.92	10.43	-41.49	62.63	
	1880	1/12	QPSK	3760.00	H	-50.14	8.36	-41.78	63.20	34.42
				5640.18	H	-49.43	10.64	-38.79	60.21	
			16QAM	3760.09	H	-50.49	8.36	-42.13	62.74	33.61
				5639.91	H	-50.71	10.64	-40.07	60.68	
	1907.5	1/12	QPSK	3814.96	H	-48.58	8.22	-40.36	62.37	35.01
				5725.85	H	-49.77	10.72	-39.05	61.06	
			16QAM	3814.98	H	-49.44	8.22	-41.22	62.46	34.24
				5725.19	H	-50.27	10.72	-39.55	60.79	
3	1851.5	1/14	QPSK	3705.56	H	-53.37	8.38	-44.99	66.95	34.96
				5558.36	H	-51.49	10.44	-41.05	63.01	
			16QAM	3705.66	H	-53.54	8.38	-45.16	66.46	34.30
				5558.05	H	-52.01	10.44	-41.57	62.87	
	1880	1/14	QPSK	3762.59	H	-49.91	8.35	-41.56	63.37	34.81
				5643.67	H	-49.36	10.65	-38.71	60.52	
			16QAM	3762.81	H	-50.94	8.35	-42.59	63.76	34.17
				5643.62	H	-49.67	10.65	-39.02	60.19	
	1908.5	1/14	QPSK	3819.41	H	-48.51	8.22	-40.29	61.36	34.07
				5729.32	H	-48.10	10.72	-37.38	58.45	
			16QAM	3819.56	H	-48.81	8.22	-40.59	61.02	33.43
				5729.43	H	-49.62	10.72	-38.90	59.33	
1.4	1850.7	1/5	QPSK	3702.65	H	-52.98	8.38	-44.60	66.55	34.95
				5553.40	H	-51.44	10.42	-41.02	62.97	
			16QAM	3702.37	H	-53.75	8.38	-45.37	66.44	34.07
				5553.36	H	-51.87	10.42	-41.45	62.52	
	1880	1/5	QPSK	3760.99	H	-50.54	8.36	-42.18	63.82	34.64
				5641.24	H	-48.73	10.65	-38.08	59.72	
			16QAM	3760.92	H	-51.24	8.36	-42.88	63.87	33.99
				5641.54	H	-50.00	10.65	-39.35	60.34	
	1909.3	1/5	QPSK	3819.44	H	-47.45	8.22	-39.23	60.44	34.21
				5729.24	H	-49.05	10.72	-38.33	59.54	
			16QAM	3819.66	H	-48.12	8.22	-39.90	60.24	33.34
				5729.38	H	-49.98	10.72	-39.26	59.60	

Note 1: Limit Calculation = $43 + 10\log_{10}(P[\text{Watts}])$

Note 2: This device was tested under all bandwidths, modulations and RB configurations and the worst case data are reported in the table above.

Note 3: The frequency spectrum is examined from 9 kHz to the 10th harmonic of the fundamental frequency of the transmitter. No other spurious and harmonic emissions were reported greater than listed emissions above table.

7.8 FREQUENCY STABILITY

7.8.1 LTE Band 12

OPERATING FREQUENCY : 707.5 MHz
 REFERENCE VOLTAGE : 12 VDC
 LIMIT : The frequency stability shall be sufficient to ensure that the fundamental emission stays within the authorized frequency block.

VOLTAGE (%)	POWER (V DC)	TEMP (°C)	FREQUENCY (Hz)	FREQ.Dev (Hz)	Deviation	
					(ppm)	(%)
100%	12.0	+20(Ref)	707,499,996	-4	-0.0057	-0.000000565
100%		-30	707,499,993	-7	-0.0099	-0.000000989
100%		-20	707,499,997	-3	-0.0042	-0.000000424
100%		-10	707,500,001	1	0.0014	0.000000141
100%		0	707,499,997	-3	-0.0042	-0.000000424
100%		+10	707,499,998	-2	-0.0028	-0.000000283
100%		+20	707,499,996	-4	-0.0057	-0.000000565
100%		+30	707,499,999	-1	-0.0014	-0.000000141
100%		+40	707,500,004	4	0.0057	0.000000565
100%		+50	707,500,007	7	0.0099	0.000000989
115%		13.8	+20	707,499,997	-3	-0.0042
85%	10.2	+20	707,500,001	1	0.0014	0.000000141

Based on the results of the frequency stability test at the center channel the frequency deviation results measured are very small. As such it is determined that the channels at the band edge would remain inband when the maximum measured frequency deviation noted during the frequency stability tests is applied. Therefore the device is determined to remain operating in band over the temperature and voltage range as tested.

7.8.2 LTE Band 4

OPERATING FREQUENCY : 1732.5 MHz
 REFERENCE VOLTAGE : 12 VDC
 LIMIT : The frequency stability shall be sufficient to ensure that the fundamental emission stays within the authorized frequency block.

VOLTAGE (%)	POWER (V DC)	TEMP (°C)	FREQUENCY (Hz)	FREQ.Dev (Hz)	Deviation	
					(ppm)	(%)
100%	12.0	+20(Ref)	1,732,499,998	-2	-0.0012	-0.000000115
100%		-30	1,732,499,994	-6	-0.0035	-0.000000346
100%		-20	1,732,499,996	-4	-0.0023	-0.000000231
100%		-10	1,732,499,999	-1	-0.0006	-0.000000058
100%		0	1,732,500,002	2	0.0012	0.000000115
100%		+10	1,732,499,999	-1	-0.0006	-0.000000058
100%		+20	1,732,499,998	-2	-0.0012	-0.000000115
100%		+30	1,732,500,001	1	0.0006	0.000000058
100%		+40	1,732,500,003	3	0.0017	0.000000173
100%		+50	1,732,500,006	6	0.0035	0.000000346
115%	13.8	+20	1,732,499,999	-1	-0.0006	-0.000000058
85%	10.2	+20	1,732,500,003	3	0.0017	0.000000173

Note : Based on the results of the frequency stability test at the center channel the frequency deviation results measured are very small. As such it is determined that the channels at the band edge would remain inband when the maximum measured frequency deviation noted during the frequency stability tests is applied. Therefore the device is determined to remain operating in band over the temperature and voltage range as tested.

7.8.3 LTE Band 2

OPERATING FREQUENCY : 1880 MHz
 REFERENCE VOLTAGE : 12 VDC
 LIMIT : The frequency stability shall be sufficient to ensure that the fundamental emission stays within the authorized frequency block.

VOLTAGE (%)	POWER (V DC)	TEMP (°C)	FREQUENCY (Hz)	FREQ.Dev (Hz)	Deviation	
					(ppm)	(%)
100%	12.0	+20(Ref)	1,879,999,997	-3	-0.0016	-0.000000160
100%		-30	1,879,999,995	-5	-0.0027	-0.000000266
100%		-20	1,879,999,998	-2	-0.0011	-0.000000106
100%		-10	1,879,999,997	-3	-0.0016	-0.000000160
100%		0	1,880,000,001	1	0.0005	0.000000053
100%		+10	1,879,999,996	-4	-0.0021	-0.000000213
100%		+20	1,879,999,997	-3	-0.0016	-0.000000160
100%		+30	1,879,999,998	-2	-0.0011	-0.000000106
100%		+40	1,880,000,001	1	0.0005	0.000000053
100%		+50	1,880,000,003	3	0.0016	0.000000160
115%		13.8	+20	1,879,999,998	-2	-0.0011
85%	10.2	+20	1,880,000,002	2	0.0011	0.000000106

Note : Based on the results of the frequency stability test at the center channel the frequency deviation results measured are very small. As such it is determined that the channels at the band edge would remain inband when the maximum measured frequency deviation noted during the frequency stability tests is applied. Therefore the device is determined to remain operating in band over the temperature and voltage range as tested.

8. TEST PLOTS

Note: All bandwidths, RB configurations, and modulations were investigated.
The worst case test results are reported.

8.1 OCCUPIED BANDWIDTH

8.1.1 LTE Band 12

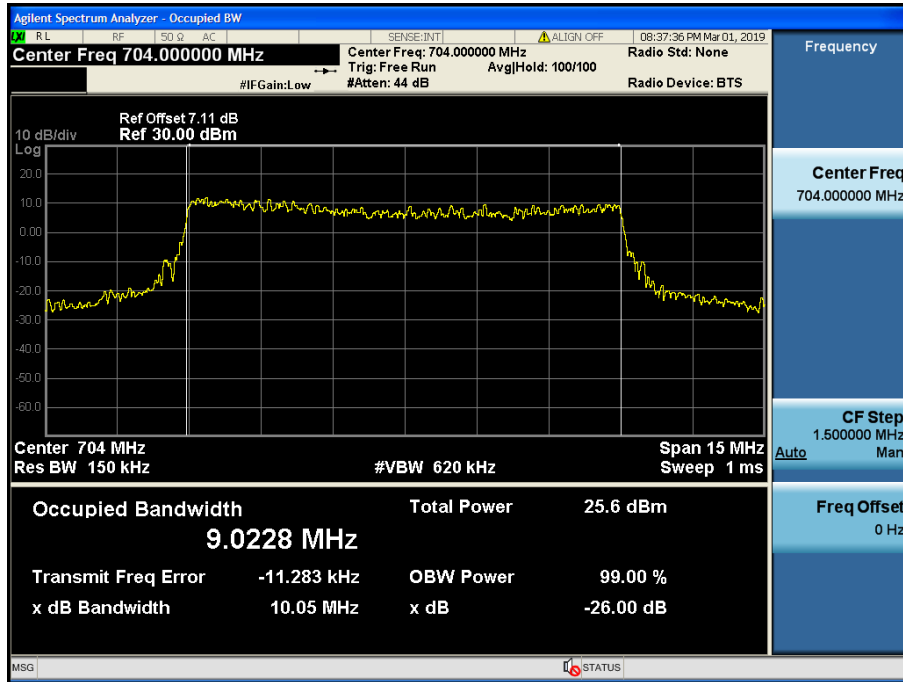

LTE Band 12 / 10 MHz / QPSK - RB Size 50

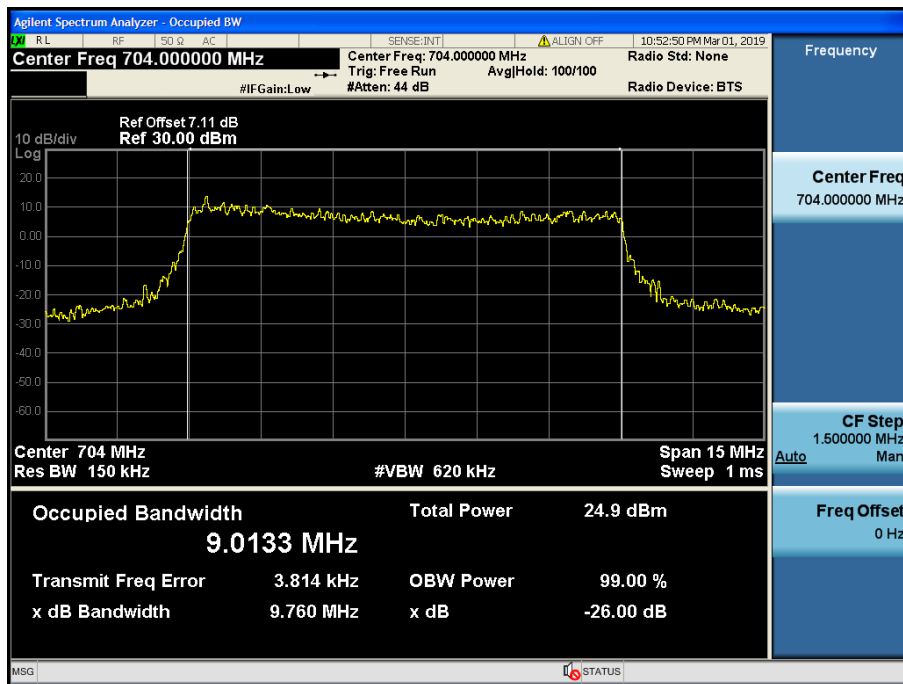

LTE Band 12 / 10 MHz / 16QAM - RB Size 50

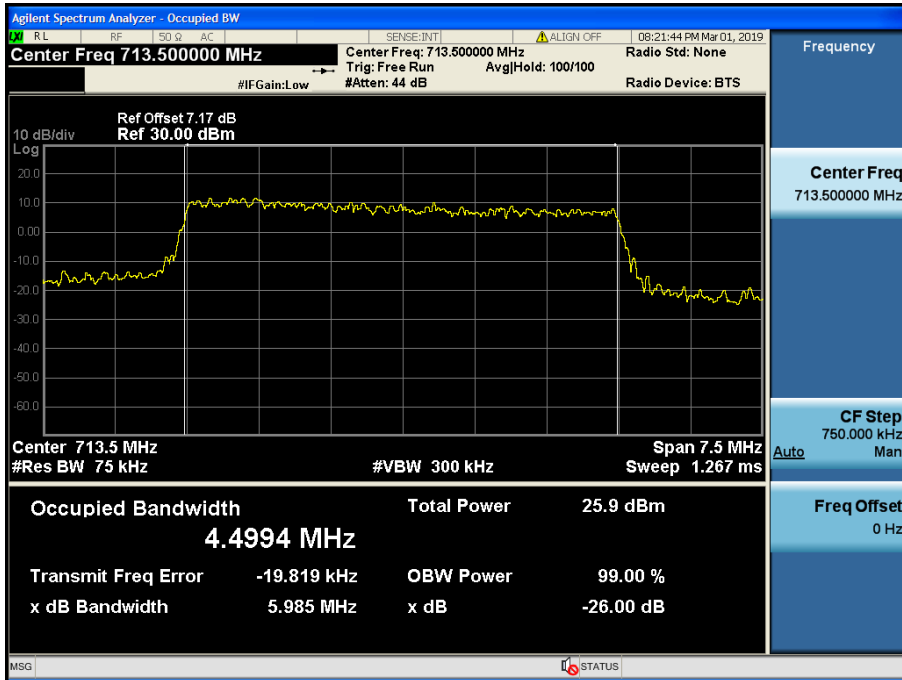

LTE Band 12 / 5 MHz / QPSK - RB Size 25

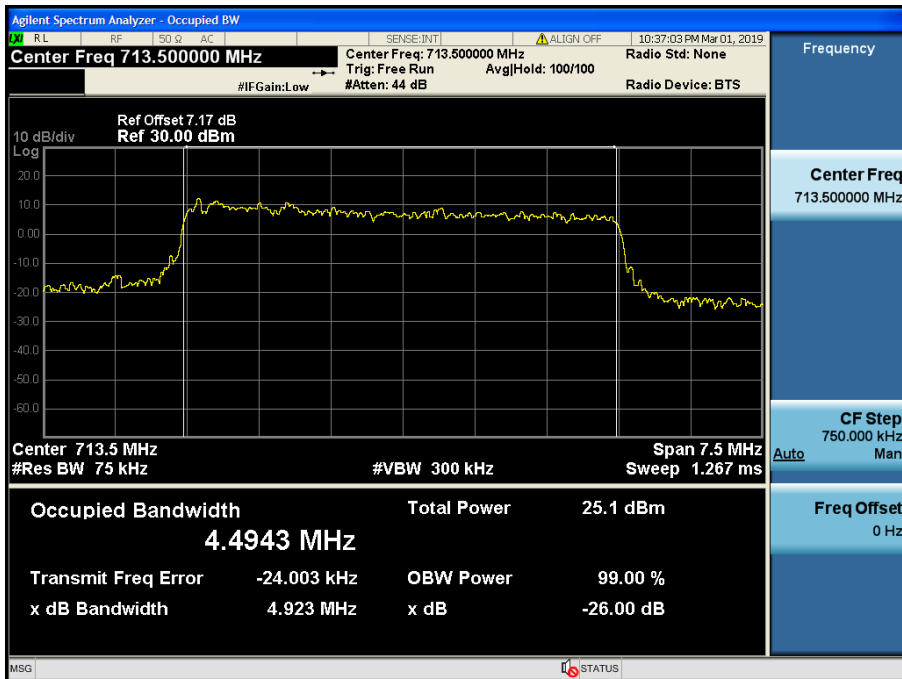

LTE Band 12 / 5 MHz / 16QAM - RB Size 25

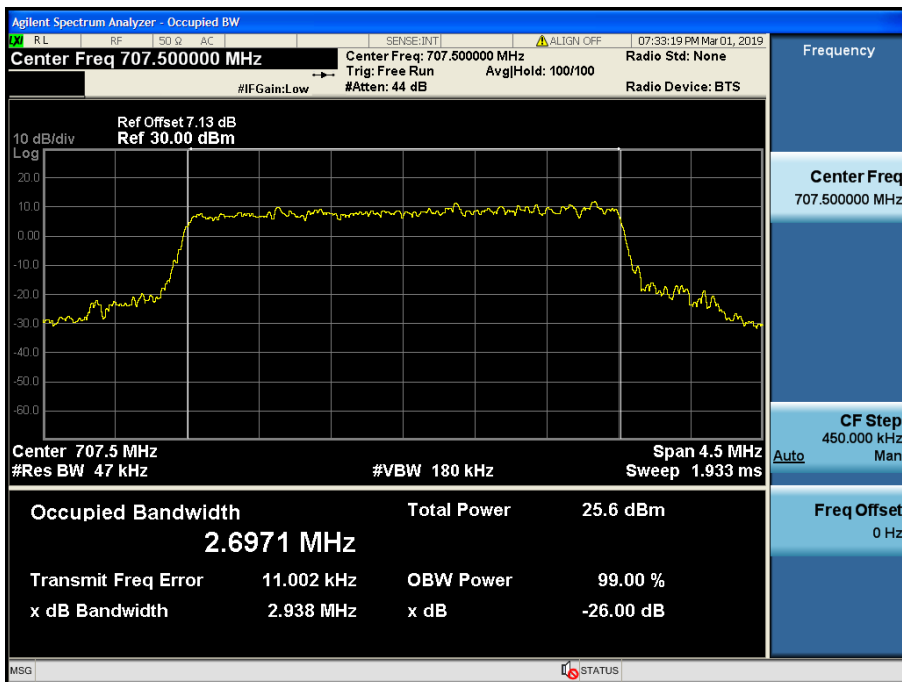

LTE Band 12 / 3 MHz / QPSK - RB Size 15

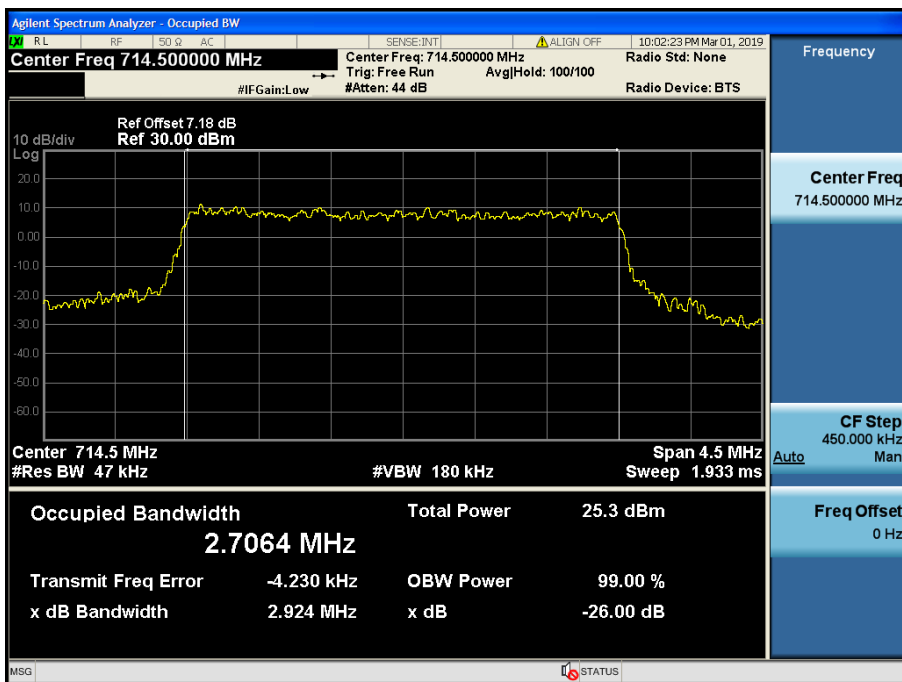

LTE Band 12 / 3 MHz / 16QAM - RB Size 15

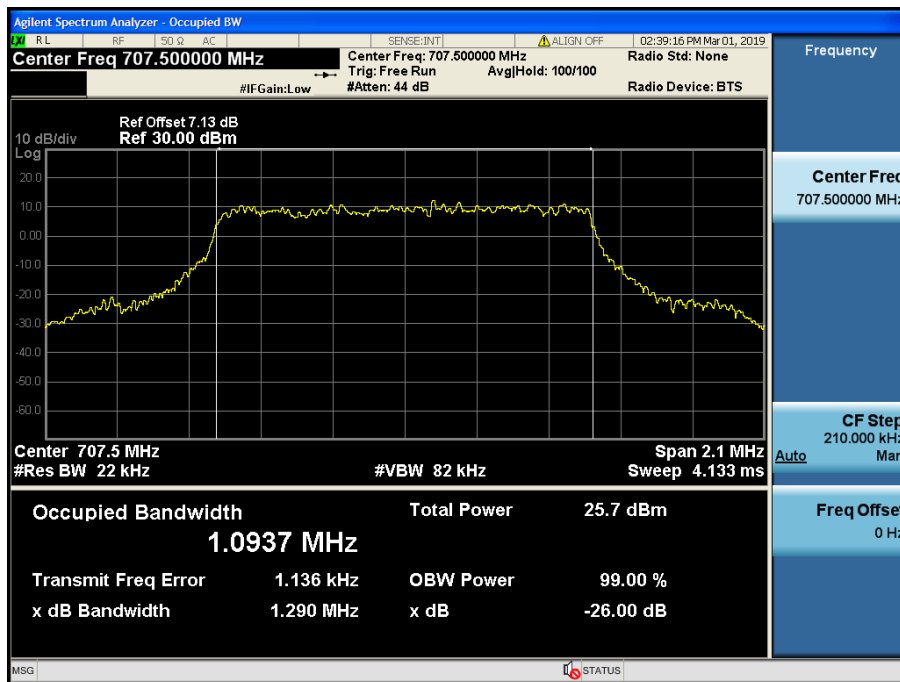

LTE Band 12 / 1.4 MHz / QPSK - RB Size 6

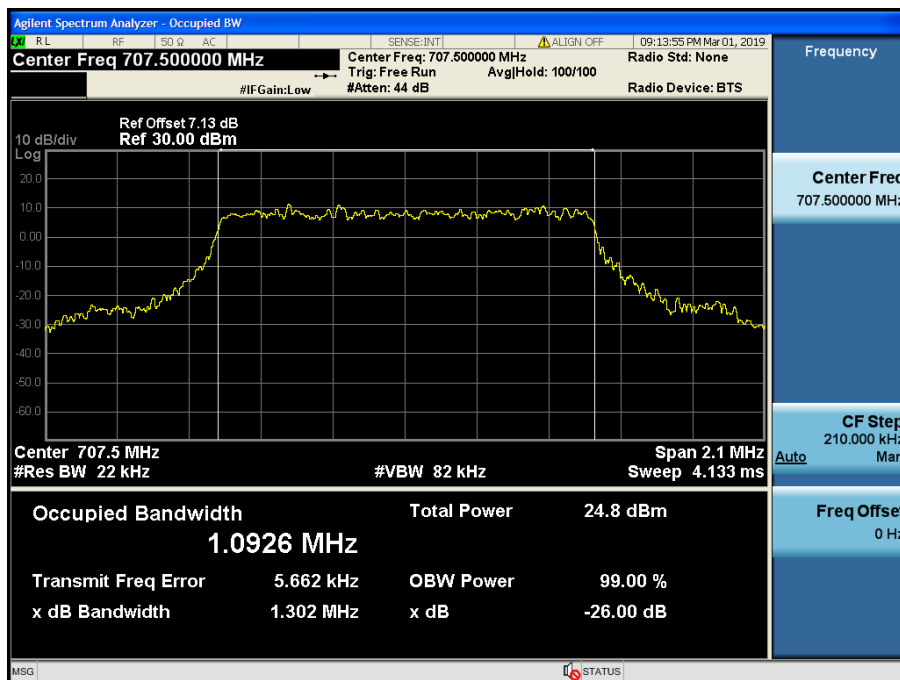

LTE Band 12 / 1.4 MHz / 16QAM - RB Size 6

8.1.2 LTE Band 4

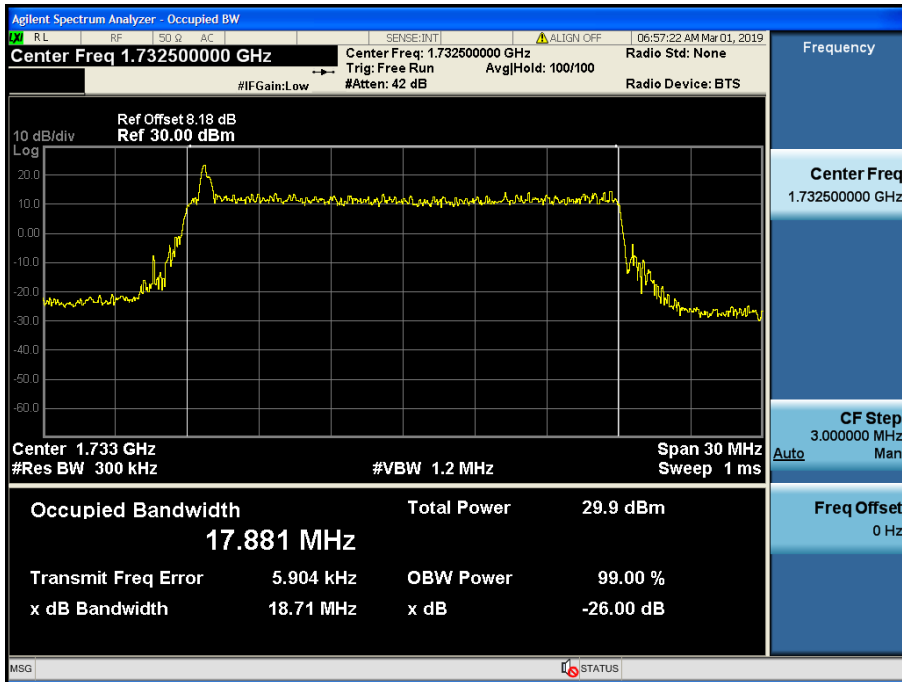

LTE Band 4 / 20 MHz / QPSK - RB Size 100

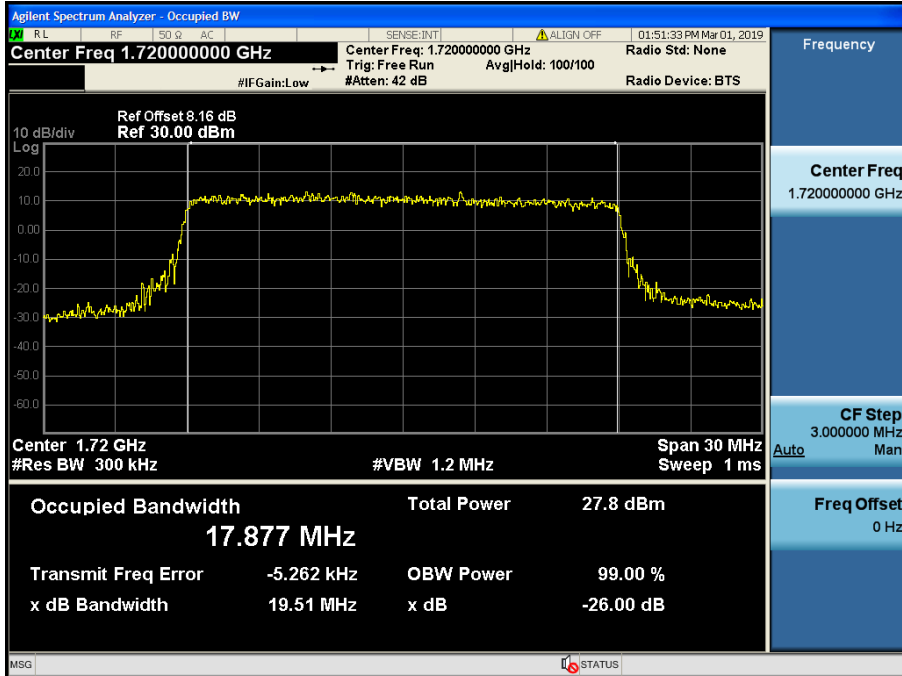

LTE Band 4 / 20 MHz / 16QAM - RB Size 100

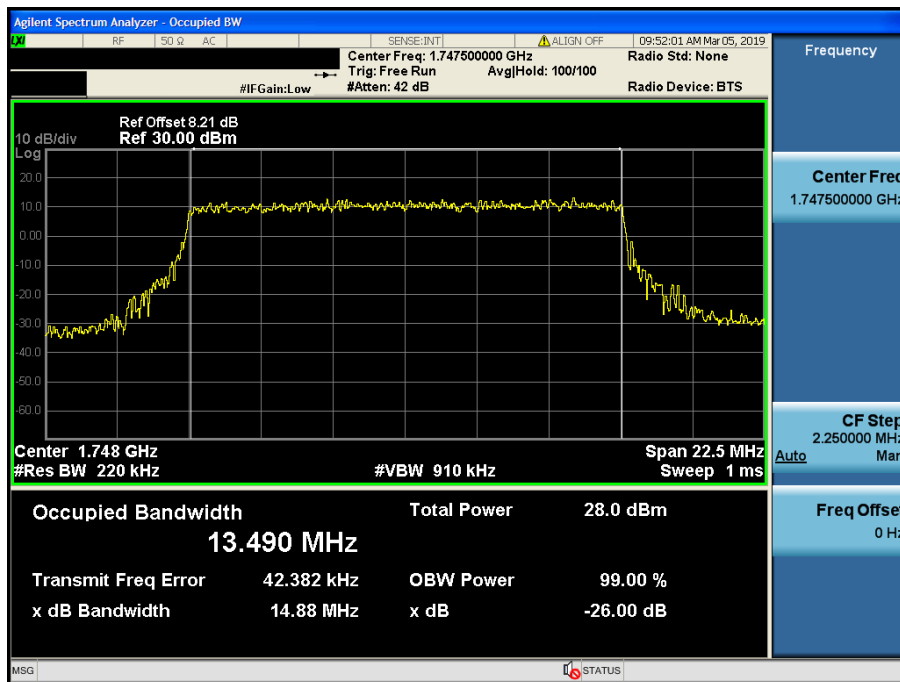

LTE Band 4 / 15 MHz / QPSK - RB Size 75

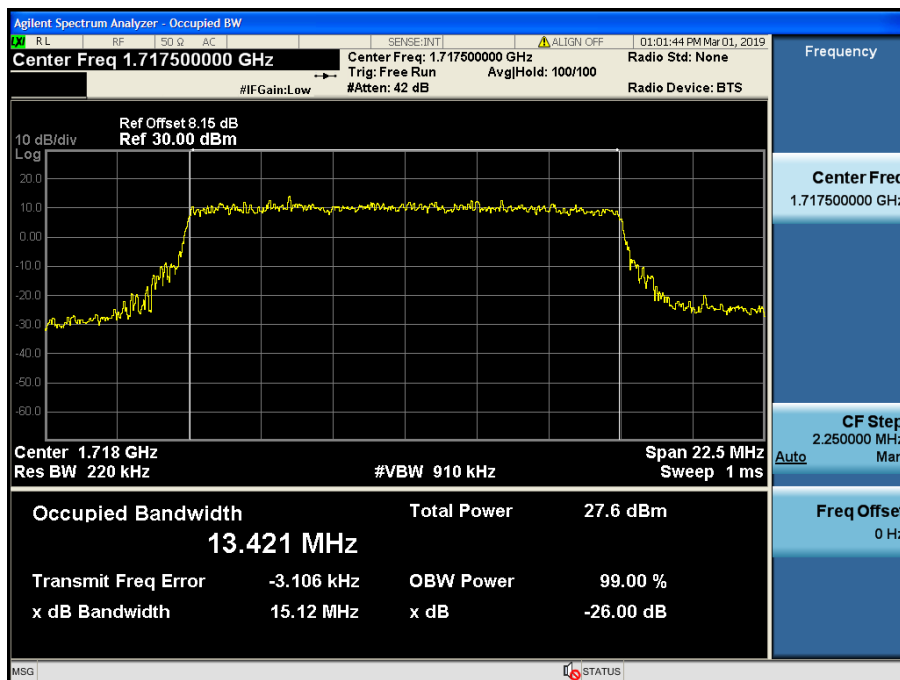

LTE Band 4 / 15 MHz / 16QAM - RB Size 75

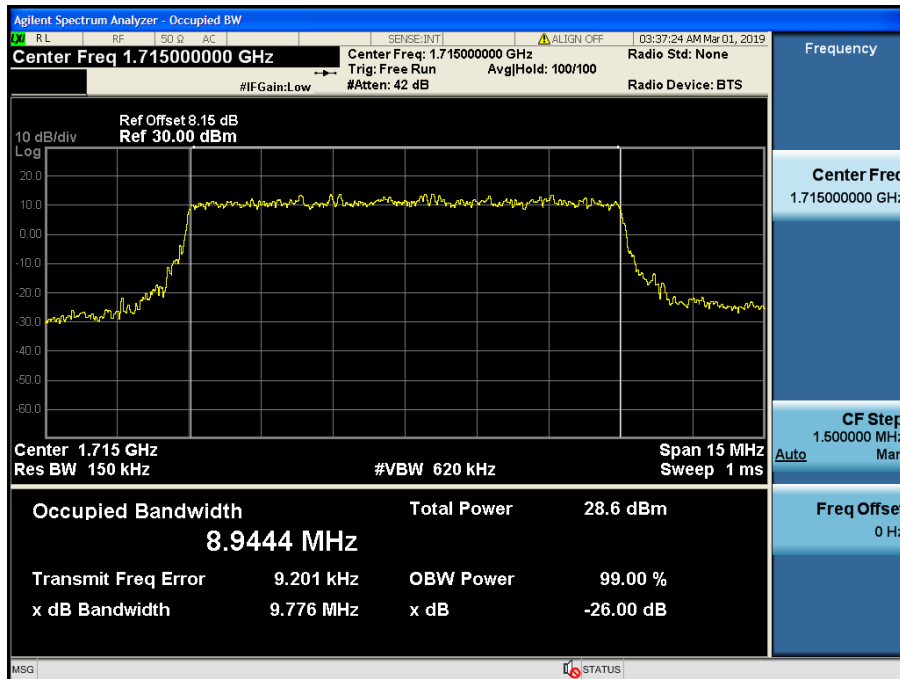

LTE Band 4 / 10 MHz / QPSK - RB Size 50

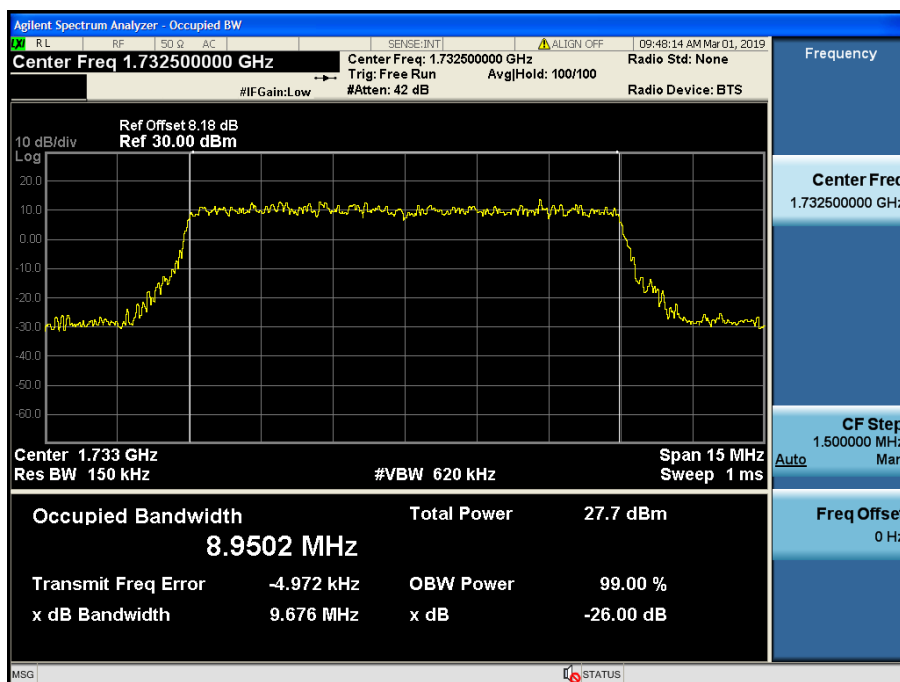

LTE Band 4 / 10 MHz / 16QAM - RB Size 50

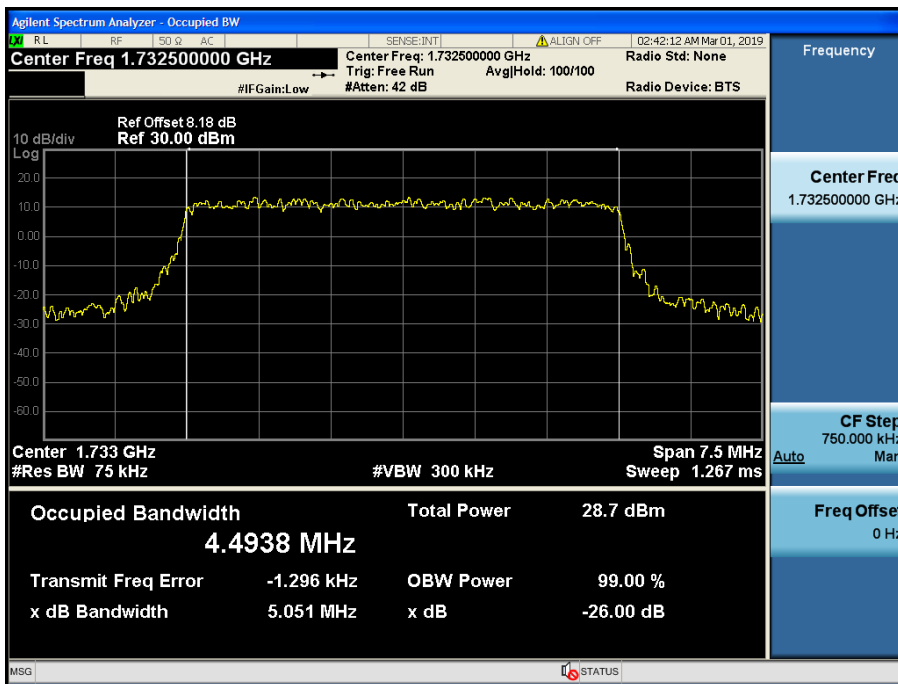

LTE Band 4 / 5 MHz / QPSK - RB Size 25

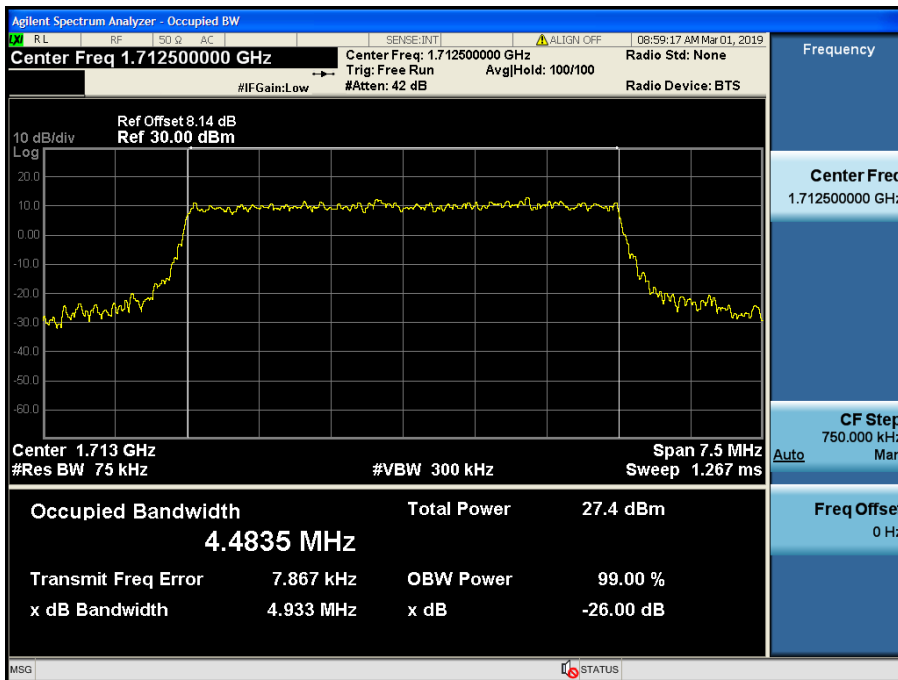

LTE Band 4 / 5 MHz / 16QAM - RB Size 25

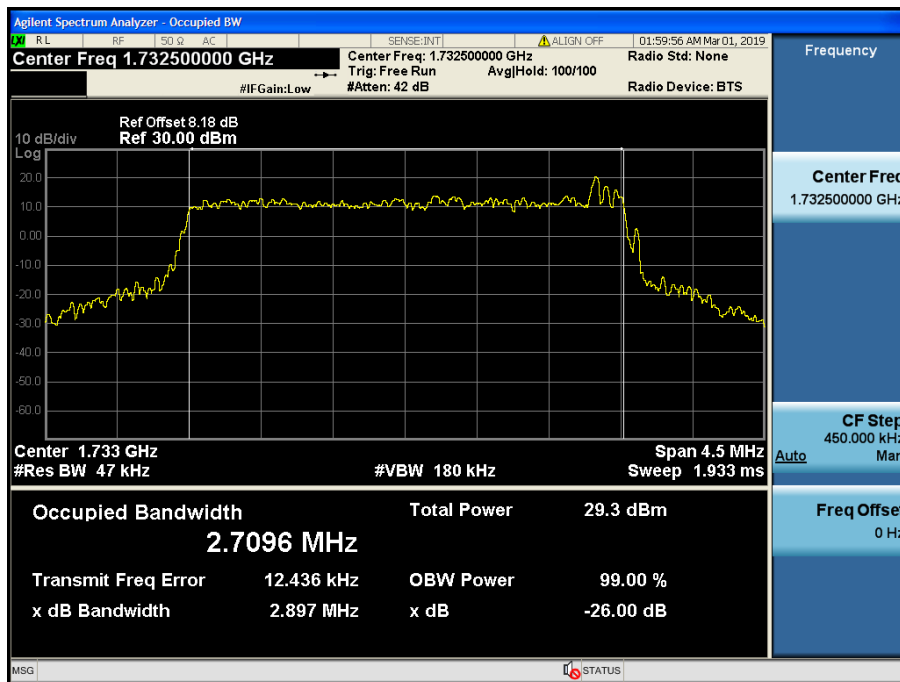

LTE Band 4 / 3 MHz / QPSK - RB Size 15

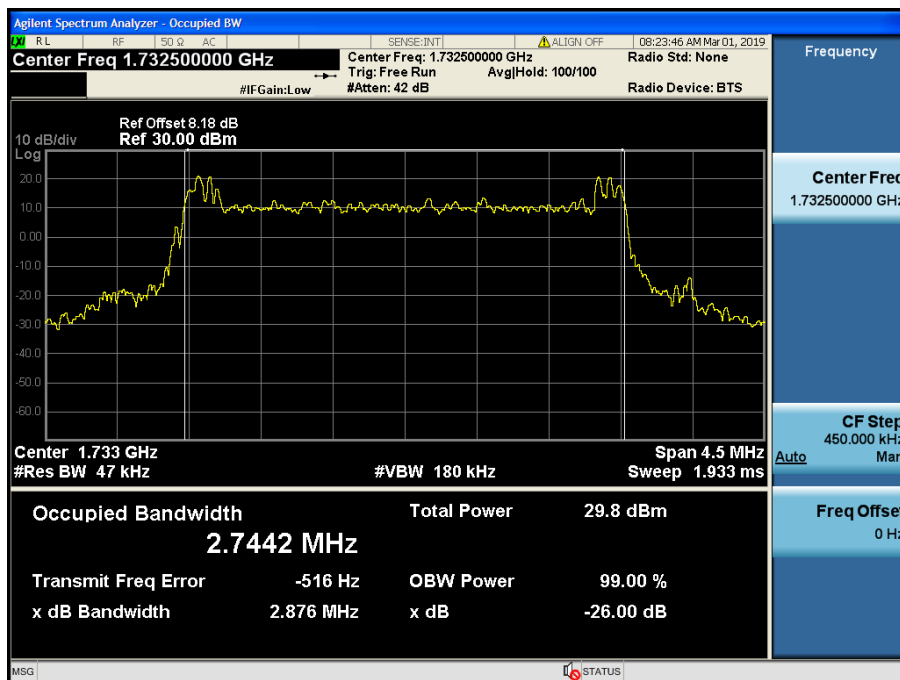

LTE Band 4 / 3 MHz / 16QAM - RB Size 15

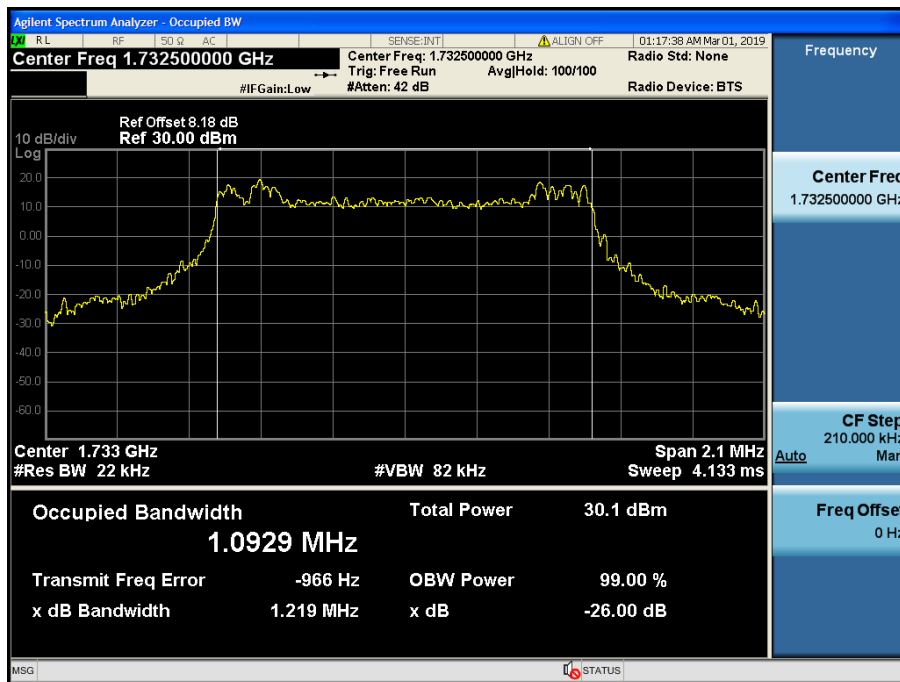

LTE Band 4 / 1.4 MHz / QPSK - RB Size 6

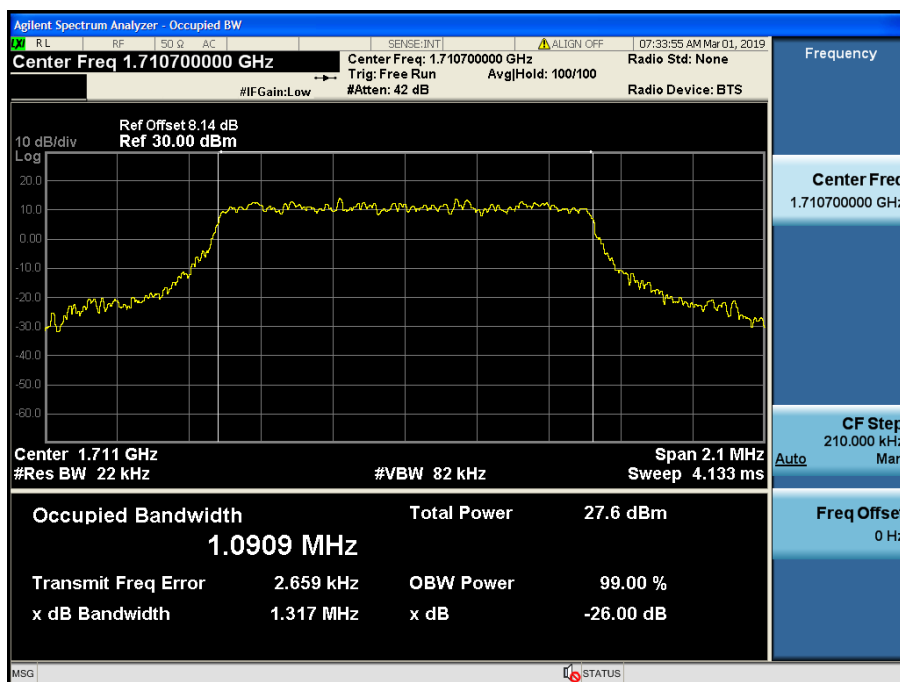

LTE Band 4 / 1.4 MHz / 16QAM - RB Size 6

8.1.3 LTE Band 2

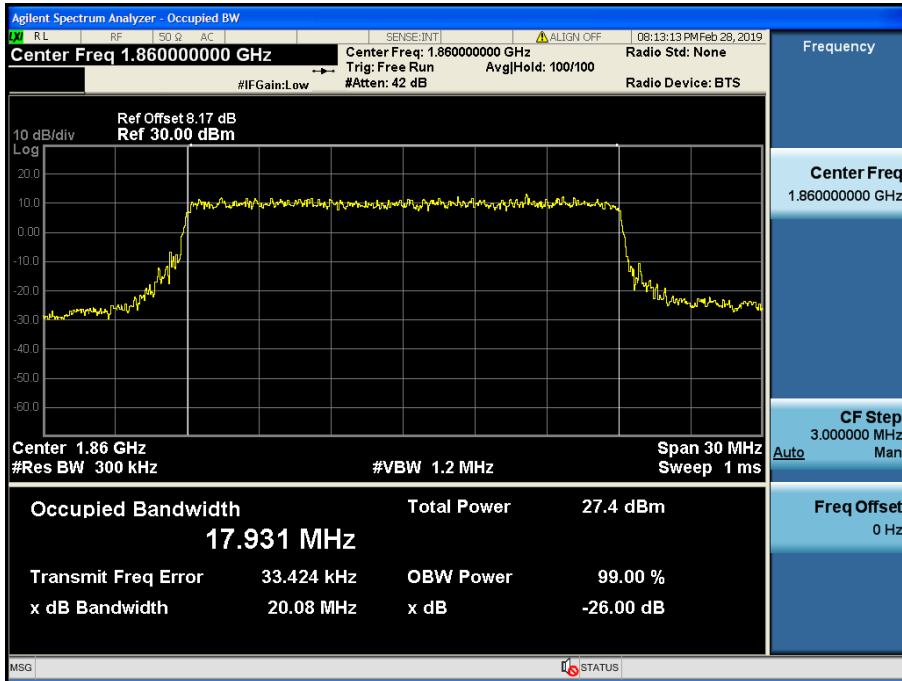

LTE Band 2 / 20 MHz / QPSK - RB Size 100

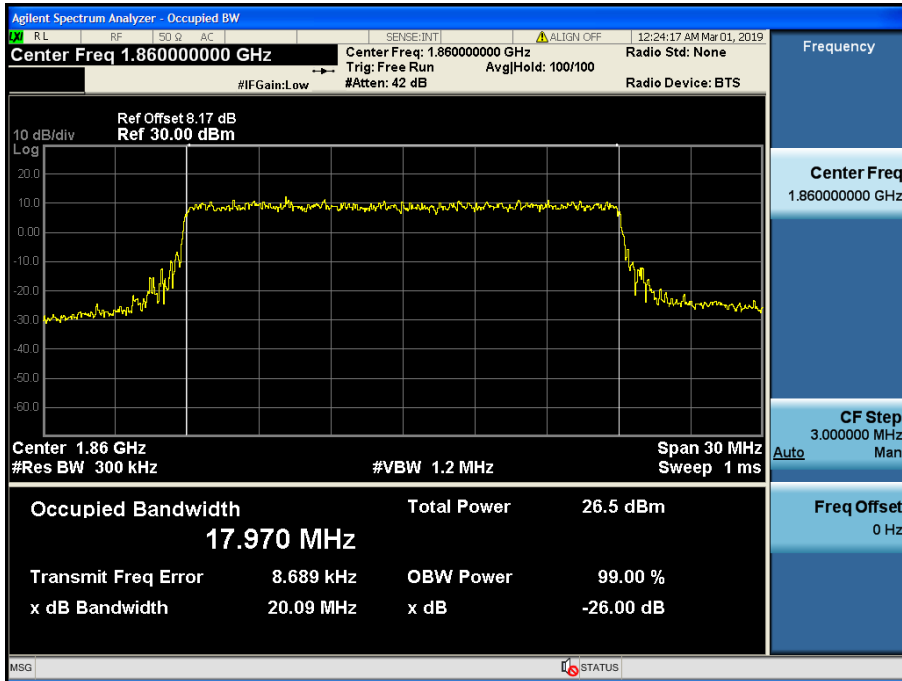

LTE Band 2 / 20 MHz / 16QAM - RB Size 100

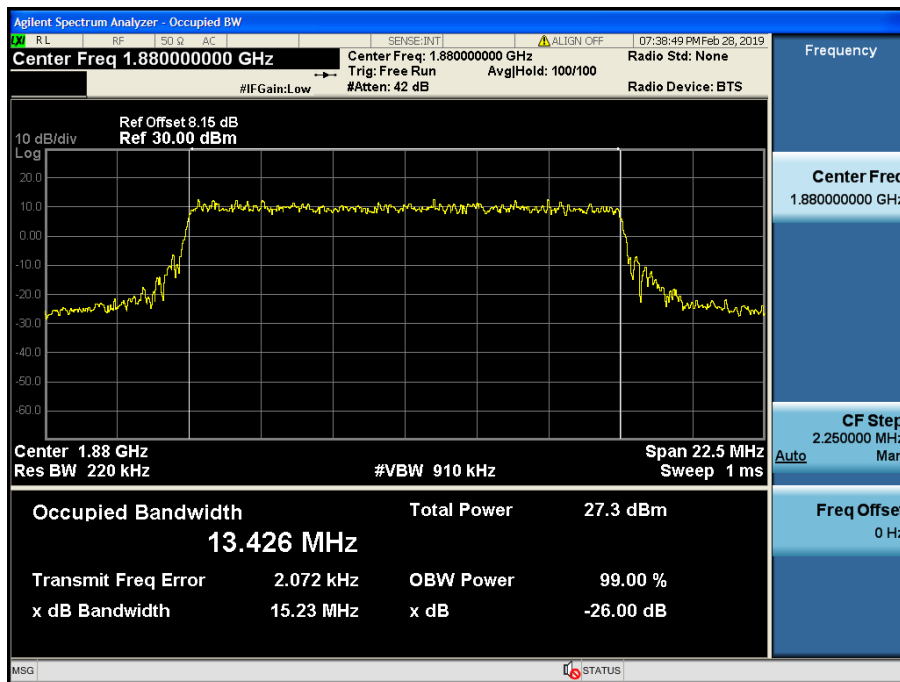

LTE Band 2 / 15 MHz / QPSK - RB Size 75

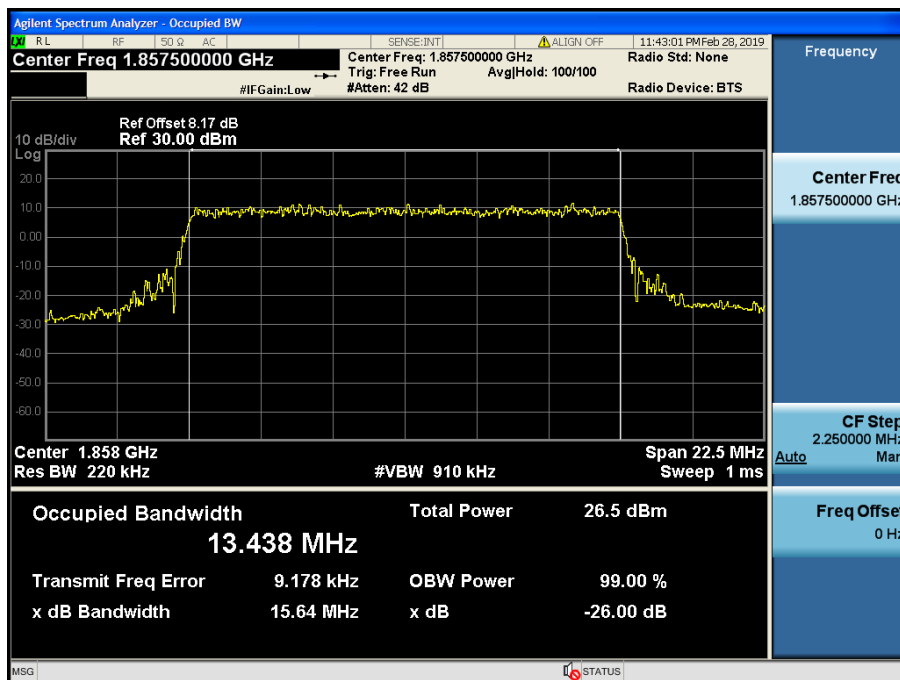

LTE Band 2 / 15 MHz / 16QAM - RB Size 75

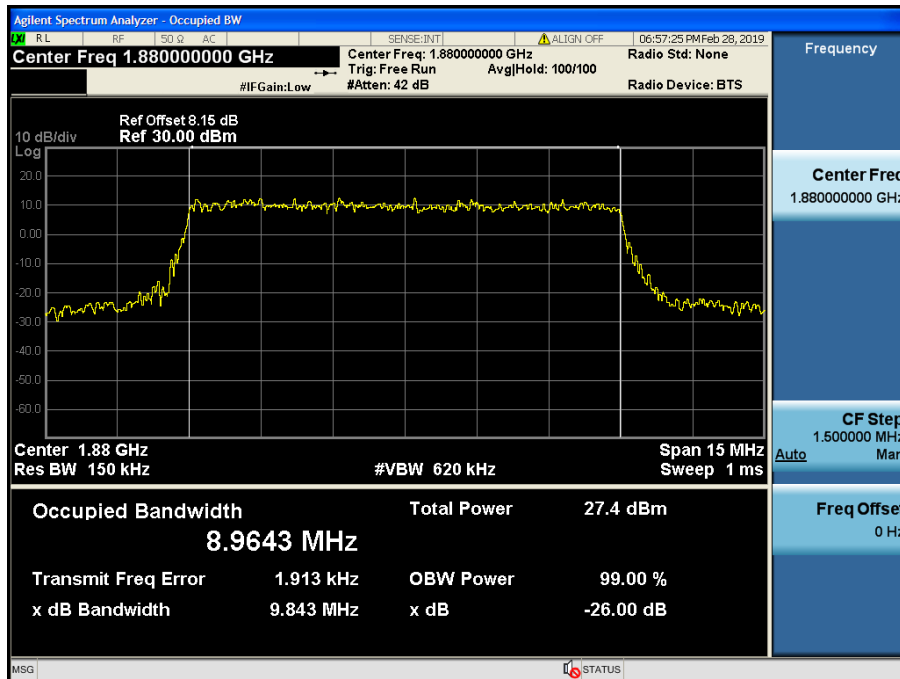

LTE Band 2 / 10 MHz / QPSK - RB Size 50

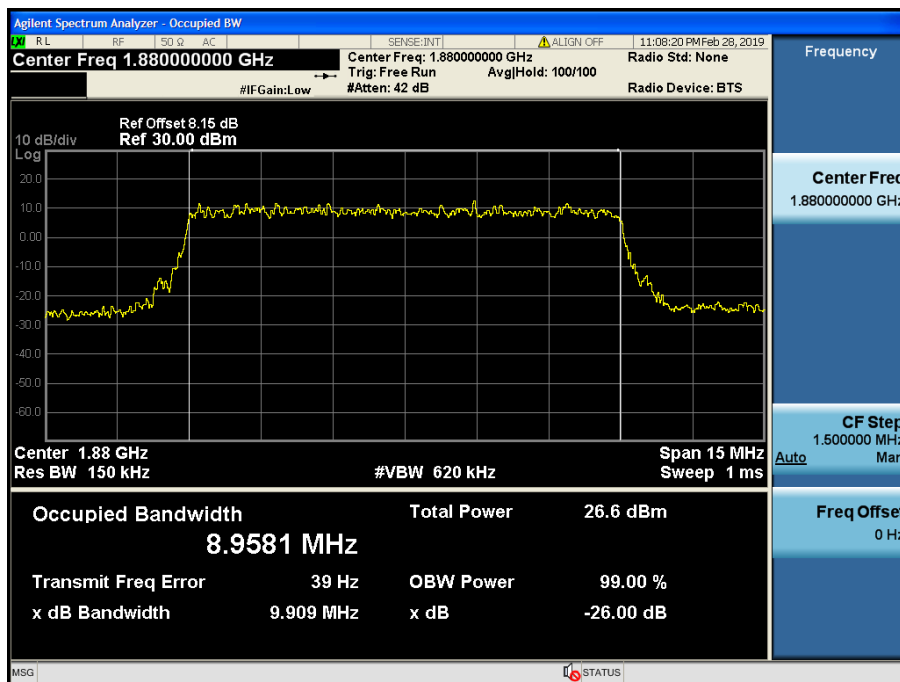

LTE Band 2 / 10 MHz / 16QAM - RB Size 50

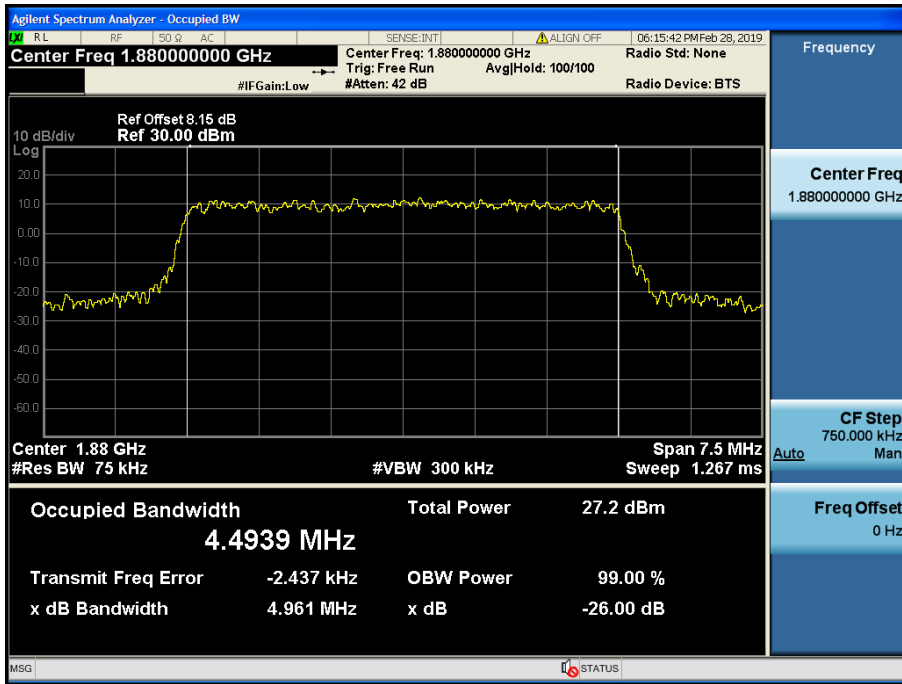

LTE Band 2 / 5 MHz / QPSK - RB Size 25

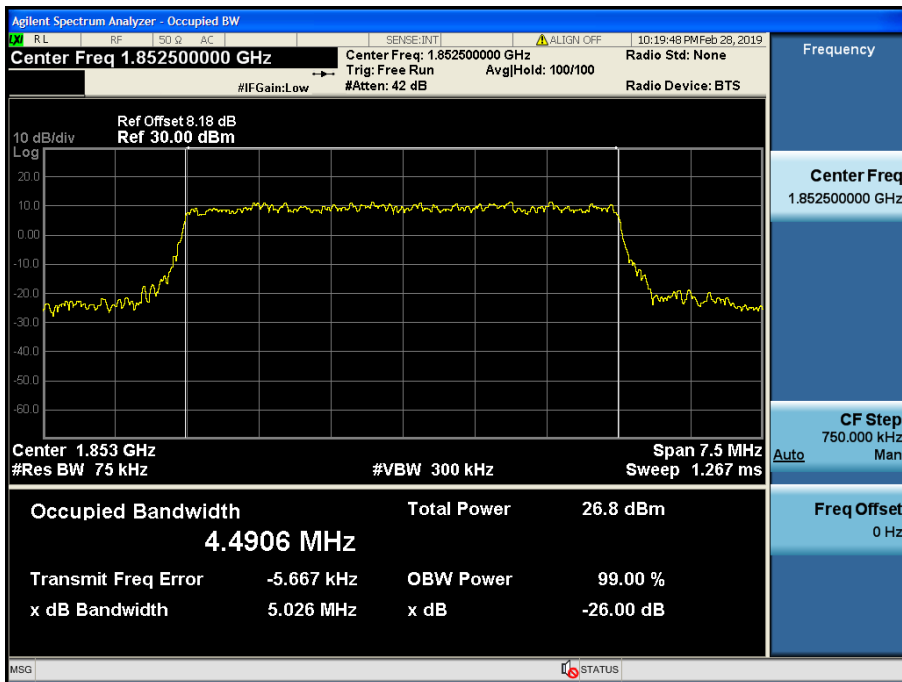

LTE Band 2 / 5 MHz / 16QAM - RB Size 25

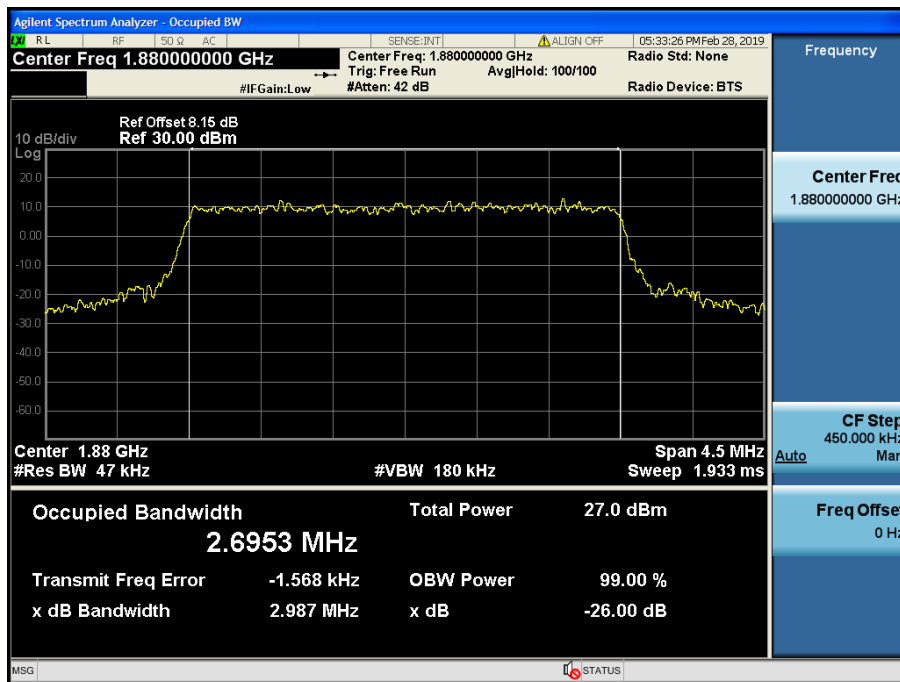

LTE Band 2 / 3 MHz / QPSK - RB Size 15

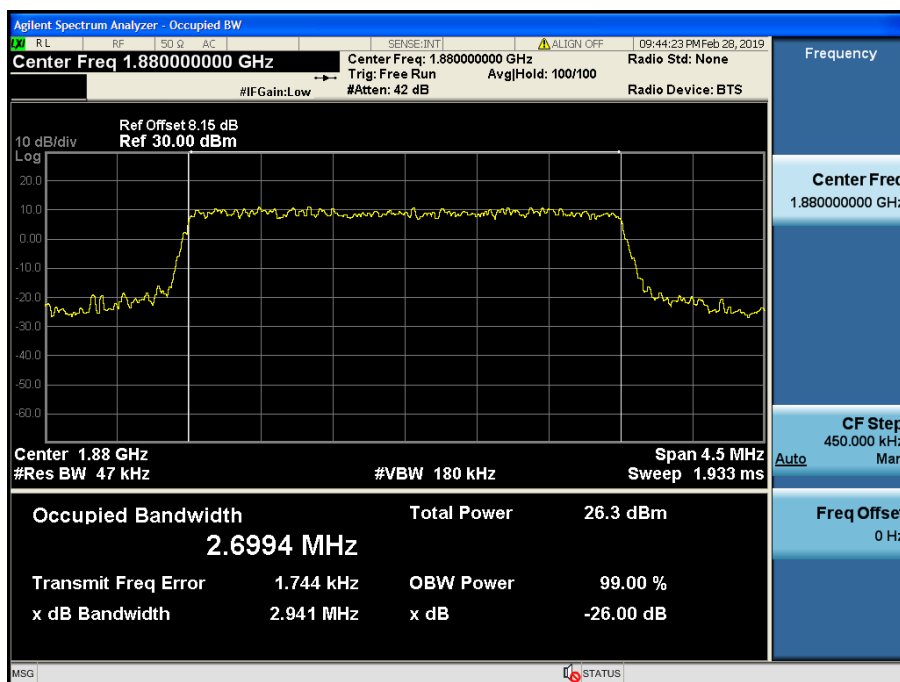

LTE Band 2 / 3 MHz / 16QAM - RB Size 15

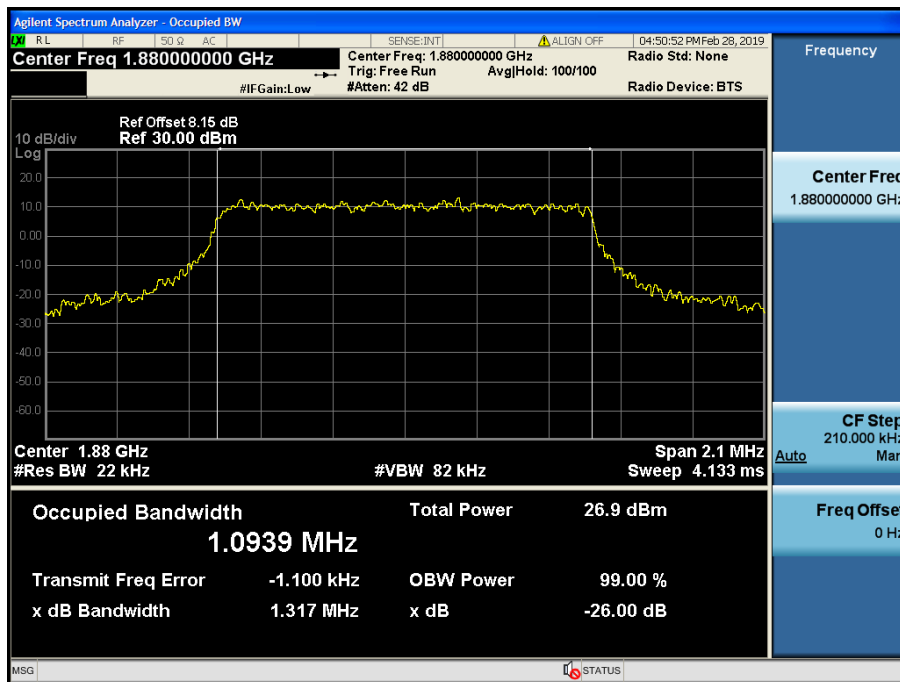

LTE Band 2 / 1.4 MHz / QPSK - RB Size 6

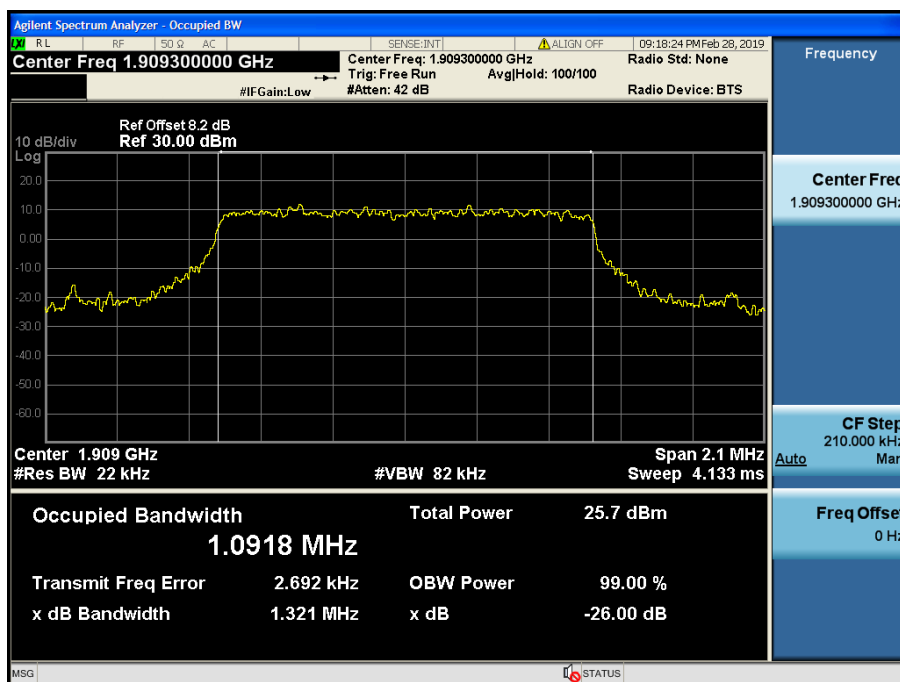

LTE Band 2 / 1.4 MHz / 16QAM - RB Size 6

8.2 PEAK TO AVERAGE RATIO

8.2.1 LTE Band 12

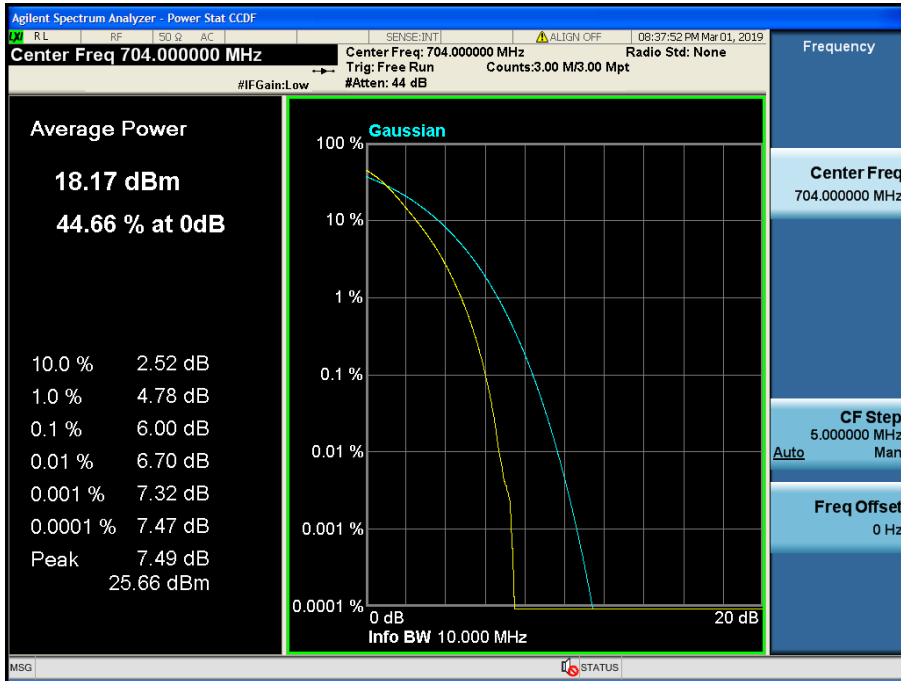

LTE Band 12 / 10 MHz / QPSK - RB Size 50

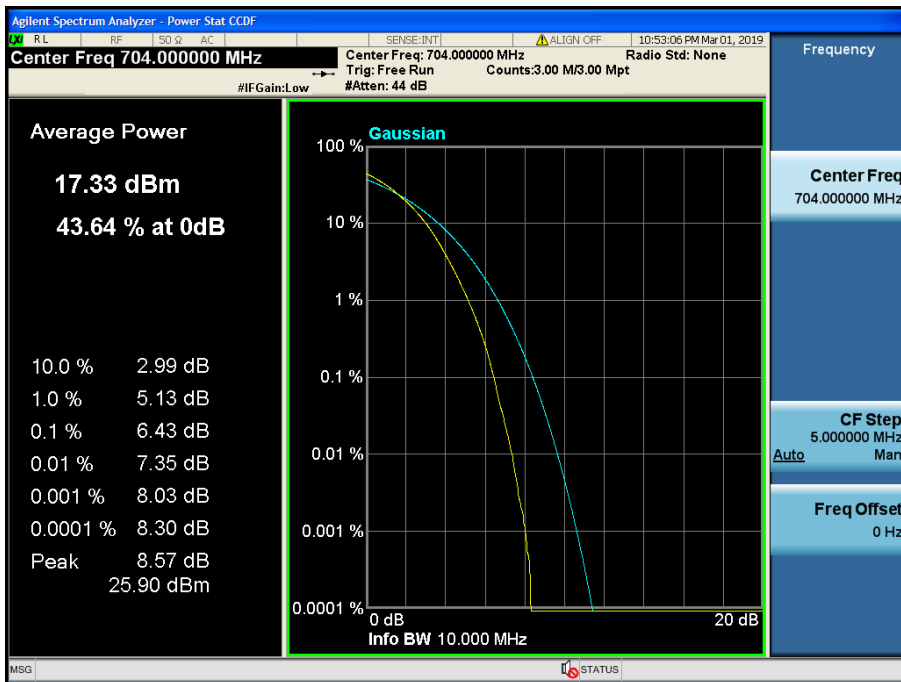

LTE Band 12 / 10 MHz / 16QAM - RB Size 50

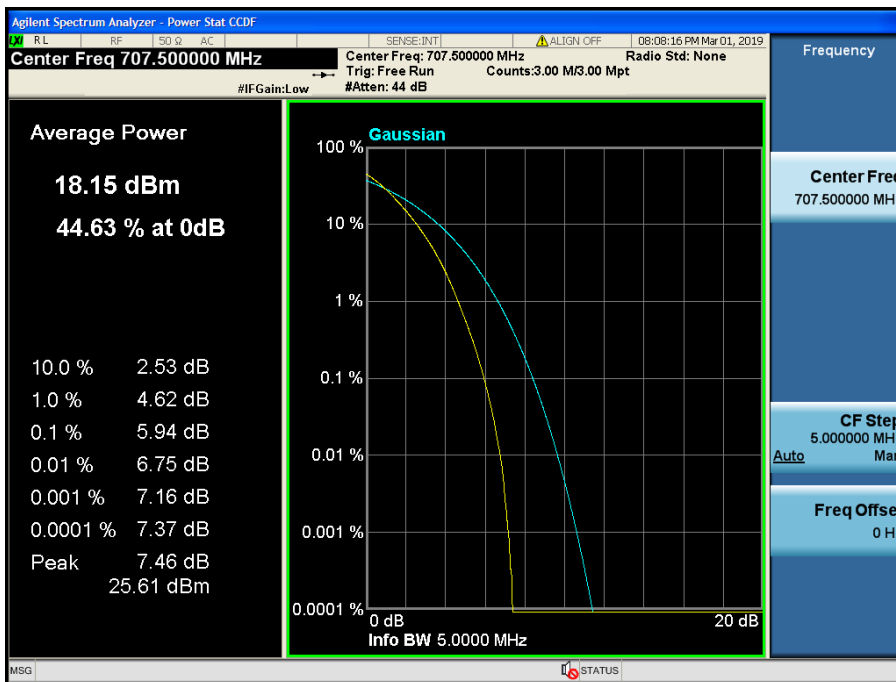

LTE Band 12 / 5 MHz / QPSK - RB Size 25

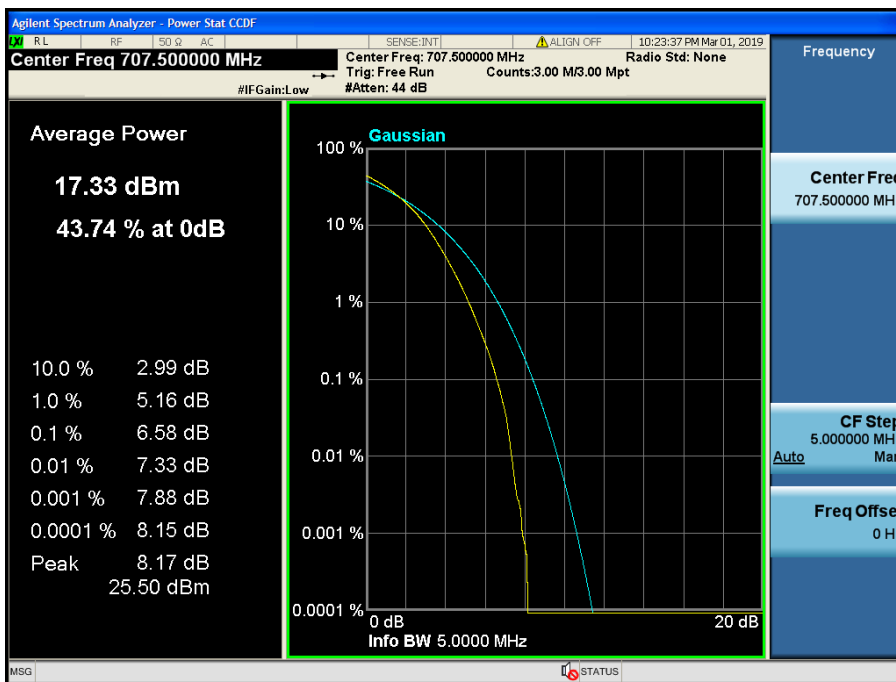

LTE Band 12 / 5 MHz / 16QAM - RB Size 25

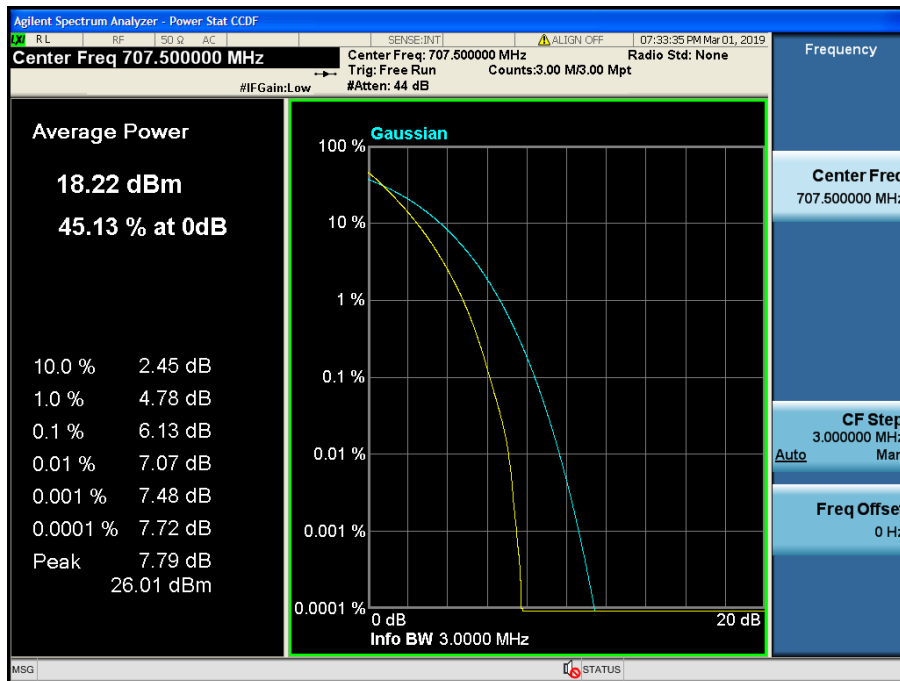

LTE Band 12 / 3 MHz / QPSK - RB Size 15

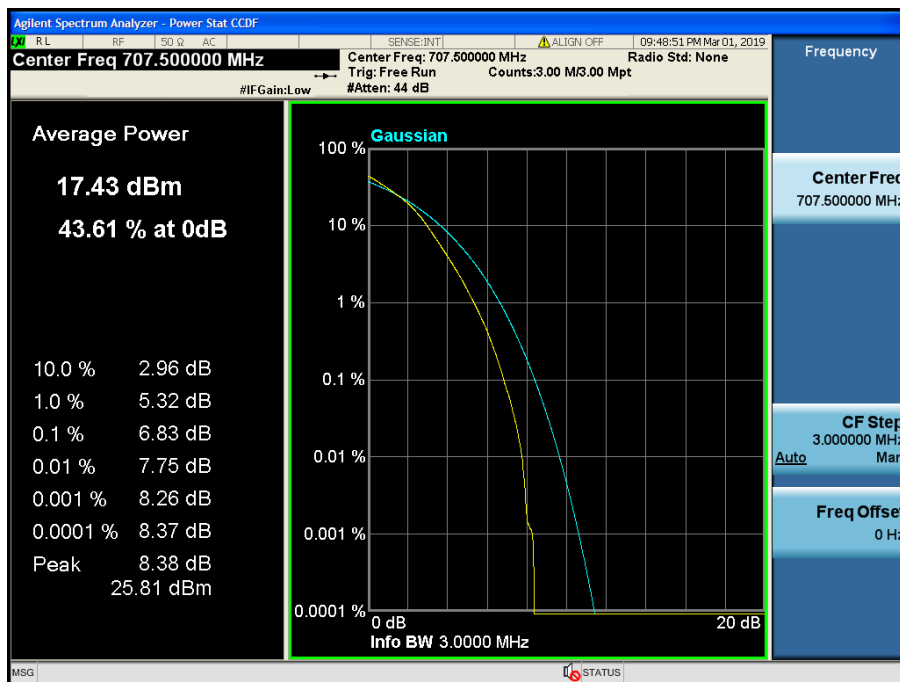

LTE Band 12 / 3 MHz / 16QAM - RB Size 15

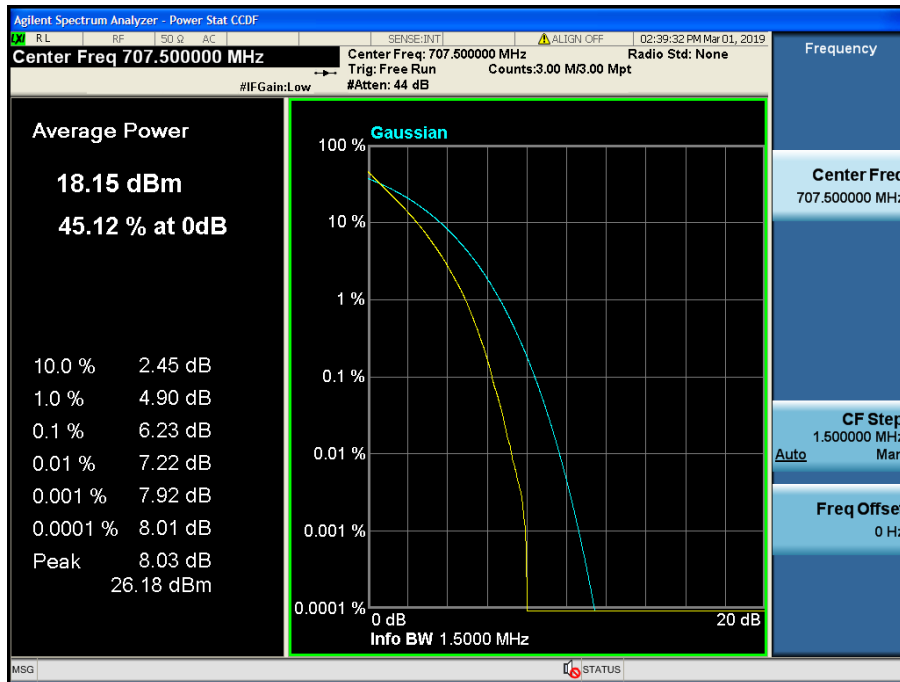

LTE Band 12 / 1.4 MHz / QPSK - RB Size 6

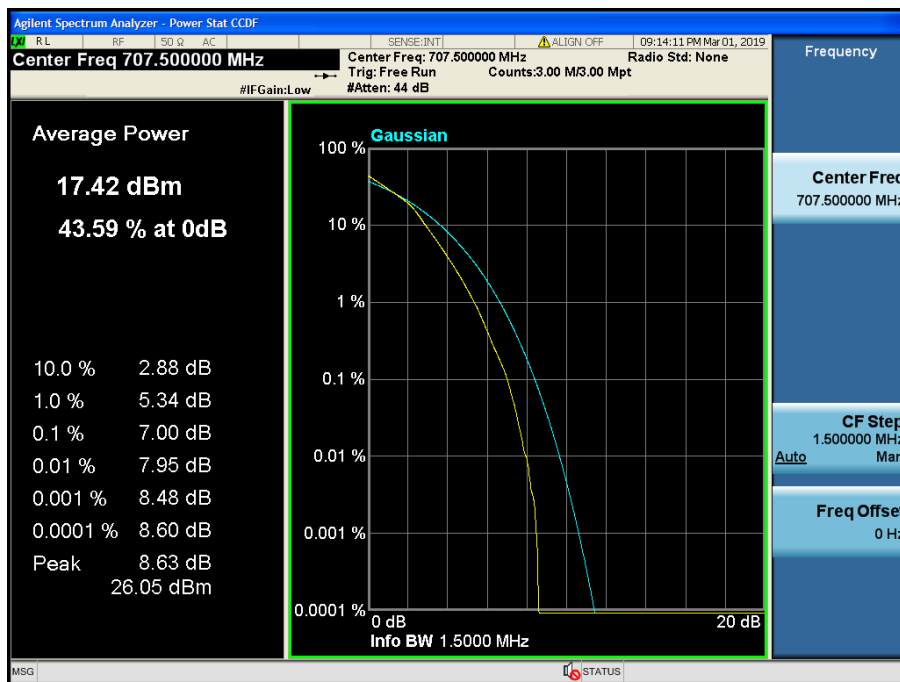

LTE Band 12 / 1.4 MHz / 16QAM - RB Size 6

8.2.2 LTE Band 4

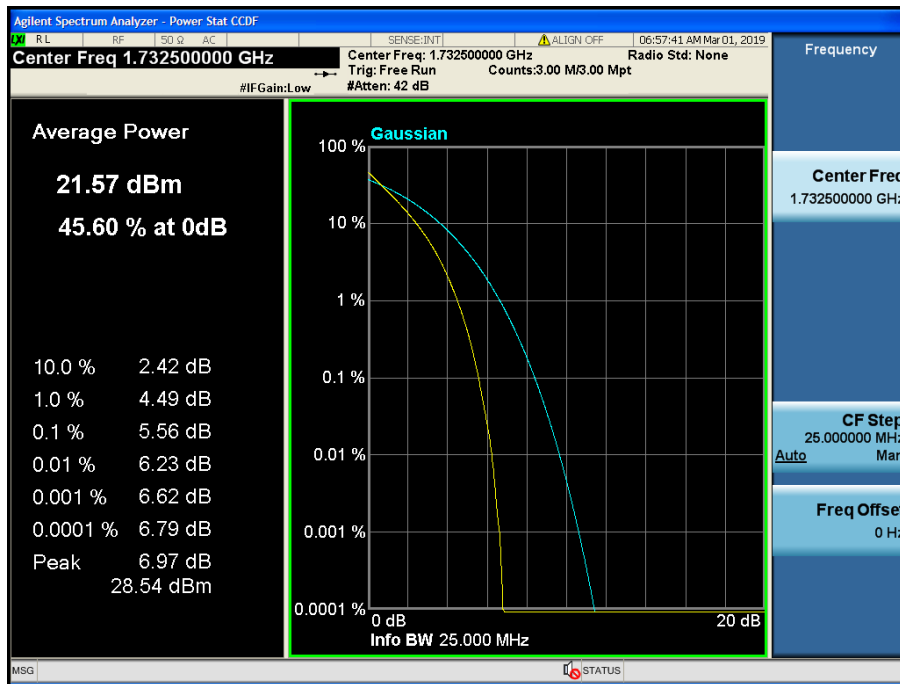

LTE Band 4 / 20 MHz / QPSK - RB Size 100

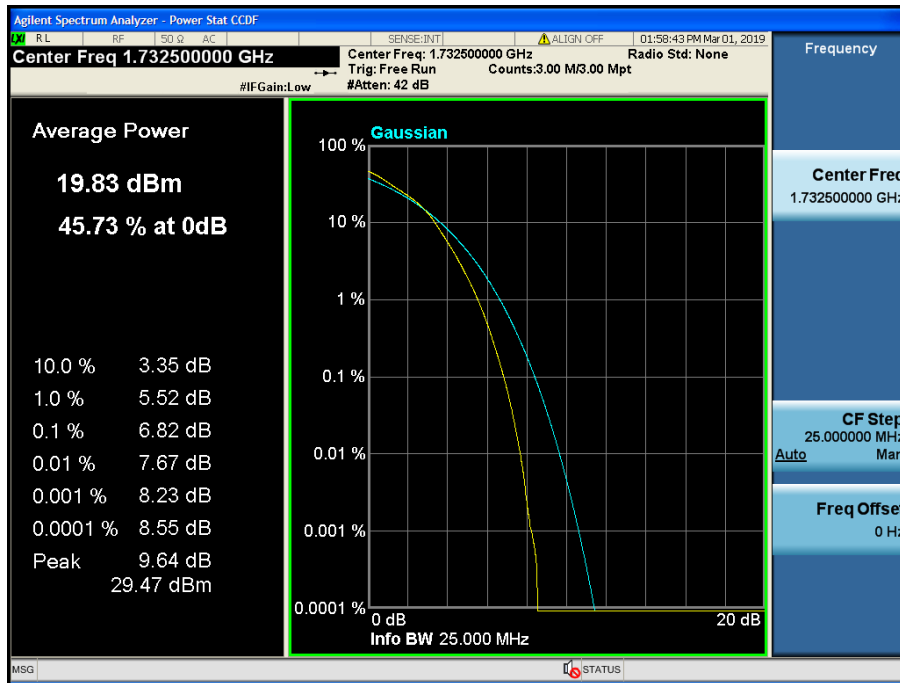

LTE Band 4 / 20 MHz / 16QAM - RB Size 100

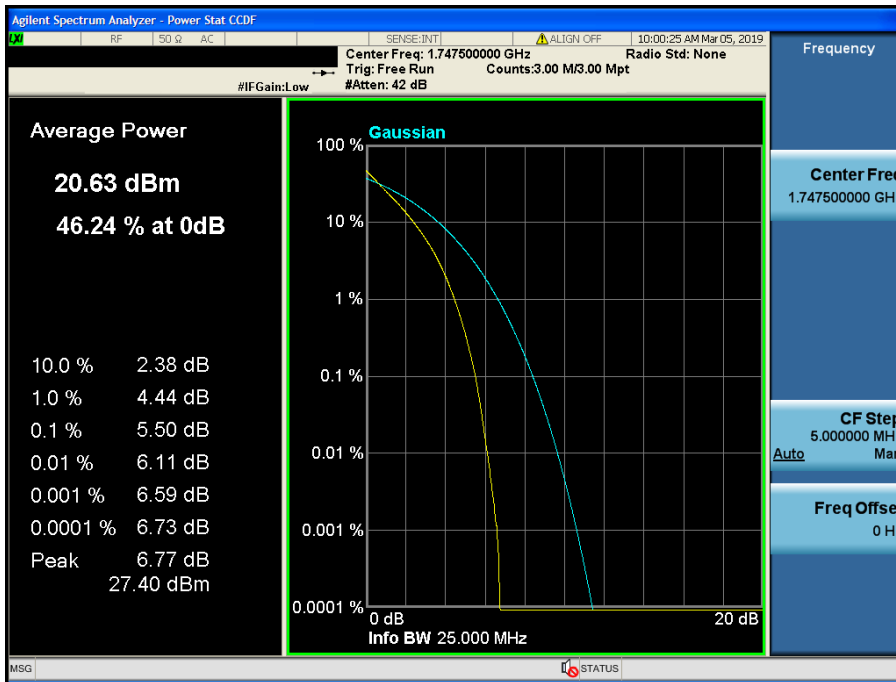

LTE Band 4 / 15 MHz / QPSK - RB Size 75

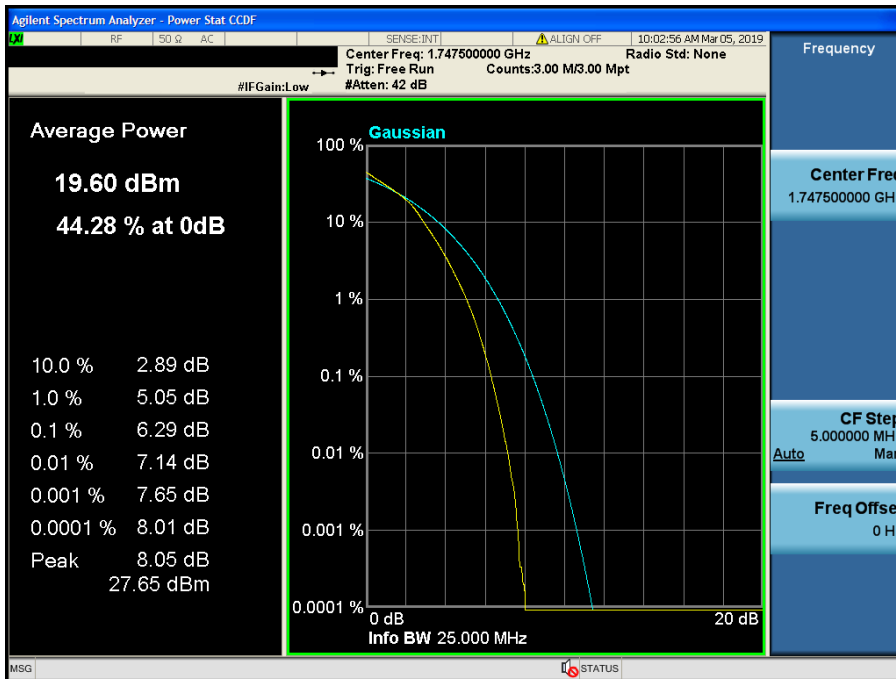

LTE Band 4 / 15 MHz / 16QAM - RB Size 75

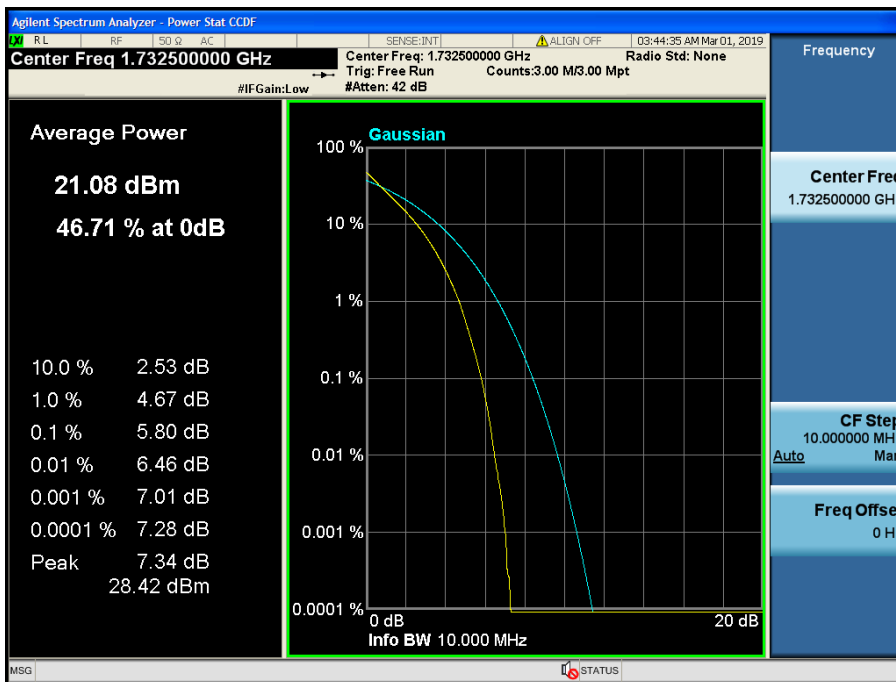

LTE Band 4 / 10 MHz / QPSK - RB Size 50

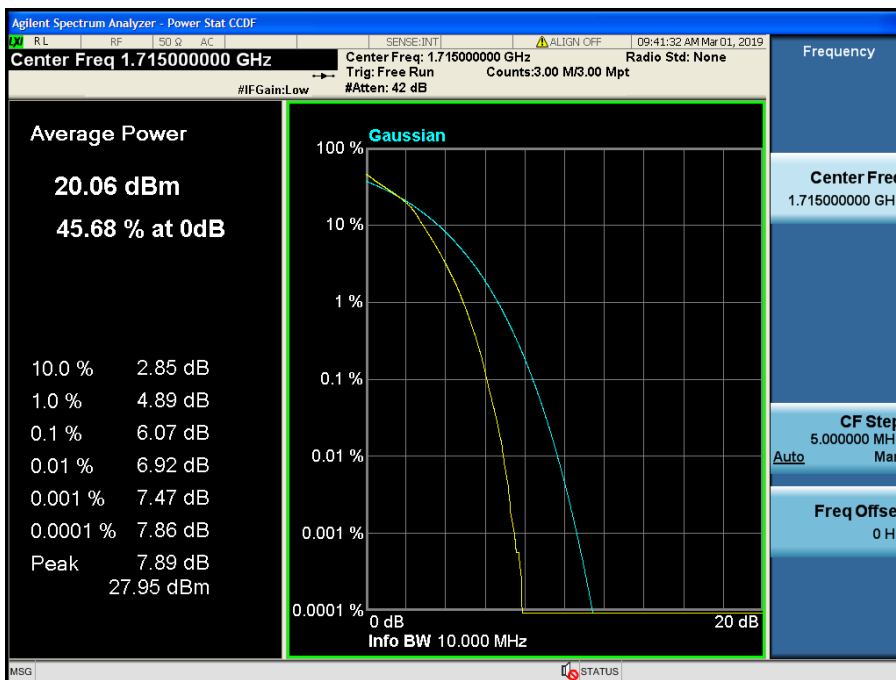

LTE Band 4 / 10 MHz / 16QAM - RB Size 50

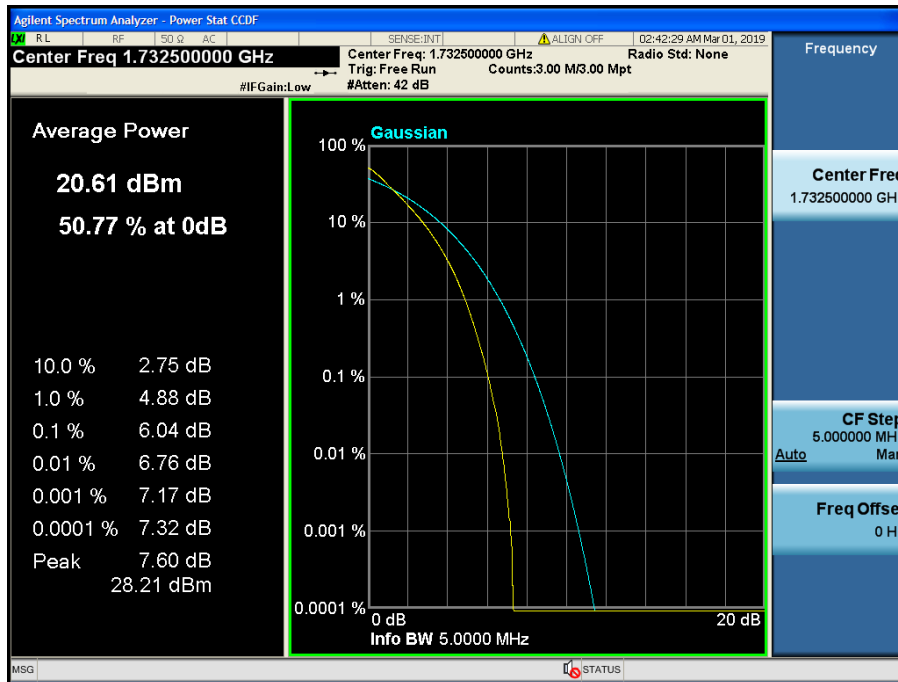

LTE Band 4 / 5 MHz / QPSK - RB Size 25

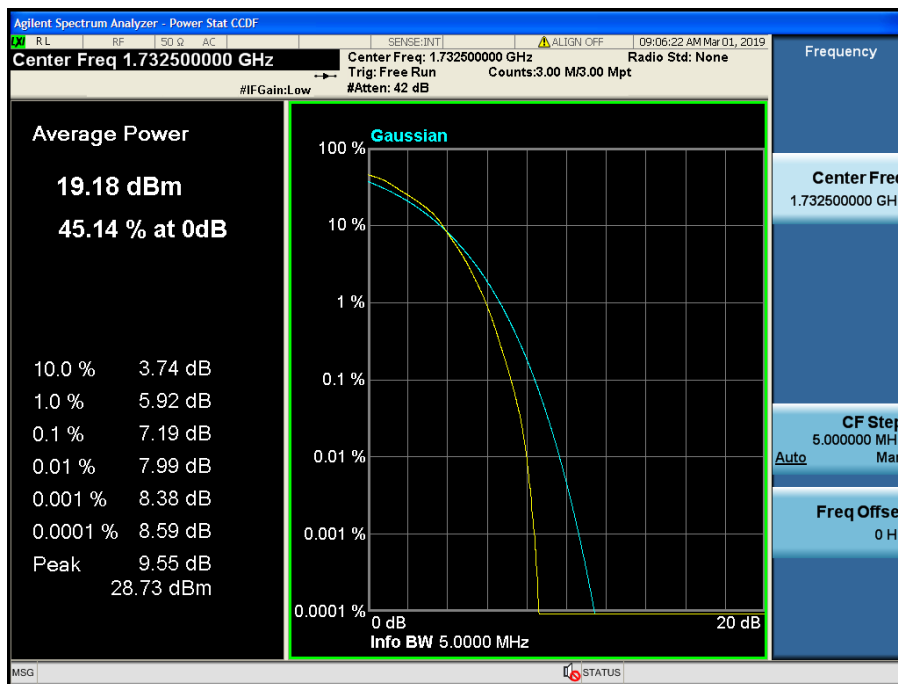

LTE Band 4 / 5 MHz / 16QAM - RB Size 25

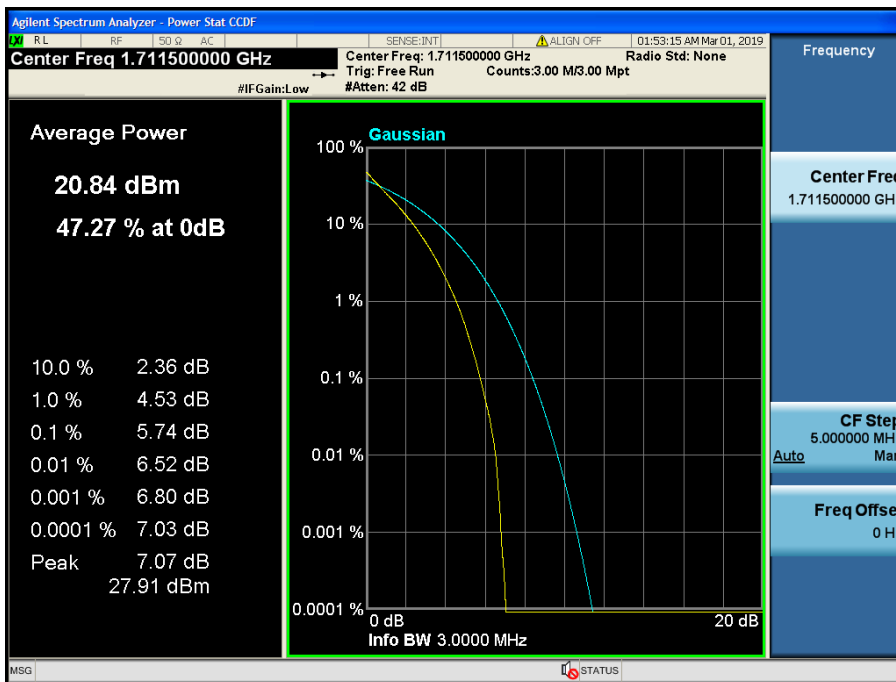

LTE Band 4 / 3 MHz / QPSK - RB Size 15

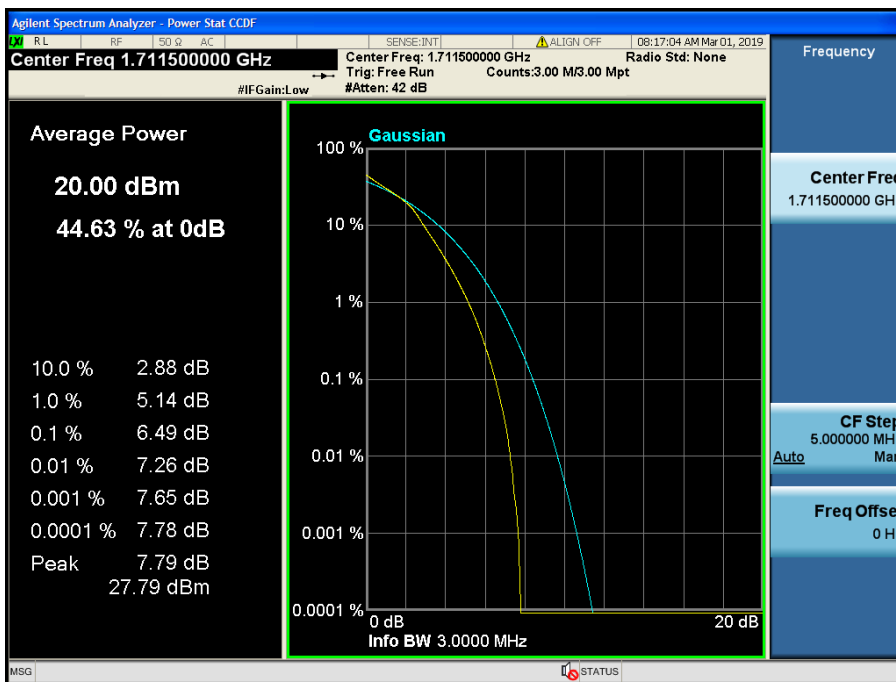

LTE Band 4 / 3 MHz / 16QAM - RB Size 15

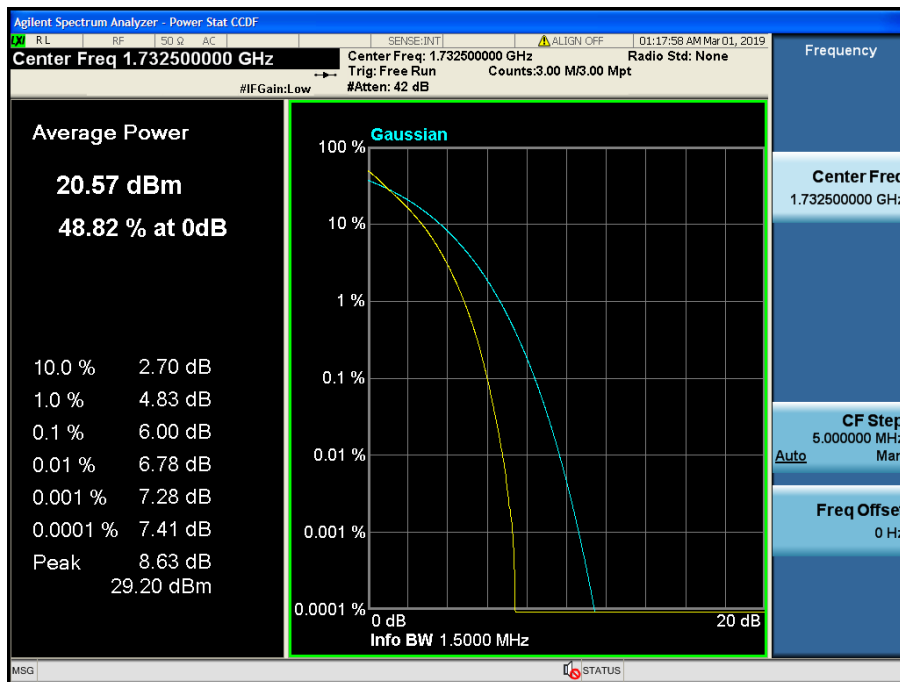

LTE Band 4 / 1.4 MHz / QPSK - RB Size 6

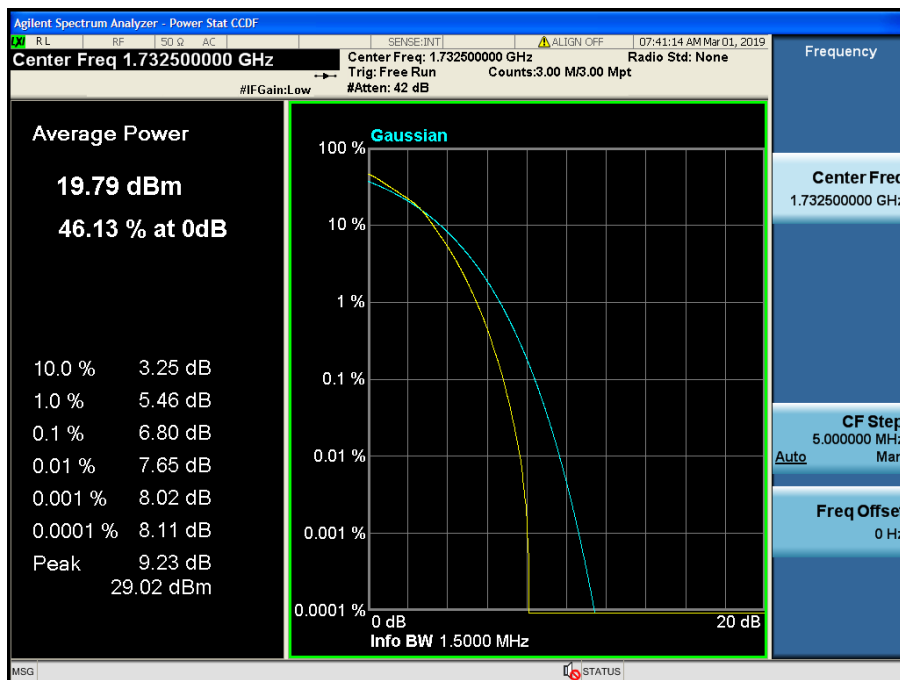

LTE Band 4 / 1.4 MHz / 16QAM - RB Size 6

8.2.3 LTE Band 2

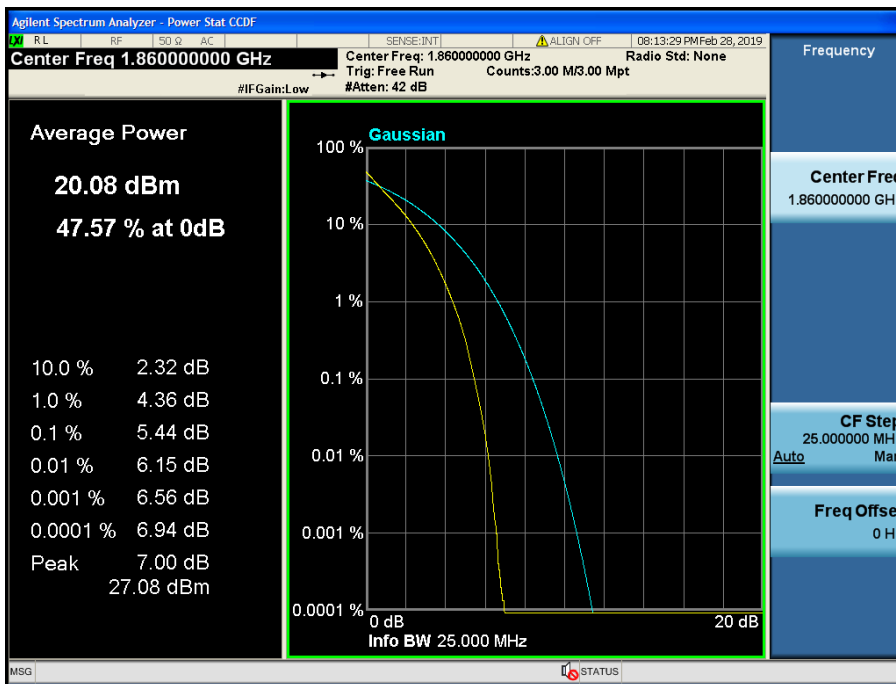

LTE Band 2 / 20 MHz / QPSK - RB Size 100

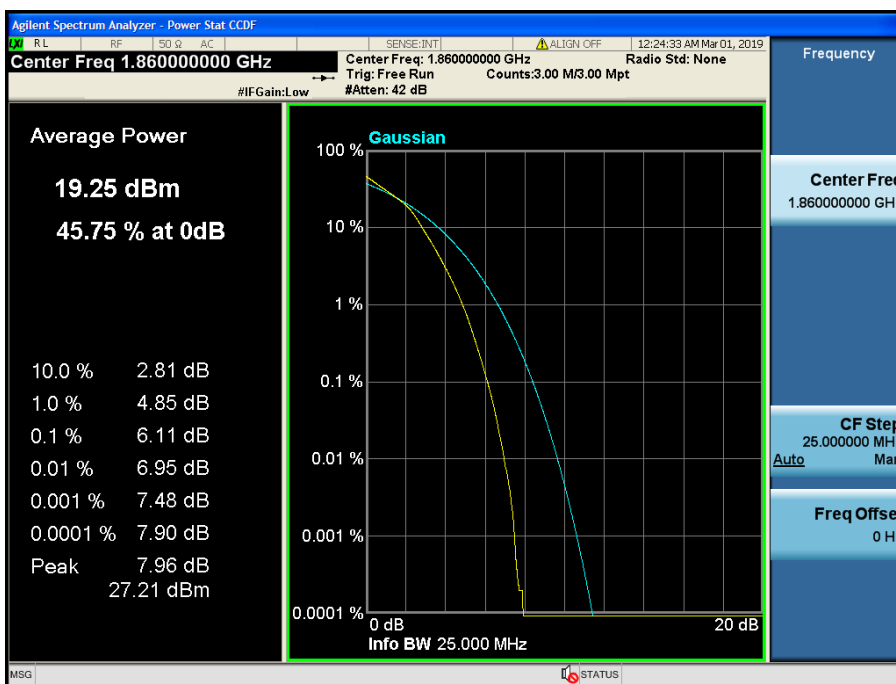

LTE Band 2 / 20 MHz / 16QAM - RB Size 100

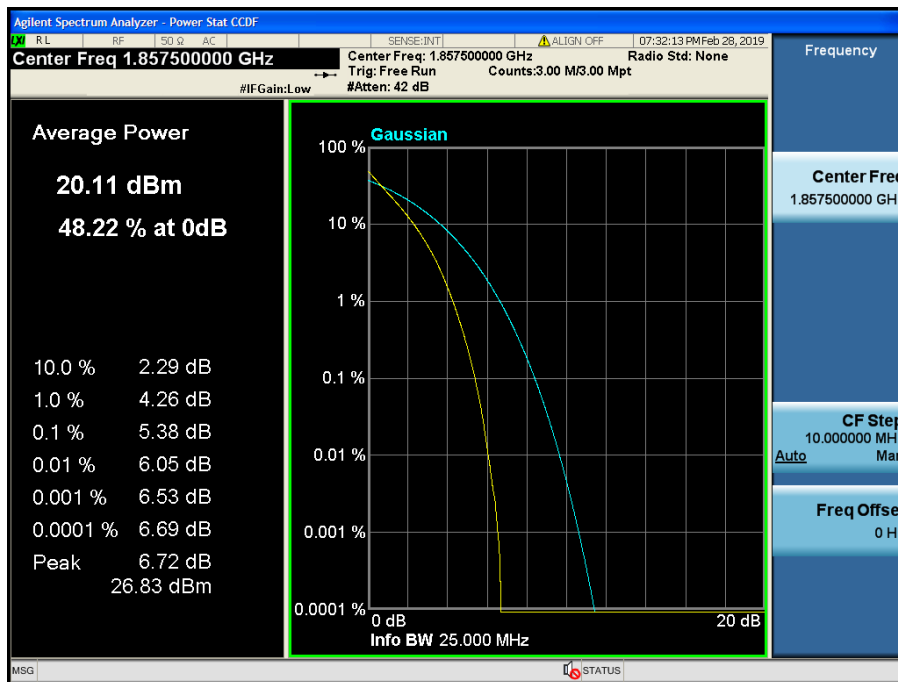

LTE Band 2 / 15 MHz / QPSK - RB Size 75

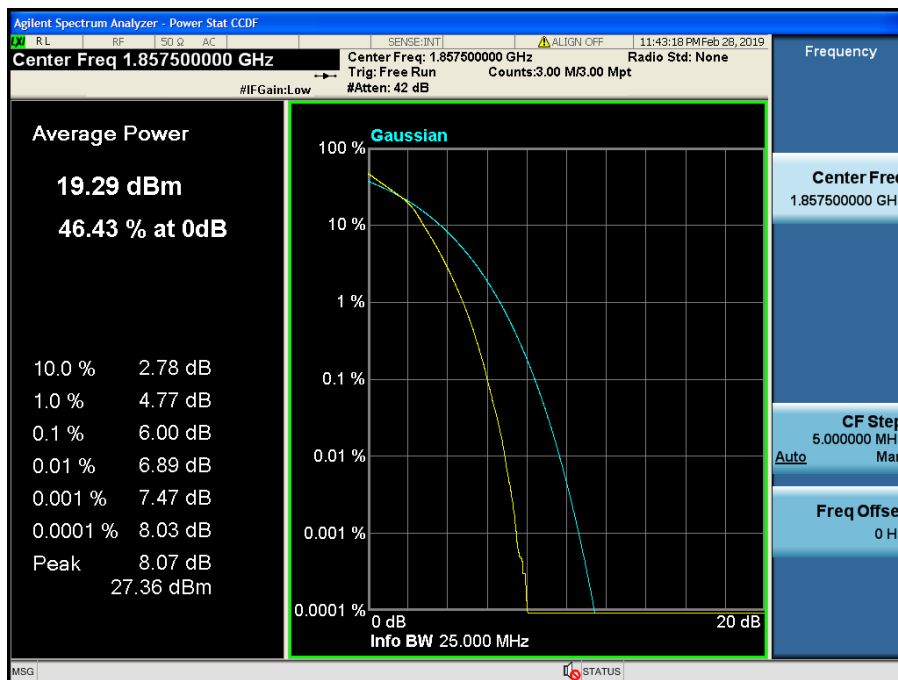

LTE Band 2 / 15 MHz / 16QAM - RB Size 75

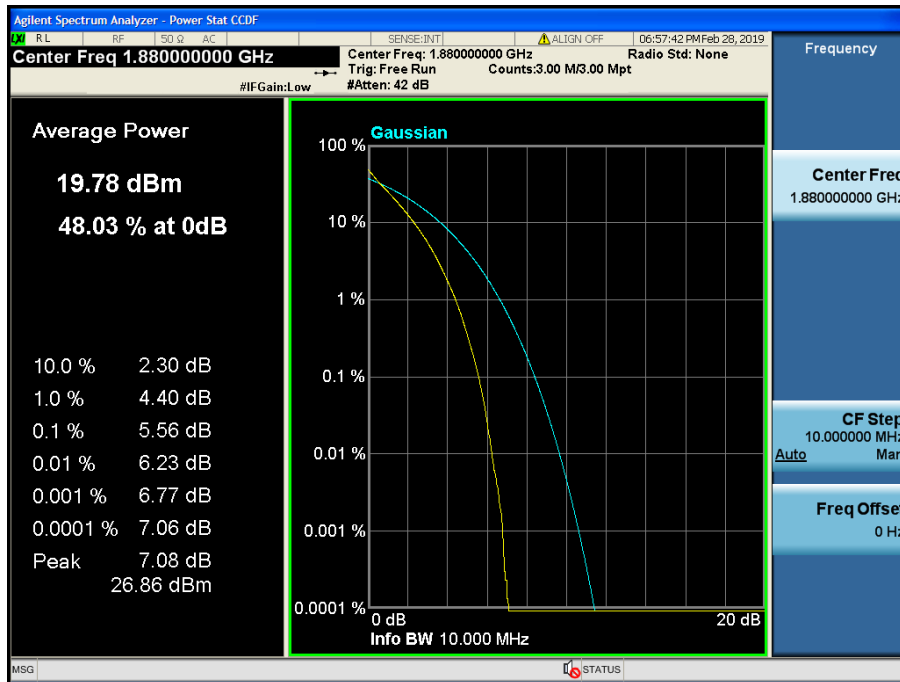

LTE Band 2 / 10 MHz / QPSK - RB Size 50

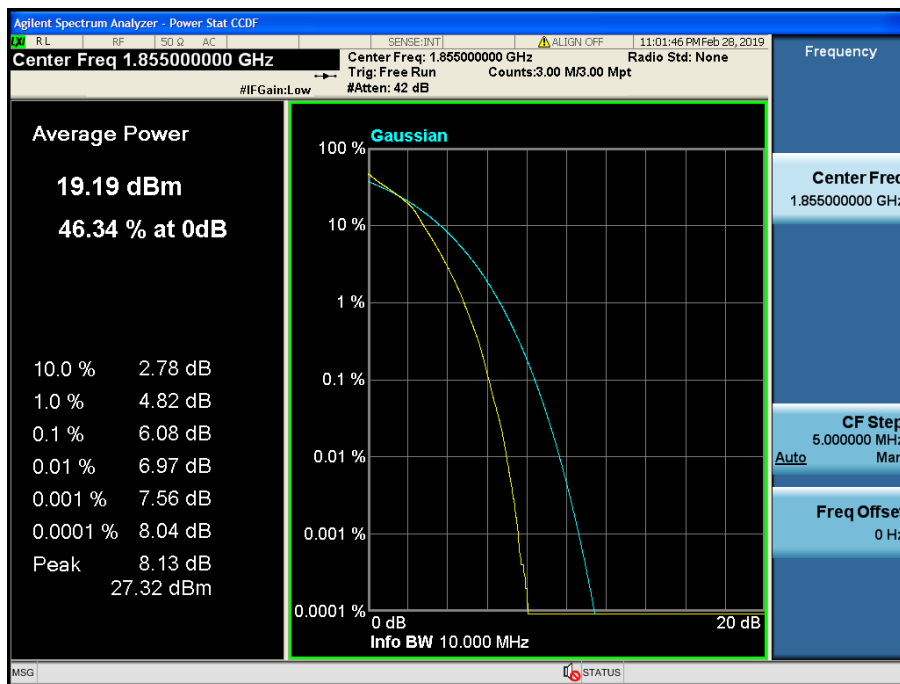

LTE Band 2 / 10 MHz / 16QAM - RB Size 50

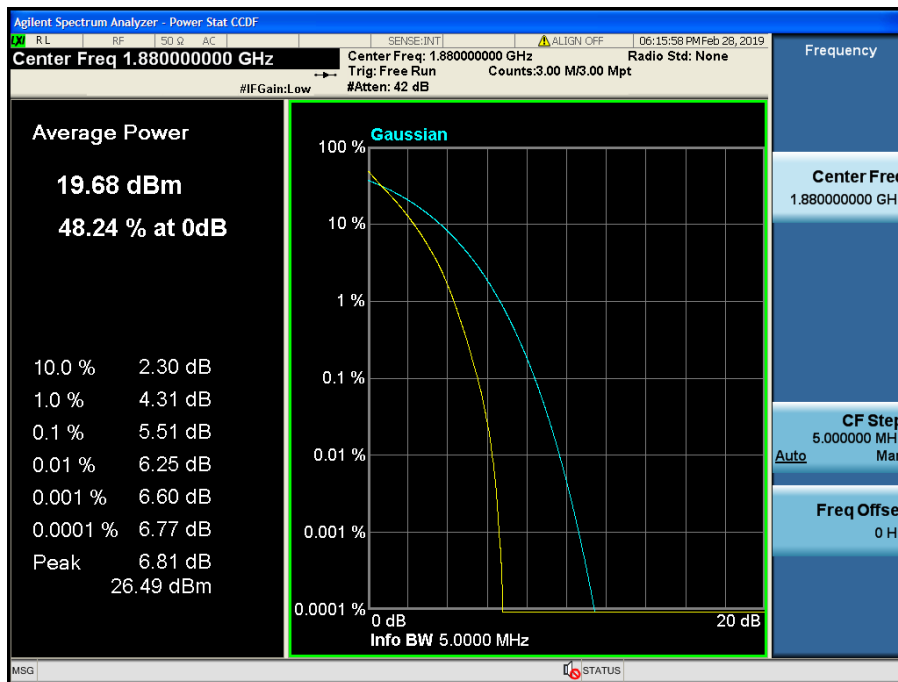

LTE Band 2 / 5 MHz / QPSK - RB Size 25

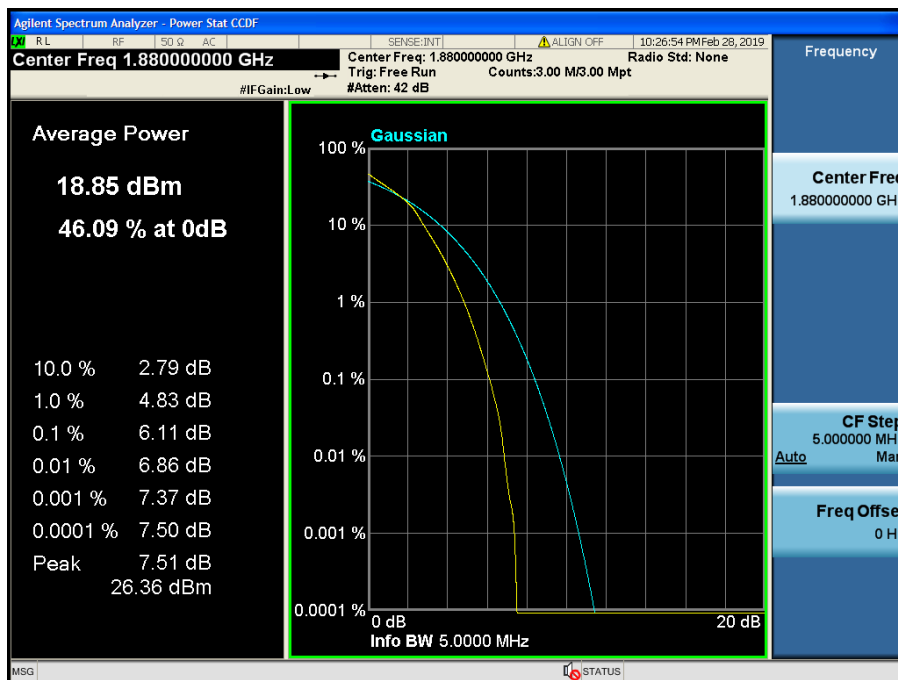

LTE Band 2 / 5 MHz / 16QAM - RB Size 25

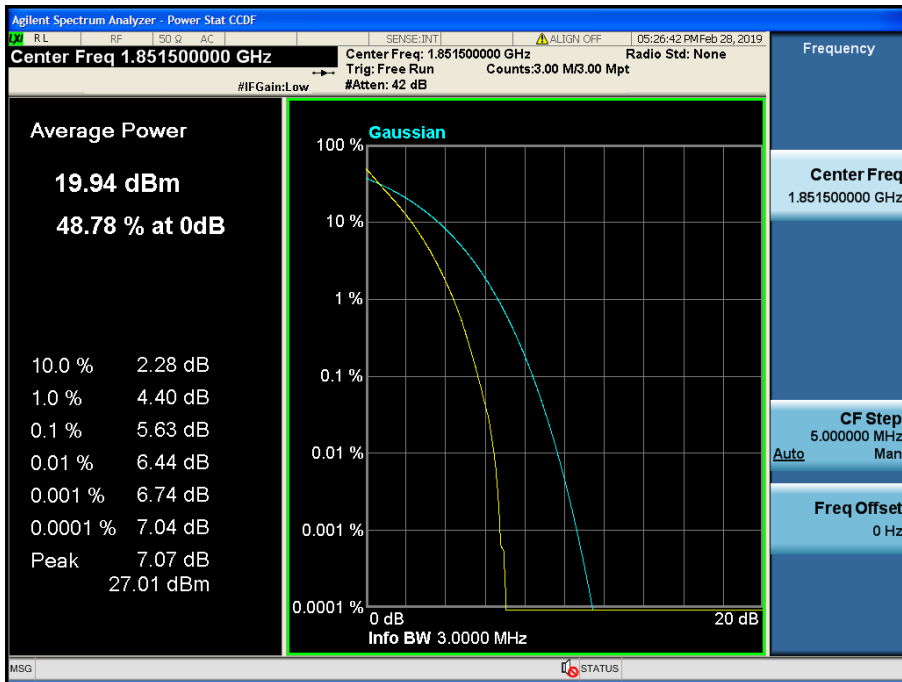

LTE Band 2 / 3 MHz / QPSK - RB Size 15

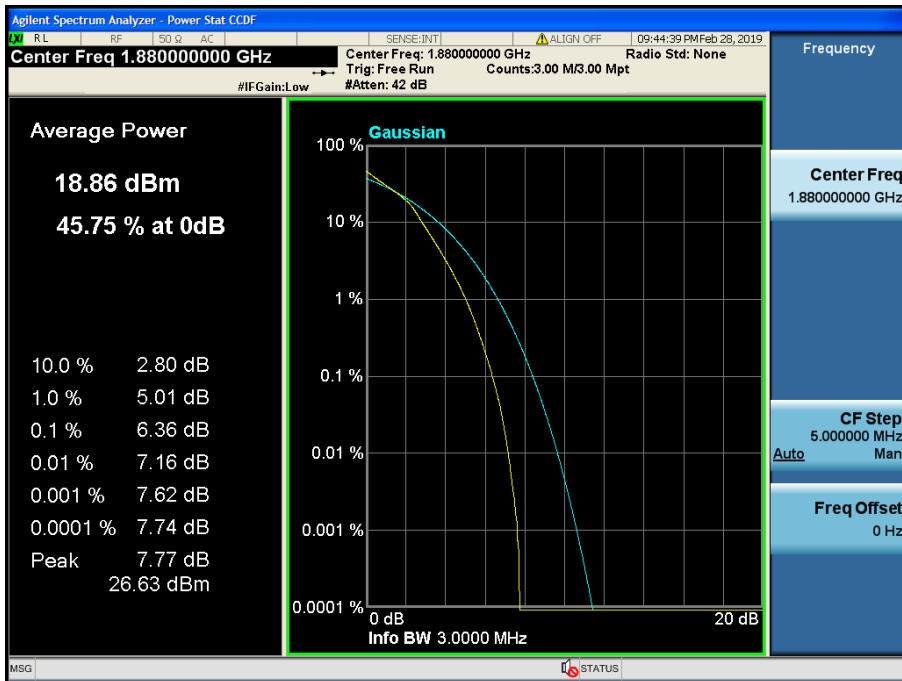

LTE Band 2 / 3 MHz / 16QAM - RB Size 15

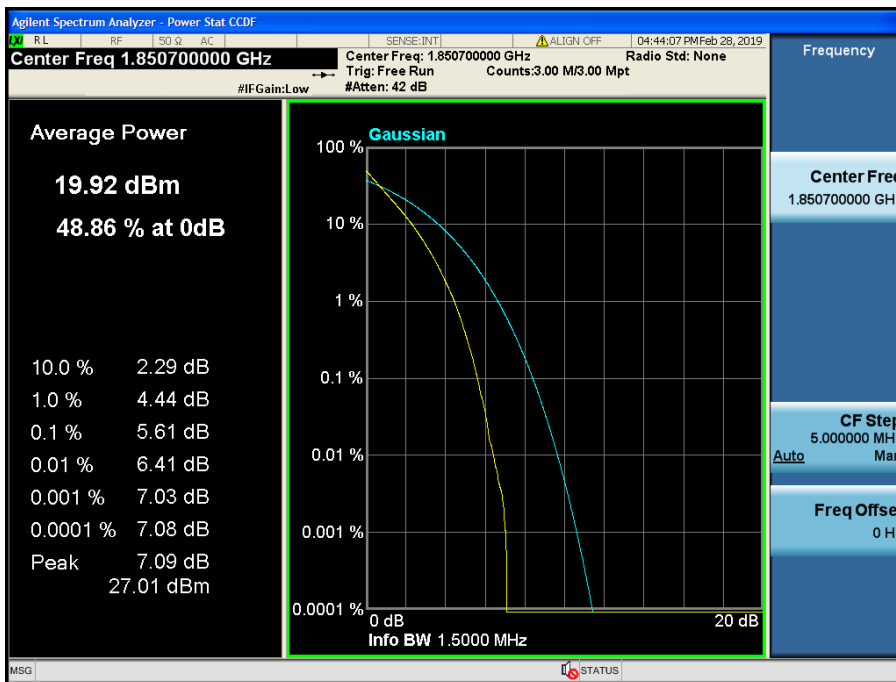

LTE Band 2 / 1.4 MHz / QPSK - RB Size 6

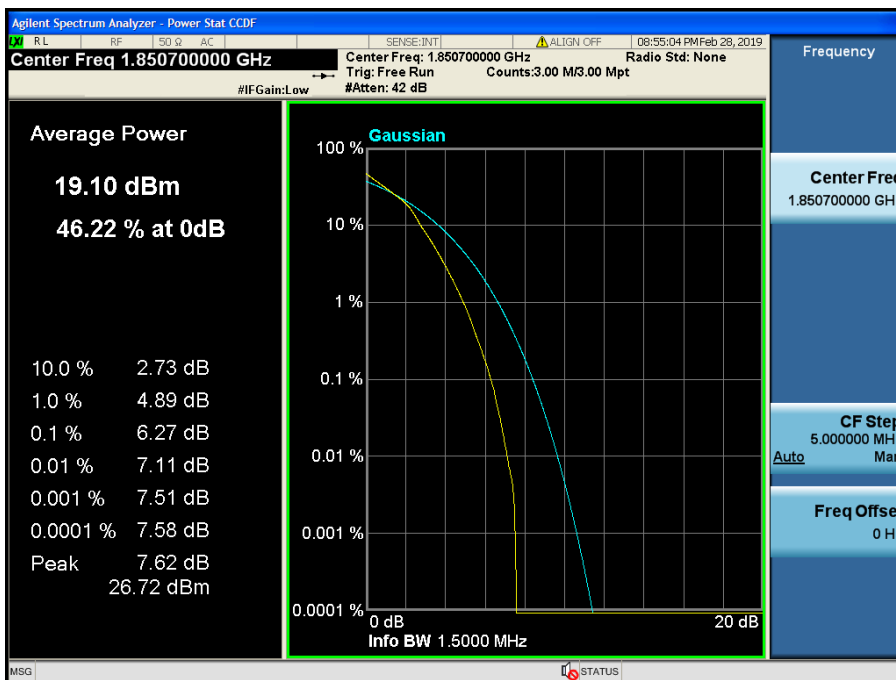

LTE Band 2 / 1.4 MHz / 16QAM - RB Size 6

8.3 BAND EDGE EMISSIONS(Conducted)

8.3.1 LTE Band 12

- Lower Band Edge

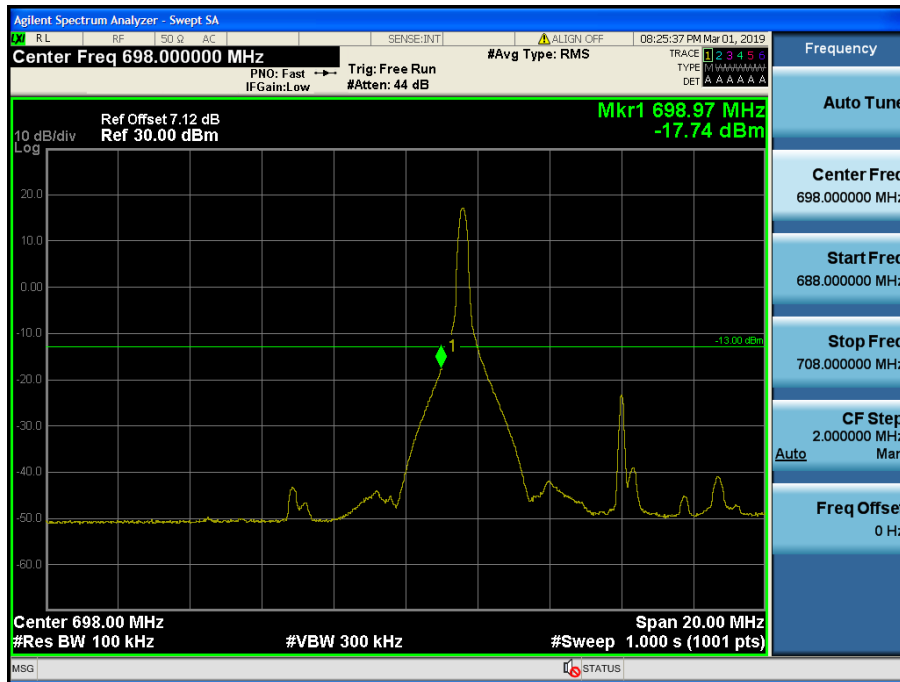

LTE Band 12 / 10MHz / QPSK - RB Size/Offset (1/0)

- Lower Extended Band Edge

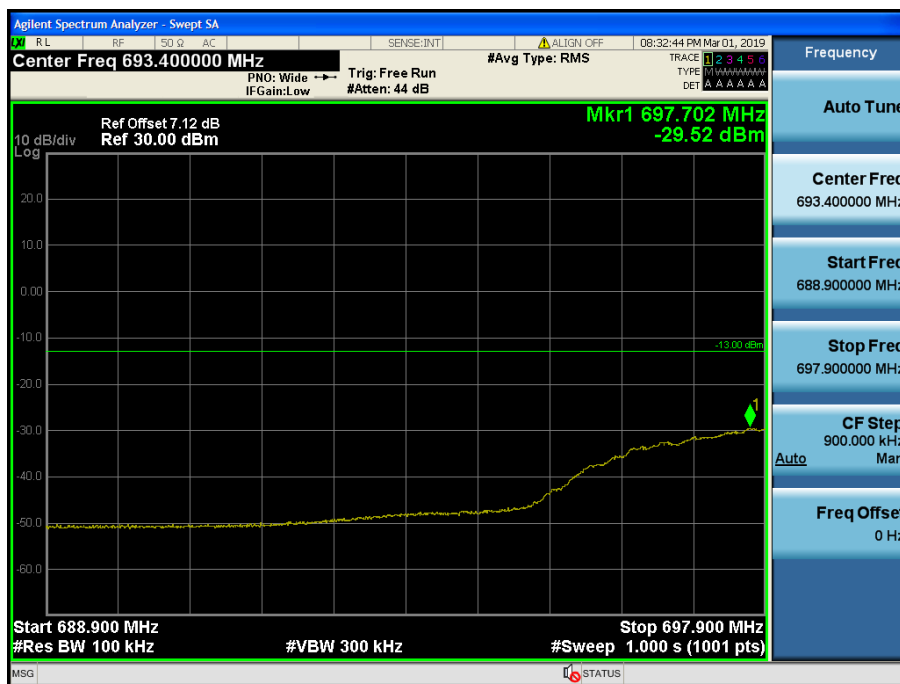

LTE Band 12 / 10MHz / QPSK - RB Size/Offset (25/0)

- Upper Band Edge

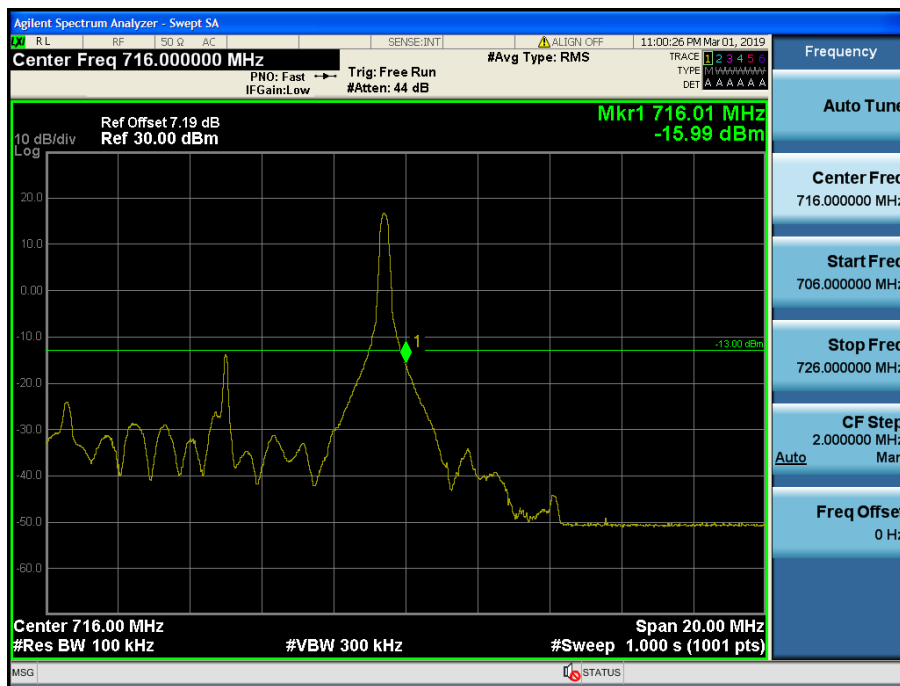

LTE Band 12 / 10MHz / 16QAM - RB Size/Offset (1/49)

- Upper Extended Band Edge



LTE Band 12 / 10MHz / QPSK - RB Size/Offset (1/49)

- Lower Band Edge

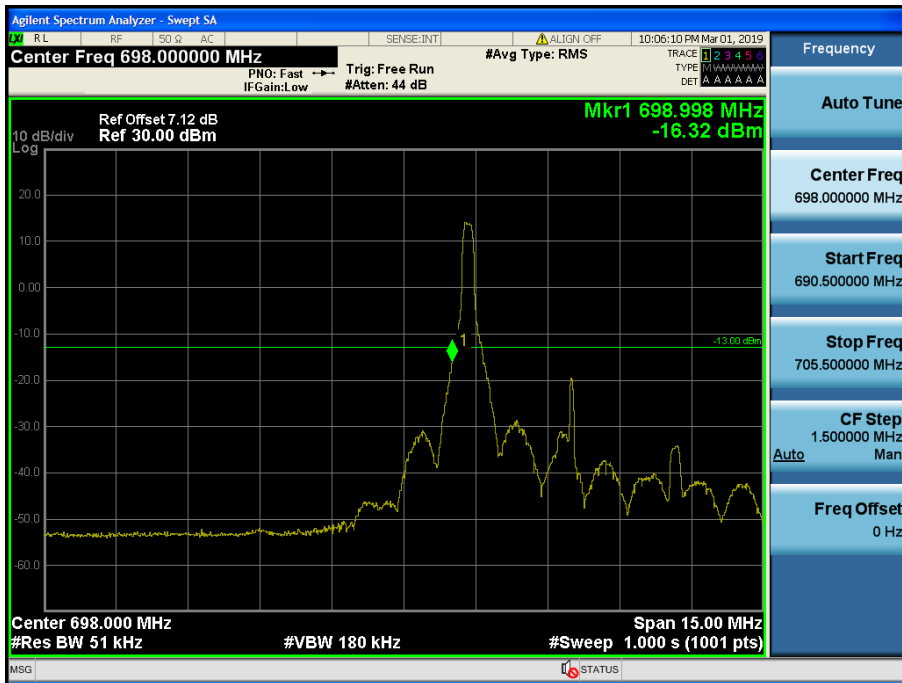

LTE Band 12 / 5MHz / 16QAM Offset/Size (1/0)

- Lower Extended Band Edge



LTE Band 12 / 5MHz / QPSK Offset/Size (25/0)

- Upper Band Edge

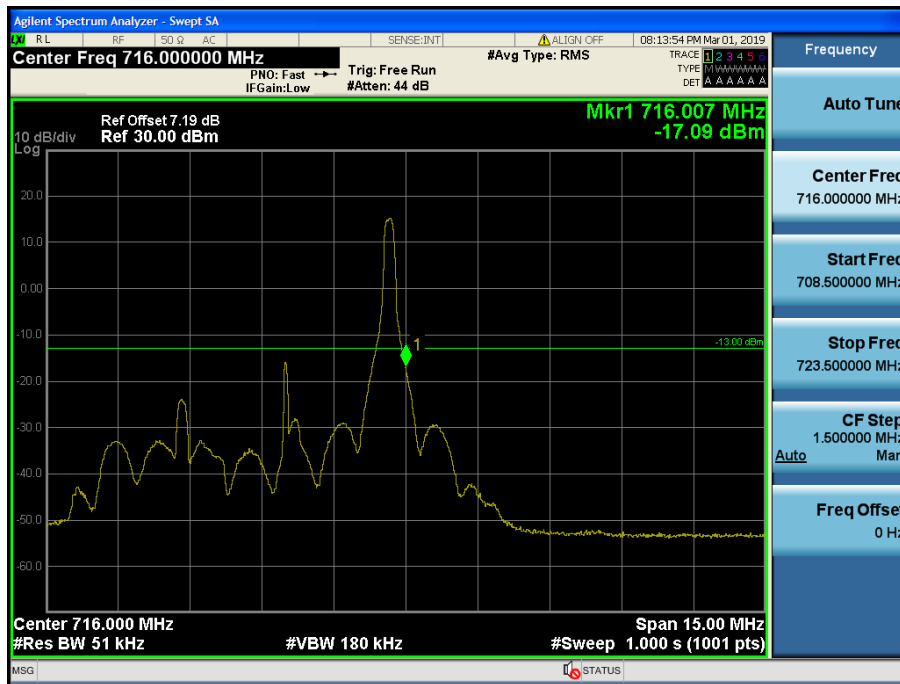

LTE Band 12 / 5MHz / QPSK - RB Size/Offset (1/24)

- Upper Extended Band Edge

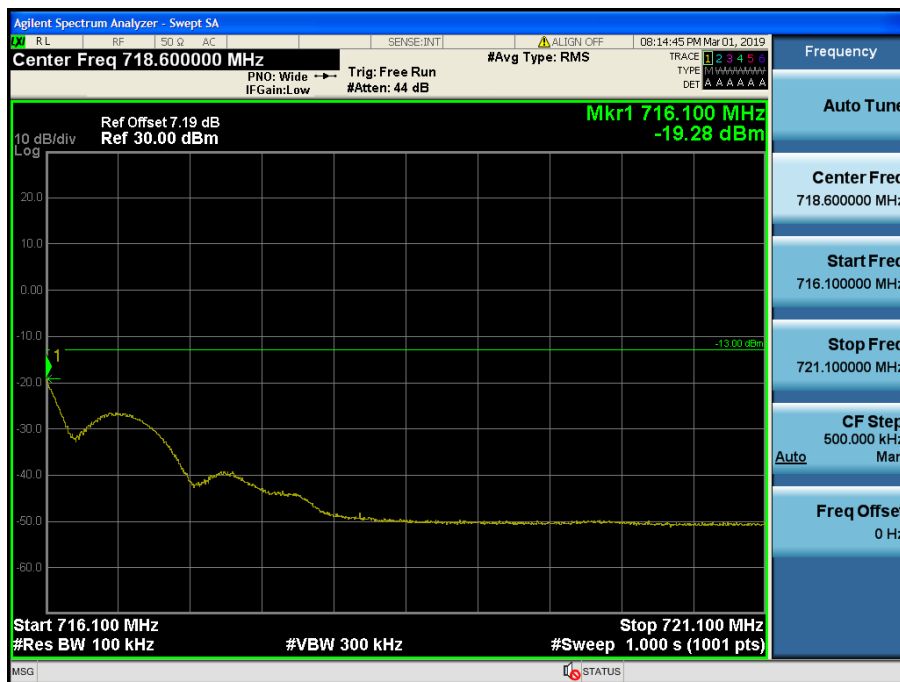

LTE Band 12 / 5MHz / QPSK - RB Size/Offset (1/24)

- Lower Band Edge

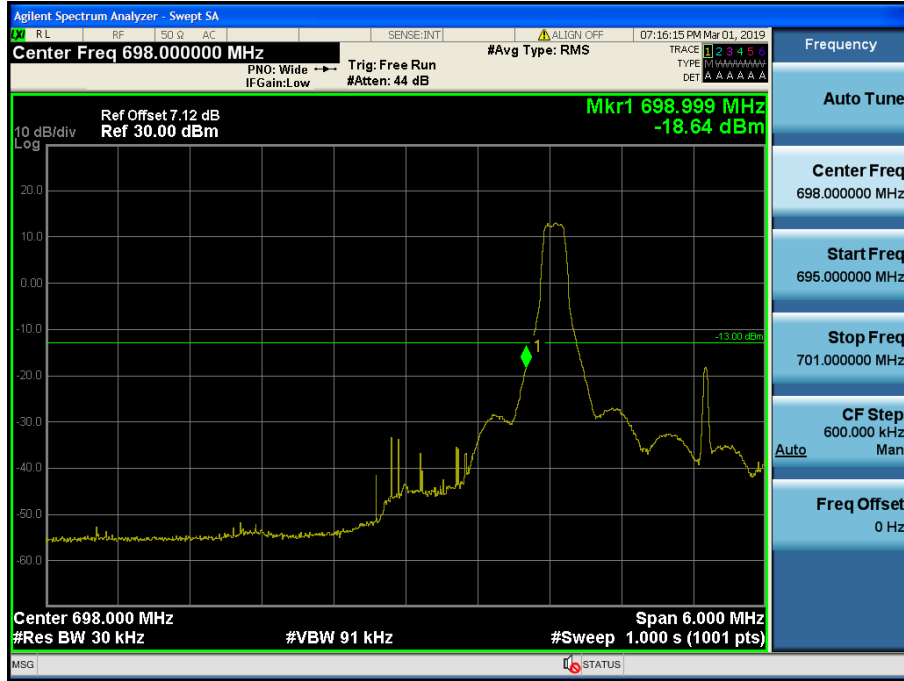

LTE Band 12 / 3MHz / QPSK - RB Size/Offset (1/0)

- Lower Extended Band Edge

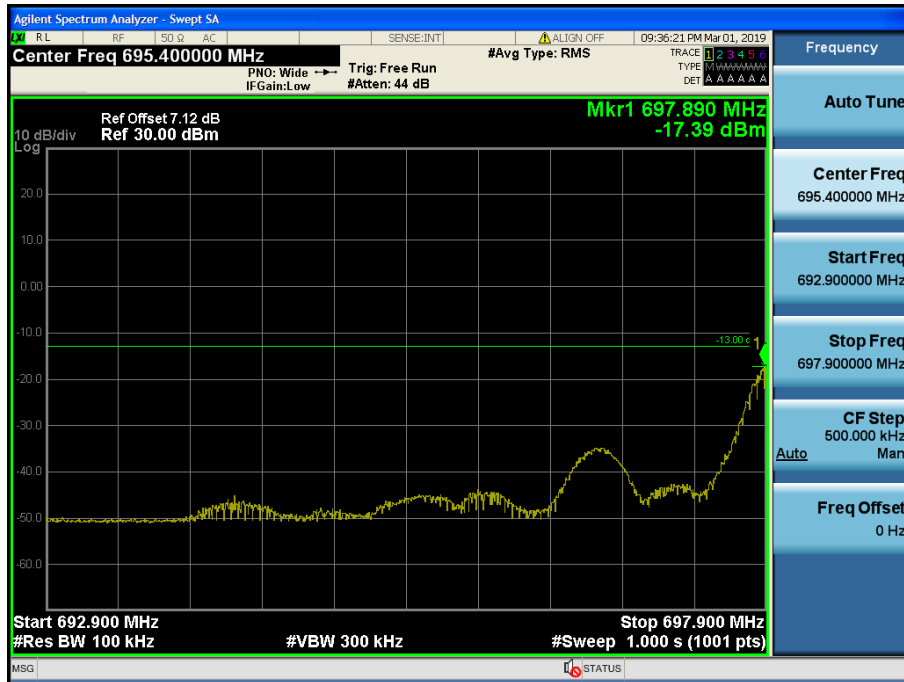

LTE Band 12 / 3MHz / 16QAM - RB Size/Offset (1/14)

- Upper Band Edge



LTE Band 12 / 3MHz / 16QAM - RB Size/Offset (1/14)

- Upper Extended Band Edge



LTE Band 12 / 3MHz / 16QAM - RB Size/Offset (1/14)

- Lower Band Edge



LTE Band 12 / 1.4MHz / 16QAM - RB Size/Offset (1/0)

- Lower Extended Band Edge



LTE Band 12 / 1.4MHz / 16QAM - RB Size/Offset (1/0)

- Upper Band Edge



LTE Band 12 / 1.4MHz / 16QAM - RB Size/Offset (1/5)

- Upper Extended Band Edge



LTE Band 12 / 1.4MHz / QPSK - RB Size/Offset (3/3)

8.3.2 LTE Band 4

- Lower Band Edge

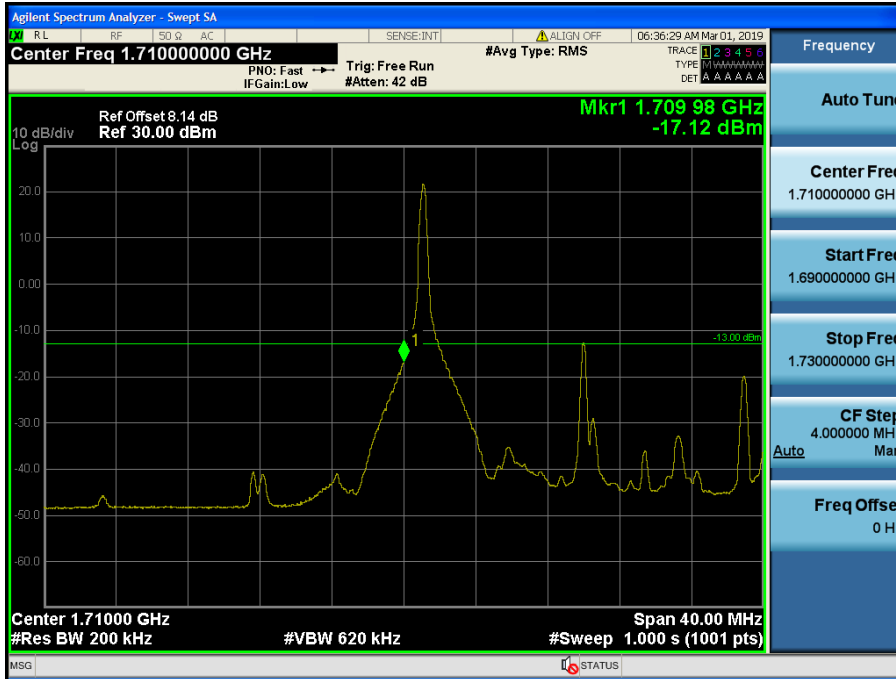

LTE Band 4 / 20MHz / QPSK - RB Size/Offset (1/0)

- Lower Extended Band Edge

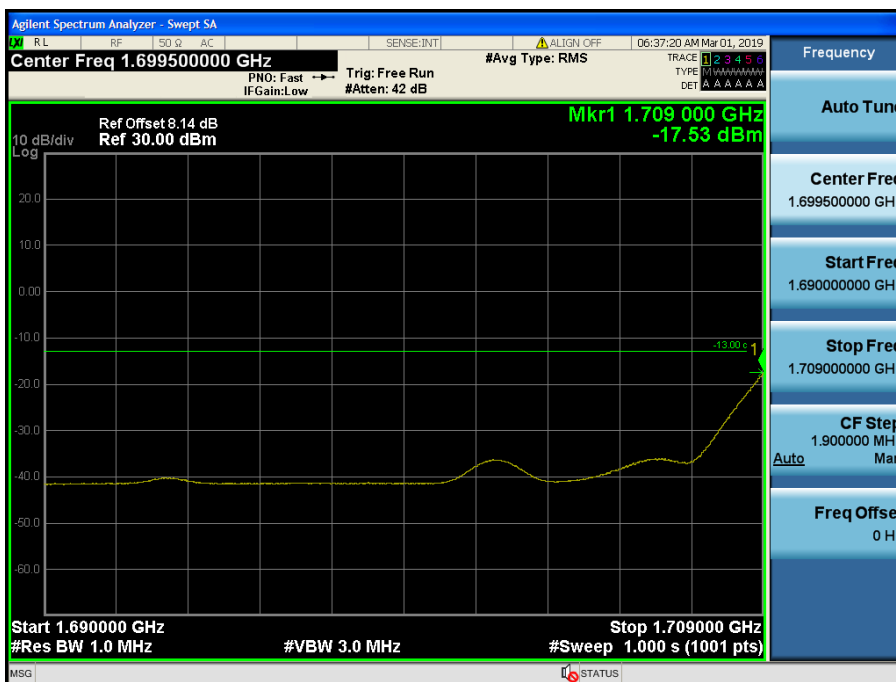

LTE Band 4 / 20MHz / QPSK - RB Size/Offset (1/0)

- Upper Band Edge

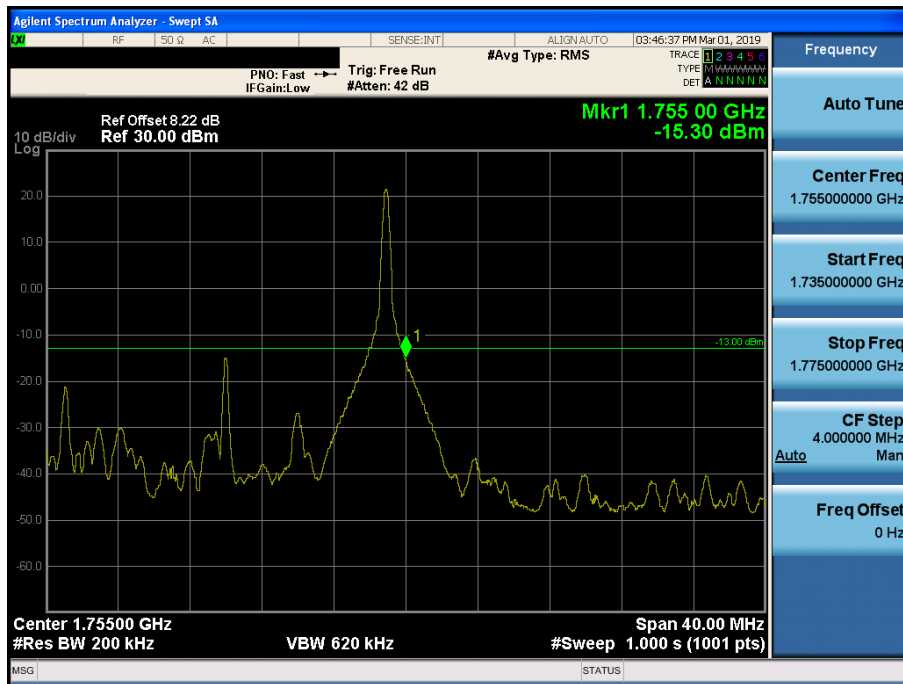

LTE Band 4 / 20MHz / QPSK - RB Size/Offset (1/99)

- Upper Extended Band Edge

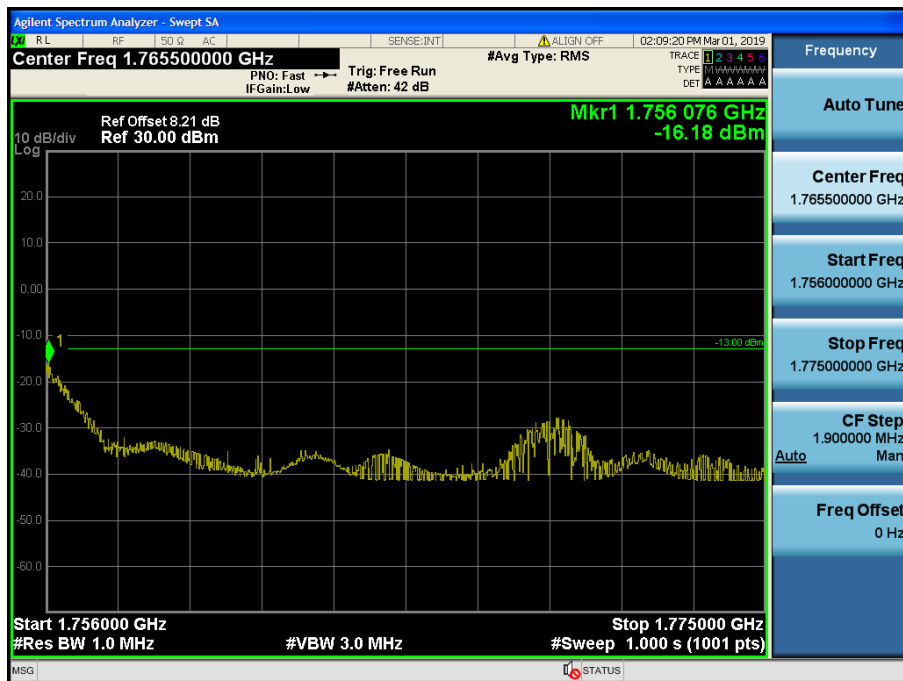

LTE Band 4 / 20MHz / 16QAM - RB Size/Offset (1/99)

- Lower Band Edge

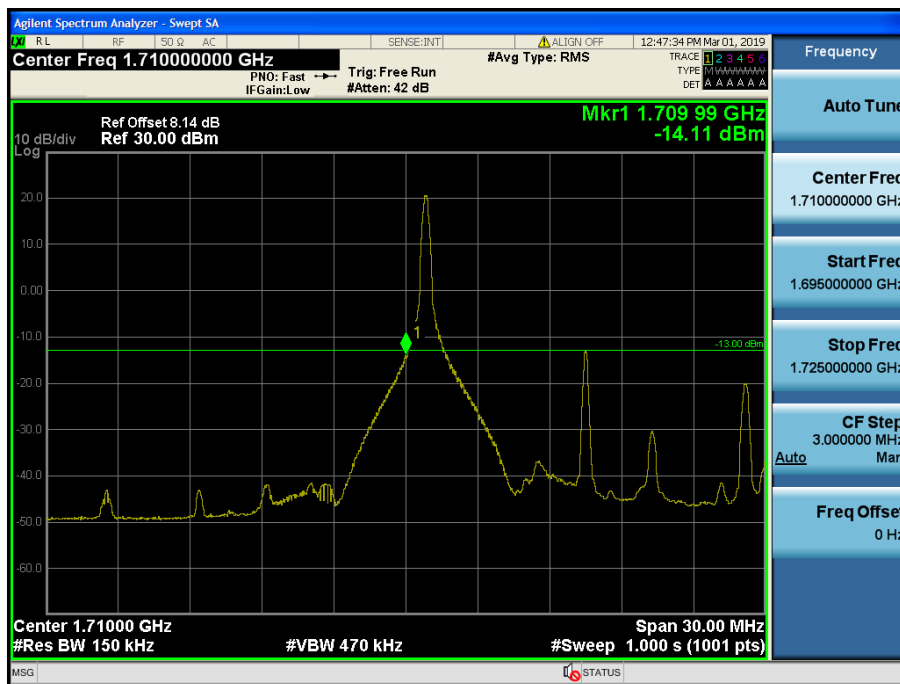

LTE Band 4 / 15MHz / 16QAM - RB Size/Offset (1/0)

- Lower Extended Band Edge

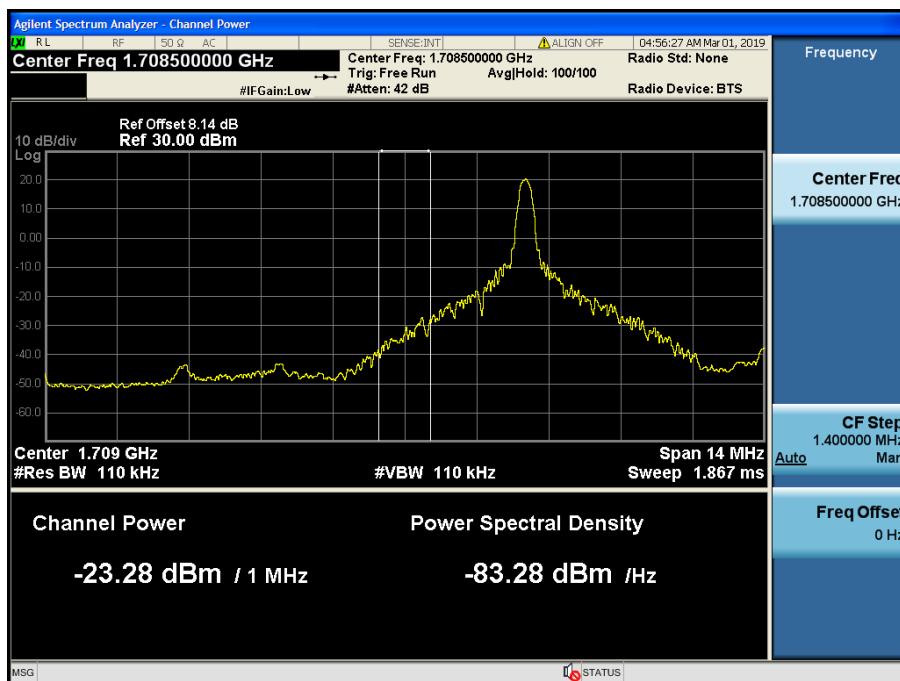

LTE Band 4 / 15MHz / QPSK - RB Size/Offset (1/0)

- Upper Band Edge

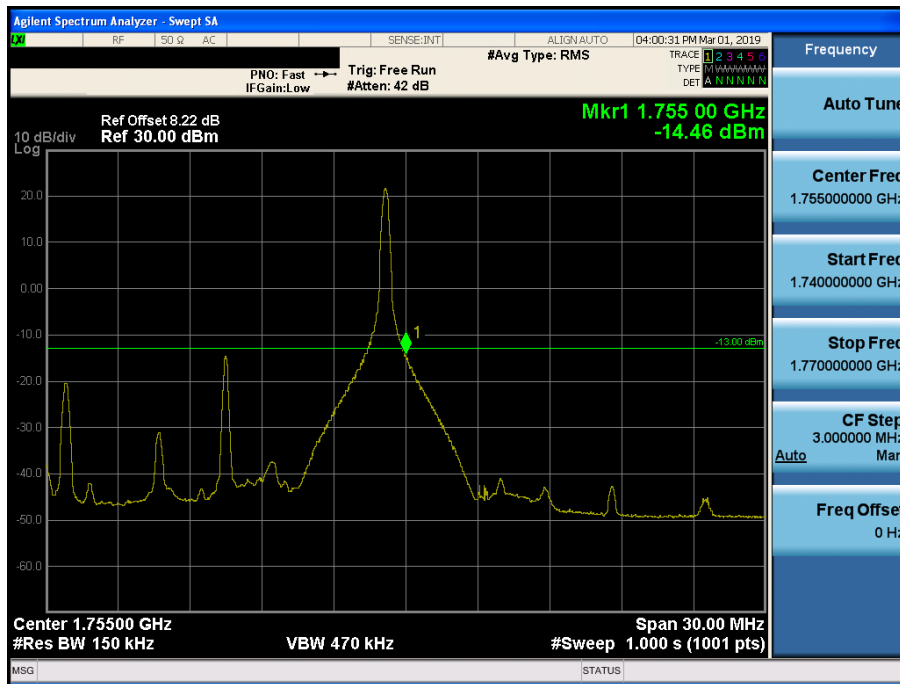

LTE Band 4 / 15MHz / 16QAM - RB Size/Offset (1/74)

- Upper Extended Band Edge



LTE Band 4 / 15MHz / 16QAM - RB Size/Offset (36/39)

- Lower Band Edge

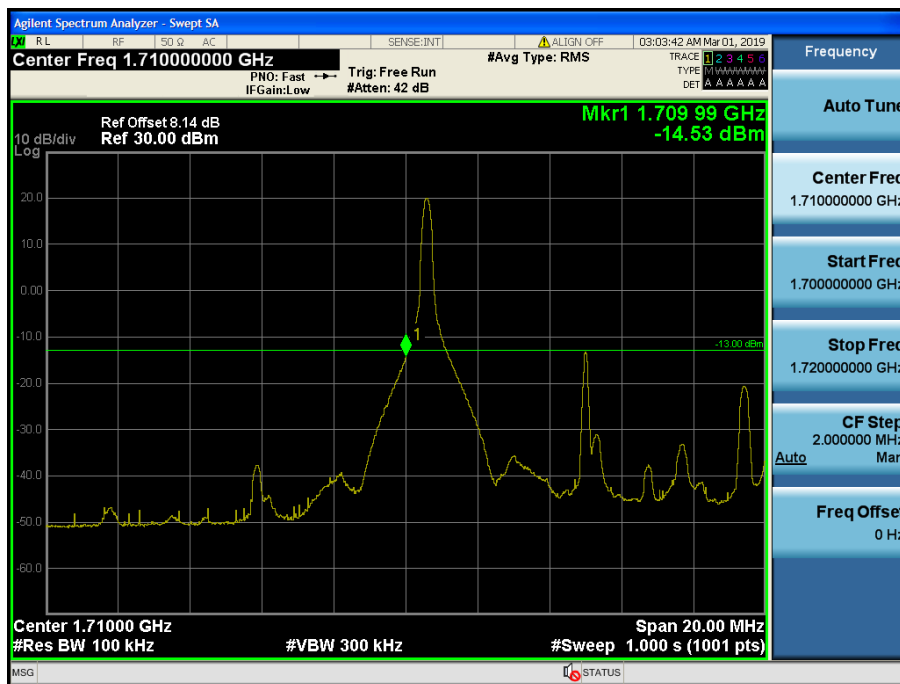

LTE Band 4 / 10MHz / QPSK - RB Size/Offset (1/0)

- Lower Extended Band Edge

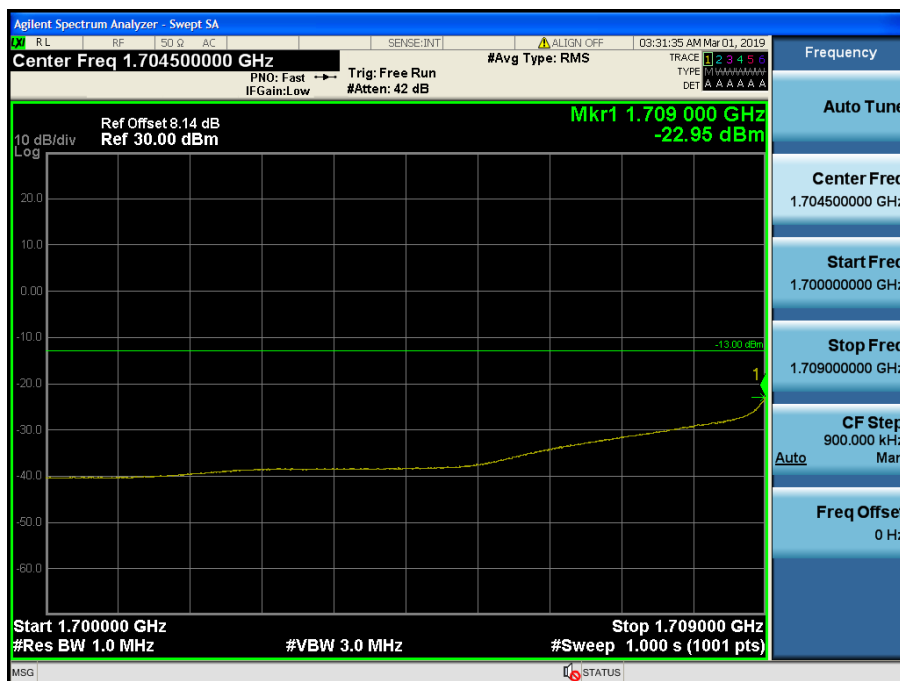

LTE Band 4 / 10MHz / QPSK - RB Size/Offset (25/0)

- Upper Band Edge



LTE Band 4 / 10MHz / QPSK - RB Size/Offset (1/49)

- Upper Extended Band Edge

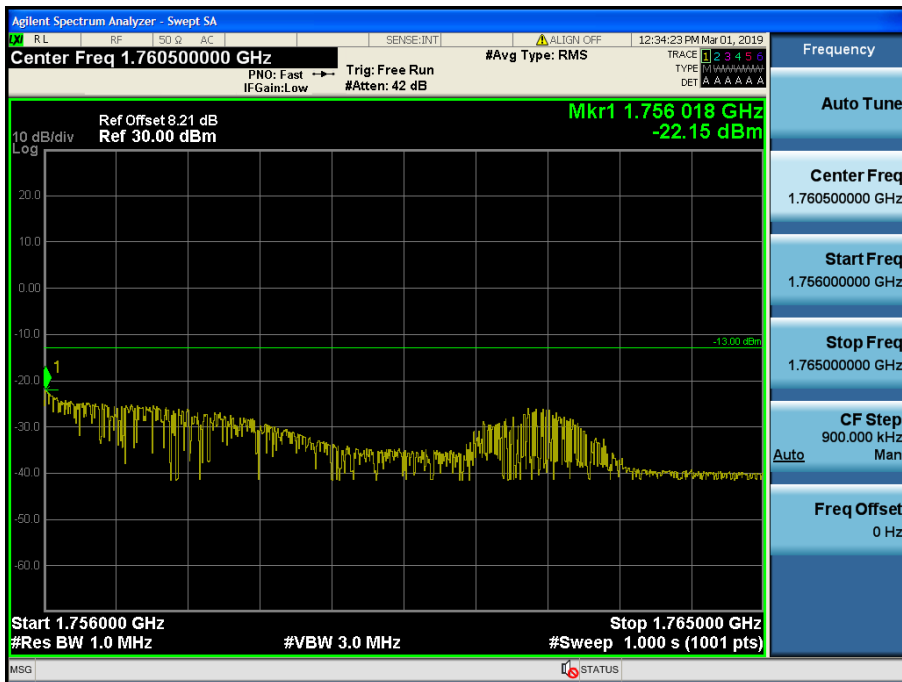

LTE Band 4 / 10MHz / 16QAM - RB Size/Offset (25/25)

- Lower Band Edge

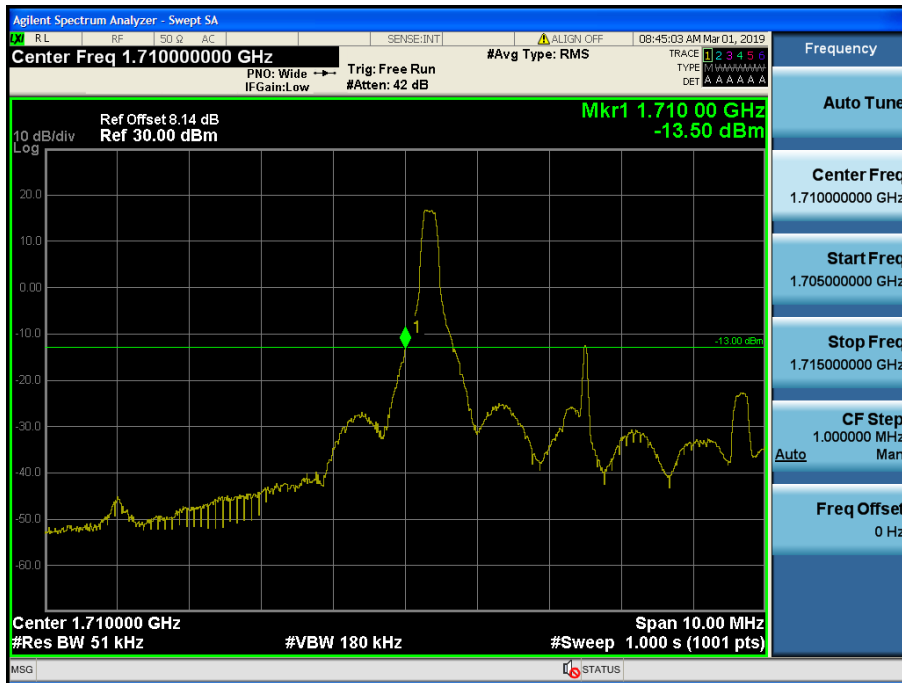

LTE Band 4 / 5MHz / 16QAM Offset/Size (1/0)

- Lower Extended Band Edge

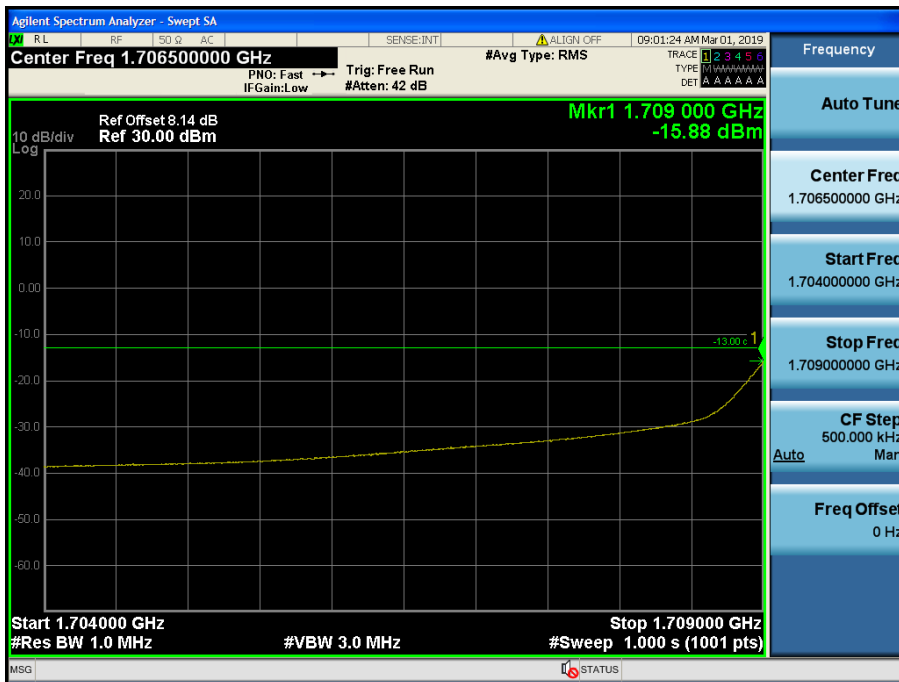

LTE Band 4 / 5MHz / 16QAM Offset/Size (25/0)

- Upper Band Edge

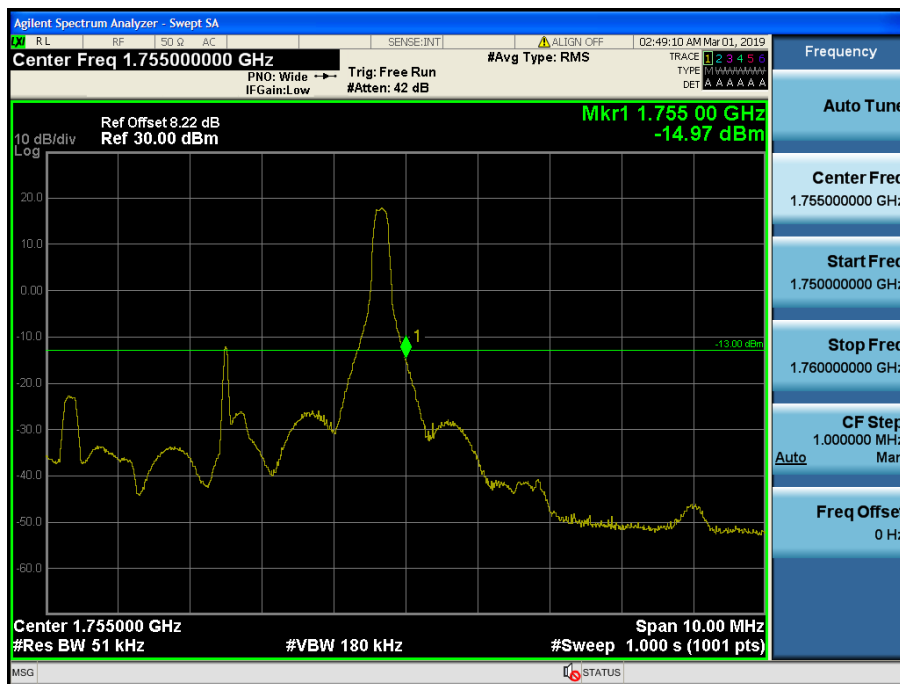

LTE Band 4 / 5MHz / QPSK - RB Size/Offset (1/24)

- Upper Extended Band Edge

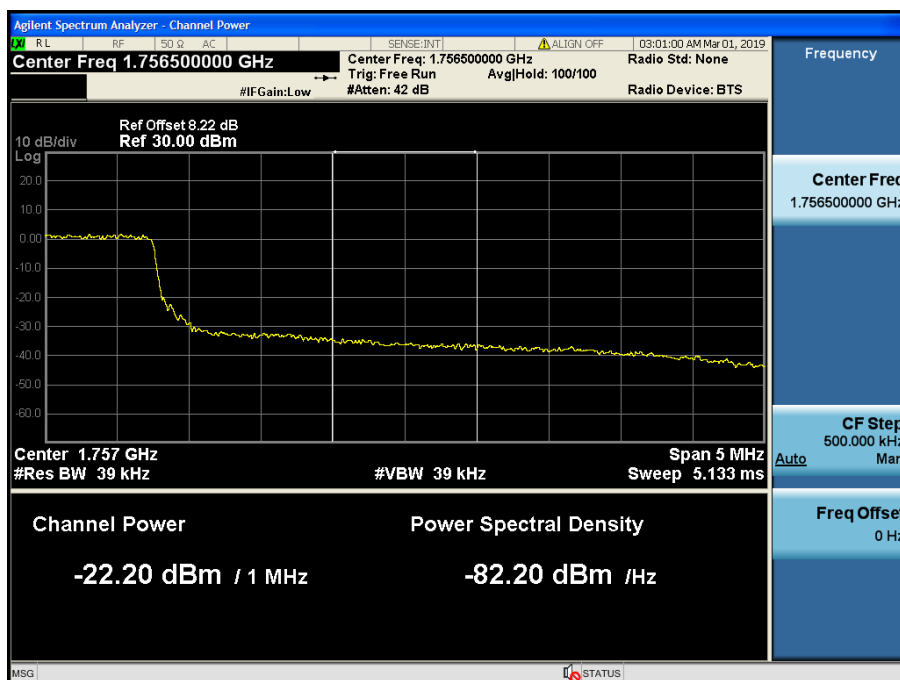

LTE Band 4 / 5MHz / QPSK - RB Size/Offset (25/0)

- Lower Band Edge

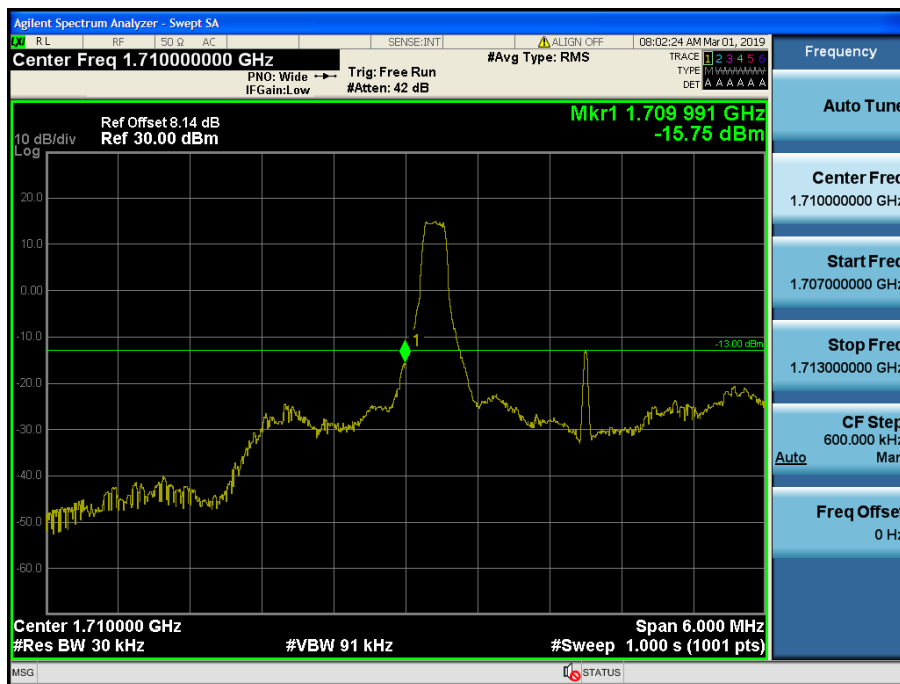

LTE Band 4 / 3MHz / 16QAM - RB Size/Offset (1/0)

- Lower Extended Band Edge

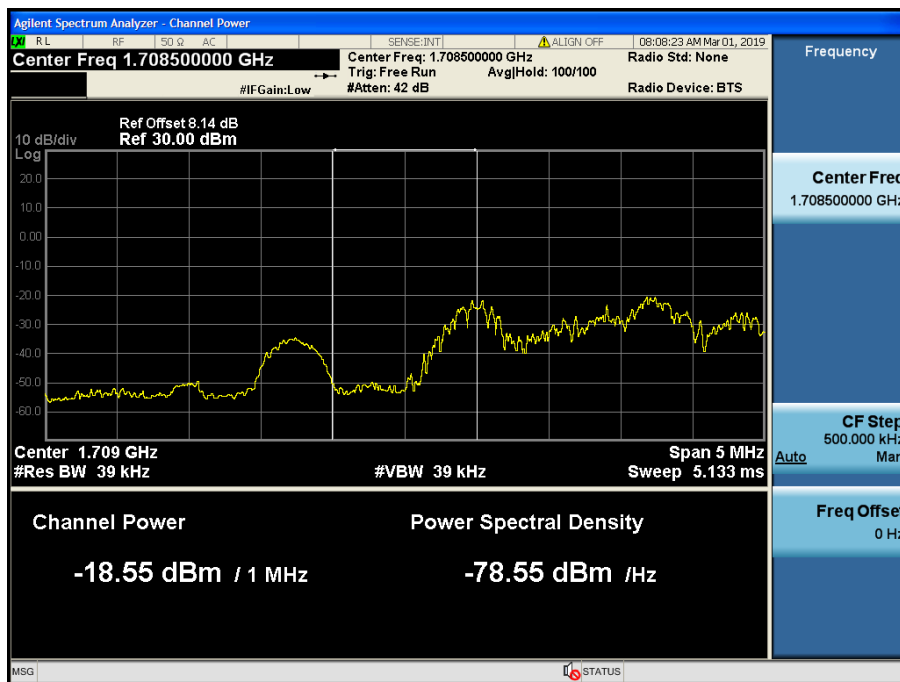

LTE Band 4 / 3MHz / 16QAM - RB Size/Offset (1/14)

- Upper Band Edge



LTE Band 4 / 3MHz / QPSK - RB Size/Offset (1/14)

- Upper Extended Band Edge



LTE Band 4 / 3MHz / QPSK - RB Size/Offset (1/0)

- Lower Band Edge



LTE Band 4 / 1.4MHz / 16QAM - RB Size/Offset (1/0)

- Lower Extended Band Edge



LTE Band 4 / 1.4MHz / QPSK - RB Size/Offset (3/2)

- Upper Band Edge

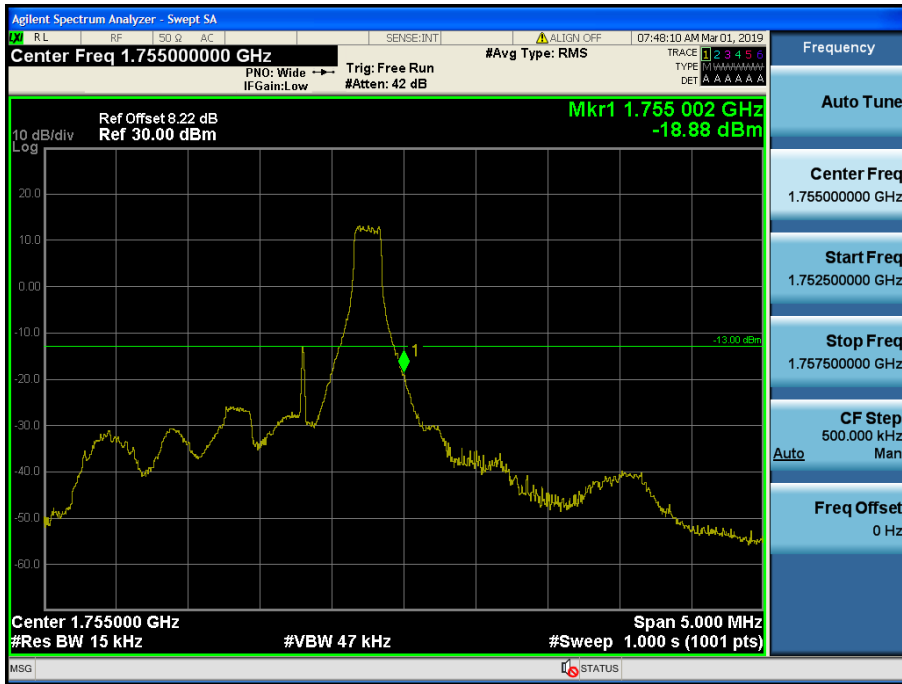

LTE Band 4 / 1.4MHz / 16QAM - RB Size/Offset (1/5)

- Upper Extended Band Edge

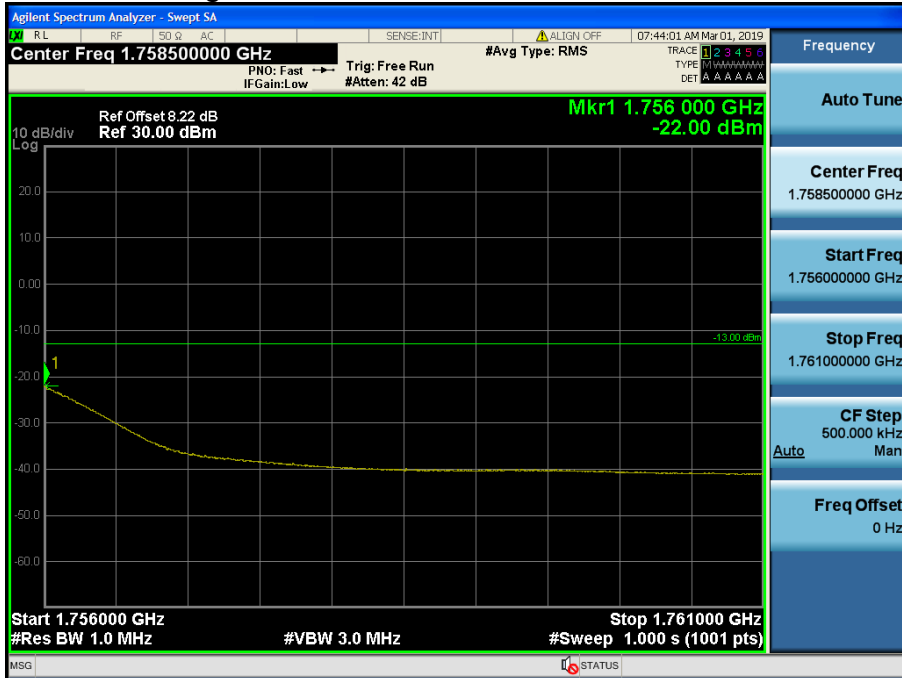

LTE Band 4 / 1.4MHz / 16QAM - RB Size/Offset (1/0)